

# OWNER'S GUIDE

• ASSEMBLY • OPERATION • MAINTENANCE • PARTS •



## 20" MULCHING ROTARY MOWERS

### Model Numbers

112-093R000

112-095R000

112-096R000

112-098R000

### IMPORTANT!

Record the **Model No.** and **Mfg. Code** which appear on your unit in the space below. You **must** have these numbers, along with the date of purchase, in order to receive warranty or service.

#### MEETS ANSI SAFETY STANDARDS

MODEL NO.

MFG. CODE

\_\_\_\_\_

**Important:  
Read Safety Rules  
and Instructions Carefully**



Made  
in  
AMERICA

**WARNING:** This unit is equipped with an internal combustion engine and should not be used on or near any unimproved forest-covered, brush-covered or grass-covered land unless the engine's exhaust system is equipped with a spark arrester meeting applicable local or state laws (if any). If a spark arrester is used, it should be maintained in effective working order by the operator.

In the State of California the above is required by law (Section 4442 of the California Public Resources Code). Other states may have similar laws. Federal laws apply on federal lands. A spark arrester for the muffler is available through your nearest engine authorized service dealer or contact the service department, P.O. Box 360900, Cleveland, Ohio 44136.

# IMPORTANT

## RULES FOR SAFE OPERATION



THIS SYMBOL POINTS OUT IMPORTANT SAFETY INSTRUCTIONS WHICH, IF NOT FOLLOWED, COULD ENDANGER THE PERSONAL SAFETY AND/OR PROPERTY OF YOURSELF AND OTHERS. READ AND FOLLOW ALL INSTRUCTIONS IN THIS MANUAL BEFORE ATTEMPTING TO OPERATE YOUR LAWN MOWER. FAILURE TO COMPLY WITH THESE INSTRUCTIONS MAY RESULT IN PERSONAL INJURY. WHEN YOU SEE THIS SYMBOL—



**HEED ITS WARNING**



### DANGER

**Your lawn mower was built to be operated according to the rules for safe operation in this manual. As with any type of power equipment, carelessness or error on the part of the operator can result in serious injury. If you violate any of these rules, you may cause serious injury to yourself or others.**



### TRAINING

1. Read this owner's guide carefully in its entirety before attempting to assemble or operate this machine. Be completely familiar with the controls and the proper use of this machine before operating it. Keep this manual in a safe place for future and regular reference and for ordering replacement parts.
2. Your rotary mower is a precision piece of power equipment, not a plaything. Therefore, exercise extreme caution at all times.
3. Never allow children to operate a power mower. Only persons well acquainted with these rules of safe operation should be allowed to use your mower.
4. Keep the area of operation clear of all persons, particularly small children and pets. Stop engine when they are in the vicinity of your mower to help prevent blade contact or thrown object injury. Although the area of operation should be completely cleared of foreign objects, an object may have been overlooked and could be accidentally thrown by the mower in any direction and cause serious personal injury to the operator or any others allowed in the area.

9. For your safety, use the slope gauge included as part of this manual to measure slopes before operating this unit on a sloped or hilly area. If the slope is greater than 15° as shown on the slope gauge, do not operate this unit on that area or serious injury could result.



### OPERATION

1. Do not change the engine governor settings or overspeed the engine. Excessive engine speeds are dangerous.
2. Do not put hands or feet near or under rotating parts. Keep clear of deck at all times as the rotating blade can cause injury.
3. Stop the blade when crossing gravel drives, walks or roads.
4. After striking a foreign object, stop the engine, remove the wire from the spark plug, and thoroughly inspect the mower for any damage. Repair the damage before restarting and operating the mower.
5. If the equipment should start to vibrate abnormally, stop the engine and check immediately for the cause. Vibration is generally a warning of trouble.
6. Shut the engine off and wait until the blade comes to a complete stop before performing any work on the mower. The cutting blade continues to rotate for a few seconds after the engine is shut off. Never place any part of the body in the blade area until you are sure the blade has stopped rotating.
7. Before cleaning, repairing or inspecting, make certain the blade and all moving parts have stopped. Disconnect the spark plug wire, and keep the wire away from the spark plug to prevent accidental starting.
8. Do not run the engine indoors.
9. Mow across the face of slopes, never up-and-down. Exercise extreme caution when changing direction on slopes. Do not mow excessively steep slopes. Always be sure of your footing. A slip and fall can cause serious personal injury.
10. Never operate mower without proper guards, plates or other safety protective devices in place.



### PREPARATION

1. Thoroughly inspect the area where the equipment is to be used. Remove all stones, sticks, wire, bones and other foreign objects which could be picked up and thrown by the mower in any direction and cause serious personal injury to the operator or any others allowed in the area.
2. Always wear safety glasses or eye shields during operation or while performing an adjustment or repair, to protect eyes from foreign objects that may be thrown from the machine in any direction.
3. Wear sturdy, rough-soled work shoes and close-fitting slacks and shirts to avoid entanglement in the moving parts. Never operate a unit in bare feet, sandals, or sneakers.
4. Check the fuel before starting the engine. Gasoline is an extremely flammable fuel. Do not fill the gasoline tank indoors, while the engine is running, or until engine has been allowed to cool for two minutes after running. Replace gasoline cap securely and wipe off any spilled gasoline before starting the engine as it may cause a fire or explosion.
5. Disengage the self-propelled mechanism or drive clutch on units so equipped before starting the engine.
6. The blade control handle is a safety device. Never attempt to bypass its operation. Doing so makes the safety device inoperative and may result in personal injury through contact with the rotating blade. The blade control handle must operate easily in both directions.
7. Never attempt to make a wheel or cutting height adjustment while the engine is running.
8. Never operate the equipment in wet grass. Always be sure of your footing. A slip and fall can cause serious personal injury. Keep a firm hold on the handle and walk, never run. Mow only in daylight or in good artificial light.



### MAINTENANCE AND STORAGE

1. Check the blade and engine mounting bolts at frequent intervals for proper tightness.
2. Keep all nuts, bolts, and screws tight to be sure the equipment is in safe working condition.
3. Never store the equipment with gasoline in the tank inside of building where fumes may reach an open flame or spark. Allow the engine to cool before storing in any enclosure.
4. To reduce fire hazard, keep the engine free of grass, leaves, or excessive grease.

USE THIS SHEET AS A GUIDE TO DETERMINE SLOPES WHERE YOU MAY NOT OPERATE SAFELY.

# SLOPE GAUGE

(Keep this sheet in a safe place for future reference.)

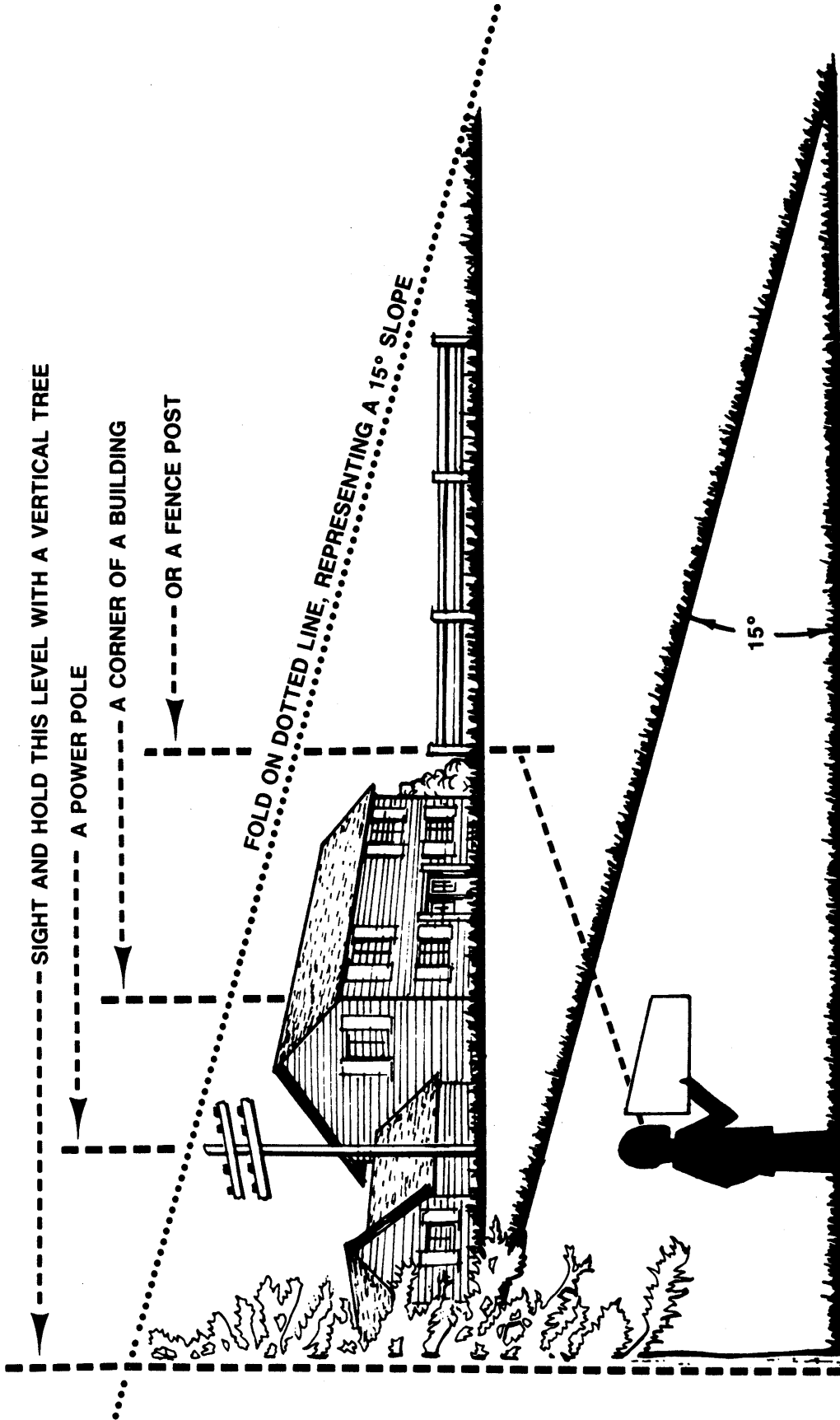

Do not mow on inclines with a slope in excess of 15 degrees (a rise of approximately 2-1/2 feet every 10 feet). A riding mower could overturn and cause serious injury. If operating a walk-behind mower on such a slope, it is extremely difficult to maintain your footing and you could slip, resulting in serious injury.

Operate RIDING mowers up and down slopes, never across the face of slopes.

Operate WALK-BEHIND mowers across the face of slopes, never up and down slopes.

# CONTENTS OF HARDWARE PACK/PARTS IDENTIFICATION

Remove this sheet from your owner's manual and lay the hardware on the illustration for identification purposes. After assembly, keep the Slope Gauge which is on the reverse side of this sheet for future use.

(Hardware pack may contain extra items which are not used on your unit. Part numbers are shown in parentheses.)

**A ATTACHING THE LOWER HANDLE**

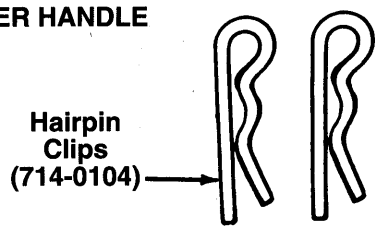

Hairpin Clips (714-0104)

**B ATTACHING THE UPPER HANDLE**

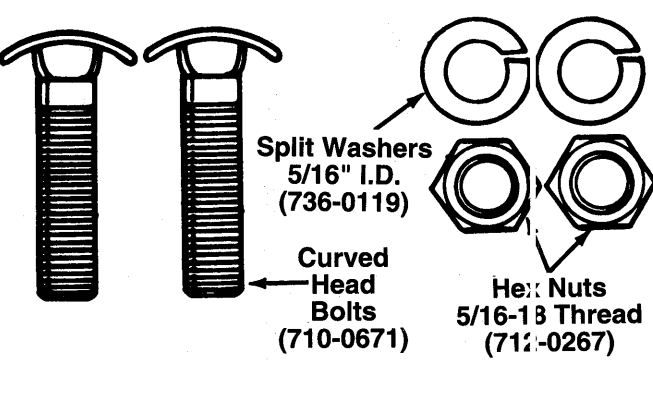

Split Washers 5/16" I.D. (736-0119)

Curved Head Bolts (710-0671)

Hex Nuts 5/16-18 Thread (712-0267)

**C ATTACHING THE STARTER ROPE**

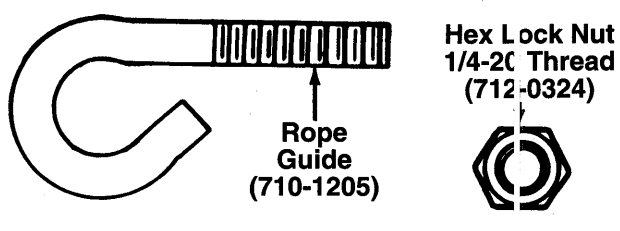

Rope Guide (710-1205)

Hex Lock Nut 1/4-20 Thread (712-0324)

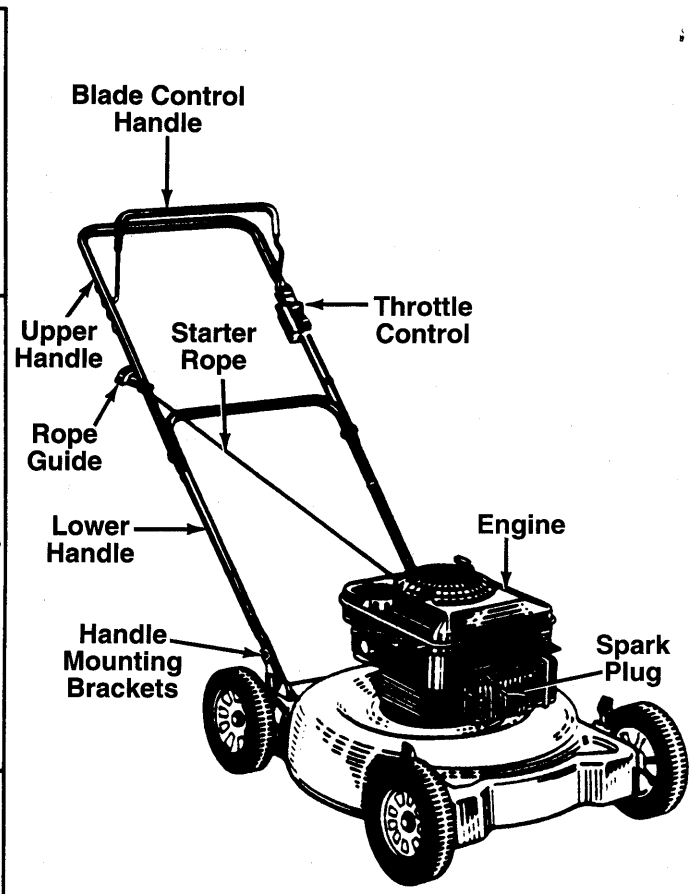

(Model 098R Shown)

## PARTS IDENTIFICATION

**D SECURING THE CABLES**

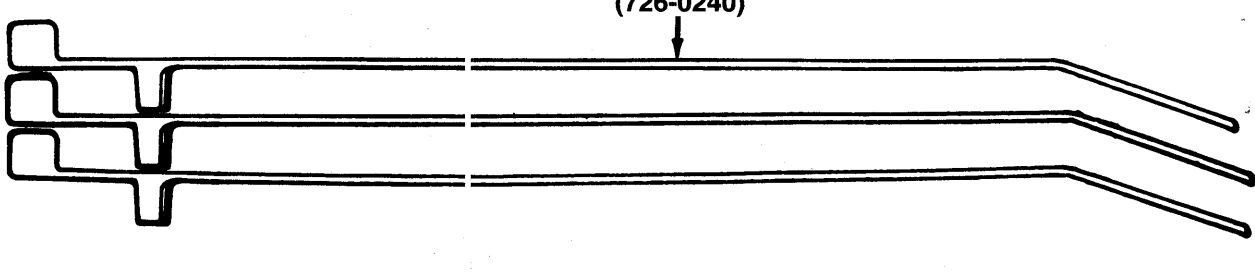

Cable Ties (726-0240)



Cut A  
This Line

# ASSEMBLY INSTRUCTIONS

**IMPORTANT:** This unit is shipped **WITHOUT GASOLINE or OIL.** After assembly, service engine with gasoline and oil as instructed in the separate engine manual packed with your unit.

**NOTE:** Reference to right or left hand side of the mower is observed from the operating position. Refer to parts identification on page 4 for location of parts when assembling the mower.

## Tools Required for Assembly

- (1) Pair of Pliers
- (1) 1/2" Wrench or Adjustable Wrench
- (1) Phillips Screwdriver

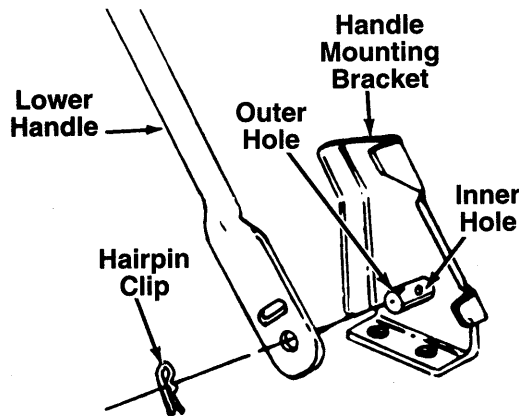

FIGURE 1.

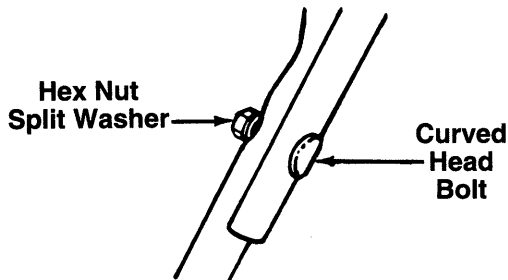

FIGURE 2.

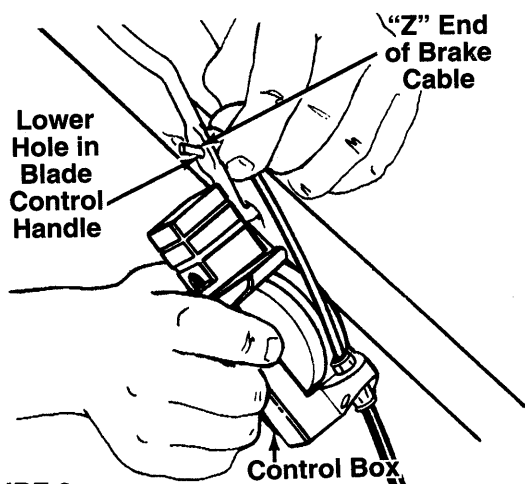

FIGURE 3.

## UNPACKING

1. Remove the lawn mower from the carton by opening the top flaps and lifting the unit out. Be careful of the staples. Make certain all parts and literature have been removed from the carton before the carton is discarded.
2. Disconnect the spark plug wire and move away from the spark plug.
3. Stretch out all control cables behind the mower and place on the floor. Be careful not to bend or kink the cables at any time during assembly.
4. Remove page four from this manual and lay the contents of the hardware pack on the illustration for identification.

## ATTACHING THE LOWER HANDLE (Hardware A)

1. Attach the lower handle by placing the bottom holes in the lower handle over the weld pins on the handle mounting brackets on the rear of the deck.
2. Using a pair of pliers, squeeze one leg of the lower handle against the handle mounting bracket. Insert the hairpin clip into the inner hole in the weld pin. See figure 1. Repeat on other side.

**NOTE:** There are two (2) holes in the handle mounting brackets. Place the hairpin clip in the inner hole for operation. Outer hole is for storage.

## ATTACHING THE UPPER HANDLE (Hardware B)

1. Place the upper handle in position over the lower handle. The hole in the side of the blade control handle (attached to the upper handle) must be on the left side.
2. Secure the upper handle to the lower handle using the curved head bolts, split washers and hex nuts as shown in figure 2.

## ATTACHING THE CONTROL BOX

One end of the throttle control cable and the brake cable is attached to the engine. The other end is attached to the control box. Attach the control box to the upper handle as follows.

1. Remove the truss machine screw and hex lock nut from the middle of the control box using a phillips screwdriver. Place your finger over the hex lock nut to hold it inside the control box so you can unscrew the truss machine screw.
2. Make certain the control handle is on top of the upper handle.
3. Route the control box (with cables attached) under the lower handle. Make certain the cables are not twisted. Hold the control box near the left side of the upper handle (control box must be inside the handle).

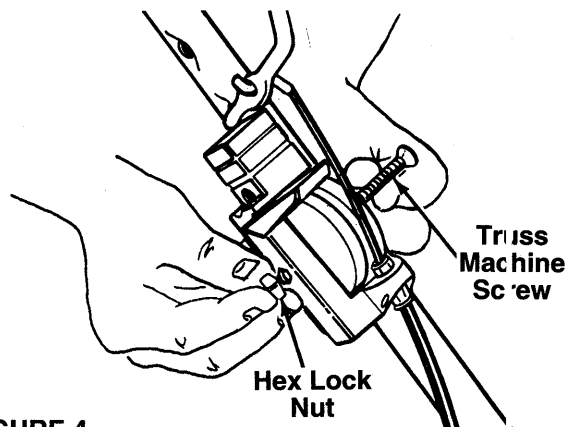

FIGURE 4.

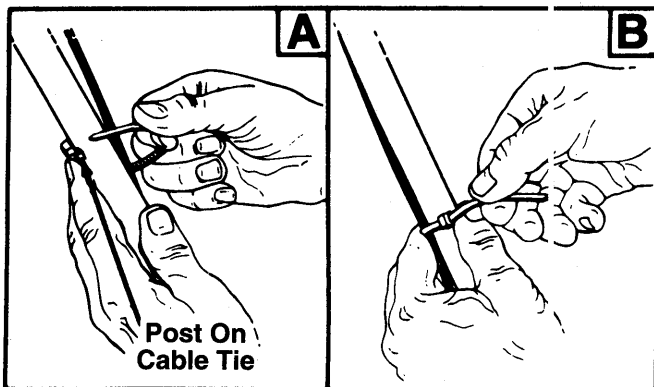

FIGURE 5.

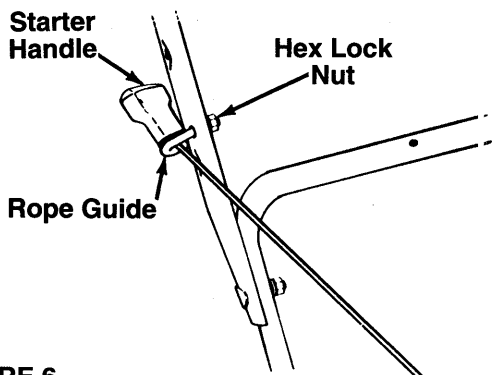

FIGURE 6.

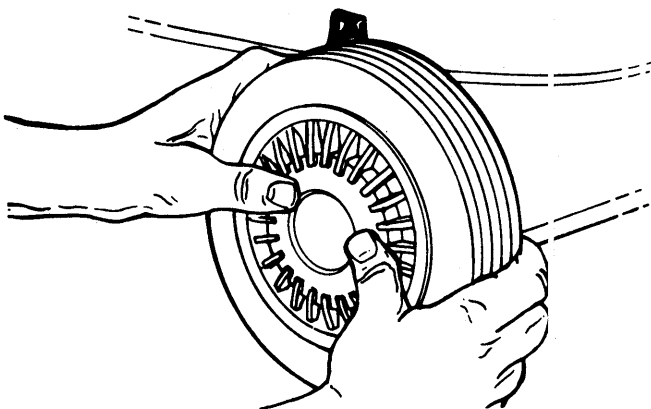

FIGURE 7.

4. Hook the "Z" end of the brake cable into the blade control handle from the **outside** to the **inside**. See figure 3.

5. Place the control box on the upper handle just below the end of the control handle as shown in figure 4. Secure with hardware removed in step one by placing hex lock nut into the indent on the inside of the control box. Screw the truss machine screw into the hex lock nut.

### SECURING THE CABLES (Hardware D)

Secure cables to the left side of the handle as follows.



**WARNING:** When attaching the control cables, the cables must be routed to avoid contact with all sharp edges and hot surfaces to prevent damage to the cables, which will render the controls inoperative.

1. Insert posts on cable ties into holes provided on the handles, one on the upper handle and two on the lower handle. The holes may be either on the inside or outside of the handles. See figure 5A.

2. Secure the cables with the cable ties. See figure 5B. Trim excess ends of cable ties.

### ATTACHING THE STARTER ROPE (Hardware C)

1. The starter rope is inside the top of the engine. Additional rope may be wound around the starter handle. If so, unwind the rope from the handle.

2. With the spark plug wire disconnected and grounded, depress the blade control handle and pull the rope out of the engine.

3. Place the rope guide around the starter rope, so the rope guide is positioned as shown (bends downward slightly). Insert the rope guide through the side of the upper handle, and secure with hex lock nut. See figure 6.

### FINAL ASSEMBLY OF MOWER

1. Attach hub caps (optional) to wheels by placing in position against the inner hub of the wheel. For units with 2" wide tires, press firmly around the center portion of hub cap in a circular motion, similar to installing a lid on a round, plastic container. See figure 7. The hub caps are flexible and will snap over the 3-1/2" diameter wheel hubs.

**NOTE:** It may be helpful to place the hub caps in hot tap water for several minutes to make them pliable before installing, especially if the temperature is less than 60°F.

2. Make certain all nuts and bolts are tightened securely.

## CONTROLS

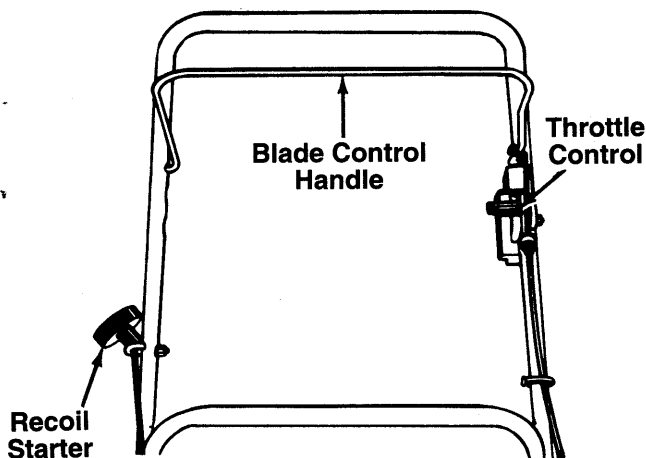

FIGURE 8.

### BLADE CONTROL HANDLE



**WARNING:** This control mechanism is a safety device. Never attempt to bypass its operations.

The blade control handle is located on the upper handle of the mower. See figure 8. The blade control handle must be depressed in order to operate the unit. Release the blade control handle to stop the engine and blade.



**WARNING:** The blade will be rotating whenever the engine is running.

### THROTTLE CONTROL

The throttle control is located on the side of the upper handle. It is used to regulate the engine speed.



**WARNING:** The throttle control cannot be used to stop the engine.

### RECOIL STARTER

The recoil starter handle is attached to the handle. See figure 8. Stand behind the unit in the operating position to start the unit.

## OPERATION



FIGURE 9.

Keep hands and feet away from the mowing deck. See figure 9.

The operation of any lawn mower can result in foreign objects being thrown into the eyes, which can result in severe eye damage. Always wear safety glasses or eye shields. We recommend wide vision safety mask for over spectacles or standard safety glasses.



**NOTE:** For shipping purposes your mower is set with the wheels in a low cutting height position. For best results raise the cutting position until it is determined which height is best for your lawn. See cutting height adjustment section.

### GAS AND OIL FILL-UP

Service the engine with gasoline and oil as instructed in the separate engine manual packed with your mower. Read instructions carefully.



**WARNING:** Never fill fuel tank indoors, with engine running or until the engine has been allowed to cool for at least two minutes after running.

### TO START ENGINE AND ENGAGE BLADE

1. Attach spark plug wire to spark plug. Make certain the metal loop on the end of the spark plug wire (inside the rubber boot) is fastened securely over the metal tip on the spark plug. See figure 10.

Metal Loop on Spark Plug Wire

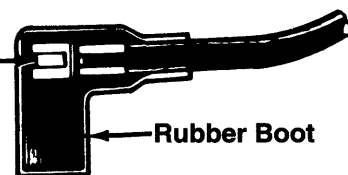

FIGURE 10.

2. If engine is equipped with a primer, prime engine as instructed in separate engine manual.
3. Move throttle control lever all the way forward.
4. Standing behind the unit, depress the blade control handle and hold it against the upper handle as shown. See figure 11.
5. Grasp the recoil starter handle and pull back rapidly, extending rope fully. Return it slowly to the rope guide.
6. After engine starts, move throttle control to desired engine speed.

**NOTE:** If any problems are encountered, refer to the Trouble Shooting Guide on page 11.

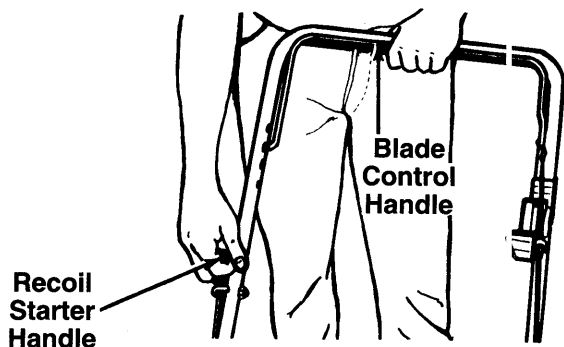

FIGURE 11.

### TO STOP ENGINE AND BLADE

1. Release the blade control handle to stop the engine and blade.



**WARNING:** The blade continues to rotate for a few seconds after the engine is shut off.

2. Disconnect the spark plug wire and ground it against the engine to prevent accidental starting while equipment is unattended.

### USING YOUR ROTARY MOWER

Be sure that lawn is clear of stones, sticks, wire, or other objects which could damage lawn mower or engine. Such objects could be accidentally thrown by the mower in any direction and cause serious personal injury to the operator and others.

For the best results, do not cut wet grass because it tends to stick to the underside of the mower, preventing proper mulching of grass clippings. In addition, wet grass could cause you to slip and fall. New grass, thick grass or wet grass may require a narrower cut.

For best results, cut off one-third or less of the total length of the grass. Lawn should be cut in the fall as long as there is growth.

This mower is designed to be operated at full throttle to give you the best cut and do the most effective job of mulching.



**WARNING:** If you strike a foreign object, stop the engine. Remove wire from spark plug, thoroughly inspect the mower for any damage, and repair the damage before restarting and operating the mower. Extensive vibration of the mower during operation is an indication of damage. The unit should be promptly inspected and repaired.

## ADJUSTMENTS



**WARNING:** Do not at any time make any adjustment to lawn mower without first stopping engine and disconnecting spark plug wire

### CUTTING HEIGHT ADJUSTMENT

An adjusting plate and thumb lever at each wheel position provides cutting height adjustment. Each adjusting plate has nine height positions. Height of cut will be changed when the thumb lever is moved from one hole to another. Simply depress the lever towards wheel and move wheel and lever assembly to desired position. All wheels must be placed in the same relative position. See figure 12.

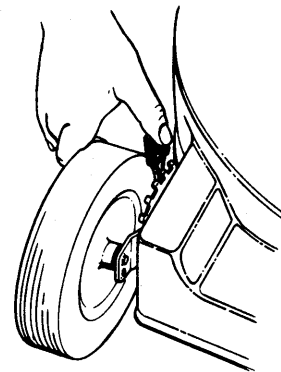

FIGURE 12.

### THROTTLE CONTROL ADJUSTMENT

If the throttle control requires adjustment or if it has been replaced, adjust the throttle control as follows.

1. Remove the screw shown in figure 13. Remove the cable clamp from the cable.

**NOTE:** If you have a Tecumseh engine, simply loosen the screw shown in figure 13 so the cable will move freely beneath the clamp. It is not necessary to remove the screw and clamp completely.



2. Push the throttle control lever on the handle all the way forward as far as it will go, then back it off **one "click"**. Make certain the throttle control lever remains in this position.
3. Push the control lever on the engine as far toward the **rear** of the engine as it will go. Secure the cable in this position with the cable clamp and screw.

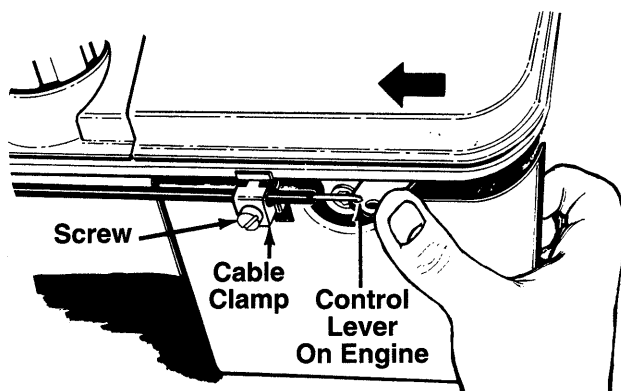

FIGURE 13A.—Briggs & Stratton Engines

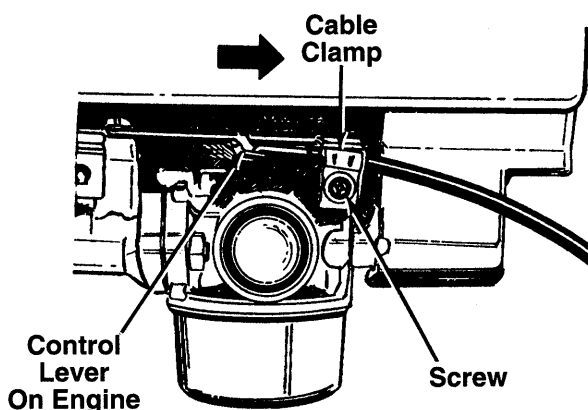

FIGURE 13B.—Tecumseh Engines

### CARBURETOR ADJUSTMENTS



**WARNING:** If any adjustments are made to the engine while the engine is running (e.g. carburetor), keep clear of all moving parts. Be careful of heated surfaces and muffler.

Minor carburetor adjustments may be required to compensate for differences in fuel, temperature, altitude and load. To adjust carburetor, refer to the separate engine manual packed with your mower.

**NOTE:** A dirty air cleaner will cause an engine to run rough. Be certain air cleaner is clean and attached to the carburetor before adjusting carburetor. Refer to the separate engine manual.

## LUBRICATION



**WARNING:** Always stop engine and disconnect spark plug wire before cleaning, lubricating or doing any kind of work on lawn mower.

**Blade Control**—Lubricate the pivot points on the blade control handle and the brake cable at least once a season with light oil. See figure 14. The blade control must operate freely in both directions.

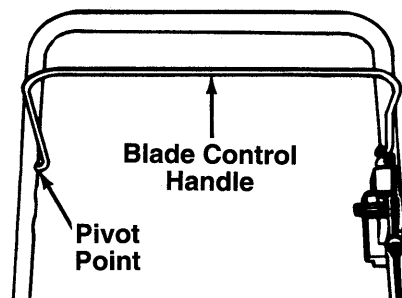

FIGURE 14.

**Wheels**—Mower may be provided with ball bearing wheels. Lubricate at least once a season with light oil. Also, if the wheels are removed for any reason, lubricate the surface of the axle bolt and the inner surface of the wheel with light oil. A 4 oz. plastic bottle of light oil lubricant is available. Order part number 737-0170. Engine oil may also be used.

**Engine**—Follow engine manual for lubrication instructions.

## MAINTENANCE



**WARNING:** Be sure to disconnect and ground the spark plug wire before performing any repairs or maintenance.

**NOTE:** When tipping the unit, empty the fuel tank and keep engine spark plug side up.

### TROUBLE SHOOTING

Refer to page 11 of this manual for trouble shooting information.

### CUTTING BLADE

When removing the cutting blade for sharpening or replacement, protect hands by using heavy gloves or a rag to grasp the cutting blade. Remove the bolt and bell washer which hold the blade and adapter to the engine crankshaft. Remove the blade and adapter from the crankshaft.

If the blade or blade adapter needs replacing, remove the two small bolts, lock washers and nuts which hold the blade to the adapter.



**WARNING: Periodically inspect the blade adapter for cracks, especially if you strike a foreign object. Replace when necessary.**

When sharpening the blade, follow the original angle of grind as a guide. It is extremely important that each cutting edge receives an equal amount of grinding to prevent an unbalanced blade. An unbalanced blade will cause excessive vibration when rotating at high speeds, may cause damage to the mower and could break, causing personal injury.

It is recommended that the blade always be removed from the adapter for the best test of balance. The blade can be tested by balancing it on a round shaft screwdriver. Remove metal from the heavy side until it balances evenly.

Before reassembling the blade and the blade adapter to the unit, lubricate the engine crankshaft and the inner surface of the blade adapter with light oil. Lubricating the bolt holes, bolts and inner surface of the nuts with light oil is also recommended. A 4 oz. plastic bottle of light oil lubricant is available. Order part number 737-0170. Engine oil may also be used.

When replacing the blade, be sure to install the blade with the side of the blade marked "Bottom" (or with part number) facing the ground when the mower is in the operating position.

#### **Blade Mounting Torque**

Center Bolt: 450 in. lbs. min., 600 in. lbs. max.

Blade Adapter Bolts: 200 in. lbs. min., 350 in. lbs. max.

To insure safe operation of your unit, all nuts and bolts must be checked periodically for correct tightness.

#### **DECK**

The underside of the mower deck should be cleaned after each use to prevent a buildup of grass clippings, leaves, dirt or other matter. If this debris is allowed to accumulate, it will invite rust and corrosion, and may prevent proper mulching.

The deck may be cleaned by tilting the mower and scraping clean with a suitable tool (make certain the spark plug wire is disconnected).

#### **ENGINE**

**Refer to the separate engine manual for engine maintenance instructions.**

Maintain **engine oil** as instructed in the separate engine manual packed with your unit. Read and follow instructions carefully.

Service **air cleaner** every 25 hours under normal conditions. Clean every few hours under extremely dusty conditions. Poor engine performance and flooding usually indicates that the air cleaner should be serviced. To service the air cleaner, refer to the separate engine manual packed with your unit.

The **spark plug** should be cleaned and the gap reset once a season. Spark plug replacement is recommended at the start of each mowing season; check engine manual for correct plug type and gap specifications.

**Clean the engine** regularly with a cloth or brush. Keep the cooling system (blower housing area) clean to permit proper air circulation which is essential to engine performance and life. Be certain to remove all grass, dirt and combustible debris from muffler area.

---

## **OFF-SEASON STORAGE**

---

The following steps should be taken to prepare lawn mower for storage.

1. Clean and lubricate mower thoroughly as described in the lubrication instructions.
2. Refer to engine manual for correct engine storage instructions.
3. Coat mower's cutting blade with chassis grease to prevent rusting.
4. Store mower in a dry, clean area. Do not store next to corrosive materials, such as fertilizer.

**NOTE:** *When storing any type of power equipment in an unventilated or metal storage shed, care should be taken to rust-proof the equipment. Using a light oil or silicone, coat the equipment, especially cables and all moving parts.*

---

## **HANDLE STORAGE**

---

The handle may be placed in an upright position for storage. Move hairpin clips to outer hole on weld pins. See figure 1. Press inward on the bottom of the lower handle and push forward. The handle will lock in this position.

To place the handle in the operating position, remove the starter rope from the rope guide. Grasp the lower handle at the bottom, press inward slightly and tip the handle backward. Place the hairpin clips in the inner holes. With the spark plug wire disconnected and grounded, depress the blade control handle and pull the starter rope out from the engine. Slip the starter rope into the rope guide.

# TROUBLE SHOOTING GUIDE

Trouble	Possible Cause(s)	Corrective Action
Engine fails to start	<ol style="list-style-type: none"> <li>1. Blade control handle disengaged.</li> <li>2. Spark plug wire disconnected.</li> <li>3. Throttle control lever not in CHOKE or START position.</li> <li>4. Fuel tank empty, or stale fuel.</li> <li>5. Blocked fuel line.</li> <li>6. Faulty spark plug.</li> <li>7. Engine flooded.</li> </ol>	<ol style="list-style-type: none"> <li>1. Engage blade control handle.</li> <li>2. Connect wire to spark plug.</li> <li>3. Move throttle lever to CHOKE or START position.</li> <li>4. Fill tank with clean, fresh gasoline.</li> <li>5. Clean fuel line.</li> <li>6. Clean, adjust gap or replace.</li> <li>7. Remove spark plug, dry the plug, and crank engine with plug removed and throttle in off position. Replace spark plug, connect wire and resume starting procedures.</li> </ol>
Engine runs erratic	<ol style="list-style-type: none"> <li>1. Unit running in CHOKE or START position.</li> <li>2. Spark plug wire loose.</li> <li>3. Blocked fuel line or stale fuel.</li> <li>4. Vent in gas cap plugged.</li> <li>5. Water or dirt in fuel system.</li> <li>6. Dirty air cleaner.</li> <li>7. Carburetor out of adjustment.</li> </ol>	<ol style="list-style-type: none"> <li>1. Move throttle lever to FAST position.</li> <li>2. Connect and tighten spark plug wire.</li> <li>3. Clean fuel line; fill tank with clean, fresh gasoline.</li> <li>4. Clear vent.</li> <li>5. Drain fuel tank. Refill with fresh fuel.</li> <li>6. Clean air cleaner.†</li> <li>7. Adjust carburetor.†</li> </ol>
Engine overheats	<ol style="list-style-type: none"> <li>1. Engine oil level low.</li> <li>2. Air flow restricted.</li> <li>3. Carburetor not adjusted properly.</li> </ol>	<ol style="list-style-type: none"> <li>1. Fill crankcase with proper oil.</li> <li>2. Remove blower housing and clean.†</li> <li>3. Adjust carburetor.†</li> </ol>
Occasional skip (hesitates) at high speed	Spark plug gap too close.	Adjust gap to .030".
Idles poorly	<ol style="list-style-type: none"> <li>1. Spark plug fouled, faulty or gap too wide.</li> <li>2. Carburetor improperly adjusted.</li> <li>3. Dirty air cleaner.</li> </ol>	<ol style="list-style-type: none"> <li>1. Reset gap to .030" or replace spark plug.</li> <li>2. Adjust carburetor.†</li> <li>3. Clean air cleaner.†</li> </ol>
Excessive vibration	<ol style="list-style-type: none"> <li>1. Cutting blade loose or unbalanced.</li> <li>2. Bent cutting blade.</li> </ol>	<ol style="list-style-type: none"> <li>1. Tighten blade and adapter. Balance blade.</li> <li>2. Replace blade.</li> </ol>
Mower will not mulch grass	<ol style="list-style-type: none"> <li>1. Engine speed too low.</li> <li>2. Wet grass.</li> <li>3. Excessively high grass.</li> <li>4. Dull blade.</li> </ol>	<ol style="list-style-type: none"> <li>1. Set throttle between 3/4 and full throttle.</li> <li>2. Do not mow when grass is wet; wait until later to cut.</li> <li>3. Mow once at a high cutting height, then mow again at desired height or make a narrower cutting swath (1/2 width).</li> <li>4. Sharpen or replace blade.</li> </ol>
Uneven cut	<ol style="list-style-type: none"> <li>1. Wheels not positioned correctly.</li> <li>2. Dull blade.</li> </ol>	<ol style="list-style-type: none"> <li>1. Place all four wheels in same height position.</li> <li>2. Sharpen or replace blade.</li> </ol>

†Refer to separate engine manual packed with your unit.

**Note:** For repairs beyond the minor adjustments listed above, contact your local authorized service dealer.

# Models 093R, 095R, 096R and 098R

**NOTE**

This instruction manual covers various models, and all specifications shown do not necessarily apply to your model. Specifications subject to change without notice or obligation.

†Optional Hub Caps

Description	Part No.
Gray (5-1/2" Dia.)	731-0981A
Beige (5-1/2" Dia.)	731-0982A
Gray (3-1/2" Dia.)	720-0249
Black (1-1/2" Dia.)	720-0251
Red (1-3/8" Dia.)	731-0342

*ACE HOWE UNITS  
(096R)  
SEE NOTE FOR  
THROTTLE CONTROL,  
CABLE, ETC.*

*POSITION IN  
BOTTOM HOLE  
ON HANDLE*

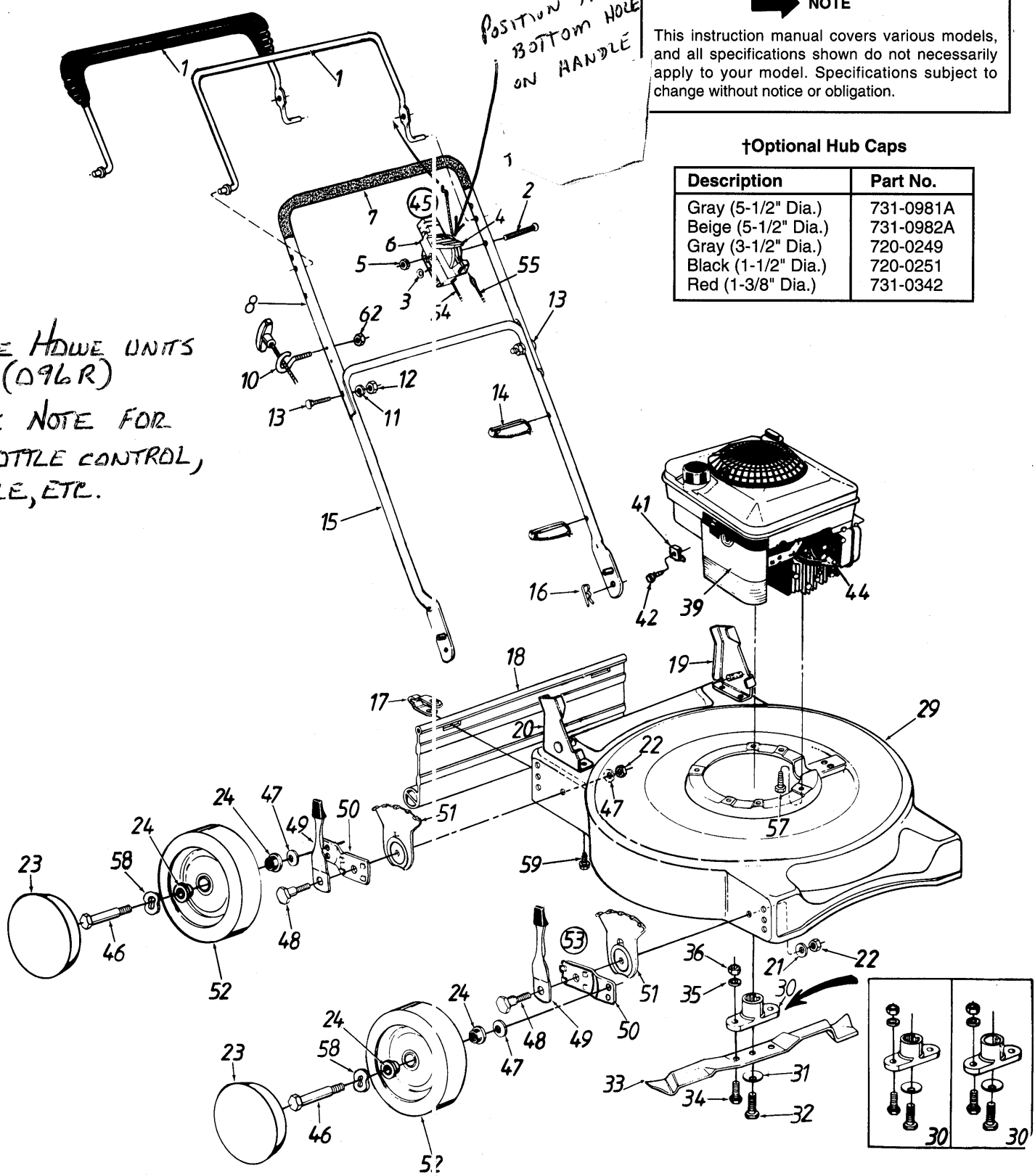







# Models 093R, 095R, 096R and 098R

## PARTS LIST FOR MODELS 093R, 095R, 096R and 098R ROTARY MOWERS

REF. NO.	PART NO.	CODE	DESCRIPTION	REF. NO.	PART NO.	CODE	DESCRIPTION
1	647-0004	N	Control Handle Ass'y. (Deluxe)	33	742-0500		20" Mulching Blade
	747-0824	N	Control Handle Ass'y. (Std.)	34	710-1055		Hex Bolt 3/8-24 x 1" Lg.
2	710-0605	N	Oval C-Sunk Scr.	35	736-0169		L-Wash. 3/8" I.D.*
3	736-0501	N	Spr. Wash. .66" I.D.	36	712-0241		Hex Nut 3/8-24 Thd.
4	746-0876	N	Throttle Lever	39	—		Engine
5	712-0291		Hex L-Nut 1/4-20 Thd.	41	751-0568	N	Cable Clamp
6	746-0875	N	Throttle Body	42	710-1237	N	Hex Self-Tap Scr. #10-32 x .62"
7	720-0226		Grip	44	735-0639		Spark Plug Boot
8	749-0538C	N	Upper Handle	45	811-00185	N	Throttle Box Comp. (Incl. Ref. 2, 3, 4, 5, 6)
10	710-1205		Rope Guide	46	738-0102		Axle Bolt
11	736-0119		L-Wash. 5/16" I.D.*	47	736-0105		Bell-Wash. .400" I.D. x .88"
12	712-0267		Hex Nut 5/16-18 Thd.*	48	738-0507B		Shld. Bolt .50" Dia. x .357"
13	710-0671		Curved Carriage Bolt 5/16-18 x 1.38" Lg.	49	14832		Spring Lever Ass'y. w/Knob
14	726-0240		Cable Tie	50	15262B		Pivot Bar
15	749-0372B		Lower Handle	51	15261A		Height Adj. Plate
16	714-0104		Hairpin Cotter	52	**		Wheel Ass'y. Comp.
17	17098		Hinge Clip	53	14578		Height Adj. Ass'y. Comp.—R.F. & L.R.
18	731-0872		Rear Flap		14579		Height Adj. Ass'y. Comp.—L.F. & R.R.
19	12935A		Handle Bracket Ass'y.—L.H.	54	746-0842	N	Throttle Cable—51" (B&S)
20	12936A		Handle Bracket Ass'y.—R.H.		746-0845	N	Throttle Cable—45" (Tec.) <i>WHITE</i>
21	736-0356		Bell-Wash. .39" I.D. x 1.38"	55	746-0550		Control Cable—39" (B&S)
22	712-0798		Hex Nut 3/8-16 Thd.*		746-0552		Control Cable—49" (Tec.) <i>BLUE</i>
23	†		Hub Cap	57	710-0654A		Hex L-Wash. Hd. Scr. 3/8-16 x 1.0" Lg.
24	**		Bearing (Optional)	58	736-0232		Wave Washer .53" I.D.
29	682-0002		20" Deck Ass'y.	59	710-0603		Hex Wash. Hd. B-Tap Scr. 5/16-18 x .5" Lg.
30	753-0484		Blade Adapter Kit (Keyed)	62	712-0324		Hex L-Nut 1/4-20 Thd.
	753-0485		Blade Adapter Kit (Splined)				
31	736-0452		Bell-Wash. .39" I.D. (Used w/Keyed Adapter)				
	736-0453		Bell-Wash. .46" I.D. (Used w/Splined Adapter)				
32	710-1044		Hex Bolt 3/8-24 x 1.5" Lg. (Used w/Keyed Adapter)				
	710-0757		Hex Bolt 7/16-20 x 1.5" Lg. (Used w/Splined Adapter)				

### \*\*WHEEL CHART

Wheels w/o Bearings			Wheels with Bearings			
Tread***	Ass'y. Comp.	Axle Bolt	Tread***	Ass'y. Comp.	Bearings	Axle Bolt
Diamond	634-0004 (7")	738-0102	"S" Wave	734-1513B (Gray)	Ball Brg. 1/2" I.D.-741-0180 (2 per Wheel)	738-0102
	734-1655 (8")	738-0102		734-1517B (Beige)	Ball Brg. 1/2" I.D.-741-0180 (2 per Wheel)	738-0102
				734-1510B (Gray)	Ball Brgs. 3/8" I.D.-741-0267, 1/2" I.D.-741-0484, Spacer-750-0434	738-0102
Bar*	734-1608 (8")	738-0102	Waffle	734-0645	Ball Brgs. 3/8" I.D.-741-0267, 1/2" I.D.-741-0484, Spacer-750-0434	710-1020
	634-0020 (8" x 1.75")	738-0102				
"S" Wave	734-1512A (8")	738-0102				
Waffle	734-1162A (8")	738-0102	"T" Tread	734-1259	Ball Brgs. 3/8" I.D.-741-0267, 1/2" I.D.-741-0484, Spacer-750-0434	710-1020
Rib	734-1169 (8")	738-0144		734-1260	Ball Brg. 1/2" I.D.-741-0180 (2 per Wheel)	738-0102

\*\*\*Tread Type: Waffle  ; Rib  ; Bar  ; "T" Tread  ; "S" Wave  ; Diamond 

634-0020 8" PLASTIC



**NOTE:** The use of any accessory on this Rotary Mower other than those manufactured by the mower manufacturer is **not** recommended.

**WARNING:** To reduce the risk of injury, do not operate mower unless rear trailing shield is in its proper place.

\*For faster service obtain standard nuts, bolts and washers locally. If these items cannot be obtained locally, order by part number and size as shown on parts list.

NOTE: The engine is not under warranty by the mower manufacturer. . .If repairs or service is needed on the engine, please contact your nearest authorized engine service outlet. Check the "Yellow Pages" of your telephone book under "Engines-Gasoline."



**CODE: N** notates a **new part** (not previously existing). A three digit number is the **color code**. Specify color code as shown below if color or finish is important when ordering parts. [i.e., 638 for Red Finish].

**Color Codes**

456—Radiant Tangerine	637—Black
460—Green Flake	638—Red
483—Charcoal Gray	640—Green
498—Yellow	646—CM Blue
499—Beige	657—Teal
629—Silver Flake	

***FOR REPLACEMENT PARTS, CONTACT:***  
**SERVICE DEPARTMENT • P.O. BOX 360900 • CLEVELAND, OHIO 44136**