

FURUNO

OPERATOR'S MANUAL ADDENDUM

Model: GP1650/1850 Series

**Subject: New FISHING MODE and
Feature Enhancements**

This Furuno GP1650/1850 Series Plotter has a newly developed software revision that includes many exciting new features. This addendum is a supplement to your Operator's Manual. It describes these new features and explains how to utilize them.



FURUNO ELECTRIC CO., LTD.
NISHINOMIYA, JAPAN

TABLE OF CONTENTS

A. Explanation of New Features.....	2
B. Operator's Manual Information.....	3
C. Software Revision Check.....	3
D. New Fishing Modes and Mark Function.....	5
E. New Memory Card Storage Function.....	8
F. <i>Navionics "Nav-Chart"</i> Cartography "OFFSET" Capability...11	
G. RTCM DGPS Data Output(1650/1850 "D"/"DF" ONLY).....12	
H. New "Wide-Screen" E/S Mode(1650/1850 "F"/"DF" ONLY)..13	

A. Explanation of New Features:

- 1. New "Fishing Plotter Mode":** This feature allows you to place your GP1650/1850 in either a "Pleasure Mode" or a "Fishing Mode". In the "Pleasure Mode", the GP1650/1850 operates the same as previous software revisions.
In the new Fishing Mode, you can place Marks and Line Points (Up To 5000) in internal memory. The mode also allows you to change Track Colors, Start/Stop Own Ship Tracking, and Edit Mark Entries easily from a newly added Softkey Menu. In "Pleasure Mode", this new Softkey Menu is not displayed.
- 2. New "Memory Card Storage" Capability:** It is now possible to store Marks/Lines, Waypoints/Routes, Tracks, and Configuration Information (Menu Settings) of the GP1650/1850 Series onto a memory card. The entire memory contents of a GP1650/1850 can be stored into a single memory card for storage or cloning your GP1650/1850. This provision allows Unlimited Data Storage for the GP1650/1850 Series. Uploading/Downloading Waypoint information via the RS232 PC Interface has remained unchanged. The part number for the RAM Storage Card is 000-140-483. It is available from any authorized Furuno Dealer.
- 3. RTCM DGPS Data Output:** It is now possible to send RTCM 104, Differential Correction Data, to other Differential-Ready GPS Products on your vessel. This feature requires a "D" or "DF" version.

4. **Navionics Cartography "OFFSET" Capability**: This new software allows operators to OFFSET Navionics Charts. Previous software versions did not have this capability.
5. **"Wide-Screen" Echo Sounder Mode**: When operating in the "Split Screen" mode (Plotter and Sounder display), this function allows the user to select between the wide (50%) or narrow (25%) sounder screen. This feature requires a "F" or "DF" version.

B. Operator's Manual – The Operator's Manual included with your GP1650/1850 is not updated at this time. We will offer revised Operator's Manuals late in the first quarter of 2000.

Please call your authorized Furuno Dealer for further information.

This software revision does not effect the Installation Manual included with your GP1650/1850.

C. Software Revision Check (For Confirmation Only) - The Software Revision of your GP1650/1850 can be found by using the "Self Test" procedure on page 4.

The "Memory I/O" test will display the software revision number in the **upper left corner of the display**.

The **last two digits** of the number indicate which software version is currently installed.

If your revision number is lower than the ones listed below, a simple software upgrade for any GP1650/1850 is all that is necessary to take advantage of the new features available.

Call your local Furuno Dealership for more information.

-GP1650/GP1650D	Software Version 145-1801- 013 and higher
-GP1650F/GP1650DF	Software Version 145-1802- 011 and higher
-GP1850D	Software Version 145-1826- 006 and higher
-GP1850DF	Software Version 145-1827- 006 and higher

Diagnostic Tests

Memory, I/O port test

This test conducts a general check of the display unit and the antenna unit. The unit displays the results for each device or component checked as OK or NG (No Good).

1. Press the [MENU] key to open the main menu.
2. Press the soft key CONFIGURATION to show the configuration menu.

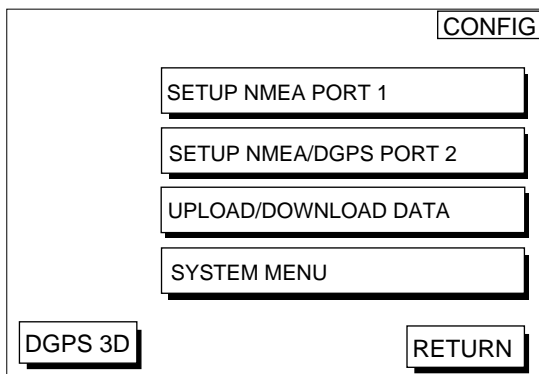

Figure 12-1 Configuration menu

3. Press the soft key SYSTEM MENU to open the system menu.

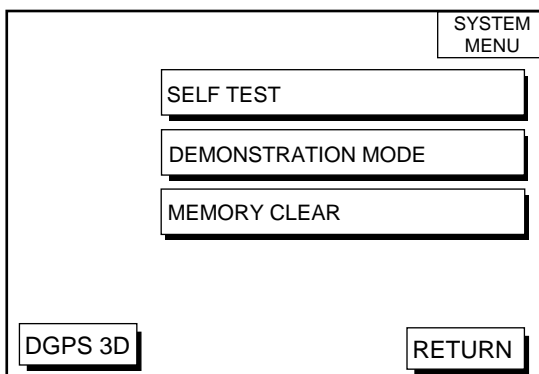

Figure 12-2 System menu

4. Press the soft key SELF TEST to open the test menu.

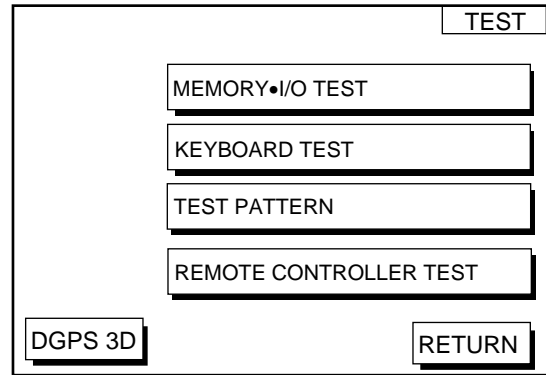
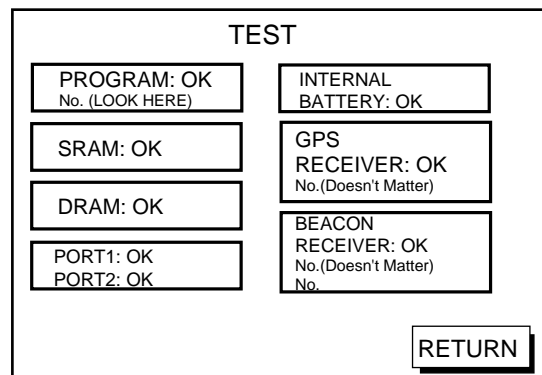

Figure 12-3 Test menu

5. Press the soft key MEMORY•I/O TEST to start the test. Test results and program nos. are shown as below.



NOTE: Special connections are required to check PORT1 and PORT2 otherwise, "--" appears.

Figure 12-4 Memory, I/O test results

6. The test runs continuously. To return to the self test menu, press the soft key RETURN.

Note: BEACON RECEIVER results only appear on GP-1650/1850 "D" and "DF" Ver.

Changing Operation Mode

Operation mode can be changed between PLEASURE and FISHING. FISHING mode provides mark/line entries on the PLOTTER display. Up to 5000 Marks can be entered together with track points. Apportioning between track and mark memory can be changed by menu. Pressing the [HIDE/SHOW] key changes the function of soft keys. Holding tracks, changing track color, selecting mark colors, and the type of marks/lines can be performed by the soft keys directly.

1. Press the [MENU] key and the soft key DISPLAY OPTIONS. The display setup1 menu appears.

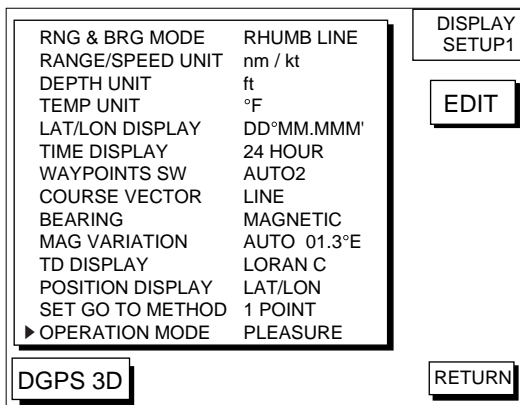

Display setup1 menu

2. Press ▼ to select OPERATION MODE.
3. Press the soft key EDIT to show the OPERATION MODE window.

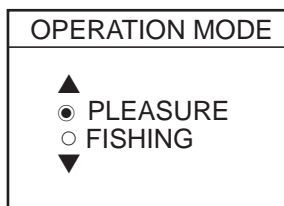

OPERATION MODE window

4. Press ▲ or ▼ to select PLEASURE or FISHING.
5. Press the soft key ENTER or the [ENTER] key to finish.

In the FISHING mode, pressing the [HIDE/SHOW] key changes the function of soft keys as follows.

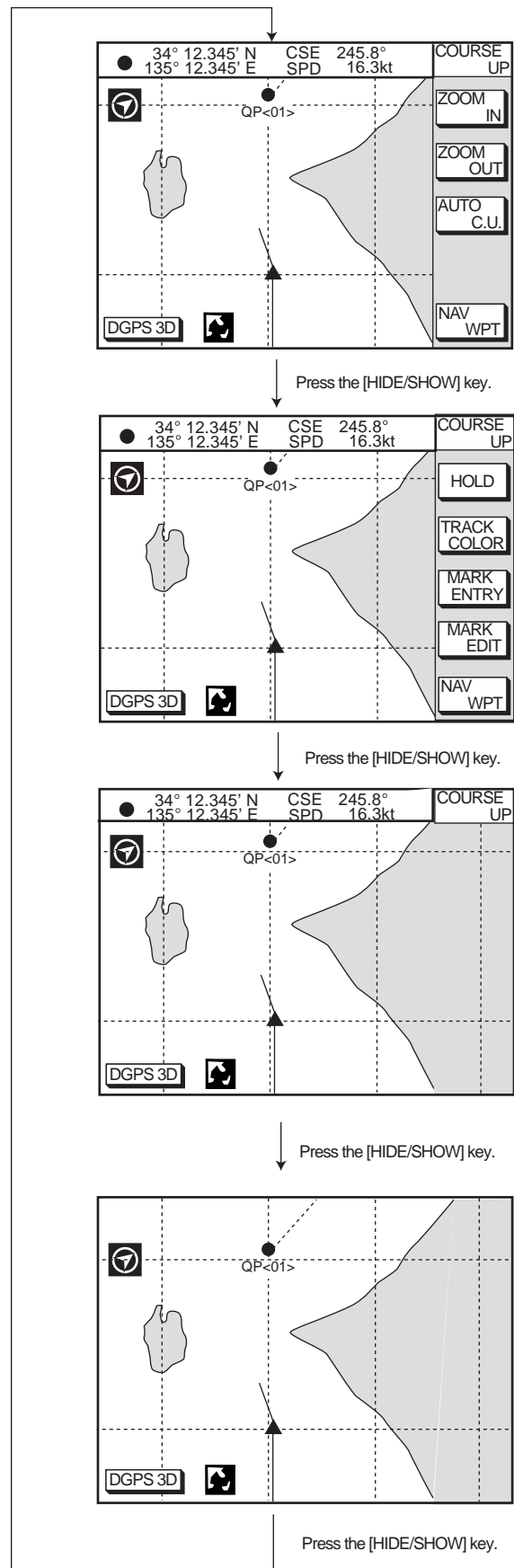

Changing displays by Scrolling

MARKS

1 Entering Marks

Select the Fishing Mode to enable entry of marks on the PLOTTER display. Select the location desired with the cursor, or turn off the cursor to enter the mark at own ship position. Pressing the [HIDE/SHOW] key changes the function of soft keys. Press the soft key MARK ENTRY to enter a new mark. The mark is entered in the shape and color selected from the MARK SHAPE and MARK COLOR selection windows.

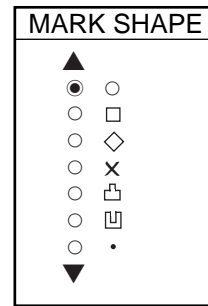

MARK SHAPE window

2 Changing Mark Attributes

You can select the shapes, line types and colors of Marks and Lines on the TRACK display.

1. Press the [HIDE/SHOW] key to show the soft key MARK EDIT.
2. Press the soft key MARK EDIT to show the MARK/LINE window.

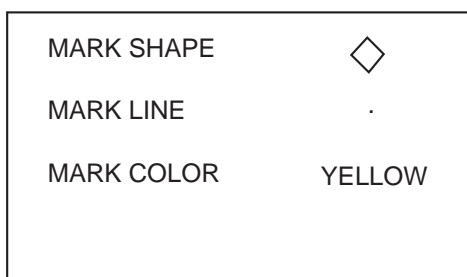

MARK/LINE window

3. Press the soft key MARK SHAPE to change mark shape, the soft key MARK LINE to change mark line, or the soft key MARK COLOR to change mark color.

Mark shape

Press the soft key MARK SHAPE to display the MARK SHAPE window. Press ▲ or ▼ to select mark shape desired.

Mark line

Press the soft key MARK LINE to display the MARK LINE window. Press ▲ or ▼ to select mark line desired.

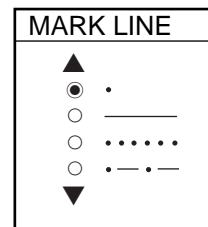

MARK LINE window

Mark color

Press the soft key MARK COLOR to display the MARK COLOR window. Press ▲ or ▼ to select mark color desired.

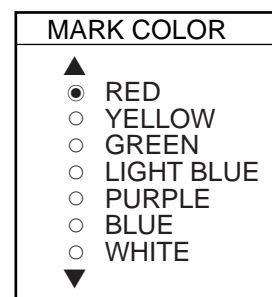

MARK COLOR window

4. Press the soft key ENTER or the [ENTER] key.
5. Press the soft key RETURN to finish.

Marks/lines entered hereafter are inscribed in the shape, color and line type selected here.

3 Changing Mark Size

Mark size can be selected from STD (standard) and SMALL.

1. Press the [MENU] key to display the main menu.
2. Press the soft key CHART SETUP OPTIONS.
3. Press the soft key CHART DETAIL to open the CHART DETAIL menu.

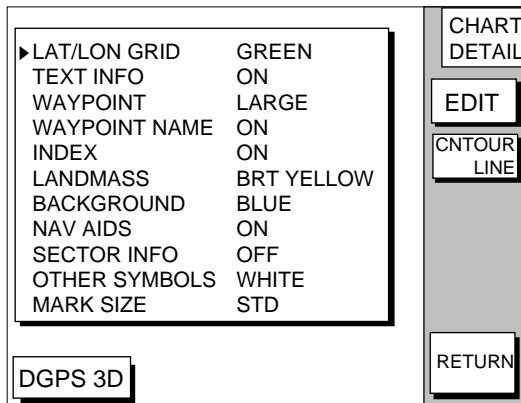

CHART DETAIL menu

4. Press ▼ to select MARK SIZE.
5. Press the soft key EDIT.
6. Press ▲ or ▼ to select STD (standard) or SMALL.
7. Press the [ENTER] key.

4 Erasing Marks

Erasing individual marks/lines

1. Operate the cursor pad to place the cursor on the mark you want to erase.
2. Press the [CLEAR] key. The mark selected is erased.

Note: To erase a line, place the cursor on the edge of the line. The line segment will be erased.

Erasing whole marks/lines

You can erase all marks and lines. Be absolutely sure you want to erase all marks and lines; erased marks and lines cannot be restored.

1. Press the [MENU] key followed by the soft keys CHART SETUP OPTIONS and TRACK CONTROL.
2. Press the soft key ERASE MARK. You are asked if you are sure to erase all marks and lines.
3. Press the [ENTER] key to erase, or press the [CLEAR] key to escape.

5 Displaying Track and Mark Points

Number of track and mark points used appears in the TRACK STATUS window on the TRACK CONTROL display. For further details see TRACK CONTROL WINDOW.

SAVING AND LOADING DATA TO/FROM MEMORY CARDS

The following data can be saved to memory card:

- Mark/line
- Waypoints/routes
- Track
- Configuration (menu settings)

1 Formatting Memory Cards

Before you can use a memory card it must be formatted. Note that formatting always erases all saved data on the card!

1. Insert the memory card you want to format into the slot.
2. Press the [MENU] key followed by the soft keys CONFIGURATION and UPLOAD/DOWNLOAD DATA.

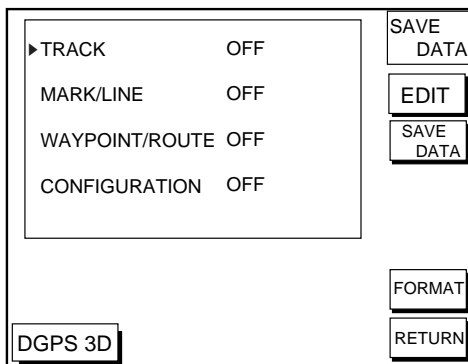

SAVE DATA display

3. Press the soft key SAVE DATA TO MEMORY CARD and the soft key FORMAT. You are asked if you are ready to format the memory card.
4. Press the [ENTER] key to format (or press the [CLEAR] key to escape). Now FORMATTING MEMORY CARD appears. Do not remove the card while it is being formatting. When the formatting is completed, FORMAT COMPLETED appears.
5. Press the [ENTER] key to finish. Now you can record data to the memory card.

2 Saving Data to Memory Card

The memory card can save four items of data; track, mark/line, waypoint/route and configuration.

Saving data

1. Insert a formatted memory card into the slot.
2. Press the [MENU] key followed by the soft keys CONFIGURATION and UPLOAD/DOWNLOAD DATA.
3. Press the soft key labeled SAVE DATA TO MEMORY CARD. The SAVE DATA display appears.
4. Press ▲ or ▼ to select item to save.
5. Press the soft key EDIT to open the TRACK, MARK/LINE, WAYPOINTS/ROUTES or CONFIGURATION window.
6. Press ▲ to select ON.
7. Press the soft key ENTER or the [ENTER] key.
8. Repeat from steps 4 to 7 to save other data if desired.
9. Press the soft key SAVE DATA. The following message appears and saving starts. Do not remove the memory card while data is being saved.

NOW SAVING DATA TO MEMORY CARD. DO NOT TURN OFF THE POWER UNTIL SAVING COMPLETED.

SAVE DATA message

When saving is completed, COMPLETE SAVING DATA appears.

10. Press the [ENTER] key.

Error message

Memory card not inserted

Press the [ENTER] key to return to the SAVE DATA display.

MEMORY CARD NOT
INSERTED. INSERT CARD
PRESS "ENTER" key
TO CONTINUE.

NOT INSERTED message

Unformatted memory card

Press the [ENTER] key to return to the SAVE DATA display. And format it referring to the previous page.

MEMORY CARD NOT
FORMATTED
PRESS "ENTER" key
TO CONTINUE.

NOT FORMATTED message

Wrong card inserted

Appears when a chart card is inserted. Press the [ENTER] key to return to the SAVE DATA display. Replace it with a formatted memory card.

WRONG CARD INSERTED.
INSERT MEMORY CARD.
PRESS "ENTER" key
TO CONTINUE.

WRONG CARD message

Data overwrite

Data type to be recorded exists on memory card. (Two or more of same data type cannot be recorded.) Press the [ENTER] key to overwrite same data type on the card, or press the [CLEAR] key to escape.

 OVERWRITE FOLLOWING
DATA. OK?
(TRACK)
YES ... "ENTER" key
NO ... "CLEAR" key

OVERWRITE message

3 Loading Data from Memory Card

Data (track, marks, waypoints, configuration) can be loaded from a memory card and displayed on the screen. This feature is useful for observing past data and setting up the equipment for a specific purpose (with "configuration").

1. Press the [MENU] key followed by the soft keys CONFIGURATION and UPLOAD/DOWNLOAD DATA.
2. Press the soft key LOAD DATA FROM MEMORY CARD to show the LOAD DATA display.

▶ TRACK	OFF	LOAD DATA
MARK/LINE	OFF	EDIT
WAYPOINT/ROUTE	OFF	LOAD DATA
CONFIGURATION	OFF	
DGPS 3D		RETURN

LOAD DATA display

3. Press ▲ or ▼ to select item to load.
4. Press the soft key EDIT to show the ON/OFF selection window.
5. Press ▲ to select ON. Press the soft key ENTER or the [ENTER] key. If the memory card does not contain the item selected, the buzzer sounds and ON cannot be selected.

6. After you select all items desired, press the soft key LOAD DATA to load data. The following message appears.

NOW LOADING DATA FROM
MEMORY CARD. DO NOT
TURN OFF THE POWER UNTIL
LOADING COMPLETE.

LOAD DATA message

After loading is completed, the following message appears.

COMPLETE LOADING DATA.
PRESS "ENTER" KEY
TO CONTINUE.

COMPLETE message

7. Press the [ENTER] key.

Note on loading data

Track

Since loaded track data is added to internal track, oldest track will be erased when the track memory capacity is exceeded.

Waypoint/route

The loaded data **OVERWRITES** previously stored waypoints and routes. **BE CAREFUL NOT TO DESTROY VALUABLE DATA!**

Mark/line

The loaded data is added to internal data. When the mark/line memory becomes full no marks may be entered.

Configuration

The loaded data replaces current configuration settings. Press the [ENTER] key to restart. If the memory card is ejected while loading or data could not be loaded, press the [ENTER] key to restart with default settings. Note that track memory capacity is not saved or loaded.

CUSTOMIZING YOUR UNIT

This section describes the various options which allow you to set up your unit to suit your needs.

1 CHART SETUP OPTIONS menu

The chart offset options menu provides three menus: chart offset, track control, and chart detail.

1. Press the [MENU] key to open the main menu.
2. Press the soft key CHART SETUP OPTIONS.

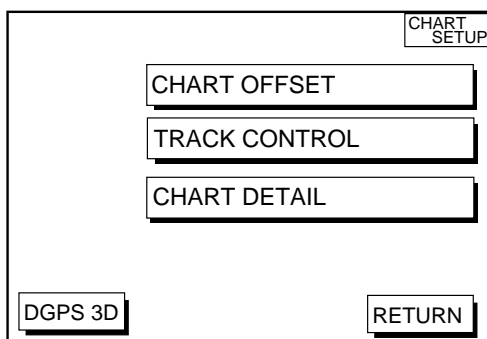

11-1 Chart setup options menu

CHART OFFSET-NEW FOR NAVIONICS

In some instances position may be off by a few minutes. For example, the position of the ship is shown to be at sea while it is in fact moored at a pier. You can compensate for this error by offsetting chart position as follows:

1. Press the [MENU] key followed by the soft keys CHART SETUP OPTIONS and CHART OFFSET.

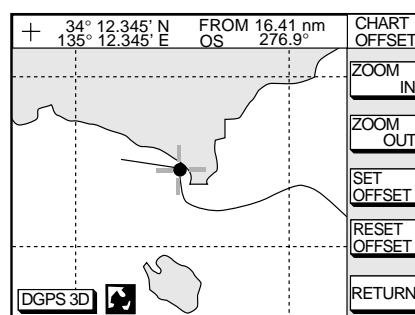

Plotter display,
chart offset selected

2. Use the cursor pad to place the cursor where to offset chart position.
3. Press the soft key SET OFFSET.
4. Press the soft key RETURN to finish.

To cancel chart offset, press the soft key RESET OFFSET at step 3 in the above procedure.

TRACK CONTROL menu

This menu mainly controls track color and track plotting interval. For further details see Track Chapter.

SETUP NMEA/DGPS PORT 2 menu description

This menu should be set according to the specifications of the equipment connected to connectors PORT 1 (NMEA) and PORT 2 (DGPS) at the rear of the display unit. The menu can be displayed by pressing the [MENU] key followed by the soft keys CONFIGURATION and SETUP NMEA PORT 2. For detailed information, see the installation manual.

FORMAT- WITH NEW RTCM(OUTPUT)

Selects data format of connected equipment; NMEA0183 version 1.5, version 2.0, RTVM104 (EXTRN), RTCM104 (INTRN) or RTCM104 (OUTPUT). RTCM104 (INTRN) is for "D" versions only. The default setting for non-"D" versions is RTCM104 (EXTRN).

The procedure for setting LAT/LON FORMAT is similar to those for PORT 1. Note that you cannot setup data sentences when you select RTCM104 (INTRN) as the format. (A level converter (IF-1432) maybe required when using NMEA0183 format from this port.)

LAT/LON FORMAT (GGA only)

Selects the seconds of latitude and longitude positions in hundredths, thousandths or ten thousandths of a degree.

UPLOAD/DOWNLOAD DATA menu

This menu allows you to upload waypoint and route data to a PC or download the same data from a PC, via the DGPS connector at the back of display unit. The menu can be displayed by pressing the [MENU] key followed by the soft keys CONFIGURATION and UPLOAD/DOWNLOAD DATA. For detailed information, see the installation manual.

See previous pages for Memory Card info.

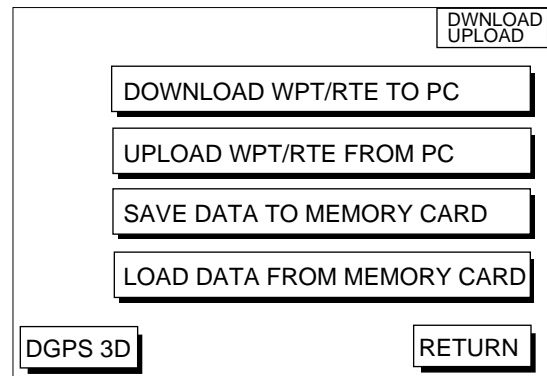

upload/download menu

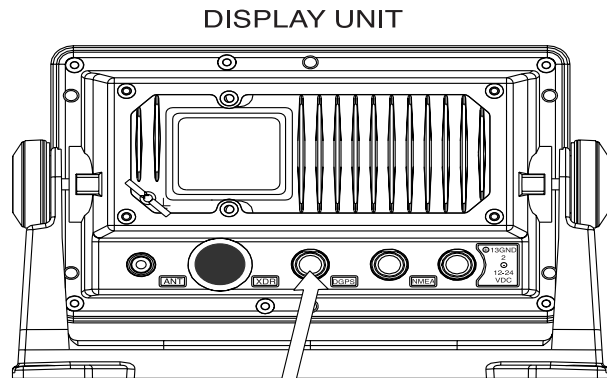

Connect with PC here.

Display unit, rear view

Set communication software on the PC as follows:

Baud Rate:	4800 bps
Character Length:	8 bit
Stop bit:	1 bit
Parity:	None
X Control:	XON/XOFF

The following data can be downloaded/uploaded between a personal computer and this equipment.

- Waypoint data (In alphanumeric order)
- Route data (In order of route number)
- End of sentence

Note 1: There are two kinds of data for route data: route data and route comment data.

Note 2: DGPS position fix is not available when uploading or downloading data.

A-scope display

This display shows echoes at each transmission with amplitudes and tone proportional to their intensities, on the right 1/3 of the screen. It is useful for estimating the kind of fish school and seabed composition.

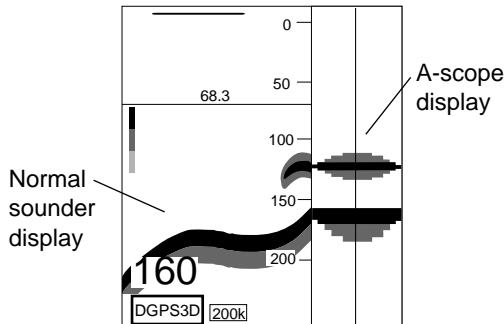

A-scope display plus normal sounder display

4. Press ▲ or ▼ to select STD or WIDE.

STD: The width of the sounder display is approx. 20 mm (Default setting).

WIDE: The width is approx. 40 mm.

5. Press the [ENTER] key or the soft key ENTER.

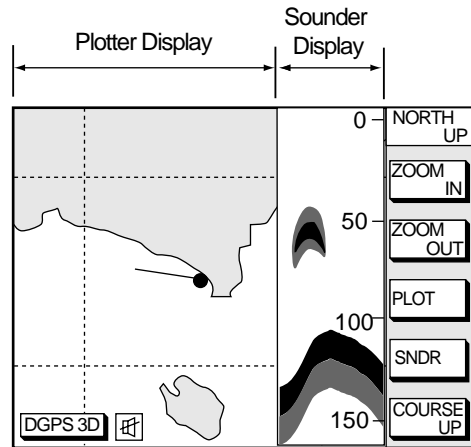

Plotter/Sounder display

New Wide Plotter/ES Display

This display provides the plotter display on the left part of the screen and the normal sounder display on the right part. It is useful for searching fish schools at cruising speed. The width of the sounder display can be selected between standard (approx. 20 mm) and wide (approx. 40 mm).

1. Press the [MENU] key and the soft key SOUNDER SETUP OPTIONS. The sounder setup menu appears. See Figure 1-9.
2. Press ▼ to select E/S WINDOW window.
3. Press the soft key EDIT to show the E/S WINDOW window.

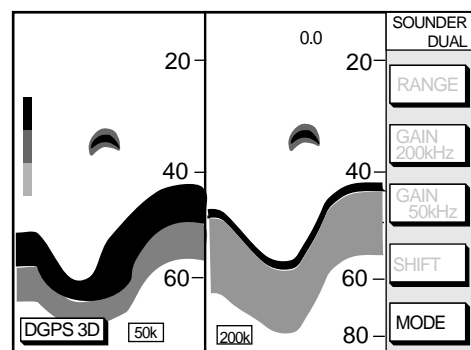
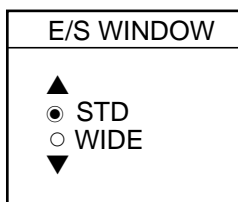

Dual-frequency display example