

# FURUNO

# OPERATOR'S MANUAL

**GPS PLOTTER**

---

**MODEL GP-1250**

---



**FURUNO ELECTRIC CO., LTD.**  
NISHINOMIYA, JAPAN

**©FURUNO ELECTRIC CO., LTD.**

9-52, Ashihara-cho,  
Nishinomiya, Japan 662

Telephone: 0798-65-2111  
Telefax: 0798-65-4200

-Your Local Agent/Dealer

All rights reserved. Printed in Japan

FIRST EDITION : JUL 1991  
F : OCT. 19, 1993

(SHNI)

PUB. No. OME-43371  
GP-1250

\* 0 0 0 8 0 2 9 3 5 0 0 \*

# **WELCOME TO THE WORLD OF THE GPS PLOTTER!**

Furuno Electric Company thanks you for selecting and purchasing the GP-1250 GPS Plotter. We are confident you will discover why the Furuno name has become synonymous with quality and reliability.

For over 40 years Furuno Electric Company has enjoyed an enviable reputation for quality and reliability throughout the world. This dedication to excellence is furthered by our extensive global network of agents and dealers.

The GP-1250 GPS Plotter is the culmination of a long line of Furuno developments in the field of navigation. In one remarkably small cabinet is an unbeatable combination of a professional GPS receiver and virtually all the navigation capabilities most voyagers will ever need. Daily used functions are accessible directly by hitting hot keys.

Because the unit is small there may be a tendency to forget just how sophisticated this machine really is, and perhaps to disregard the fact that no machine can perform its intended function unless it is installed properly. The desirability of a professional installation and a thorough checkout cannot be overemphasized!

## **ORGANIZATION OF THIS MANUAL**

Layout of this manual is so designed to guide the user along in the use of the gear as gently and as comfortably as possible in a series of chapters that start at a very basic level and proceed forward in complexity in a logical manner. Contents of this manual are briefed below:

### **About GPS**

This chapter explains principle of the GPS system and the operation of the GP-1250. Some important concepts, such as HDOP, BACK-UP NAVAID, ALMANAC, etc. are also explained in this chapter. These knowledges are indispensable to understand the succeeding chapters.

### **BASIC LEVEL OPERATION**

This chapter explains the most elementary but most important operations, mainly concerning the plotter screen. When you are through with this chapter, you may perform position fixing/plotting, and may be able to sail to a desired location using a cross cursor.

## About MENU SCREEN

In the succeeding chapters, you enter various data through menu screens. This chapter allows you to get familiar with the menu system.

## WAYPOINT NAVIGATION

You may sail to a desired location in the shortest path, using a sophisticated method called a Waypoint Navigation.

## ROUTING NAVIGATION

Unlike the waypoint navigation, this method supports a navigation involving a series of course changes.

The following chapters cover the operations which are more advanced or more seldomly used when compared with the ones explained until now.

## ALARM FUNCTIONS

Various alarm functions (arrival alarm, cross-track error alarm, and border alarm) are explained.

## MEMORY PARTITIONS

This chapter explains how to save/display ship's track line to/from the internal memory partitions.

## RAM CARD (optional)

This chapter explains how to save/reload ship's track line and waypoints to/from the optional RAM card.

## MISCELLANEA

Daily used parameter settings etc., are explained.

The pages prefixed by "M-" (Page M-1 and after) contain:

#### USE-LEVEL MAINTENANCE

Troubleshootings etc., are explained.

#### PARAMETER SETTING

GP-1250's functions are controlled by many parameters. You may adjust them to your preference.

The pages prefixed by "AP-" (Page AP-1 and after) are intended for service technicians.

### **SUGGESTION TO SERVICE TECHNICIANS**

To understand the technical aspect of the GP-1250, it is recommended to read the following chapters.

To understand the concept of the GPS system and GP-1250:

About GPS.....Page 1 thru 5

To install the GP-1250:

INSTALLATION.....Page AP-1 thru AP-16

PARAMETER SETTING.....Page M-14 thru M-32

To maintain the GP-1250:

USER LEVEL MAINTENANCE .....Page M-0 thru M-13

MAINTENANCE .....Page AP-17 thru AP-20

# IMPORTANT READ THIS FIRST!

Although your GPS Plotter is capable of providing very accurate position data, no single navigational device should ever be solely relied upon. Position information obtained from the GPS Plotter should always be double-checked against other sources such as radar, visual and celestial sightings, sounding measurements, etc. to verify the reliability of the data.

---

## HANDLING PRECAUTIONS FOR THE DISPLAY UNIT

---

1. The display unit is carefully constructed to be able to withstand the humidity and corrosive atmosphere common in a pilothouse, but it is **not** designed to be used outside, directly exposed to the environment! Salt water spray (or even coffee spills) will most assuredly cause damage to the sensitive components inside. Keep these factors in mind when planning the installation of the display unit.

Many owners will undoubtedly use the GP-1250 on small boats, many with center consoles. The Display Unit must be mounted inside an enclosed cabinet, completely shielded from salt water spray, and from fresh water spray if the boat is usually hosed down after a day's outing. Corrosion can occur, especially on the rear connectors exposed to salt spray, unless these are taped and thoroughly sealed with putty compounds made especially for this purpose. Most small center console boats are equipped with such an enclosed cabinet behind the wheel, and most have clear doors so that equipment may be seen behind them.

**FURUNO WILL ASSUME NO RESPONSIBILITY FOR CORROSION DAMAGE CAUSED BY EXPOSURE TO EITHER FRESH OR SALT WATER SPRAY!**

2. Accumulated dust on the exterior surfaces, including the CRT, may be removed with a soft cloth. For stubborn dirt, use a soft cloth and a mild soap. Never use chemical solvents, such as alcohol, benzine, etc. They may remove paint and markings.
3. Before operating the unit, confirm that the copper ground strap (supplied) is properly connected between the GND terminal on the rear panel and the ship's ground bus.
4. The anti-radiation filter attached to the CRT aperture prevents interference to radio equipment. For that reason do not detach it.
5. On a small boat it is rather common that the supply voltage fluctuates largely when turning the engine on. If the GP-1250 is then in the operating condition, it may accidentally malfunction, resulting in destruction of memory contents. To avoid this, start the engine with the GP-1250 turned off.

---

## HANDLING PRECAUTIONS FOR THE OPTIONAL MEMORY CARDS

---

1. The digitized coast lines contained in the ROM card are designated to supplement navigation charts, not replace them. The prudent navigator always checks his position against paper charts.
2. To prevent destruction of the RAM card contents, turn on or off the unit with the card pulled out from the card slit.
3. Keep the card out of direct sunlight.  
  
Do not place it in hot, wet or dusty environment.  
  
Keep it away from electrified material. (Do not put it in a plastic bag, the pocket of a nylon jacket, etc.)  
  
Keep the card-edge connector clean.  
  
Do not strike, bend nor disassemble the card.
4. A lithium battery in the RAM card preserves the memory contents for about 4 years. To ensure important information will not be lost, record on the card label the date of purchase, and change the battery well before the expiration date. (Instructions for replacement of the battery are given on page M-8.)

---

## HOW TO ATTACH THE VIEWING HOOD

---

A viewing hood comes with this unit, and may be attached to the CRT to eliminate extraneous light.

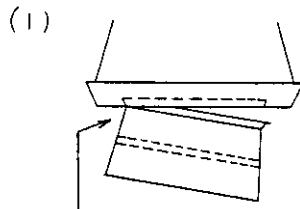

Insert the hood edge into the unit.

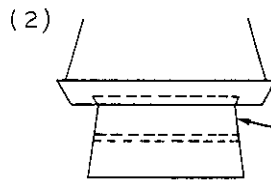

Insert the other edge as well.

A magnifying lens is factory-attached to the viewing hood. If you do not require its function you may remove it.

(1) If the hood is attached, detach it from the display unit.

(2) With the hood body pulled outward, disengage the lens.

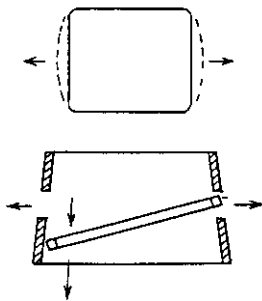



# TABLE OF CONTENTS

\* \* \* \* \*

## About GPS

How GPS works _____	1
Position-fixing Accuracy (HDOP) and BACK-UP NAVAID _____	3
GPS Satellite Arrival Time & ALMANAC _____	5

## BASIC LEVEL OPERATIONS

GPS PLOTTER Tutorial _____	6
Getting Started _____ [PWR], [OFF], [DIM], , [PLOT] ...6	
Interpreting On-screen Indicators.....	10
Magnifying Character Size.....	11
CURSOR/SCREEN Manipulations [ + / , [ , [ , Arrow Keys, [CTR]... 13	
Concurrent, Dual Page Plotting [ , ..... 15	
Sailing to a cursor-pointed location ..... 16	
Entering EVENT MARKS _____ 18	
Selecting a mark shape [SHFT] [ , ..... 18	
Entering an event mark [EVT] ..... 19	
Erasing event marks [MENU] [4]..... 21	
After-sailing Operations _____ 22	
Suspending track line plotting ..... 22	
Erasing a track line [MEMO] [3] [ENT]..... 22	
Erasing event marks..... 22	
More about Plotter Screen _____ 22	
Summary of ON-SCREEN INDICATORS..... 23	
About NAV. STATUS Indication..... 24	

## MENU SCREEN CONVENTIONS

General rules in selecting an item _____	26
--	----

## WAYPOINT NAVIGATION

Entering WAYPOINTS _____	29
by LAT/LON [WPT] .....	30
at PRESENT POSITION [EVT] .....	30
at CURSOR CROSSING [EVT] .....	31

Displaying a WAYPOINT LIST _____	33
Selecting FROM and TO WAYPOINTS [TO]/[TO] [TO] _____	34
Plotter-aided Navigation _____	36
CROSS-TRACK ERROR.....	36
ON-PLOTTER NAV. INDICATORS.....	37
Displaying a NAV DATA SCREEN [MON] _____	40
Exiting the Plotter-aided Navigation [TO] [0] [0] [ENT] _____	41

**ROUTING NAVIGATION**

Entering a ROUTE [WPT] [2] _____	42
Selecting a ROUTE [TO] [TO] [TO] _____	44

**MORE ABOUT GP-1250**

**ALARM FUNCTIONS**

ARRIVAL Alarm [MENU] [5] [1] _____	50
CROSS-TRACK ERROR Alarm [MENU] [5] [2] _____	51
BORDER Alarm [MENU] [5] [3] _____	52

**MEMORY PARTITIONS**

Saving ship's track line [MEMO] [1] _____	54
Overlay [MEMO] [2] _____	55

**RAM CARD (optional)**

Formatting a RAM card [MC] [8] _____	57
Saving/reloading SHIP'S TRACK LINE/EVENT MARKS _____	58
Saving [MC] [2].....	58
Reloading [MC] [4].....	59
Deleting [MC] [6].....	60
Saving/reloading WAYPOINTS _____	61
Saving [MC] [3].....	61
Reloading [MC] [5].....	61
Deleting [MC] [7].....	62

**MISCELLANEA**

Loading a COASTLINE from a ROM CARD manually [MC] [1] \_\_\_\_\_ 63

CORRECTIONS \_\_\_\_\_ 66

LAT/LON Correction [MENU] [6] [1] .....66

MAGNETIC Correction [MENU] [6] [2] .....67

Selecting a PLOTTING INTERVAL [PLOT] [SHFT] [SHFT] [↺] \_\_\_\_ 69

PLOTTER-ONLY MODE [PLOT] [SHFT] [SHFT] [SHFT] [↺] \_\_\_\_ 70

## USER LEVEL MAINTENANCE

Deselecting an UNHEALTHY SATELLITE manually _____	M-1
Running the SELF-TEST Program _____	M-2
ALL MEMORY CLEAR _____	M-4
COLD START (erasing/receiving ALMANAC) _____	M-6
Replacing the LITHIUM BATTERY in a RAM CARD _____	M-8
"MEMORIES: SOME ERROR!" _____	M-10
"INT. GPS NG!" or "INT. GPS BACKUP DATA ERROR!" _____	M-11
Q & A _____	M-12

## PARAMETER SETTING

Entering estimated LAT/LON	[MENU] [1] _____	M-15
Entering DATE/TIME/LOCAL ZONE TIME	[MENU] [2] _____	M-16
Entering PLOTTING INTERVALS	[MENU] [3] _____	M-19
Erasing/displaying WAYPOINT MARK "+ " INTENDED TRACK "-----"	[MENU] [4] _____	M-21
GPS CORRECTIONS _____		M-23
LAT/LON Correction	[MENU] [6] [1] .....	M-23
MAGNETIC Correction	[MENU] [6] [2] .....	M-23
SMOOTHING	[MENU] [6] [3] .....	M-23
ANTENNA HEIGHT	[MENU] [6] [4] .....	M-25
HDOP THRESHOLD	[MENU] [6] [5] .....	M-25
Adjusting COMMUNICATION PORTS (NMEA/CIF) _____		M-27
Turning BACK-UP function on/off	[MENU] [7] [1] .....	M-27
Adjusting PORT1 (EXT NAV)	[MENU] [7] [2] .....	M-29
Adjusting PORT2 (OUTPUT)	[MENU] [7] [3] .....	M-30
Changing TALKER NAME	[MENU] [7] [4] .....	M-32

# APPENDIX (for technicians only)

## INSTALLATION

Mounting the DISPLAY UNIT _____	AP-1
Mounting Location.....	AP-1
Mounting Procedure.....	AP-2
Mounting the ANTENNA UNIT _____	AP-3
Mounting Location.....	AP-3
Mounting Methods .....	AP-5
CABLING _____	AP-6
DC IN .....	AP-6
GND .....	AP-7
ANTenna .....	AP-8
EXT NAV .....	AP-11
OUTPUT .....	AP-11
Modification for RS232C Interface _____	AP-12

## MAINTENANCE

Replacing the MEMORY BACK-UP BATTERY _____	AP-14
Replacing ROM CHIPS _____	AP-16
Maintenance Parts List _____	AP-17

OUTLINE DRAWINGS _____	D-1 to D-3
Connection of external navigator _____	S-1
Connection of autopilot & color sounder _____	S-2
INTERCONNECTION DIAGRAM _____	S-3
SCHEMATIC DIAGRAM _____	S-4

## ABC INDEX

\_\_\_\_\_ X-1 to X-2

# About GPS

---

## How GPS works

---

GPS is an acronym meaning Global Positioning System. The Global Positioning System, also known as NAVSTAR, is a precise satellite navigation system developed by the U.S. Department of Defense.

When full global coverage becomes available, a constellation of 24 satellites (including 3 spares) emplaced in nearly 20,000-kilometer high 12-hour circular orbits will provide highly precise, continuous, worldwide, all-weather position plus time and velocity information to user-equipped land vehicles, marine vessels, and aircraft.

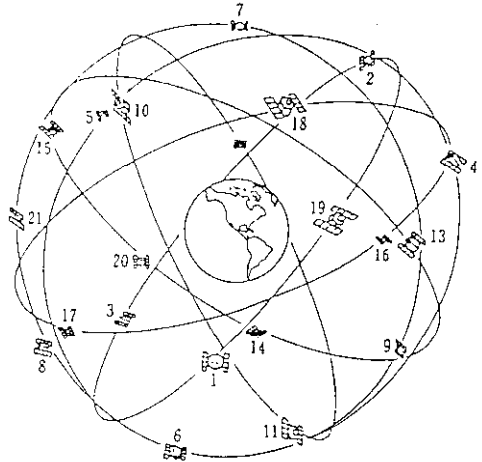

### GPS vs. TRANSIT & LORAN-C

Many people surmise that GPS is similar to TRANSIT since the position is fixed by receiving satellites. However, as detailed in the following table, it is quite different from TRANSIT, but is rather similar to LORAN-C. (It might be called "Loran chains in the sky.")

GPS	TRANSIT(satnav)	LORAN-C
Position is fixed by receiving 3 satellites in line of sight.	Position is fixed by receiving only one satellite.	Position is fixed by receiving 3 stations (= 1 master + 2 slaves).
Position can be fixed continually while 3 satellites are in line of sight.	Position is fixed one time only when a satellite comes in line of sight.	Position can be fixed continually while the ship is in the loran chain coverage.

However, note should be taken that GPS fix is obtainable by receiving any 3 satellites. There is no specific combination requirement unlike LORAN-C where the master and slave combination is fixed.

### How GPS fix is obtained

As mentioned earlier, GPS satellites are not geostationary. They are orbiting the earth as illustrated on the preceding page. Position is repeatedly fixed through the following three steps while any 3 satellites are in line of sight.

- (1) GPS satellites continually transmit their own precise orbital data (called "ephemeris"). The GPS receiver computes their locations by receiving these data.
- (2) In the above-mentioned receiving process, the GPS receiver measures very accurate distances to the satellites, using what is known as "spread spectrum modulation." Excellence in GPS's position-fixing accuracy is mainly due to this technology.
- (3) Satellite locations and their distances are known already. Now the GPS receiver fixes its own position by triangulation:

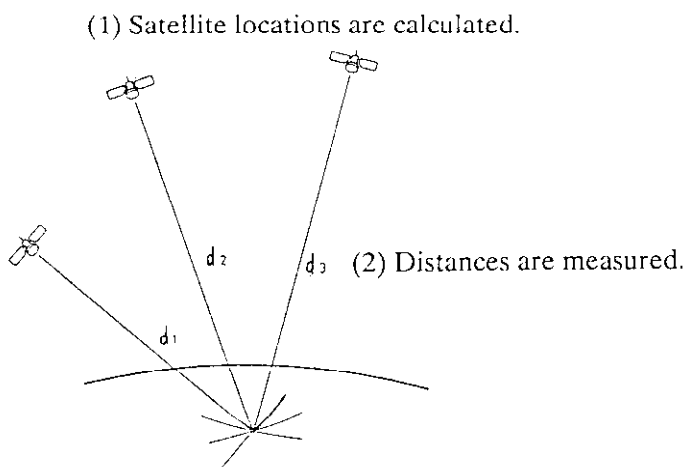

- (3) GPS fix is calculated as the meeting point of three spheres which are drawn around the three satellites with diameters,  $d_1$ ,  $d_2$ , and  $d_3$ .

## Position-fixing Accuracy (HDOP) and Back-up Navaid

As you may have noticed, GPS fix is obtained in the same manner as the position-fixing which is conducted on the radar by using the VRM (variable range marker). The following figures show a radar screen and sea chart. A, B and C are known locations (lighthouse, cape, etc.), and the distances to those targets are measured on the radar screen by using the VRM. The own ship location is fixed as the intersection of three circles which are drawn with the diameters of VRM readouts, centering around A, B and C. (In case of GPS, A, B and C correspond to satellites.)

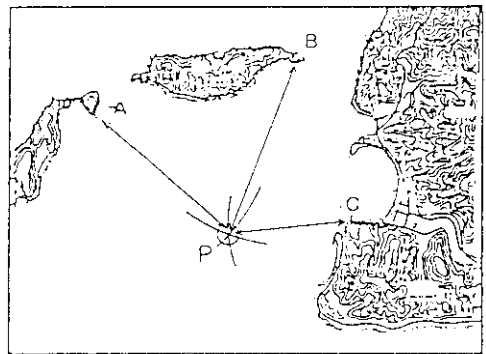
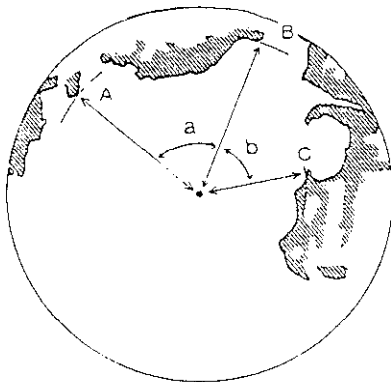

As experienced navigators know, high accuracy can be expected when the targets are spaced nearly 90 degrees approx. from each other.

Similarly, GPS fix accuracy is subject to the locations of 3 satellites in the sky. Roughly speaking, high accuracy is obtainable when the satellites are widely scattered in the sky; on the contrary, accuracy is reduced when the satellites have gathered in a narrow space (angle).

See the figures below. In both cases GPS fix is obtainable in Tokyo since 3 satellites are in line of sight. However, accuracy in the right case will be higher than the left because 3 satellites are located in three different (apart) locations.

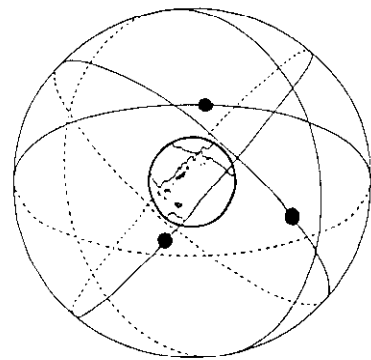
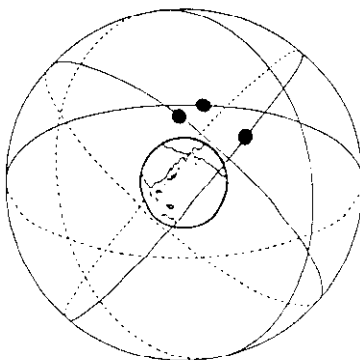



As the index for position-fixing accuracy, HDOP (Horizontal Dilution of Precision) is widely used. The smaller the HDOP value, the more accurately position can be fixed. For instance, HDOP of 3 to 5 are considered desirable, but values above 20 represent poor GPS fix accuracy. While each satellite is revolving in a different direction, the geometrical distribution of 3 satellites e.g. HDOP value changes as time elapses.

Error in distance is proportional to the HDOP value as shown below.

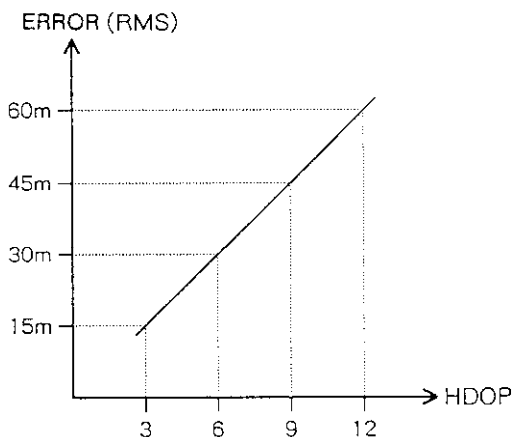

*NOTE 1. The error shown above occurs in the GP-1250 under favorable receiving condition.*

*2. GPS system accuracy is under control of the US Government; the error above is subject to change.*

You may register a HDOP Threshold value in the GP-1250. While the HDOP of existing satellites is lower (better) than the threshold, GPS fix is presented on the GP-1250. When the HDOP becomes worse than the threshold, the external navaid fix is presented. Such an external navaid is called a BACK-UP NAVAIID.

---

## GPS Satellite Arrival Time & Almanac

---

Until the full complement of GPS satellites is launched, it is important to note that limited hours of position-fixing is available. The period and time differ with respect to geographical location on the earth.

The time required for a GPS satellite to revolve round the earth is 11 hours and 58 minutes. This means that the predicted satellite arrival time in a given area will be 4 minutes earlier each succeeding day. (4 min. per day, half an hour per week, 2 hours per month and whole a day per year). For example, supposing that the satellite arrival time was 3:00 to 5:00 PM today, the same satellite will be in line of sight from 2:56 to 4:56 PM tomorrow. The position-fixing periods also advance 4 minutes a day.

Every satellite is broadcasting not only its own orbital data (ephemeris explained on page 2) but also rough orbital data of all the GPS satellites, called the Almanac. Therefore, the GP-1250 can predict arrival times of all the GPS satellites by receiving a single satellite. The GP-1250 acquires/receives GPS satellites in accordance with this prediction. Unless the Almanac is available in the GP-1250, position-fixing is not initiated. As the GP-1250 is shipped from the factory with the Almanac memorized, you may use it immediately after installation. Whenever the GP-1250 receives a satellite, the Almanac is replaced.

# BASIC LEVEL OPERATIONS

## CAUTION

*Engine ignition on small boats sometimes causes a serious supply voltage fluctuation exceeding GP-1250's tolerance. This may result in malfunction of the GP-1250 and destruction of memory contents such as waypoints, various parameters which you had accomplished. For that reason make it a rule to turn off your GP-1250 before you start the engine.*

---

## GPS Plotter Tutorial

---

### Getting Started

Before you get started using your new GP-1250, be sure that the following two important jobs had been completed:

1. INSTALLATION described from page AP-1.
2. PARAMETER SETTING described from page M-14.

In this section, you will learn the following subjects which are most elementary portions in the GPS plotter operations.

1. Turning the POWER on and off.
2. Turning the KEYBOARD BACKLIGHT on and off, and adjusting the SCREEN BRILLIANCE.
3. Displaying and scrolling a PLOTTER SCREEN.  
Displaying and controlling a CROSS CURSOR.  
Sailing to a cursor- pointed location.

Operate your GP-1250 as you read through the procedure starting from the next page.

*NOTE: Keyboard layout is available on page 25'.*

## START

If you have a **ROM CARD** covering your sea area, insert it into the GP-1250. (The unit will automatically search the card for a proper coastline image.)

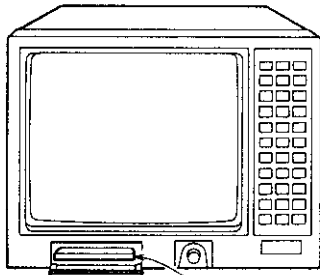

### NOTE

*If a card is not inserted, or if the inserted card does not contain a coastline of your current area, the warning "CHART" appears.*

Flip down the lid, and insert the card into the card slit gently with the label side facing upwards. Release the card when you feel resistance. About one inch of the card should be outside the slit.

To **TURN THE POWER ON**, press the [PWR] key. The unit acknowledges it by releasing a long peep, and the power-on self-test sequence runs automatically. In a few seconds, you will see the **STARTUP STATUS** screen as illustrated below.

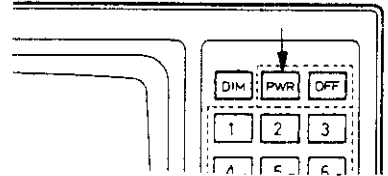

### START UP STATUS SCREEN

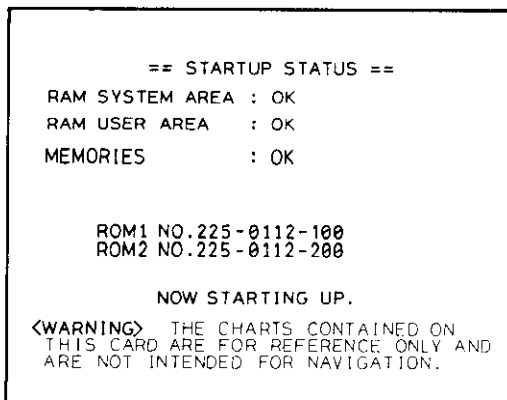

If the GP-1250 finds any error, it continually displays the STARTUP STATUS screen, reporting:

"MEMORIES: SOME ERROR!"

-----> See page M-10.

"INT. GPS NG!" or "INT. GPS BACKUP DATA ERROR!" -----> See page M-11.

If the test results are OK, the STARTUP STATUS screen is followed by the **ALERT** screen in about 10 seconds. Now the screen should look like the one illustrated at the top of the next page.

## GPS POSITION FIXING SCHEDULE

### FROM UNTIL

Mon/Day Time --> Time

```

NAV: [ALERT]
(* FUTURE SATELLITES *)
1. 03/27 ---:-- --> 17:20 HDOP : THRHLD=20
   03/27 23:01 --> 03:34 : NOW =12
   03/28 03:46 --> : NORMAL =12
   : ABNORMAL:
   :
(* SV CONDITION *)
NO. MODE ELV AZM LVL CODE DOPL TIME
06 12 37 038 ---:-- --> 175596
12 46 183 ---:-- --> : NL
   : 107
(* ALMANAC DATE & TIME *)
03/26/90 14:34:24J SV=03
(* OFFSET FREQ. *)
+0 HZ
  
```

HDOP Threshold → Page M-25

HDOP at present moment

Q'ty of Normal Satellites

List of Abnormal Satellites

Your GP-1250 is able to discriminate abnormal satellites and exclude them from reception schedule.

The existing Almanac was received on this date/time.

"SV = xx" means the satellite (Space Vehicle) number from which the GP-1250 received the Almanac.

List of GPS SATELLITES under reception.

In the upper left portion of the ALERT screen, you should see a GPS Position Fixing Schedule (up to 6 periods within 24 hours.) If "—:—" appears as a starting time, it means that your GP-1250 is performing GPS position fixing now.

The middle portion of the ALERT screen offers a List of GPS Satellites which your GP-1250 is receiving now. If "TRK" appears under the MODE column, it means that the GP-1250 is receiving that satellite for position fixing. Don't worry if you don't understand the other columns because they are intended for technicians.

*NOTE 1. You may have noticed that "PF" (Power Failure) warning appears at the lower righthand corner of the screen. If this warning appears at power-on, it does not mean equipment fault. It disappears when you press a key.*

*2. You may display the ALERT screen at any time by pressing the [MON] key. Note that repeated pressings of this key display the NAV and ALERT screens alternately.*

By pressing the [DIM] key, turn the KEYBOARD BACKLIGHT on or off.



## KEYBOARD CONVENTIONS

- 1) When you press a key, the GP-1250 acknowledges it by releasing a peep.
- 2) When the unit detects invalid key operation, it releases two peeps.  
Press a correct key.

Adjust the  **SCREEN BRILLIANCE** control.

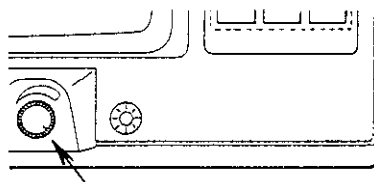

In order to display the **PLOTTER SCREEN**, press the [PLOT] key. You should see a graphic screen with latitude and longitude grids overlaid on it. Across the screen center, a warning should read:

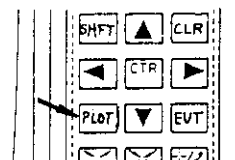

"PLOT OFF NOW! ON = [PLOT] AGAIN."

This means track line plotting is now disabled to prevent false track line plotting. (If the back-up navaid is in a stable condition, false latitude and longitude information may be transferred to your GP-1250, filling the screen with false track lines.)

Date  
Time  
(Page M-16)

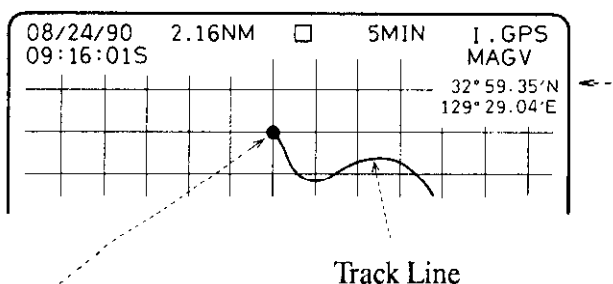

You should see a large dot is blinking every second. It is your SHIP'S MARK, and its latitude and longitude appear here.

If a back-up navaid is available, place it in the fully operating condition.

Be sure that the **PRESENT POSITION** (latitude and longitude) reading is reasonable. If it differs from the actual position by more than 10 degrees, GPS position fixing can not start. Enter estimated latitude and longitude as explained on page M-15.

Now is a good time to start plotting. Press the [PLOT] key again, and you will see the warning message erased and track line plotting started if the boat is sailing and position fixing is being performed.

- - - Interpreting On-screen Indications - - -

The figure on page 23 illustrates all the indications which appear on the plotter screen. Don't worry if you don't understand everything on the screen, or if anything in the figure does not appear on the screen. The meaning of each indication will be explained in the later part of this manual.

This section explains several indications which are most commonly used and yet most important.

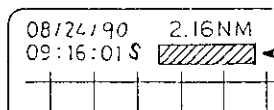

The GP-1250 displays the following NAV STATUS signs in the hatched area to tell you what the GP-1250 is doing.

No Back-up Navaid

- "2-D" .....GPS position fixing with normal grade of accuracy.
- "HDOP" .....GPS position fixing with inferior accuracy.
- Others.....GPS position fixing is not performed. The PRESENT POSITION is frozen.

Back-up Navaid Connected

- "2-D" .....GPS position fixing with normal grade of accuracy.
- "\* GPS - xx" .....The BACK-UP NAVAID is used.

↑  
 These two letters indicate what type navaid is in use:  
 LA = Loran A   LC = Loran C   DR = Satnav   DE = Decca

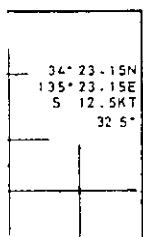

← PRESENT POSITION appears here. From the NAV STATUS indication, you can know where these latitude and longitude information is coming from, the built-in GPS or back-up navaid. If you want a GPS fix with 0.001 minute resolution, see page 40.

← Ship's SPEED and COURSE (moving direction) are read here. If your boat is moored in a harbor, the COURSE reading may fluctuate randomly. This is because the ship's speed is zero and consequently the speed measurement is 100% random noise. The reading should stabilize as the boat speeds up.

-Magnifying Character Size-

This feature is useful when your GP-1250 is installed away from the helm and difficult to read the digital data on the screen. You may magnify the following indications.

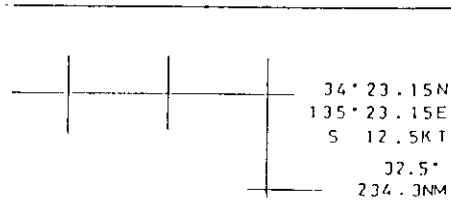

**Keystrokes**

Press the [SHFT] key, and you will see a highlighted rectangle presented on the top center of the screen. (Further pressings of [SHFT] will move the highlighted rectangle from indication to indication.)

Press!

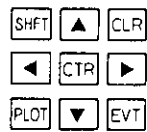

If you want to magnify another item, too;

By pressing [SHFT], move the highlighted rectangle onto the item which you want to magnify, for instance the latitude and longitude readings.....



To magnify the presentation, press [ \* ]. (To return the indication to the normal size, press [ \* ].)

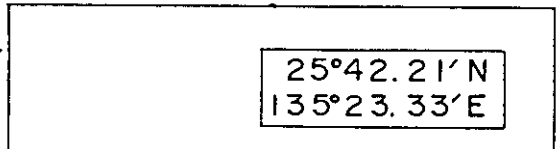

When the job is over, press [CLR].

The highlighted rectangle disappears.

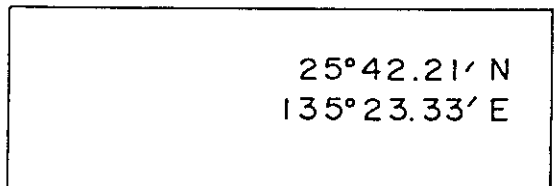



↓  
If you leave your GP-1250 unattended for hours, turn the ☉ SCREEN BRILLIANCE control counterclockwise until a click is felt. Under this condition the GP-1250 operates in ECONOMY (POWER SAVING) mode, i.e., the CRT is turned off completely but the internal electronics continues position-fixing, etc.

If you want to TURN THE ENTIRE SYSTEM OFF, press the [PWR] and [OFF] keys simultaneously. This arrangement prevents the power from being shut down accidentally.

## CURSOR/SCREEN Manipulations

In this section you will control the plotter screen by pressing the keys illustrated right.

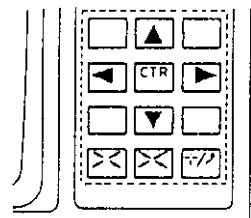

Turn the power on, then display the plotter screen.

### Displaying a Cursor

The cross cursor serves to enter a mark on a desired position, etc. Press the [ +/∩ ] key several times, and you will see a **CROSS CURSOR** (+) appears and disappears alternately. The cursor-pointed latitude and longitude and the bearing/range observed from the present position are read as illustrated below.

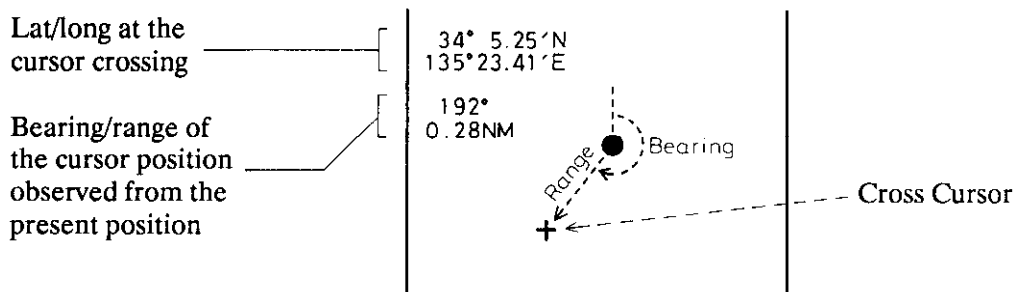

### Changing the Chart Scale

In order to expand or shrink the chart scale, hold down the [ ⌘ ] or [ ⌘ ] key. You should see the chart scale reading count up or down while the key is held down, and the chart is repainted with the new scale when the key is released.

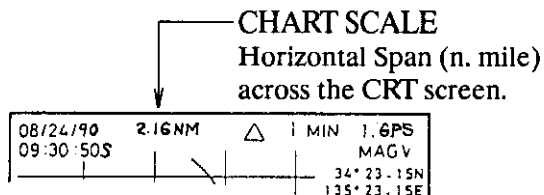

### Controlling the Cursor & Scrolling the Chart

Hold down the arrow keys with and without the cross cursor presented on the screen. If the cursor is presented, the arrow keys move it. If not, they scroll the chart.

The following table summarizes the above-mentioned functions:

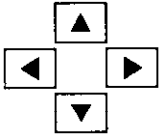
Key	Functions	
	Cursor "+" displayed	Cursor "+" erased
	<p>While the key is held down, the chart scale reading counts up or down. When the key is released, the picture is repainted with the new scaling.</p> <p>The cursor-pointed position (latitude and longitude) is centered.</p>	<p>The own ship position is centered.</p>
	<p>Controls the cursor.</p>	<p>Scrolls the screen.</p> <p>When the screen is scrolled up to its border, the GP-1250 beeps. If you want further scrolling, release the key once, then hold it down again.</p>
[CTR]	<p>Repaints the screen with the cursor-pointed latitude and longitude at the screen center.</p>	<p>Repaints the screen with the own ship position at the screen center.</p>

## Concurrent, Dual Page Plotting

The GP-1250 plots two pictures concurrently; one is the picture which you currently see on the CRT, and the other is the one plotted in the background. Press [↔] several times, and you can see the two pictures displayed alternately. You may magnify/shrink or scroll the two pictures independently.

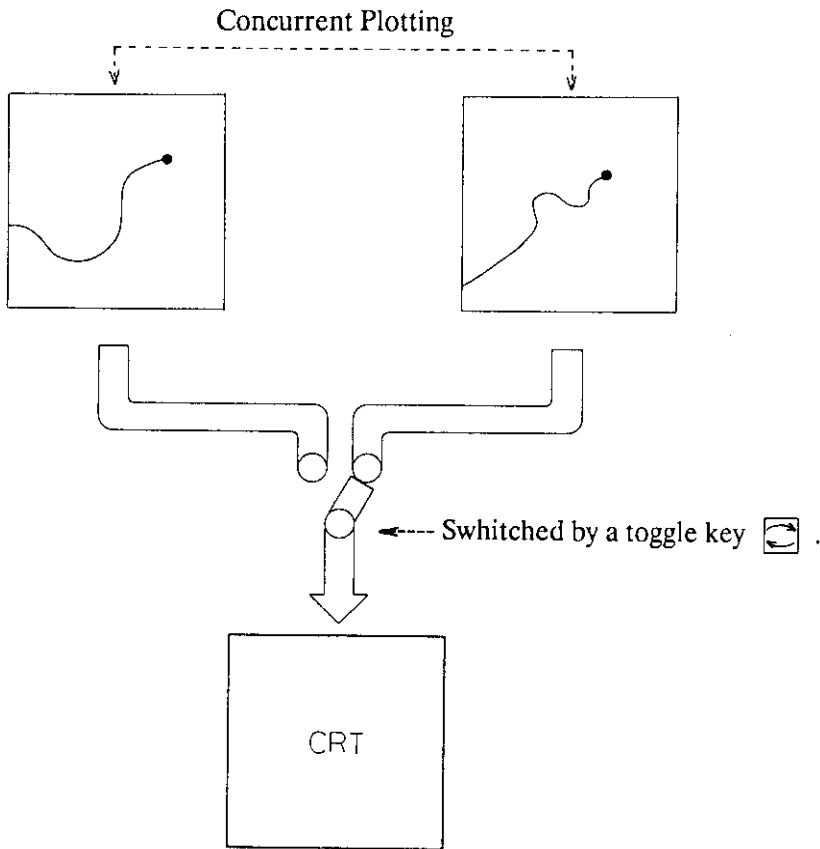

It is a good practice to keep a magnified picture in the background so that you may switch to it instantly when close observation is required.

**Sailing to a cursor-pointed location**

The purpose of a navaid, whether it be a GPS, loran-C or satnav, is to fix own ship's position and to guide you to the destination.

Until this section you mainly learned the former function. In this section you will experience the latter.

**PROCEDURE**

First, display the cross cursor, then move it to the latitude/longitude coordinate of your destination. It should be noted that the cursor moves fast (many miles) with the chart shrunk. Therefore, in order to save time, move the cursor to your intended point roughly with the chart shrunk, then pinpoint it with the chart expanded. Latitude and longitude at the cursor crossing appear as illustrated below.

Latitude and longitude at cursor crossing

Bearing/distance to the cursor crossing

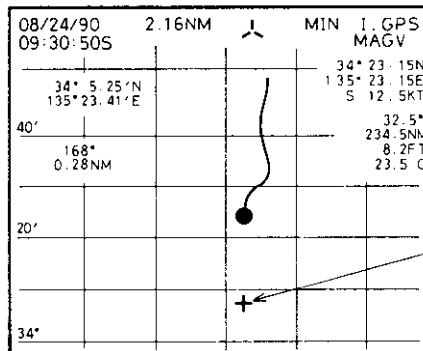

Cross Cursor

**NOTE**

*A true bearing appears regardless of the magnetic variation setting on page 67. Be careful if you are using a magnetic compass.*

In order to sail to the cursor-pointed location, steer the helm as follows:

- If the compass reading is **SMALLER** than the bearing of the cross cursor, steer **RIGHT**.

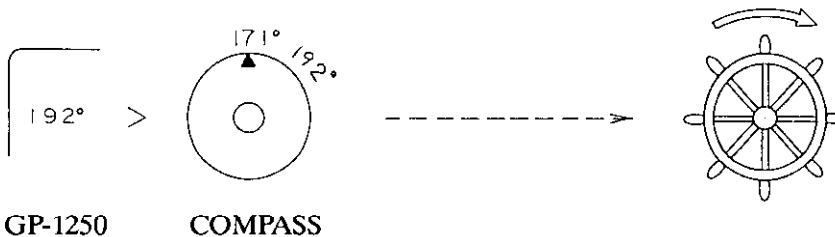

- If the compass reading is **GREATER** than the bearing of the cross cursor, steer **LEFT**.

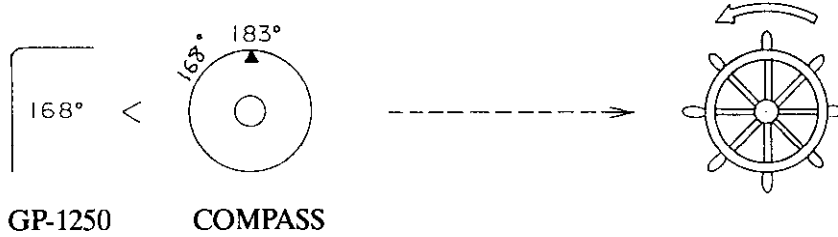

If you keep steering the helm in the above manner, you will reach the destination in the shortest path.

This method is used for short range sailing only because of its simplicity. You will learn a more sophisticated method in the **WAYPOINT NAVIGATION** chapter.

## Entering EVENT MARKS

When you meet your partner boat in the mid sea, you would like to put a mark at the present position on the plotter screen. This kind of mark is called an EVENT MARK. You may enter an event mark by simply pressing the [EVT] key with the cross-cursor erased. If you press the [EVT] key with the cross-cursor presented, an event mark is entered on the cursor crossing. Also, you may enter an event mark by specifying latitude and longitude. You may enter up to 508 points of event positions.

An event mark is merely a landmark. You can not read its exact latitude/longitude later, nor can select it as a destination. For such a purpose, another function called WAYPOINT is available.

*NOTE: If you want to know the latitude and longitude of an event mark, superimpose the cross cursor on the center of the event mark and read the cursor latitude/longitude indication. For better pointing accuracy, magnify the plotter screen as much as possible.*

### Selecting a mark shape

Three shapes are available;  $\triangle$ ,  $\diamond$ , or  $\square$ . Before you enter event marks, select a shape as follows. It is a good idea to assign " $\triangle$ " to lighthouses, " $\diamond$ " to shoals, " $\square$ " to events on a voyage for example. The mark shape in use is displayed at the center top of the screen.

#### Procedure

[PLOT] .....→ Display the plotter screen.

[SHFT] .....→ The mark in use is highlighted.

[↺] --- [↻] → Call up a desired mark.

[CLR].....→ The highlighted rectangle disappears.

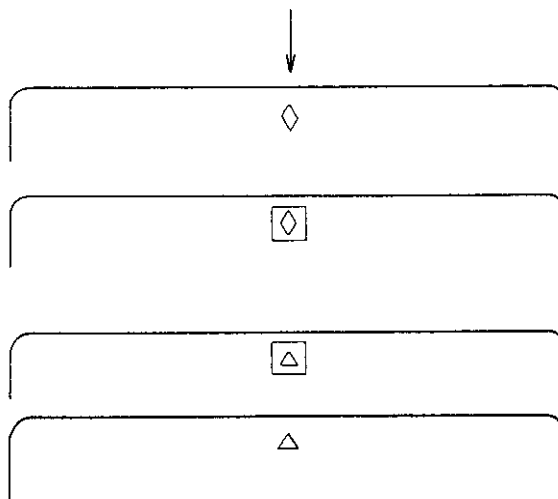

## Entering an event mark

### at the PRESENT POSITION

[PLOT] .....Display the plotter screen.

[+ / ] ..... Erase the cross cursor if presented.

[EVT] .....The unit prompts you as illustrated below:

```
<QUIT=[EVT]> WPT NO.: █ ?
([ENT]=MARK, [SHFT]=LL->MARK)
```

[ENT] .....You will see an event mark entered on the present ship's position with the pre-selected shape.

### at the CURSOR CROSSING

[PLOT] .....Display the plotter screen.

[+ / ] .....Display the cross cursor.

Move the cursor to a desired position by pressing the arrow keys.

If you want to enter more

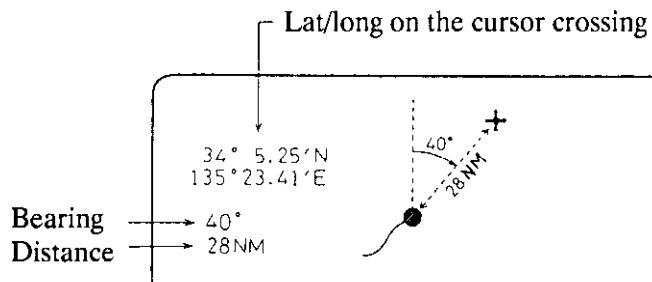

[EVT] .....The unit prompts you:

```
<QUIT=[EVT]> WPT NO.: █ ?
([ENT]=MARK, [SHFT]=LL->MARK)
```

[ENT] .....You will see an event mark entered at the cursor crossing.





## **Erasing event marks**

### Erasing individually

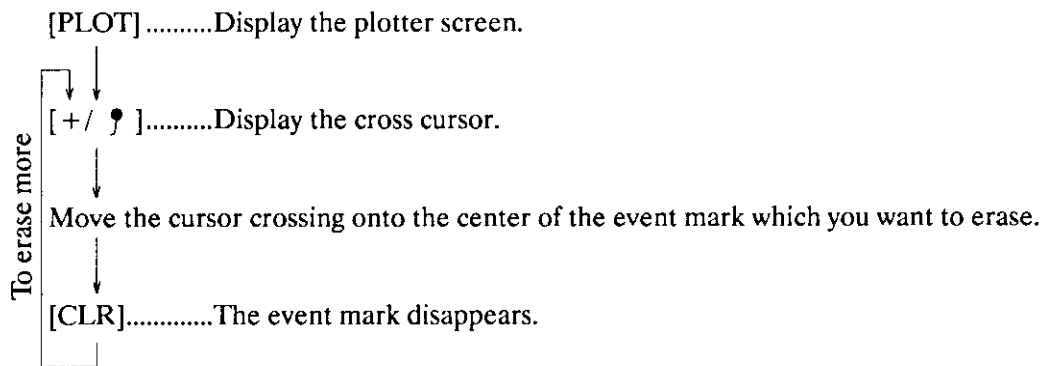

### Erasing all at a time

Press [MENU], [4] and [ENT] in that order.

## After-sailing Operations

### Suspending track line plotting

When your boat is stopped, a track line should not be plotted theoretically. However, you will see it done randomly within a narrow area on the screen. This is because of position fixing error, and can not be prevented. If you want to disable plotting function, use the following keystrokes.

[PLOT] ..... Display the plotter screen.



[SHFT][SHFT].... Press the key twice, and you will see the plotting interval highlighted:



[↻] ..... By tapping this key, call up "HALT."



[CLR]..... The highlighted rectangle disappears.

To restart plotting, call up the previously used plotting interval rather than "HALT." Two plotting intervals are available. For further information see pages 69 and M-19.

### Erasing a track line

When the plotter screen is filled with track lines, you may clear them by pressing [MEMO], [3], and [ENT] in that order.

### Erasing event marks

See the preceding page.

**Summary of On-screen Indicators**

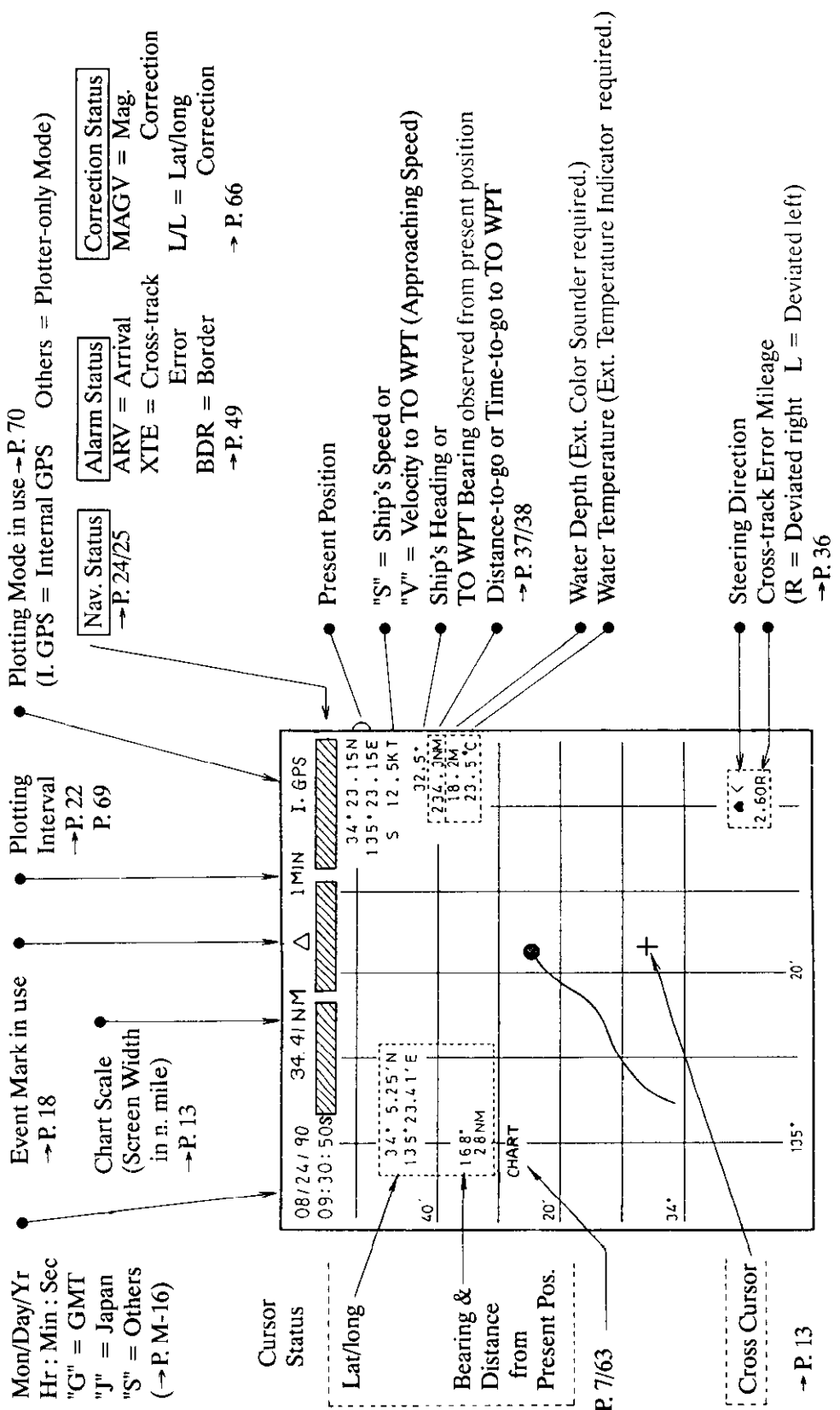

**About NAV. STATUS Indication**

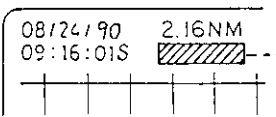

You can know from the NAV. STATUS Indication what your GP-1250 is doing.

**No Back-up Navaid**

Ind.	Status
C-ST	<p>COLD START (This is an exceptional start-up condition.)</p> <p>The GP-1250 was turned on without Almanac inside. The GP-1250 immediately starts acquiring a satellite in order to receive Almanac. If you know what satellite is available in line-of-sight, conduct the COLD START operation described on page M-6.</p>
IMP	<p>IMPOSSIBLE to receive.</p> <p>According to the Almanac, a satellite is not available in line-of-sight.</p>
ACQ	<p>ACQUIRING a satellite.</p> <p>According to the Almanac, a satellite is available in line-of-sight, and the GP-1250 is acquiring it, but has not received it yet. If the ACQ state lasts a long time without changing to ALM or 2-D below, suspect that satellite signal is not received normally.</p>
ALM	<p>Receiving ALMANAC.</p> <p>According to the Almanac in the GP-1250, 3 satellites are not yet available in line-of-sight. Since position-fixing can not be done, the GP-1250 is receiving Almanac.</p>
HDOP	<p>GPS Position Fixing</p> <p>According to the Almanac, 3 or more satellites are available. The GP-1250 is performing GPS position fixing, but the HDOP is inferior to the preset HDOP threshold.</p>
2-D	<p>GPS Position Fixing (2-D: 2-dimensional)</p> <p>The HDOP is superior to the HDOP threshold.</p>
INT	<p>Position-fixing INTERRUPTed.</p> <p>Reception is interrupted due to objects around the GPS antenna, etc. According to the Almanac, HDOP is still superior to the HDOP threshold. When the lost satellite reappears, 2-D position-fixing will be resumed.</p>

## Back-up Navaid Connected

Indication	Navaid in use
2-D	Position-fixing by GPS. (2-D: 2-dimensional) The HDOP is superior to the preset threshold.
*GPS-DR	Back-up by external SATNAV (TRANSIT)
*GPS-LC	Back-up by external LORAN-C
*GPS-LA	Back-up by external LORAN-A
*GPS-OM	Back-up by external OMEGA
*GPS-DC	Back-up by external DECCA
RCV-ERR	No data coming from the back-up navaid.
NAV-ERR	Data are coming from the back-up navaid, but information necessary for back-up is not contained.
SIG-ERR	Necessary data are coming from the back-up navaid, but with the error signal asserted.

----- If GPS POSITION CORRECTION [page M-28] is performed, \* is not attached.

Ex. "GPS-LC"

# GP-1250 Keyboard Layout

BASIC

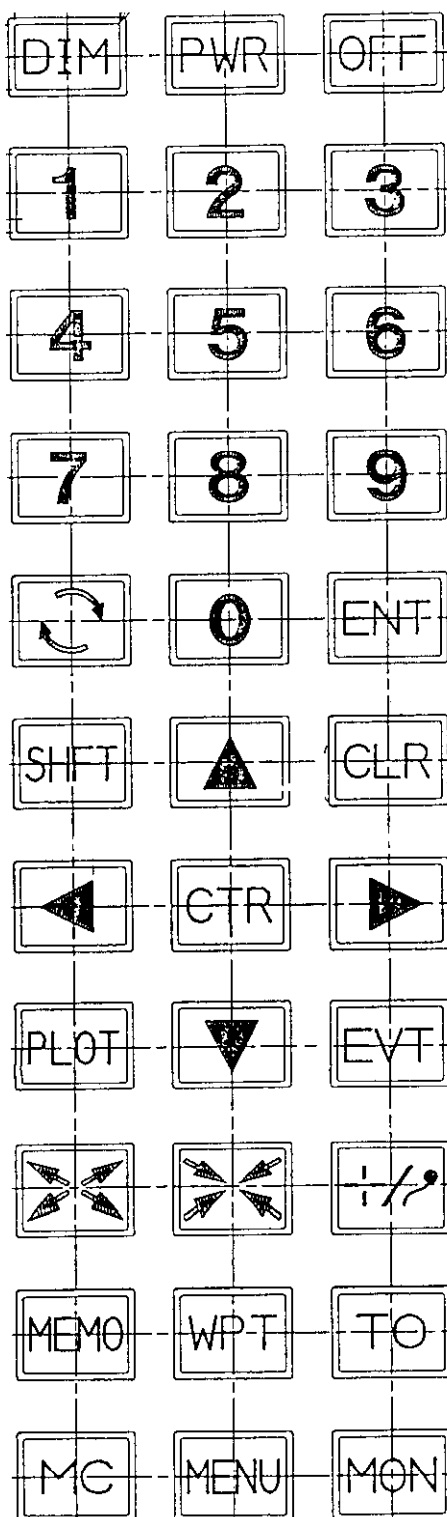

# MENU SCREEN CONVENTIONS

Until this chapter you mainly did operations on the plotter screen. In the succeeding chapters, you will select an item on a text mode screen called a MENU. In this section you will learn general rules to select an item on the menu screen.

The MENU screen contains items which normally do not require frequent adjustment in daily use.

---

## General rules in selecting an item

---

Press the [MENU] key, and you will see the "INITIALIZATION" screen appear.

```
(* INITIALIZATION *)
[1] INITIAL LAT & LONG SETTING
    LAT : 38° 30.00' N
    LON : 123° 30.00' W
[2] DATE, TIME & LOCAL ZONE TIME
[3] PLOT INTERVAL PRESET
[4] DISPLAY WPT MARKS, COURSE
    WPT MRKS : 'ON'
    COURSE   : 'ON'
[5] ALARM SETTING
[6] GPS CORRECTIONS
[7] INTERFACE PORT, BACKUP NAVIGATION
[8] COLD START
[9] SELF TEST, CLEAR DATA, BATTERY

== CHOOSE MENU ==
```

You have nine choices numbered [1] thru [9], and the GP-1250 is prompting you to select one. This is a MENU screen.

To select an item on the menu, you have two methods.

### Method 1

Press the numeric key corresponding to the intended item. If you want to select "[9] SELF TEST -----" for example, press [9]. The GP-1250 instantly responds to display the screen which is specific to the selected item.



## Method 2

Press the down arrow key several times until the intended item is highlighted.

```
(* INITIALIZATION *)
[0] INITIAL LAT & LON SETTING
    LAT : 38° 30.00'N
    LON : 123° 30.00'W
[2] DATE, TIME & LOCAL ZONE TIME
[3] PLOT INTERVAL PRESET
[4] DISPLAY WPT MARKS, COURSE
    WPT MRKS : ON
    COURSE : ON
[5] ALARM SETTING
[6] GPS CORRECTIONS
[7] INTERFACE PORT, BACKUP NAVIGATION
[8] COLD START
[9] SELF TEST, CLEAR DATA, BATTERY

== CHOOSE MENU == ?
```



Then press [ENT], and the screen specific to the selected item appears.

In this sample operation select "[9] SELF TEST -----", and the following screen should appear.

```
(* SELF TEST, CLEAR DATA, BATTERY *)
[1] SELF TEST
[2] CLEAR DATA
[3] EXCHANGE BATTERY <RAM CARD>
[4] FACTORY TEST MODE

== CHOOSE MENU == ?
```

Continue selection of item until you reach the screen in which you can enter data.

If you want to quit from a text screen without entering data, simply press [PLOT].

*NOTE: When you select an item on a menu, you may use both down and up arrow keys. Each time you press the up arrow key, the highlighted rectangle goes upwards. When it reaches the top item, press the up arrow key again. You will see the highlighted rectangle erased, and the following message appears on the bottom line.*

```
< IF HIT      , RETURN TO UPPER MENU >
```

*This means that the current screen is a sub-menu of another main menu screen and that another press of the up arrow key will recall the main menu screen. This feature reduces keystrokes when you want to go back to the previously displayed text screen.*

# WAYPOINT NAVIGATION

In navigational terminology, a particular location is known as a WAYPOINT whether it be a harbor, fishing ground, etc. You may enter in the GP-1250 up to 99 locations as waypoints.

Later you may select one waypoint as a destination, and your GP-1250 calculates the shortest path and tells you how you should steer the helm to follow the path.

WAYPOINT

---

## Entering WAYPOINTS

---

Enter your future destinations as many as you like. In this section, you will learn to enter waypoints in the following three methods:

### 1. by LATITUDE and LONGITUDE

This method is useful to enter locations (harbor, etc.) of which the latitude and longitude you read from the sea chart. Also, this method is usable when you enter a good fishing ground of which the latitude and longitude came from your partner boat.

### 2. at PRESENT POSITION

When a wreckage, which is usually a good fishing point, is recorded on your echo sounder, you would like to enter the present position as a waypoint. You may do it easily by this method.

Also, you may use this method when your boat is in a harbor and you want to enter its position as a waypoint.

### 3. at CURSOR CROSSING

You move the cross cursor to a desired point on the plotter screen, and enter the cursor-pointed location as a waypoint.

Each time you enter a waypoint, you should record its latitude and longitude in a log. This will prevent complete loss of information should something happen to the memories.

**by LATITUDE and LONGITUDE**

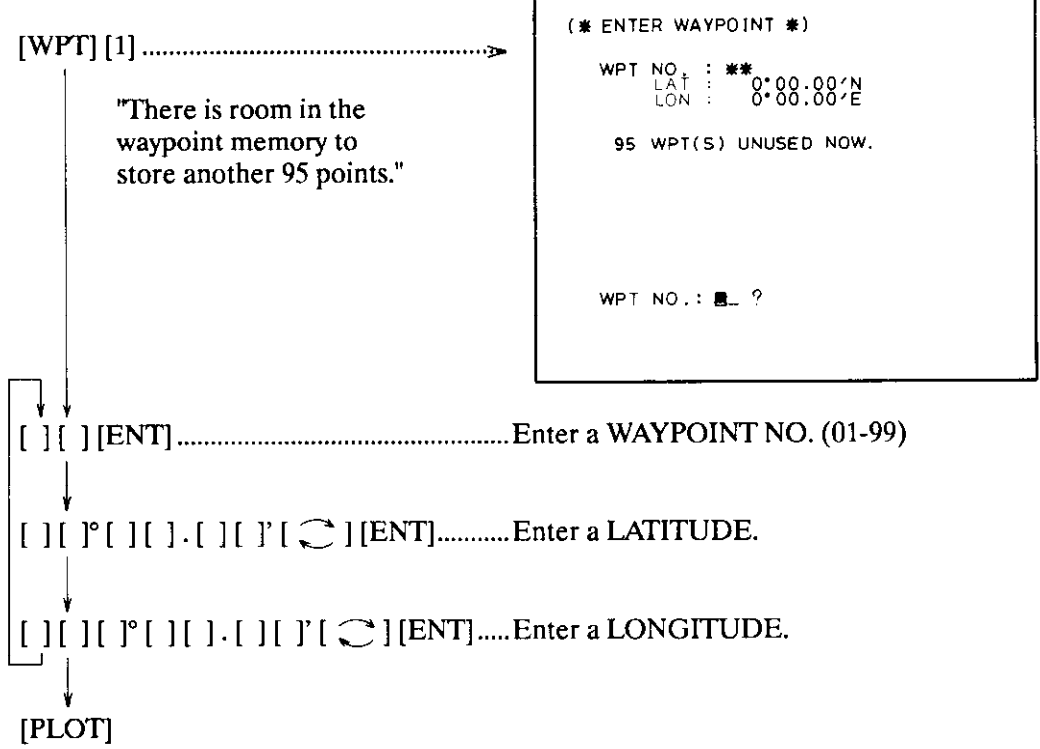

**at PRESENT POSITION**

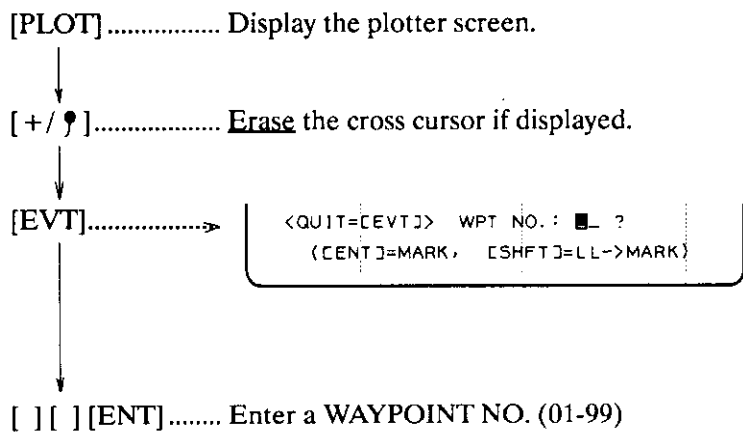

## at CURSOR CROSSING

[PLOT]..... Display the plotter screen.



[ + / ⌂ ]..... Display the cross cursor.



By pressing the arrow keys, move the cursor to the latitude/longitude coordinate where you want to enter a waypoint.



[EVT].....

```
<QUIT=[EVT]> WPT NO.: ■ _ ?
(CENT)=MARK, (SHFT)=LL->MARK
```



[ ] [ ] [ENT]..... Enter a WAYPOINT NO. (01-99)

WAYPOINT

## Waypoint Mark "+"

When a waypoint is entered, a small cross "+" appears at its latitude and longitude coordinate on the plotter screen.

*NOTE: If you wish, you may suppress the "+" display:*

[MENU] [4] [1] .....



[2] [ENT]



[PLOT]

```
(* DISPLAY WPT MARKS ON/OFF *)
```

```
NOW : 'ON'
```

```
TURN ON/OFF ?
```

```
1: ON
```

```
2: OFF
```

```
CHOOSE : # ■ ?
```

To display it again, use the same keystrokes but enter [1] rather than [2].

### Modifying a waypoint latitude and longitude

Re-enter (overwrite) it.

### Deleting a waypoint

Waypoints can not be deleted; the only alternative is the ALL MEMORY CLEAR described on page M-4. If you want to erase the "+" mark of a superfluous waypoint, overwrite the waypoint with zero latitude and longitude.



# Selecting FROM and TO WAYPOINTS

Suppose that many waypoints are available in your GP-1250. In this section you will select one waypoint as a destination. We call the starting point and the destination waypoint the FROM WAYPOINT and TO WAYPOINT respectively.

## Keystrokes

[TO] .....>

The waypoint list appears.  
To view the rest of the list,  
press the [↺] key.

```
(* SELECT NAVIGATION *)
NOW : NAV OFF
(1)
00 05 ** ** ** ** ** ** ** ** ** ** ** ** ** ** ** ** **
10 ** ** ** ** ** ** ** ** ** ** ** ** ** ** ** ** **
20 ** ** ** ** ** ** ** ** ** ** ** ** ** ** ** ** **
30 ** ** ** ** ** ** ** ** ** ** ** ** ** ** ** ** **
40 ** ** ** ** ** ** ** ** ** ** ** ** ** ** ** **

WPT00:PRESENT POSIT. [↺]:CHANGE PAGE.
PRESENT POSIT.          TO WPT
NO : 00                 NO : **
LAT : 34*44.47'N ==>  LAT : * ** ** . ** ** / **
LON : 135*21.29'E     LON : * ** ** . ** ** / **

TO WPT NO. : ■ _ ?

◀: FROM==>TO  ROUTE  WPT00==>TO ▶
```

[ ] [ ] [ENT] ..... Enter a WAYPOINT NUMBER (TO WPT), and a second later the plotter screen appears automatically.

Note that the ship's position at this moment is entered in WPT No. 00, and the WPT No. 00 is selected as a FROM WAYPOINT implicitly.

If you wish, you may specify a FROM WAYPOINT explicitly:

[TO] [TO] ..... Press the key twice. ....>

[ ] [ ] [ENT] ..... Enter a FROM WAYPOINT number.

[ ] [ ] [ENT] ..... Enter a TO WAYPOINT number.

```
(* SELECT NAVIGATION *)
NOW : NAV OFF
(1)
00 05 ** ** ** ** ** ** ** ** ** ** ** ** ** ** ** ** **
10 ** ** ** ** ** ** ** ** ** ** ** ** ** ** ** ** **
20 ** ** **~** ** ** ** ** ** ** ** ** ** **
30 ** ** **~** ** **~** ** **~**
40 ** ** **~** ** **~** ** **~**

WPT00:PRESENT POSIT. [↺]:CHANGE PAGE.
FROM WPT          TO WPT
NO : **          NO : **
LAT : * ** ** . ** ** / ** ==>  LAT : * ** ** . ** ** / **
LON : * ** ** . ** ** / **     LON : * ** ** . ** ** / **

FROM WPT NO. : ■ _ ?

◀: FROM==>TO  ROUTE  WPT00==>TO ▶
```





A second later the plotter screen appears automatically. You will see a cross-track error displayed at the lower right corner if the ship's position is off the intended track line.

WAYPOINT

# Plotter-aided Navigation

When the FROM and TO WAYPOINTS are selected, the plotter screen appears automatically. Confirm that FROM and TO WAYPOINTS are selected properly. Don't worry if the TO WAYPOINT is not displayed. This is because the waypoint is out of the scope of your screen.

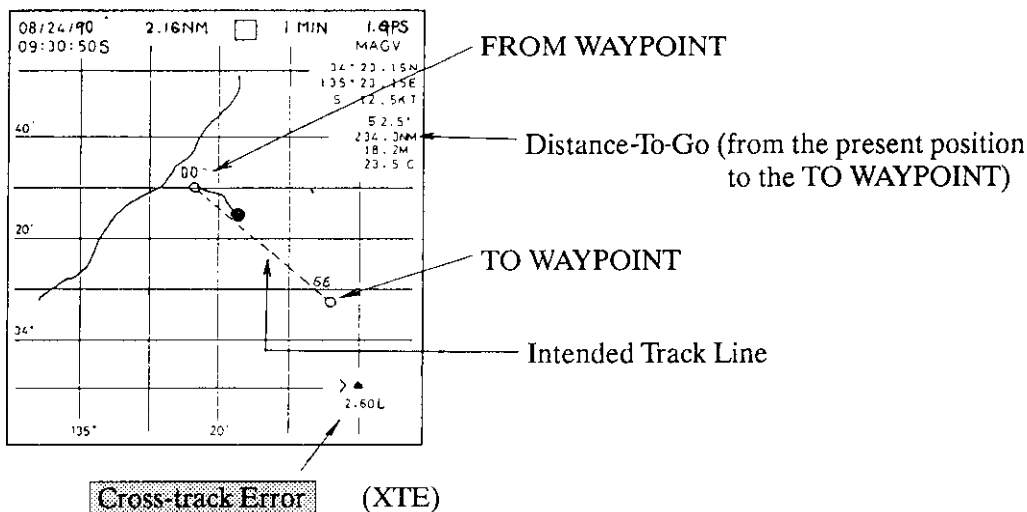

On a voyage between a FROM WPT and a TO WPT, a straight line drawn between the two points is known as a **TRACK**. It could just as well be termed the **INTENDED TRACK** because although it is the use's intention to follow this course faithfully, in reality, he never can do so perfectly due to wind, current, etc.

The amount which the boat is thrown off the intended track is termed the **CROSS-TRACK ERROR**, and appears on the screen along with the wheel-steering instruction:

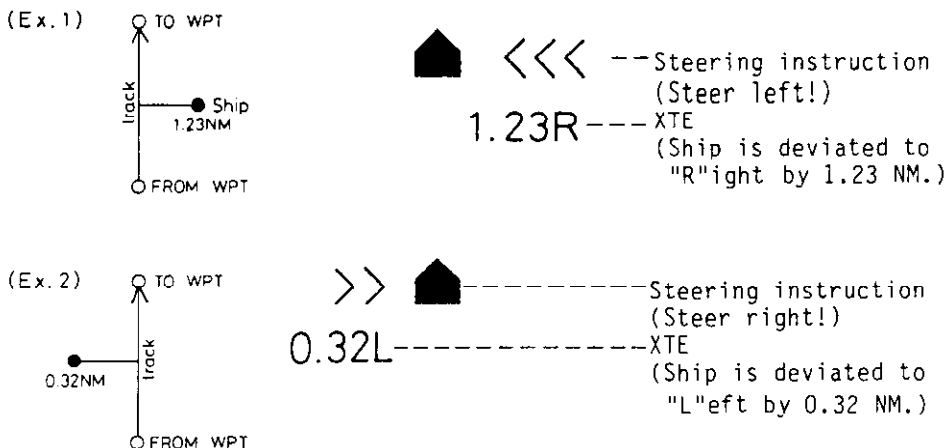

As explained on page 51, you may set a safety-lane on both sides of the intended track. The GP-1250 increases the number of the arrows in proportion to the cross-track error amount. One mark equals one third of the lateral lane width.

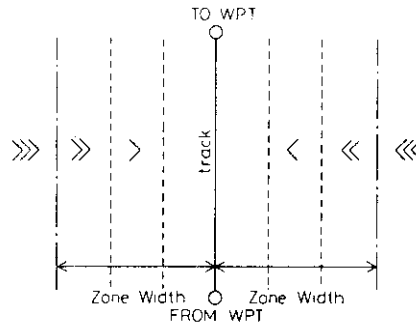

When the ship goes outside the safety-lane, three marks appear and an alarm is released. (The Morse-coded audible alarms are ".\_\_\_." (R) for STEER RIGHT and ".\_\_\_." (L) for STEER LEFT. Be careful not to confuse them.)

WAYPOINT

### ON-PLOTTER NAV. INDICATORS

You learned earlier that you can change the size of the on-screen indicators. By using similar keystrokes, you may select data to display. You have the following choices.

△	1 MIN	1. GPS	
		MAGV	
	34° 23.15N		
	135° 23.15E		
	S 12.5KT		
	32.5°		
	234.5NM		
	8.2FT		
	23.5°C		

**SPEED** or VTD (Velocity-To TO WAYPOINT)

**Ship's COURSE** or BEARING of TO WAYPOINT

**RANGE** or TTG (Time-To-Go) to TO WAYPOINT

---(These are factory-selected)

### Interpreting the indicators

The **COURSE** is ship's moving direction measured by receiving the GPS signal. It differs from the compass reading which is merely a ship's bow direction. Notice that the ship does not always go in the bow direction. She sometimes goes in a squint direction due to waves, wind, sea stream, unbalanced loading condition, etc.

*NOTE: In the absence of the GPS fix, the indicator shows the course information sent from the back-up navaid.*

The **SPEED** is a ground-tracking speed in the **COURSE** direction. This is also measured from the **GPS** signal directly. Note that the value may differ from the speed log reading because the log merely displays a water-tracking speed in the ship's fore-aft direction.

*NOTE: In the absence of the **GPS** fix, the indicator displays the speed information sent from the back-up navaid.*

When the **COURSE** (ship's moving direction) is deviated from the **TO WAYPOINT** direction, ship's **SPEED** can be broken into the following two components:

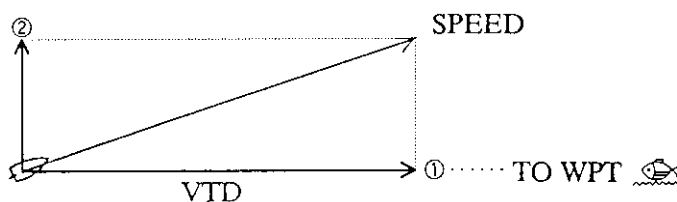

The speed component in the **TO WPT** direction, ①, is called a **Velocity-To-Destination** or **VTD**. Component ②, which makes a right angle with ①, increases the cross-track error.

The **BEARING** is the direction of the **TO WAYPOINT** observed from your boat. If the **COURSE** agrees with the **BEARING**, it means that your boat is sailing towards the **TO WAYPOINT**.

The **RANGE** is the **Distance-To-Go**, i.e. the mileage between your boat and the **TO WAYPOINT**.

The **Time-To-Go** or **TTG** indicates how many hours it takes until your boat reaches the **TO WAYPOINT**. The **GP-1250** calculates this value based on the assumption that present **COURSE** and **SPEED** are maintained. If they change, the **TTG** also changes.

How to select indicators

[PLOT] Display the plotter screen.

By pressing [SHFT], move the highlighted rectangle on to the item which you want to change, for instance SPEED.

<input type="checkbox"/>	1 MIN	1.GPS
		MAGV
	34° 23.15N	
	135° 23.15E	
	S 12.5KT	
	32.5°	
	234.5NM	
	8.2FT	
	23.5°C	

To change the item, press [↻].

<input type="checkbox"/>	1 MIN	1.GPS
		MAGV
	34° 23.15N	
	135° 23.15E	
	V 10.5KT	
	32.5°	
	234.5NM	
	8.2FT	
	23.5°C	

When the job is over, press [CLR]. The highlighted rectangle disappears.

WAYPOINT

## Displaying the NAV DATA SCREEN

The NAV. DATA screen offers complete navigational information on one screen. At every press of the [MON] key, the "NAV" and "ALERT" on the top line are highlighted alternately. Highlight "NAV", and the screen should look like the one illustrated below.

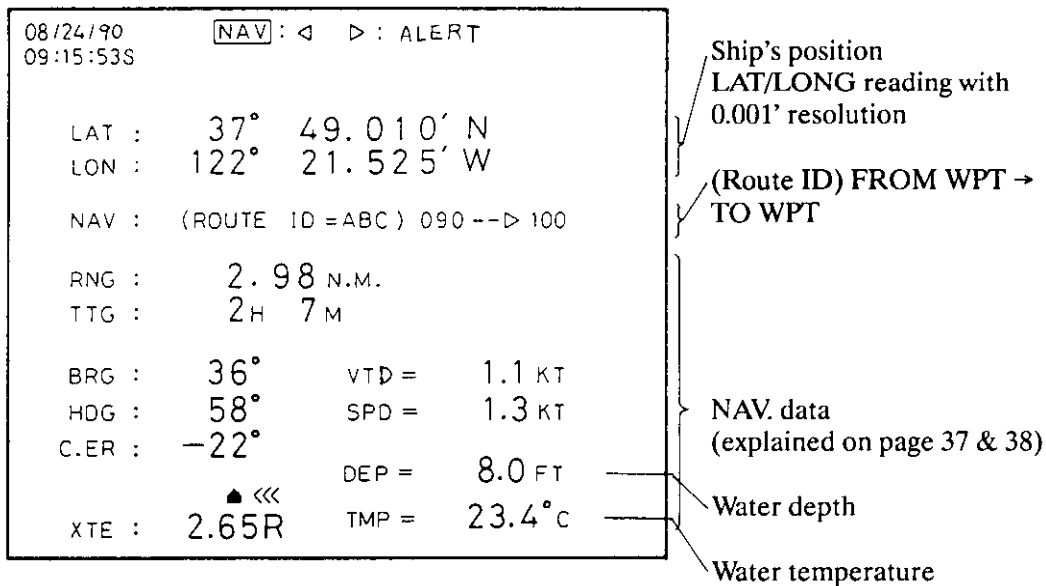

You may enter an event mark on the ship's present position by hitting [EVT].

---

## Exiting the Plotter-aided Navigation

---

When a trip is over, you may deselect FROM and TO WAYPOINTS.

Press [TO], [0], [0], and [ENT] in that order, and wait until the plotter screen appears automatically. You should see the FROM/TO WAYPOINTS, the INTENDED TRACK LINE, and the related indications erased from the screen.

WAYPOINT

# ROUTING NAVIGATION

In the preceding chapter you learned how to sail to a destination, but it does not involve course changes. In many cases, a trip to a destination requires several course changes, calling at harbors, avoiding islands, etc. Your GP-1250 supports this type of navigation. You will practice the following operations in this chapter.

1. Entering the course-changing points and the final destination as waypoints.

We call sequence of waypoints leading to the final destination a ROUTE.

2. Registering a route by entering a route ID number and a series of waypoint numbers leading to the final destination.

You may enter up to ten routes in your GP-1250.

3. Selecting a route between the ten.
4. Plotter-aided navigation.

---

## Entering a ROUTE

---

First, enter course changing points and the final destination as waypoints. See the "Entering WAYPOINT" section on page 29.

Next, enter a route as follows.

[WPT] [2] .....

You can see a list of route numbers which had been entered in your GP-1250.

(\* ENTER ROUTE \*)

ROUTE NO. 10  
NO. 09  
NO. 08  
NO. \*\*  
NO. \*\*  
NO. \*\*  
NO. \*\*  
NO. \*\*  
NO. \*\*  
NO. \*\*

PLEASE SPECIFY ROUTE NO. (01-10).

ROUTE NO. : █ ?



[ ] [ ] [ENT].....>

Enter a new ROUTE ID (01-10).

```

(* ENTER ROUTE *)
ROUTE NO: 07      WPT LIST [↻]
WPT ( 1) : **      ( 1) 00 **
      ( 2) : **      10 **
      ( 3) : **      20 **
      ( 4) : **      30 **
      ( 5) : **      40 **
      ( 6) : **      05 **
      ( 7) : **      **
      ( 8) : **      **
      ( 9) : **      **
      (10) : **      **

YOU MAY ENTER 10 WPTS FOR A ROUTE.
[SHFT]+[ENT] : PAUSE A WPT.
[SHFT]+[SHFT]+[ENT] : REMOVE A WPT.

WPT ( 1): █- ?
( NEW ROUTE )

```

On the right half portion of the screen waypoint list is displayed. Press the [↻] key to display the rest of the list.

[ ] [ ] [ENT]..... Enter waypoint numbers serially from the first course changing point to the destination, and you will see them entered on the upper left portion of the screen.

[PLOT]

ROUTE

How to modify a route

Reenter (overwrite) the route.

How to delete a route

Routes can not be deleted; the only alternative is the ALL MEMORY CLEAR described on page M-4.

How to delete a waypoint from a route

See page 46.

# Selecting a ROUTE

Tell the GP-1250 the route number which you want to travel.

## Keystrokes

[TO] [TO] [TO]..... Press the key three times.

The route list appears.

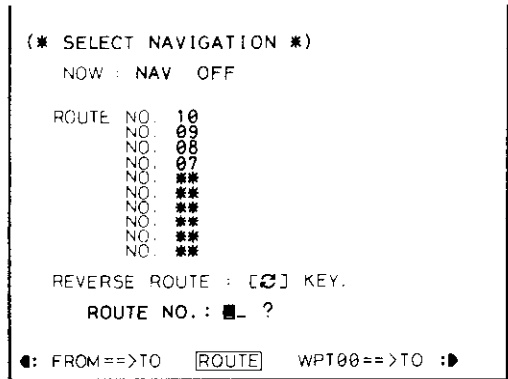

[ ] [ ] [ENT]..... Enter a ROUTE No. which you want to travel.

A second later the plotter screen appears automatically. Note that the ship's position at this moment is entered as WPT No. 00, and is selected as the FROM WAYPOINT. The TO WAYPOINT is the first waypoint on the selected route. Don't worry, your GP-1250 does all these things by itself.

Suppose that you travel the route illustrated below. The FROM and TO WAYPOINTS are initially WPT No. 00 and WPT No. 10, respectively. To go to the TO WAYPOINT, you do it by using the Plotter-aided Navigation explained on page 36.

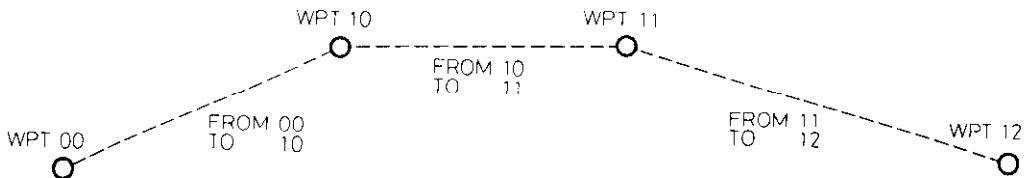

When you reach the TO WAYPOINT (= WPT No. 10), the GP-1250 automatically switches the TO and FROM WAYPOINTS in order to travel the next line segment. The following figure illustrates the FROM and TO WAYPOINTS which are used to travel each segment.

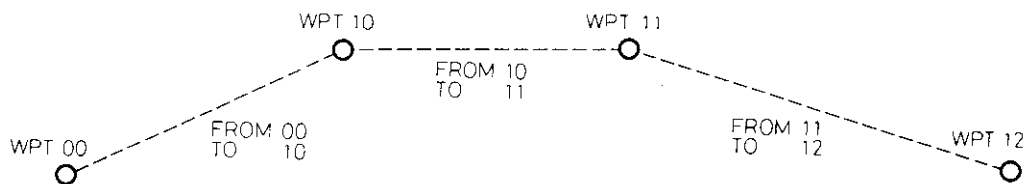

### Entering an ARRIVAL ALARM range

In order to switch the FROM and TO WAYPOINTS, the GP-1250 is continually calculating the Distance-To-Go, which you may read on the plotter screen. When the DTG gets shorter than a threshold, the unit recognizes that the ship has arrived in the TO WPT, resulting in changeover of the FROM/TO WAYPOINTS.

By using the following keystrokes, you may enter the threshold mileage. Do not enter such a short threshold that your boat can not clear. Otherwise FROM and TO WAYPOINTS are not switched. The default value (0.05 nm) is most commonly used.

[MENU] [5] [1] .....  
 ↓  
 [ ] . [ ] [ ] [ENT] ..... Enter a threshold mileage.  
 ↓  
 [1] [ENT]  
 or  
 [2] [ENT]

(\* ARRIVAL ALARM \*)

LIMIT : 0.05 N.M.

SOUND : OFF

LIMIT : ■ . . . N.M. ?

If you enter [1], the GP-1250 will beep each time your boat reaches a TO WAYPOINT. If you do not need a beep, enter [2].

[PLOT]

As explained before, you may travel each segment in the same manner as the waypoint navigation. The following three functions, described in the preceding chapter, are fully supported in the ROUTING NAVIGATION as well.

Plotter-aided Navigation ----- Page 36

Displaying NAV. DATA SCREEN ----- Page 40

Exiting the plotter-aided Navigation ----- Page 41

### Reversing a Route

For the return trip, you would want to reverse the routing direction. You may do this by pressing [↶] when you select a route.

↓  
[TO] [TO] [TO]

↓  
[ ] [ ] [↶] [ENT]..... Press [↶] before you enter a route number, and the GP-1250 attaches sign "-" to the route number to acknowledge that the route direction is reversed.

The plotter screen appears automatically.

When you want to return the route to the initial direction, reenter the route number without pressing [↶]. The "-" sign will be erased.

### Skipping a Waypoint on a Route

When your voyage plan has changed and you want to skip a waypoint on a route, use the following keystrokes. The GP-1250 recalculates the route with the waypoint excluded.

[WPT] [3]

↓

↓  
 [ ] [ ] [ENT] ..... Enter a route number from which you want to exclude a waypoint.

```

(* ENTER ROUTE *)
ROUTE NO. : 07
WPT ( 1 ) : **
           ( 2 ) : **
           ( 3 ) : **
           ( 4 ) : **
           ( 5 ) : **
           ( 6 ) : **
           ( 7 ) : **
           ( 8 ) : **
           ( 9 ) : **
           (10) : **
WPT LIST [C]
(1) 00 **
    10 **
    20 **
    30 **
    40 **
    05 **
    ** **
    ** **
    ** **
    ** **

YOU MAY ENTER 10 WPTS FOR A ROUTE.
[SHFT]+[ENT] : PAUSE A WPT.
[SHFT]+[SHFT]+[ENT] : REMOVE A WPT.

WPT ( 1 ): - ?
( NEW ROUTE )
  
```

ROUTE

SERIAL NO.

↓  
 [ENT] ... [ENT] ..... Press [ENT] several times until the 2- digit **SERIAL NUMBER** of an intended waypoint appears on the prompt line.

↓  
 [SHFT] [ENT] ..... The waypoint is temporarily, and sign "-" is attached to the waypoint number on the screen. (You may restore it when desired. See the NOTE below.)

or

[SHFT] {SHFT} [ENT] .. That waypoint is permanently deleted from the route.

↓  
 [PLOT]

*NOTE: To restore the excluded waypoint, call up the SERIAL NUMBER of the excluded waypoint, then enter the waypoint number rather than pressing [SHFT] [ENT].*

**MORE ABOUT GP-1250**  
**\* \* \* \* \***

# ALARM FUNCTIONS

The GP-1250 is provided with the following alarm functions, and you will learn their usages in this chapter.

## ARRIVAL Alarm

The alarm is triggered when the ship enters into the alarm zone on the TO WPT.

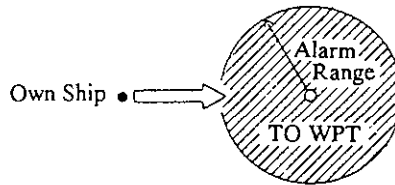

## CROSS-TRACK ERROR Alarm

The alarm is triggered when the cross-track error exceeds the alarm range.

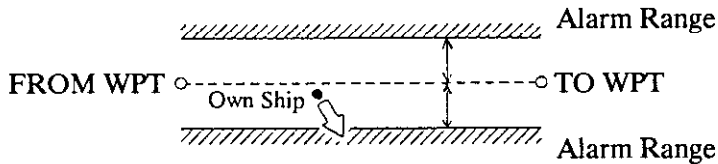

## BORDER Alarm

First, register two waypoints on a border line, then select them as FROM and TO WAYPOINTS. The alarm is triggered when the ship enters into the alarm zone on the border line.

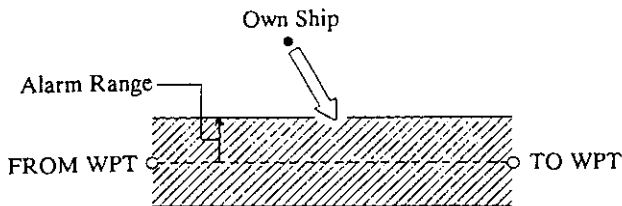

ALARM

When an alarm condition is breached, the GP-1250 peeps and displays a relevant message as illustrated below. If you want to silence the peep, press the [CLR] key. The visual alarm can't be erased.

*NOTE: The GP-1250 releases the alarms in all modes of operation, including the ECONOMY mode.*

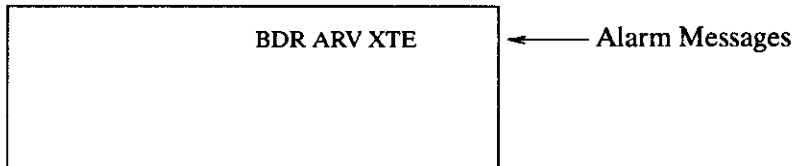

---

## ARRIVAL Alarm

---

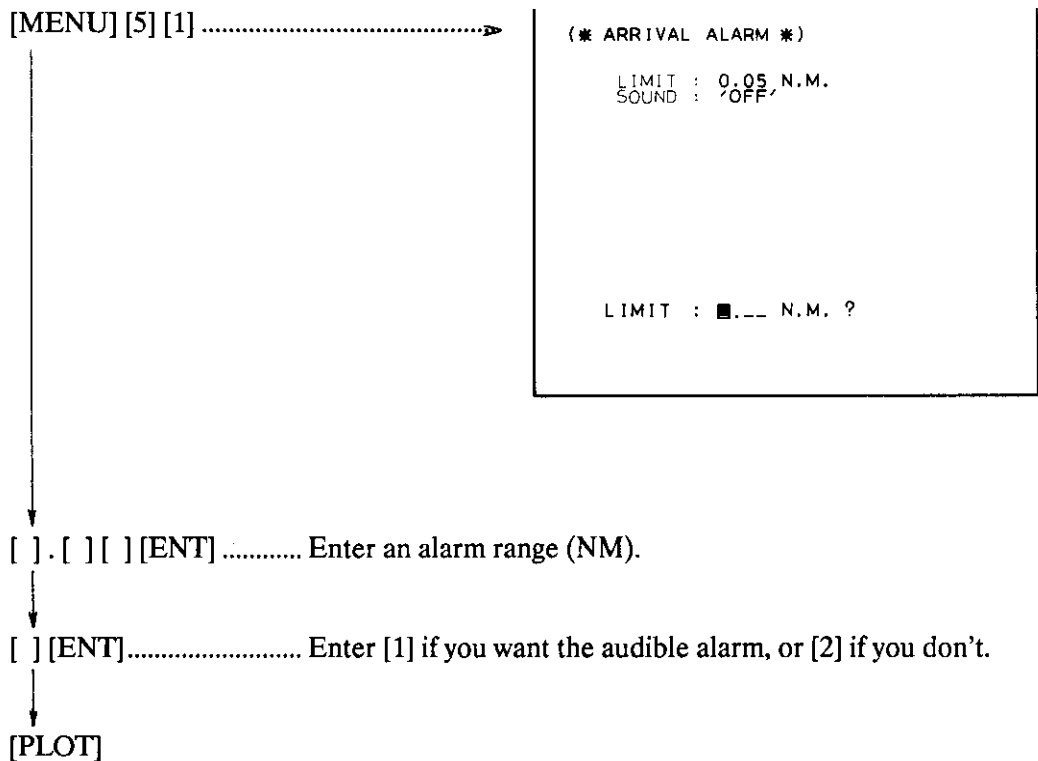

*NOTE: In the routing navigation, the FROM and TO WAYPOINTS are changed each time the boat breaches the arrival alarm range.*



# CROSS-TRACK ERROR Alarm

[MENU] [5] [2] .....

(\* XTE ALARM \*)

LIMIT: 0.05 N.M.

SOUND: OFF

LIMIT : ■. \_ \_ N.M. ?

[ ] . [ ] [ ] [ENT] ..... Enter an alarm range (NM).

[ ] [ENT] ..... Enter [1] if you want the audible alarm, or [2] if you don't.

[PLOT]

ALARM

---

## BORDER Alarm

---

Enter two waypoints on the border line, and select them as FROM and TO WAYPOINTS.

↓  
[MENU] [5] [3] .....

(* BORDER ALARM *)
LIMIT: 0.00 N.M.
SOUND: OFF
LIMIT : ■. _ _ N.M. ?

↓  
[ ] . [ ] [ ] [ENT] ..... Enter an alarm range (NM).

↓  
[ ] [ENT] ..... Enter [1] if you want the audible alarm, or [2] if you don't.

↓  
[PLOT]

# MEMORY PARTITIONS

As the following figure illustrates, the GP-1250 can memorize up to 4423 (= 1800 + 1524 + 99 + 1000) points of geographical locations as track line, event marks, waypoints, and coastline (from a ROM card).

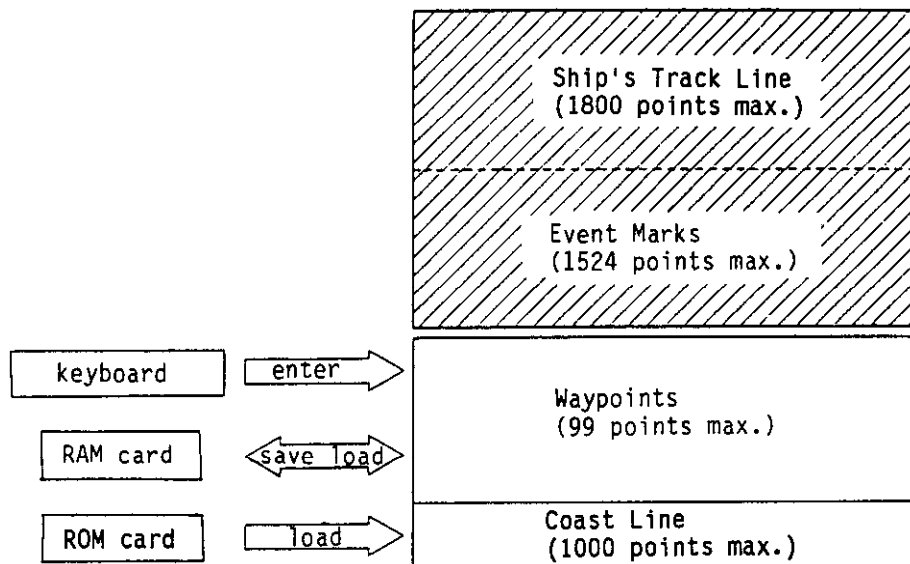

MEMORY

The hatched area in the above figure stores present positions (track line) and event marks, and is divided into three equal partitions, ①, ②, and ③ as illustrated below. The "present positions" from the built-in GPS or a back-up navaid are stored in ①. When you press the [EVT] key, an event position is stored in ① as well. The contents of partition ① are always visible on the plotter screen as ship's track line or event marks.

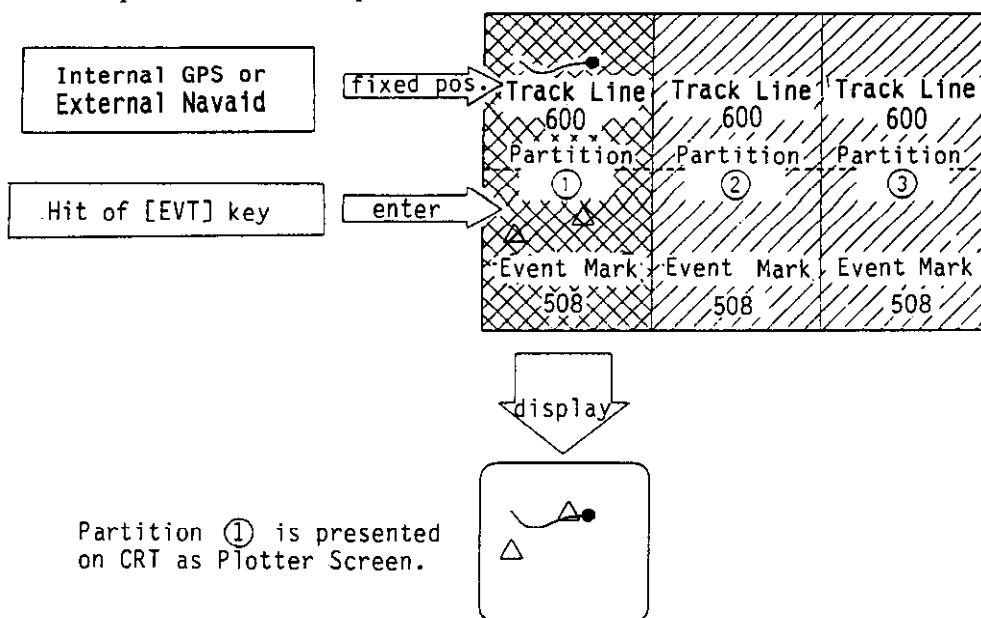

## Saving ship's track line

You may copy partition ① onto ② or ③ for future reference. All memories are kept alive even when the power is shut down.

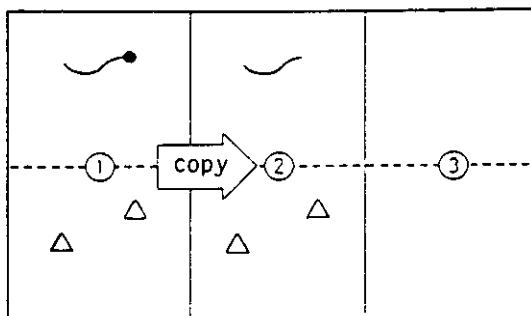

[MEMO] [1].....

Status of each partition appears.

"UPDATED" is displayed for partition No. 1 since present position is being entered there.

```
(* STORE TRACK & MRKS INTO PART.*)
PARTITION NO.1: UPDATED [ 13, 0 ]
           NO.2: UNUSED  [  0, 0 ]
           NO.3: USED    [ 13, 0 ]
```

THE TRACK & MARKS IN PARTITION NO.1 WILL BE STORED INTO A PARTITION YOU CHOOSE.

CHOOSE PARTITION NO. : ■ ?

If "USED" is displayed, it means that the partition was written before. If you overwrite it, the existing contents will be lost.

"UNUSED" means that the partition is empty.

These numbers show how many position data each partition contains. (MARKS = event marks)

[ ] [ENT].....Enter a partition number on which you want to copy ① to.

[ENT].....The plotter screen appears automatically.

# Overlay

You may overlay partition ① with ② or ③. This feature is useful when you want to follow a past track line, etc.

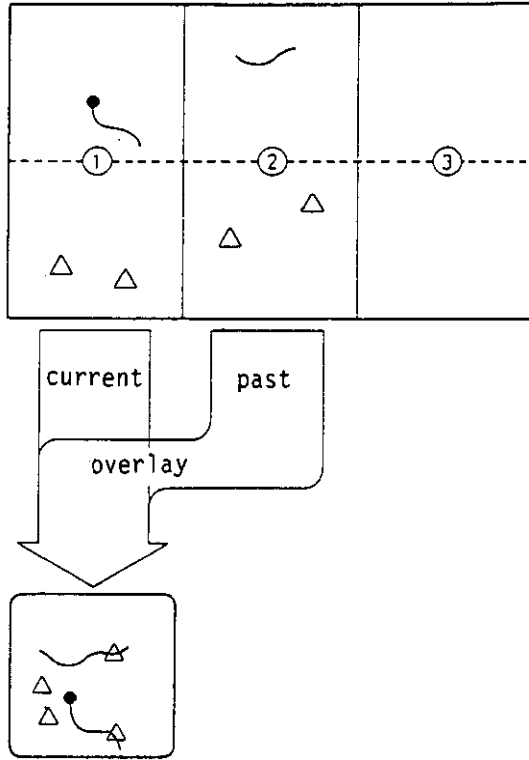

MEMORY

[MENU] [2] .....

```
(* RECALL TRACK & MRKS FROM PART.*)
PARTITION NO.1: UPDATED [ 13, 0]
           NO.2: UNUSED  [  0, 0]
           NO.3: USED    [ 13, 0]

NO.1 IS ALWAYS DISPLAYED.

PLEASE ENTER PARTITION NO.1 TO
CANCEL OVERLAID MODE.

CHOOSE OVERLAID PART.NO.: ■ ?
```

[ ] [ENT] ..... Enter the partition number which you want to overlay on ①.

The plotter screen appears automatically, showing the past track line and event marks overlaid on the currently plotted picture, e.g. ①.

When you want to exit the overlay mode, press [MENU] [2] [1] [ENT] in this order.

# RAM CARD (optional)

Before you start using a RAM card, read the cautions described at the head part (page E) in this manual.

A RAM card allows you to:

1. Save all waypoints into a RAM card as a data file, and reload the data file on the GP-1250 as waypoints.

It is a good practice to keep several waypoint files in a RAM card for each fishing season or sea area.

2. Save a memory partition into a RAM card as a data file, and reload the data file onto one of GP-1250's memory partitions.

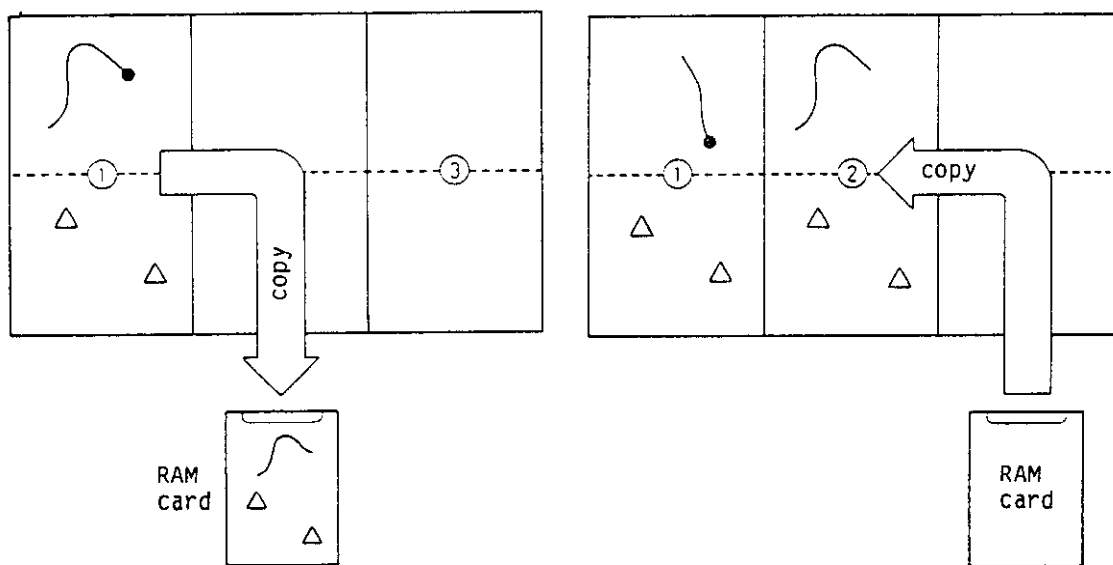

If a file is reloaded on (1), you will immediately see the past track line and event marks on the screen. In this case one part of the existing track line and/or event marks will be lost if the memory capacity of partition (1) is exceeded. If it is reloaded on (2) or (3), you may see it by overlay.

## Capacity of RAM Card

Each RAM card can store the following quantities of data:

- (99 points of waypoints)
- + (1800 points of track line plotting)
- + (1524 points of event marks)

Don't misconstrue that the entire capacity is divided into the three fixed areas for waypoints, track line, and event marks, respectively. No, the memory structure is flexible. If less event marks are entered, for example, you may enter waypoints the more.

---

## Formatting a RAM card

---

Before using a brand-new RAM card, you must add a process called "formatting" to it.

*NOTE 1. An unformatted RAM card can't be read or written by the GP-1250.*

*2. Formatting is required one time only. If a RAM card containing any data is formatted, the data is lost.*

Insert a brand-new RAM card into the card slit.

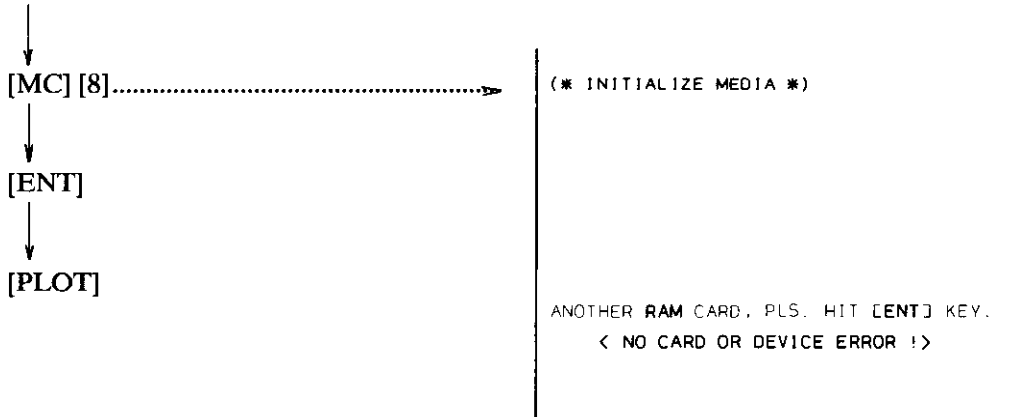

RAM CARD

# Saving/reloading SHIP'S TRACK LINE/EVENT MARKS

## Saving ship's track line/event marks into a RAM card

Insert a RAM card into the card slit.

[MC] [2].....

A partition list appears.

```
(* STORE DATA INTO MEDIA *)
PARTITION NO. 1: UPDATED   TRACK MRKS
              NO. 2: UNUSED   [ 15, 0 ]
              NO. 3: USED    [  6, 0 ]
                          [ 13, 0 ]

CHOOSE PARTITION NO. : ■ ?
```

[ ] [ENT]..... Enter the partition number which you want to save.

A track line file list appears.  
These track line files already exist in the RAM card.

To display the rest of the list,  
press [ ↻ ].

```
(* STORE DATA INTO MEDIA *)
FILE NAME      DATE  SIZE & MEMO
01: T_0001     03/27/90 10:45  15
02: T_1989     03/27/90 10:45  13
03: T_1990     03/27/90 10:45  15

( [↻] KEY CHANGES PAGE. )
CHOOSE PARTITION : NO.3
FILE NAME ON MEDIA : T_■_■_■_ ?
```

[ ] [ ] [ ] [ ] [ENT]..... Enter a 4-digit label (ID) number for a new file.

The GP-1250 automatically adds prefix "T\_" (meaning Track line) to the 4-digit number.

[PLOT]



**Reloading ship's track line/event marks from a RAM card**

Insert a RAM card into the card slit.



[MC] [4].....

A track line file list appears.

To display the rest, press  
[C].

```
(* RECALL DATA FROM MEDIA *)
FILE NAME      DATE , SIZE & MEMO
01: T_0001     03/27/90 10:45 15
02: T_1989     03/27/90 10:45 13
03: T_1990     03/27/90 10:45 15

( [C] KEY CHANGES PAGE. )

CHOOSE FILE NO.: █ ?
```

[ ][ ][ENT]..... Enter the 2-digit number assigned to the intended file label.

```
(* RECALL DATA FROM MEDIA *)

PARTITION NO.1: UPDATED [ 17, 0 ] TRACK MRKS
              NO.2: UNUSED [ 0, 0 ]
              NO.3: USED  [ 13, 0 ]

CHOOSE FILE NO.: 02 ( T_1989 )

CHOOSE PARTITION NO.: █ ?
```

[ ][ ][ENT]..... Enter the partition number on which you want to reload the file to.

If the number of "USED" partition is entered, it is overwritten.

[PLOT]

**RAM CARD**

**Deleting a track line/event mark file from a RAM card**

Insert a RAM card into the card slit.

[MC] [6].....

A track line file list appears.

To display the rest of the list,  
press [↻].

(* ERASE WPT DATA ON MEDIA *)			
	FILE NAME	DATE	SIZE & MEMO
01:	W_0001	03/27/90	10:56 1614
02:	W_1989	03/27/90	10:57 1614
03:	W_1990	03/27/90	10:57 1614

( [↻] KEY CHANGES PAGE. )

CHOOSE NO.: █ ?

[ ] [ ] [ENT]..... Enter the 2-digit number assigned to the intended file label,  
and the GP-1250 will prompt you for confirmation.

[ENT]..... Press [ENT] to say Yes.

[PLOT]

# Saving/reloading WAYPOINTS

## Saving waypoints into a RAM card

Insert a RAM card into the card slit.

[MC] [3].....→

A waypoint file list appears.

To display the rest of the list,  
press [↺].

```
(* STORE WPT DATA INTO MEDIA *)
FILE NAME      DATE , SIZE & MEMO
01: W_0001     03/27/90 10:56 1614
02: W_1989     03/27/90 10:57 1614
03: W_1990     03/27/90 10:57 1614

( [↺] KEY CHANGES PAGE. )
FILE NAME ON MEDIA : W_█_█_█_ ?
```

[ ] [ ] [ ] [ ] [ENT]..... Enter 4-digit label number for a new file.

The GP-1250 automatically adds prefix "W\_" (meaning Waypoint) to the 4-digit number.

[PLOT]

RAM CARD

## Reloading waypoints from a RAM card

Insert a RAM card into the card slit.

[MC] [5].....→

A waypoint file list appears.

To display the rest of the list,  
press [↺].

```
(* RECALL WPT DATA FROM MEDIA *)
FILE NAME      DATE , SIZE & MEMO
01: W_0001     03/27/90 10:56 1614
02: W_1989     03/27/90 10:57 1614
03: W_1990     03/27/90 10:57 1614

( [↺] KEY CHANGES PAGE. )
'TO WPT' ON NAV. WILL BE CANCELLED !
CHOOSE FILE NO. : █_ ?
```

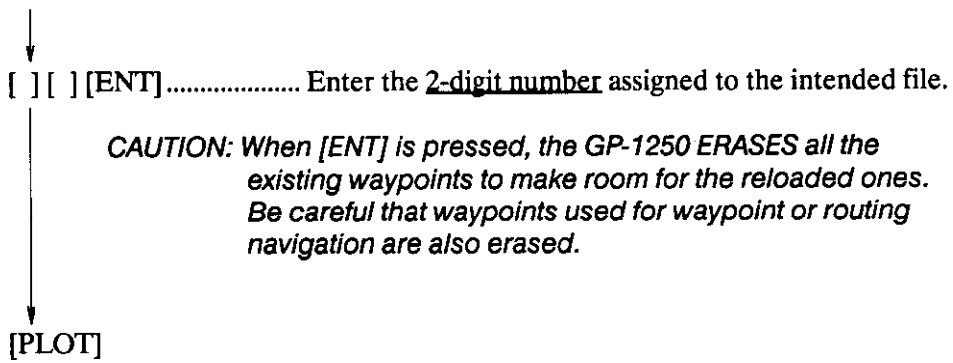

**Deleting a waypoint file from a RAM card**

Insert a RAM card into the card slit.



A waypoint file list appears.

To display the rest of the list, press [↻].

(* ERASE WPT DATA ON MEDIA *)			
FILE NAME	DATE	SIZE	MEMO
01: W_0001	03/27/90	10:56	1614
02: W_1989	03/27/90	10:57	1614
03: W_1990	03/27/90	10:57	1614

( [☒] KEY CHANGES PAGE. )

CHOOSE NO.: █. ?

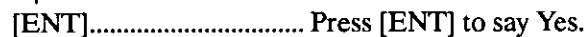
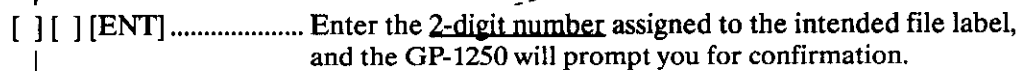



When the auto loading function is disabled, you must load a coastline manually:

Insert a ROM card into the card slit. ....

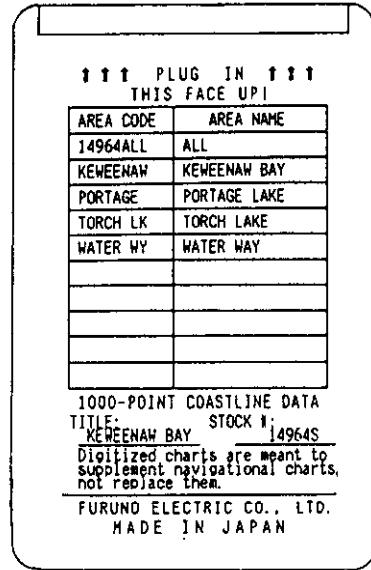

[MC] [1].....

A coastline file list appears.

To display the rest of the list, press [↺].

(\* RECALL CHART FROM MEDIA \*)

NAME

01: 1496ALL

02: KEWEENAW

03: PORTAGE

04: TORCH LK

05: WATER WY

( [↺] KEY CHANGES PAGE. )

CHOOSE NO. : █ ?

[ ] [ ] [ENT].....

Enter the **2-digit number** assigned to the intended file.  
 (You may select a coastline which is away from your current area.)

Message "NOW READING" appears on the bottom line. Wait until it changes to "COMPLETE!"

[PLOT]

*NOTE 1. You may do this operation when the auto loading mode is selected as well.*

*2. If a coastline is not displayed on your screen, check the following points:*

- Isn't the coastline situated out of the scope of the current plotter screen?
- Isn't the picture shrunk and the coastline is out of the scope of the current plotter screen?

# CORRECTIONS

## LAT/LON Correction

Each paper chart is made based on a latitude/longitude system called a geodetic system. Each country has a different geodetic system, and this means that the latitude/longitude system employed in your chart may slightly differ from the other's or perhaps from the GPS fix displayed on the GP-1250. In this case the latitude/longitude readings on your GP-1250 may be a yacht club house on your paper chart for example, though the boat is moored in a harbor.

Measures to compensate for this difference is furnished in the GP-1250. If a constant error is observed in the latitude or longitude reading of a GPS fix, compensate for it as follows.

[MENU] [6] [1] .....

(\* LAT/LON CORRECTION \*)

NOW: CORRECTION TO LAT = 0.00' N  
LON = 0.00' E

CORRECTION TO LAT: ■. \_ \_ ' N ?

[ ] . [ ] [ ] ' [ ] [ENT] ..... Enter a latitude offset value.

↑  
----- Select  
N or S.

CORRECTION TO LON: ■. \_ \_ ' E ?

[ ] . [ ] [ ] ' [ ] [ENT] ..... Enter a longitude offset value.

↑  
----- Select  
E or W.

[PLOT]

NOTE: When a non-zero value is entered, "L/L" (latitude/longitude) appears.

L/L



## MAGNETIC Correction

Because the magnetic north pole is slightly deviated from the true north pole, a small difference always exists between the true and magnetic bearings. This difference, called a **MAGNETIC VARIATION**, differs with respect to sea areas on the earth.

The GP-1250 automatically computes a magnetic variation applicable to your latitude/longitude coordinate, and displays magnetic bearings. If you wish, you may disable this function. In this case you must consult with your sea chart to find a proper magnetic variation and enter it manually as described on the next page. For accuracy, manual entry of magnetic variation is preferable because the magnetic variations written on a sea chart are usually more reliable than the automatically computed ones.

### Selecting an **AUTOMATIC** or **MANUAL** mode

[MENU] [6] [2] .....

(\* MAGNETIC VARIATION \*)

MAG.V: 7° WEST 'AUTO'

1: AUTO  
2: MANUAL

CHOOSE: \* ■ ?

[1] [ENT]..... Enter [1] for the automatic mode.

or

[2] [ENT]..... Enter [2] for the manual mode.

[PLOT]

## Entering a magnetic variation manually

If the manual mode is selected in the preceding page, enter a magnetic variation manually:

[MENU] [6] [2]

[2] [ENT].....

Select a MANUAL mode.

```
(* MAGNETIC VARIATION *)
MAG. V:  7° WEST      'MANUAL'
```

```
MAG. VARIATION : ■ - ° WEST ?
```

[ ] [ ] ° [ ] [ENT]..... Enter a magnetic variation.

--Select East or West.

If you are using a GYROCOMPASS, enter zeroes. You will see TRUE BEARINGS displayed.

[PLOT]

When a magnetic variation (non-zero value) is entered, whether it be done automatically or manually, the GP-1250 displays "MAG V" to tell you that all bearings you read on the GP-1250 are MAGNETIC bearings. It disappears when true bearings are displayed.

```
MAG V
```

*NOTE: The bearing of the cross cursor is always true. Keep this in mind when you sail to a cursor-pointed location. See page 16.*

## Selecting a PLOTTING INTERVAL

As explained on page 53, the GP-1250 can store up to 600 points of latitude/longitude coordinates to draw ship's track line. The default plotting interval is 5 minutes. This means that the memory becomes full after 3000 (= 5 × 600) minutes' plotting. When the next plotting time has come, the GP-1250 erases the earliest end of the track line and adds a new point to the latest end of the track line. In other words you can see the past 3000 minutes of track line on the screen. The following figure illustrates this operation.

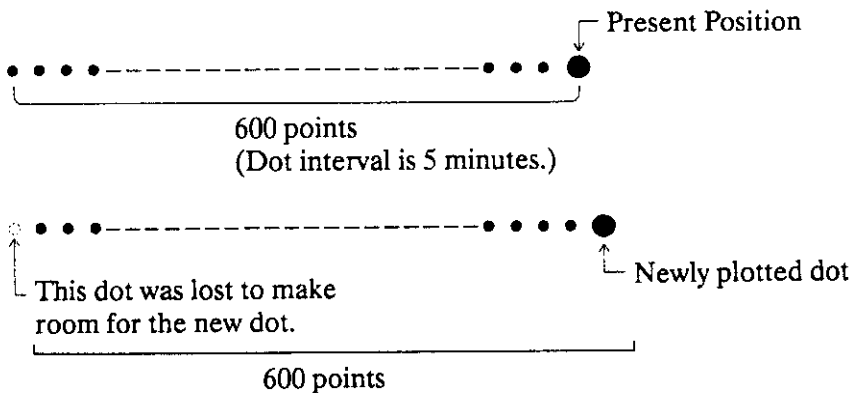

In your GP-1250, two plotting intervals are available. One is called a No.1 INTERVAL (= 5 MIN) and the other No. 2 INTERVAL (= 10 MIN). Use the following keystrokes to switch between the two intervals. If the No. 2 INTERVAL (= 10 MIN) is selected, you will see 6000 (= 10 × 600) minutes of track line on the screen.

[PLOT]  
 ↓  
 [SHFT] [SHFT]..... Press the key twice, and you will see the plotting interval indication highlighted.  
 ↓  
 [↻]..... Select No. 1 or No. 2 INTERVAL.  
 ↓  
 [CLR]..... The highlighted rectangle disappears.

MISCELLANEA

Trade-off for a longer track line is that ship's track line appears zigzagged when the screen is expanded. Therefore, you would have to compromise between a long track line and precise plotting.

If you want, you may change the values in the No. 1 and No. 2 intervals from the default values (5 & 10 min.) See page M-19.

---

## PLOTTER-ONLY MODE

---

When the built-in GPS receiver is faulty, you would like to use your GP-1250 as a video plotter for the external navaid only. Use the following keystrokes, resulting that the internal GPS receiver is totally disabled and the GP-1250 operates as a display device for the external navaid.

[PLOT]



[SHFT] [SHFT] [SHFT] .....>

"I. GPS" is highlighted.



[C].....The type of the external navaid appears:

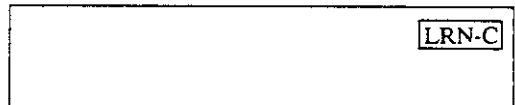

- I. GPS..... Internal GPS
- E. GPS..... External GPS
- LRN-A ..... External LORAN A
- LRN-C ..... External LORAN C
- NNSS..... External SATNAV (TRANSIT)
- DECC..... External DECCA
- E. NAV ..... External Device (Talker Name = II)

To enable the internal GPS receiver again, call up "I. GPS."

[CLR]..... The highlighted rectangle disappears.

*NOTE: If a data is not transferred from the external navaid, "RCV-ERR" appears and blinks.*

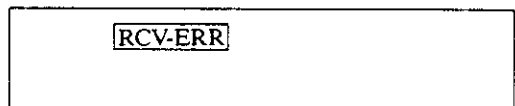

# **USER LEVEL MAINTENANCE**

\* \* \* \* \*

**MAINTENANCE**

## Deselecting an UNHEALTHY SATELLITE manually

Every GPS satellite is broadcasting the abnormal satellite number(s). By receiving this information, the GP-1250 eliminates a malfunctioning satellite from the GPS receiving schedule. When the satellite has restarted normal operation and this information is received, the GP-1250 includes it in the schedule. Accordingly it is usually not required to deselect a satellite manually.

Sometimes abnormal satellite number is not broadcasted by any satellite. If you learn of an unhealthy satellite through official announcement, etc., deselect it manually. When the satellite has restarted normal operation, do not forget to reselect it because the manually deselected satellite can not be restored automatically.

Abnormal satellites presented on the ALERT screen ([MON], page 8) are automatically deselected ones; the disabled satellites presented on the following screen are manually deselected ones.

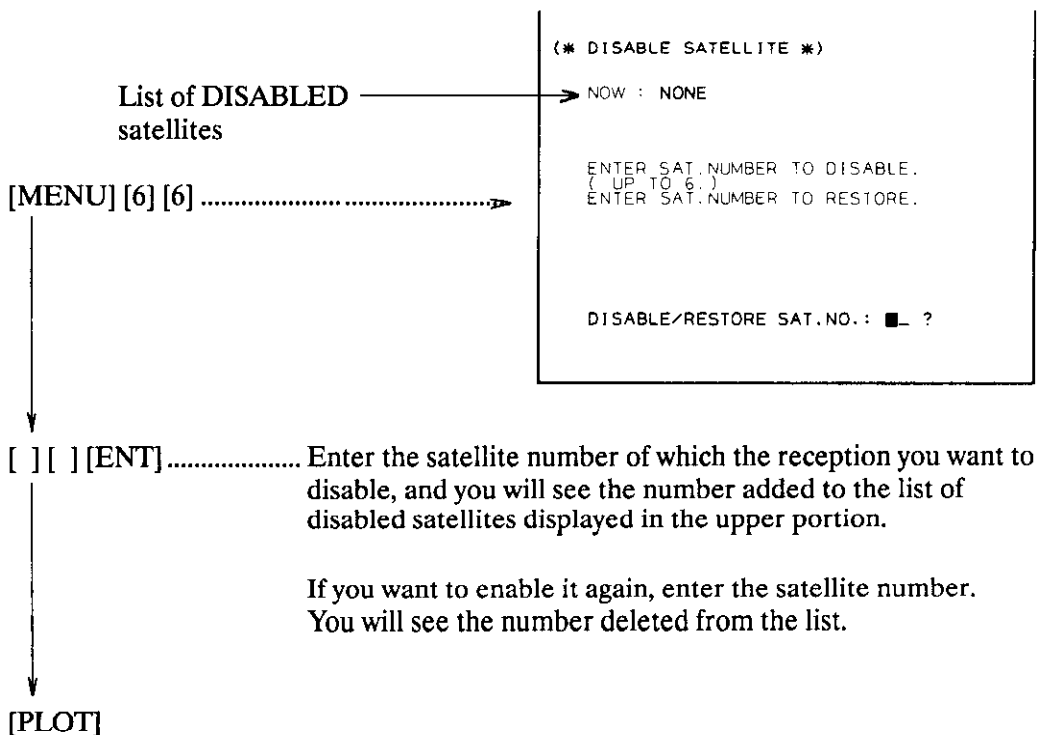

# Running the SELF-TEST Program

If you feel anything wrong with your GP-1250, run the self-test program as follows.

[MENU] [9] [1] [ENT]



In a few seconds the GP-1250 will report the test results on the SELF TEST screen:

```
(* SELF TEST *)
ROM : OK
RAM1 : OK
RAM2 : OK
VRAM1 : OK
VRAM2 : OK
VRAM3 : OK
VRAM4 : OK
PORT 1 : NG
PORT 2 : NG
          WHEN YOU CHECK
          PORTS, PLEASE SET
          JUMPERS.
INT. GPS : 0123456789ABCDEF GHIJKLMN
NO. : ?-?-??-?-?-?-?-?-?-?-?-?
CARD : READ OK
KEYS :
(AFTER TESTING,
PLEASE TURN THE POWER OFF.)
< PLEASE HIT ANY KEY >
```

- Memory Chips are tested.
  - Input/output ports for ext. equipment are tested. (For service technician only.) Don't be surprised if NG (No Good) appears; it always appears unless a special arrangement is made.
  - INTERNAL GPS Receiver is tested. "NG" or "?" appears if faulty. Refer to the next page for the detail.
- No. = **xx xx**  
           └─ SIG Program Ver. No.  
               └─ NAV Program Ver. No.
- Memory Card, which is presently inserted, is tested.
  - Hit keys one by one while "PLEASE HIT ANY KEY" is displayed. If a proper key symbol appears, the key is normal.

If any abnormality is reported on the screen, call for repair. Bear in mind that the self-test program does not test all the functions of the GP-1250. Therefore, even if everything is OK on the self-test screen, it does not always mean that your GP-1250 is 100% alright.

To exit the self-test mode, turn the power off.

**MAINTENANCE**

## FOR SERVICE TECHNICIANS

To test the communication ports, run the self-test program with jumper leads strapped as illustrated below.

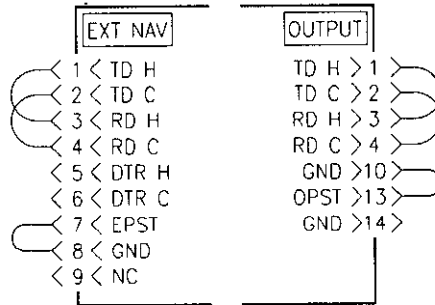

The GP-1250 transmits a test data and receives it. If the received data matches the transmitted one, it displays "OK."

## RESULT OF THE SELFTTEST

No.	Results	
0	Antenna not connected	
1	SIG block	ROM error
2		Local RAM error
3		Common RAM error
4		Chip 1 error
5		Chip 2 error
6		FIX block
7	Local RAM error	
8	Backup RAM error	
9	Common RAM error	
A	I/O error	
B	8087 error	
C	RTC error	
D	NAV block	ROM error
E		Local RAM error
F		Backup RAM error
G		Common RAM error
H		Battery error
I		External loop back error
J	Not used	
K		
L		
M		
N		



---

# ALL MEMORY CLEAR

---

The ALL MEMORY CLEAR function erases all memories in the GP-1250. Use this function when someone has entered a lot of wrong data etc., and you want to initialize the memories. Note that this operation clears all waypoints which you had entered.

— CAUTION —

1. When the ALL MEMORY CLEAR is executed, all the memories listed on the next page are cleared or initialized to the default values. If required, record the current settings in a log so that you can reenter them later. Don't forget to record waypoint latitude/longitude. See page 33.
2. After the ALL MEMORY CLEAR operation, the COLD START (page 24) is invoked automatically, i.e. the GP-1250 searches for a satellite to receive Almanac. If you can tell your GP-1250 what satellite is presently available in line-of-sight, it is helpful for the GP-1250 to acquire the satellite smoothly. Therefore, it is recommended to find satellite numbers on the ALERT screen (page 8) before you start the all memory clear. Note that once that all memories are cleared, a satellite number can not be displayed on the ALERT screen.

[MENU] [9] [2] .....

(\* CLEAR DATA \*)

PLEASE TURN OFF THE POWER TO  
INITIALIZE ALL MEMORIES.

< QUIT: ▲, 'FUNC' KEY >

↓  
Turn the power off by pressing [PWR] and [OFF] simultaneously.

Now, memories in your GP-1250 are cleared/initialized.

↓  
Reenter the memory contents if necessary, referring to the PARAMETER-SETTING chapter. Don't forget to enter estimated latitude/longitude (page M-15), or GPS reception can not be initiated. (If your boat is in California, USA, you are exempted from the latitude/longitude entry operation because the default latitude/longitude coordinate is California.)

↓  
 If you have a satellite number which is now available in line-of- sight, proceed to the COLD START on the next page. If not, display the ALERT screen (page 8) and wait until the Almanac Collection Date appears. It will take several tens minutes even if there is a satellite in your area.

### DEFAULT SETTINGS

[PLOT]: Plot Interval = No. 1 (5 MIN) Navaid = I. GPS

[MEMO]: Track Line/Event Marks..... All partitions cleared.

[WPT]: Waypoints/Routes ..... Cleared.

[TO]: Navigation ..... OFF

[MC]: Coastline Data ..... Cleared.  
 Coastline Entry Mode ..... AUTO

[MENU] [1]: Estimated Latitude ..... 38° 30.00'N  
 Longitude ..... 23° 30.00'W

[MENU] [2]: Date/Time ..... GMT  
 Local Zone Time..... + 00:00

[MENU] [3]: Plotting Interval..... No.1 = 5 MIN No.2 = 10 MIN

[MENU] [4]: Waypoint ( + ) Display ..... ON  
 Intended Track (---) Display..... ON

[MENU] [5]: Alarm ARV ..... 0.05 NM OFF  
 XTE ..... 0.05 NM OFF  
 BDR..... 0.00 NM OFF

[MENU] [6]: GPS Correction Latitude and longitude... 0.00'N 0.00'E  
 Magnetic ..... AUTO  
 Smoothing ..... Position = 0 Speed = 5  
 Antenna Height..... 0M  
 HDOP Threshold..... 20  
 Disable Satellite ..... none

[MENU] [7]: Back-up function ..... OFF  
 GPS Position Correction..... OFF  
 Port 1 (EXT NAV)..... FURUNO CIF/LORAN-C  
 Port 2 (OUTPUT)..... FURUNO CIF (input)  
 FURUNO CIF (output)  
 Output Talker Name ..... GPS

## COLD START (erasing/receiving ALMANAC)

If the GP-1250 has not been used for a long time, half a year for example, it may not acquire a satellite because the existing Almanac is too old to predict a proper satellite arrival time. In such a case, perform the COLD START. This function erases the existing Almanac and receives a new Almanac. Note that extreme error contained in the present time or latitude/longitude also causes the said trouble. If necessary, reenter them, referring to pages M-15 thru M-17.

### CAUTION

*When the Almanac is erased, the GP-1250 searches for a satellite to receive Almanac. If you can tell your GP-1250 what satellite is presently available in line-of-sight, it is helpful for the GP-1250 to acquire the satellite smoothly. Therefore, it is recommended to find satellite numbers on the Alert Screen (page 8) before you start the COLD START operation. Note that once that the Almanac is erased, a satellite number can not be displayed on the Alert Screen.*

- *A satellite acquisition takes several tens minutes even if you enter the satellite number.*
- *After the GP-1250 succeeds in acquiring a satellite, it receives Almanac, which takes about 20 minutes additionally.*

[MENU] [8] .....

(\* COLD START \*)

ALMANAC DATE & TIME:  
03/26/98 14:34:24 SV=03

AFTER COLD START, ENTER SAT.NO.  
FOR ALMANAC RECEPTION.

COLD START  ( YES:[ENT],NO:[CLR] )

MAINTENANCE

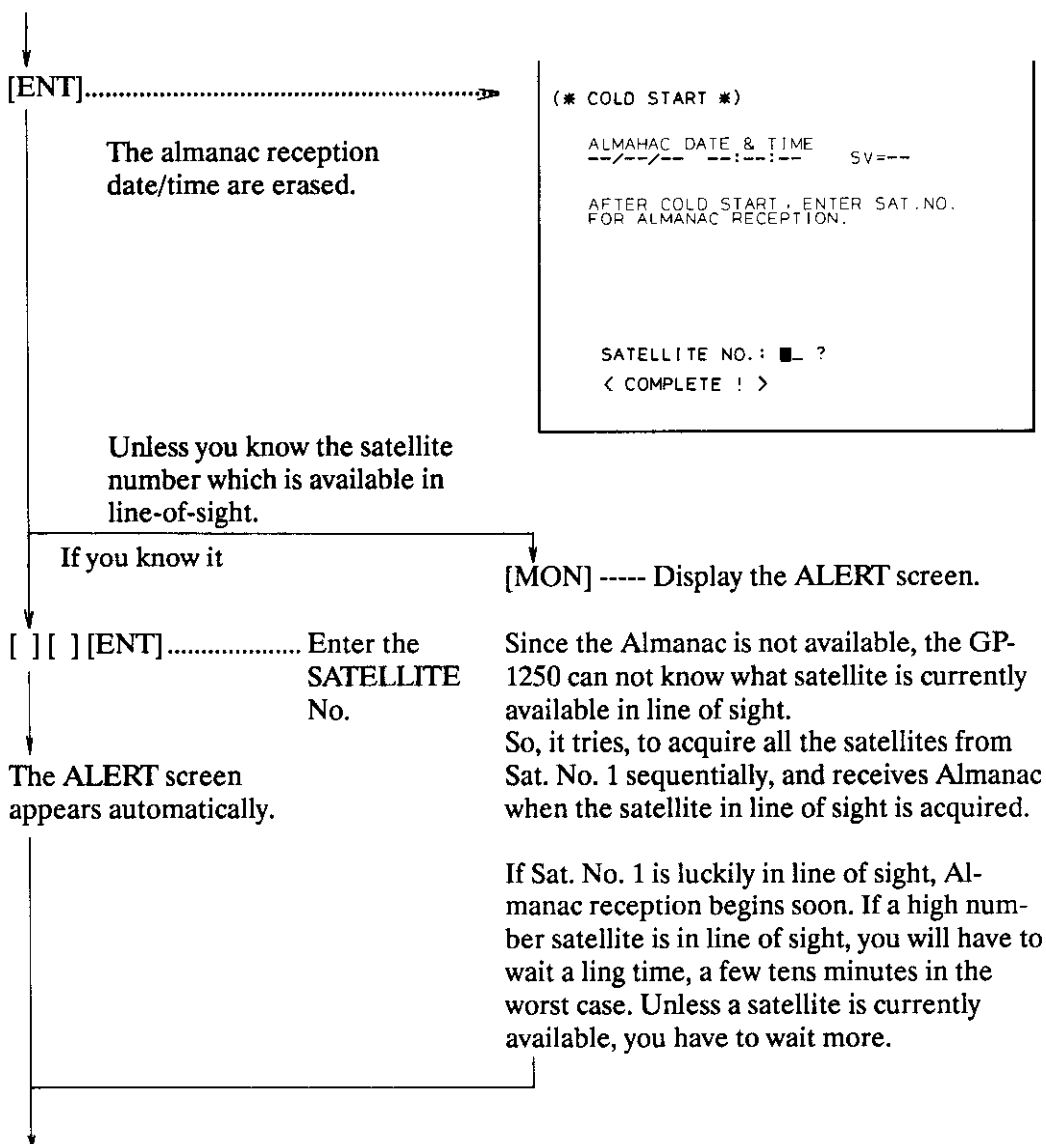

When the Almanac has been received, the ALMANAC DATE/TIME appears on bottom portion of the ALERT screen.

*NOTE: After the ALL MEMORY CLEAR operation, Almanac is erased already. If you wish, you may directly proceed to the SATELLITE No. entry by pressing [MENU], [8], and [CLR] in this order.*

## Replacing the LITHIUM BATTERY in a RAM CARD

The RAM card used for the GP-1250 contains a lithium battery which preserves the memory contents for about 4 years. To ensure important information will not be lost, record on the card label the date the card was purchased. Replace the battery well before the expiration date. Use "BR2325, 3V" lithium battery only. It will be available at a camera shop, electric appliance shop, supermarket, etc.

Lithium Battery "BR2325 3V"



### Procedure

- (1) Turn your GP-1250 on, and insert the RAM card into the card slit.
- (2) Press [MENU], [9], and [3] in this order, and the GP-1250 supplies power to the RAM card. You should replace the battery under this condition because even a momentary power suspension can result in volatilization of the RAM card contents. Do not remove the RAM card from the GP-1250 until you replace the battery.
- (3) Unfasten the small screw illustrated in the left figure, then carefully take out the battery holder as illustrated in the right-hand figure.

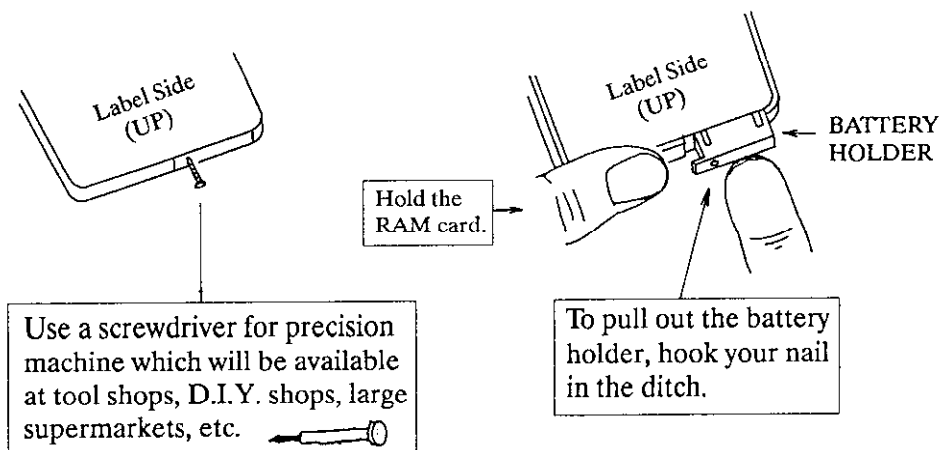

- (4) Place a new battery in the holder, then store the holder in the RAM card. Fasten the small screw.

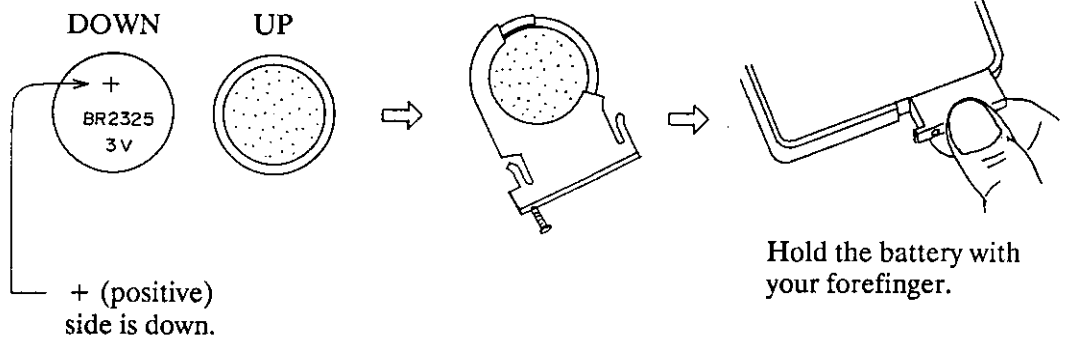

- (5) Press [PLOT]. Now you may take out the RAM card from the GP-1250.

---

## "MEMORIES: SOME ERROR!"

---

In the power-on self-test, the GP-1250 checks if its memory contents are intact. If any memory contents are found destroyed, it displays "SOME ERROR" on the STARTUP STATUS screen, prompting you for an instruction:

```
== STARTUP STATUS ==
RAM SYSTEM AREA : OK
RAM USER AREA  : OK
MEMORIES       : SOME ERROR!

ROM1 NO.225-0112-100
ROM2 NO.225-0112-200

PLEASE CHOOSE EITHER ONE BELOW.
[1] KEY: SAVE WAYPOINTS
[2] KEY: ALL MEMORIES CLEAR
```

You have two choices:

- If you don't mind clearing all the memories including waypoints, press [2].
- If you didn't record waypoint data in a log and want to exclude waypoints from erasing, follow the instructions below:

- (1) Press [1] to exit the STARTUP STATUS screen.
- (2) Display the waypoints, and record their latitude/longitude in a log so that you can reenter them later. See page 33.
- (3) Execute the ALL MEMORY CLEAR described on page M-4, then reenter the waypoints.

After the above operation (regardless of whether you selected [2] or [1] in the STARTUP STATUS screen), the following operations are required:

PARAMETER SETTING ----- Page M-14  
(Don't forget to enter estimated latitude and longitude.)  
COLD START ----- Page M-6

If "MEMORIES: SOME ERROR!" appears the next time the power is turned on, the internal lithium battery (good for 3 years) is used up. Call for replacement.

---

## **"INT. GPS NG!" or "INT. GPS BACKUP DATA ERROR!"**

---

In the power-on self-test, the GP-1250 examines the function of the built-in GPS receiver and its memory. If any abnormality is detected, the following messages appear on the STARTUP STATUS screen:

### **"INT. GPS NG!"**

The built-in GPS receiver is faulty. For the time being, use your GP-1250 in the Plotter-only Mode (page 70) if an external navaid is connected.

### **"INT. GPS BACKUP DATA ERROR!"**

The memories of the built-in GPS receiver were not intact. The GP-1250 already cleared the memories including the Almanac, and C-ST (Cold Start) condition has been invoked. Wait until the Almanac date/time appear on the ALERT screen. If you know what satellite is now available in line-of-sight, perform the COLD START operation described on page M-6.

If the same message appears at the next power application, the internal lithium battery (good for 3 years) is used up. Call for replacement.



---

## Q & A

---

This section provides user-level troubleshooting procedures for the troubles which are mainly caused by misoperation.

[Symptom 1] No satellite reception/No position fixing

(1) Is the PRESENT POSITION reasonable?

If the error is larger than ten degrees, reenter the INITIAL latitude and longitude as explained on page M-15.

(2) Isn't the HDOP THRESHOLD (page M-25) set too low?

Too low a setting, such as 1, causes extremely short position fixing periods.

(3) Perform the SELF-TEST described on page M-2. Are the test results ok?

*NOTE 1. If "INT. GPS: ?" appears, check the ANTENNA connector for proper seating on the rear panel.*

*2. Disregard the test results of the communication interfaces described on page M-3. "NG" is presented unless the jumper leads are connected.*

*3. If the other errors appear, call for repair.*

(4) Are the PRESENT DATE/TIME reasonable?

If not, reenter them as described on page M-16.

(5) Call up the ALERT screen (page 8). Isn't the ALMANAC DATE off more than 6 months or older?

If so, perform the COLD START.

(6) Call up the ALERT screen (page 8). Ask another boat having a GPS receiver to call up the similar screen. If there is a significant discrepancy between the two, the Almanac in your GP-1250 should be faulty. Perform the COLD START explained on page M-6.

[Symptom 2] Position fixing periods are shorter when compared with other ship's GPS.

(1) Isn't the HDOP THRESHOLD (page M-25) set too low?

(2) Aren't healthy satellites DISABLED (page M-1) by mistake?

(3) Isn't there a mast, funnel, etc., near the GPS antenna?

Isn't the GPS antenna close the INMARSAT antenna? During the 2-D period, transmit the INMARSAT. Doesn't the sign change to INT? If it does, GPS reception is interfered.

# PARAMETER SETTING

After the unit is installed, various parameters must be entered. You may adjust their settings in daily operations to meet various requirements in the field.

*NOTE: 1. Although the memories are preserved internally even when the power is failed, it is highly recommended to keep record of parameter setting just in case. It is a good practice to fill in the brackets [ ] in this chapter.*

*2. The default settings are available on page M-5.*

There are many parameters to set, but the following ones are particularly important. Unless you set them properly, your GP-1250 will not work at full performance or may not receive a satellite at all!

**Estimated LAT/LONG** .....▶ Page M-15

Enter them if the PRESENT POSITION reading is different from the actual position by more than 10 degrees. If not, you may omit this operation.

**DATE/TIME/LOCAL ZONE TIME** .....▶ Page M-16

Enter them if the PRESENT DATE/TIME reading are off by more than one hour from the actual time, or if you want to display your local time. If not, you may omit this operation.

**ANTENNA HEIGHT** .....▶ Page M-25

Measure the antenna height above the sea level and enter it. This parameter affects the GPS position fixing accuracy.

**Adjusting COMMUNICATION PORTS** .....▶ Page M-27

This operation is a must if external devices, such as a back-up navaid, color sounder, or autopilot, are connected.

---

## Entering estimated LATITUDE/LONGITUDE

---

If the latitude/longitude of the present position is different from the actual position by more than 10 degrees, GPS position fixing may not be initiated. Enter estimated lat/long as follows.

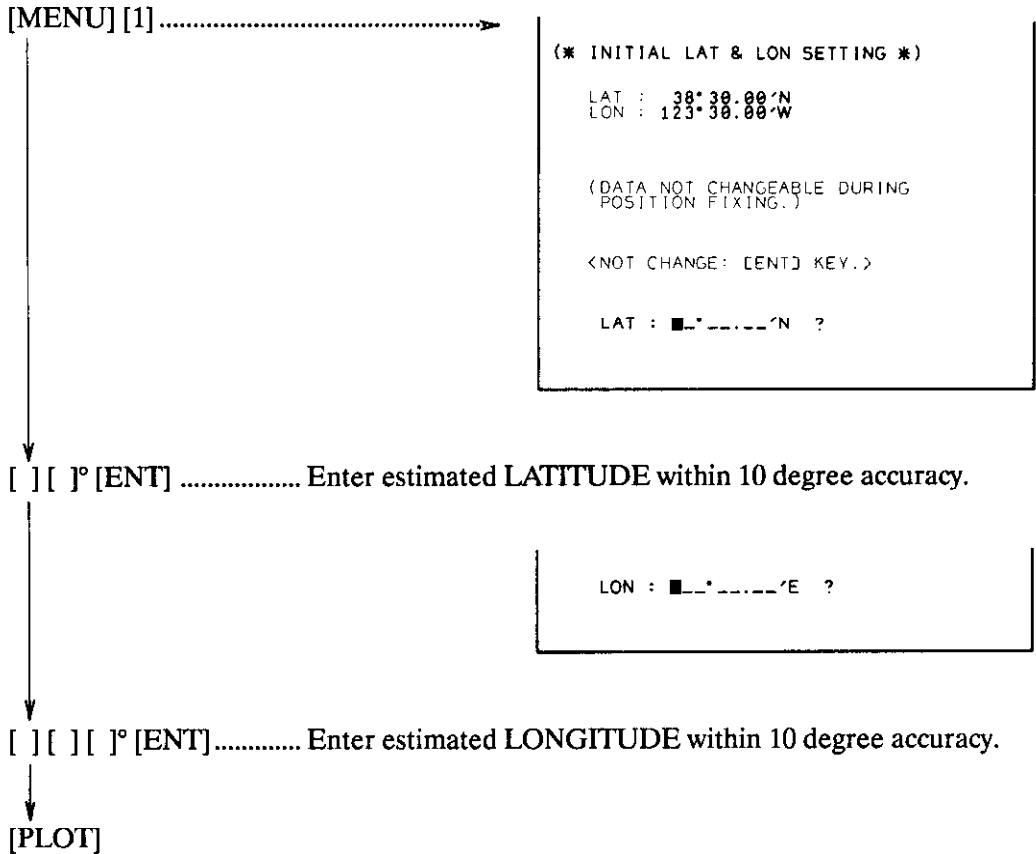

- NOTE** 1. During the GPS position fixing operation, the GP-1250 does not accept your latitude/longitude entry, displaying "POSITION FIXING!"
2. The latitude/longitude settings are automatically replaced by a GPS fix when the HDOP is better than 99. If not, they are updated by the back-up navaid if connected. (When the HDOP is inferior to the HDOP threshold, the GP-1250 displays the position data from the back-up navaid. However, GPS position fixing is performed internally until the HDOP becomes worse than 99.)

# Entering DATE/TIME/LOCAL ZONE TIME

This operation is required when the PRESENT DATE/TIME readings are advanced or delayed more than one hour. The GP-1250 may not receive a satellite if the internal clock is off more than one hour from the actual time.

This operation is also required if you want to display your local time on the on-screen clock.

[MENU] [2] .....

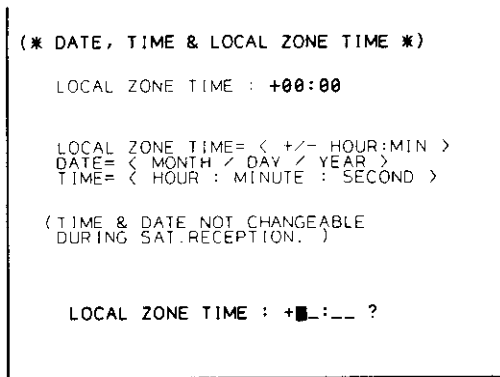

[ ] [ ] hr [ ] [ ] min [ ] [ ] [ENT].....Enter LOCAL ZONE TIME, consulting the chart on page M-18.  
 ↳ Select + or -.

Regardless of the PRESENT POSITION, you may enter any local zone time you want. The GP-1250 is smart enough to adjust the on-screen clock to show a present time which is local to the designated zone. Depending on the local zone time, one of the following suffixes is attached to the on-screen clock reading.

- "G" ..... GMT (Greenwich Mean Time)
- "J" ..... JST (Japan Standard Time)
- "S" ..... others

[ ] [ ] mon [ ] [ ] day [ ] [ ] year [ENT]...Enter today's DATE which is local to the above-entered zone.

↳ For the year, enter the lowest 2 digits.

EX. 19 [9] [6] for 1996  
 20 [0] [0] for 2000

[ ] [ ] hr [ ] [ ] min [ ] [ ] sec [ENT].....Enter present TIME which is local to the above-entered zone.

PARAMETER

↓  
[PLOT]

- NOTE*
- 1. During the GPS satellite reception, the GP-1250 does not accept your date/time entry, displaying "RECEIVING SATELLITE!" As for the local zone time, it may be entered any time.*
  - 2. When a GPS satellite is received, the on-screen clock is corrected automatically.*

LOCAL ZONE TIME

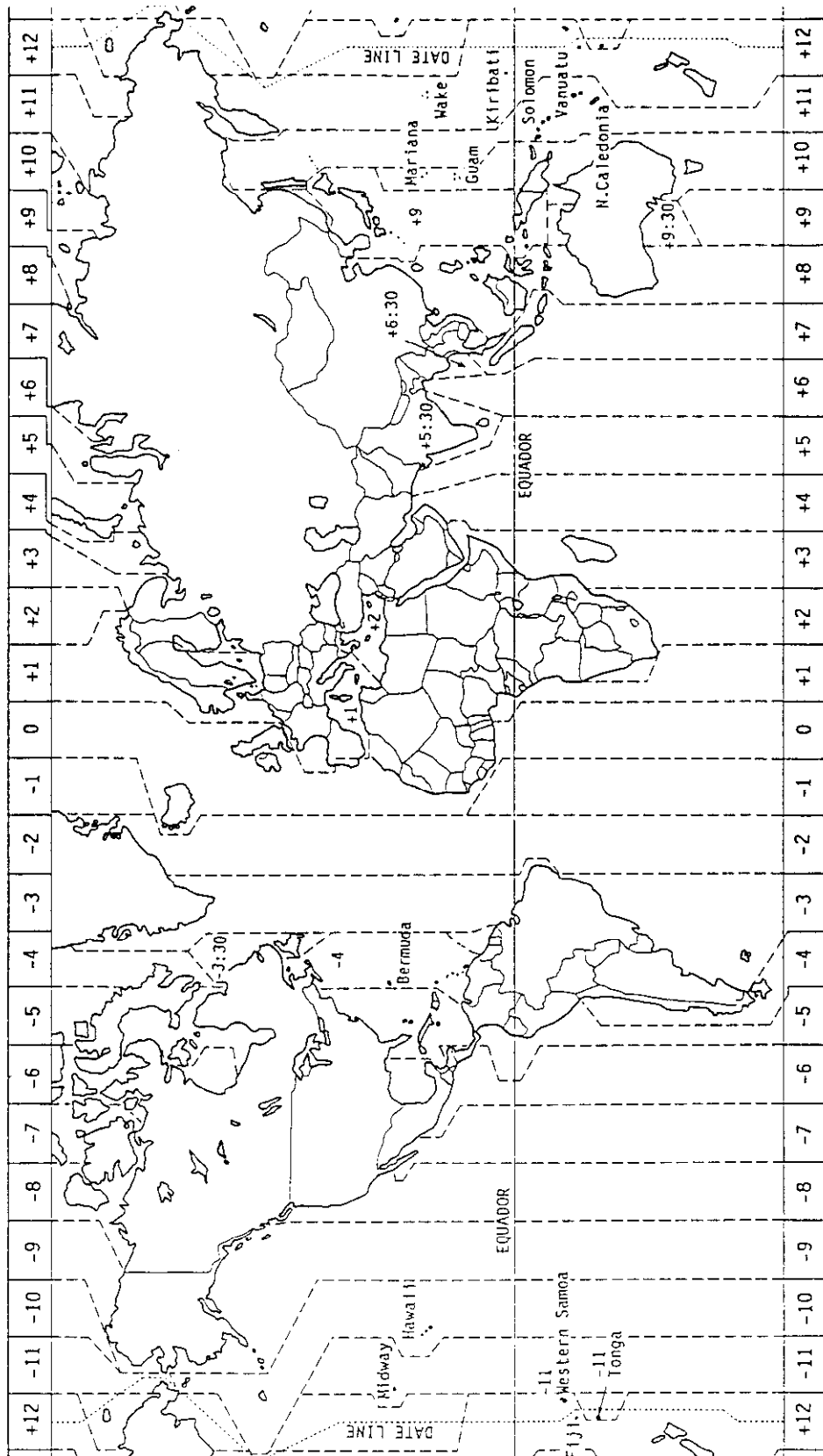

# Entering PLOTTING INTERVALS

Two plotting intervals (No. 1 & No. 2) are available in your GP-1250, and you may use either interval as explained on page 69.

In this section you will define two plotting intervals by time or by distance.

## By TIME

[MENU] [3]  
↓  
[1] [ENT].....for No. 1 Interval  
or  
[2] [ENT].....for No. 2 Interval  
↓  
[1] [ENT].....by TIME .....→  
↓  
[ ][ ] min [ ][ ] sec [ENT] .... Enter an interval by time.  
↓  
-----05, 10, ---, 50, or 55  
-----01 to 60  
↓  
[PLOT]

(\* PLOT INTERVAL PRESET \*)

NO.1 : 5 MIN  
NO.2 : 10 MIN

THE RANGE FROM 5 SEC. TO 60 MIN.  
IS AVAILABLE FOR TIME PRESET.  
THE DATA LESS THAN 1 MIN. IS A  
MULTIPLE OF 5 SECONDS.

- NO.2 SELECTED -

■ \_ MIN \_ \_ SEC ?

## by DISTANCE

[MENU] [3]  
↓  
[1] [ENT].....for No. 1 Interval  
or  
[2] [ENT].....for No. 2 Interval  
↓  
[2] [ENT].....by DISTANCE.....→  
↓  
↓

(\* PLOT INTERVAL PRESET \*)

NO.1 : 5 MIN  
NO.2 : 10 MIN

THE VALUE FROM 0.01 N.M. TO  
9.99 N.M. IS ALLOWED IN THE CASE  
OF DISTANCE.

- NO.2 SELECTED -

■ \_ \_ N.M. ?



↓  
[ ] . [ ] [ ] n. miles [ENT]..... Enter an interval by mileage.  
↓  
[PLOT]

PARAMETER

---

## Erasing/displaying WAYPOINT MARK "+" INTENDED TRACK "-----"

---

When you enter a waypoint, the GP-1250 displays a small cross at the waypoint location on the plotter screen. Also, when you use the waypoint or routing navigation function, the GP-1250 connects the FROM and TO waypoints with a broken line. If you do not need these marks, you may suppress their display.

### Turning WAYPOINT MARK "+" on/off

[MENU] [4] [1] .....

(\* DISPLAY WPT MARKS ON/OFF \*)

NOW : 'ON'

TURN ON/OFF ?

1: ON

2: OFF

CHOOSE: \* ■ ?

[2] [ENT].....to erase the mark

or

[1] [ENT].....to display the mark

[PLOT]

### Turning INTENDED TRACK "-----" on/off

[MENU] [4] [2] .....

(\* DISPLAY COURSE ON/OFF \*)

NOW : 'ON'

TURN ON/OFF ?

1: ON

2: OFF

CHOOSE: \* ■ ?

↓  
[2] [ENT].....to erase the line  
or  
[1] [ENT].....to display the line  
↓  
[PLOT]

# GPS CORRECTIONS

**LATITUDE/LONGITUDE Correction**

See page 66.

**MAGNETIC Correction**

See page 67.

## SMOOTHING

When the PRESENT POSITION or SPEED/COURSE readings fluctuate randomly, you may stabilize them.

[MENU] [6] [3] .....

(\* SMOOTHING \*)

NOW : LAT/LON SMOOTHING = 0  
: SPEED SMOOTHING = 5

SMOOTHING IN 10 STEPS ( 0 TO 9 ).

LAT/LON SMOOTHING ■ ?

[ ] [ENT]..... Enter an index (0 to 9) for POSITION smoothing.

When the HDOP or receiving condition is unfavorable, the GPS fix fluctuates randomly. This fluctuation may be reduced by smoothing (averaging) the raw GPS fixes as illustrated below.

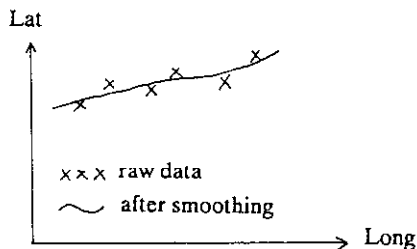

The higher the setting, the more smoothed are the raw data. If the setting is too high, the response of the latitude/longitude readings becomes slow. This phenomenon is notable when the ship's speed is high. For no smoothing, enter "0".

Usually use "0"; increase the setting if the GPS fix fluctuates intolerably.

↓  
 [ ] [ENT]..... Enter an index (0 to 9) for SPEED/COURSE smoothing.

During GPS position-fixing, ship's velocity (Speed/Course) is directly measured by receiving GPS satellites. The raw velocity data usually varies randomly depending on receiving condition, etc. This random variation may be reduced by smoothing (averaging) the raw data as illustrated below.

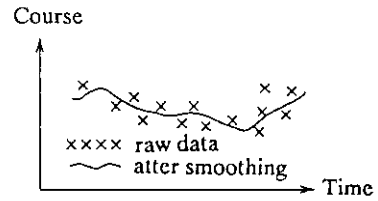
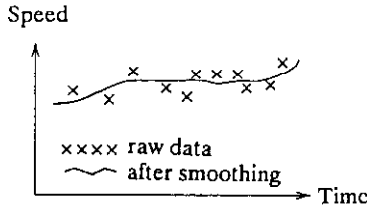

The higher the setting, the more smoothed are the raw data. If the setting is too high, the response of the speed/course readings becomes slow. For no smoothing, enter "0". Setting "5" is commonly used.

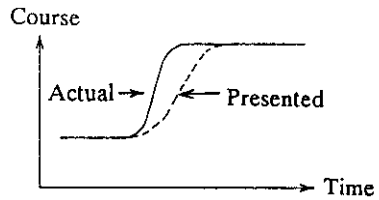
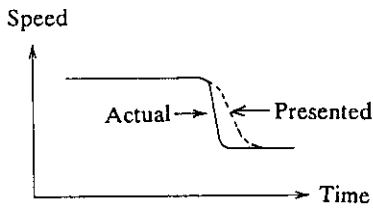

*NOTE: The course reading becomes unstable as ship's speed slows down. This is reasonable and can not be prevented. The setting should be adjusted when the boat is running at the normal speed.*

↓  
 [PLOT]

PARAMETER

## ANTENNA HEIGHT

[MENU] [6] [4] .....

```
(* ANTENNA HEIGHT *)
NOW :    0 M

RANGE : -999M TO 9999M.

ANTENNA HEIGHT:  █_ _ _ M ?
```

[ ] [ ] [ ] [ ] m [ENT] ..... Enter the antenna height above the sea level.

Measure the antenna height as accurately as possible because this setting affects GPS position fixing accuracy.

*NOTE: 1 foot = 0.3 meter*

[PLOT]

## HDOP THRESHOLD

HDOP varies as time elapses. While HDOP is better (lower) than the threshold, GPS position-fixing is performed. When HDOP becomes worse (higher) than the threshold, position information sent from the back-up navaid is used. You will learn in this section how to enter the HDOP threshold.

If the threshold is set low, GPS position-fixing is performed only when high accuracy is expected. Trade-off for a low HDOP threshold setting is short GPS position-fixing periods, e.g. long back-up periods.

Setting of 03 to 04 should be suitable for high accuracy GPS fix. Unless a back-up navaid is available, a higher setting, 10 or 20 for example, is preferable because GPS fix is obtainable for longer periods.

Call up the ALERT screen ([MON]) with various HDOP threshold settings, and you can see how GPS position-fixing periods are influenced. Note that it will take several minutes until the GP-1250 calculates/displays the ALERT based on the new HDOP threshold.

*NOTE 1. If the back-up function is disabled, GPS position-fixing is performed, regardless of the HDOP value, so long as 3 satellites are available in line of sight.*

*2. Relationship between HDOP value and error in distance is available on page 4.*

[MENU] [6] [5] .....

(\* HDOP THRESHOLD \*)  
NOW : 20  
  
RANGE : 01 TO 99.  
  
HDOP THRESHOLD : █- ?

[ ] [ ] [ENT] ..... Enter a HDOP threshold (01 to 99).

[PLOT]

PARAMETER

---

## Adjusting COMMUNICATION PORTS (NMEA/CIF)

---

### Turning BACK-UP function on/off

As explained on page 4, the GP-1250 is provided with a back-up function which switches automatically between the built-in GPS receiver and an external navaid tied to the EXT NAV connector.

You may turn on or off this function as follows.

- NOTE* 1. The default setting is OFF. If an external navaid is connected and you want to use it as a back-up navaid, turn the back-up function on.
2. Even when the back-up function is turned on, you may use the external navaid continually with the built-in GPS receiver entirely disabled. This feature is useful when the built-in GPS is defective and you want to use the GP-1250 in the plotter-only mode. See page 70 for further information.

*On the other hand, if the back-up navaid is failed, disable the back-up function. Your GP-1250 works in stand-alone mode.*

[MENU] [7] [1] .....

```
(* BACKUP NAVIGATION *)
BACKUP NAV. : 'OFF'
              : POSIT. CORRECT. OFF

SELECT NAVAID / FORMAT ON
[PORT 1 SETTING FOR EXT. NAV] SCREEN.

BACKUP NAVIGATION ON/OFF
1 : ON
2 : OFF
CHOOSE: # ■ ?
```

[1] [ENT].....to enable the BACK-UP function.

or

[2] [ENT].....to disable the BACK-UP function.



GPS POSIT.CORRECTION ON/OFF

1: ON  
2: OFF

CHOOSE: # ■ ?

[1] [ENT].....to enable GPS POSITION CORRECTION.

or

[2] [ENT].....to disable GPS POSITION CORRECTION.

Usually a constant difference exists between GPS and back-up fixes. This causes a jump of present position at the switching from GPS to the back-up navaid as illustrated below.

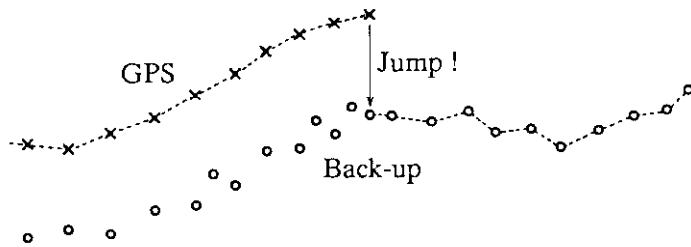

If the HDOP threshold is set low and the GPS fix is thought to be more reliable than the back-up fix, enter [1] ON. The back-up fix is corrected for better continuity from the GPS fix as illustrated below. Enter [0] OFF if you do not need such a correction.

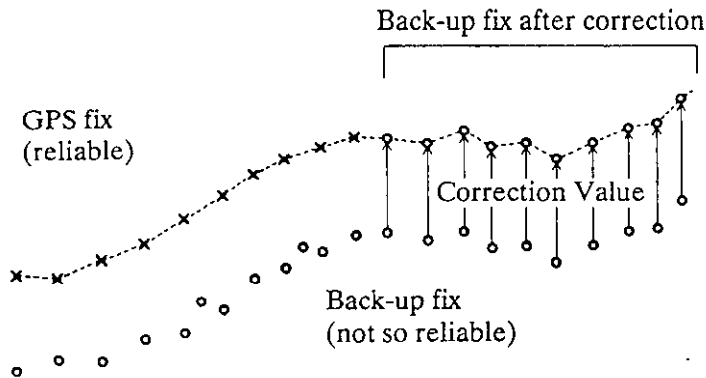

[PLOT]

PARAMETER

## Adjusting PORT1 (EXT NAV)

The EXT NAV is a receive-only-port. If an external navaid is connected, declare its specification.

[MENU] [7] [2] .....

```
(* PORT 1 SETTING FOR EXT.NAV *)
NOW : LORAN-C (FURUNO C1F)
PORT 1 IS INPUT PORT.
YOU MAY SELECT EITHER ONE OF BELOW.
0: LORAN-A FURUNO C1F
1: LORAN-C FURUNO C1F
2: NNSS FURUNO C1F
3: DECCA FURUNO C1F
4: GPS FURUNO C1F
5: LORAN-C NMEA 0183
6: NNSS NMEA 0183
7: DECCA NMEA 0183
8: GPS NMEA 0183
9: EXT.NAV NMEA 0183
CHOOSE: # █ ?
```

[ ] [ENT].....Select a desired combination of NAVAID and FORMAT, and enter its number.

*NOTE: "EXT.NAV" = Talker ID "IP"*

[PLOT]

**NOTE 1.** For the NMEA 0183 format, the GP-1250 receives the following sentences through the EXT NAV port.  
(These data are not received while the internal GPS receiver is active.)

```
LCGLL  DEGLL  TRGLL  GPGLL  IIGLL
LCVTG  DEVTG  TRVTG  GPVTG  IIVTG
**DBT  **MTW  (** may be an arbitrary talker ID)
```

2. To use the external navaid for back-up, enable the back-up function. See page M-27.
3. To use the GP-1250 as a plotter for the external navaid without using the built-in GPS receiver, see page 70.

## Adjusting PORT2 (OUTPUT)

The primary purpose of this port is to supply various nav. data to a color sounder, autopilot, etc. Though it is labeled "OUTPUT," it can receive water depth and temperature data to display them on the plotter screen. If any device is connected to the OUTPUT port, declare its specification.

[MENU] [7] [3] .....

```
(* PORT 2 SETTING *)  
  
NOW : INPUT = FURUNO CIF  
      : OUTPUT = FURUNO CIF  
  
PLEASE SELECT EACH OF BELOW.  
  
CHOOSE INPUT FORMAT  
1: INPUT FURUNO CIF  
2: INPUT NMEA 0183  
  
CHOOSE: # █ ?
```

Selecting a INPUT format

- [1] [ENT].....to select the FURUNO CIF format
- or
- [2] [ENT].....to select the NMEA 0183 format

```
(* PORT 2 SETTING *)  
  
NOW : INPUT = NMEA 0183  
      : OUTPUT = FURUNO CIF  
  
PLEASE SELECT EACH OF BELOW.  
  
CHOOSE OUTPUT FORMAT  
1: OUTPUT FURUNO CIF  
2: OUTPUT NMEA 0183  
3: OUTPUT NMEA 0180  
  
CHOOSE: # █ ?
```

Selecting a OUTPUT format

- [1] [ENT].....to select the FURUNO CIF format
- or
- [2] [ENT].....to select the NMEA 0183 format
- or
- [3] [ENT].....to select the NMEA 0180 format (for Autopilot only)

[PLOT]

PARAMETER

*NOTE 1. During the GPS position fixing period, the GP-1250 transmits data with the talker name GPS.*

*During the back-up period, the GP-1250 transmits the backup data with the talker name GPS. In this case the GP-1250 asserts an error flag in each sentence (such as XTE) in order to signal that the data is not from the GPS receiver.*

*The following sentences are transmitted from the OUTPUT port.*

*GPGLL GPVTG GPAAM GPWPL GPBOD GPBWC GPXTE  
GPDBT GPMTW GPRMB GPRMC GPZDA*

*If the external device does not accept GPS data, you may change the talker name. See the next page for further information.*

*If the GP-1250 is operated in the plotter-only mode as explained on page 70, the same sentences are output but with the talker name of the external navaid.*

*2. If NMEA 0183 is selected as an input format, the GP-1250 receives the following sentences:*

*\*\*MTW    \*\*DBT  
(\* may be an arbitrary talker ID.)*

## Changing a TALKER NAME

Because GPS is a recently developed system, some equipment can not receive GPS data. If this is the case, the GP-1250 can transmit all the sentences (GPS + Back Up) with a conventional talker name which the external equipment can accept.

[MENU] [7] [4] .....

```
(* TALKER NAME FOR OUTPUT DATA *)  
NOW : GPS  
  
SPECIFY TALKER NAME FOR GPS/BACK-  
UP DATA. (IN PLOTTER-ONLY MODE,  
EXT-NAV DATA IS BYPASSED WITH  
ORIGINAL TALKER NAME.)  
  
SELECT TALKER NAME.  
1 : GPS  
2 : LORAN-C  
3 : LORAN-A  
4 : NNSS  
5 : DECCA  
  
CHOOSE: # ■ ?
```

- [1] [ENT].....to transmit all data as GPS data  
or .....(Talker name unchanged)  
[2] [ENT].....to transmit all data as LORAN-C data  
or  
[3] [ENT].....to transmit all data as LORAN-A data  
or  
[4] [ENT].....to transmit all data as TRANSIT data  
or  
[5] [ENT].....to transmit all data as DECCA data

[PLOT]

PARAMETER

**A P P E N D I X**  
**\* \* \* \* \***

**(for technicians only)**

# INSTALLATION

---

## Mounting the DISPLAY UNIT

---

### Mounting Location

The display unit is carefully constructed to be able to withstand the humidity and corrosive atmosphere common in the marine environment, but it is not designed to be used outside, directly exposed to that environment. Salt water spray will most assuredly cause damage to the sensitive components inside. Keep these and the following factors in mind when planning the installation of the display unit.

**CAUTION**

*Furuno will assume no responsibility for the damage caused by exposure to either fresh or salt water.*

- 1) The display unit consumes very little power, so there is no need of forced air ventilation. However it is necessary to provide at least some circulation of cooling air by allowing sufficient space around the unit.
- 2) Many owners will undoubtedly use the GP-1250 on small boats, many with center consoles. The display unit must be mounted inside an enclosed cabinet, completely shielded from salt water spray, and from fresh water spray if the boat is usually hosed down after a day's outing. Most small center console boats are equipped with such an enclosed cabinet behind the wheel, and most have clear doors so that equipment may be seen behind them.
- 3) It is recommended to keep the display unit out of direct sunlight or at least shaded because of heat that can build up inside the cabinet.
- 4) Consideration should be made to provide space for access to the mounting hardware on the side and connectors behind the display unit. Also allow at least a foot or so of "service loop" in the cables to allow the unit to be pulled forward for servicing or internal adjustment.

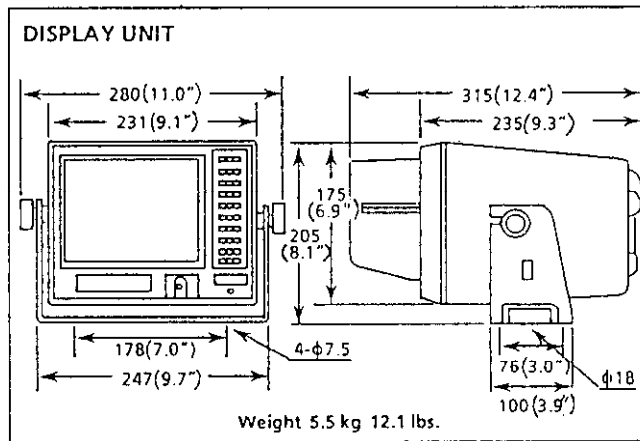

- 5) The display unit can be mounted on either a tabletop, bulkhead or overhead. Make sure that the selected location is strong enough to support the unit under the conditions of continued vibration or shock which will be normally encountered on the boat. If necessary, appropriate reinforcement measures should be taken in the mounting area.
- 6) The display unit should be mounted apart from equipment(s) emitting heat. Also, do not put thing(s) on the top of the unit.

### **Mounting Procedure**

The outline drawing is available on page D-1 at the end part of this manual. Mount the display unit as instructed below, using the mounting materials (ACCESSORIES) listed on page AP-21.

1. Mark the screw locations by using the bracket as a template.

As was stated before, make sure you allow enough clearance both to get to the connectors behind the unit and to allow you to get your hands in on both sides to loosen or tighten the mounting knobs. Make sure you leave at least a foot or so of "service loop" of cables behind the unit so that it can be pulled forward for servicing or easy removal of the connectors.

2. Drill four pilot holes for the bracket.
3. Install the bracket by using the screws supplied.
4. Fit knobs, rubber washer and knob washers to the display unit.
5. Install the display unit in the bracket. Tighten the knobs securely.



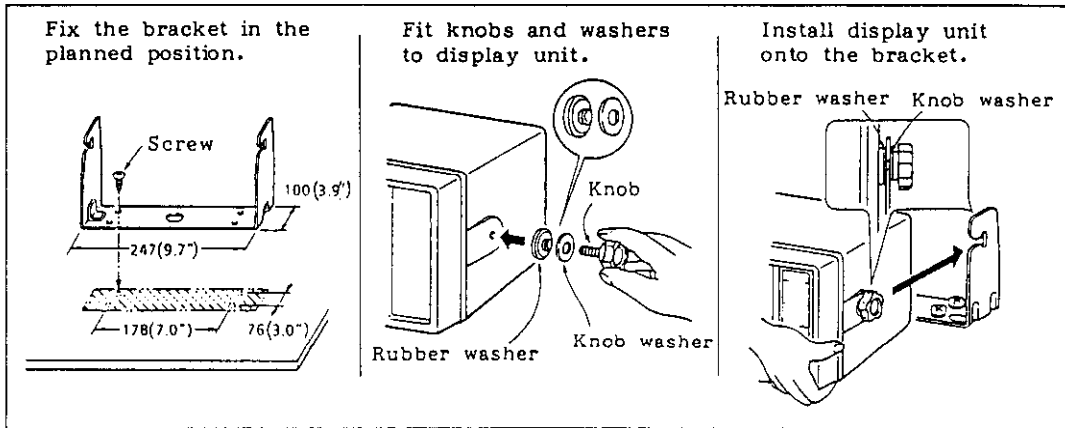

## Mounting the ANTENNA UNIT

### Mounting Location

When you install a TV antenna, you would normally select a place which provides the antenna with an unobstructed line-of-sight to broadcasting stations, usually a rooftop. However, even if there is an obstruction between the antenna and a broadcasting station, reception is possible to considerable extent since the radiowave used for TV can curve.

With the GPS antenna, however, you cannot expect reception without a clear line-of-sight between the antenna and the GPS satellites. This is because the radiowave used in the GPS system is a microwave, which propagates straightly.

Install the GPS antenna as high as possible, free from the influence of nearby funnels, masts, stacks, riggings, antennas, etc. If an object exists within line-of-sight to a GPS satellite, reception of a satellite with low elevation angle will be obstructed, resulting in long-lasting ACQ or INT condition. The frequency of GPS is 1575.42 MHz, which is far higher than SATNAV's 399.968 MHz. This means that you should be very careful about obstructions.

Frozen water spray heavily sticking to the antenna surface may interfere with reception. Locate the antenna where it will be free from water spray.

Locate the antenna where pitching and rolling effects are minimal, otherwise speed and course readings may be influenced. Mast-top mount is optimum for GPS reception, but is poor for measurement of speed and course.

When installing the GPS antenna, separate it from the other antennas. Select a place which satisfies the following limitations.

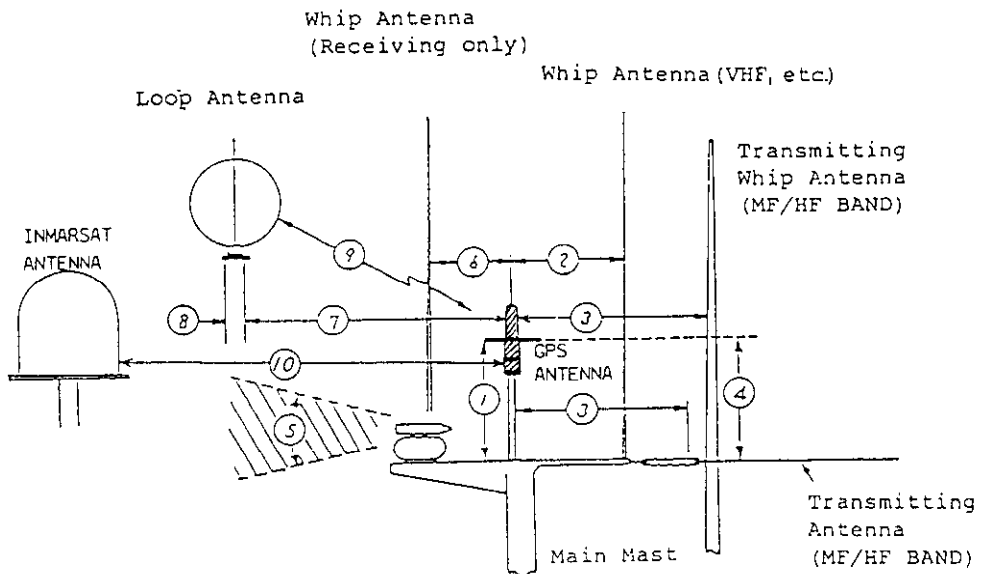

- ① More than 0.5m
- ② More than 1m (more than 2m preferable)
- ③ More than 4m
- ④ More than 1.5m
- ⑤ Do not place in the radar beam (usually 30 to 40°)
- ⑥ More than 1m
- ⑦ Distance depends on the diameter of the steel pole ⑧
  - More than 1.5m if ⑧ < 10cm
  - More than 3m if ⑧ > 30cm
- ⑨ More than 3m
- ⑩ More than 5m

**NOTE:** The requirements for GPS' antenna separation are not so restrictive as SATNAV's because the GPS employs a sophisticated communication system strong against interference. Nevertheless, you should separate the GPS antenna sufficiently from other antennas, particularly from a microwave antenna, such as INMARSAT's.

## Mounting Methods

Two mounting methods are available. For the outline drawing, see page D-2.

### CAUTION

*Do not use the antenna for GP-300 or GP-500. They are not equivalent to GP-1250's antenna electrically. (A different supply voltage is used!)*

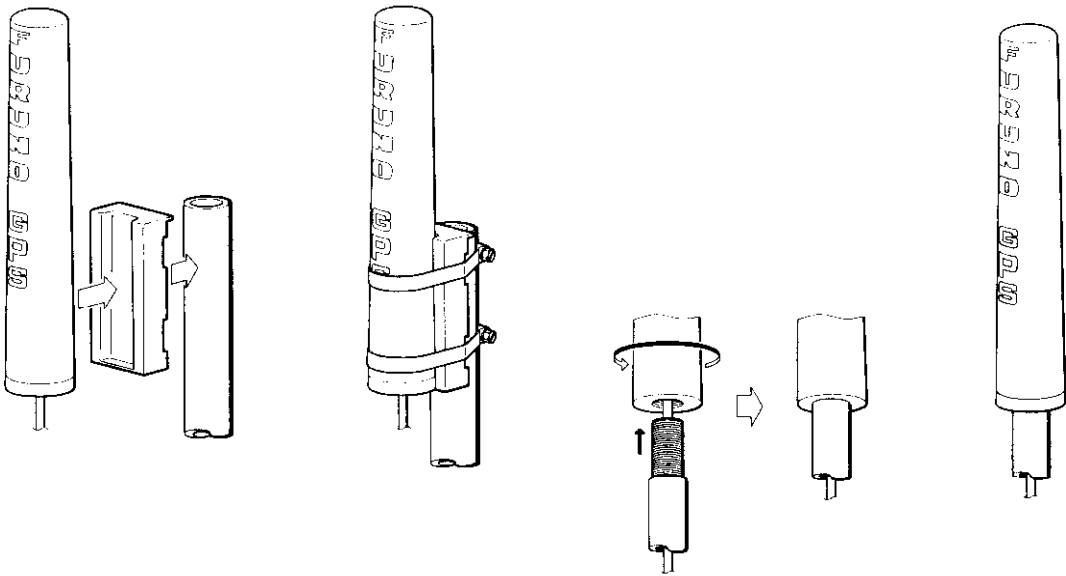

---

# CABLING

---

Cable connections to the GP-1250's display unit are made at the connectors located at the rear of the unit. The following illustration shows where to make the connections.

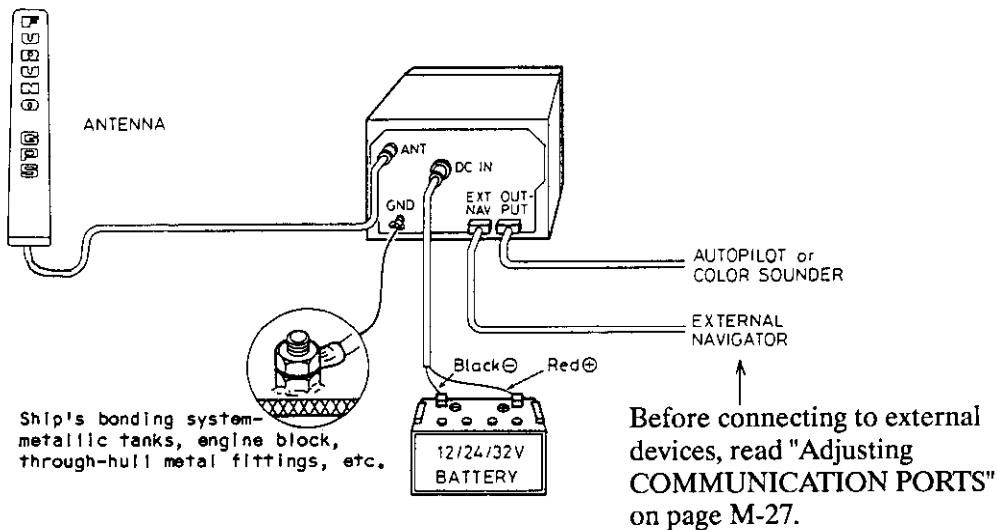

**DC IN** (11 to 40 Vdc 22 W max. 14 W in the ECONOMY mode)

Ship's power lines are notorious for being "dirty" electrically. The voltage can go all over the place as various heavy loads are placed on the line, and the power wiring is a prime source for interfering electrical signals (from such sources as alternators or generators, and other electronics equipment, like radars or echosounders.)

The GP-1250 is very forgiving machine since it has a built-in universal D.C. power supply that can take input voltages from 11 to 40 Vdc. However, a piece of gear of this quality deserves to have a circuit breaker dedicated to it alone. The size of the wire feeding power to the unit should be no less than AWG 16 gauge (0.75 mm square).

## How to suppress generator noise

Ship's generator (dynamo) is usually a serious noise source on most boats. Here is one method to suppress this type of noise.

### [Necessary Parts]

Electrolytic Capacitor --- 2200 uF, 50 WV

Film Capacitor ----- 4.7 uF, 400 WV

### [Procedure]

1. Solder the two capacitors and leads as illustrated below

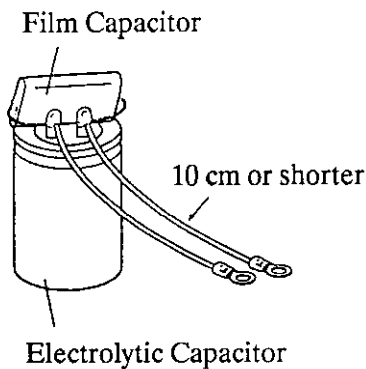

2. Insulate metallic parts with silicone compound in order to prevent shortcircuit due to bilge.

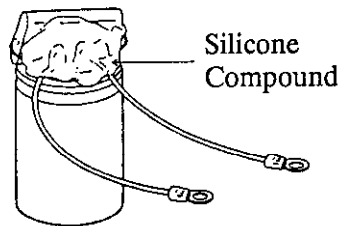

3. Connect the above assembly to the generator output. Connect it to the output terminal of the generator directly in order to suppress the noise efficiently.

*NOTE: Be careful about the polarity of the electrolytic capacitor.*



No less important for proper operation is the ground for the Display Unit. On a steel boat, a good connection to the hull is sufficient. On a wood or fiberglass boat, it is best to use a ground plate mounted on the hull exterior; if this is not practical the engine block can be used. Do not "share" ground leads that go to other equipment in the console, but instead run a separate heavy-duty wire for the GP-1250 alone.

## ANTenna

Connect the 15 m antenna cable here. If the cable is too long, you may leave the slack in cable looped. If the GP-1250 gives interference to an adjacent radio equipment, however, shorten the cable. In this case cut the cable at the display end, and solder the BNC connector (supplied) to it as follows.

UNIT = mm

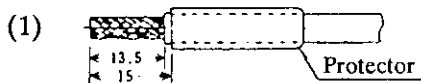

Remove the PVC sheath by 13.5 mm.

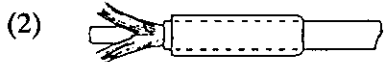

Separate the shielding mesh into two pieces as shown left.

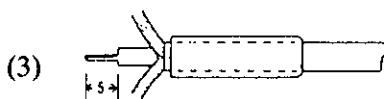

Remove the insulator by 5 mm.



Shape the two pieces of the mesh flat, and trim them as shown left.

- (5) You would see two soldering holes arranged on the inner shell. Insert the cable end into the inner shell while leading the two pieces of the mesh into the soldering holes through the slits. The 5 mm tip of the core lead should be inserted into the pin of the shell.

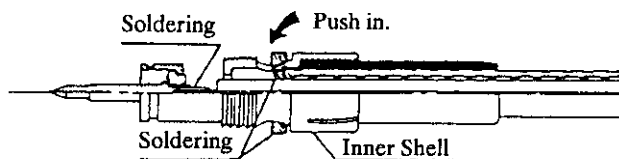

- (6) Screw the outer shell onto the inner shell which are soldered to the cable end. Couple the fixing nut to the outer shell.

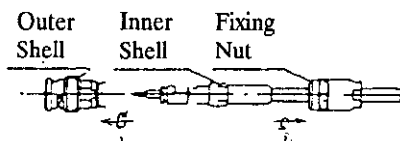

Using the 30/50 M CABLES (optional) (See the lists on pages AP-19 and AP-20.)

The 50m or 30m cable (8D-FBCV) can not be connected to the GP-1250 directly because the diameter is too large for the GP-1250 end connector. Shorten the cable to a suitable length. Solder the N-P-8DFB plug (included in the 30/50 M CABLE SET) to the cable end as instructed on the next page. Joint it to the 1 m connector- conversion cable which also comes with the 50m or 30m cable.

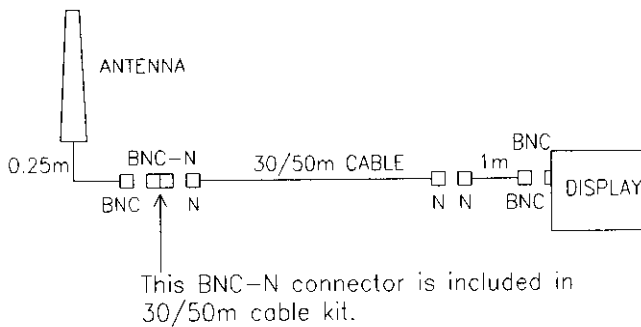

## How to attach N-P-8DFB Plug

Outer sheath

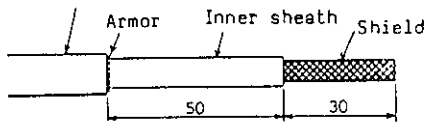

Remove the outer sheath, armor and inner sheath as specified left.

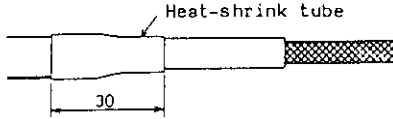

Insulate the armor with heat-shrink tube.

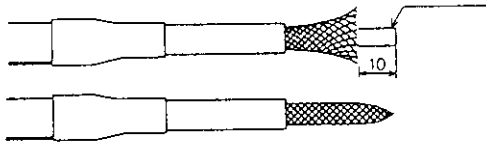

Cut off the insulator and inner conductor by 10 mm, and shape the shield as shown left.

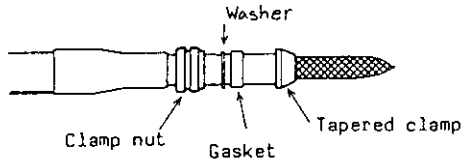

In order, pass the cable through the clamp nut, washer, gasket and tapered clamp.

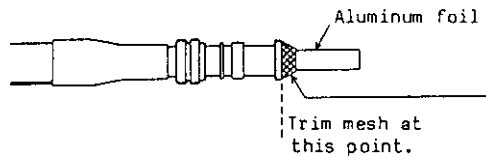

Fold back the shield mesh onto the tapered clamp and trim its end as shown left.

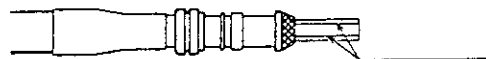

Cut the aluminum foil at four places (every 90 degrees).

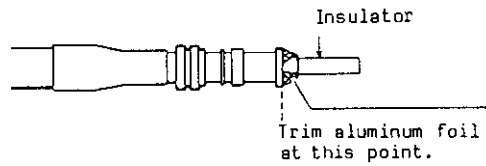

Fold back the four pieces of aluminum foil onto the mesh and trim them as shown left.



Cut out the insulator leaving 1 mm only.

Cut out the conductor, leaving 5 mm only.

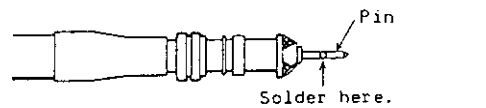

Insert the conductor into the connector pin, and solder them together through the hole in the connector pin.

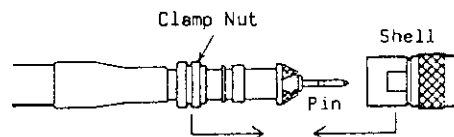

Insert the connector pin into the shell, and screw the clamp nut into the shell. (Turn the clamp nut only. NEVER TURN THE SHELL.)



**EXT NAV** (reception-only-port) (Diagram is available on Page S-1.)

Connect an external navaid (NMEA 0183 or FURUNO CIF) to this port.

*NOTE 1. Don't forget to strap a jumper between the #7 and #8 pins on this connector. At the power-on, the GP-1250 examines the jumper connection. Unless a jumper connection is detected, it does not receive data through this port.*

*2. If a external navaid requires a DSR input, couple it to its own DTR output. Otherwise, transmission is not initiated.*

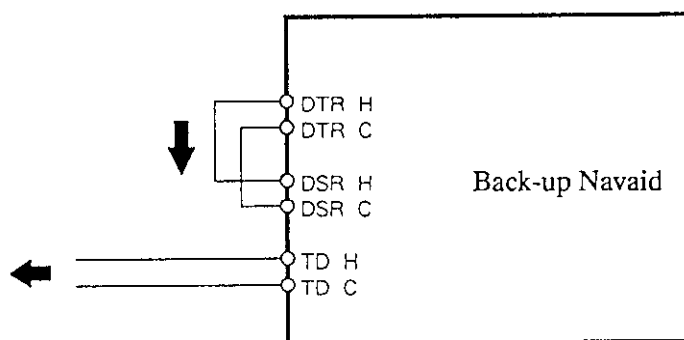

*3. To connect an RS232C equipment, see the next page.*

**OUTPUT** (transmission/reception port) (Diagram is available on Page S-2.)

Connect peripheral devices, such as color sounder, autopilot, etc. This port transmits navigational data, and receives water depth and temperature information.

Transmission : FURUNO CIF or NMEA 0183 or NMEA 0180

Reception : FURUNO CIF or NMEA 0183

*NOTE 1. Do not forget to strap a jumper between the #13 and #14 pins on this port. Otherwise, the GP-1250 will neither transmit nor receive data through this port.*

*2. If you want to receive data from an external device which requires a DSR input, connect the DSR to its own DTR output.*

*3. To connect an RS232C equipment, see the next page.*

---

## Modification for RS232C Interface

---

The EXT NAV and OUTPUT ports may be interfaced with an RS232C machine by adding the following modification.

*NOTE: This modification does not affect data sentences which are input or out from the GP-1250. Only the physical characteristics of the signal are changed from the 20mA current-loop to the voltage level which swings between positive and negative voltages.*

### Modification

- (1) Place the display unit on a tabletop upside down.
- (2) Remove the cabinet cover after loosening the four screws.

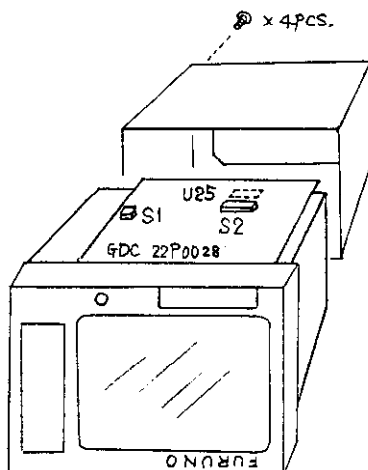

- (3) Find mark "U25" which is located by the jumper plug post S2 on the GDC (22P0028) board. Solder there the RS232C interface IC (LT1080, manufactured by LINEAR TECHNOLOGY, optionally available from Furuno as 0P22-3). We recommend you to solder it from the component side of the pcb because the chassis/panels must be disassembled to considerable extent to gain access to the soldering side. Soldering work should be carried out with the utmost care not to damage neighboring components. It is recommended to remove the jumper plugs from post S2 temporarily, and use a good soldering iron of 20 W or so and high-grade soldering lead. It is also important to clean the pins of the IC beforehand.

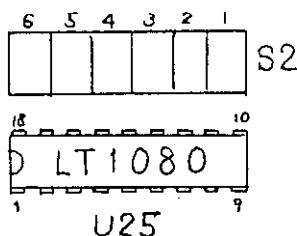

(4) Set the jumper plugs on post S2 on the GDC board (22P0028), and carry out wiring as instructed below.

**Case-1** EXT NAV/OUTPUT ports: RS232C

S2 plug	#1 ON	#2 ON	#3 ON	#4 off	#5 ON	#6 off
------------	----------	----------	----------	-----------	----------	-----------

S1 plug	#2 ON
------------	----------

GP-1250

Ext. machine

"EXT NAV"

"RS232C"

RXD4 ————— TXD  
 DTD 6 ————— DSR  
 GND 10 ————— GND  
 EPST 7 —————  
 GND 8 —————

"OUTPUT"

"RS232C"

TXD 2 ————— RXD  
 DSR 8 ————— DTR  
 GND 10 ————— DTR  
 OPST 13 —————  
 GND 14 —————

**Case-2** EXT NAV/OUTPUT ports: CURRENT LOOP (factory setting)

S2 plug	#1 off	#2 off	#3 off	#4 ON	#5 off	#6 ON
------------	-----------	-----------	-----------	----------	-----------	----------

S1 plug	#2 off
------------	-----------

---

## Replacing the MEMORY BACK-UP BATTERY

---

**CAUTION**

*Even if the machine is turned off, some circuits are kept "alive" by the back-up battery. Do not touch the circuits unless instructed below. Shortcircuit may result in defect of the component or loss of memory contents.*

- (1) After disconnecting the power cable, put the machine on the table upside down.
- (2) Loosen the four screws, and remove the cabinet cover.

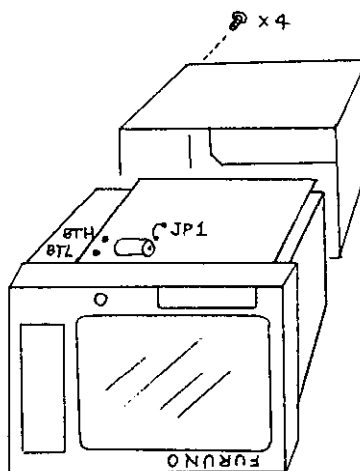

- (3) Measure the battery voltage between the "BTH" (+) and "BTL" (-) terminals on the GDC (22P0028) board. If the voltage is below 2.5 Vdc, replace the battery as instructed in the following steps. (Unless you mind loosing the memory contents, you may omit the steps with "\*" marks.)

Lithium Battery: CR2/3 8.L-080080A  
[000-119-969]  
Life = 3 years approx.

- \* (4) In order to hold the memory contents during the battery replacing work, temporarily connect a dry battery between the "BTH" (+) and "BTL" (-) terminals, using leads. (Any type battery may be used so long as the voltage is 3 to 5 Vdc.) (Be careful about the polarity.)
- \* (5) Cut jumper "JP1" on the same pc board.
- (6) Remove the battery fixing metal, and replace the existing lithium battery with a new one. (Be careful about the polarity.)

- \* (7) Reconnect jumper "JP1".
- \* (8) Remove the dry battery which was connected in step (4) for temporary back-up.
- (9) Fix the newly connected lithium battery with the fixing metal.
- (10) Turn the machine on, and confirm that the memory contents are not lost. See page M-10.

---

## Replacing ROM CHIPS

---

**CAUTION**

*Even if the machine is turned off, some circuits are kept "alive" by the back-up battery. Do not touch the circuits unless instructed below. Shortcircuit may result in defect of the component or loss of the memory contents.*

- (1) Put the machine on the table upside-down.
- (2) Loosen the four screws, and remove the cabinet cover.

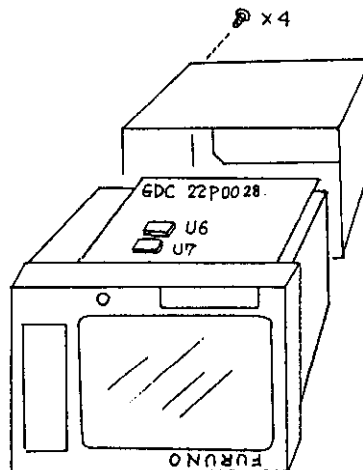

- (3) Extract the ROM chips (U6 and U7) from the GDC (22P0028) board by using an IC extractor.
- (4) After inserting the new ROM's into the sockets, fix them with a plastic tie.

Program Nos.

U6: 225-0112-1xx

U7: 225-0112-2xx

└— Version No.

- (5) Turn the machine on, and confirm that the memory contents are not lost. See page M-10.

# Maintenance Parts List for GP-1250

\* \* \* \* \*

Code	Name	Type	Note
000-040-663	Antenna Unit	GPA-014	
004-366-290	Printed Circuit Board	22P0030A AMP-NAV	
004-028-660	Printed Circuit Board	22P0031 SIG	
004-028-540	Printed Circuit Board	22P0028A GDC	Export Version
000-124-828	Keyboard Module	22S0238 KEY	Export Version Incl. Panel & Keyboard & PCB
004-029-010	Power Supply Module	22S0160 PWB	
000-111-844	CRT Module	MG750 SFR	PCB + CRT
100-082-333	CRT Filter	22-001-0122-3	

# PACKING LIST

GP-1250

20AE-X-9851-2



工事材料

INSTALLATION MATERIALS

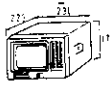
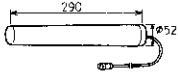



指示部用 CP20-00340

NAME	OUTLINE	DESCRIPTION/CODE No.	Q'TY
指示器 DISPLAY UNIT		GPR-014-( )	1
空中線部 ANTENNA UNIT		GPA-014 000-040-633	1

予備品  
SPARE PARTS

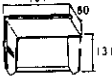
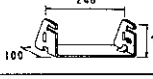
コネクタ CONNECTOR		XJ8A-0211 000-107-770	2
ヒューズ FUSE		FGMA 1.6A 125V (UL) 000-111-849	1
ミゼットヒューズ FUSE		FGMB 4A 125V (UL) 000-119-976	2

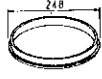
付属品  
ACCESSORIES

フード組品 HOOD ASSY. *3		22-001-0123-1 100-082-411	1
ハンガー組品 BRACKET ASSY.		FP20-00501 004-029-890	1
ノブボルト組品 KNOB BOLT ASSY.		FP20-00502 004-029-900	2
ガスケット GASKET		22-001-0202-1 100-082-401	1
⊕ナベタッピンUIネジ TAPPING SCREW		6 × 20 SUS304 000-800-414	4
ミガキ平座金 FLAT WASHER		M6 SUS304 000-864-129	4

\* 3のフードは、貿易向では下表のものに変わります。  
\* 3 FOOD ASSY. For export version is as shown below.

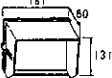
フード組品 HOOD ASSY.		FP22-00140 004-027-770	1
---------------------	---	---------------------------	---

\* 1, \* 2印の空中線部用工事材料は仕様により選択となります。  
\* 1, \* 2 Antenna materials are subject to selection according to the specification.

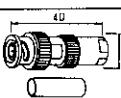
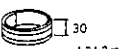

C4337-Z02-C

電源コード POWER CABLE		22S0019-2 000-109-000	1
コネクタ CONNECTOR		BNC-PI17NI 000-112-144	1
アース銅板 COPPER STRAP		04S40801 30×1200×0.3 000-572-187	1

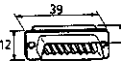
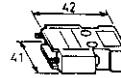
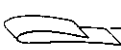

外部機器接続セット(1) CP20-00350

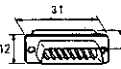
Dサブコネクタ D-SUB CONNECTOR		XM2A-1501 000-111-706	1
コネクタフード CONNECTOR HOUSING		XM2S-1513 000-118-820	1
EMIシールドテープ EMI-SHIELDED TAPE		FERREX 147φ *40CM* 000-835-089	1

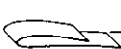

外部機器接続セット(2) CP20-00360

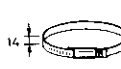
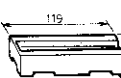
Dサブコネクタ D-SUB CONNECTOR		XM2A-0901 000-111-785	1
コネクタフード CONNECTOR HOUSING		XM2S-0913 000-121-148	1
EMIシールドテープ EMI-SHIELDED TAPE		FERREX 147φ *40CM* 000-835-089	1

\*1 空中線部用 CP20-00560

アンテナケーブル組品 ANTENNA CABLE ASSY.		BB-3DXV-L-15N 000-120-325	1
パーカクランプ HOSE CLAMP		5872 SUS 000-803-218	2
取付補助具 INSTALLING SPACER		20-005-3101 100-150-540	1
絶縁テープ SELF-BONDING TAPE		U7-7 0.5×19×5M 000-800-985	1
ビニルテープ NO.360 VINYL TAPE		0.2 × 19 × 10000 クロエドウ BLK 000-835-215	1

\*2 空中線部用 CP20-00560



アンテナケーブル組品 ANTENNA CABLE ASSY.		BB-3DXV-L-15N 000-120-325	1
絶縁テープ SELF-BONDING TAPE		U7-7 0.5×19×5M 000-800-985	1
ビニルテープ NO.360 VINYL TAPE		0.2 × 19 × 10000 クロエドウ BLK 000-835-215	1

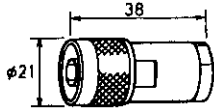
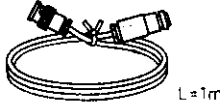
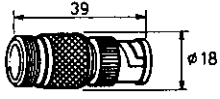
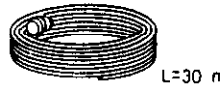

CODE No.	000-040-670	20AE-X-9401-2
TYPE	CP20-00600	

<b>工事材料表</b> INSTALLATION MATERIALS		GP-1250 GP-3000	GPSプロット GPS PLOTTER	
--	--	--------------------	------------------------	--

番号 No.	名称 NAME	略 図 OUTLINE	型名 / 規格 DESCRIPTIONS	数量 Q'TY	用途 / 備考 REMARKS
1	同軸コネクタ COAX. CONNCTOR		N-P-8DFB	1	
			CODE No.		
2	アンテナケーブル組品 ANTENNA CABLE ASSY.		NJBP-3DXV-1 (3D-XV *1M*)	1	
			CODE No.		
3	コネクタ CONNCTOR		NJ-BNCP-NI	1	
			CODE No.		
4	アンテナケーブル組品 ANTENNA CABLE ASSY.		8D-FBCV *30M*	1	
			CODE No.		
			CODE No.		
			CODE No.		
			CODE No.		
			CODE No.		
			CODE No.		

アンテナケーブルセット ANTENNA CABLE SET	図番 DWG. No.	C4337-M03-C	1/1
	検 図 CHECKED	  	

CODE No.	000-040-671	20AE-X-9402
TYPE	CP20-00610	

工事材料表 INSTALLATION MATERIALS		GP-1250	GPSプロッタ GPS PLOTTER	
---------------------------------	--	---------	------------------------	--

番号 No.	名称 NAME	略図 OUTLINE	型名 / 規格 DESCRIPTIONS	数量 Q'TY	用途 / 備考 REMARKS
-----------	------------	---------------	-------------------------	------------	--------------------

004-366-210  
CP20-00601

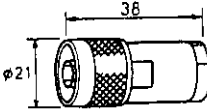
1	同軸コネクタ COAX. CONNCTOR		N-P-8DFB	1	
			CODE No. 000-111-549		

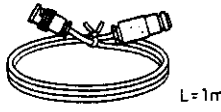
2	アンテナケーブル組品 ANTENNA CABLE ASSY.		NJBP-3DXV-1	1	
			CODE No. 000-117-602		

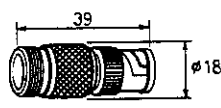
3	コネクタ CONNCTOR		NJ-BNCP-NI	1	
			CODE No. 000-123-810		

4	アンテナケーブル組品 ANTENNA CABLE ASSY.		8D-FBCV *50M*	1	
			CODE No. 000-111-599		

			CODE No.		

			CODE No.		

			CODE No.		

			CODE No.		

			CODE No.		

			CODE No.		

アンテナケーブルセット  
ANTENNA CABLE SET

図番 DWG. No.	C4337-M04-A	1/1
検図 CHECKED		

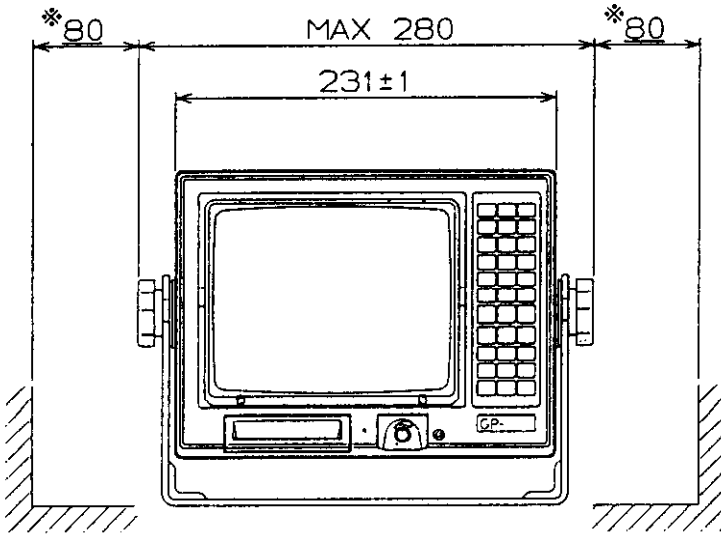
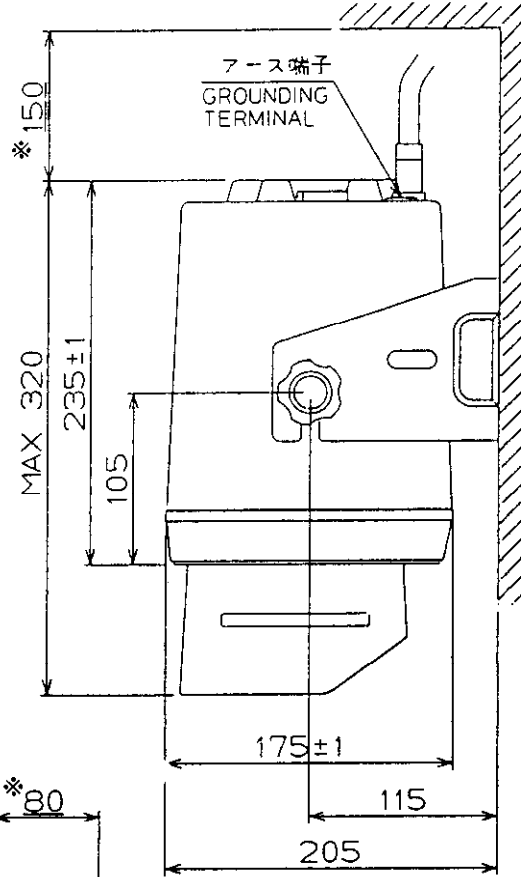
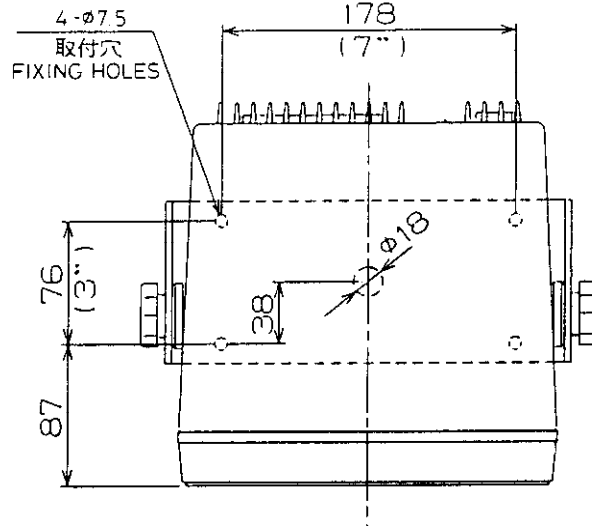

※ サービス空間  
RECOMENDED CLEARANCE

GP-1500/1250

品番 ITEM	品名 NAME	材質 MATERIAL	数量 Q'TY	図番 DWG. NO.	摘要 REMARKS
承認 APPROVED	FEB. 20. '90 T. NAKANO	三角法 THIRD ANGLE PROJECTION	名称 TITLE	指示器外觀図 DISPLAY UNIT	
検図 CHECKED	FEB. 20. '90 T. YUYAMA	尺度 SCALE	1/4		
製図 DRAWN	FEB. 20. '90 N. SAITO	重量 WEIGHT	約 5.5 kg	図番 DWG. NO.	C4337-G01-B

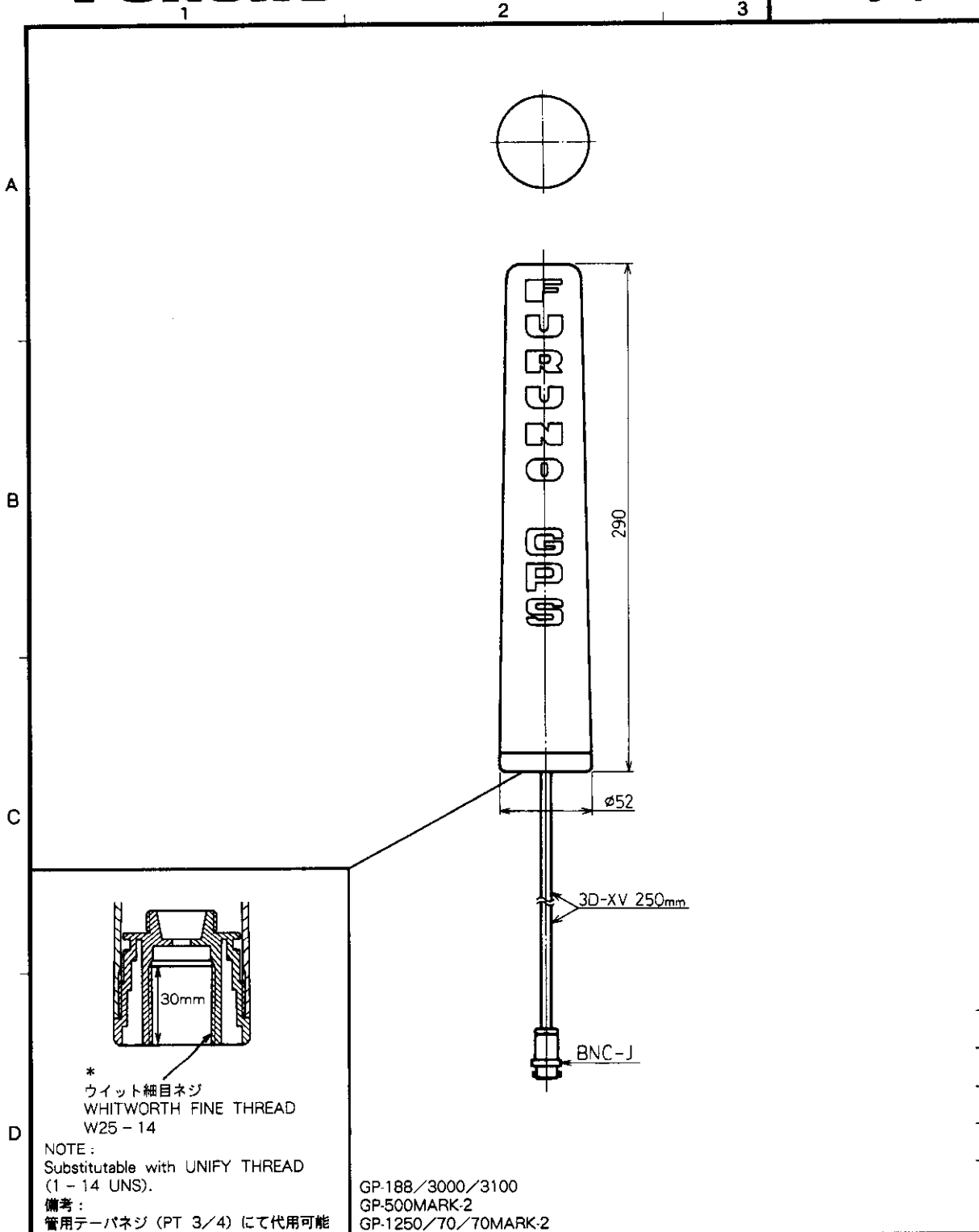

\*  
ウイット細目ネジ  
WHITWORTH FINE THREAD  
W25 - 14

NOTE:  
Substitutable with UNIFY THREAD  
(1 - 14 UNS).  
備考:  
管用テーパネジ (PT 3/4) にて代用可能

GP-188/3000/3100  
GP-500MARK-2  
GP-1250/70/70MARK-2

承認 APPROVED	June 4 '91 T. Nakano	三角法 THIRD ANGLE		名称 TITLE	空中線部 ANTENNA UNIT
検図 CHECKED	June 4 '91 N. Saito	尺度 SCALE	1/3	GPA-014	
製図 DRAWN	June 4 '91 S. Nishi	重量 WEIGHT	0.5 kg	図番 DWG.NO	C4344-G02-C

# CONNECTION OF EXTERNAL NAVIGATOR

Cable: CO-SPEVV-SB-C 0.2 x 5 P or 04S41670

Standard length = 5 m

Max. allowable length = 10 m

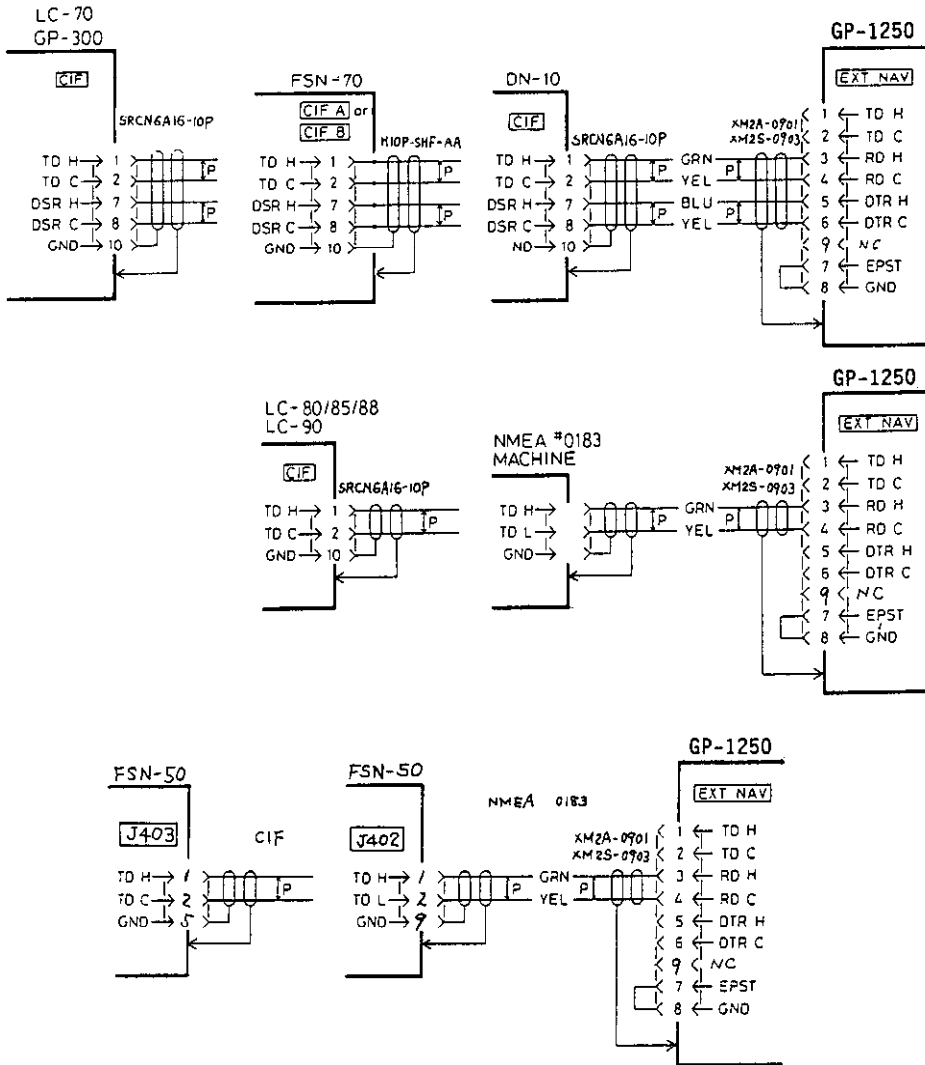

**NOTE:** 1. "OP22-2 Connection Kit" (optional) is required. This kit includes the plug for GP-1250 end only. Procure the cable separately.

2. Do not forget to strap a jumper between pin #7 and #8 on GP-1250.

3. Ground unused twisted pairs. Floating wire causes noise.

# CONNECTION OF AUTOPILOT & COLOR SOUNDER

## AUTOPILOTS

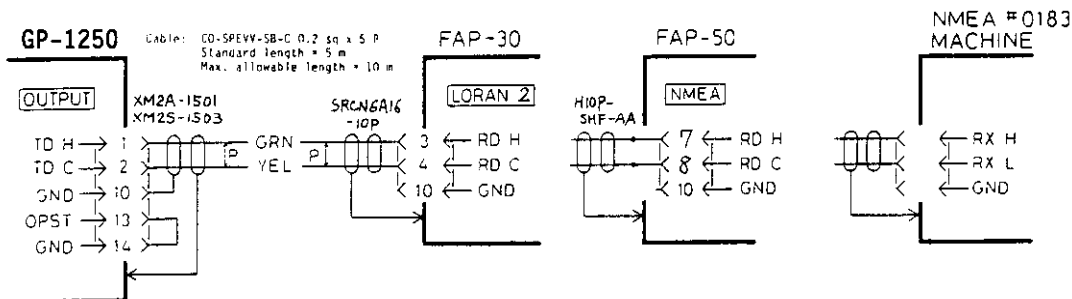

## COLOR SOUNDERS

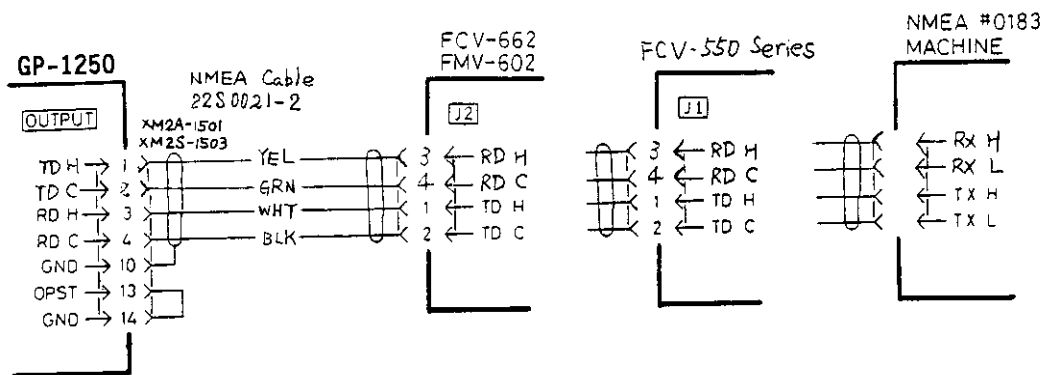

**NOTE 1.** The driving capability of this port is 20mA, and the number of the units connectable to this port varies depending on their input impedances. In the worst case where the input impedance is 500 ohm each (specified by NMEA 0183), max. two units may be parallel-driven. (HIGH level +4V specified by NMEA 0183 is ensured because the driving capability 20mA is greater than the total load 16mA (4V - 500 ohm × 2 units).

2. If the "OUTPUT" port is occupied by an auto pilot (NMEA 0180), no other device (NMEA 0183) may be additionally connected to this port even though the driving capability is large enough.

3. "OP22-1 Connection Kit" (optional) is required. This kit includes the plug for GP-1250 end only. Use the cable included in the options for the autopilot or color sounder.

4. Do not forget to strap a jumper between pin #13 and #14 on GP-1250.

5. Ground unused twisted pairs. Floating wire causes noise.

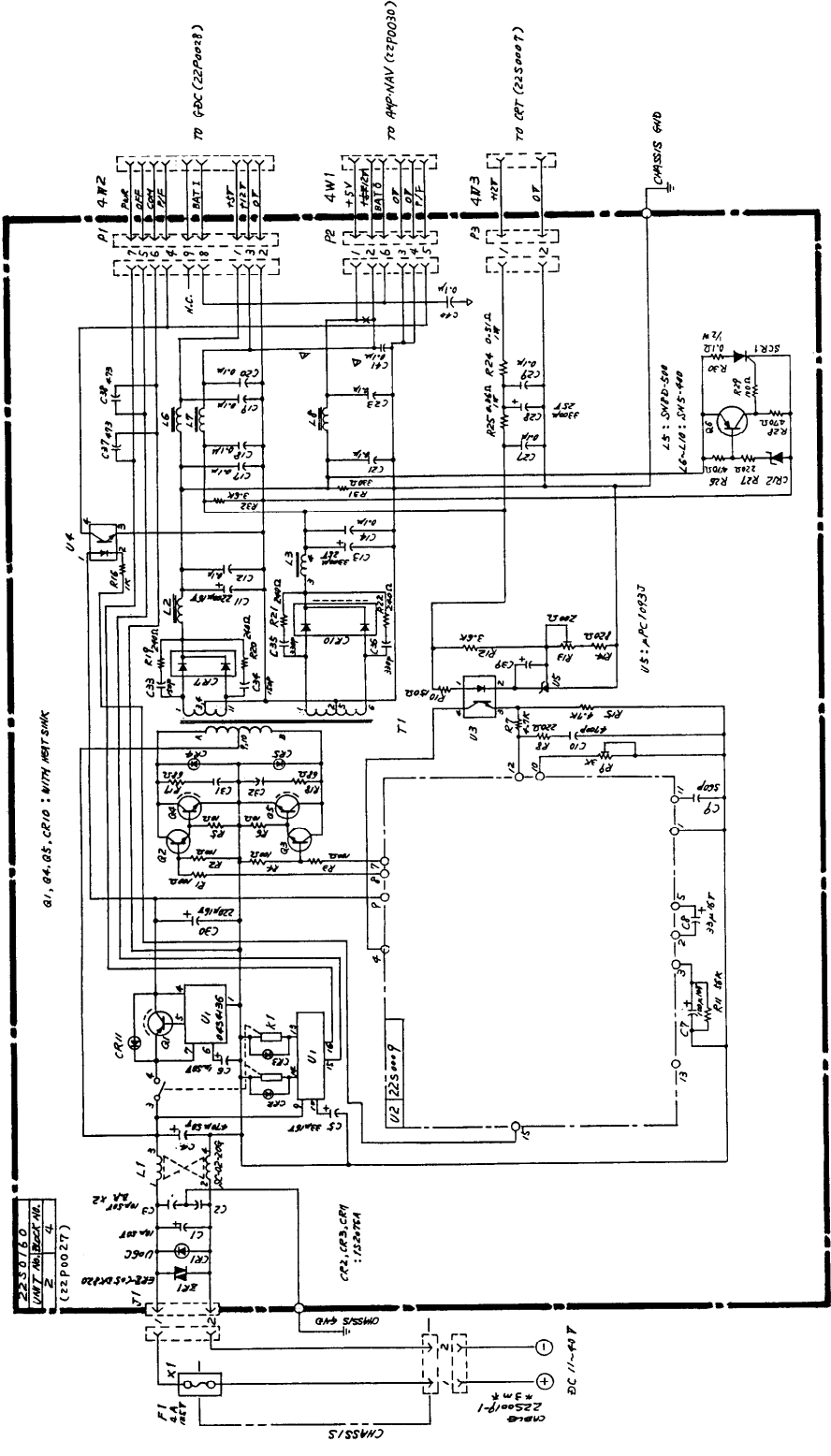

品番 ITEM	品名 NAME	材 質 MATERIAL	数 量 QTY	回 番 DWG.NO.	備 考 REMARKS
承認 APPROVED	ARC・13・70				
検 CHECKED	T. AKAZU				
製 DRAWN	APR・13・90				
	N. SAITO				
	APR・13・90				
	T. Yamada				
GP-1350					
GP-1500					
品名 TITLE	22P0027				
角 THIRD ANGLE PROJECTION	電源基板				
尺 SCALE	POWER SUPPLY BOARD				
重 WEIGHT					
回 DWG.NO.	C4337-K01-B				

FURUNO ELECTRIC CO., LTD.

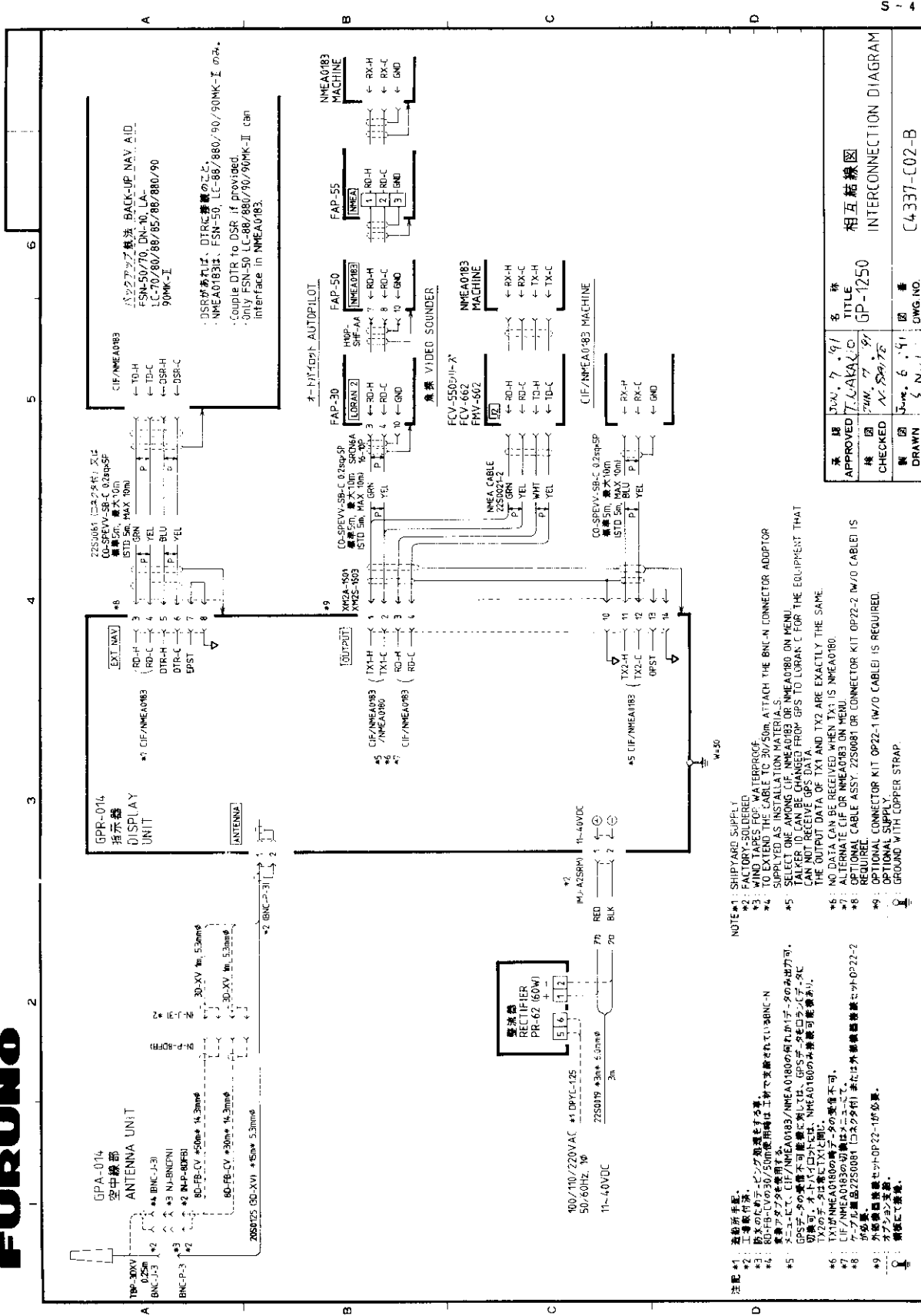

注記 \*1: 造船所指定。  
 \*2: 標準品として付属。  
 \*3: 標準品として付属。  
 \*4: 標準品として付属。  
 \*5: 標準品として付属。  
 \*6: 標準品として付属。  
 \*7: 標準品として付属。  
 \*8: 標準品として付属。  
 \*9: 標準品として付属。

NOTE \*1: SHIPYARD SUPPLY.  
 \*2: FACTORY SUPPLIED.  
 \*3: WIND TAPES FOR WATERPROOF.  
 \*4: TO EXTEND THE CABLE TO 30/50m ATTACH THE BNC-IN CONNECTOR ADAPTOR SUPPLIED AS INSTALLATION MATERIALS.  
 \*5: SELECT ONE AMONG CIF/NMEA0183 OR NMEA0180 ON MENU TALKER ID CAN BE CHANGED FROM GPS TO LORAN C FOR THE EQUIPMENT THAT CAN OUTPUT LORAN C TX AND TX2 ARE EXACTLY THE SAME.  
 \*6: NO DATA CAN BE RECEIVED WHEN TX1 IS NMEA0180.  
 \*7: ALTERNATE CUF OR NMEA0183 ON MENU.  
 \*8: OPTIONAL CABLE ASSY. Z250081 OR CONNECTOR KIT OP22-2 (W/O CABLE) IS REQUIRED.  
 \*9: OPTIONAL SUPPLY.  
 \*10: GROUND WITH COPPER STRAP.

承認	2007.7.9	名称	
検閲	2007.7.9	TITLE	相互接続図
CHECKED	N. Saito		INTERCONNECTION DIAGRAM
製図	2007.6.9	図番	C4337-C02-B
DRAWN			



# ABC INDEX

\* \* \* \* \*

<p><b>[A]</b> ACQ.....24  ALERT.....8  all memory clear..... M-4  ALM.....24  Almanac..... 5, 8, 24, M-6  ANTENNA HEIGHT..... M-25  arrival alarm.....45, 50  ARV.....50</p> <p><b>[B]</b> back-up navaid..... 4, 25, M-27  battery..... M-8  bearing.....38, 40  BDR.....50  border alarm.....52</p> <p><b>[C]</b> CHART.....7, 63  chart scale.....13, 15  CLEAR DATA..... M-4  COLD START..... 24, M-6  correction..... 66, M-28  course (heading)..... 10, 37, 40  cross cursor.....13, 16  cross-track error.....36  cross-track error alarm.....37, 51  cursor.....13, 16  C-ST..... 24, M-6</p> <p><b>[D]</b> DATE, TIME &amp; LOCAL ZONE  TIME..... M-16  DECC.....70  DISABLE SATELLITE..... M-1  Distance-To-Go (range).....38, 40</p> <p><b>[E]</b> ECONOMY.....12  event mark..... 18, 53, 58  E.GPS.....70  E. NAV.....70</p> <p><b>[F]</b> FROM WPT..... 34, 40, 41</p>	<p><b>[G]</b> GPS..... 1  GPS position correction..... M-28  GPS-DC.....25  GPS-DR.....25  GPS-LA.....25  GPS-LC.....25  GPS-OM.....25</p> <p><b>[H]</b> HALT.....22  HDOP.....4, 8, 10, 24  HDOP threshold..... 4, 8, 24, M-25</p> <p><b>[I]</b> IMP.....24  INITIAL LAT/LON SETTING..M-15  INT.....24  intended track.....36, 41  I.GPS.....70</p> <p><b>[L]</b> LAT/LON CORRECTION.....66  LRN-A.....70  LRN-C.....70</p> <p><b>[M]</b> MAGNETIC VARIATION.....66  memory clear.....M-4  memory partition.....53</p> <p><b>[N]</b> NAV.....40  NAV-ERR.....25, 70  NNSS.....70</p> <p><b>[O]</b> overlay.....55</p> <p><b>[P]</b> parameter..... M-5, M-14  plotting interval..... 53, 69, M-19</p> <p><b>[R]</b> RAM card.....56  range (Distance-To-Go).....38, 40  RCV-ERR.....25, 70  ROM card.....7, 63  route.....40, 42</p>
---	---

<b>[S]</b>	scale .....	13, 15
	SELF TEST .....	M-2
	SIG-ERR .....	25, 70
	SMOOTHING .....	M-23
	speed.....	10, 38, 40
	STARTUP STATUS.....	7, M-10, M-11
<b>[T]</b>	Time-To-Go.....	38, 40
	TO WPT.....	34, 40, 41
	TTG .....	38, 40
	track line.....	22, 53, 54, 58, 69, M-19
	true bearing.....	68
<b>[V]</b>	Velocity-To-Distination .....	38, 40
<b>[W]</b>	waypoint .....	29, 61
<b>[X]</b>	XTE .....	37, 50
<b>[others]</b>	2-D.....	24, 25
	+ .....	31
	+ .....	13