

Dell™ Latitude™ D430

# User's Guide

**Model PP09S**

For information on other documentation included with your computer, see "Finding Information" on page 11.

## Notes, Notices, and Cautions



**NOTE:** A NOTE indicates important information that helps you make better use of your computer.



**NOTICE:** A NOTICE indicates either potential damage to hardware or loss of data and tells you how to avoid the problem.



**CAUTION:** A CAUTION indicates a potential for property damage, personal injury, or death.

## Abbreviations and Acronyms

For a complete list of abbreviations and acronyms, see "Glossary" on page 139.

If you purchased a Dell™ n Series computer, any references in this document to Microsoft® Windows® operating systems are not applicable.

---

**Information in this document is subject to change without notice.**

**© 2007–2008 Dell Inc. All rights reserved.**

Reproduction in any manner whatsoever without the written permission of Dell Inc. is strictly forbidden.

Trademarks used in this text: *Dell*, the *DELL* logo, *Latitude*, *Wi-Fi Catcher*, *ExpressCharge*, and *Undock & Go* are trademarks of Dell Inc.; *Core* is a trademark and *Intel* is a registered trademark of Intel Corporation; *Microsoft*, *Outlook*, *Windows*, *Vista*, *TravelLite*, and *Touch Strip* are registered trademarks of Microsoft Corporation; *Bluetooth* is a registered trademark owned by Bluetooth SIG, Inc. and is used by Dell under license; *EMC* is a registered trademark of EMC Corporation; *ENERGY STAR* is a registered trademark of the U.S. Environmental Protection Agency. As an ENERGY STAR partner, Dell Inc. has determined that this product meets the ENERGY STAR guidelines for energy efficiency.

Other trademarks and trade names may be used in this document to refer to either the entities claiming the marks and names or their products. Dell Inc. disclaims any proprietary interest in trademarks and trade names other than its own.

**Model PP09S**

**May 2008**

**P/N XK022 Rev. A03**

# Contents

1	Finding Information	
2	About Your Computer	
	<b>Front View</b> . . . . .	15
	<b>Left Side View</b> . . . . .	18
	<b>Right Side View</b> . . . . .	19
	<b>Back View</b> . . . . .	20
	<b>Bottom View</b> . . . . .	22
3	Transferring Information to a New Computer	
	<b>Microsoft® Windows® XP</b> . . . . .	25
	<b>Microsoft Windows Vista®</b> . . . . .	27
4	Using a Battery	
	<b>Battery Performance</b> . . . . .	29
	<b>Checking the Battery Charge</b> . . . . .	30
	Dell™ QuickSet Battery Meter . . . . .	30
	Microsoft® Windows® Power Meter . . . . .	30
	Charge Gauge . . . . .	30
	Low-Battery Warning . . . . .	31
	<b>Conserving Battery Power</b> . . . . .	31
	<b>Power Management Modes</b> . . . . .	31
	Standby and Sleep Mode . . . . .	31
	Hibernate Mode . . . . .	32
	<b>Configuring Power Management Settings</b> . . . . .	33
	<b>Accessing Power Options Properties</b> . . . . .	33

<b>Charging the Battery</b> . . . . .	<b>33</b>
<b>Replacing the Battery</b> . . . . .	<b>33</b>
<b>Storing a Battery</b> . . . . .	<b>34</b>

## 5 Using the Keyboard and Touch Pad

<b>Numeric Keypad</b> . . . . .	<b>35</b>
<b>Key Combinations</b> . . . . .	<b>35</b>
System Functions . . . . .	35
Battery . . . . .	36
Optical Drive Tray . . . . .	36
Display Functions . . . . .	36
Power Management . . . . .	36
Speaker Functions . . . . .	36
Microsoft® Windows® Logo Key Functions. . . . .	37
<b>Touch Pad</b> . . . . .	<b>37</b>
<b>Fingerprint Reader (optional)</b> . . . . .	<b>39</b>
Customizing the Touch Pad and Track Stick . . . . .	39
<b>Changing the Track Stick Cap</b> . . . . .	<b>39</b>

## 6 Using the Display

<b>Adjusting Brightness</b> . . . . .	<b>41</b>
<b>Switching the Video Image From Your Computer Display to a Projector</b> . . . . .	<b>41</b>
<b>Making Images and Text Look Bigger or Sharper on the Screen: Setting Display Resolution and Refresh Rate</b> . . . . .	<b>41</b>
Microsoft® Windows® XP . . . . .	42
Microsoft Windows Vista®. . . . .	42
<b>Using an External Monitor Simultaneously as an Extension of Your Computer Display</b>	<b>43</b>
Microsoft® Windows® XP . . . . .	43
Microsoft Windows Vista®. . . . .	43
<b>Using an External Monitor as Your Primary Display: Swapping Primary and Secondary Displays</b> . . . . .	<b>44</b>
Microsoft® Windows® XP . . . . .	44

Microsoft Windows Vista® . . . . .	44
------------------------------------	----

## 7 Setting Up and Using Networks

<b>Connecting a Network or Broadband Modem Cable . . . . .</b>	<b>45</b>
<b>Setting Up a Network in the Microsoft® Windows® XP Operating System . . . . .</b>	<b>46</b>
<b>Setting Up a Network in the Microsoft Windows Vista® Operating System . . . . .</b>	<b>46</b>
<b>Wireless Local Area Network . . . . .</b>	<b>47</b>
What You Need to Establish a WLAN Connection . . . . .	47
Checking Your Wireless Network Card. . . . .	47
Setting Up a New WLAN Using a Wireless Router and a Broadband Modem . . . . .	48
Connecting to a WLAN . . . . .	49
<b>Mobile Broadband (or Wireless Wide Area Network) . . . . .</b>	<b>51</b>
What You Need to Establish a Mobile Broadband Network Connection . . . . .	51
Checking Your Dell Mobile Broadband Card . . . . .	51
Connecting to a Mobile Broadband Network . . . . .	52
Managing Your Network Settings Through the Dell QuickSet Location Profiler . . . . .	53
<b>Dell Wi-Fi Catcher™ Network Locator . . . . .</b>	<b>53</b>
<b>Microsoft® Windows® Firewall . . . . .</b>	<b>53</b>

## 8 Using Cards

<b>Card Types . . . . .</b>	<b>55</b>
<b>Card Blanks . . . . .</b>	<b>56</b>
<b>PC Cards . . . . .</b>	<b>56</b>
PC Card Blanks . . . . .	56
Extended PC Cards . . . . .	56
<b>Installing a PC Card or an ExpressCard . . . . .</b>	<b>56</b>
Removing a PC Card or Blank. . . . .	58
<b>Installing or Removing a Secure Digital (SD) Card . . . . .</b>	<b>59</b>
<b>Extended Cards. . . . .</b>	<b>60</b>

## 9 Securing Your Computer

<b>Security Cable Lock</b> . . . . .	<b>61</b>
<b>Smart Card</b> . . . . .	<b>61</b>
About Smart Cards . . . . .	61
Installing a Smart Card . . . . .	62
<b>Passwords</b> . . . . .	<b>63</b>
Using a Primary (or System) Password. . . . .	64
Using an Administrator Password . . . . .	64
Using a Hard Drive Password . . . . .	64
<b>Trusted Platform Module (TPM)</b> . . . . .	<b>65</b>
Enabling the TPM Feature . . . . .	65
<b>Security Management Software.</b> . . . . .	<b>66</b>
Using the Security Management Software. . . . .	66
<b>Computer Tracking Software</b> . . . . .	<b>66</b>
<b>If Your Computer Is Lost or Stolen</b> . . . . .	<b>66</b>

## 10 Cleaning Your Computer

<b>Computer, Keyboard, and Display</b> . . . . .	<b>69</b>
<b>Touch Pad</b> . . . . .	<b>69</b>
<b>Floppy Drive</b> . . . . .	<b>69</b>
<b>Optical Disks</b> . . . . .	<b>70</b>

## 11 Troubleshooting

<b>Dell Technical Update Service</b> . . . . .	<b>71</b>
<b>Dell Diagnostics</b> . . . . .	<b>71</b>
When to Use the Dell Diagnostics . . . . .	71
Starting the Dell Diagnostics From Your Hard Drive . . . . .	71
Starting the Dell Diagnostics From the Drivers and Utilities media . . . . .	72
Dell Diagnostics Main Menu . . . . .	72
<b>Dell Support Utility</b> . . . . .	<b>74</b>
Accessing the Dell Support Utility . . . . .	74

Clicking the Dell Support Icon . . . . .	74
Double-Clicking the Dell Support Icon . . . . .	75
<b>Drive Problems . . . . .</b>	<b>75</b>
Optical drive problems . . . . .	76
Hard drive problems . . . . .	76
<b>E-Mail, Modem, and Internet Problems . . . . .</b>	<b>77</b>
<b>Error Messages . . . . .</b>	<b>78</b>
<b>IEEE 1394 Device Problems . . . . .</b>	<b>81</b>
<b>Keyboard Problems . . . . .</b>	<b>81</b>
External Keyboard problems . . . . .	82
Unexpected characters. . . . .	82
<b>Lockups and Software Problems . . . . .</b>	<b>82</b>
The computer does not start up . . . . .	83
The computer stops responding . . . . .	83
A program stops responding or crashes repeatedly . . . . .	83
A program is designed for an earlier Microsoft® Windows® operating system . . . . .	83
A solid blue screen appears . . . . .	83
Other software problems . . . . .	83
<b>Memory Problems . . . . .</b>	<b>84</b>
<b>Network Problems . . . . .</b>	<b>84</b>
General . . . . .	84
<b>PC Card or ExpressCard Problems. . . . .</b>	<b>85</b>
<b>Power Problems . . . . .</b>	<b>85</b>
Ensuring Sufficient Power for Your Computer . . . . .	86
Docking Power Considerations. . . . .	86
<b>Printer Problems . . . . .</b>	<b>87</b>
<b>Scanner Problems . . . . .</b>	<b>87</b>
<b>Sound and Speaker Problems . . . . .</b>	<b>88</b>
No sound from integrated speakers . . . . .	88
No sound from external speakers . . . . .	88
No sound from headphones . . . . .	88
<b>Touch Pad or Mouse Problems . . . . .</b>	<b>88</b>
<b>Video and Display Problems. . . . .</b>	<b>89</b>

If the display is blank . . . . .	89
If the display is difficult to read . . . . .	90
If only part of the display is readable . . . . .	90

## 12 System Setup Program

<b>Overview</b> . . . . .	<b>91</b>
<b>Viewing the System Setup Screens</b> . . . . .	<b>91</b>
<b>System Setup Screens</b> . . . . .	<b>92</b>
<b>Commonly Used Options</b> . . . . .	<b>92</b>
Changing the Boot Sequence . . . . .	92
Changing COM Ports . . . . .	93

## 13 Reinstalling Software

<b>Drivers</b> . . . . .	<b>95</b>
What Is a Driver? . . . . .	95
Identifying Drivers . . . . .	95
Reinstalling Drivers and Utilities . . . . .	96
<b>Troubleshooting Software and Hardware Problems in the Microsoft® Windows® XP and Microsoft Windows Vista® Operating Systems</b> . . . . .	<b>98</b>
<b>Restoring Your Operating System</b> . . . . .	<b>98</b>
Using Microsoft® Windows® System Restore . . . . .	99
Using the Operating System CD . . . . .	101

## 14 Adding and Replacing Parts

<b>Before You Begin</b> . . . . .	<b>103</b>
Recommended Tools . . . . .	103
Turning Off Your Computer . . . . .	103
Before Working Inside Your Computer . . . . .	104
<b>Hard Drive</b> . . . . .	<b>105</b>
Removing the Hard Drive . . . . .	106
Replacing the Hard Drive . . . . .	108
<b>Memory</b> . . . . .	<b>108</b>



<b>Keyboard</b> . . . . .	<b>110</b>
<b>Hinge Cover</b> . . . . .	<b>112</b>
<b>Mini-Cards</b> . . . . .	<b>113</b>
Wireless Local Area Network (WLAN) Cards . . . . .	113
Mobile Broadband (WWAN) Cards . . . . .	115
<b>Subscriber Identity Module (SIM) Card</b> . . . . .	<b>117</b>
<b>Internal Card With Bluetooth® Wireless Technology</b> . . . . .	<b>117</b>
<b>Coin-Cell Battery</b> . . . . .	<b>118</b>

## 15 Dell™ QuickSet

## 16 Traveling With Your Computer

<b>Identifying Your Computer</b> . . . . .	<b>123</b>
<b>Packing the Computer</b> . . . . .	<b>123</b>
<b>Travel Tips</b> . . . . .	<b>124</b>
Traveling by Air . . . . .	124

## 17 Getting Help

<b>Obtaining Assistance</b> . . . . .	<b>125</b>
Technical Support and Customer Service . . . . .	125
DellConnect . . . . .	126
Online Services . . . . .	126
AutoTech Service . . . . .	127
Automated Order-Status Service . . . . .	127
<b>Problems With Your Order</b> . . . . .	<b>127</b>
<b>Product Information</b> . . . . .	<b>127</b>
<b>Returning Items for Warranty Repair or Credit</b> . . . . .	<b>127</b>
<b>Before You Call</b> . . . . .	<b>128</b>
<b>Contacting Dell</b> . . . . .	<b>128</b>

## 18 Specifications

Glossary . . . . .	139
Appendix . . . . .	149
<b>FCC Notice (U.S. Only)</b> . . . . .	<b>149</b>
FCC Class B . . . . .	149
<b>Macrovision Product Notice.</b> . . . . .	<b>150</b>

## Finding Information

 **NOTE:** Some features or media may be optional and may not ship with your computer. Some features or media may not be available in certain countries.

 **NOTE:** Additional information may ship with your computer.

What Are You Looking For?	Find It Here
<ul style="list-style-type: none"> <li>• A diagnostic program for my computer</li> <li>• Drivers for my computer</li> <li>• Notebook System Software (NSS)</li> </ul>	<p><b>Drivers and Utilities Media</b></p> <p><b>NOTE:</b> The <i>Drivers and Utilities</i> media may be optional and may not ship with your computer.</p> <p>Documentation and drivers are already installed on your computer. You can use the media to reinstall drivers (see <i>Drivers and Utilities</i> media) or to run the Dell Diagnostics (see "Dell Diagnostics" on page 71).</p> <div data-bbox="739 800 1005 1065" data-label="Image"> </div> <p>Readme files may be included on your media to provide up-to-the-minute updates about technical changes to your computer or advanced technical-reference material for technicians or experienced users.</p> <p><b>NOTE:</b> Drivers and documentation updates can be found at <a href="http://support.dell.com">support.dell.com</a>.</p>

---

## What Are You Looking For?

- How to set up my computer
- Basic troubleshooting information
- How to run the Dell Diagnostics
- How to remove and install parts

## Find It Here

### Quick Reference Guide



**NOTE:** This document may be optional and may not ship with your computer.

**NOTE:** This document is available as a PDF at [support.dell.com](http://support.dell.com).

### Dell™ Product Information Guide

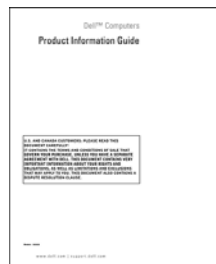

- Warranty information
- Terms and Conditions (U.S. only)
- Safety instructions
- Regulatory information
- Ergonomics information
- End User License Agreement

### Service Tag and Microsoft® Windows® License

These labels are located on your computer.

- Use the Service Tag to identify your computer when you use [support.dell.com](http://support.dell.com) or contact support.
- Enter the Express Service Code to direct your call when contacting support.



What Are You Looking For?	Find It Here
<ul style="list-style-type: none"> <li>• Solutions — Troubleshooting hints and tips, articles from technicians, online courses, and frequently asked questions</li> <li>• Community — Online discussion with other Dell customers</li> <li>• Upgrades — Upgrade information for components, such as memory, the hard drive, and the operating system</li> <li>• Customer Care — Contact information, service call and order status, warranty, and repair information</li> <li>• Service and support — Service call status and support history, service contract, online discussions with support</li> <li>• Reference — Computer documentation, details on my computer configuration, product specifications, and white papers</li> <li>• Downloads — Certified drivers, patches, and software updates</li> <li>• Notebook System Software (NSS) — If you reinstall the operating system for your computer, you should also reinstall the NSS utility. NSS provides critical updates for your operating system and support for Dell™ 3.5-inch USB floppy drives, Intel® processors, optical drives, and USB devices. NSS is necessary for correct operation of your Dell computer. The software automatically detects your computer and operating system and installs the updates appropriate for your configuration.</li> <li>• Software upgrades and troubleshooting hints — Frequently asked questions, hot topics, and general health of your computing environment</li> </ul>	<p data-bbox="721 237 1126 265"><b>Dell Support Website</b> — <a href="http://support.dell.com">support.dell.com</a></p> <p data-bbox="721 272 1283 329"><b>NOTE:</b> Select your region or business segment to view the appropriate support site.</p> <p data-bbox="721 746 1130 774">To download Notebook System Software:</p> <ol style="list-style-type: none"> <li data-bbox="733 781 1270 838">1 Go to <a href="http://support.dell.com">support.dell.com</a>, select your region or business segment, and enter your Service Tag.</li> <li data-bbox="733 845 1158 873">2 Select <b>Drivers &amp; Downloads</b> and click <b>Go</b>.</li> <li data-bbox="733 880 1282 937">3 Click your operating system and search for the keyword <i>Notebook System Software</i>.</li> </ol> <p data-bbox="721 944 1226 1001"><b>NOTE:</b> The <a href="http://support.dell.com">support.dell.com</a> user interface may vary depending on your selections.</p>
<ul style="list-style-type: none"> <li>• How to use Windows XP</li> <li>• How to work with programs and files</li> <li>• How to personalize my desktop</li> </ul>	<p data-bbox="721 1055 909 1083"><b>Dell Support Utility</b></p> <p data-bbox="721 1097 1303 1302">The Dell Support Utility is an automated upgrade and notification system installed on your computer. This support provides real-time health scans of your computing environment, software updates, and relevant self-support information. Access the Dell Support Utility from the  icon in the taskbar. For more information, see "Dell Support Utility" on page 74.</p> <p data-bbox="721 1315 1058 1343"><b>Windows Help and Support Center</b></p> <ol style="list-style-type: none"> <li data-bbox="733 1350 1072 1378">1 Click <b>Start</b> → <b>Help and Support</b>.</li> <li data-bbox="733 1385 1275 1442">2 Type a word or phrase that describes your problem and click the arrow icon.</li> <li data-bbox="733 1449 1172 1477">3 Click the topic that describes your problem.</li> <li data-bbox="733 1484 1110 1512">4 Follow the instructions on the screen.</li> </ol>

---

## What Are You Looking For?

- Information on network activity, the Power Management Wizard, hotkeys, and other items controlled by Dell QuickSet.
- How to reinstall my operating system

## Find It Here

### Dell QuickSet Help

To view Dell QuickSet Help, right-click the Quickset icon in the Microsoft® Windows® taskbar.

### Operating System media

**NOTE:** The *Operating System* CD may be optional and may not ship with your computer.

The operating system is already installed on your computer. To reinstall your operating system, use the *Operating System* media. See *Drivers and Utilities* media.



After you reinstall your operating system, use the *Drivers and Utilities* media to reinstall drivers for the devices that came with your computer.

Your operating system product key label is located on your computer (see "Service Tag and Microsoft® Windows® License" on page 12).

**NOTE:** The color of your media varies based on the operating system you ordered.

## About Your Computer

### Front View



- |    |                                    |    |                      |   |                      |
|----|------------------------------------|----|----------------------|---|----------------------|
| 1  | display latch                      | 2  | display              | 3 | device status lights |
| 4  | touch pad                          | 5  | touch pad buttons    | 6 | track stick buttons  |
| 7  | track stick                        | 8  | keyboard             | 9 | speakers             |
| 10 | keyboard and network status lights | 11 | ambient light sensor |   |                      |

**DISPLAY LATCH** — Keeps the display closed.

**DISPLAY** — For more information about your display, see "Using the Display" on page 41.

### DEVICE STATUS LIGHTS



Turns on when you turn on the computer and blinks when the computer is in Standby mode.



Turns on when the computer reads or writes data.



**NOTICE:** To avoid loss of data, never turn off the computer while the light is flashing.



Turns on steadily or blinks to indicate battery charge status.

If the computer is connected to an electrical outlet, the  light operates as follows:

- Solid green: The battery is charging.
- Flashing green: The battery is almost fully charged.

If the computer is running on a battery, the  light operates as follows:

- Off: The battery is adequately charged (or the computer is turned off).
- Flashing orange: The battery charge is low.
- Solid orange: The battery charge is critically low.

**TOUCH PAD** — Provides the functionality of a mouse. See "Touch Pad" on page 37 for more information.



**TOUCH PAD BUTTONS** — Provide the functionality of a mouse. See "Touch Pad" on page 37 for more information.

**TRACK STICK BUTTONS** — Provide the functionality of a mouse. See "Touch Pad" on page 37 for more information.

**TRACK STICK** — Provide the functionality of a mouse. See "Touch Pad" on page 37 for more information.

**KEYBOARD** — The keyboard includes a numeric keypad as well as the Windows logo key. For information on supported keyboard shortcuts, see "Key Combinations" on page 35.

**SPEAKERS** — To adjust the volume of the integrated speakers, press the volume-control keyboard shortcuts. For more information, see "Key Combinations" on page 35.

#### **KEYBOARD AND NETWORK STATUS LIGHTS**



The green lights located above the keyboard indicate the following:



Turns on when the uppercase letter function is enabled.



Turns on when wireless devices are enabled.



Turns on when the numeric keypad is enabled.



Turns on when the scroll lock function is enabled.

---

---

✂ Turns on when Bluetooth® wireless technology is enabled. To enable or disable Bluetooth wireless technology or other wireless devices, turn the wireless switch on or off.

**NOTE:** Bluetooth wireless technology is an optional feature on your computer, so the ✂ icon turns on only if Bluetooth wireless technology is installed on your computer.

For more information, see the documentation that came with your Bluetooth wireless technology.

---

➔ **NOTICE:** To avoid losing data, turn off your computer by performing a Microsoft® Windows® operating system shutdown rather than by pressing the power button.

If the computer stops responding, press and hold the power button until the computer turns off completely (which may take several seconds).

**AMBIENT LIGHT SENSOR** — Detects available environmental light and automatically increases or decreases the display backlighting to compensate for low-light and high-light environments. Press the <Fn> and left-arrow key to enable or disable the sensor.

## Left Side View



- |   |                     |   |                      |   |                                 |
|---|---------------------|---|----------------------|---|---------------------------------|
| 1 | security cable slot | 2 | microphone connector | 3 | headphone connector             |
| 4 | PC Card slot        | 5 | Smart Card slot      | 6 | Secure Digital memory card slot |

🔊 **NOTE:** The computer turns on the fan when the computer gets hot. Fan noise is normal and does not indicate a problem with the fans or the computer.

**SECURITY CABLE SLOT** — Lets you attach a commercially available antitheft device to the computer. For more information, see "Security Cable Lock" on page 61.

**MICROPHONE CONNECTOR** — Lets you connect a microphone to the 🎤 connector.

**HEADPHONE CONNECTOR** — Lets you connect headphones or speakers to the 🎧 connector.

**PC CARD SLOT** — Supports one PC Card, such as a modem or network adapter, or a 34-mm ExpressCard in an adapter. The computer ships with a plastic blank installed in the slot. For more information, see "Installing a PC Card or an ExpressCard" on page 56.

**SMART CARD SLOT** — Supports one smart card.

**SECURE DIGITAL MEMORY CARD SLOT** — The Secure Digital memory card slot supports one Secure Digital memory card. Use Secure Digital memory cards to save or back up data.

## Right Side View

 **CAUTION:** Do not block, push objects into, or allow dust to accumulate in the air vents. Do not store your computer in a low-airflow environment, such as a closed briefcase, while it is running. Restricting the airflow can damage the computer or cause a fire.



1 air vents

2 wireless switch

3 power button

**AIR VENTS** — The computer uses an internal fan to create airflow through the vents, which prevents the computer from overheating.

 **CAUTION:** Do not block, push objects into, or allow dust to accumulate in the air vents. Do not store your Dell computer in a low-airflow environment, such as a closed briefcase, while it is running. Restricting the airflow can damage the computer or cause a fire. The computer turns on the fan when the computer gets hot. Fan noise is normal and does not indicate a problem with the fan or the computer.

**WIRELESS SWITCH** — When enabled through Dell QuickSet, this switch can scan for a wireless LAN (WLAN) in your vicinity. You can also use it to rapidly turn off or on any wireless devices such as WLAN cards and internal cards with Bluetooth wireless technology (see "Dell Wi-Fi Catcher™ Network Locator" on page 53).

**POWER BUTTON** — Press the power button to turn on the computer or exit a power management mode "Power Management Modes" on page 31.

 **NOTICE:** To avoid losing data, turn off your computer by performing a Microsoft® Windows® operating system shutdown rather than by pressing the power button.

If the computer stops responding, press and hold the power button until the computer turns off completely (which may take several seconds).

## Back View

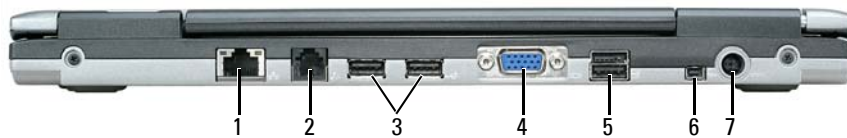

- |   |                           |   |                         |   |                     |
|---|---------------------------|---|-------------------------|---|---------------------|
| 1 | network connector (RJ-45) | 2 | modem connector (RJ-11) | 3 | USB connectors      |
| 4 | video connector           | 5 | powered USB connector   | 6 | IEEE 1394 Connector |
| 7 | AC adapter connector      |   |                         |   |                     |

### NETWORK CONNECTOR (RJ-45)

**NOTICE:** The network connector is slightly larger than the modem connector. To avoid damaging the computer, do not plug a telephone line into the network connector.

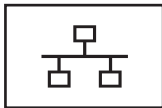

Connects the computer to a network. The two lights next to the connector indicate the status of both the connection and the transfer of information for wired network communications.

For information on using the network adapter, see the device user's guide supplied with your computer. See "Finding Information" on page 11.

## MODEM CONNECTOR (RJ-11)



Connect the telephone line to the modem connector.

For information on using the modem, see the online modem documentation supplied with your computer. See "Finding Information" on page 11 for information about accessing online user's guides.

## USB CONNECTORS

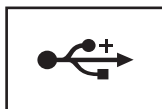

Connect a USB device, such as a mouse, keyboard, or printer. You can also connect the optional floppy drive directly to a USB connector using the optional floppy drive cable.

## VIDEO CONNECTOR



Connects an external monitor. For more information, see "Using the Display" on page 41.

## POWERED USB CONNECTOR



Connect a USB device, such as a mouse, keyboard, or printer. You can also connect the optional floppy drive directly to a USB connector using the optional floppy drive cable.

**IEEE 1394 CONNECTOR** — Connects devices supporting IEEE 1394 high-speed transfer rates, such as some digital video cameras.

## AC ADAPTER CONNECTOR



Connects an AC adapter to the computer.

The AC adapter converts AC power to the DC power required by the computer. You can connect the AC adapter with your computer turned either on or off.

**CAUTION:** The AC adapter works with electrical outlets worldwide. However, power connectors and power strips vary among countries. Using an incompatible cable or improperly connecting the cable to the power strip or electrical outlet may cause fire or equipment damage.

**NOTICE:** When you disconnect the AC adapter cable from the computer, grasp the connector, not the cable itself, and pull firmly but gently to avoid damaging the cable. When you wrap the AC adapter cable, ensure that you follow the angle of the connector on the AC adapter to avoid damaging the cable.

**NOTE:** The D430 has been optimally designed to be used with the slim Media Base for docking. However, it is compatible with the D-Family D/Port and D/Dock. With the use of the D-Family D/Port and D/Dock, all ports can be effectively utilized except for the 1394 port. If the use of this port is required, it is recommended that you use the Media Base as your primary docking device.



The AC adapter converts AC power to the DC power required by the computer. You can connect the AC adapter with your computer turned either on or off.

**CAUTION:** The AC adapter works with electrical outlets worldwide. However, power connectors and power strips vary among countries. Using an incompatible cable or improperly connecting the cable to the power strip or electrical outlet may cause fire or equipment damage.

**NOTICE:** When you disconnect the AC adapter cable from the computer, grasp the connector, not the cable itself, and pull firmly but gently to avoid damaging the cable.

## Bottom View

**CAUTION:** Do not block, push objects into, or allow dust to accumulate in the air vents. Do not store your computer in a low-airflow environment, such as a closed briefcase, while it is running. Restricting the airflow can damage the computer or cause a fire.



- |   |                                    |   |                      |   |                               |
|---|------------------------------------|---|----------------------|---|-------------------------------|
| 1 | battery                            | 2 | battery charge gauge | 3 | battery-bay latch release (2) |
| 4 | memory module/WLAN Mini-Card cover | 5 | air vents            | 6 | docking device slot           |

**BATTERY** — When a battery is installed, you can use the computer without connecting the computer to an electrical outlet. For more information, see "Using a Battery" on page 29.

**BATTERY CHARGE GAUGE** — Provides information on the battery charge. For more information, see "Checking the Battery Charge" on page 30.

**BATTERY-BAY LATCH RELEASE (2)** — Releases the battery. See "Replacing the Battery" on page 33 for instructions.

**COVER** — Covers the compartment that contains one memory module and the WLAN Mini-Card. For additional information, see "Adding and Replacing Parts" on page 103.

**MEMORY MODULE/WLAN MINI-CARD COVER** — Covers the compartment that contains the second memory module connector (DIMM B) (see "Memory" on page 131).

**AIR VENTS** — The computer uses an internal fan to create airflow through the vents, which prevents the computer from overheating.

**CAUTION:** Do not block, push objects into, or allow dust to accumulate in the air vents. Do not store your Dell computer in a low-airflow environment, such as a closed briefcase, while it is running. Restricting the airflow can damage the computer or cause a fire. The computer turns on the fan when the computer gets hot. Fan noise is normal and does not indicate a problem with the fan or the computer.

**DOCKING DEVICE SLOT** — Lets you attach your computer to a docking device. See the documentation that came

with your docking device for additional information.



**NOTICE:** Your computer features Dell Undock & Go™ technology that allows you to undock your computer without going into standby mode. Because the computer may not automatically go into standby mode when it is undocked, be sure the settings in the **Power Options** control panel do not prohibit the computer from going into standby mode. If you change the **Power Options** control panel to prohibit the computer from going into standby mode, you greatly increase the chances of causing your battery to wear down quickly or causing your computer to overheat.



# Transferring Information to a New Computer

You can use your operating system "wizards" to help you transfer files and other data from one computer to another—for example, from an *old* computer to a *new* computer. For instructions, see the following section that corresponds to the operating system your computer is running.

## Microsoft® Windows® XP

The Microsoft Windows XP operating system provides the Files and Settings Transfer Wizard to move data from a source computer to a new computer. You can transfer data, such as:

- E-mail messages
- Toolbar settings
- Window sizes
- Internet bookmarks

You can transfer the data to the new computer over a network or serial connection, or you can store it on removable media, such as a writable CD, for transfer to the new computer.

 **NOTE:** You can transfer information from an old computer to a new computer by directly connecting a serial cable to the input/output (I/O) ports of the two computers. To transfer data over a serial connection, you must access the Network Connections utility from the Control Panel and perform additional configuration steps, such as setting up an advanced connection and designating the host computer and the guest computer.

For instructions on setting up a direct cable connection between two computers, see Microsoft Knowledge Base Article #305621, titled *How to Set Up a Direct Cable Connection Between Two Computers in Windows XP*. This information may not be available in certain countries.

For transferring information to a new computer, you must run the Files and Settings Transfer Wizard. You can use the optional *Operating System* media for this process or you can create a wizard disk with the Files and Settings Transfer Wizard.

### Running the Files and Settings Transfer Wizard With the Operating System Media

 **NOTE:** This procedure requires the *Operating System* media. This media is optional and may not be included with certain computers.

To prepare a new computer for the file transfer:

- 1 Open the Files and Settings Transfer Wizard: click **Start**→ **All Programs**→ **Accessories**→ **System Tools**→ **Files and Settings Transfer Wizard**.
- 2 When the Files and Settings Transfer Wizard welcome screen appears, click **Next**.

- 3 On the **Which computer is this?** screen, click **New Computer**→**Next**.
- 4 On the **Do you have a Windows XP CD?** screen, click **I will use the wizard from the Windows XP CD**→**Next**.
- 5 When the **Now go to your old computer** screen appears, go to your old or source computer. Do *not* click **Next** at this time.

To copy data from the old computer:

- 1 On the old computer, insert the Windows XP *Operating System* media.
- 2 On the **Welcome to Microsoft Windows XP** screen, click **Perform additional tasks**.
- 3 Under **What do you want to do?**, click **Transfer files and settings**→**Next**.
- 4 On the **Which computer is this?** screen, click **Old Computer**→**Next**.
- 5 On the **Select a transfer method** screen, click the transfer method you prefer.
- 6 On the **What do you want to transfer?** screen, select the items you want to transfer and click **Next**.  
After the information has been copied, the **Completing the Collection Phase** screen appears.
- 7 Click **Finish**.

To transfer data to the new computer:

- 1 On the **Now go to your old computer** screen on the new computer, click **Next**.
- 2 On the **Where are the files and settings?** screen, select the method you chose for transferring your settings and files and click **Next**.

The wizard reads the collected files and settings and applies them to your new computer.

When all of the settings and files have been applied, the **Finished** screen appears.

- 3 Click **Finished** and restart the new computer.

### **Running the Files and Settings Transfer Wizard Without the Operating System Media**

To run the Files and Settings Transfer Wizard without the *Operating System* media, you must create a wizard disk that will allow you to create a backup image file to removable media.

To create a wizard disk, use your new computer with Windows XP and perform the following steps:

- 1 Open the Files and Settings Transfer Wizard: click **Start**→**All Programs**→**Accessories**→**System Tools**→**Files and Settings Transfer Wizard**.
- 2 When the **Files and Settings Transfer Wizard** welcome screen appears, click **Next**.
- 3 On the **Which computer is this?** screen, click **New Computer**→**Next**.
- 4 On the **Do you have a Windows XP CD?** screen, click **I want to create a Wizard Disk in the following drive**→**Next**.
- 5 Insert the removable media, such as a writable CD, and click **OK**.

- 6 When the disk creation completes and the **Now go to your old computer** message appears, *do not* click **Next**.
- 7 Go to the old computer.

To copy data from the old computer:

- 1 On the old computer, insert the wizard disk.
- 2 Click **Start**→**Run**.
- 3 In the **Open** field on the **Run** window, browse to the path for **fastwiz** (on the appropriate removable media) and click **OK**.
- 4 On the **Files and Settings Transfer Wizard** welcome screen, click **Next**.
- 5 On the **Which computer is this?** screen, click **Old Computer**→**Next**.
- 6 On the **Select a transfer method** screen, click the transfer method you prefer.
- 7 On the **What do you want to transfer?** screen, select the items you want to transfer and click **Next**.  
After the information has been copied, the **Completing the Collection Phase** screen appears.
- 8 Click **Finish**.

To transfer data to the new computer:

- 1 On the **Now go to your old computer** screen on the new computer, click **Next**.
- 2 On the **Where are the files and settings?** screen, select the method you chose for transferring your settings and files and click **Next**. Follow the instructions on the screen.

The wizard reads the collected files and settings and applies them to your new computer.

When all of the settings and files have been applied, the **Finished** screen appears.

- 3 Click **Finished** and restart the new computer.



**NOTE:** For more information about this procedure, search [support.dell.com](http://support.dell.com) for document #154781, titled *What Are The Different Methods To Transfer Files From My Old Computer To My New Dell™ Computer Using the Microsoft® Windows® XP Operating System?*



**NOTE:** Access to the Dell™ Knowledge Base document may not be available in certain countries.

## Microsoft Windows Vista®

- 1 Click the Windows Vista Start button, , and then click **Transfer files and settings**→**Start Windows Easy Transfer**.
- 2 In the **User Account Control** dialog box, click **Continue**.
- 3 Click **Start a new transfer** or **Continue a transfer in progress**.
- 4 Follow the instructions provided on the screen by the Windows Easy Transfer wizard.



# Using a Battery

## Battery Performance

 **NOTE:** For information about the Dell warranty for your computer, see the *Product Information Guide* or separate paper warranty document that shipped with your computer.

For optimal computer performance and to help preserve BIOS settings, operate your Dell™ portable computer with the main battery installed at all times. One battery is supplied as standard equipment in the battery bay.

 **NOTE:** Because the battery may not be fully charged, use the AC adapter to connect your new computer to an electrical outlet the first time you use the computer. For best results, operate the computer with the AC adapter until the battery is fully charged. To view battery charge status, check the Power Meter in Power Options (see "Accessing Power Options Properties" on page 33).

Battery operating time varies depending on operating conditions.

 **NOTE:** Battery operating time (the time the battery can hold a charge) decreases over time. Depending on how often the battery is used and the conditions under which it is used, you may need to purchase a new battery during the life of your computer.

 **NOTE:** It is recommended that you connect your computer to an electrical outlet when writing to a CD or DVD.

Operating time is significantly reduced when you perform operations including, but not limited to, the following:

- Using optical drives.
- Using wireless communications devices, PC Cards, ExpressCards, media memory cards, or USB devices.
- Using high-brightness display settings, 3D screen savers, or other power-intensive programs such as complex 3D graphics applications.
- Running the computer in maximum performance mode. See "Configuring Power Management Settings" on page 33 for information about accessing Windows Power Options Properties or Dell QuickSet, which you can use to configure power management settings.



You can check the battery charge before you insert the battery into the computer (see "Checking the Battery Charge" on page 30). You can also set power management options to alert you when the battery charge is low (see "Configuring Power Management Settings" on page 33).

 **CAUTION:** Using an incompatible battery may increase the risk of fire or explosion. Replace the battery only with a compatible battery purchased from Dell. The lithium ion battery is designed to work with your Dell computer. Do not use a battery from another computer with your computer.

 **CAUTION:** Do not dispose of batteries with household waste. When your battery no longer holds a charge, call your local waste disposal or environmental agency for advice on disposing of a lithium-ion battery. See "Battery Disposal" in the *Product Information Guide*.

 **CAUTION:** Misuse of the battery may increase the risk of fire or chemical burn. Do not puncture, incinerate, disassemble, or expose the battery to temperatures above 65°C (149°F). Keep the battery away from children. Handle damaged or leaking batteries with extreme care. Damaged batteries may leak and cause personal injury or equipment damage.

## Checking the Battery Charge



The Dell QuickSet Battery Meter, the Microsoft Windows Power Meter window and battery meter icon (  or  ), the battery charge gauge and health gauge, and the low-battery warning provide information on the battery charge.

### Dell™ QuickSet Battery Meter

If Dell QuickSet is installed, press <Fn><F3> to display the QuickSet Battery Meter. The Battery Meter displays status, battery health, charge level, and charge completion time for the battery in your computer.

For more information about QuickSet, right-click the QuickSet icon in the taskbar, and click **Help**.

### Microsoft® Windows® Power Meter

The Windows Power Meter indicates the remaining battery charge. To check the Power Meter, double-click the battery meter icon (  or  ) on the taskbar.

If the computer is connected to an electrical outlet, a  icon appears.

### Charge Gauge

By either pressing once or *pressing and holding* the status button on the charge gauge on the battery, you can check:

- Battery charge (check by pressing and *releasing* the status button)
- Battery health (check by pressing and *holding* the status button)

The battery operating time is largely determined by the number of times it is charged. After hundreds of charge and discharge cycles, batteries lose some charge capacity—or battery health. That is, a battery can show a status of "charged" but maintain a reduced charge capacity (health).

### Check the Battery Charge

To check the battery charge, *press and release* the status button on the battery charge gauge to illuminate the charge-level lights. Each light represents approximately 20 percent of the total battery charge. For example, if the battery has 80 percent of its charge remaining, four of the lights are on. If no lights appear, the battery has no charge.

## Check the Battery Health

 **NOTE:** You can check battery health in one of two ways: by using the charge gauge on the battery as described below and by using the Battery Meter in Dell QuickSet. For information about QuickSet, right-click the icon in the taskbar, and click **Help**.

To check the battery health using the charge gauge, *press and hold* the status button on the battery charge gauge for at least 3 seconds. If no lights appear, the battery is in good condition, and more than 80 percent of its original charge capacity remains. Each light represents incremental degradation. If five lights appear, less than 60 percent of the charge capacity remains, and you should consider replacing the battery. See "Battery" on page 135 for more information about the battery operating time.

## Low-Battery Warning

 **NOTICE:** To avoid losing or corrupting data, save your work immediately after a low-battery warning. Then connect the computer to an electrical outlet. If the battery runs completely out of power, hibernate mode begins automatically.

A pop-up window warns you when the battery charge is approximately 90 percent depleted. The computer enters hibernate mode when the battery charge is at a critically low level.

You can change the settings for the battery alarms in **QuickSet** or the **Power Options Properties** window. See "Configuring Power Management Settings" on page 33 for information about accessing **QuickSet** or the **Power Options Properties** window.

## Conserving Battery Power

Perform the following actions to conserve battery power:

- Connect the computer to an electrical outlet when possible because battery life is largely determined by the number of times the battery is used and recharged.
- Place the computer in standby mode or hibernate mode when you leave the computer unattended for long periods of time. See "Power Management Modes" on page 31.
- Use the Power Management Wizard or the **Power Options Properties** window to select options to optimize your computer's power usage. These options can also be set to change when you press the power button, close the display, or press <Fn><Esc>.

 **NOTE:** See "Configuring Power Management Settings" on page 33 for information on conserving battery power.

## Power Management Modes

### Standby and Sleep Mode

Standby mode (sleep mode in Microsoft Windows Vista®) conserves power by turning off the display and the hard drive after a predetermined period of inactivity (a time-out). When the computer exits standby or sleep mode, it returns to the same operating state it was in before entering standby or sleep mode.

 **NOTICE:** If your computer loses AC and battery power while in standby or sleep mode, it may lose data.

To enter standby mode in Windows XP, click the **Start** button, click **Turn off computer**, and then click **Stand by**.

To enter sleep mode in Windows Vista, click the Windows Vista Start button , and then click **Sleep**.

Depending on how you set the power management options in the **Power Options Properties** window or the **QuickSet Power Management Wizard**, you may also use one of the following methods:

- Press the power button.
- Close the display.
- Press <Fn><Esc>.

To exit standby or sleep mode, press the power button or open the display, depending on how you set the power management options. You cannot make the computer exit standby or sleep mode by pressing a key or touching the touch pad.

## Hibernate Mode

Hibernate mode conserves power by copying system data to a reserved area on the hard drive and then completely turning off the computer. When the computer exits hibernate mode, it returns to the same operating state it was in before entering hibernate mode.

 **NOTICE:** You cannot remove devices or undock your computer while your computer is in hibernate mode.

Your computer enters hibernate mode if the battery charge level becomes critically low.

To manually enter hibernate mode in Windows XP, click the **Start** button, click **Turn off computer**, press and hold <Shift>, and then click **Hibernate**.

To manually enter hibernate mode in Windows Vista, click the Windows Vista Start button , and then click **Hibernate**.

Depending on how you set the power management options in the **Power Options Properties** window or the **QuickSet Power Management Wizard**, you may also use one of the following methods to enter hibernate mode:

- Press the power button.
- Close the display.

 **NOTE:** Some PC Cards or Express Cards may not operate correctly after the computer exits hibernate mode. Remove and reinsert the card (see "Removing a PC Card or Blank" on page 58), or restart (reboot) your computer.

To exit hibernate mode, press the power button. The computer may take a short time to exit hibernate mode. You cannot make the computer exit hibernate mode by pressing a key or touching the touch pad. For more information on hibernate mode, see the documentation that came with your operating system.



## Configuring Power Management Settings

You can use the QuickSet Power Management Wizard or Windows Power Options Properties to configure the power management settings on your computer. For more information about QuickSet, right-click the QuickSet icon in the taskbar and click **Help**.

### Accessing Power Options Properties

#### Windows XP

Click the Start button, point to **Control Panel** → **Performance and Maintenance**, and then click **Power Options**.

#### Windows Vista

Click the Windows Vista Start button , click **Control Panel** → **System and Maintenance** and then click **Power Options**.

## Charging the Battery

When you connect the computer to an electrical outlet or install a battery while the computer is connected to an electrical outlet, the computer checks the battery charge and temperature. If necessary, the AC adapter then charges the battery and maintains the battery charge.

 **NOTE:** With Dell™ ExpressCharge™, when the computer is turned off, the AC adapter charges a completely discharged battery to 80 percent in about 1 hour and to 100 percent in approximately 2 hours. Charge time is longer with the computer turned on. You can leave the battery in the computer for as long as you like. The battery's internal circuitry prevents the battery from overcharging.

If the battery is hot from being used in your computer or being in a hot environment, the battery may not charge when you connect the computer to an electrical outlet.

The battery is too hot to start charging if the  light flashes alternately green and orange. Disconnect the computer from the electrical outlet and allow the computer and the battery to cool to room temperature. Then connect the computer to an electrical outlet to continue charging the battery.

For information about resolving problems with a battery, see "Power Problems" on page 85.

## Replacing the Battery

 **CAUTION:** Using an incompatible battery may increase the risk of fire or explosion. Replace the battery only with a compatible battery purchased from Dell. The battery is designed to work with your Dell™ computer. Do not use a battery from other computers with your computer.

 **CAUTION:** Before performing these procedures, turn off the computer, disconnect the AC adapter from the electrical outlet and the computer, disconnect the modem from the wall connector and computer, and remove any other external cables from the computer.

 **NOTICE:** You must remove all external cables from the computer to avoid possible connector damage.

To remove the battery:

- 1 If the computer is connected to a docking device (docked), undock it. See the documentation that came with your docking device for instructions.
- 2 Ensure that the computer is turned off.
- 3 Slide and hold the battery-bay latch release on the bottom of the computer, and then remove the battery from the bay.



1 battery-bay latch releases (2)

2 battery

**BATTERY-BAY LATCH RELEASES (2)** — Releases the battery.

**BATTERY** — When a battery is installed, you can use the computer without connecting the computer to an electrical outlet.

To replace the battery, place the battery in the bay and press down until the battery-bay latch release clicks.

## Storing a Battery

Remove the battery when you store your computer for an extended period of time. A battery discharges during prolonged storage. After a long storage period, recharge the battery fully (see "Charging the Battery" on page 33) before you use it.

# Using the Keyboard and Touch Pad

## Numeric Keypad

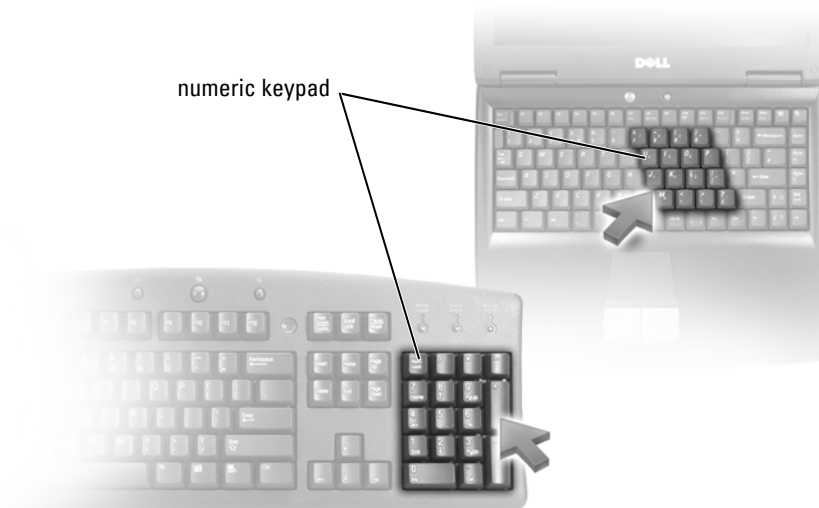

The numeric keypad functions like the numeric keypad on an external keyboard. Each key on the keypad has multiple functions. The keypad numbers and symbols are marked in blue on the right of the keypad keys. To type a number or symbol, hold down <Fn> and press the desired key.

- To enable the keypad, press <Num Lk>. The  light indicates that the keypad is active.
- To disable the keypad, press <Num Lk> again.

## Key Combinations

### System Functions

---

<Ctrl><Shift><Esc>	Opens the <b>Task Manager</b> window.
--------------------	---------------------------------------

---

## Battery

---

<Fn> <F3>	Displays the Dell™ QuickSet Battery Meter (see "Dell™ QuickSet Battery Meter" on page 30).
-----------	--

---

## Optical Drive Tray

---

<Fn> <F10>	Ejects the tray out of the drive if Dell QuickSet is installed (see "Dell™ QuickSet" on page 121).
------------	--

---

## Display Functions

---

<Fn> <F8>	Switches the video image to the next display option. The options include the integrated display, an external monitor, and both displays simultaneously.
-----------	---

---

<Fn> <F7>	Scales between wide-screen and standard aspect ratio video resolutions.
-----------	---

---

---

<Fn> and left-arrow key	Activates the ambient light sensor, which controls brightness of the display based on light level in the current environment.
-------------------------	---

---

---

<Fn> and up-arrow key	Increases brightness on the integrated display only (not on an external monitor).
-----------------------	---

---

---

<Fn> and down-arrow key	Decreases brightness on the integrated display only (not on an external monitor).
-------------------------	---

---

## Power Management

---

<Fn> <Esc>	Activates a power management mode. You can reprogram this keyboard shortcut to activate a different power management mode using the <b>Advanced</b> tab in the <b>Power Options Properties</b> window (see "Power Management Modes" on page 31).
------------	--

---

<Fn> <F1>	Puts the computer into hibernate mode. Dell QuickSet is required (see "Dell™ QuickSet" on page 121).
-----------	--

---

## Speaker Functions

---

<Fn> <Page Up>	Increases the volume of the integrated speakers and external speakers, if attached.
----------------	---

---

<Fn> <Page Dn>	Decreases the volume of the integrated speakers and external speakers, if attached.
----------------	---

---

---

<Fn><End>	Enables and disables the integrated speakers and external speakers, if attached.
-----------	--

---

## Microsoft® Windows® Logo Key Functions

---

Windows logo key and <m>	Minimizes all open windows
Windows logo key and <Shift><m>	Restores all minimized windows. This key combination functions as a toggle to restore minimized windows following the use of the Windows logo key and <m> key combination.
Windows logo key and <e>	Runs Windows Explorer.
Windows logo key and <r>	Opens the <b>Run</b> dialog box.
Windows logo key and <f>	Opens the <b>Search Results</b> dialog box.
Windows logo key and <Ctrl><f>	Opens the <b>Search Results-Computer</b> dialog box (if the computer is connected to a network).
Windows logo key and <Pause>	Opens the <b>System Properties</b> dialog box.

---

To adjust keyboard operation, such as the character repeat rate, open the Control Panel, click **Printers and Other Hardware**, and click **Keyboard**. For information about the Control Panel, see the Windows Help and Support Center. To access the Help and Support Center, see "Windows Help and Support Center" on page 13.

## Touch Pad

The touch pad detects the pressure and movement of your finger to allow you to move the cursor on the display. Use the touch pad and touch pad buttons as you would use a mouse.



1 track stick buttons

2 touch pad

3 touch pad buttons

**TRACK STICK BUTTONS** — Provide the functionality of a mouse.

**TOUCH PAD** — Provides the functionality of a mouse.

**TOUCH PAD BUTTONS** — Provide the functionality of a mouse.

- To move the cursor, lightly slide your finger over the touch pad.
- To select an object, lightly tap once on the surface of the touch pad or use your thumb to press the left touch-pad button.
- To select and move (or drag) an object, position the cursor on the object and tap twice on the touch pad. On the second tap, leave your finger on the touch pad and move the selected object by sliding your finger over the surface.
- To double-click an object, position the cursor on the object and tap twice on the touch pad or use your thumb to press the left touch-pad button twice.

You can also use the track stick to move the cursor. Press the track stick left, right, up, or down to change the direction of the cursor on the display. Use the track stick and track stick buttons as you would use a mouse.

## Fingerprint Reader (optional)

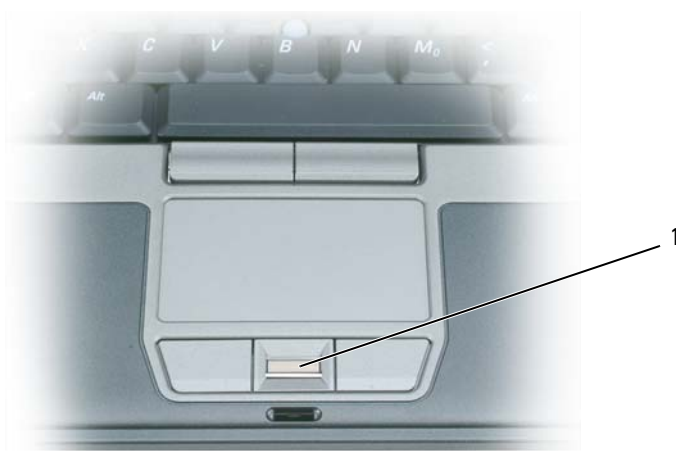

1 fingerprint reader (optional)

 **NOTE:** The fingerprint reader is optional and may not be installed on your computer. For information on how to activate and use the security management software that controls the fingerprint reader, see "Security Management Software" on page 64.

### Customizing the Touch Pad and Track Stick

You can use the **Mouse Properties** window to disable the touch pad and track stick or adjust their settings.

- 1 Open the Control Panel, and then click Mouse. For information about the Control Panel, see the Windows Help and Support Center. To access the Help and Support Center, see "Windows Help and Support Center" on page 13.
- 2 In the **Mouse Properties** window:
  - Click the **Device Select** tab to disable the touch pad and track stick.
  - Click the **Touch Pad** tab to adjust touch pad and track stick settings.
- 3 Click **OK** to save the settings and close the window.

### Changing the Track Stick Cap

You can replace your track stick cap if it wears down from prolonged use. You can purchase additional caps by visiting the Dell website at [dell.com](http://dell.com).



- 1 Pull the cap off the track stick.
- 2 Align the new cap over the square track-stick post and gently press the cap down onto the post.
- ➔ **NOTICE:** The track stick can damage the display if it is not properly seated on the post.
- 3 Test the track stick to ensure that the cap is seated properly.



# Using the Display

## Adjusting Brightness

When a Dell™ computer is running on battery power, you can conserve power by setting the display brightness to the lowest comfortable setting by pressing <Fn> and the up- or down-arrow key on the keyboard.

 **NOTE:** Brightness key combinations only affect the display on your portable computer, not monitors or projectors that you attach to your portable computer or docking device. If your computer is connected to an external monitor and you try to change the brightness level, the Brightness Meter may appear, but the brightness level on the external device does not change.

You can press the following keys to adjust display brightness:

- Press <Fn> and the up-arrow key to increase brightness on the integrated display only (not on an external monitor).
- Press <Fn> and the down-arrow key to decrease brightness on the integrated display only (not on an external monitor).

## Switching the Video Image From Your Computer Display to a Projector

When you start the computer with an external device (such as an external monitor or projector) attached and turned on, the image may appear on either the computer display or the external device. Press <Fn><F8> to switch the video image between the display only, the external device only, or the display and the external device simultaneously.

## Making Images and Text Look Bigger or Sharper on the Screen: Setting Display Resolution and Refresh Rate

 **NOTE:** If you change the display resolution from the current settings, the image may appear blurry or text may be hard to read if you change the resolution to one not supported by your computer and display. Before you change any of the display settings, make a note of the current settings so you can change back to the previous settings if you need to.

You can enhance the legibility of text and change the appearance of images on the screen by adjusting display resolution. As you increase resolution, items appear smaller on the screen. In contrast, lower resolution causes text and images to appear larger and can benefit people with vision impairments. To display a program at a specific resolution, both the video card and the display must support the program, and the necessary video drivers must be installed.

 **NOTE:** Use only the Dell-installed video drivers, which are designed to offer the best performance with your Dell-installed operating system.

If you choose a resolution or color palette that is higher than the display supports, the settings adjust automatically to the closest supported values.

To set the display resolution and refresh rate for your display, perform the steps in the following section that corresponds to the operating system your computer is using.

### Microsoft® Windows® XP

- 1 Click Start→ Settings→ Control Panel.
- 2 Under Pick a category, click Appearance and Themes.
- 3 Under Pick a task..., click the area you want to change, or under or pick a Control Panel icon, click Display.
- 4 In the Display Properties window, click the Settings tab.
- 5 Try different settings for Color quality and Screen resolution.

 **NOTE:** As the resolution increases, icons and text appear smaller on the screen.

### Microsoft Windows Vista®

- 1 Click the Windows Vista Start button, , and click Control Panel.
- 2 Under Appearance and Personalization, click Adjust screen resolution.
- 3 In the Display Settings window, under Resolution, slide the slide bar to the left/right to decrease/increase the screen resolution.
- 4 Click How do I get the best display? for further instructions.

If the video resolution setting is higher than that supported by the display, the computer enters pan mode. In pan mode, the entire video image cannot be displayed at one time, and the taskbar that usually appears at the bottom of the desktop may no longer be visible. To view the parts of the video image that are not visible, you can use the touch pad or track stick to "pan" (or *move*) the image up, down, left, and right.

 **NOTICE:** You can damage an external monitor by using an unsupported refresh rate. Before adjusting the refresh rate on an external monitor, see the user's guide for the monitor.

# Using an External Monitor Simultaneously as an Extension of Your Computer Display

You can attach an external monitor or projector to your computer and use it as an extension of your display (known as "dual independent display" or "extended desktop" mode). This mode allows you to use both screens independently and drag objects from one screen to the other, effectively doubling the amount of viewable work space.

To use extended desktop mode, perform the steps in the following section that corresponds to the operating system your computer is using.

## Microsoft® Windows® XP

- 1 Connect the external monitor, TV, or projector to the computer.
- 2 Click **Start**→ **Settings**→ **Control Panel**.
- 3 Under **Pick a category**, click **Appearance and Themes**.
- 4 Under **Pick a task...**, click the area you want to change, or under **or pick a Control Panel icon**, click **Display**.
- 5 In the **Display Properties** window, click the **Settings** tab.



**NOTE:** If you choose a resolution or color palette that is higher than the display supports, the settings adjust automatically to the closest supported values. For more information, see your operating system documentation.

- 6 Click the monitor 2 icon, click the **Extend my Windows desktop...** check box, and then click **Apply**.
- 7 Change **Screen Area** to the appropriate sizes for both displays and click **Apply**.
- 8 If prompted to restart the computer, click **Apply the new color setting without restarting** and click **OK**.
- 9 If prompted, click **OK** to resize your desktop.
- 10 If prompted, click **Yes** to keep the settings.
- 11 Click **OK** to close the **Display Properties** window.

To disable dual independent display mode:

- 1 Click the **Settings** tab in the **Display Properties** window.
- 2 Click the monitor 2 icon, uncheck the **Extend my Windows desktop onto this monitor** option, and then click **Apply**.

If necessary, press <Fn><F8> to bring the screen image back to the computer display.

## Microsoft Windows Vista®

- 1 Click the Windows Vista Start button, , and click **Control Panel**.
- 2 Under **Appearance and Personalization**, click **Adjust screen resolution**.

- 3 In the **Display Settings** window, click the monitor 2 icon, click the **Extend the desktop onto this monitor** check box, and then click **Apply**.
- 4 Click **OK** to close the **Display Settings** window.

To disable extended desktop mode:

- 1 In the **Display Settings** window, click the **Settings** tab.
- 2 Click the monitor 2 icon, uncheck the **Extend the desktop onto this monitor** option, and then click **Apply**.

## Using an External Monitor as Your Primary Display: Swapping Primary and Secondary Displays

To swap your primary and secondary display designations (for example, to use your external monitor as your primary display after docking), perform the steps in the following section that corresponds to the operating system your computer is using.

### Microsoft® Windows® XP

- 1 Click the **Start** button and click **Control Panel**.
- 2 Under **Pick a category**, click **Appearance and Themes**.
- 3 Under **Pick a task...**, click the area you want to change, or under **or pick a Control Panel icon**, click **Display**.
- 4 Click the **Settings** tab→ **Advanced**→ **Displays** tab.

See the documentation that came with your video card for additional information.

### Microsoft Windows Vista®

- 1 Click the Windows Vista **Start** button, , and click **Control Panel**.
- 2 Under **Appearance and Personalization**, click **Adjust screen resolution**.
- 3 In the **Display Settings** window, click the monitor 2 icon, click the **This is my main monitor** check box, and then click **Apply**.
- 4 Click **OK** to close the **Display Settings** window.



# Setting Up and Using Networks

Setting up a computer network provides connectivity between your computer and the Internet, another computer, or a network. For example, with a network set up in a home or small office you can print to a shared printer, access drives and files on another computer, browse other networks, or access the Internet. You can set up a local area network (LAN) using a network or broadband modem cable or set up a wireless LAN (WLAN).

The Microsoft® Windows® XP and Microsoft Windows Vista® operating systems provide wizards to help guide you through the process of networking computers. For more information about Networking, see the Windows Help and Support Center (see "Windows Help and Support Center" on page 13).

## Connecting a Network or Broadband Modem Cable

Before you connect your computer to a network, the computer must have a network adapter installed and a network cable connected to it.

- 1 Connect the network cable to the network adapter connector on the back of your computer.
  -  **NOTE:** Insert the cable connector until it clicks into place, and then gently pull the cable to ensure that it is securely attached.
- 2 Connect the other end of the network cable to a network connection device or a network wall connector.
  -  **NOTE:** Do not use a network cable with a telephone wall connector.



## Setting Up a Network in the Microsoft® Windows® XP Operating System

- 1 Click Start→ All Programs→ Accessories→ Communications→ Network Setup Wizard→ Next→ Checklist for creating a network.

 **NOTE:** Selecting the connection method labeled **This computer connects directly to the Internet** enables the integrated firewall provided with Windows XP Service Pack 2 (SP2).

- 2 Complete the checklist.
- 3 Return to the Network Setup Wizard and follow the instructions in the wizard.

## Setting Up a Network in the Microsoft Windows Vista® Operating System

- 1 Click the Windows Vista Start button, , and then click Connect To→ Set up a connection or network.
- 2 Select an option under Choose a connection option.
- 3 Click Next, and then follow the instructions in the wizard.

# Wireless Local Area Network

A WLAN is a series of interconnected computers that communicate with each other over the air waves rather than through a network cable connected to each computer. In a WLAN, a radio communications device called an access point or wireless router connects network computers and provides Internet, or network, access. The access point or wireless router and the wireless network card in the computer communicate by broadcasting data from their antennas over the air waves.

## What You Need to Establish a WLAN Connection

Before you can set up a WLAN, you need:

- High-speed (broadband) Internet access (such as cable or DSL)
- A broadband modem that is connected and working
- A wireless router or access point
- A wireless network card for each computer that you want to connect to your WLAN
- A network cable with a network (RJ-45) connector

## Checking Your Wireless Network Card

Depending on what you selected when you purchased your computer, the computer has a variety of configurations. To confirm that your computer has a wireless network card and to determine the type of card, use one of the following:

- The **Start** button and the **Connect To** option
- The order confirmation for your computer

### Start Button and Connect To Option

In Microsoft Windows XP, click **Start**→ **Connect To**→ **Show all connections**.

In Microsoft Windows Vista, click → **Connect To**→ **View network computers and devices**.

 **NOTE:** If your computer is set to the **Classic Start** menu option, you can view network connections by clicking the **Start**→ **Settings**→ **Network Connections**. If **Wireless Network Connection** does not appear, you may not have a wireless network card. If **Wireless Network Connection** does not appear under **LAN** or **High-Speed Internet**, you may not have a wireless network card.

If **Wireless Network Connection** appears, you have a wireless network card. To view detailed information about the wireless network card:

- 1 Right-click **Wireless Network Connection**.
- 2 Click **Properties**.

The **Wireless Network Connection Properties** window appears. The wireless network card's name and model number are listed on the **General** tab.

## The Order Confirmation for Your Computer

The order confirmation that you received when you ordered your computer lists the hardware and software that shipped with your computer.

## Setting Up a New WLAN Using a Wireless Router and a Broadband Modem

- 1 Contact your Internet service provider (ISP) to obtain specific information about the connection requirements for your broadband modem.
- 2 Ensure that you have wired Internet access through your broadband modem before you attempt to set up a wireless Internet connection (see "Connecting a Network or Broadband Modem Cable" on page 45).
- 3 Install any software required for your wireless router. Your wireless router may have been shipped with an installation CD. Installation CDs usually contain installation and troubleshooting information. Install the required software according to the instructions provided by the router manufacturer.
- 4 Shut down your computer and any other wireless-enabled computers in the vicinity through the **Start** or  menu.
- 5 Disconnect your broadband modem power cable from the electrical outlet.
- 6 Disconnect the network cable from the computer and the modem.
- 7 Disconnect the AC adapter cable from your wireless router to ensure that there is no power connected to the router.



**NOTE:** Wait for a minimum of 5 minutes after disconnecting your broadband modem before you continue with the network setup.

- 8 Insert a network cable into the network (RJ-45) connector on the unpowered broadband modem.
- 9 Connect the other end of the network cable into the Internet network (RJ-45) connector on the unpowered wireless router.
- 10 Ensure that no network or USB cables other than the network cable connecting the modem and the wireless router are connected to the broadband modem.



**NOTE:** Restart your wireless equipment in the order described below to prevent a potential connection failure.

- 11 Turn on *only* your broadband modem and wait for at least 2 minutes for the broadband modem to stabilize. After 2 minutes, proceed to step 12.
- 12 Turn on your wireless router and wait for at least 2 minutes for the wireless router to stabilize. After 2 minutes, proceed to the step 13.
- 13 Start your computer and wait until the boot process completes.
- 14 See the documentation that came with your wireless router to set up the wireless router:
  - Establish communication between your computer and your wireless router.
  - Configure your wireless router to communicate with your broadband router.



- Find out your wireless router's broadcast name. The technical term for the name of your router's broadcast name is Service Set Identifier (SSID) or network name.

**15** If necessary, configure your wireless network card to connect to the wireless network (see "Connecting to a WLAN" on page 49).

## Connecting to a WLAN



**NOTE:** Before you connect to a WLAN, ensure that you have followed the instructions in "Wireless Local Area Network" on page 47.



**NOTE:** The following networking instructions do not apply to internal cards with Bluetooth® wireless technology or cellular products.

This section provides general procedures for connecting to a network using wireless technology. Specific network names and configuration details vary. See "Wireless Local Area Network" on page 47 for more information about how to prepare for connecting your computer to a WLAN.

Your wireless network card requires specific software and drivers for connecting to a network. The software is already installed.



**NOTE:** If the software is removed or corrupted, follow the instructions in the user documentation for your wireless network card. Verify the type of wireless network card installed in your computer and then search for that name on the Dell™ Support website at [support.dell.com](http://support.dell.com). For information on the type of wireless network card that is installed in your computer, see "Checking Your Wireless Network Card" on page 47.

## Determining the Wireless Network Device Manager

Depending on the software installed on your computer, different wireless configuration utilities may manage your network devices:

- Your wireless network card's client utility
- The Windows XP or Windows Vista operating system

In Windows XP:

To determine which wireless configuration utility is managing your wireless network card in Windows XP:

- 1 Click **Start**→ **Settings**→ **Control Panel**→ **Network Connections**.
- 2 Right-click the **Wireless Network Connection** icon, and then click **View Available Wireless Networks**.

If the **Choose a wireless network** window states **Windows cannot configure this connection**, the wireless network card's client utility is managing the wireless network card.

If the **Choose a wireless network** window states **Click an item in the list below to connect to a wireless network in range or to get more information**, the Windows XP operating system is managing the wireless network card.

In Windows Vista:

To determine which wireless configuration utility is managing your wireless network card in Windows Vista:

- 1 Click  → Connect To → Manage wireless networks.
- 2 Double-click a profile to open the wireless network properties screen.

For specific information about the wireless configuration utility installed on your computer, see your wireless network documentation in the Windows Help and Support Center (see "Windows Help and Support Center" on page 13).

### Completing the Connection to the WLAN

When you turn on your computer and a network (for which your computer is not configured) is detected in the area, a pop-up appears near the network icon in the notification area (in the lower-right corner of the Windows desktop).

Follow the instructions provided in any utility prompts that appear on your screen.

Once you have configured your computer for the wireless network that you selected, another pop-up notifies you that your computer is connected to that network.

Thereafter, whenever you log on to your computer within the range of the wireless network that you selected, the same pop-up notifies you of the wireless network connection.

 **NOTE:** If you select a secure network, you must enter a Wired Equivalent Privacy (WEP) or WiFi Protected Access (WPA) key when prompted. Network security settings are unique to your network. Dell cannot provide this information.

 **NOTE:** Your computer can take up to 1 minute to connect to the network.

### Enabling/Disabling the Wireless Network Card

 **NOTE:** If you are unable to connect to a wireless network, ensure that you have all the components for establishing a WLAN (see "What You Need to Establish a WLAN Connection" on page 47).

To enable or disable the network card, see "Connecting to a Mobile Broadband Network" on page 52.

### Monitoring the Status of the Wireless Network Card Through Dell QuickSet

The wireless activity indicator provides you with an easy way to monitor the status of your computer's wireless devices. To turn the wireless activity indicator on or off, click the QuickSet icon in the taskbar and select **Hotkey Popups**. If **Wireless Activity Indicator Off** is not checked, the indicator is on. If **Wireless Activity Indicator Off** is checked, the indicator is off.

The wireless activity indicator displays whether your computer's integrated wireless devices are enabled or disabled. When you turn the wireless networking function on or off, the wireless activity indicator changes to display the status.

For more information about the Dell QuickSet wireless activity indicator, right-click the QuickSet icon in the taskbar and select **Help**.

## Mobile Broadband (or Wireless Wide Area Network)

A Mobile Broadband network, also known as a Wireless Wide Area Network (WWAN), is a high-speed digital cellular network that provides Internet access over a much wider geographical area than a WLAN, which typically covers only from 100 to 1000 feet. Your computer can maintain Mobile Broadband network access as long as the computer is within a cellular-data coverage zone. Contact your service provider for coverage of a high-speed digital cellular network.

 **NOTE:** Even if you are able to make a call from your cellular phone in a specific geographical location, that location may not necessarily be within a cellular-data coverage zone.

### What You Need to Establish a Mobile Broadband Network Connection

 **NOTE:** Depending on your computer, you can use either a Mobile Broadband ExpressCard or Mini-Card, but not both, to establish a Mobile Broadband network connection.

To set up a Mobile Broadband network connection, you need:

- A Mobile Broadband ExpressCard or activated Mini-Card (depending on your computer's configuration)
  -  **NOTE:** For instructions on using ExpressCards, see "Installing a PC Card or an ExpressCard" on page 56.
- An activated Mobile Broadband ExpressCard or activated Subscriber Identity Module (SIM) for your service provider
- The Dell Mobile Broadband Card Utility (already installed on your computer if you purchased the card when you purchased your computer, or on the CD that accompanied your card if purchased separately from your computer)

If the utility is corrupted or deleted from your computer, see the *Dell Mobile Broadband Card Utility* user's guide for instructions. The user's guide is available through the Windows Help and Support Center (see "Windows Help and Support Center" on page 13) or on the CD that accompanied your card if you purchased it separately from your computer.

### Checking Your Dell Mobile Broadband Card

Depending on what you selected when you purchased your computer, the computer has a variety of configurations. To determine your computer configuration, see one of the following:

- Your order confirmation
- Microsoft Windows Help and Support Center

To check your Mobile Broadband card in the Windows Help and Support Center:

- 1 Click **Start**→ **Help and Support**→ **Use Tools** to view your computer information and diagnose problems.
- 2 Under **Tools**, click **My Computer Information**→ **Find information about the hardware installed on this computer**.

On the **My Computer Information - Hardware** screen, you can view the type of Mobile Broadband card installed in your computer as well as other hardware components.

 **NOTE:** The Mobile Broadband card is listed under **Modems**.

## Connecting to a Mobile Broadband Network

 **NOTE:** These instructions only apply to Mobile Broadband ExpressCards or Mini-Cards. They do not apply to internal cards with wireless technology.

 **NOTE:** Before you connect to the Internet, you must activate Mobile Broadband service through your cellular service provider. For instructions and for additional information about using the Dell Mobile Broadband Card Utility, see the user's guide available through the Windows Help and Support Center (see "Windows Help and Support Center" on page 13). The user's guide is also available on the Dell Support website at [support.dell.com](http://support.dell.com) and on the CD included with your Mobile Broadband card if you purchased the card separately from your computer.

Use the Dell Mobile Broadband Card Utility to establish and manage a Mobile Broadband network connection to the Internet:

- 1 Click the Dell Mobile Broadband Card Utility icon  on the Windows desktop, to run the utility.
- 2 Click **Connect**.

 **NOTE:** The **Connect** button changes to the **Disconnect** button.

- 3 Follow the instructions on the screen to manage the network connection with the utility.

Or

- 1 Click **Start**→ **All Programs**→ **Dell Wireless**.
- 2 Click **Dell Wireless Broadband** and follow the instructions on the screen.

 **NOTE:** If you are unable to connect to a Mobile Broadband network, ensure that you have all the components for establishing a Mobile Broadband connection (see "What You Need to Establish a Mobile Broadband Network Connection" on page 51), and then verify that your Mobile Broadband card is enabled by verifying the setting of the wireless switch.

You can turn your Mobile Broadband card on and off using the wireless switch on your computer.

You can turn your computer's wireless devices on and off with the wireless switch on the left side of the computer (see "Left Side View" on page 18).

If the switch is in the "on" position, move the switch to the "off" position to disable the switch and the Mobile Broadband card. If the switch is in the "off" position, move the switch to the "on" position to enable the switch and the Dell Mobile Broadband card. For information about the wireless switch positions, see "Dell Wi-Fi Catcher™ Network Locator" on page 53

To monitor the status of your wireless device, see "Monitoring the Status of the Wireless Network Card Through Dell QuickSet" on page 50.

## Managing Your Network Settings Through the Dell QuickSet Location Profiler

The Dell QuickSet Location Profiler helps you manage network settings that correspond to your computer's physical location. It includes two categories of profile settings:

- Location Profile Settings
- General Mobility Settings

You can use **Location Profile Settings** to create profiles for accessing the Internet with your computer in your office, home, or other public places with Internet services. **General Mobility Settings** allows you to change the way network connections are handled. The profiles consist of different network settings and equipment that you need when using your computer in different locations.

For more information about Dell QuickSet, right-click the QuickSet icon in the taskbar and select **Help**.

## Dell Wi-Fi Catcher™ Network Locator

The wireless switch on your Dell computer uses the Dell Wi-Fi Catcher Network Locator to scan specifically for WiFi WLAN in your vicinity. For more information about the wireless switch, see "Dell Wi-Fi Catcher™ Network Locator" on page 53.

To scan for WiFi WLAN, slide and hold the switch in the "momentary" position for a few seconds. The Wi-Fi Catcher Network Locator functions regardless of whether your computer is turned on or off, in hibernate mode, or in standby mode, as long as the switch is configured through Dell QuickSet or the BIOS (system setup program) to control WiFi network connections.

Because the Wi-Fi Catcher Network Locator is disabled and not configured for use when your computer is shipped to you, you must first use Dell QuickSet to enable and configure the switch to control WiFi network connections.



**NOTE:** The Dell Wi-Fi Catcher Network Locator light appears only when the computer is turned off and wireless networking is activated in the system setup program. While working in Microsoft Windows operating systems, the light is designed not to appear.

## Microsoft® Windows® Firewall

Windows Firewall provides basic protection from unauthorized access to your computer while it is connected to the Internet. Windows Firewall is automatically enabled when you run the Network Setup Wizard.

When Windows Firewall is enabled for a network connection, the firewall icon appears with a red background in the **Network Connections** section of the Control Panel.



**NOTE:** Enabling Windows Firewall does not reduce the need for virus-checking software.

For more information, click **Start**→ **Control Panel**→ **Security**→ **Windows Firewall**, or see "Windows Help and Support Center" on page 13.



# Using Cards

## Card Types

This computer supports the following PC Cards, 34-mm ExpressCard (with adapter), SD (Secure Digital) card, and smart cards.

See "Installing a Smart Card" on page 62 for more information on smart cards.

See "Specifications" on page 131 for information on supported card types.

 **NOTE:** A PC Card is not a bootable device.

The PC Card slot has one connector that supports a single Type I or Type II card. The PC Card slot supports CardBus technology and extended PC Cards. "Type" of card refers to its thickness, not its functionality.

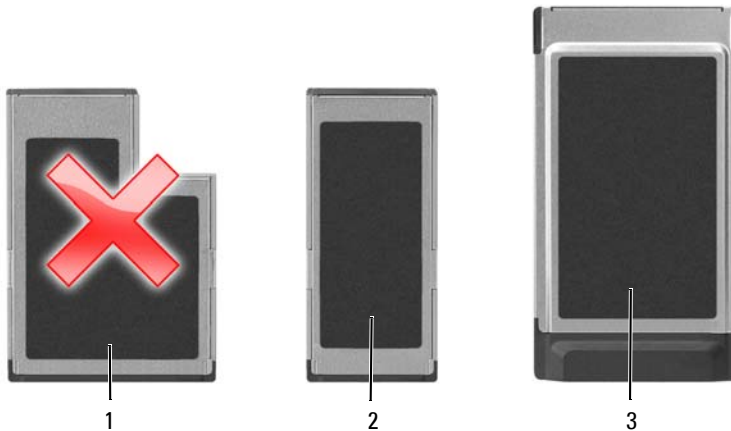

- 1 54-mm ExpressCard  
(*not* supported by your computer)
- 2 34-mm ExpressCard  
(supported with an adapter)
- 3 PC Card  
(supported by your computer)

## Card Blanks

Your computer shipped with a plastic blank installed in the card slots. Blanks protect unused slots from dust and other particles. Save the blank for use when no card is installed in the slot; blanks from other computers may not fit your computer. To remove the blank, see "Removing a PC Card or Blank" on page 58.

## PC Cards

See "PC Card/Express Card" on page 131 for information on supported PC Cards.



**NOTE:** A PC Card is not a bootable device.

The PC Card slot has one connector that supports a single Type I or Type II card. The PC Card slot supports CardBus technology and extended PC Cards. "Type" of card refers to its thickness, not its functionality.

### PC Card Blanks

Your computer shipped with a plastic blank installed in the PC Card slot. Blanks protect unused slots from dust and other particles. Save the blank for use when no PC Card is installed in the slot; blanks from other computers may not fit your computer.

To remove the blank, see "Removing a PC Card or Blank" on page 58.

### Extended PC Cards

An extended PC Card (for example, a wireless network adapter) is longer than a standard PC Card and extends outside the computer. Follow these precautions when using extended PC Cards:

- Protect the exposed end of an installed card. Striking the end of the card can damage the system board.
- Always remove an extended PC Card before you pack the computer in its carrying case.

## Installing a PC Card or an ExpressCard

You can install a PC Card or ExpressCard in the computer while the computer is running. The computer automatically detects the card.

PC Cards and ExpressCards are generally marked with a symbol (such as a triangle or an arrow) to indicate which end to insert into the slot. The cards are keyed to prevent incorrect insertion. If card orientation is not clear, see the documentation that came with the card.



**CAUTION:** Before you begin any of the procedures in this section, follow the safety instructions in the *Product Information Guide* and see "Before Working Inside Your Computer" on page 104.

To install a PC Card:

- 1 Hold the card with its orientation symbol pointing into the slot and the top side of the card facing up. The latch may need to be in the "in" position before you insert the card.



- 2 Slide the card into the slot until the card is completely seated in its connector.  
If you encounter too much resistance, do not force the card. Check the card orientation and try again.

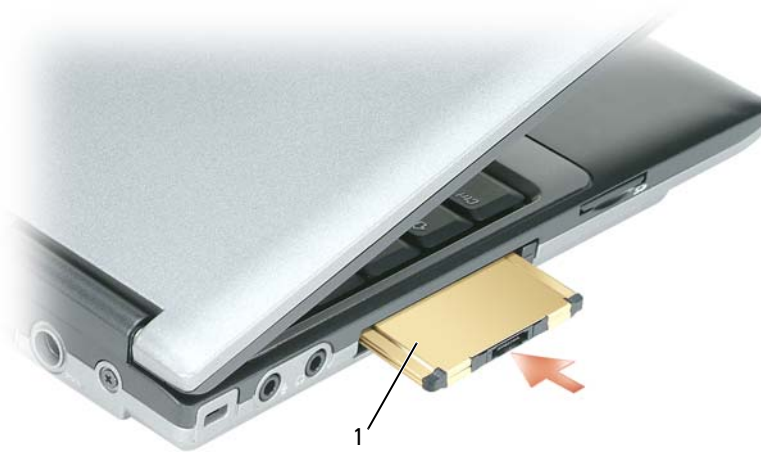

#### 1 PC Card

The computer recognizes most PC Cards and automatically loads the appropriate device driver. If the configuration program tells you to load the manufacturer's drivers, use the floppy disk or CD that came with the PC Card.

To install an ExpressCard:

- 1 Place the ExpressCard in the PC Card adapter (the adapter is included with the ExpressCard).
- 2 Install the ExpressCard with adapter the same way as a PC Card (see "PC Cards" on page 56).

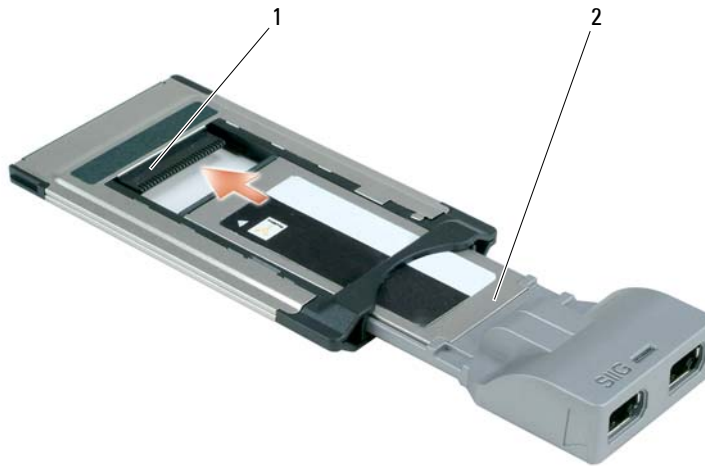

1 slot

2 ExpressCard

## Removing a PC Card or Blank

**➡ NOTICE:** Use the PC Card configuration utility (click the  icon in the taskbar) to select a card and stop it from functioning before you remove it from the computer. If you do not stop the card in the configuration utility, you could lose data. Do not attempt to eject a card by pulling its cable, if one is attached.

**⚠ CAUTION:** Before you begin any of the procedures in this section, follow the safety instructions in the *Product Information Guide*.

- 1 Press the latch and remove the card or blank. For some latches, you must press the latch twice: once to pop the latch out, and then a second time to pop the card out.
- 2 Remove the card or blank.



1 release button 2 PC Card

## Installing or Removing a Secure Digital (SD) Card

- 1 Ensure that the card orientation is correct; the gold-metal contacts should be facing downward.
- 2 Slide the card into the slot until the card is completely seated in its connector.



To remove a secure digital card, press in on the card and it will spring outward. Remove the card from the computer.

## Extended Cards

An extended card (for example, a wireless network adapter) is longer than a standard card and extends outside the computer. Follow these precautions when using extended cards:

- Protect the exposed end of an installed card. Striking the end of the card can damage the system board.
- Always remove an extended card before you pack the computer in its carrying case.

# Securing Your Computer

## Security Cable Lock

 **NOTE:** Your computer does not ship with a security cable lock.

A security cable lock is a commercially available antitheft device. To use the lock, attach it to the security cable slot on your Dell™ computer. For more information, see the instructions included with the device.

 **NOTICE:** Before you buy an antitheft device, ensure that it will work with the security cable slot on your computer.



## Smart Card

 **NOTE:** For information on how to secure your computer while traveling, see "Traveling With Your Computer" on page 123.

### About Smart Cards

Smart cards are portable credit-card shaped devices with internal integrated circuits. The top surface of the smart card usually contains an embedded processor under the gold contact pad. The combination of the small size and integrated circuits make smart cards valuable tools for security, data storage, and special programs. Using smart cards can improve system security by combining something a user has (the smart card) with something only the user should know (a PIN) to provide more secure user-authentication than passwords alone.

## Installing a Smart Card

You can install a smart card in the computer while the computer is running. The computer automatically detects the card.

To install a smart card:

- 1 Hold the card so that the gold contact pad is facing upward and pointing toward the smart card slot.

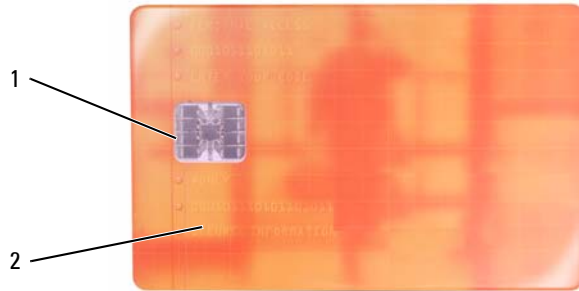

- 1 gold contact pad                      2 smart card (top)

- 2 Slide the smart card into the smart card slot until the card is completely seated in its connector. The smart card will protrude approximately 1/2 inch from the slot. The smart card slot is located below the PC Card slot.

If you encounter too much resistance, do not force the card. Check the card orientation and try again.

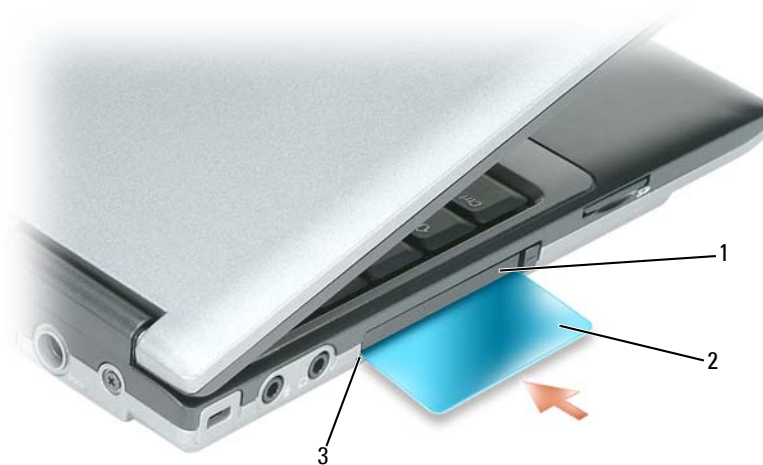



## Passwords

 **NOTE:** Passwords are disabled when you receive your computer.

A primary (or system) password, an administrator password, and a hard drive password all prevent unauthorized access to your computer in different ways. The following table identifies types and features of passwords available on your computer.

Type of Password	Features
Primary (or system)	<ul style="list-style-type: none"> <li>Protects the computer from unauthorized access</li> </ul>
Administrator	<ul style="list-style-type: none"> <li>Gives system administrators or service technicians access to computers for repair or reconfiguration</li> <li>Allows you to restrict access to system setup in the same way a primary password restricts access to the computer</li> <li>Can be used instead of the primary password</li> </ul>
Hard drive	<ul style="list-style-type: none"> <li>Helps protect the data on your hard drive or external hard drive (if one is being used) from unauthorized access</li> </ul>

 **NOTE:** Some hard drives do not support hard drive passwords.

 **NOTICE:** Passwords provide a high level of security for data in your computer or hard drive. However, they are not foolproof. If you require more security, obtain and use additional forms of protection, such as smart cards, data encryption programs, or PC Cards with encryption features.

When using passwords, observe the following guidelines:

- Choose passwords that you can remember, but not ones that are easy to guess. For example, do not use the names of family members or pets for passwords.
- It is recommended that you do not write down passwords. If you do write it down, however, ensure that the password is stored in a secure place.
- Do not share passwords with other people.
- Ensure that people are not watching you when you type your password(s).

 **NOTICE:** Passwords provide a high level of security for data in your computer or hard drive. However, they are not foolproof. If you require more security, obtain and use additional forms of protection, such as smart cards, data encryption programs, or PC Cards with encryption features.

If you forget any of your passwords, contact Dell (see "Contacting Dell" on page 128). For your protection, Dell technical support staff will ask you for proof of your identity to ensure that only an authorized person can use the computer.

## Using a Primary (or System) Password

The primary password allows you to protect the computer from unauthorized access.

When you first start your computer, you must assign a primary password at the prompt.

If you do not enter a password within 2 minutes, the computer returns to its previous operating state.



**NOTICE:** If you disable the administrator password, the primary password is also disabled.

To add or change passwords, access **User Accounts** from the **Control Panel**.

If you have assigned an administrator password, you can use it instead of the primary password. The computer does not specifically prompt you for the administrator password.

## Using an Administrator Password

The administrator password is designed to give system administrators or service technicians access to computers for repair or reconfiguration. The administrators or technicians can assign identical administrator passwords to groups of computers, allowing you to assign a unique primary password.

To set or change administrator passwords, access **User Accounts** from the **Control Panel**.

When you set an administrator password, the **Configure Setup** option becomes available in system setup. The **Configure Setup** option allows you to restrict access to system setup in the same way that a primary password restricts access to the computer.

The administrator password can be used instead of the primary password. Whenever you are prompted to enter the primary password, you can enter the administrator password.



**NOTICE:** If you disable the administrator password, the primary password is also disabled.



**NOTE:** The administrator password provides access to the computer, but it does not provide access to the hard drive when a hard drive password is assigned.

If you forget the primary password and do not have an administrator password assigned, or if you have both a primary and an administrator password assigned but forget them both, contact your system administrator or contact Dell (see "Contacting Dell" on page 128).

## Using a Hard Drive Password

The hard drive password helps protect the data on your hard drive from unauthorized access. You can also assign a password for an external hard drive (if one is being used) that can be the same as or different from the password for the primary hard drive.

To assign or change a hard drive password, enter system setup (see "System Setup Program" on page 91).

After assigning a hard drive password, you must enter it each time you turn on the computer and each time you restore the computer to normal operation from standby mode.

If the hard drive password is enabled, you must enter it each time you turn on the computer: A message appears asking for the hard drive password.

To continue, enter your password (with no more than eight characters) and press <Enter>.



If you do not enter a password within 2 minutes, the computer returns to its previous operating state. If you enter the wrong password, a message tells you that the password is invalid. Press <Enter> to try again.

If you do not enter the correct password in three attempts, the computer tries to start from another bootable device if the **Boot First Device** option in system setup is set to allow start-up from another device. If the **Boot First Device** option is not set to allow the computer to start from another device, the computer returns to the operating state it was in when you turned it on.

If the hard drive password, the external hard-drive password, and the primary password are the same, the computer prompts you only for the primary password. If the hard drive password is different from the primary password, the computer prompts you for both. Two different passwords provide greater security.

 **NOTE:** The administrator password provides access to the computer, but it does not provide access to the hard drive when a hard drive password is assigned.

## Trusted Platform Module (TPM)

 **NOTE:** Computers shipping into China are not equipped with the TPM feature.

 **NOTE:** The TPM feature supports encryption only if the operating system supports TPM. For more information, see the TPM software documentation and the help files that came with the software.

TPM is a hardware-based security feature that can be used to create and manage computer-generated encryption keys. When combined with security software, the TPM enhances existing network and computer security by enabling features such as file protection capabilities and protected e-mail. The TPM feature is enabled through a system setup option.

 **NOTICE:** To secure your TPM data and encryption keys, follow the backup procedures documented in the *Broadcom Secure Foundation Getting Started Guide*. In the event of these backups being incomplete, lost, or damaged, Dell will be unable to assist in the recovery of encrypted data.

### Enabling the TPM Feature

- 1 Enable the TPM software:
  - a Restart the computer and press <F2> during the Power On Self Test to enter the system setup program.
  - b Select **Security**→**TPM Security** and press <Enter>.
  - c Under **TPM Security**, select **On**.
  - d Press <Esc> to exit the setup program.
  - e If prompted, click **Save/Exit**.
- 2 Activate the TPM setup program:
  - a Restart the computer and press <F2> during the Power On Self Test to enter the system setup program.
  - b Select **Security**→**TPM Activation** and press <Enter>.

- c Under **TPM Activation**, select **Activate** and press <Enter>.

 **NOTE:** You only need to activate the program once.

- d Once the process is complete, the computer either restarts automatically or prompts you to restart your computer.

## Security Management Software

The security management software is designed to utilize four different features to help you secure your computer:

- Log-in management
- Pre-boot authentication (using a fingerprint reader, smart card, or password)
- Encryption
- Private information management

### Using the Security Management Software

For information about how to use the software and the different security features, see the *Getting Started Guide* for the software:

Click **Start**→ **All Programs**→ **Wave EMBASSY Trust Suite**→ **Getting Started Guide**.

## Computer Tracking Software

Computer tracking software may enable you to locate your computer if it is lost or stolen. The software is optional and may be purchased when you order your Dell™ computer, or you can contact your Dell sales representative for information about this security feature.

 **NOTE:** Computer tracking software may not be available in certain countries.

 **NOTE:** If you have computer tracking software and your computer is lost or stolen, you must contact the company that provides the tracking service to report the missing computer.

## If Your Computer Is Lost or Stolen

- Call a law enforcement agency to report the lost or stolen computer. Include the Service Tag in your description of the computer. Ask that a case number be assigned and write down the number, along with the name, address, and phone number of the law enforcement agency. If possible, obtain the name of the investigating officer.

 **NOTE:** If you know where the computer was lost or stolen, call a law enforcement agency in that area. If you do not know, call a law enforcement agency where you live.

- If the computer belongs to a company, notify the security office of the company.

- Contact Dell customer service to report the missing computer. Provide the computer Service Tag, the case number, and the name, address, and phone number of the law enforcement agency to which you reported the missing computer. If possible, give the name of the investigating officer.

The Dell customer service representative will log your report under the computer Service Tag and record the computer as missing or stolen. If someone calls Dell for technical assistance and gives your Service Tag, the computer is identified automatically as missing or stolen. The representative will attempt to get the phone number and address of the caller. Dell will then contact the law enforcement agency to which you reported of the missing computer.



# Cleaning Your Computer

 **CAUTION:** Before you begin any of the procedures in this section, follow the safety instructions in the *Product Information Guide*.

## Computer, Keyboard, and Display

 **CAUTION:** Before you clean your computer, disconnect the computer from the electrical outlet and remove any installed batteries. Clean your computer with a soft cloth dampened with water. Do not use liquid or aerosol cleaners, which may contain flammable substances.

- Use a can of compressed air to remove dust from between the keys on the keyboard.
- ➡ **NOTICE:** To avoid damaging the computer or display, do not spray cleaning solution directly onto the display. Only use products specifically designed for cleaning displays, and follow the instructions that are included with the product.
- Moisten a soft, lint-free cloth with either water or a display cleaner, and wipe the display until it is clean.
- Moisten a soft, lint-free cloth with water and wipe the computer and keyboard. Do not allow water from the cloth to seep between the touch pad and the surrounding palm rest.

## Touch Pad

- 1 Shut down and turn off your computer.
- 2 Disconnect any attached devices from the computer and from their electrical outlets.
- 3 Remove any installed batteries (see "Replacing the Battery" on page 33).
- 4 Moisten a soft, lint-free cloth with water, and wipe it gently across the surface of the touch pad. Do not allow water from the cloth to seep between the touch pad and the surrounding palm rest.

## Floppy Drive

➡ **NOTICE:** Do not attempt to clean drive heads with a swab. You might accidentally misalign the heads which prevents the drive from operating.

Clean your floppy drive using a commercially available cleaning kit. These kits contain pretreated floppy disks to remove contaminants that accumulate during normal operation.

## Optical Disks

- ➡ **NOTICE:** Always use compressed air to clean the lens in the optical drive, and follow the instructions that come with the compressed-air product. Never touch the lens in the drive.

If you notice problems, such as skipping, with the playback quality of your optical disks, try cleaning them.

- 1 Hold the disk by its outer edge. You can also touch the inside edge of the center hole.

- ➡ **NOTICE:** To avoid damaging the surface, do not wipe in a circular motion around the disk.

- 2 With a soft, lint-free cloth, gently wipe the bottom of the disk (the unlabeled side) in a straight line from the center to the outer edge of the disk.

For stubborn dirt, try using water or a diluted solution of water and mild soap. You can also purchase commercial products that clean disks and provide some protection from dust, fingerprints, and scratches. Cleaning products for CDs are also safe to use on DVDs.

# Troubleshooting

## Dell Technical Update Service

The Dell Technical Update service provides proactive e-mail notification of software and hardware updates for your computer. The service is free and can be customized for content, format, and how frequently you receive notifications.

To enroll for the Dell Technical Update service, go to [support.dell.com/technicalupdate](http://support.dell.com/technicalupdate).

## Dell Diagnostics

 **CAUTION:** Before you begin any of the procedures in this section, follow the safety instructions in the *Product Information Guide*.

### When to Use the Dell Diagnostics

If you experience a problem with your computer, run the Dell Diagnostics before you contact Dell for technical assistance.

It is recommended that you print these procedures before you begin.

 **NOTICE:** The Dell Diagnostics works only on Dell™ computers.

 **NOTE:** The *Drivers and Utilities* media is optional and may not ship with your computer.

Enter the system setup program, review your computer's configuration information, and ensure that the device you want to test displays in the system setup program and is active.

Start the Dell Diagnostics from your hard drive or from the *Drivers and Utilities* media.

### Starting the Dell Diagnostics From Your Hard Drive

The Dell Diagnostics is located on a hidden diagnostic utility partition on your hard drive.

 **NOTE:** If your computer cannot display a screen image, contact Dell (see "Contacting Dell" on page 128).

 **NOTE:** If the computer is connected to a docking device (docked), undock it. See the documentation that came with your docking device for instructions.

- 1 Ensure that the computer is connected to an electrical outlet that is known to be working properly.
- 2 Turn on (or restart) your computer.
- 3 Start the Dell Diagnostics in one of the following two ways:

- a When the DELL™ logo appears, press <F12> immediately. Select Diagnostics from the boot menu and press <Enter>.

 **NOTE:** If you wait too long and the operating system logo appears, continue to wait until you see the Microsoft® Windows® desktop; then, shut down your computer and try again.

 **NOTE:** Before attempting option B, the computer must be powered down completely.

- b Press and hold the <Fn> key while powering the computer on.

 **NOTE:** If you see a message stating that no diagnostics utility partition has been found, run the Dell Diagnostics from the *Drivers and Utilities* media.

The computer runs the Pre-boot System Assessment (PSA), a series of initial tests of your system board, keyboard, display, memory, hard drive, etc.

- During the assessment, answer any questions that appear.
- If failures are detected during the Pre-boot System Assessment, write down the error code(s) and see "Contacting Dell" on page 128.

If the Pre-boot System Assessment completes successfully, you will receive the message, "Booting Dell Diagnostic Utility Partition. Press any key to continue".

- 4 Press any key to start the Dell Diagnostics from the diagnostics utility partition on your hard drive.

## Starting the Dell Diagnostics From the Drivers and Utilities media

- 1 Insert the *Drivers and Utilities* media.
- 2 Shut down and restart the computer.

When the DELL logo appears, press <F12> immediately.

 **NOTE:** If you wait too long and the operating system logo appears, continue to wait until you see the Microsoft® Windows® desktop; then, shut down your computer and try again.

 **NOTE:** The next steps change the boot sequence for one time only. On the next start-up, the computer boots according to the devices specified in the system setup program.

- 3 When the boot device list appears, highlight CD/DVD/CD-RW and press <Enter>.
- 4 Select the **Boot from CD-ROM** option from the menu that appears and press <Enter>.
- 5 Type 1 to start the CD menu and press <Enter> to proceed.
- 6 Select **Run the 32 Bit Dell Diagnostics** from the numbered list. If multiple versions are listed, select the version appropriate for your computer.
- 7 When the Dell Diagnostics **Main Menu** screen appears, select the test you want to run.

## Dell Diagnostics Main Menu

- 1 After the Dell Diagnostics loads and the **Main Menu** screen appears, click the button for the option you want.

 **NOTE:** It is recommended that you select **Test System** to run a complete test on your computer.



Option	Function
Test Memory	Run the stand-alone memory test
Test System	Run System Diagnostics
Exit	Exit the Diagnostics

2 After you have selected the **Test System** option from the main menu, the following menu appears.



**NOTE:** It is recommended that you select **Extended Test** from the menu below to run a more thorough check of devices in the computer.

Option	Function
Express Test	Performs a quick test of devices in the system. This typically can take 10 to 20 minutes.
Extended Test	Performs a thorough check of devices in the system. This typically can take an hour or more.
Custom Test	Use to test a specific device or customize the tests to be run.
Symptom Tree	This option allows you to select tests based on a symptom of the problem you are having. This option lists the most common symptoms.

3 If a problem is encountered during a test, a message appears with an error code and a description of the problem. Write down the error code and problem description and contact Dell (see "Contacting Dell" on page 128).



**NOTE:** The Service Tag for your computer is located at the top of each test screen. If you contact Dell, technical support will ask for your Service Tag.

4 If you run a test from the **Custom Test** or **Symptom Tree** option, click the applicable tab described in the following table for more information.

Tab	Function
Results	Displays the results of the test and any error conditions encountered.
Errors	Displays error conditions encountered, error codes, and the problem description.

Tab	Function ( <i>continued</i> )
Help	Describes the test and may indicate requirements for running the test.
Configuration	Displays your hardware configuration for the selected device.  The Dell Diagnostics obtains configuration information for all devices from system setup, memory, and various internal tests, and it displays the information in the device list in the left pane of the screen. The device list may not display the names of all the components installed on your computer or all devices attached to your computer.
Parameters	Allows you to customize the test by changing the test settings.

- 5 When the tests are complete, close the test screen to return to the **Main Menu** screen. To exit the Dell Diagnostics and restart the computer, close the **Main Menu** screen.
- 6 Remove the *Dell Drivers and Utilities* media (if applicable).

## Dell Support Utility

The Dell Support Utility is installed on your computer and available from the Dell Support, , icon on the taskbar or from the **Start** button. Use this support utility for self-support information, software updates, and health scans of your computing environment.

### Accessing the Dell Support Utility

Access the Dell Support Utility from the  icon on the taskbar or from the **Start** menu.

If the Dell Support icon does not appear in your taskbar:

- 1 Click **Start**→ **All Programs**→ **Dell Support**→ **Dell Support Settings**.
- 2 Ensure that the **Show icon on the taskbar** option is checked.

**NOTE:** If the Dell Support Utility is not available from the **Start** menu, go to [support.dell.com](http://support.dell.com) and download the software.

The Dell Support Utility is customized for your computing environment.

The  icon in the taskbar functions differently when you click, double-click, or right-click the icon.

### Clicking the Dell Support Icon

Click or right-click the  icon to perform the following tasks:

- Check your computing environment
- View the Dell Support Utility settings
- Access the help file for the Dell Support Utility
- View frequently asked questions
- Learn more about the Dell Support Utility
- Turn the Dell Support Utility off

## Double-Clicking the Dell Support Icon

Double-click the  icon to manually check your computing environment, view frequently asked questions, access the help file for the Dell Support Utility, and view Dell Support settings.

For more information about the Dell Support Utility, click the question mark (?) at the top of the **Dell™ Support** screen.

## Drive Problems

 **CAUTION:** Before you begin any of the procedures in this section, follow the safety instructions in the *Product Information Guide*.

Fill out the Diagnostics Checklist (see "Dell Diagnostics" on page 71) as you complete these checks.

### ENSURE THAT MICROSOFT® WINDOWS® RECOGNIZES THE DRIVE —

In *Windows XP*:

- Click **Start** → **My Computer**.

In *Windows Vista*®:

- Click the *Windows Vista* Start button,  → **Computer**.

If the floppy, CD, or DVD drive, is not listed, perform a full scan with your antivirus software to check for and remove viruses. Viruses can sometimes prevent Windows from recognizing the drive.

### TEST THE DRIVE —

- Insert another floppy disk, CD, or DVD to eliminate the possibility that the original one is defective.
- Insert a bootable floppy disk and restart the computer.

**CLEAN THE DRIVE OR DISK** — See "Cleaning Your Computer" on page 69.

### ENSURE THAT THE CD IS SNAPPED ONTO THE SPINDLE

### CHECK THE CABLE CONNECTIONS

**CHECK FOR HARDWARE INCOMPATIBILITIES** — See "Troubleshooting Software and Hardware Problems in the Microsoft® Windows® XP and Microsoft Windows Vista® Operating Systems" on page 98.

**RUN THE DELL DIAGNOSTICS** — See "Dell Diagnostics" on page 71.

## Optical drive problems



**NOTE:** High-speed optical drive vibration is normal and may cause noise, which does not indicate a defect in the drive, CD, or DVD.



**NOTE:** Because of different regions worldwide and different disc formats, not all DVD titles work in all DVD drives.

### Problems writing to an optical drive

**CLOSE OTHER PROGRAMS** — The CD/DVD-RW drive must receive a steady stream of data when writing. If the stream is interrupted, an error occurs. Try closing all programs before you write to the CD/DVD-RW.

**TURN OFF STANDBY MODE IN WINDOWS BEFORE WRITING TO A CD/DVD-RW DISK** — See "Standby and Sleep Mode" on page 31 or search for the keyword *standby* in the Windows Help and Support Center for information on power management modes.

**CHANGE THE WRITE SPEED TO A SLOWER RATE** — See the help files for your CD or DVD creation software.

### If you cannot eject the optical drive tray

- 1 Ensure that the computer is turned off.
- 2 Straighten a paper clip and insert one end into the eject hole at the front of the drive; push firmly until the tray is partially ejected.
- 3 Gently pull out the tray until it stops.

### If you hear an unfamiliar scraping or grinding sound

- Ensure that the sound is not caused by the program that is running.
- Ensure that the disk or disc is inserted properly.

## Hard drive problems

**ALLOW THE COMPUTER TO COOL BEFORE TURNING IT ON** — A hot hard drive may prevent the operating system from starting. Try allowing the computer to return to room temperature before turning it on.

### RUN CHECK DISK —

For *Windows XP*:

- 1 Click Start → My Computer.
- 2 Right-click Local Disk C:.
- 3 Click Properties → Tools → Check Now.
- 4 Click Scan for and attempt recovery of bad sectors → Start.

For *Windows Vista*:

- 1 Click the Windows Vista Start button,  → Computer.
- 2 Right-click Local Disk C:.
- 3 Click Properties → Tools → Check Now.

 **NOTE:** The **User Account Control** window may appear. If you are an administrator on the computer, click **Continue**; otherwise, contact your administrator to continue the desired action.

- 4 Click **Scan for and attempt recovery of bad sectors**→ **Start**.

## E-Mail, Modem, and Internet Problems

 **CAUTION:** Before you begin any of the procedures in this section, follow the safety instructions in the *Product Information Guide*.

 **NOTE:** Connect the modem to an analog telephone connector only. The modem does not operate while it is connected to a digital telephone network.

**CHECK THE MICROSOFT OUTLOOK® EXPRESS SECURITY SETTINGS** — If you cannot open your e-mail attachments:

- 1 In Outlook Express, click **Tools**→ **Options**→ **Security**.
- 2 Click **Do not allow attachments** to remove the checkmark.

**CHECK THE TELEPHONE LINE CONNECTION**

**CHECK THE TELEPHONE CONNECTOR**

**CONNECT THE MODEM DIRECTLY TO THE TELEPHONE WALL CONNECTOR**

**USE A DIFFERENT TELEPHONE LINE** —

- Verify that the telephone line is connected to the connector on the modem. (The connector has either a green label or a connector-shaped icon next to it.)
- Ensure that you insert the telephone line connector into the modem until it clicks.
- Disconnect the telephone line from the modem and connect it to a telephone. Listen for a dial tone.
- If you have other telephone devices sharing the line, such as an answering machine, fax machine, surge protector, or line splitter, bypass the devices and connect the modem directly to the telephone wall connector. If you are using a line that is 3 m (10 ft) or more in length, try a shorter one.

**RUN THE MODEM HELPER DIAGNOSTICS** — Click **Start**→ **All Programs**→ **Modem Helper**. Follow the instructions on the screen to identify and resolve modem problems. (Modem Helper is not available on certain computers.)

**VERIFY THAT THE MODEM IS COMMUNICATING WITH WINDOWS** —

- 1 Click **Start**→ **Control Panel**→ **Printers and Other Hardware**→ **Phone and Modem Options**→ **Modems**.
- 2 Click the COM port for your modem→ **Properties**→ **Diagnostics**→ **Query Modem** to verify that the modem is communicating with Windows.

If all commands receive responses, the modem is operating properly.

**ENSURE THAT YOU ARE CONNECTED TO THE INTERNET** — Ensure that you have subscribed to an Internet provider. With the Outlook Express e-mail program open, click **File**. If **Work Offline** has a checkmark next to it, click the checkmark to remove it and connect to the Internet. For help, contact your Internet service provider.

**SCAN THE COMPUTER FOR SPYWARE** — If you are experiencing slow computer performance, you frequently receive pop-up advertisements, or you are having problems connecting to the Internet, your computer might be infected with spyware. Use an anti-virus program that includes anti-spyware protection (your program may require

an upgrade) to scan the computer and remove spyware. For more information, go to [support.dell.com](http://support.dell.com) and search for the keyword *spyware*.

## Error Messages

Fill out the Diagnostics Checklist (see "Diagnostics Checklist" on page 129) as you complete these checks.



**CAUTION:** Before you begin any of the procedures in this section, follow the safety instructions in the *Product Information Guide*.

If the message is not listed, see the documentation for the operating system or the program that was running when the message appeared.

**AUXILIARY DEVICE FAILURE** — The touch pad, track stick, or external mouse may be faulty. For an external mouse, check the cable connection. Enable the Pointing Device option in the system setup program. If the problem persists, contact Dell (see "Contacting Dell" on page 128).

**BAD COMMAND OR FILE NAME** — Ensure that you have spelled the command correctly, put spaces in the proper place, and used the correct pathname.

**CACHE DISABLED DUE TO FAILURE** — The primary cache internal to the microprocessor has failed. Contact Dell (see "Contacting Dell" on page 128).

**CD DRIVE CONTROLLER FAILURE** — The CD drive does not respond to commands from the computer (see "Dell Support Utility" on page 74).

**DATA ERROR** — The hard drive cannot read the data (see "Dell Support Utility" on page 74).

**DECREASING AVAILABLE MEMORY** — One or more memory modules may be faulty or improperly seated. Reinstall the memory modules and, if necessary, replace them (see "Memory" on page 108).

**DISK C: FAILED INITIALIZATION** — The hard drive failed initialization. Run the hard drive tests in the Dell Diagnostics (see "Dell Diagnostics" on page 71).

**DRIVE NOT READY** — The operation requires a hard drive in the bay before it can continue. Install a hard drive in the hard drive bay (see "Hard Drive" on page 105).

**ERROR READING PCMCIA CARD** — The computer cannot identify the PC Card. Reinsert the card or try another PC Card (see "Using Cards" on page 55).

**EXTENDED MEMORY SIZE HAS CHANGED** — The amount of memory recorded in NVRAM does not match the memory installed in the computer. Restart the computer. If the error appears again, contact Dell (see "Contacting Dell" on page 128).

**THE FILE BEING COPIED IS TOO LARGE FOR THE DESTINATION DRIVE** — The file that you are trying to copy is too large to fit on the disk, or the disk is too full. Try copying the file to a different disk or use a larger capacity disk.

**A FILENAME CANNOT CONTAIN ANY OF THE FOLLOWING CHARACTERS: \ / : \* ? " < > |** — Do not use these characters in filenames.

**GATE A20 FAILURE** — A memory module may be loose. Reinstall the memory modules and, if necessary, replace them (see "Memory" on page 108).

**GENERAL FAILURE** — The operating system is unable to carry out the command. The message is usually followed by specific information—for example, *Printer out of paper*. Take the appropriate action.

**HARD-DISK DRIVE CONFIGURATION ERROR** — The computer cannot identify the drive type. Shut down the computer, remove the hard drive (see "Hard Drive" on page 105), and boot the computer from a CD. Then shut down the computer, reinstall the hard drive, and restart the computer. Run the Hard-Disk Drive tests in the Dell Diagnostics (see "Dell Diagnostics" on page 71).

**HARD-DISK DRIVE CONTROLLER FAILURE 0** — The hard drive does not respond to commands from the computer. Shut down the computer, remove the hard drive (see "Hard Drive" on page 105), and boot the computer from a CD. Then shut down the computer, reinstall the hard drive, and restart the computer. If the problem persists, try another drive. Run the Hard-Disk Drive tests in the Dell Diagnostics (see "Dell Diagnostics" on page 71).

**HARD-DISK DRIVE FAILURE** — The hard drive does not respond to commands from the computer. Shut down the computer, remove the hard drive (see "Hard Drive" on page 105), and boot the computer from a CD. Then shut down the computer, reinstall the hard drive, and restart the computer. If the problem persists, try another drive. Run the Hard-Disk Drive tests in the Dell Diagnostics (see "Dell Diagnostics" on page 71).

**HARD-DISK DRIVE READ FAILURE** — The hard drive may be defective. Shut down the computer, remove the hard drive (see "Hard Drive" on page 105), and boot the computer from a CD. Then shut down the computer, reinstall the hard drive, and restart the computer. If the problem persists, try another drive. Run the Hard-Disk Drive tests in the Dell Diagnostics (see "Dell Diagnostics" on page 71).

**INSERT BOOTABLE MEDIA** — The operating system is trying to boot to a nonbootable CD. Insert a bootable CD.

**INVALID CONFIGURATION INFORMATION-PLEASE RUN SYSTEM SETUP PROGRAM** — The system configuration information does not match the hardware configuration. The message is most likely to occur after a memory module is installed. Correct the appropriate options in the system setup program (see "System Setup Program" on page 91).

**KEYBOARD CLOCK LINE FAILURE** — For external keyboards, check the cable connection. Run the Keyboard Controller test in the Dell Diagnostics (see "Dell Diagnostics" on page 71).

**KEYBOARD CONTROLLER FAILURE** — For external keyboards, check the cable connection. Restart the computer, and avoid touching the keyboard or the mouse during the boot routine. Run the Keyboard Controller test in the Dell Diagnostics (see "Dell Diagnostics" on page 71).

**KEYBOARD DATA LINE FAILURE** — For external keyboards, check the cable connection. Run the Keyboard Controller test in the Dell Diagnostics (see "Dell Diagnostics" on page 71).

**KEYBOARD STUCK KEY FAILURE** — For external keyboards or keypads, check the cable connection. Restart the computer, and avoid touching the keyboard or keys during the boot routine. Run the Stuck Key test in the Dell Diagnostics (see "Dell Diagnostics" on page 71).

**MEMORY ADDRESS LINE FAILURE AT ADDRESS, READ VALUE EXPECTING VALUE** — A memory module may be faulty or improperly seated. Reinstall the memory modules and, if necessary, replace them (see "Memory" on page 108).

**MEMORY ALLOCATION ERROR** — The software you are attempting to run is conflicting with the operating system, another program, or a utility. Shut down the computer, wait 30 seconds, and then restart it. Try to run the program again. If the error message still appears, see the software documentation.

**MEMORY DATA LINE FAILURE AT ADDRESS, READ VALUE EXPECTING VALUE** — A memory module may be faulty or improperly seated. Reinstall the memory modules (see "Memory" on page 108) and, if necessary, replace them.

**MEMORY DOUBLE WORD LOGIC FAILURE AT ADDRESS, READ VALUE EXPECTING VALUE** — A memory module may be faulty or improperly seated. Reinstall the memory modules (see "Memory" on page 108) and, if necessary, replace them.

**MEMORY ODD/EVEN LOGIC FAILURE AT ADDRESS, READ VALUE EXPECTING VALUE** — A memory module may be

faulty or improperly seated. Reinstall the memory modules (see "Memory" on page 108) and, if necessary, replace them.

**MEMORY WRITE/READ FAILURE AT ADDRESS, READ VALUE EXPECTING VALUE** — A memory module may be faulty or improperly seated. Reinstall the memory modules (see "Memory" on page 108) and, if necessary, replace them.

**NO BOOT DEVICE AVAILABLE** — The computer cannot find the hard drive. If the hard drive is your boot device, ensure that the drive is installed, properly seated, and partitioned as a boot device.

**NO BOOT SECTOR ON HARD DRIVE** — The operating system may be corrupted. Contact Dell (see "Contacting Dell" on page 128).

**NO TIMER TICK INTERRUPT** — A chip on the system board may be malfunctioning. Run the System Set tests in the Dell Diagnostics (see "Dell Diagnostics" on page 71).

**NOT ENOUGH MEMORY OR RESOURCES. EXIT SOME PROGRAMS AND TRY AGAIN** — You have too many programs open. Close all windows and open the program that you want to use.

**OPERATING SYSTEM NOT FOUND** — Reinstall the hard drive (see "Hard Drive" on page 105). If the problem persists, contact Dell (see "Contacting Dell" on page 128).

**OPTIONAL ROM BAD CHECKSUM** — The optional ROM apparently failed. A required DLL file was not found. Contact Dell (see "Contacting Dell" on page 128).

The program that you are trying to open is missing an essential file. Remove and then reinstall the program.

- 1 Click **Start**→ **Control Panel**→ **Add or Remove Programs**.
- 2 Select the program you want to remove.
- 3 Click **Remove** or **Change/Remove** and follow the prompts on the screen.
- 4 See the program documentation for installation instructions.

**SECTOR NOT FOUND** — The operating system cannot locate a sector on the hard drive. You may have a defective sector or corrupted FAT on the hard drive. Run the Windows error-checking utility to check the file structure on the hard drive. See the Help and Support Center for instructions. If a large number of sectors are defective, back up the data (if possible), and then reformat the hard drive.

**SEEK ERROR** — The operating system cannot find a specific track on the hard drive.

**SHUTDOWN FAILURE** — A chip on the system board may be malfunctioning. Run the System Set tests in the Dell Diagnostics (see "Dell Diagnostics" on page 71).

**TIME-OF-DAY CLOCK LOST POWER** — System configuration settings are corrupted. Connect your computer to an electrical outlet to charge the battery. If the problem persists, try to restore the data by entering the system setup program. Then immediately exit the program. If the message reappears, contact Dell (see "Contacting Dell" on page 128).

**TIME-OF-DAY CLOCK STOPPED** — The reserve battery that supports the system configuration settings may require recharging. Connect your computer to an electrical outlet to charge the battery. If the problem persists, contact Dell (see "Contacting Dell" on page 128).

**TIME-OF-DAY NOT SET-PLEASE RUN THE SYSTEM SETUP PROGRAM** — The time or date stored in the system setup program does not match the system clock. Correct the settings for the **Date** and **Time** options (see "System Setup Program" on page 91).

**TIMER CHIP COUNTER 2 FAILED** — A chip on the system board may be malfunctioning. Run the System Set tests in



the Dell Diagnostics (see "Dell Diagnostics" on page 71).

**UNEXPECTED INTERRUPT IN PROTECTED MODE** — The keyboard controller may be malfunctioning, or a memory module may be loose. Run the System Memory tests and the Keyboard Controller test in the Dell Diagnostics (see "Dell Diagnostics" on page 71).

**X:\ IS NOT ACCESSIBLE. THE DEVICE IS NOT READY** — Insert a disk into the drive and try again.

**WARNING: BATTERY IS CRITICALLY LOW** — The battery is running out of charge. Replace the battery, or connect the computer to an electrical outlet. Otherwise, activate hibernate mode or shut down the computer.

## IEEE 1394 Device Problems

 **CAUTION:** Before you begin any of the procedures in this section, follow the safety instructions in the *Product Information Guide*.

**ENSURE THAT THE IEEE 1394 DEVICE IS RECOGNIZED BY WINDOWS** —

For *Windows XP*:

- 1 Click Start → Control Panel.
- 2 Under Pick a Category, click Performance and Maintenance.
- 3 Click System.
- 4 In the System Properties window, click the Hardware tab.
- 5 Click Device Manager.

For *Windows Vista*:

- 1 Click the Windows Vista Start button, , and click Control Panel → System and Maintenance → Device Manager.

 **NOTE:** The **User Account Control** window may appear. If you are an administrator on the computer, click **Continue**; otherwise, contact your administrator to continue the desired action.

If your IEEE 1394 device is listed, Windows recognizes the device.

**IF YOU HAVE PROBLEMS WITH AN IEEE 1394 DEVICE** —

If the device was provided by Dell, contact Dell (see "Contacting Dell" on page 128). If the device was provided by a different manufacturer, contact that manufacturer.

**ENSURE THAT THE IEEE 1394 DEVICE IS PROPERLY INSERTED INTO THE CONNECTOR**

## Keyboard Problems

 **CAUTION:** Before you begin any of the procedures in this section, follow the safety instructions in the *Product Information Guide*.

Fill out the Diagnostics Checklist (see "Diagnostics Checklist" on page 129) as you perform the various checks.

 **NOTE:** Use the integrated keyboard when running the Dell Diagnostics or the system setup program. When you attach an external keyboard, the integrated keyboard remains fully functional.

## External Keyboard problems

 **NOTE:** When you attach an external keyboard, the integrated keyboard remains fully functional.

**CHECK THE KEYBOARD CABLE** — Shut down the computer. Disconnect the keyboard cable and check it for damage, and firmly reconnect the cable.

If you are using a keyboard extension cable, disconnect it and connect the keyboard directly to the computer.

**CHECK THE EXTERNAL KEYBOARD** —

- 1 Shut down the computer, wait 1 minute, and turn it on again.
- 2 Verify that the numbers, capitals, and scroll lock lights on the keyboard blink during the boot routine.
- 3 From the Windows desktop, click **Start**→ **All Programs**→ **Accessories**→ **Notepad**.
- 4 Type some characters on the external keyboard and verify that they appear on the display.  
If you cannot verify these steps, you may have a defective external keyboard.

**TO VERIFY THAT THE PROBLEM IS WITH THE EXTERNAL KEYBOARD, CHECK THE INTEGRATED KEYBOARD** —

- 1 Shut down the computer.
- 2 Disconnect the external keyboard.
- 3 Turn on the computer.
- 4 From the Windows desktop, click **Start**→ **All Programs**→ **Accessories**→ **Notepad**.
- 5 Type some characters on the internal keyboard and verify that they appear on the display.  
If the characters appear now but did not with the external keyboard, you may have a defective external keyboard. Contact Dell (see "Contacting Dell" on page 128).

**RUN THE KEYBOARD DIAGNOSTICS TESTS** — Run the PC-AT Compatible Keyboards tests in the Dell Diagnostics (see "Dell Diagnostics" on page 71). If the tests indicate a defective external keyboard, contact Dell (see "Contacting Dell" on page 128).

## Unexpected characters

**DISABLE THE NUMERIC KEYPAD** — Press <Num Lk> to disable the numeric keypad if numbers are displayed instead of letters. Verify that the numbers lock light is not lit.

## Lockups and Software Problems

 **CAUTION:** Before you begin any of the procedures in this section, follow the safety instructions in the *Product Information Guide*.

## The computer does not start up

**ENSURE THAT THE AC ADAPTER IS FIRMLY CONNECTED TO THE COMPUTER AND TO THE ELECTRICAL OUTLET.**

## The computer stops responding



**NOTICE:** You might lose data if you are unable to perform an operating system shutdown.

**TURN THE COMPUTER OFF** — If you are unable to get a response by pressing a key on your keyboard or moving your mouse, press and hold the power button for at least 8 to 10 seconds until the computer turns off. Then restart your computer.

## A program stops responding or crashes repeatedly



**NOTE:** Software usually includes installation instructions in its documentation or on a floppy disk or CD.

**END THE PROGRAM** —

- 1 Press <Ctrl> <Shift> <Esc> simultaneously.
- 2 Click Task Manager.
- 3 Click Applications.
- 4 Click the program that is no longer responding.
- 5 Click End Task.

**CHECK THE SOFTWARE DOCUMENTATION** — If necessary, uninstall and then reinstall the program.

## A program is designed for an earlier Microsoft® Windows® operating system

**RUN THE PROGRAM COMPATIBILITY WIZARD** — The Program Compatibility Wizard configures a program so it runs in an environment similar to non-Windows XP operating system environments.

- 1 Click Start→ All Programs→ Accessories→ Program Compatibility Wizard→ Next.
- 2 Follow the instructions on the screen.

## A solid blue screen appears

**TURN THE COMPUTER OFF** — If you are unable to get a response by pressing a key on your keyboard or moving your mouse, press and hold the power button for at least 8 to 10 seconds until the computer turns off. Then restart your computer.

## Other software problems

**CHECK THE SOFTWARE DOCUMENTATION OR CONTACT THE SOFTWARE MANUFACTURER FOR TROUBLESHOOTING INFORMATION** —

- Ensure that the program is compatible with the operating system installed on your computer.
- Ensure that your computer meets the minimum hardware requirements needed to run the software. See the software documentation for information.
- Ensure that the program is installed and configured properly.

- Verify that the device drivers do not conflict with the program.
- If necessary, uninstall and then reinstall the program.

#### **BACK UP YOUR FILES IMMEDIATELY**

#### **USE A VIRUS-SCANNING PROGRAM TO CHECK THE HARD DRIVE, FLOPPY DISKS, OR CDS**

#### **SAVE AND CLOSE ANY OPEN FILES OR PROGRAMS AND SHUT DOWN YOUR COMPUTER THROUGH THE **Start** MENU**

**SCAN THE COMPUTER FOR SPYWARE** — If you are experiencing slow computer performance, you frequently receive pop-up advertisements, or you are having problems connecting to the Internet, your computer might be infected with spyware. Use an anti-virus program that includes anti-spyware protection (your program may require an upgrade) to scan the computer and remove spyware. For more information, go to [support.dell.com](http://support.dell.com) and search for the keyword *spyware*.

**RUN THE DELL DIAGNOSTICS** — See "Dell Diagnostics" on page 71. If all tests run successfully, the error condition is related to a software problem.

## Memory Problems

Fill out the Diagnostics Checklist (see "Contacting Dell" on page 128) as you complete these checks.



**CAUTION:** Before you begin any of the procedures in this section, follow the safety instructions in the *Product Information Guide*.

#### **IF YOU RECEIVE AN INSUFFICIENT MEMORY MESSAGE —**

- Save and close any open files and exit any open programs you are not using to see if that resolves the problem.
- See the software documentation for minimum memory requirements. If necessary, install additional memory (see "Memory" on page 108).
- Reseat the memory modules to ensure that your computer is successfully communicating with the memory (see "Memory" on page 108).
- Run the Dell Diagnostics (see "Dell Diagnostics" on page 71).

#### **IF YOU EXPERIENCE OTHER MEMORY PROBLEMS —**

- Reseat the memory modules (see "Memory" on page 108) to ensure that your computer is successfully communicating with the memory.
- Ensure that you are following the memory installation guidelines (see "Memory" on page 108).
- Run the Dell Diagnostics (see "Dell Diagnostics" on page 71).

## Network Problems



**CAUTION:** Before you begin any of the procedures in this section, follow the safety instructions in the *Product Information Guide*.

### General

**CHECK THE NETWORK CABLE CONNECTOR** — Ensure that the network cable is firmly inserted into both the

network connector on the back of the computer and the network connector.

**CHECK THE NETWORK LIGHTS ON THE NETWORK CONNECTOR** — No light indicates that no network communication exists. Replace the network cable.

**PLUG THE A/C POWER ADAPTER INTO THE COMPUTER** — If batter power only, the QuickSet utility can disable the onboard network card to save battery life. For more information on the QuickSet utility, see "Contacting Dell" on page 128.

**CHECK YOUR NETWORK SETTINGS** — Contact your network administrator or the person who set up your network to verify that your network settings are correct and that the tnetwork is functioning.

For more information on the different types of networks, see "Contacting Dell" on page 128.

## PC Card or ExpressCard Problems



**CAUTION:** Before you begin any of the procedures in this section, follow the safety instructions in the *Product Information Guide*.

**CHECK THE CARD** — Ensure that the card is properly inserted into the connector.

**ENSURE THAT THE CARD IS RECOGNIZED BY WINDOWS** — Double-click the Safely Remove Hardware icon in the Windows taskbar. Ensure that the card is listed.

**IF YOU HAVE PROBLEMS WITH A DELL-PROVIDED CARD** — Contact Dell (see "Contacting Dell" on page 128).

**IF YOU HAVE PROBLEMS WITH A CARD NOT PROVIDED BY DELL** — Contact the PC Card manufacturer.

## Power Problems

Fill out the Diagnostics Checklist (see "Diagnostics Checklist" on page 129) as you complete these checks.



**CAUTION:** Before you begin any of the procedures in this section, follow the safety instructions in the *Product Information Guide*.

**CHECK THE POWER LIGHT** — When the power light is lit or blinking, the computer has power. If the power light is blinking, the computer is in standby mode—press the power button to exit standby mode. If the light is off, press the power button to turn on the computer.

**CHARGE THE BATTERY** — The battery charge may be depleted.

- 1 Reinstall the battery.
- 2 Use the AC adapter to connect the computer to an electrical outlet.
- 3 Turn on the computer.



**NOTE:** Battery operating time (the time the battery can hold a charge) decreases over time. Depending on how often the battery is used and the conditions under which it is used, you may need to purchase a new battery during the life of your computer.

**CHECK THE BATTERY STATUS LIGHT** — If the battery status light flashes orange or is a steady orange the battery charge is low or depleted. Connect the computer to an electrical outlet.

If the battery status light flashes green and orange, the battery is too hot to charge. Shut down the computer, disconnect the computer from the electrical outlet, and then let the battery and computer cool to room temperature.

If the battery status light rapidly flashes orange, the battery may be defective. Contact Dell (see "Contacting Dell" on page 128).

**CHECK THE BATTERY TEMPERATURE** — If the battery temperature is below 0° C (32° F), the computer will not start up.

**TEST THE ELECTRICAL OUTLET** — Ensure that the electrical outlet is working by testing it with another device, such as a lamp.

**CHECK THE AC ADAPTER** — Check the AC adapter cable connections. If the AC adapter has a light, ensure that the light is on.

**CONNECT THE COMPUTER DIRECTLY TO AN ELECTRICAL OUTLET** — Bypass power protection devices, power strips, and the extension cable to verify that the computer turns on.

**ELIMINATE POSSIBLE INTERFERENCE** — Turn off nearby fans, fluorescent lights, halogen lamps, or other appliances.

**ADJUST THE POWER PROPERTIES** — See "Configuring Power Management Settings" on page 33.

**RESEAT THE MEMORY MODULES** — If the computer power light turns on but the display remains blank, reinstall the memory modules (see "Memory" on page 108).

## Ensuring Sufficient Power for Your Computer

Your computer is designed to use a 65-W or 90-W AC adapter. However, for optimum system performance, you should always use a 90-W adapter.

Using less-powerful AC adapters, including the 65-W AC adapter, will cause you to receive a **WARNING** message.

## Docking Power Considerations

Due to the extra power consumption when a computer is docked to the Dell D/Dock, normal computer operation is not possible on battery power alone. Ensure that the AC adapter is connected to your computer when the computer is docked to the Dell D/Dock.

### Docking While the Computer Is Running

If a computer is connected to the Dell D/Dock or Dell D/Port while the computer is running, presence of the docking device is ignored until the AC adapter is connected to the computer.

### AC Power Loss While the Computer Is Docked

If a computer loses AC power while docked to the Dell D/Dock or Dell D/Port, the computer immediately goes into low-performance mode.

## Printer Problems

Fill out the Diagnostics Checklist (see "Diagnostics Checklist" on page 129) as you complete these checks.

 **CAUTION:** Before you begin any of the procedures in this section, follow the safety instructions in the *Product Information Guide*.

 **NOTE:** If you need technical assistance for your printer, contact the printer's manufacturer.

**ENSURE THAT THE PRINTER IS TURNED ON**

**CHECK THE PRINTER CABLE CONNECTIONS** —

- See the printer documentation for cable connection information.
- Ensure that the printer cables are securely connected to the printer and the computer.

**TEST THE ELECTRICAL OUTLET** — Ensure that the electrical outlet is working by testing it with another device, such as a lamp.

**VERIFY THAT THE PRINTER IS RECOGNIZED BY WINDOWS** —

- 1 Click Start→ Control Panel→ Printers and Other Hardware→ View installed printers or fax printers.
- 2 If the printer is listed, right-click the printer icon.
- 3 Click Properties→ Ports. For a parallel printer, ensure that the **Print to the following port(s):** setting is LPT1 (Printer Port). For a USB printer, ensure that the **Print to the following port(s):** setting is USB.

**REINSTALL THE PRINTER DRIVER** — See the printer documentation for instructions.

## Scanner Problems

 **CAUTION:** Before you begin any of the procedures in this section, follow the safety instructions in the *Product Information Guide*.

 **NOTE:** If you need technical assistance for your scanner, contact the scanner's manufacturer.

**CHECK THE SCANNER DOCUMENTATION** — See the scanner documentation for setup and troubleshooting information.

**UNLOCK THE SCANNER** — Ensure that your scanner is unlocked if it has a locking tab or button.

**RESTART THE COMPUTER AND TRY THE SCANNER AGAIN**

**CHECK THE CABLE CONNECTIONS** —

- See the scanner documentation for cable connection information.
- Ensure that the scanner cables are securely connected to the scanner and the computer.

**VERIFY THAT THE SCANNER IS RECOGNIZED BY MICROSOFT WINDOWS** —

Click Start→ Control Panel→ Printers and Other Hardware→ Scanners and Cameras.

If your scanner is listed, Windows recognizes the scanner.

**REINSTALL THE SCANNER DRIVER** — See the scanner documentation for instructions.

## Sound and Speaker Problems

Fill out the Diagnostics Checklist (see "Diagnostics Checklist" on page 129) as you complete these checks.

 **CAUTION:** Before you begin any of the procedures in this section, follow the safety instructions in the *Product Information Guide*.

### No sound from integrated speakers

**ADJUST THE WINDOWS VOLUME CONTROL** — Double-click the speaker icon in the lower-right corner of your screen. Ensure that the volume is turned up and that the sound is not muted. Adjust the volume, bass, or treble controls to eliminate distortion.

**REINSTALL THE SOUND (AUDIO) DRIVER** — See "Reinstalling Drivers and Utilities" on page 96.

### No sound from external speakers

**ENSURE THAT THE SUBWOOFER AND THE SPEAKERS ARE TURNED ON** — See the setup diagram supplied with the speakers. If your speakers have volume controls, adjust the volume, bass, or treble to eliminate distortion.

**ADJUST THE WINDOWS VOLUME CONTROL** — Click or double-click the speaker icon in the lower-right corner of your screen. Ensure that the volume is turned up and that the sound is not muted.

**DISCONNECT HEADPHONES FROM THE HEADPHONE CONNECTOR** — Sound from the speakers is automatically disabled when headphones are connected to the computer's front-panel headphone connector.

**TEST THE ELECTRICAL OUTLET** — Ensure that the electrical outlet is working by testing it with another device, such as a lamp.

**ELIMINATE POSSIBLE INTERFERENCE** — Turn off nearby fans, fluorescent lights, or halogen lamps to check for interference.

**REINSTALL THE AUDIO DRIVER** — See "Reinstalling Drivers and Utilities" on page 96.

**RUN THE DELL DIAGNOSTICS** — See "Dell Diagnostics" on page 71.

 **NOTE:** The volume control in some MP3 players overrides the Windows volume setting. If you have been listening to MP3 songs, ensure that you did not turn the player volume down or off.

### No sound from headphones

**CHECK THE HEADPHONE CABLE CONNECTION** — Ensure that the headphone cable is securely inserted into the headphone connector.

**ADJUST THE WINDOWS VOLUME CONTROL** — Click or double-click the speaker icon in the lower-right corner of your screen. Ensure that the volume is turned up and that the sound is not muted.

## Touch Pad or Mouse Problems

**CHECK THE TOUCH PAD SETTINGS** —

- 1 Click Start → Control Panel → Printers and Other Hardware → Mouse.
- 2 Try adjusting the settings.



**CHECK THE MOUSE CABLE** — Shut down the computer. Disconnect the mouse cable, check it for damage, and firmly reconnect the cable.

If you are using a mouse extension cable, disconnect it and connect the mouse directly to the computer.

**TO VERIFY THAT THE PROBLEM IS WITH THE MOUSE, CHECK THE TOUCH PAD** —

- 1 Shut down the computer.
- 2 Disconnect the mouse.
- 3 Turn on the computer.
- 4 At the Windows desktop, use the touch pad to move the cursor around, select an icon, and open it.

If the touch pad operates correctly, the mouse may be defective.

**CHECK THE SYSTEM SETUP PROGRAM SETTINGS** — Verify that the system setup program lists the correct device for the pointing device option. (The computer automatically recognizes a USB mouse without making any setting adjustments.) For more information on using the system setup program, see "System Setup Program" on page 91.

**TEST THE MOUSE CONTROLLER** — To test the mouse controller (which affects pointer movement) and the operation of the touch pad or mouse buttons, run the Mouse test in the **Pointing Devices** test group in the Dell Diagnostics (see "Dell Diagnostics" on page 71).

**REINSTALL THE TOUCH PAD DRIVER** — See "Reinstalling Drivers and Utilities" on page 96.

## Video and Display Problems

Fill out the Diagnostics Checklist (see "Diagnostics Checklist" on page 129) as you complete these checks.



**CAUTION:** Before you begin any of the procedures in this section, follow the safety instructions in the *Product Information Guide*.

### If the display is blank



**NOTE:** If you are using a program that requires a higher resolution than your computer supports, it is recommended that you attach an external monitor to your computer.

**CHECK THE BATTERY** — If you are using a battery to power your computer, the battery charge may be depleted. Connect the computer to an electrical outlet using the AC adapter, and turn on the computer.

**TEST THE ELECTRICAL OUTLET** — Ensure that the electrical outlet is working by testing it with another device, such as a lamp.

**CHECK THE AC ADAPTER** — Check the AC adapter cable connections. If the AC adapter has a light, ensure that the light is on.

**CONNECT THE COMPUTER DIRECTLY TO AN ELECTRICAL OUTLET** — Bypass power protection devices, power strips, and the extension cable to verify that the computer turns on.

**ADJUST THE POWER PROPERTIES** — Search for the keyword *standby* in the Windows Help and Support Center. Click Start or  → Help and Support.

**SWITCH THE VIDEO IMAGE** — If your computer is attached to an external monitor, press <Fn><F8> to switch the video image to the display.

## **If the display is difficult to read**

**ADJUST THE BRIGHTNESS** — Press <Fn> and the up- or down-arrow key.

**MOVE THE EXTERNAL SUBWOOFER AWAY FROM THE COMPUTER OR MONITOR** — If your external speaker system includes a subwoofer, ensure that the subwoofer is at least 60 cm (2 ft) away from the computer or external monitor.

**ELIMINATE POSSIBLE INTERFERENCE** — Turn off nearby fans, fluorescent lights, halogen lamps, or other appliances.

**ROTATE THE COMPUTER TO FACE A DIFFERENT DIRECTION** — Eliminate sunlight glare, which can cause poor picture quality.

**ADJUST THE WINDOWS DISPLAY SETTINGS** —

- 1 Click Start→ Control Panel→ Appearance and Themes.
- 2 Click the area you want to change or click the **Display** icon.
- 3 Try different settings for **Color quality** and **Screen resolution**.

**RUN THE VIDEO DIAGNOSTICS TESTS** — If no error message appears and you still have a display problem, but the display is not completely blank, run the **Video** device group in the Dell Diagnostics (see "Dell Diagnostics" on page 71). Then contact Dell (see "Contacting Dell" on page 128).

**SEE "ERROR MESSAGES"** — If an error message appears, see "Error Messages" on page 78.

## **If only part of the display is readable**



**CONNECT AN EXTERNAL MONITOR** —

- 1 Shut down your computer and connect an external monitor to the computer.
- 2 Turn on the computer and the monitor and adjust the monitor brightness and contrast controls.

If the external monitor works, the computer display or video controller may be defective. Contact Dell (see "Contacting Dell" on page 128).

# System Setup Program

## Overview

 **NOTE:** Your operating system may automatically configure most of the options available in the system setup program, thus overriding options that you set through the system setup program. (An exception is the **External Hot Key** option, which you can disable or enable only through the system setup program.) For more information on configuring features for your operating system, access the Help and Support Center. To access the Help and Support Center in Microsoft® Windows XP, click **Start** → **Help and Support**. In Microsoft Windows Vista®, click the Windows Vista Start button  → **Help and Support**.

You can use the system setup program as follows:

- To set or change user-selectable features—for example, your computer password
- To verify information about the computer's current configuration, such as the amount of system memory

After you set up the computer, run the system setup program to familiarize yourself with your system configuration information and optional settings. You may want to write down the information for future reference.

The system setup screens display the current setup information and settings for your computer, such as:

- System configuration
- Boot order
- Boot (start-up) configuration and docking-device configuration settings
- Basic device-configuration settings
- System security and hard-drive password settings

 **NOTE:** Unless you are an expert computer user or are directed to do so by Dell technical support, do not change the system setup settings. Certain changes might make your computer work incorrectly.

## Viewing the System Setup Screens

- 1 Turn on (or restart) your computer.
- 2 When the DELL™ logo appears, press <F2> immediately. If you wait too long and the Microsoft Windows logo appears, continue to wait until you see the Windows desktop. Then shut down your computer and try again.

## System Setup Screens

 **NOTE:** For information about a specific item on a system setup screen, highlight the item and see the **Help** area on the screen.

In the system setup program, primary categories of settings are listed on the left. To view the types of settings in a category, highlight the category and press <Enter>. When you highlight a setting type, the right side of the screen displays the value for that setting type. You can change settings that appear as white type on the screen. Values that you cannot change (because they are determined by the computer) appear less bright.

System-setup key functions are listed across the bottom of the screen.

## Commonly Used Options

Certain options require that you reboot the computer for new settings to take effect.

### Changing the Boot Sequence

The *boot sequence*, or *boot order*, tells the computer where to look to find the software needed to start the operating system. You can control the boot sequence and enable/disable devices using the **Boot Order** page of the system setup program.

 **NOTE:** To change the boot sequence on a one-time-only basis, see "Performing a One-Time Boot" on page 93.

The **Boot Order** page displays a general list of the bootable devices that may be installed in your computer, including but not limited to the following:

- Diskette Drive
- Modular bay HDD
- Internal HDD
- Optical Drive

During the boot routine, the computer starts at the top of the list and scans each enabled device for the operating system start-up files. When the computer finds the files, it stops searching and starts the operating system.

To control the boot devices, select (highlight) a device by pressing the down-arrow or up-arrow key, and then enable or disable the device or change its order in the list.

- To enable or disable a device, highlight the item and press the space bar. Enabled items appear as white and display a small triangle to the left; disabled items appear blue or dimmed without a triangle.
- To reorder a device in the list, highlight the device and then press <u> or <d> (not case-sensitive) to move the highlighted device up or down.

Boot sequence changes take effect as soon as you save the changes and exit the system setup program.

### **Performing a One-Time Boot**

You can set a one-time-only boot sequence without entering the system setup program. (You can also use this procedure to boot the Dell Diagnostics on the diagnostics utility partition on your hard drive.)

- 1** Shut down the computer through the **Start** menu.
- 2** If the computer is connected to a docking device (docked), undock it. See the documentation that came with your docking device for instructions.
- 3** Connect the computer to an electrical outlet.
- 4** Turn on the computer. When the DELL logo appears, press <F12> immediately.  
If you wait too long and the Windows logo appears, continue to wait until you see the Windows desktop. Then shut down your computer and try again.
- 5** When the boot device list appears, highlight the device from which you want to boot and press <Enter>.

The computer boots to the selected device.

The next time you reboot the computer, the previous boot order is restored.

### **Changing COM Ports**

**Serial Port** allows you to map the serial port COM address or disable the serial port and its address, which frees computer resources for another device to use.



# Reinstalling Software

## Drivers

### What Is a Driver?

A driver is a program that controls a device such as a printer, mouse, or keyboard. All devices require a driver program.

A driver acts like a translator between the device and any other programs that use the device. Each device has its own set of specialized commands that only its driver recognizes.

Dell ships your computer to you with required drivers already installed—no further installation or configuration is needed.

 **NOTICE:** The *Drivers and Utilities* media may contain drivers for operating systems that are not on your computer. Ensure that you are installing software appropriate for your operating system.

Many drivers, such as the keyboard driver, come with your Microsoft Windows operating system. You may need to install drivers if you:

- Upgrade your operating system.
- Reinstall your operating system.
- Connect or install a new device.

### Identifying Drivers

If you experience a problem with any device, identify whether the driver is the source of your problem and, if necessary, update the driver.

#### Microsoft® Windows® XP

- 1 Click Start→ Control Panel.
- 2 Under Pick a Category, click Performance and Maintenance, and click System.
- 3 In the System Properties window, click the Hardware tab, and click Device Manager.

#### Microsoft Windows Vista®

- 1 Click the Windows Vista start button, , and right-click Computer.
- 2 Click Properties→ Device Manager.



**NOTE:** The **User Account Control** window may appear. If you are an administrator on the computer, click **Continue**; otherwise, contact your administrator to continue.

Scroll down the list to see if any device has an exclamation point (a yellow circle with a [!]) on the device icon.

If an exclamation point is next to the device name, you may need to reinstall the driver or install a new driver (see "Reinstalling Drivers and Utilities" on page 96).

## Reinstalling Drivers and Utilities



**NOTICE:** The Dell Support website at [support.dell.com](http://support.dell.com) and your *Drivers and Utilities* media provide approved drivers for Dell™ computers. If you install drivers obtained from other sources, your computer might not work correctly.

### Using Windows Device Driver Rollback

If a problem occurs on your computer after you install or update a driver, use Windows Device Driver Rollback to replace the driver with the previously installed version.

*Windows XP:*

- 1 Click **Start**→ **My Computer**→ **Properties**→ **Hardware**→ **Device Manager**.
- 2 Right-click the device for which the new driver was installed and click **Properties**.
- 3 Click the **Drivers** tab→ **Roll Back Driver**.

*Windows Vista:*

- 1 Click the Windows Vista start button, , and right-click **Computer**.
- 2 Click **Properties**→ **Device Manager**.



**NOTE:** The **User Account Control** window may appear. If you are an administrator on the computer, click **Continue**; otherwise, contact your administrator to enter the Device Manager.

- 3 Right-click the device for which the new driver was installed and click **Properties**.
- 4 Click the **Drivers** tab→ **Roll Back Driver**.

If Device Driver Rollback does not resolve the problem, then use System Restore (see "Restoring Your Operating System" on page 98) to return your computer to the operating state that existed before you installed the new driver.

### Using the Drivers and Utilities media

If using Device Driver Rollback or System Restore (see "Restoring Your Operating System" on page 98) does not resolve the problem, then reinstall the driver from the *Drivers and Utilities* media.

- 1 Save and close any open files, and exit any open programs.
- 2 Insert the *Drivers and Utilities* media.

In most cases, the CD starts running automatically. If it does not, start Windows Explorer, click your CD drive directory to display the CD contents, and then double-click the **autorcd.exe** file. The first



time that you run the CD, it might prompt you to install setup files. Click **OK**, and follow the instructions on the screen to continue.

- 3 From the **Language** drop-down menu in the toolbar, select your preferred language for the driver or utility (if available).
- 4 At the welcome screen, click **Next** and wait for the CD to complete the hardware scan.
- 5 To detect other drivers and utilities, under **Search Criteria**, select the appropriate categories from the **System Model**, **Operating System**, and **Topic** drop-down menus.

A link or links appear(s) for the specific drivers and utilities used by your computer.

- 6 Click the link of a specific driver or utility to display information about the driver or utility that you want to install.
- 7 Click the **Install** button (if present) to begin installing the driver or utility. At the welcome screen, follow the screen prompts to complete the installation.

If no **Install** button is present, automatic installation is not an option. For installation instructions, either see the appropriate instructions in the following subsections, or click **Extract**, follow the extracting instructions, and then read the readme file.

If instructed to navigate to the driver files, click the CD directory on the driver information window to display the files associated with that driver.



### Manually Reinstalling Drivers

After extracting the driver files to your hard drive as described in the previous section:

*Windows XP:*

- 1 Click **Start**→ **My Computer**→ **Properties**→ **Hardware**→ **Device Manager**.
- 2 Double-click the type of device for which you are installing the driver (for example, **Audio** or **Video**).
- 3 Double-click the name of the device for which you are installing the driver.
- 4 Click the **Driver** tab→ **Update Driver**.
- 5 Click **Install from a list or specific location (Advanced)**→ **Next**.
- 6 Click **Browse** and browse to the location to which you previously copied the driver files.
- 7 When the name of the appropriate driver appears, click **Next**.
- 8 Click **Finish** and restart your computer.

*Windows Vista:*

- 1 Click the Windows Vista start button, , and right-click **Computer**.
  - 2 Click **Properties**→ **Device Manager**.
-  **NOTE:** The **User Account Control** window may appear. If you are an administrator on the computer, click **Continue**; otherwise, contact your administrator to enter the Device Manager.
- 3 Double-click the type of device for which you are installing the driver (for example, **Audio** or **Video**).

- 4 Double-click the name of the device for which you are installing the driver.
- 5 Click the **Driver** tab→ **Update Driver**→ **Browse my computer for driver software**.
- 6 Click **Browse** and browse to the location to which you previously copied the driver files.
- 7 When the name of the appropriate driver appears, click the name of the driver→ **OK**→ **Next**.
- 8 Click **Finish** and restart your computer.

## Troubleshooting Software and Hardware Problems in the Microsoft® Windows® XP and Microsoft Windows Vista® Operating Systems

If a device is either not detected during the operating system setup or is detected but incorrectly configured, you can use the Hardware Troubleshooter to resolve the incompatibility.

To start the Hardware Troubleshooter:

*Windows XP:*

- 1 Click **Start**→ **Help and Support**.
- 2 Type `hardware troubleshooter` in the search field and press <Enter> to start the search.
- 3 In the **Fix a Problem** section, click **Hardware Troubleshooter**.
- 4 In the **Hardware Troubleshooter** list, select the option that best describes the problem and click **Next** to follow the remaining troubleshooting steps.

*Windows Vista:*

- 1 Click the Windows Vista start button, , and click **Help and Support**.
- 2 Type `hardware troubleshooter` in the search field and press <Enter> to start the search.
- 3 In the search results, select the option that best describes the problem and follow the remaining troubleshooting steps.

## Restoring Your Operating System

You can restore your operating system in the following ways:

- Microsoft Windows XP System Restore and Microsoft Windows Vista™ System Restore return your computer to an earlier operating state without affecting data files. Use System Restore as the first solution for restoring your operating system and preserving data files.
- If you received an *Operating System* CD with your computer, you can use it to restore your operating system. However, using the *Operating System* CD also deletes all data on the hard drive. Use the CD *only* if System Restore did not resolve your operating system problem.

## Using Microsoft® Windows® System Restore

The Windows operating systems provide a System Restore option which allows you to return your computer to an earlier operating state (without affecting data files) if changes to the hardware, software, or other system settings have left the computer in an undesirable operating state. Any changes that System Restore makes to your computer are completely reversible.

 **NOTICE:** Make regular backups of your data files. System Restore does not monitor your data files or recover them.

 **NOTE:** The procedures in this document were written for the Windows default view, so they may not apply if you set your Dell™ computer to the Windows Classic view.

### Starting System Restore

*Windows XP:*

 **NOTICE:** Before you restore the computer to an earlier operating state, save and close any open files and exit any open programs. Do not alter, open, or delete any files or programs until the system restoration is complete.

- 1 Click **Start**→ **All Programs**→ **Accessories**→ **System Tools**→ **System Restore**.
- 2 Click either **Restore my computer to an earlier time** or **Create a restore point**.
- 3 Click **Next** and follow the remaining on-screen prompts.

*Windows Vista:*

- 1 Click the Windows Vista Start button, , and click **Help and Support**.
- 2 In the search box, type **System Restore** and press <Enter>.

 **NOTE:** The **User Account Control** window may appear. If you are an administrator on the computer, click **Continue**; otherwise, contact your administrator to continue the desired action.

- 3 Click **Next** and follow the remaining prompts on the screen.

In the event that System Restore did not resolve the issue, you may undo the last system restore.

### Undoing the Last System Restore

 **NOTICE:** Before you undo the last system restore, save and close all open files and exit any open programs. Do not alter, open, or delete any files or programs until the system restoration is complete.

*Windows XP:*

- 1 Click **Start**→ **All Programs**→ **Accessories**→ **System Tools**→ **System Restore**.
- 2 Click **Undo my last restoration** and click **Next**.

*Windows Vista:*

- 1 Click the Windows Vista Start button, , and click **Help and Support**.
- 2 In the search box, type **System Restore** and press <Enter>.
- 3 Click **Undo my last restoration** and click **Next**.

## Enabling System Restore

 **NOTE:** Windows Vista does not disable System Restore; regardless of low disk space. Therefore, the steps below apply only to Windows XP.

If you reinstall Windows XP with less than 200 MB of free hard-disk space available, System Restore is automatically disabled.

To see if System Restore is enabled:

- 1 Click **Start**→ **Control Panel**→ **Performance and Maintenance**→ **System**.
- 2 Click the **System Restore** tab and ensure that **Turn off System Restore** is unchecked.

## Removing Dell PC Restore

 **NOTICE:** Removing Dell PC Restore from the hard drive permanently deletes the PC Restore utility from your computer. After you have removed Dell PC Restore, you will not be able to use it to restore your computer operating system.

Dell PC Restore enables you to restore your hard drive to the operating state it was in when you purchased your computer. It is recommended that you *do not* remove PC Restore from your computer, even to gain additional hard-drive space. If you remove PC Restore from the hard drive, you cannot ever recall it, and you will never be able to use PC Restore to return your computer operating system to its original state.

- 1 Log on to the computer as a local administrator.
- 2 In Microsoft Windows Explorer, go to `c:\dell\utilities\DSR`.
- 3 Double-click the filename **DSRIRRemv2.exe**.

 **NOTE:** If you do not log on as a local administrator, a message appears stating that you that you must log on as administrator. Click **Quit**, and then log on as a local administrator.

 **NOTE:** If the partition for PC Restore does not exist on your computer hard drive, a message appears stating that the partition was not found. Click **Quit**; there is no partition to delete.

- 4 Click **OK** to remove the PC Restore partition on the hard drive.
- 5 Click **Yes** when a confirmation message appears.

The PC Restore partition is deleted and the newly available disk space is added to the free space allocation on the hard drive.

- 6 Right-click **Local Disk (C)** in Windows Explorer, click **Properties**, and verify that the additional disk space is available as indicated by the increased value for **Free Space**.
- 7 Click **Finish** to close the **PC Restore Removal** window and restart the computer.

## Using the Operating System CD

### Before You Begin

If you are considering reinstalling the Windows operating system to correct a problem with a newly installed driver, first try using Windows Device Driver Rollback. See "Using Windows Device Driver Rollback" on page 96. If Device Driver Rollback does not resolve the problem, then use System Restore to return your operating system to the operating state it was in before you installed the new device driver. See "Restoring Your Operating System" on page 98.

 **NOTICE:** Before performing the installation, back up all data files on your primary hard drive. For conventional hard drive configurations, the primary hard drive is the first drive detected by the computer.

To reinstall Windows , you need the following items:

- Dell™ Operating System CD
- Dell Drivers and Utilities media

 **NOTE:** The Dell Drivers and Utilities media contains drivers that were installed during the assembly of the computer. Use the Dell Drivers and Utilities media to load any required drivers. Depending on the region from which you ordered your computer, or whether you requested the CDs, the Dell Drivers and Utilities media and Operating System CD may not ship with your computer.

### Reinstalling Windows XP or Windows Vista

The reinstallation process can take 1 to 2 hours to complete. After you reinstall the operating system, you must also reinstall the device drivers, virus protection program, and other software.

 **NOTICE:** The Operating System CD provides options for reinstalling Windows XP. The options can overwrite files and possibly affect programs that are installed on your hard drive. Therefore, do not reinstall Windows XP unless a Dell technical support representative instructs you to do so.

- 1 Save and close any open files and exit any open programs.
- 2 Insert the Operating System CD.
- 3 Click **Exit** if the **Install Windows** message appears.
- 4 Restart the computer.

When the DELL logo appears, press <F12> immediately.

 **NOTE:** If you wait too long and the operating system logo appears, continue to wait until you see the Microsoft® Windows® desktop; then, shut down your computer and try again.

 **NOTE:** The next steps change the boot sequence for one time only. On the next start-up, the computer boots according to the devices specified in the system setup program.

- 5 When the boot device list appears, highlight **CD/DVD/CD-RW Drive** and press <Enter>.
- 6 Press any key to **Boot from CD-ROM**.
- 7 Follow the instructions on the screen to complete the installation.



# Adding and Replacing Parts

## Before You Begin

This chapter provides procedures for removing and installing the components in your computer. Unless otherwise noted, each procedure assumes that the following conditions exist:

- You have performed the steps in "Turning Off Your Computer" on page 103 and "Before Working Inside Your Computer" on page 104.
- You have read the safety information in the Dell™ *Product Information Guide*.
- A component can be replaced or—if purchased separately—installed by performing the removal procedure in reverse order.

## Recommended Tools

The procedures in this document may require the following tools:

- Small flat-blade screwdriver
- Small Phillips screwdriver
- Small plastic scribe
- Hex nut driver
- Flash BIOS update program CD

## Turning Off Your Computer

 **NOTICE:** To avoid losing data, save and close all open files and exit all open programs before you turn off your computer.

- 1 Shut down the operating system:
  - a Save and close all open files and exit all open programs.
  - b *In the Microsoft® Windows® XP operating system*, click **Start**→ **Shut Down**→ **Shut down**.

*In Microsoft® Windows Vista®*, click the Windows Vista Start button,  in the lower-left corner of the desktop, click the arrow in the lower-right corner of the Start menu as shown below, and then click **Shut Down**.



The computer turns off after the operating system shutdown process is complete.

- 2 Ensure that the computer and all attached devices are turned off. If your computer and attached devices did not automatically turn off when you shut down your operating system, press and hold the power button for about 4 seconds to turn them off.

## Before Working Inside Your Computer

Use the following safety guidelines to help protect your computer from potential damage and to help to ensure your own personal safety.



**CAUTION:** Before you begin any of the procedures in this section, follow the safety instructions in the *Product Information Guide*.



**NOTICE:** Handle components and cards with care. Do not touch the components or contacts on a card. Hold a card by its edges or by its metal mounting bracket. Hold a component such as a processor by its edges, not by its pins.



**NOTICE:** Only a certified service technician should perform repairs on your computer. Damage due to servicing that is not authorized by Dell is not covered by your warranty.



**NOTICE:** When you disconnect a cable, pull on its connector or on its pull-tab, not on the cable itself. Some cables have connectors with locking tabs; if you are disconnecting this type of cable, press in on the locking tabs before you disconnect the cable. As you pull connectors apart, keep them evenly aligned to avoid bending any connector pins. Also, before you connect a cable, ensure that both connectors are correctly oriented and aligned.



**NOTICE:** To avoid damaging the computer, perform the following steps before you begin working inside the computer.

- 1 Ensure that the work surface is flat and clean to prevent the computer cover from being scratched.
- 2 Turn off your computer (see "Turning Off Your Computer" on page 103).
- 3 If the computer is connected to a docking device (docked), undock it. See the documentation that came with your docking device for instructions.



**NOTICE:** To disconnect a network cable, first unplug the cable from your computer and then unplug the cable from the network device.

- 4 Disconnect all telephone or network cables from the computer.



**NOTICE:** To avoid damaging the system board, you must remove the main battery before you service the computer.

- 5 Disconnect your computer and all attached devices from their electrical outlets.
- 6 Close the display and turn the computer upside-down on a flat work surface.







1 battery-bay latch release 2 main battery

- 7 Remove the battery:
  - a Slide the battery-bay latch release on the bottom of the computer.
  - b Remove the battery from the battery bay.
- 8 Press the power button to ground the system board.
- 9 Remove any installed PC Cards from the PC Card slot.
- 10 Remove any installed modules, including a second battery, if installed.
- 11 Remove the hard drive (see "Removing the Hard Drive" on page 106).

## Hard Drive

 **CAUTION:** If you remove the hard drive from the computer when the drive is hot, *do not touch* the metal housing of the hard drive.

 **CAUTION:** Before working inside your computer, follow the safety instructions located in the *Product Information Guide*.

 **NOTICE:** To prevent data loss, turn off your computer before removing the hard drive. Do not remove the hard drive while the computer is on, in standby mode, or in hibernate mode.

 **NOTICE:** Hard drives are extremely fragile; even a slight bump can damage the drive.

 **NOTE:** Dell does not guarantee compatibility or provide support for hard drives from sources other than Dell.

To replace the hard drive in the hard drive bay:

- 1 Follow the procedures in "Before You Begin" on page 103.
- 2 Turn the computer over, and remove the hard drive screws (see "Removing the Hard Drive" on page 106).

 **NOTICE:** When the hard drive is not in the computer, store it in protective antistatic packaging. See "Protecting Against Electrostatic Discharge" in the *Product Information Guide*.

- 3 Slide the hard drive out of the computer.
- 4 Remove the new drive from its packaging.  
Save the original packaging for storing or shipping the hard drive.

 **NOTICE:** Use firm and even pressure to slide the drive into place. If you use excessive force, you may damage the connector.

- 5 Slide the hard drive into the bay until it is fully seated.
- 6 Replace and tighten the screws.
- 7 Use the *Operating System* CD to install the operating system for your computer. (see "Using the Operating System CD" on page 101).
- 8 Use the *Drivers and Utilities* media to install the drivers and utilities for your computer. (see "Using the Drivers and Utilities media" on page 96).

## Removing the Hard Drive

To remove the hard drive:

- 1 Follow the procedures in "Before You Begin" on page 103.

 **NOTE:** Before you remove the hard drive, ensure that you removed the main battery.

- 2 Turn the computer upside down, and loosen the two captive screws on the metal bracket that holds the hard drive.
- 3 Holding the bracket by the sides, slide it toward the back of the computer to dislodge the bracket from underneath the two metal clips.
- 4 Remove the metal bracket from the hard drive and lay the bracket aside.

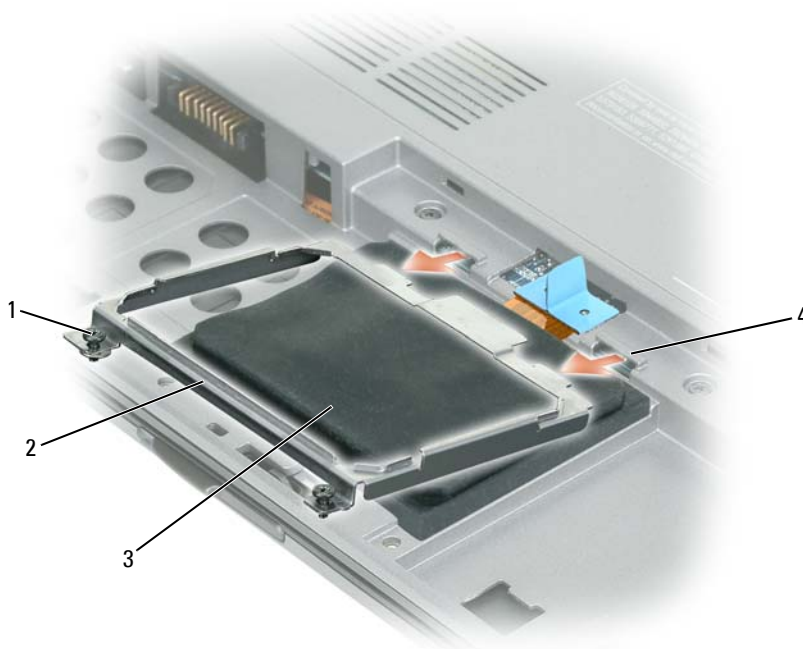

- 1 captive screws (2) 2 metal bracket 3 hard drive  
4 metal clips (2)

- ➔ NOTICE:** When the hard drive is not in the computer, store it in protective antistatic packaging. See "Protecting Against Electrostatic Discharge" in the *Product Information Guide*.
- 5** Use the pull-tab to disconnect the hard drive cable from the system board connector and remove the hard drive from the computer.

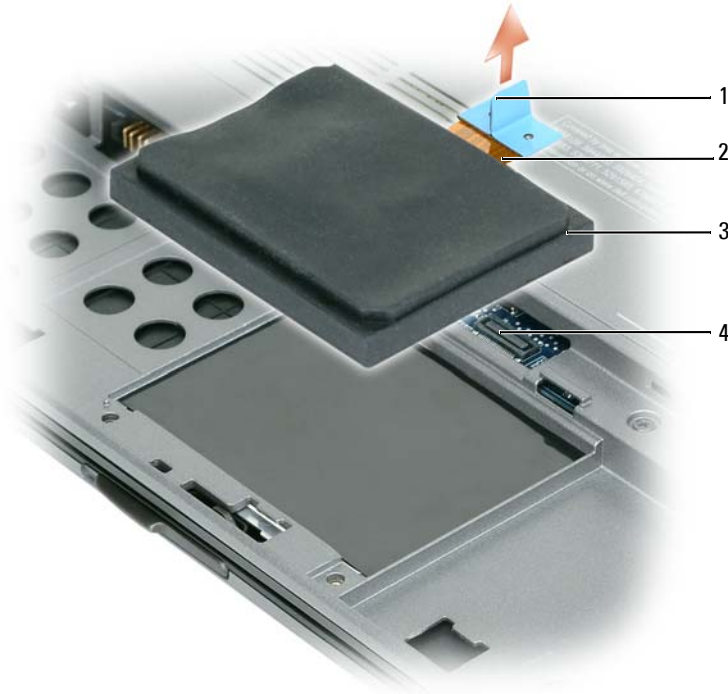

- 1 pull-tab                      2 hard drive cable    3 hard drive  
4 system board connector

## Replacing the Hard Drive

**➔ NOTICE:** Use firm and even pressure to slide the drive into place. If you use excessive force, you may damage the connector.

- 1 Follow the steps in "Removing the Hard Drive" on page 106 in reverse order.

**✍ NOTE:** This computer is not equipped with an optical drive—use the Media Base (sold separately) to install software.

- 2 Install the operating system for your computer (see "Restoring Your Operating System" on page 98).
- 3 Install the drivers and utilities for your computer (see "Reinstalling Drivers and Utilities" on page 96).

## Memory

You can increase your computer memory by installing memory modules on the system board. See "Specifications" on page 131 for information on the memory supported by your computer. Install only memory modules that are intended for your computer.

 **NOTE:** Memory modules purchased from Dell are covered under your computer warranty.

 **CAUTION:** Before you begin any of the procedures in this section, follow the safety instructions located in the *Product Information Guide*.

1 Follow the procedures in "Before You Begin" on page 103.

 **NOTICE:** To prevent damage to the memory module connector, do not use tools to spread the memory-module securing clips.

2 If you are replacing a memory module, remove the existing module:

- a Use your fingertips to carefully spread apart the securing clips on each end of the memory module connector until the module pops up.
- b Remove the module from the connector.

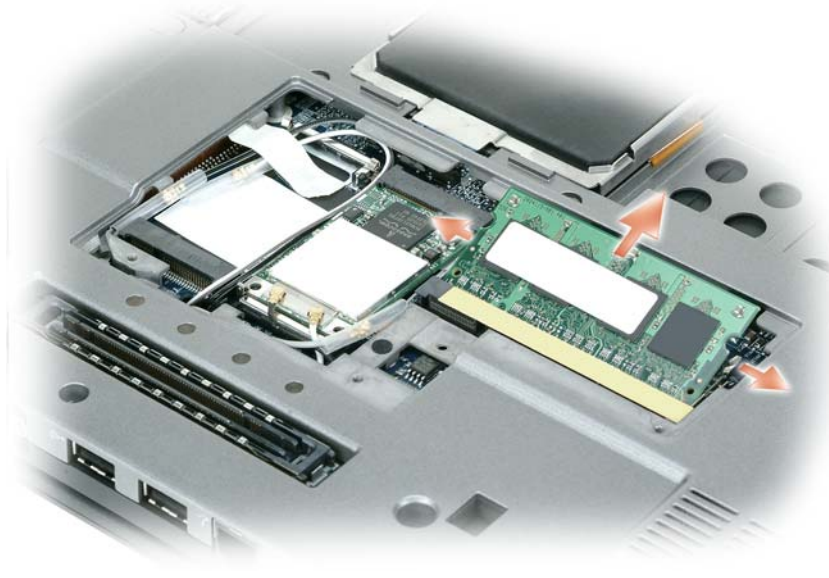

 **NOTE:** For optimal performance, identical memory modules should be used in each connector.

3 Ground yourself and install the new memory module:

 **NOTE:** If the memory module is not installed properly, the computer may not boot properly. No error message indicates this failure.

- a Align the notch in the module edge connector with the tab in the connector slot.
- b Slide the module firmly into the slot at a 45-degree angle, and rotate the module down until it clicks into place. If you do not feel the click, remove the module and reinstall it.

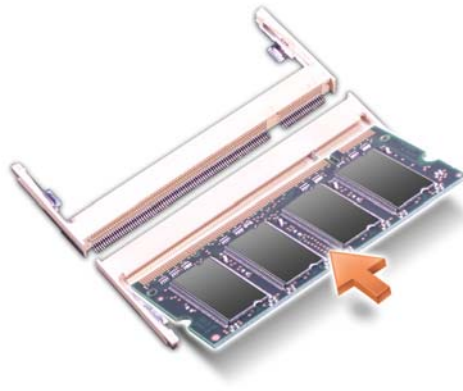

4 Replace the cover.

➔ **NOTICE:** If the cover is difficult to close, remove the module and reinstall it. Forcing the cover to close may damage your computer.

5 Insert the battery into the battery bay, or connect the AC adapter to your computer and an electrical outlet.

6 Turn on the computer.

As the computer boots, it detects the additional memory and automatically updates the system configuration information.

To confirm the amount of memory installed in the computer:

- In the *Microsoft Windows XP* operating system, right-click the **My Computer** icon on your desktop. Click **Properties**→ **General**.
- In the *Microsoft Windows Vista* operating system, click the Windows Vista Start button, , and right-click **Computer**→ **Properties**.

## Keyboard

⚠ **CAUTION:** Before you begin any of the procedures in this section, follow the safety instructions in the *Product Information Guide*.

➔ **NOTICE:** To avoid electrostatic discharge, ground yourself by using a wrist grounding strap or by periodically touching an unpainted metal surface (such as a connector on the back of the computer).

1 Follow the procedures in "Before You Begin" on page 103.

2 Remove the hinge cover (see "Hinge Cover" on page 112).

➔ **NOTICE:** The keycaps on the keyboard are fragile, easily dislodged, and time-consuming to replace. Be careful when removing and handling the keyboard.

3 Remove the keyboard:

- a Remove the three M2 x 3-mm screws across the top of the keyboard.
- ➔ **NOTICE:** Lift the keyboard carefully in [step b](#) to ensure that you do not pull the keyboard wire.
- b Slide the keyboard forward to gain access to the two keyboard connectors.
- c Pull up on the plastic bar on the keyboard connectors to disconnect the keyboard connectors from the system board.

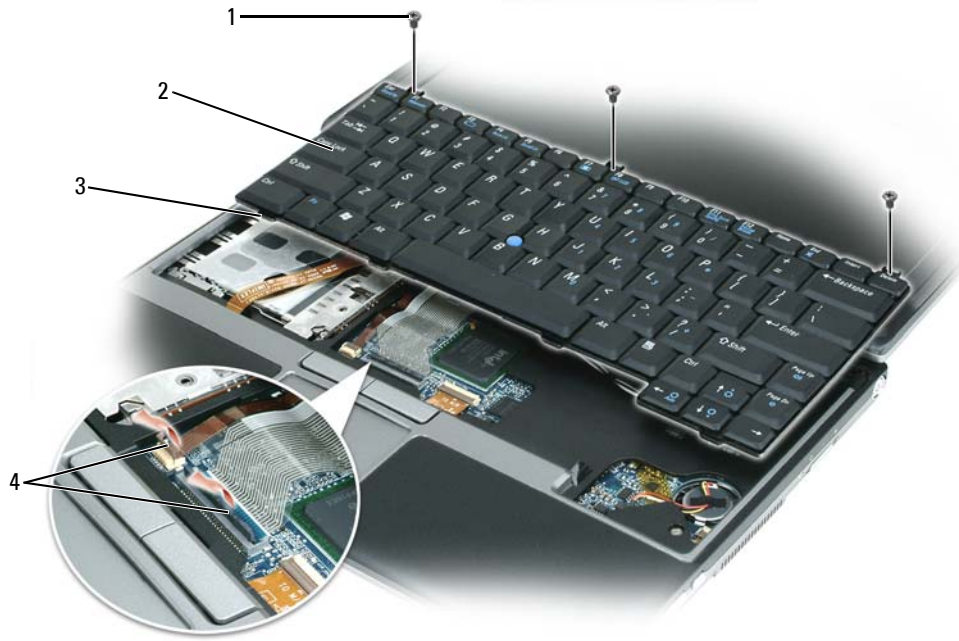

- 1 M2 x 3-mm screws (3)
- 2 keyboard
- 3 tabs (4)
- 4 plastic bar on keyboard connectors

- ➔ **NOTICE:** To avoid scratching the palm rest when replacing the keyboard, hook the tabs along the front edge of the keyboard into the palm rest, and then secure the keyboard in place.
- 4 To replace the keyboard, connect the keyboard cable to the connector on the system board.
- 5 Place the tabs along the front edge of the keyboard into the palm rest, and lay the keyboard down on the palm rest.
- 6 Replace the three screws at the top of the keyboard.
- 7 Replace the hinge cover.

## Hinge Cover

**CAUTION:** Before you begin any of the procedures in this section, follow the safety instructions in the *Product Information Guide*.

**NOTICE:** To avoid electrostatic discharge, ground yourself by using a wrist grounding strap or by periodically touching an unpainted metal surface (such as a connector on the back of the computer).

**NOTICE:** The hinge cover is fragile and can be damaged if extreme force is used. Be careful when removing the hinge cover.

1 Follow the procedures in "Before You Begin" on page 103.

2 Open the display all the way (180 degrees) so that it rests on your work surface.

**NOTICE:** To avoid damaging the hinge cover, do not lift the cover on both sides simultaneously.

3 Starting on the right side of the computer, use a plastic scribe to pry up the hinge cover.



1 hinge cover 2 plastic scribe

4 Ease the hinge cover up, moving from right to left, and remove it.

5 To replace the hinge cover, insert the left edge of the cover into the hinge cover slot, and press from left to right until the cover snaps into place.



## Mini-Cards

If you ordered a WLAN card with your computer, the card is already installed.

**⚠ CAUTION:** Before you begin any of the procedures in this section, follow the safety instructions in the *Product Information Guide*.

**➡ NOTICE:** To prevent damage to the system board, remove the main battery before you service the computer.

### Wireless Local Area Network (WLAN) Cards

- 1 Follow the procedures in "Before You Begin" on page 103.
- 2 Ground yourself by touching one of the metal connectors on the back of the computer.

**🔧 NOTE:** If you leave the area, ground yourself again when you return to the computer.

- 3 If a card is not already installed, go to step 4. If you are replacing a card, remove the existing card:
  - a Turn the computer upside-down and remove the memory/Mini-Card module cover.
  - b Disconnect the antenna cables from the card.

**🔧 NOTE:** Depending on the type of WLAN-Card you have, either two or three of the three antenna cables may be in use.

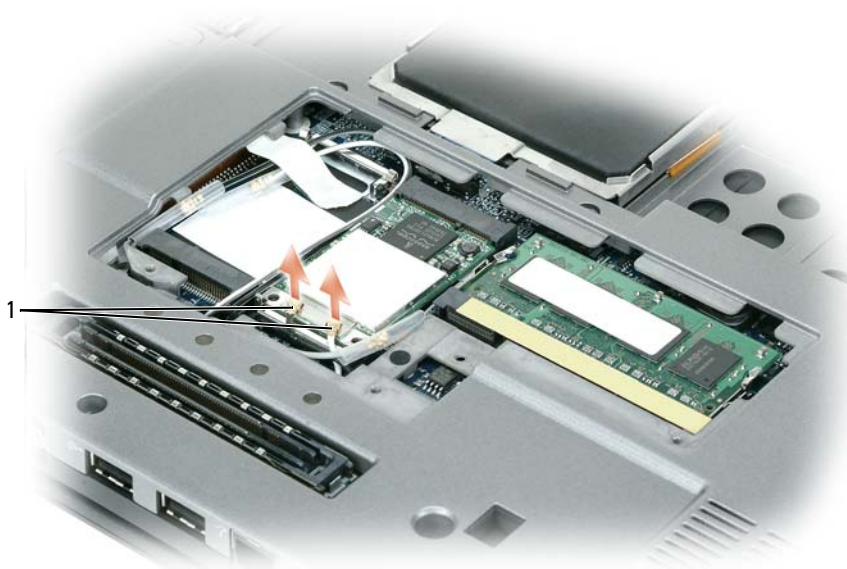

1 antenna cables (2)

- c Disconnect the antenna cables from the WLAN card.

- ➔ **NOTICE:** To prevent damage to the connector, do not use tools to spread the securing clips.
- d Release the card by pushing the metal securing clips toward the back of the computer until the card pops up slightly.
- e Lift the card out of its connector.

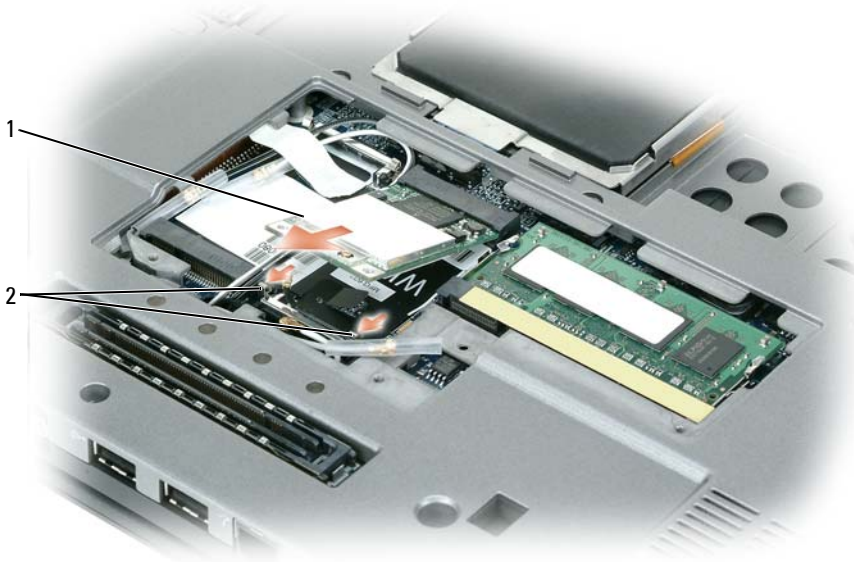

1 WLAN card 2 metal securing clips (2)

- ➔ **NOTICE:** The connectors are keyed to ensure correct insertion. If you feel resistance, check the connectors and realign the card.
- 🔧 **NOTE:** Do not insert a Mobile Broadband (WWAN) network card into the WLAN card connector.
- 4 Install the WLAN card:
- ➔ **NOTICE:** To avoid damaging the WLAN card, never place cables on top of or under the card.
- 🔧 **NOTE:** The WLAN card may have two or three antenna connectors, depending on the type of card you ordered.
  - a Move any antenna cables out of the way to make space for the WLAN card.
  - b Align the WLAN card with the connector at a 45-degree angle, and press the card down into the securing clips until the card clicks into place.
- 🔧 **NOTE:** For more specific information about which cable to connect to which connector, see the documentation that came with your WLAN card.
  - c Connect the antenna cables to the antenna connectors on the WLAN card by matching the color of the cable to the color of the triangle above the connector. Connect the main antenna cable

(white) to the antenna connector with the white triangle. Connect the auxiliary antenna cable (black) to the antenna connector with the black triangle.

 **NOTE:** If your computer has a gray cable, connect it to the connector with the gray triangle, if one is available on your card.

- 5 Connect the antenna cables to the WLAN card, ensuring that you route the cables correctly.
- 6 Replace the memory/Mini-Card module cover.

## Mobile Broadband (WWAN) Cards

 **NOTE:** Mobile Broadband cards may not be available in all regions.

If you ordered a Mobile Broadband card with your computer, the card is already installed.

 **CAUTION:** Before you begin any of the procedures in this section, follow the safety instructions in the *Product Information Guide*.

- 1 If a Mobile Broadband card is not already installed, go to step 5. If you are replacing a Mobile Broadband card, remove the existing card:

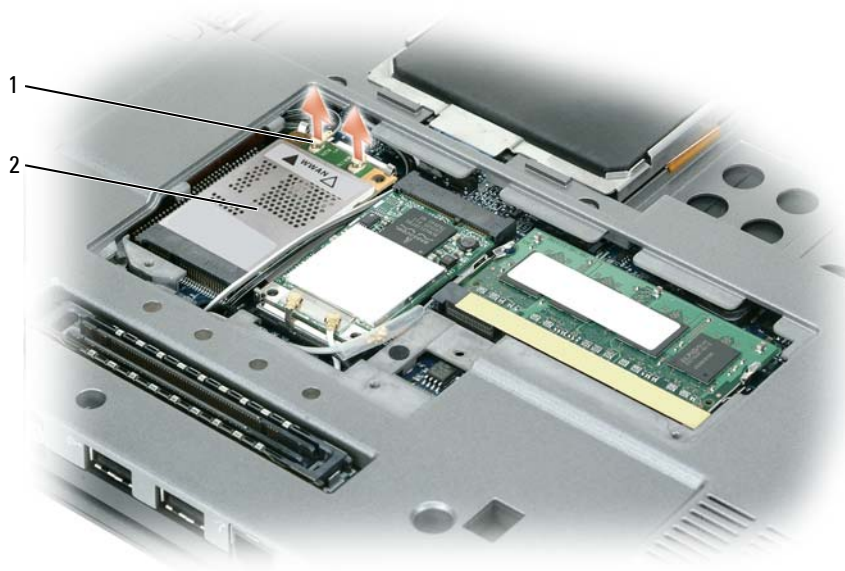

1 antenna cables (2) 2 Mobile Broadband card

- a Disconnect the Mobile Broadband card from any attached cables.

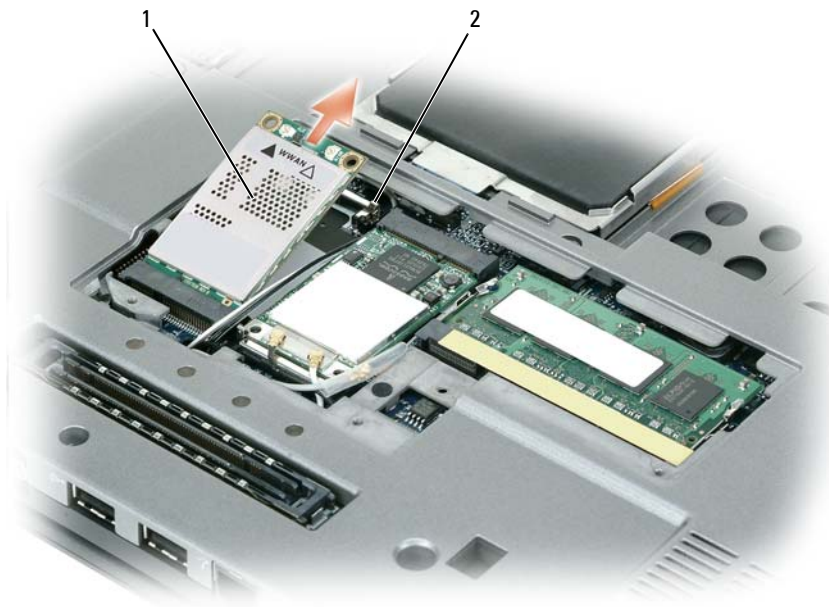

1 Mobile Broadband card 2 metal securing tabs (2)

- ➔ **NOTICE:** To prevent damage to the connector, do not use tools to spread the securing clips.
- b Use your fingertips to carefully spread apart the metal securing tabs until the card pops up slightly.
- c Slide and lift the Mobile Broadband card out of its connector.
- ➔ **NOTICE:** The connectors are keyed to ensure correct insertion. If you feel resistance, check the connectors and realign the card.
- 🔧 **NOTE:** Do not insert a WLAN card into the Mobile Broadband card slot.
- 2 To install a Mobile Broadband card:
  - a Move any antenna cables out of the way to make space for the card.
- ➔ **NOTICE:** To avoid damaging the Mobile Broadband card, never place cables on top of or under the card and ensure that you route the cables properly.
- 🔧 **NOTE:** Cable routing for the Mobile Broadband card may vary.
  - b Align the card with the connector at a 45-degree angle, and press the card into the connector until you feel a click.
  - c Connect the white stripped cable to the connector on the card marked with a white triangle.
  - d Connect the black stripped cable to the connector on the card marked with a black triangle.

## Subscriber Identity Module (SIM) Card

➡ **NOTICE:** To protect the SIM card from electrostatic discharge (ESD), do not touch the SIM card connector. Also, take care when removing the card to slide the card completely out of the metal tabs before lifting the card out of the slot. The card is brittle and may easily break otherwise.

🔪 **NOTE:** The SIM card is located in the battery bay. You must remove the main battery before you can access the SIM card.

- 1 Slide the SIM card out of the SIM card slot with the cut-off corner of the card facing toward the back of the computer.

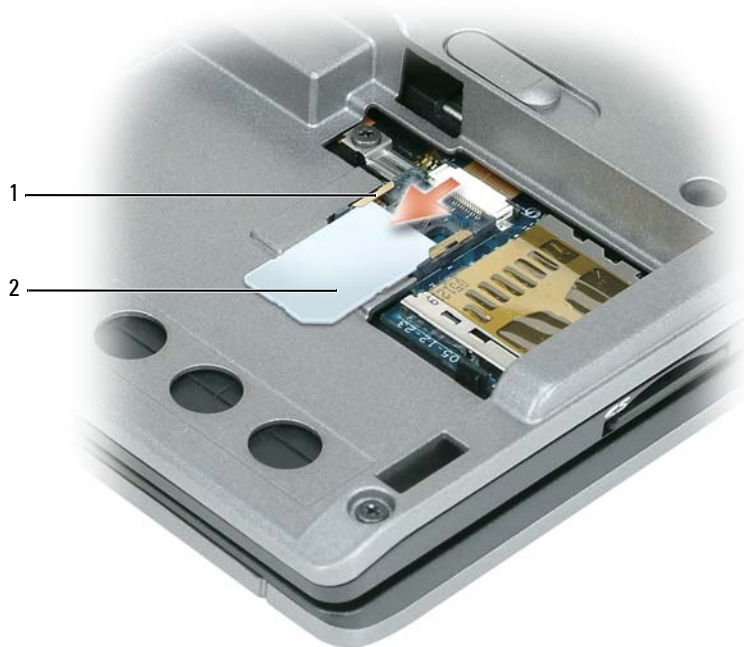

1 metal tabs (2) on  
SIM card slot

2 SIM card with cut-off  
corner

🔪 **NOTE:** When you replace the SIM card, ensure that you slide the SIM card under the two metal tabs on the SIM card slot with the cut-off corner of the card facing toward the back of the computer.

## Internal Card With Bluetooth® Wireless Technology

⚠️ **CAUTION:** Before performing the following procedures, read the safety instructions in your *Product Information Guide*.

➔ **NOTICE:** To avoid electrostatic discharge, ground yourself by using a wrist grounding strap or by periodically touching a connector on the back panel of the computer.

➔ **NOTICE:** To prevent damage to the system board, remove the main battery before you service the computer.

If you ordered an internal card with Bluetooth wireless technology with your computer, it is already installed.

- 1 Follow the procedures in "Before You Begin" on page 103.
- 2 Remove the keyboard (see "Mini-Cards" on page 113).
- 3 Remove the M2 x 3-mm screw from the card holder and lay the holder aside.
- 4 Lift the card away from the aligning pin.
- 5 Disconnect the card cable connector from the card.



1 internal card with Bluetooth wireless technology

2 card cable connector

3 M2 x 3-mm screw

4 card holder

5 aligning pin

➔ **NOTICE:** Be careful when removing the card to avoid damaging the card, card cable, or surrounding components.

## Coin-Cell Battery

⚠ **CAUTION:** Before performing the following procedures, follow the safety instructions in your *Product Information Guide*.

➔ **NOTICE:** To avoid electrostatic discharge, ground yourself by using a wrist grounding strap or by periodically touching a connector on the back panel of the computer.

➔ **NOTICE:** To prevent damage to the system board, remove the main battery before you service the computer.

- 1 Follow the procedures in "Before You Begin" on page 103.
- 2 Remove the keyboard (see "Mini-Cards" on page 113).
- 3 Disconnect the coin-cell battery cable connector from the system board connector.
- 4 Remove the coin-cell battery from the system board.



1 cable connector 2 coin-cell battery

When you replace the battery, insert it at a 30-degree angle under the clip with the positive (identified by a plus [+]) side up, and then push it into place.





## Dell™ QuickSet

 **NOTE:** This feature may not be available on your computer.

Dell™ QuickSet provides you with easy access to configure or view the following types of settings:

- Network connectivity
- Power management
- Display
- System information

Depending on what you want to do in Dell™ QuickSet, you can start it by either *clicking*, *double-clicking*, or *right-clicking* the QuickSet icon in the Microsoft® Windows® taskbar. The taskbar is located in the lower-right corner of your screen.

For more information about QuickSet, right-click the QuickSet icon and select **Help**.



# Traveling With Your Computer

## Identifying Your Computer

- Attach a name tag or business card to the computer.
- Write down your Service Tag and store it in a safe place away from the computer or carrying case. Use the Service Tag if you need to report a loss or theft to law enforcement officials and to Dell.
- Create a file on the Microsoft® Windows® desktop called **if\_found**. Place information such as your name, address, and phone number in this file.
- Contact your credit card company and ask if it offers coded identification tags.

## Packing the Computer

- Remove any external devices attached to the computer and store them in a safe place. Remove any cables attached to installed PC Cards, and remove any extended PC Cards (see "Extended PC Cards" on page 56).
- To make the computer as light as possible, replace any devices installed in the module bay with the Dell TravelLite™ module.
- Fully charge the main battery and any spare batteries that you plan to carry with you.
- Shut down the computer.
- Disconnect the AC adapter.



**NOTICE:** When the display is closed, extraneous items on the keyboard or palm rest could damage the display.

- Remove any extraneous items, such as paper clips, pens, and paper, from the keyboard and palm rest and close the display.
- Use the optional Dell™ carrying case to pack the computer and its accessories together safely.
- Avoid packing the computer with items such as shaving cream, colognes, perfumes, or food.



**NOTICE:** If the computer has been exposed to extreme temperatures, allow it to acclimate to room temperature for 1 hour before turning it on.

- Protect the computer, the batteries, and the hard drive from hazards such as extreme temperatures and overexposure to sunlight, dirt, dust, or liquids.
- Pack the computer so that it does not slide around in the trunk of your car or in an overhead storage compartment.

## Travel Tips

➡ **NOTICE:** Do not move the computer while using the optical drive to prevent loss of data.

➡ **NOTICE:** Do not check the computer as baggage.

- Consider disabling wireless activity on your computer to maximize battery operating time. To disable wireless activity, use the wireless switch (see "Dell Wi-Fi Catcher™ Network Locator" on page 53).
- Consider changing your power management options to maximize battery operating time (see "Power Management Modes" on page 31).
- If you are traveling internationally, carry proof of ownership—or of your right to use the computer if it is company-owned—to speed your passage through customs. Investigate the customs regulations of the countries you plan to visit, and consider acquiring an international carnet (also known as a *merchandise passport*) from your government.
- Find out what type of electrical outlets are used in the countries you will visit, and have appropriate power adapters.
- Check with your credit card company for information about the kinds of emergency travel assistance it offers to users of portable computers.

## Traveling by Air

➡ **NOTICE:** Do not walk the computer through a metal detector. Send the computer through an X-ray machine or have it hand-inspected.

- Ensure that you have a charged battery available in case you are asked to turn on the computer.
- Prior to entering the airplane, verify that using a computer is permitted. Some airlines forbid the use of electronic devices during flight. All airlines forbid the use of electronic devices during takeoff and landing.

# Getting Help

## Obtaining Assistance

 **CAUTION:** If you need to remove the computer cover, first disconnect the computer power and modem cables from all electrical outlets.

If you experience a problem with your computer, you can complete the following steps to diagnose and troubleshoot the problem:

- 1 See "Troubleshooting" on page 71 for information and procedures that pertain to the problem your computer is experiencing.
- 2 See "Dell Diagnostics" on page 71 for procedures on how to run Dell Diagnostics.
- 3 Fill out the "Diagnostics Checklist" on page 129.
- 4 Use Dell's extensive suite of online services available at Dell Support ([support.dell.com](http://support.dell.com)) for help with installation and troubleshooting procedures. See "Online Services" on page 126 for a more extensive list of Dell Support online.
- 5 If the preceding steps have not resolved the problem, see "Contacting Dell" on page 128.

 **NOTE:** Call Dell Support from a telephone near or at the computer so that the support staff can assist you with any necessary procedures.

 **NOTE:** Dell's Express Service Code system may not be available in all countries.

When prompted by Dell's automated telephone system, enter your Express Service Code to route the call directly to the proper support personnel. If you do not have an Express Service Code, open the **Dell Accessories** folder, double-click the **Express Service Code** icon, and follow the directions.

For instructions on using the Dell Support, see "Technical Support and Customer Service" on page 125.

 **NOTE:** Some of the following services are not always available in all locations outside the continental U.S. Call your local Dell representative for information on availability.

## Technical Support and Customer Service

Dell's support service is available to answer your questions about Dell™ hardware. Our support staff uses computer-based diagnostics to provide fast, accurate answers.

To contact Dell's support service, see "Before You Call" on page 128, and then see the contact information for your region or go to [support.dell.com](http://support.dell.com).

## DellConnect

DellConnect is a simple online access tool that allows a Dell service and support associate to access your computer through a broadband connection, diagnose your problem and repair it all under your supervision. For more information, go to [support.dell.com](http://support.dell.com) and click DellConnect.

## Online Services

You can learn about Dell products and services on the following websites:

[www.dell.com](http://www.dell.com)

[www.dell.com/ap](http://www.dell.com/ap) (Asian/Pacific countries only)

[www.dell.com/jp](http://www.dell.com/jp) (Japan only)

[www.euro.dell.com](http://www.euro.dell.com) (Europe only)

[www.dell.com/la](http://www.dell.com/la) (Latin American and Caribbean countries)

[www.dell.ca](http://www.dell.ca) (Canada only)

You can access Dell Support through the following websites and e-mail addresses:

- Dell Support websites  
[support.dell.com](http://support.dell.com)  
[support.jp.dell.com](http://support.jp.dell.com) (Japan only)  
[support.euro.dell.com](http://support.euro.dell.com) (Europe only)
- Dell Support e-mail addresses  
[mobile\\_support@us.dell.com](mailto:mobile_support@us.dell.com)  
[support@us.dell.com](mailto:support@us.dell.com)  
[la-techsupport@dell.com](mailto:la-techsupport@dell.com) (Latin America and Caribbean countries only)  
[apsupport@dell.com](mailto:apsupport@dell.com) (Asian/Pacific countries only)
- Dell Marketing and Sales e-mail addresses  
[apmarketing@dell.com](mailto:apmarketing@dell.com) (Asian/Pacific countries only)  
[sales\\_canada@dell.com](mailto:sales_canada@dell.com) (Canada only)
- Anonymous file transfer protocol (FTP)  
[ftp.dell.com](http://ftp.dell.com)  
Log in as user: `anonymous`, and use your e-mail address as your password.

## **AutoTech Service**

Dell's automated support service—AutoTech—provides recorded answers to the questions most frequently asked by Dell customers about their portable and desktop computers.

When you call AutoTech, use your touch-tone telephone to select the subjects that correspond to your questions. For the telephone number to call for your region, see "Contacting Dell" on page 128.

## **Automated Order-Status Service**

To check on the status of any Dell products that you have ordered, you can go to [support.dell.com](http://support.dell.com), or you can call the automated order-status service. A recording prompts you for the information needed to locate and report on your order. For the telephone number to call for your region, see "Contacting Dell" on page 128.

## **Problems With Your Order**

If you have a problem with your order, such as missing parts, wrong parts, or incorrect billing, contact Dell for customer assistance. Have your invoice or packing slip handy when you call. For the telephone number to call for your region, see "Contacting Dell" on page 128.

## **Product Information**

If you need information about additional products available from Dell, or if you would like to place an order, visit the Dell website at [www.dell.com](http://www.dell.com). For the telephone number to call for your region or to speak to a sales specialist, see "Contacting Dell" on page 128.

## **Returning Items for Warranty Repair or Credit**

Prepare all items being returned, whether for repair or credit, as follows:

- 1 Call Dell to obtain a Return Material Authorization Number, and write it clearly and prominently on the outside of the box.  
For the telephone number to call for your region, see "Contacting Dell" on page 128.
- 2 Include a copy of the invoice and a letter describing the reason for the return.
- 3 Include a copy of the Diagnostics Checklist (see "Diagnostics Checklist" on page 129), indicating the tests that you have run and any error messages reported by the Dell Diagnostics (see "Dell Diagnostics" on page 71).
- 4 Include any accessories that belong with the item(s) being returned (power cables, software floppy disks, guides, and so on) if the return is for credit.
- 5 Pack the equipment to be returned in the original (or equivalent) packing materials.

You are responsible for paying shipping expenses. You are also responsible for insuring any product returned, and you assume the risk of loss during shipment to Dell. Collect On Delivery (C.O.D.) packages are not accepted.

Returns that are missing any of the preceding requirements will be refused at Dell's receiving dock and returned to you.

## Before You Call

 **NOTE:** Have your Express Service Code ready when you call. The code helps Dell's automated-support telephone system direct your call more efficiently. You may also be asked for your Service Tag (located on the back or bottom of your computer).

Remember to fill out the Diagnostics Checklist (see "Diagnostics Checklist" on page 129). If possible, turn on your computer before you call Dell for assistance and call from a telephone at or near the computer. You may be asked to type some commands at the keyboard, relay detailed information during operations, or try other troubleshooting steps possible only at the computer itself. Ensure that the computer documentation is available.

 **CAUTION:** Before working inside your computer, follow the safety instructions in your *Product Information Guide*.

## Contacting Dell

For customers in the United States, call 800-WWW-DELL (800-999-3355).

 **NOTE:** If you do not have an active Internet connection, you can find contact information on your purchase invoice, packing slip, bill, or Dell product catalog.

Dell provides several online and telephone-based support and service options. Availability varies by country and product, and some services may not be available in your area. To contact Dell for sales, technical support, or customer service issues:

- 1 Visit [support.dell.com](http://support.dell.com).
- 2 Verify your country or region in the **Choose A Country/Region** drop-down menu at the bottom of the page.
- 3 Click **Contact Us** on the left side of the page.
- 4 Select the appropriate service or support link based on your need.
- 5 Choose the method of contacting Dell that is convenient for you.



## **Diagnostics Checklist**

Name:

Date:

Address:

Phone number:

Service Tag (bar code on the back or bottom of the computer):

Express Service Code:

Return Material Authorization Number (if provided by Dell support technician):

Operating system and version:

Devices:

Expansion cards:

Are you connected to a network? Yes No

Network, version, and network adapter:

Programs and versions:

See your operating system documentation to determine the contents of the system's start-up files. If the computer is connected to a printer, print each file. Otherwise, record the contents of each file before calling Dell.

Error message, beep code, or diagnostic code:

Description of problem and troubleshooting procedures you performed:



## Specifications

 **NOTE:** Offerings may vary by region. For more information regarding the configuration of your computer, click **Start**→ **Help and Support** and select the option to view information about your computer.

---

### Processor

Processor type	Intel® Core™ Solo and Intel Core 2 Duo processors
L1 cache	32 KB (internal)
L2 cache	2 MB
External bus frequency	533

---

### System Information

System chipset	Intel 945 GMS
Data bus width	64 bits
DRAM bus width	64 bits
Processor address bus width	32 bits

---

### PC Card/Express Card

CardBus controller	Ricoh R5C843
PC Card connector	80-pin
Cards supported	Type I and II cards 34mm ExpressCard with adapter
PC Card connector size	68 pins
Data width (maximum)	PCMCIA 16 bits CardBus 32 bits

---

### Memory

Memory module connector	one user-accessible DIMM socket
Memory module capacities	1 GB minimum to 2 GB maximum
Memory type	533 MHz DDRII SDRAM (supports up to 667 MHz DDRII)

<b>Memory (continued)</b>	
Minimum memory	1 GB (onboard memory)
Maximum memory	up to 2 GB
<b>Smart Card</b>	
Read/write capabilities	reads and writes to all ISO 7816 1/2/3/4 microprocessor cards (T=0, T=1)
Cards supported	3 V and 5 V
Program technology supported	Java cards
Interface speed	9600–115,200 bps
EMV level	level 1 certified
WHQL certification	PC/SC
Compatibility	compatible within a PKI environment
Insert/eject cycles	certified for up to 100,000 cycles
<b>Ports and Connectors</b>	
Video	15-hole connector
Audio	microphone miniconnector, stereo headphones/speakers miniconnector
USB	2 4-pin USB 2.0-compliant connectors
Powered USB	one 9-pin USB 2.0-compliant powered
Modem	RJ-11 support
IEEE 1394a	4-pin serial connector
	<b>NOTE:</b> The D430 has been optimally designed to be used with the slim Media Base for docking. However, it is compatible with the D-Family D/Port and D/Dock. With the use of the D-Family D/Port and D/Dock, all ports can be effectively utilized except for the 1394 port. If the use of this port is required, it is recommended that you utilize the Media Base as your primary docking device.
Mini-Card	two Type IIIA Mini-Card slot
Network adapter	RJ-45 port
D-Dock connector	standard docking connector for D/Dock, D/Port, or D420 Media Base

---

**Communications**

---

## Modem:

Type v.92 56K MDC

Controller softmodem

Interface Intel High-Definition Audio

Network adapter 10/100/1000 Ethernet LAN on system board

Wireless

- internal PCI-e Mini-Card WLAN support
- Bluetooth® wireless technology support
- WWAN Mini-Card support using USB interface

---

**Video**

---

Video type Intel Integrated UMA Graphics

Data bus PCI Express

Controller/Memory 224 MB of shared memory (with 512 MB or more of system memory)

LCD interface LVDS

TV support NTSC or PAL in S-video and composite modes (through Dell D/Port advanced port replicator only)

---

**Audio**

---

Audio type High Definition Audio (HDA)  
Intellisonic software by Knowles Acoustics for embedded mic (WinXP, WinXP64, Win2000)

Audio controller SigmaTel STAC9200

Stereo conversion 24-bit (stereo digital-to-analog),  
24-bit (stereo analog-to-digital)

## Interfaces:

Internal High Definition Audio

External microphone mini-connector, stereo  
headphones/speakers mini-connector

Speaker one 8-ohm speaker

Internal speaker amplifier 1-W channel into 8 ohms

<b>Display</b>	
Type (WXGA)	12.1-inch WXGA 220nit
Dimensions (12.1-inch display):	
Height	163.2 mm (6.43 inches)
Width	261.12 mm (10.3 inches)
Diagonal	307.34 mm (12.1 inches)
Operating angle	0° (closed) to 180°
Viewing angles:	
WXGA+ horizontal	+/- 40/40°
WXGA+ vertical	+/- 10/30°
Pixel pitch:	
WXGA	0.204 mm
Power consumption (panel with backlight) (typical):	
WXGA	6.2 W (max.)
Controls	brightness can be controlled through keyboard shortcuts
<b>Keyboard</b>	
Number of keys	87 (U.S. and Canada); 87 (China); 89 (Brazil); 88 (Europe); 91 (Japan)
Key travel	2.5 mm ± 0.3 mm (0.11 inch ± 0.016 inch)
Key spacing	18.5 mm ± 0.3 mm (0.73 inch ± 0.012 inch)
Layout	QWERTY/AZERTY/Kanji
<b>Fingerprint Reader (optional)</b>	
Type	UPEK TCS3 TouchStrip™ strip sensor with CMOS active capacitive pixel-sensing technology
Power Supply	2.7 V to approx. 3.6 V
Connector	48-ball BGA
Array Size	248 x 2 pixels
<b>Touch Pad</b>	
X/Y position resolution (graphics table mode)	240 cpi

---

**Fingerprint Reader (optional)**

---

Type	UPEK TCS3 TouchStrip™ strip sensor with CMOS active capacitive pixel-sensing technology
Power Supply	2.7 V to approx. 3.6 V
Connector	48-ball BGA
Array Size	248 x 2 pixels

---

**Touch Pad**

---

Size:

Width	64.88 mm (2.55-inch) sensor-active area
Height	48.88-mm (1.92-inch) rectangle

---

**Battery**

---

Type	9-cell hybrid lithium ion (68 WHr) 6-cell "smart" lithium ion (42 WHr) 4-cell "smart" lithium ion (28 WHr) (optional)
Dimensions:	
Depth	77.5 mm (3.05 inches)
Height	19.5 mm (0.76 inch)
Width	123.4 mm (4.86 inches)
Weight	0.32 kg (0.70 lb) (6 cell) 0.23 kg (0.52 lb) (4 cell)
Voltage	14.8 VDC (4 cell) 11.1 VDC (6 cell) 11.1 VDC (9 cell)
Charge time (approximate):	
Computer off	approximately 1 hour for 80 percent charge for 4 and 6 cell.
Operating time	varies depending on operating conditions and can be significantly reduced under certain power-intensive conditions. See "Battery Performance" on page 29 for more information.

<b>Battery (continued)</b>	
Life span (approximate)	300 discharge/charge cycles
Temperature range:	
Operating	0° to 35°C (32° to 95°F)
Storage	-40° to 65°C (-40° to 149°F)
<b>AC Adapter</b>	
Input voltage	100–240 VAC
Input current (maximum)	1.5 A
Input frequency	50–60 Hz
Output current	3.34 A (65-W AC adapter) 4.62 A (90-W AC adapter)
Output power	65 W 90 W
Rated output voltage	19.5 VDC
Dimensions and weight (65-W AC adapter):	
Height	28.3 mm (1.11 inches)
Width	57.8 mm (2.28 inches)
Depth	137.2 mm (5.40 inches)
Weight (with cables)	<b>0.4 kg (0.9 lb)</b>
Dimensions and weight (90-W AC adapter):	
Height	34.2 mm (1.35 inches)
Width	60.9 mm (2.39 inches)
Depth	153.42 mm (6.04 inches)
Weight (with cables)	0.46 kg (1.01 lb)
Temperature range:	
Operating	0° to 35°C (32° to 95°F)
Storage	-40° to 65°C (-40° to 149°F)
<b>Physical</b>	
Height	2.54 cm (1.0 inches)
Width	29.5 cm (11.6 inches)



---

**Physical (continued)**

---

Depth	20.98 cm (8.26 inches)
Weight	2.98 lbs (1.35 kg) with 4-cell battery 3.17 lbs (1.4 kg) with 6-cell battery 4.25 lbs (1.9 kg) with media base and 4-cell

---

**Environmental**

---

Temperature range:

Operating	0° to 35°C (32° to 95°F)
Storage	-40° to 65°C (-40° to 149°F)

Relative humidity (maximum):

Operating	10% to 90% (noncondensing)
Storage	5% to 95% (noncondensing)

Maximum vibration (using a random-vibration spectrum that simulates user environment):

Operating	0.66 GRMS
Storage	1.30 GRMS

Maximum shock (measured with hard drive in operating status and a 2-ms half-sine pulse for operating; also measured with hard drive in head-parked position and a 2-ms half-sine pulse for storage):

Operating	142g 2ms
Storage	162g 2ms

Altitude (maximum):

Operating	15.2 to 3048 m (50 to 10,000 ft)
Storage	15.2 to 10,668 m (50 to 35,000 ft)

Airborne contaminant level G2 or lower as defined by ISA-S71.04-1985



# Glossary

Terms in this Glossary are provided for informational purposes only and may or may not describe features included with your particular computer.

## A

**AC** — alternating current — The form of electricity that powers your computer when you plug the AC adapter power cable in to an electrical outlet.

**ACPI** — advanced configuration and power interface — A power management specification that enables Microsoft® Windows® operating systems to put a computer in standby or hibernate mode to conserve the amount of electrical power allocated to each device attached to the computer.

**AGP** — accelerated graphics port — A dedicated graphics port that allows system memory to be used for video-related tasks. AGP delivers a smooth, true-color video image because of the faster interface between the video circuitry and the computer memory.

**AHCI** — Advanced Host Controller Interface — An interface for a SATA hard drive Host Controller which allows the storage driver to enable technologies such as Native Command Queuing (NCQ) and hot plug.

**ALS** — ambient light sensor — A feature that helps to control display brightness.

**antivirus software** — A program designed to identify, quarantine, and/or delete viruses from your computer.

**ASF** — alert standards format — A standard to define a mechanism for reporting hardware and software alerts to a management console. ASF is designed to be platform- and operating system-independent.

## B

**battery life span** — The length of time (years) during

which a portable computer battery is able to be depleted and recharged.

**battery operating time** — The length of time (minutes or hours) that a portable computer battery powers the computer.

**BIOS** — basic input/output system — A program (or utility) that serves as an interface between the computer hardware and the operating system. Unless you understand what effect these settings have on the computer, do not change them. Also referred to as *system setup*.

**bit** — The smallest unit of data interpreted by your computer.

**Blu-ray Disc™ (BD)** — An optical storage technology offering storage capacity of up to 50 GB, full 1080p video resolution (HDTV required), and as many as 7.1 channels of native, uncompressed surround sound. BD-R is a recordable Blu-ray Disc that can be written to once. BD-RE is a Blu-ray Disc that can be erased and re-recorded multiple times.

**Bluetooth® wireless technology** — A wireless technology standard for short-range (9 m [29 feet]) networking devices that allows for enabled devices to automatically recognize each other.

**boot sequence** — Specifies the order of the devices from which the computer attempts to boot.

**bootable media** — A CD, DVD, or floppy disk that you can use to start your computer. In case your hard drive is damaged or your computer has a virus, ensure that you always have a bootable CD, DVD, or floppy disk available. Your *Drivers and Utilities* media is an example of bootable media.

**bps** — bits per second — The standard unit for measuring data transmission speed.

**BTU** — British thermal unit — A measurement of heat output.

**bus** — A communication pathway between the

components in your computer.

**bus speed** — The speed, given in MHz, that indicates how fast a bus can transfer information.

**byte** — The basic data unit used by your computer. A byte is usually equal to 8 bits.

## C

**C** — Celsius — A temperature measurement scale where 0° is the freezing point and 100° is the boiling point of water.

**cache** — A special high-speed storage mechanism which can be either a reserved section of main memory or an independent high-speed storage device. The cache enhances the efficiency of many processor operations.

**L1 cache** — Primary cache stored inside the processor.

**L2 cache** — Secondary cache which can either be external to the processor or incorporated into the processor architecture.

**carney** — An international customs document that facilitates temporary imports into foreign countries. Also known as a *merchandise passport*.

**CD-R** — CD recordable — A recordable version of a CD. Data can be recorded only once onto a CD-R. Once recorded, the data cannot be erased or written over.

**CD-RW** — CD rewritable — A rewritable version of a CD. Data can be written to a CD-RW disc, and then erased and written over (rewritten).

**CD-RW drive** — A drive that can read CDs and write to CD-RW (rewritable CDs) and CD-R (recordable CDs) discs. You can write to CD-RW discs multiple times, but you can write to CD-R discs only once.

**CD-RW/DVD drive** — A drive, sometimes referred to as a combo drive, that can read CDs and DVDs and write to CD-RW (rewritable CDs) and CD-R (recordable CDs) discs. You can write to CD-RW discs multiple times, but you can write to CD-R discs only once.

**clock speed** — The speed, given in MHz, that indicates how fast computer components that are connected to the system bus operate.

**CMOS** — A type of electronic circuit. Computers use a

small amount of battery-powered CMOS memory to hold date, time, and system setup options.

**COA** — Certificate of Authenticity — The Windows alpha-numeric code located on a sticker on your computer. Also referred to as the *Product Key* or *Product ID*.

**Control Panel** — A Windows utility that allows you to modify operating system and hardware settings, such as display settings.

**controller** — A chip that controls the transfer of data between the processor and memory or between the processor and devices.

**CRIMM** — continuity rambus in-line memory module — A special module that has no memory chips and is used to fill unused RIMM slots.

**cursor** — The marker on a display or screen that shows where the next keyboard, touch pad, or mouse action will occur. It often is a blinking solid line, an underline character, or a small arrow.

## D

**DDR SDRAM** — double-data-rate SDRAM — A type of SDRAM that doubles the data burst cycle, improving system performance.

**DDR2 SDRAM** — double-data-rate 2 SDRAM — A type of DDR SDRAM that uses a 4-bit prefetch and other architectural changes to boost memory speed to over 400 MHz.

**device** — Hardware such as a disk drive, printer, or keyboard that is installed in or connected to your computer.

**device driver** — See *driver*.

**DIMM** — dual in-line memory module — A circuit board with memory chips that connects to a memory module on the system board.

**DIN connector** — A round, six-pin connector that conforms to DIN (Deutsche Industrie-Norm) standards; it is typically used to connect PS/2 keyboard or mouse cable connectors.

**disk striping** — A technique for spreading data over

multiple disk drives. Disk striping can speed up operations that retrieve data from disk storage. Computers that use disk striping generally allow the user to select the data unit size or stripe width.

**DMA** — direct memory access — A channel that allows certain types of data transfer between RAM and a device to bypass the processor.

**docking device** — See *APR*.

**DMTF** — Distributed Management Task Force — A consortium of hardware and software companies who develop management standards for distributed desktop, network, enterprise, and Internet environments.

**domain** — A group of computers, programs, and devices on a network that are administered as a unit with common rules and procedures for use by a specific group of users. A user logs on to the domain to gain access to the resources.

**DRAM** — dynamic random-access memory — Memory that stores information in integrated circuits containing capacitors.

**driver** — Software that allows the operating system to control a device such as a printer. Many devices do not work properly if the correct driver is not installed in the computer.

**DSL** — Digital Subscriber Line — A technology that provides a constant, high-speed Internet connection through an analog telephone line.

**dual-core** — A technology in which two physical computational units exist inside a single processor package, thereby increasing computing efficiency and multi-tasking ability.

**dual display mode** — A display setting that allows you to use a second monitor as an extension of your display. Also referred to as *extended display mode*.

**DVD-R** — DVD recordable — A recordable version of a DVD. Data can be recorded only once onto a DVD-R. Once recorded, the data cannot be erased or written over.

**DVD+RW** — DVD rewritable — A rewritable version of a DVD. Data can be written to a DVD+RW disc, and then erased and written over (rewritten). (DVD+RW technology is different from DVD-RW technology.)

**DVD+RW drive** — drive that can read DVDs and most

CD media and write to DVD+RW (rewritable DVDs) discs.

**DVI** — digital video interface — A standard for digital transmission between a computer and a digital video display.

## E

**ECC** — error checking and correction — A type of memory that includes special circuitry for testing the accuracy of data as it passes in and out of memory.

**ECP** — extended capabilities port — A parallel connector design that provides improved bidirectional data transmission. Similar to EPP, ECP uses direct memory access to transfer data and often improves performance.

**EIDE** — enhanced integrated device electronics — An improved version of the IDE interface for hard drives and CD drives.

**EMI** — electromagnetic interference — Electrical interference caused by electromagnetic radiation.

**ENERGY STAR®** — Environmental Protection Agency requirements that decrease the overall consumption of electricity.

**EPP** — enhanced parallel port — A parallel connector design that provides bidirectional data transmission.

**ESD** — electrostatic discharge — A rapid discharge of static electricity. ESD can damage integrated circuits found in computer and communications equipment.

**expansion card** — A circuit board that installs in an expansion slot on the system board in some computers, expanding the capabilities of the computer. Examples include video, modem, and sound cards.

**expansion slot** — A connector on the system board (in some computers) where you insert an expansion card, connecting it to the system bus.

**ExpressCard** — A removable I/O card adhering to the PCMCIA standard. Modems and network adapters are common types of ExpressCards. ExpressCards support both the PCI Express and USB 2.0 standard.

**Express Service Code** — A numeric code located on a sticker on your Dell™ computer. Use the Express Service

Code when contacting Dell for assistance. Express Service Code service may not be available in some countries.

**extended display mode** — A display setting that allows you to use a second monitor as an extension of your display. Also referred to as *dual display mode*.

**extended PC Card** — A PC Card that extends beyond the edge of the PC Card slot when installed.

## F

**Fahrenheit** — A temperature measurement scale where 32° is the freezing point and 212° is the boiling point of water.

**FBD** — fully-buffered DIMM — A DIMM with DDR2 DRAM chips and an Advanced Memory Buffer (AMB) that speeds communication between the DDR2 SDRAM chips and the system.

**FCC** — Federal Communications Commission — A U.S. agency responsible for enforcing communications-related regulations that state how much radiation computers and other electronic equipment can emit.

**fingerprint reader** — A strip sensor that uses your unique fingerprint to authenticate your user identity to help secure your computer.

**folder** — A term used to describe space on a disk or drive where files are organized and grouped. Files in a folder can be viewed and ordered in various ways, such as alphabetically, by date, and by size.

**format** — The process that prepares a drive or disk for file storage. When a drive or disk is formatted, the existing information on it is lost.

**FSB** — front side bus — The data path and physical interface between the processor and RAM.

**FTP** — file transfer protocol — A standard Internet protocol used to exchange files between computers connected to the Internet.

## G

**G** — gravity — A measurement of weight and force.

**GB** — gigabyte — A measurement of data storage that

equals 1024 MB (1,073,741,824 bytes). When used to refer to hard drive storage, the term is often rounded to 1,000,000,000 bytes.

**GHz** — gigahertz — A measurement of frequency that equals one thousand million Hz, or one thousand MHz. The speeds for computer processors, buses, and interfaces are often measured in GHz.

**graphics mode** — A video mode that can be defined as *x* horizontal pixels by *y* vertical pixels by *z* colors. Graphics modes can display an unlimited variety of shapes and fonts.

**GUI** — graphical user interface — Software that interacts with the user by means of menus, windows, and icons. Most programs that operate on the Windows operating systems are GUIs.

## H

**hard drive** — A drive that reads and writes data on a hard disk. The terms hard drive and hard disk are often used interchangeably.

**heat sink** — A metal plate on some processors that helps dissipate heat.

**hibernate mode** — A power management mode that saves everything in memory to a reserved space on the hard drive and then turns off the computer. When you restart the computer, the memory information that was saved to the hard drive is automatically restored.

**HTTP** — hypertext transfer protocol — A protocol for exchanging files between computers connected to the Internet.

**Hyper-Threading** — Hyper-Threading is an Intel technology that can enhance overall computer performance by allowing one physical processor to function as two logical processors, capable of performing certain tasks simultaneously.

**Hz** — hertz — A unit of frequency measurement that equals 1 cycle per second. Computers and electronic devices are often measured in kilohertz (kHz), megahertz (MHz), gigahertz (GHz), or terahertz (THz).

## I

**IC** — integrated circuit — A semiconductor wafer, or chip, on which thousands or millions of tiny electronic components are fabricated for use in computer, audio, and video equipment.

**IDE** — integrated device electronics — An interface for mass storage devices in which the controller is integrated into the hard drive or CD drive.

**IEEE 1394** — Institute of Electrical and Electronics Engineers, Inc. — A high-performance serial bus used to connect IEEE 1394-compatible devices, such as digital cameras and DVD players, to the computer.

**integrated** — Usually refers to components that are physically located on the computer's system board. Also referred to as *built-in*.

**I/O** — input/output — An operation or device that enters and extracts data from your computer. Keyboards and printers are I/O devices.

**I/O address** — An address in RAM that is associated with a specific device (such as a serial connector, parallel connector, or expansion slot) and allows the processor to communicate with that device.

**IRQ** — interrupt request — An electronic pathway assigned to a specific device so that the device can communicate with the processor. Each device connection must be assigned an **IRQ**. Although two devices can share the same **IRQ** assignment, you cannot operate both devices simultaneously.

**ISP** — Internet service provider — A company that allows you to access its host server to connect directly to the Internet, send and receive e-mail, and access websites. The ISP typically provides you with a software package, user name, and access phone numbers for a fee.

## K

**Kb** — kilobit — A unit of data that equals 1024 bits. A measurement of the capacity of memory integrated circuits.

**KB** — kilobyte — A unit of data that equals 1024 bytes but is often referred to as 1000 bytes.

**key combination** — A command requiring you to press multiple keys at the same time.

**kHz** — kilohertz — A measurement of frequency that equals 1000 Hz.

## L

**LAN** — local area network — A computer network covering a small area. A LAN usually is confined to a building or a few nearby buildings. A LAN can be connected to another LAN over any distance through telephone lines and radio waves to form a wide area network (WAN).

**LCD** — liquid crystal display — The technology used by portable computer and flat-panel displays.

**LED** — light-emitting diode — An electronic component that emits light to indicate the status of the computer.

**local bus** — A data bus that provides a fast throughput for devices to the processor.

**LPT** — line print terminal — The designation for a parallel connection to a printer or other parallel device.

## M

**Mb** — megabit — A measurement of memory chip capacity that equals 1024 Kb.

**Mbps** — megabits per second — One million bits per second. This measurement is typically used for transmission speeds for networks and modems.

**MB** — megabyte — A measurement of data storage that equals 1,048,576 bytes. 1 MB equals 1024 KB. When used to refer to hard drive storage, the term is often rounded to 1,000,000 bytes.

**MB/sec** — megabytes per second — One million bytes per second. This measurement is typically used for data transfer ratings.

**media bay** — A bay that supports devices such as optical drives, a second battery, or a Dell TravelLite™ module.

**memory** — A temporary data storage area inside your computer. Because the data in memory is not permanent, it is recommended that you frequently save your files

while you are working on them, and always save your files before you shut down the computer. Your computer can contain several different forms of memory, such as RAM, ROM, and video memory. Frequently, the word memory is used as a synonym for RAM.

**memory address** — A specific location where data is temporarily stored in RAM.

**memory mapping** — The process by which the computer assigns memory addresses to physical locations at start-up. Devices and software can then identify information that the processor can access.

**memory module** — A small circuit board containing memory chips, which connects to the system board.

**MHz** — megahertz — A measure of frequency that equals 1 million cycles per second. The speeds for computer processors, buses, and interfaces are often measured in MHz.

**Mini PCI** — A standard for integrated peripheral devices with an emphasis on communications such as modems and NICs. A Mini PCI card is a small external card that is functionally equivalent to a standard PCI expansion card.

**Mini-Card** — A small card designed for integrated peripherals, such as communication NICs. The Mini-Card is functionally equivalent to a standard PCI expansion card.

**modem** — A device that allows your computer to communicate with other computers over analog telephone lines. Three types of modems include: external, PC Card, and internal. You typically use your modem to connect to the Internet and exchange e-mail.

**module bay** — See *media bay*.

**MP** — megapixel — A measure of image resolution used for digital cameras.

**ms** — millisecond — A measure of time that equals one thousandth of a second. Access times of storage devices are often measured in ms.

## N

**network adapter** — A chip that provides network capabilities. A computer may include a network adapter

on its system board, or it may contain a PC Card with an adapter on it. A network adapter is also referred to as a NIC (network interface controller).

**NIC** — See *network adapter*.

**notification area** — The section of the Windows taskbar that contains icons for providing quick access to programs and computer functions, such as the clock, volume control, and print status. Also referred to as *system tray*.

**ns** — nanosecond — A measure of time that equals one billionth of a second.

**NVRAM** — nonvolatile random access memory — A type of memory that stores data when the computer is turned off or loses its external power source. NVRAM is used for maintaining computer configuration information such as date, time, and other system setup options that you can set.

## O

**optical drive** — A drive that uses optical technology to read or write data from CDs, DVDs, or DVD+RWs. Example of optical drives include CD drives, DVD drives, CD-RW drives, and CD-RW/DVD combo drives.

## P

**parallel connector** — An I/O port often used to connect a parallel printer to your computer. Also referred to as an *LPT port*.

**partition** — A physical storage area on a hard drive that is assigned to one or more logical storage areas known as logical drives. Each partition can contain multiple logical drives.

**PC Card** — A removable I/O card adhering to the PCMCIA standard. Modems and network adapters are common types of PC Cards.

**PCI** — peripheral component interconnect — PCI is a local bus that supports 32- and 64-bit data paths, providing a high-speed data path between the processor and devices such as video, drives, and networks.

**PCI Express** — A modification to the PCI interface that boosts the data transfer rate between the processor and



the devices attached to it. PCI Express can transfer data at speeds from 250 MB/sec to 4 GB/sec. If the PCI Express chip set and the device are capable of different speeds, they will operate at the slower speed.

**PCMCIA** — Personal Computer Memory Card International Association — The organization that establishes standards for PC Cards.

**PIO** — programmed input/output — A method of transferring data between two devices through the processor as part of the data path.

**pixel** — A single point on a display screen. Pixels are arranged in rows and columns to create an image. A video resolution, such as 800 x 600, is expressed as the number of pixels across by the number of pixels up and down.

**Plug-and-Play** — The ability of the computer to automatically configure devices. Plug and Play provides automatic installation, configuration, and compatibility with existing hardware if the BIOS, operating system, and all devices are Plug and Play compliant.

**POST** — power-on self-test — Diagnostics programs, loaded automatically by the BIOS, that perform basic tests on the major computer components, such as memory, hard drives, and video. If no problems are detected during POST, the computer continues the start-up.

**processor** — A computer chip that interprets and executes program instructions. Sometimes the processor is referred to as the CPU (central processing unit).

**PS/2** — personal system/2 — A type of connector for attaching a PS/2-compatible keyboard, mouse, or keypad.

**PXE** — pre-boot execution environment — A WfM (Wired for Management) standard that allows networked computers that do not have an operating system to be configured and started remotely.

## R

**RAID** — redundant array of independent disks — A method of providing data redundancy. Some common implementations of RAID include RAID 0, RAID 1, RAID 5, RAID 10, and RAID 50.

**RAM** — random-access memory — The primary

temporary storage area for program instructions and data. Any information stored in RAM is lost when you shut down your computer.

**readme file** — A text file included with a software package or hardware product. Typically, readme files provide installation information and describe new product enhancements or corrections that have not yet been documented.

**read-only** — Data and/or files you can view but cannot edit or delete. A file can have read-only status if:

- It resides on a physically write-protected floppy disk, CD, or DVD.
- It is located on a network in a directory and the system administrator has assigned rights only to specific individuals.

**refresh rate** — The frequency, measured in Hz, at which your screen's horizontal lines are recharged (sometimes also referred to as its *vertical frequency*). The higher the refresh rate, the less video flicker can be seen by the human eye.

**resolution** — The sharpness and clarity of an image produced by a printer or displayed on a monitor. The higher the resolution, the sharper the image.

**RFI** — radio frequency interference — Interference that is generated at typical radio frequencies, in the range of 10 kHz to 100,000 MHz. Radio frequencies are at the lower end of the electromagnetic frequency spectrum and are more likely to have interference than the higher frequency radiations, such as infrared and light.

**ROM** — read-only memory — Memory that stores data and programs that cannot be deleted or written to by the computer. ROM, unlike RAM, retains its contents after you shut down your computer. Some programs essential to the operation of your computer reside in ROM.

**RPM** — revolutions per minute — The number of rotations that occur per minute. Hard drive speed is often measured in rpm.

**RTC** — real time clock — Battery-powered clock on the system board that keeps the date and time after you shut down the computer.

**RTCST** — real-time clock reset — A jumper on the system board of some computers that can often be used

for troubleshooting problems.

## S

**SAS** — serial attached SCSI — A faster, serial version of the SCSI interface (as opposed to the original SCSI parallel architecture).

**SATA** — serial ATA — A faster, serial version of the ATA (IDE) interface.

**ScanDisk** — A Microsoft utility that checks files, folders, and the hard disk's surface for errors. ScanDisk often runs when you restart the computer after it has stopped responding.

**SCSI** — small computer system interface — A high-speed interface used to connect devices to a computer, such as hard drives, CD drives, printers, and scanners. The SCSI can connect many devices using a single controller. Each device is accessed by an individual identification number on the SCSI controller bus.

**SDRAM** — synchronous dynamic random-access memory — A type of DRAM that is synchronized with the optimal clock speed of the processor.

**serial connector** — An I/O port often used to connect devices such as a handheld digital device or digital camera to your computer.

**Service Tag** — A bar code label on your computer that identifies your computer when you access Dell Support at [support.dell.com](http://support.dell.com) or when you call Dell for customer service or technical support.

**setup program** — A program that is used to install and configure hardware and software. The **setup.exe** or **install.exe** program comes with most Windows software packages. *Setup program* differs from *system setup*.

**shortcut** — An icon that provides quick access to frequently used programs, files, folders, and drives. When you place a shortcut on your Windows desktop and double-click the icon, you can open its corresponding folder or file without having to find it first. Shortcut icons do not change the location of files. If you delete a shortcut, the original file is not affected. Also, you can rename a shortcut icon.

**SIM** — Subscriber Identity Module — A SIM card

contains a microchip that encrypts voice and data transmissions. SIM cards can be used in phones or portable computers.

**Smart Card** — A card that is embedded with a processor and a memory chip. Smart cards can be used to authenticate a user on computers equipped for smart cards.

**S/PDIF** — Sony/Philips Digital Interface — An audio transfer file format that allows the transfer of audio from one file to another without converting it to and from an analog format, which could degrade the quality of the file.

**standby mode** — A power management mode that shuts down all unnecessary computer operations to save energy.

**Strike Zone™** — Reinforced area of the platform base that protects the hard drive by acting as a dampening device when a computer experiences resonating shock or is dropped (whether the computer is on or off).

**surge protectors** — Prevent voltage spikes, such as those that may occur during an electrical storm, from entering the computer through the electrical outlet. Surge protectors do not protect against lightning strikes or against brownouts, which occur when the voltage drops more than 20 percent below the normal AC-line voltage level.

Network connections cannot be protected by surge protectors. Always disconnect the network cable from the network connector during electrical storms.

**SVGA** — super-video graphics array — A video standard for video cards and controllers. Typical SVGA resolutions are 800 x 600 and 1024 x 768.

The number of colors and resolution that a program displays depends on the capabilities of the monitor, the video controller and its drivers, and the amount of video memory installed in the computer.

**S-video TV-out** — A connector used to attach a TV or digital audio device to the computer.

**SXGA** — super-extended graphics array — A video standard for video cards and controllers that supports resolutions up to 1280 x 1024.

**SXGA+** — super-extended graphics array plus — A video standard for video cards and controllers that supports resolutions up to 1400 x 1050.

**system board** — The main circuit board in your computer. Also known as the *motherboard*.

**system setup** — A utility that serves as an interface between the computer hardware and the operating system. System setup allows you to configure user-selectable options in the BIOS, such as date and time or system password. Unless you understand what effect the settings have on the computer, do not change the settings for this program.

## T

**TAPI** — telephony application programming interface — Enables Windows programs to operate with a wide variety of telephony devices, including voice, data, fax, and video.

**text editor** — A program used to create and edit files that contain only text; for example, Windows Notepad uses a text editor. Text editors do not usually provide word wrap or formatting functionality (the option to underline, change fonts, and so on).

**TPM** — trusted platform module — A hardware-based security feature that when combined with security software enhances network and computer security by enabling features such as file and e-mail protection.

**travel module** — A plastic device designed to fit inside the module bay of a portable computer to reduce the weight of the computer.

## U

**UAC** — user account control— Microsoft Windows Vista® security feature that, when enabled, provides an added layer of security between user accounts and access to operating system settings.

**UMA** — unified memory allocation — System memory dynamically allocated to video.

**UPS** — uninterruptible power supply — A backup power source used when the electrical power fails or drops to an unacceptable voltage level. A UPS keeps a computer running for a limited amount of time when there is no electrical power. UPS systems typically provide surge suppression and may also provide voltage regulation.

Small UPS systems provide battery power for a few minutes to enable you to shut down your computer.

**USB** — universal serial bus — A hardware interface for a low-speed device such as a USB-compatible keyboard, mouse, joystick, scanner, set of speakers, printer, broadband devices (DSL and cable modems), imaging devices, or storage devices. Devices are plugged directly in to a 4-pin socket on your computer or in to a multi-port hub that plugs in to your computer. USB devices can be connected and disconnected while the computer is turned on, and they can also be daisy-chained together.

**UTP** — unshielded twisted pair — Describes a type of cable used in most telephone networks and some computer networks. Pairs of unshielded wires are twisted to protect against electromagnetic interference, rather than relying on a metal sheath around each pair of wires to protect against interference.

**UXGA** — ultra extended graphics array — A video standard for video cards and controllers that supports resolutions up to 1600 x 1200.

## V

**video controller** — The circuitry on a video card or on the system board (in computers with an integrated video controller) that provides the video capabilities—in combination with the monitor—for your computer.

**video memory** — Memory that consists of memory chips dedicated to video functions. Video memory is usually faster than system memory. The amount of video memory installed primarily influences the number of colors that a program can display.

**video mode** — A mode that describes how text and graphics are displayed on a monitor. Graphics-based software, such as Windows operating systems, displays in video modes that can be defined as  $x$  horizontal pixels by  $y$  vertical pixels by  $z$  colors. Character-based software, such as text editors, displays in video modes that can be defined as  $x$  columns by  $y$  rows of characters.

**video resolution** — See *resolution*.

**virus** — A program that is designed to inconvenience you or to destroy data stored on your computer. A virus program moves from one computer to another through an

infected disk, software downloaded from the Internet, or e-mail attachments. When an infected program starts, its embedded virus also starts.

A common type of virus is a boot virus, which is stored in the boot sectors of a floppy disk. If the floppy disk is left in the drive when the computer is shut down and then turned on, the computer is infected when it reads the boot sectors of the floppy disk expecting to find the operating system. If the computer is infected, the boot virus may replicate itself onto all the floppy disks that are read or written in that computer until the virus is eradicated.

**V** — volt — The measurement of electric potential or electromotive force. One V appears across a resistance of 1 ohm when a current of 1 ampere flows through that resistance.

## W

**W** — watt — The measurement of electrical power. One W is 1 ampere of current flowing at 1 volt.

**WHr** — watt-hour — A unit of measure commonly used to indicate the approximate capacity of a battery. For example, a 66-WHr battery can supply 66 W of power for 1 hour or 33 W for 2 hours.

**wallpaper** — The background pattern or picture on the Windows desktop. Change your wallpaper through the Windows Control Panel. You can also scan in your favorite picture and make it wallpaper.

**WLAN** — wireless local area network. A series of interconnected computers that communicate with each other over the air waves using access points or wireless routers to provide Internet access.

**write-protected** — Files or media that cannot be changed. Use write-protection when you want to protect data from being changed or destroyed. To write-protect a 3.5-inch floppy disk, slide its write-protect tab to the open position.

**WWAN** — wireless wide area network. A wireless high-speed data network using cellular technology and covering a much larger geographic area than WLAN.

**WXGA** — wide-aspect extended graphics array — A video

standard for video cards and controllers that supports resolutions up to 1280 x 800.

## X

**XGA** — extended graphics array — A video standard for video cards and controllers that supports resolutions up to 1024 x 768.

## Z

**ZIF** — zero insertion force — A type of socket or connector that allows a computer chip to be installed or removed with no stress applied to either the chip or its socket.

**Zip** — A popular data compression format. Files that have been compressed with the Zip format are called Zip files and usually have a filename extension of **.zip**. A special kind of zipped file is a self-extracting file, which has a filename extension of **.exe**. You can unzip a self-extracting file by double-clicking it.

**Zip drive** — A high-capacity floppy drive developed by Iomega Corporation that uses 3.5-inch removable disks called Zip disks. Zip disks are slightly larger than regular floppy disks, about twice as thick, and hold up to 100 MB of data.

# Appendix

## FCC Notice (U.S. Only)

### FCC Class B

This equipment generates, uses, and can radiate radio frequency energy and, if not installed and used in accordance with the manufacturer's instruction manual, may cause interference with radio and television reception. This equipment has been tested and found to comply with the limits for a Class B digital device pursuant to Part 15 of the FCC Rules.

This device complies with Part 15 of the FCC Rules. Operation is subject to the following two conditions:

- 1 This device may not cause harmful interference.
- 2 This device must accept any interference received, including interference that may cause undesired operation.



**NOTICE:** The FCC regulations provide that changes or modifications not expressly approved by Dell Inc. could void your authority to operate this equipment.

These limits are designed to provide reasonable protection against harmful interference in a residential installation. However, there is no guarantee that interference will not occur in a particular installation. If this equipment does cause harmful interference with radio or television reception, which can be determined by turning the equipment off and on, you are encouraged to try to correct the interference by one or more of the following measures:

- Reorient the receiving antenna.
- Relocate the system with respect to the receiver.
- Move the system away from the receiver.
- Plug the system into a different outlet so that the system and the receiver are on different branch circuits.

If necessary, consult a representative of Dell Inc. or an experienced radio/television technician for additional suggestions.

The following information is provided on the device or devices covered in this document in compliance with the FCC regulations:

- Product name: Latitude
- Model number: PP09S
- Company name:  
Dell Inc.  
Worldwide Regulatory Compliance & Environmental Affairs

One Dell Way  
Round Rock, TX 78682 USA  
512-338-4400

 **NOTE:** For further regulatory information, see your *Product Information Guide*.

## **Macrovision Product Notice**

This product incorporates copyright protection technology that is protected by method claims of certain U.S. patents and other intellectual property rights owned by Macrovision Corporation and other rights owners. Use of this copyright protection technology must be authorized by Macrovision Corporation, and is intended for home and other limited viewing uses only unless otherwise authorized by Macrovision Corporation. Reverse engineering or disassembly is prohibited.