

# User's Manual

**TOSHIBA mini NB300/NB305**

## Copyright

© 2009 by TOSHIBA Corporation. All rights reserved. Under the copyright laws, this manual cannot be reproduced in any form without the prior written permission of TOSHIBA. No patent liability is assumed, with respect to the use of the information contained herein.

TOSHIBA mini NB300/NB305 User's Manual

First edition October 2009

Copyright authority for music, movies, computer programs, databases and other intellectual property covered by copyright laws belongs to the author or to the copyright owner. Copyrighted material can be reproduced only for personal use or use within the home. Any other use beyond that stipulated above (including conversion to digital format, alteration, transfer of copied material and distribution on a network) without the permission of the copyright owner is a violation of copyright or author's rights and is subject to civil damages or criminal action. Please comply with copyright laws in making any reproduction from this manual.

## Disclaimer

This manual has been validated and reviewed for accuracy. The instructions and descriptions it contains are accurate for the TOSHIBA mini NB300/NB305 Portable Personal Computers at the time of this manual's production. However, succeeding computers and manuals are subject to change without notice. TOSHIBA assumes no liability for damages incurred directly or indirectly from errors, omissions or discrepancies between the computer and the manual.

## Trademarks

IBM is a registered trademark and IBM PC is a trademark of International Business Machine Corporation.

Intel, Intel Atom are registered trademarks or trademarks of Intel Corporation.

Microsoft, Windows and Windows logo are either registered trademarks or trademarks of Microsoft Corporation.

DirectX, ActiveDesktop, DirectShow, and Windows Media are registered trademarks of Microsoft Corporation.

Adobe is either a registered trademark or trademark of Adobe Systems Incorporated in the United States.

Bluetooth is a registered trademark owned by its proprietor and used by TOSHIBA under license.

ConfigFree is a trademark of TOSHIBA Corporation,

Wi-Fi is a registered trademark of the Wi-Fi Alliance.

Secure Digital and SD are trademarks of the SD Card Association.

MultiMediaCard and MMC are trademarks of the MultiMediaCard Association.

Other trademarks and registered trademarks not listed above may be used in this manual.

## EU Conformity Statement

 This product is carrying the CE-Mark in accordance with the related European Directives. Responsible for CE-Marking is TOSHIBA Europe GmbH, Hammfelddamm 8, 41460 Neuss, Germany. The complete and official EU Declaration of Conformity can be found on TOSHIBA's web site <http://epps.toshiba-teg.com> on the Internet.

## CE compliance

This product is labelled with the CE Mark in accordance with the related European Directives, notably Electromagnetic Compatibility Directive 2004/108/EC for the notebook and the electronic accessories including the supplied power adapter, the Radio Equipment and Telecommunications Terminal Equipment Directive 1999/5/EC in case of implemented telecommunication accessories and the Low Voltage Directive 2006/95/EC for the supplied power adapter. This product and the original options are designed to observe the related EMC (Electromagnetic Compatibility) and safety standards. However, TOSHIBA cannot guarantee that this product still observes these EMC standards if options or cables not produced by TOSHIBA are connected or implemented. In this case the persons who have connected/implemented those options/cables have to provide assurance that the system (PC plus options/cables) still fulfils the required standards. To avoid general EMC problems, the following guidance should be noted:

- Only CE marked options should be connected/implemented
- Only best shielded cables should be connected

## Working environment

This product was designed to fulfil the EMC (Electromagnetic Compatibility) requirements to be observed for so-called "Residential, commercial and light industry environments". TOSHIBA do not approve the use of this product in working environments other than the above mentioned "Residential, commercial and light industry environments". For example, the following environments are not approved:

- Industrial Environments (e.g. environments where a mains voltage of 380 V three-phase is used)
- Medical Environments
- Automotive Environments
- Aircraft Environments

Any consequences resulting from the use of this product in working environments that are not approved are not the responsibility of TOSHIBA. The consequences of the use of this product in non-approved working environments may be:

- Interference with other devices or machines in the near surrounding area.
- Malfunction of, or data loss from, this product caused by disturbances generated by other devices or machines in the near surrounding area.

Therefore TOSHIBA strongly recommend that the electromagnetic compatibility of this product should be suitably tested in all non-approved working environments before use. In the case of automobiles or aircraft, the manufacturer or airline respectively should be asked for permission before use of this product. Furthermore, for general safety reasons, the use of this product in environments with explosive atmospheres is not permitted.



*Regulatory and agency labels may be located on the computer bottom or under battery.*

## GOST

П о р т а т и в н ы й    К о м п ь ю т е р

И з г о т о в и т е л ь: Toshiba Europe GmbH

А д р е с : Hammfelddamm 8  
41460 Neuss, Germany

С д е л а н о в   К и т а е



## Following information is only for EU-member states:

### Disposal of products

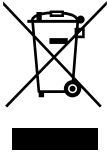

The crossed out wheeled dust bin symbol indicates that products must be collected and disposed of separately from household waste. Integrated batteries and accumulators can be disposed of with the product. They will be separated at the recycling centres.

The black bar indicates that the product was placed on the market after August 13, 2005.

By participating in separate collection of products and batteries, you will help to assure the proper disposal of products and batteries and thus help to prevent potential negative consequences for the environment and human health.

For more detailed information about the collection and recycling programmes available in your country, please visit our website (<http://eu.computers.toshiba-europe.com>) or contact your local city office or the shop where you purchased the product.

### Disposal of batteries and/or accumulators



The crossed out wheeled dust bin symbol indicates that batteries and/or accumulators must be collected and disposed of separately from household waste.

If the battery or accumulator contains more than the specified values of lead (Pb), mercury (Hg), and/or cadmium (Cd) defined in the Battery Directive (2006/66/EC), then the chemical symbols for lead (Pb), mercury (Hg) and/or cadmium (Cd) will appear below the crossed out wheeled dust bin symbol.

By participating in separate collection of batteries, you will help to assure the proper disposal of products and batteries and thus help to prevent potential negative consequences for the environment and human health.

For more detailed information about the collection and recycling programmes available in your country, please visit our website (<http://eu.computers.toshiba-europe.com>) or contact your local city office or the shop where you purchased the product.



*This symbol may not be displayed depending on the country and region where you purchased.*

## ENERGY STAR® Program



Your Computer model may be ENERGY STAR® compliant. If the model you purchased is compliant, it is labeled with the ENERGY STAR logo on the computer and the following information applies.

TOSHIBA is a partner in the ENERGY STAR Program and has designed this computer to meet the latest ENERGY STAR guidelines for energy efficiency. Your computer ships with the power management options preset to a configuration that will provide the most stable operating environment and optimum system performance for both AC power and battery modes.

To conserve energy, your computer is set to enter the low-power Sleep mode which shuts down the system and display within 15 minutes of inactivity in AC power mode. TOSHIBA recommends that you leave this and other energy saving features active, so that your computer will operate at its maximum energy efficiency. You can wake the computer from Sleep mode by pressing the power button.

Products that earn the ENERGY STAR prevent greenhouse gas emissions by meeting strict energy efficiency guidelines set by the US EPA and the EU Commission. According to the EPA, a computer meeting the new ENERGY STAR specifications will use between 20% and 50% less energy depending on how it is used.

Visit <http://www.eu-energystar.org> or <http://www.energystar.gov> for more information regarding the ENERGY STAR Program.

### Disposing of the computer and the computer's batteries

- Discard this computer in accordance with applicable laws and regulations. For further information, contact your local government.
- This computer contains rechargeable batteries. After repeated use, the batteries will finally lose their ability to hold a charge and you will need to replace them. Under certain applicable laws and regulation, it may be illegal to dispose of old batteries by placing them in the trash.
- Please be kind to our shared environment. Check with your local government authority for details regarding where to recycle old batteries or how to dispose of them properly. This product contains mercury. Disposal of this material may be regulated due to environmental considerations. For disposal, reuse or recycling information, please contact your local government.

## REACH - Compliance Statement

The new European Union (EU) chemical regulation, REACH (Registration, Evaluation, Authorization and Restriction of Chemicals), entered into force on 1 June 2007. Toshiba will meet all REACH requirements and is committed to provide our customers with information about the chemical substances in our products according to REACH regulation.

Please consult the following website

<http://www.toshiba-europe.com/computers/info/reach> for information about the presence in our articles of substances included on the candidate list according to article 59(1) of Regulation (EC) No 1907/2006 ("REACH") in a concentration above 0.1% weight by weight.

## Following information is only for Turkey:

- Compliant with EEE Regulations: Toshiba meets all requirements of Turkish regulation 26891 "Restriction of the use of certain hazardous substances in electrical and electronic equipment".
- The number of possible pixel failures of your display is defined according to ISO 13406-2 standards. If the number of pixel failures is less than this standard, they will not be counted as defect or failure.
- Battery is a consumption product, since the battery time depends on the usage of your computer. If the battery can not be charged at all, then it is a defect or failure. The changes in battery time is not a defect or failure.

# Table of Contents

<i>Chapter 1</i>	<b>Introduction</b>	
	Equipment checklist . . . . .	1-1
	Features . . . . .	1-2
	Special features . . . . .	1-6
	TOSHIBA Value Added Package . . . . .	1-9
	Utilities and Applications . . . . .	1-9
	Options . . . . .	1-10
<i>Chapter 2</i>	<b>The Grand Tour</b>	
	Front with the display closed . . . . .	2-1
	System indicators . . . . .	2-1
	Left side . . . . .	2-3
	Right side . . . . .	2-4
	Back side . . . . .	2-5
	Underside . . . . .	2-5
	Front with the display open . . . . .	2-7
	AC adaptor . . . . .	2-10
<i>Chapter 3</i>	<b>Getting Started</b>	
	Connecting the AC adaptor . . . . .	3-2
	Opening the display . . . . .	3-4
	Turning on the power . . . . .	3-5
	Starting up for the first time . . . . .	3-6
	Turning off the power . . . . .	3-7
	Restarting the computer . . . . .	3-10
	System Recovery Options . . . . .	3-11



**Chapter 4 Operating Basics**

Using the Touch Pad .....	4-1
USB Sleep and Charge function .....	4-2
TOSHIBA Disc Creator .....	4-4
Using the web camera .....	4-6
Using TOSHIBA Web Camera Application .....	4-7
Using the microphone .....	4-8
Wireless communications .....	4-8
Wireless WAN Guide .....	4-11
LAN .....	4-15
Cleaning the computer .....	4-16
Moving the computer .....	4-17
Heat dispersal .....	4-18
Using the Hard Disk Drive (HDD) Protection .....	4-18

**Chapter 5 The Keyboard**

Typewriter keys .....	5-1
Function keys: F1 ... F12 .....	5-2
Soft keys: FN key combinations .....	5-2
Hot keys .....	5-3
Windows special keys .....	5-5
Keypad overlay .....	5-6
Generating ASCII characters .....	5-7

**Chapter 6 Power and Power-up Modes**

Power conditions .....	6-1
Power indicators .....	6-2
Battery types .....	6-3
Care and use of the battery pack .....	6-5
Replacing the battery pack .....	6-9
TOSHIBA Password Utility .....	6-12
Power-up modes .....	6-13

**Chapter 7 HW Setup and Passwords**

HW Setup .....	7-1
Accessing HW Setup .....	7-1
HW Setup Window .....	7-1

<i>Chapter 8</i>	<b>Optional Devices</b>	
	Bridge media slot . . . . .	8-2
	Additional memory module . . . . .	8-3
	Battery Packs . . . . .	8-7
	Universal AC Adaptor . . . . .	8-7
	USB floppy diskette drive . . . . .	8-7
	USB optical disc drive . . . . .	8-7
	External monitor . . . . .	8-8
	Security lock . . . . .	8-9
<i>Chapter 9</i>	<b>Troubleshooting</b>	
	Problem solving process . . . . .	9-1
	Hardware and system checklist . . . . .	9-3
	TOSHIBA support . . . . .	9-13
<i>Chapter 10</i>	<b>Legal Footnotes</b>	
	CPU *1 . . . . .	10-1
	Memory (Main System) *2 . . . . .	10-2
	Battery Life *3 . . . . .	10-2
	HDD drive capacity *4 . . . . .	10-2
	LCD . . . . .	10-2
	Graphics Processor Unit (GPU) . . . . .	10-2
	Wireless LAN *7 . . . . .	10-3
	Non-applicable Icons . . . . .	10-3
	Copy Protection . . . . .	10-3
	USB Sleep and Charge . . . . .	10-3
<i>Appendix A</i>	<b>Specifications</b>	
<i>Appendix B</i>	<b>Display Controller</b>	
<i>Appendix C</i>	<b>Wireless LAN</b>	
<i>Appendix D</i>	<b>AC Power Cord and Connectors</b>	
<i>Appendix E</i>	<b>TOSHIBA PC Health Monitor</b>	
<i>Appendix F</i>	<b>If your computer is stolen</b>	
	<b>Glossary</b>	
	<b>Index</b>	

# Preface

Congratulations on your purchase of the TOSHIBA mini NB300/NB305 computer. This powerful notebook computer provides excellent expansion capability, includes multimedia functionality, and is designed to provide years of reliable, high-performance computing.

This manual tells how to set up and begin using your TOSHIBA mini NB300/NB305 computer. It also provides detailed information on configuring your computer, basic operations and care, using optional devices and troubleshooting.

If you are a new user of computers or if you're new to portable computing, first read over the *Introduction* and *The Grand Tour* chapters to familiarize yourself with the computer's features, components and accessory devices. Then read *Getting Started* for step-by-step instructions on setting up your computer.

If you are an experienced computer user, please continue reading the preface to learn how this manual is organized, then become acquainted with this manual by browsing through its pages. Be sure to read the *Special features* section of the Introduction, to learn about features that are uncommon or unique to this computer and carefully read *HW Setup and Passwords*. If you are going to connect external devices such as a printer, be sure to read Chapter 8, *Optional Devices*.

## Manual contents

This manual is composed of the following chapters, appendixes, a glossary and an index.

Chapter 1, *Introduction*, is an overview of the computer's features, capabilities, and options.

Chapter 2, *The Grand Tour*, identifies the components of the computer and briefly explains how they function.

Chapter 3, *Getting Started*, provides a quick overview of how to begin operating your computer.

Chapter 4, *Operating Basics*, includes tips on care of the computer and on using the Touch Pad, the web camera, the microphone, wireless communication and LAN.

Chapter 5, *The Keyboard*, describes special keyboard functions including the keypad overlay and hot keys.

Chapter 6, *Power and Power-up Modes*, gives details on the computer's power resources and battery save modes.

Chapter 7, *HW Setup and Passwords*, explains how to configure the computer using the HW Setup program. It also tells how to set a password.

Chapter 8, *Optional Devices*, describes the optional hardware available.

Chapter 9, *Troubleshooting*, provides helpful information on how to perform some diagnostic tests, and suggests courses of action if the computer doesn't seem to be working properly.

Chapter 10, *Legal Footnotes*, provides Legal Footnotes information related to your computer.

The *Appendixes* provide technical information about your computer.

The *Glossary* defines general computer terminology and includes a list of acronyms used in the text.

The *Index* quickly directs you to the information contained in this manual.

## Conventions

This manual uses the following formats to describe, identify, and highlight terms and operating procedures.

### Abbreviations

On first appearance, and whenever necessary for clarity, abbreviations are enclosed in parentheses following their definition. For example: Read Only Memory (ROM). Acronyms are also defined in the Glossary.

### Icons

Icons identify ports, dials, and other parts of your computer. The indicator panel also uses icons to identify the components it is providing information on.

### Keys

The keyboard keys are used in the text to describe many computer operations. A distinctive typeface identifies the key top symbols as they appear on the keyboard. For example, **ENTER** identifies the **ENTER** key.

## Key operation

Some operations require you to simultaneously use two or more keys. We identify such operations by the key top symbols separated by a plus sign (+). For example, **CTRL + C** means you must hold down **CTRL** and at the same time press **C**. If three keys are used, hold down the first two and at the same time press the third.

---

**ABC** When procedures require an action such as clicking an icon or entering text, the icon's name or the text you are to type in is represented in the typeface you see to the left.

---

## Display

---

**ABC** Names of windows or icons or text generated by the computer that appear on its display screen are presented in the type face you see to the left.

---

## Messages

Messages are used in this manual to bring important information to your attention. Each type of message is identified as shown below.



*Pay attention! A caution informs you that improper use of equipment or failure to follow instructions may cause data loss or damage your equipment.*



*Please read. A note is a hint or advice that helps you make best use of your equipment.*



*Indicates a potentially hazardous situation, which could result in death or serious injury, if you do not follow instructions.*

## Terminology

This term is defined in this document as follows:

---

**Start** The word "**Start**" refers to the "" button in Windows® 7.

---

# General Precautions

TOSHIBA computers are designed to optimize safety, minimize strain and withstand the rigors of portability. However, certain precautions should be observed to further reduce the risk of personal injury or damage to the computer.

Be certain to read the general precautions below and to note the cautions included in the text of the manual.

## Provide adequate ventilation

Always make sure your computer and AC adaptor have adequate ventilation and are protected from overheating when the power is turned on or when an AC adaptor is connected to a power outlet (even if your computer is in Sleep Mode). In this condition, observe the following:

- Never cover your computer or AC adaptor with any object.
- Never place your computer or AC adaptor near a heat source, such as an electric blanket or heater.
- Never cover or block the air vents including those located at the base of the computer.
- Always operate your computer on a hard flat surface. Using your computer on a carpet or other soft material can block the vents.
- Always provide sufficient space around the computer.
- Overheating your computer or AC adaptor could cause system failure, computer or AC adaptor damage or a fire, possibly resulting in serious injury.

## Creating a computer-friendly environment

Place the computer on a flat surface that is large enough for the computer and any other items you are using, such as a printer.

Leave enough space around the computer and other equipment to provide adequate ventilation. Otherwise, they may overheat.

To keep your computer in prime operating condition, protect your work area from:

- Dust, moisture, and direct sunlight.
- Equipment that generates a strong electromagnetic field, such as stereo speakers (other than speakers that are connected to the computer) or speakerphones.
- Rapid changes in temperature or humidity and sources of temperature change such as air conditioner vents or heaters.
- Extreme heat, cold, or humidity.
- Liquids and corrosive chemicals.

## Stress injury

Carefully read the *Instruction Manual for Safety and Comfort*. It contains information on the prevention of stress injuries to your hands and wrists that can be caused by extensive keyboard use.

## Heat injury

- Avoid prolonged physical contact with the computer. If the computer is used for long periods, its surface can become very warm. While the temperature will not feel hot to the touch, if you maintain physical contact with the computer for a long time, for example if you rest the computer on your lap or if you keep your hands on the palm rest, your skin might suffer a low-heat injury.
- If the computer has been used for a long time, avoid direct contact with the metal plate supporting the various interface ports as this can become hot.
- The surface of the AC adaptor can become hot when in use but this condition does not indicate a malfunction. If you need to transport the AC adaptor, you should disconnect it and let it cool before moving it.
- Do not lay the AC adaptor on a material that is sensitive to heat as the material could become damaged.

## Pressure or impact damage

Do not apply heavy pressure to the computer or subject it to any form of strong impact as this can damage the computer's components or otherwise cause it to malfunction.

## Mobile phones

Please be aware that the use of mobile phones can interfere with the audio system. The operation of the computer will not be impaired in any way, but it is recommended that a minimum distance of 30cm is maintained between the computer and a mobile phone that is in use.

## Instruction Manual for Safety and Comfort

All important information on the safe and proper use of this computer is described in the enclosed *Instruction Manual for Safety and Comfort*. Be sure to read it before using the computer.



# Chapter 1

## Introduction

This chapter provides an equipment checklist, and it identifies the computer's features, options and accessories.



*Some of the features described in this manual may not function properly if you use an operating system that was not pre-installed by TOSHIBA.*

## Equipment checklist

Carefully unpack your computer, taking care to save the box and packaging materials for future use.

### Hardware

Check to make sure you have all the following items:

- TOSHIBA mini NB300/NB305 Portable Personal Computer
- AC adaptor and power cord (2-pin plug or 3-pin plug)
- Battery pack

### Software

The following Windows® operating system and utility software are pre-installed.

- Windows® 7
- Bluetooth Driver
- Display Drivers for Windows
- TOSHIBA HWSetup
- TOSHIBA Supervisor Password
- LAN Driver
- Pointing Device Driver
- Sound Driver for Windows
- Wireless LAN Driver (Can be used only for Wireless LAN models)
- TOSHIBA Disc Creator
- TOSHIBA Recovery Media Creator
- TOSHIBA ConfigFree™

- TOSHIBA PC Health Monitor
- TOSHIBA Assist
- TOSHIBA eco Utility
- Online Manual
- TOSHIBA mini NB300/NB305 User's Manual (This manual)

## Documentation

- TOSHIBA mini NB300/NB305 Personal Computer User's Manual
- Instruction Manual for Safety and Control
- Warranty information
- TOSHIBA mini NB300/NB305 Personal Computer Quickstart

If any of the items are missing or damaged, contact your dealer immediately.

## Features

This computer incorporates the following features and benefits:

### Processor

<b>Built-in</b>	Your computer is equipped with one processor and processor type varies depending on model. To check which type of processor is included in your model, open the TOSHIBA PC Diagnostic Tool Utility by clicking <b>Start → All programs → TOSHIBA → Utilities → PC Diagnostic Tool</b> .
-----------------	-----------------------------------------------------------------------------------------------------------------------------------------------------------------------------------------------------------------------------------------------------------------------------------------

### Legal Footnote (CPU)\*1

For more information on the CPU, please refer to the [Legal Footnotes](#) section in Chapter 10 or click the \*1 above.

### Chipset

<b>Chipset</b>	Intel® NM10 Express Chipset.
----------------	------------------------------

### Memory

<b>Slot</b>	PC2-5300 (DDR2-667) or compatible 1GB or 2GB memory module can be installed in the memory slot.  Maximum system memory size is 2GB.
<b>Video RAM</b>	Video RAM capacity is shared with main memory with the proportion being allocated using Dynamic Video Memory Technology.

**Legal Footnote (Memory (Main System))\*2**

For more information regarding Memory (Main System), please refer to the [Legal Footnotes](#) section in Chapter 10 or click the \*2 above.

**Disks****Hard disk drive**

This computer supports SATA 3.0Gbps and is equipped with one of the following hard disk drive (HDD) types. The capacity of each hard disk drive model is different.

- HDD
  - 160GB
  - 250GB

Please note that part of the hard disk drives overall capacity is reserved as administration space.



Additional hard disk drive sizes may be introduced.

**Legal Footnote (Hard Disk Drive (HDD) Capacity)\*4**

For more information regarding Hard Disk Drive (HDD) Capacity, please refer to the [Legal Footnotes](#) section in Chapter 10 or click the \*4 above.

**Keyboard****Built-in**

The internal keyboard provides the embedded numeric overlay keys, dedicated cursor control overlay keys, and Keys. The keyboard is compatible with the IBM® enhanced keyboard. Refer to Chapter 5, [The Keyboard](#), for details.

**Pointing Device****Built-in Touch Pad**

The integrated Touch Pad and control buttons in the palm rest allow control of the on-screen pointer and support functions such as the scrolling of windows.

**Power****Battery pack**

The computer is powered by one rechargeable lithium-ion battery pack.

**Legal Footnote (Battery life) \*3**

For more information regarding Battery life, please refer to the [Legal Footnotes](#) in Chapter 10 or click the \*3 above.

---

<b>RTC battery</b>	The internal RTC battery backs up the Real Time Clock (RTC) and calendar.
<b>AC adaptor</b>	<p>The AC adaptor provides power to the system and recharges the batteries when they are low. It comes with a detachable power cord which will either have a 2-pin or 3-pin plug enclosure.</p> <p>As the AC adaptor is universal, it can receive a range of AC voltages from 100 to 240 volts, however you should note that the output current varies among different models. Using the wrong adaptor can damage your computer. Refer to the <a href="#">AC adaptor</a> section in Chapter 2, <i>The Grand Tour</i>.</p>

---

## Ports

---

<b>External monitor</b>	This port provides 15-pin, analog VGA port. This port allows you to connect an external monitor to the computer.
<b>Universal Serial Bus (USB 2.0)</b>	The computer supports multiple Universal Serial Bus ports that comply with the USB 2.0 standard. The port with the (⚡) has a <a href="#">USB Sleep and Charge function</a> .

---

## Slots

---

<b>Bridge media</b>	This slot lets you insert an SD™/SDHC™ memory card and MultiMediaCard™. Refer to Chapter 8, <i>Optional Devices</i> .
---------------------	-----------------------------------------------------------------------------------------------------------------------

---

## Multimedia

---

<b>Sound system</b>	The integrated sound system provides support for the computer's internal speakers and microphone, also allowing an external microphone and headphones to be connected via the appropriate jacks.
<b>Web Camera</b>	<b>Web Camera</b> is a device that allows you to record video or take photographs with your computer. You can use it for video chatting or video conferences using a communication tool such as <b>Windows Live Messenger</b> . <b>TOSHIBA Web Camera Application</b> will help you to add various video effects to your video or photograph.

---

<b>Headphone jack</b>	This jack lets you connect speakers or a stereo headphone. When you connect an external speaker or headphones, the internal speaker is automatically disabled.
<b>Microphone jack</b>	A 3.5mm mini microphone jack enables connection of a three-conductor mini jack for stereo microphone input, and connection of a stereo device for audio input.

## Communications

<b>LAN</b>	The computer has built-in support for Ethernet LAN (10 megabits per second, 10BASE-T) and Fast Ethernet LAN (100 megabits per second, 100BASE-TX).
<b>Bluetooth™</b>	Some models are equipped with Bluetooth wireless communication function which eliminates the need for cables between electronic devices such as computers and printers and mobile phones. When it is enabled, Bluetooth provides the wireless personal area network environment which is safe and trustworthy, that is quick and easy to use.
<b>Wireless LAN</b>	Some models are equipped with a Wireless LAN module that is compatible with other LAN systems based on Direct Sequence Spread Spectrum/Orthogonal Frequency Division Multiplexing radio technology that complies with the IEEE 802.11 Standard.



- *The transmission speed over the wireless LAN, and the distance over which the wireless LAN can reach, may vary depending on surrounding electromagnetic environment, obstacles, access point design and configuration, client design and software/hardware configurations. The transmission rate described is the theoretical maximum speed as specified under the appropriate standard - the actual transmission speed will be lower than the theoretical maximum speed.*
- *To enable or disable wireless communication, use the Hot Key **FN + F8**. For more information see the [Hot keys](#) section in Chapter 5.*

### **Legal Footnote (Wireless LAN)\*7**

*For more information regarding Wireless LAN, please refer to the [Legal Footnotes](#) section in Chapter 10 or click the \*7 above.*

## Security

<b>Security lock slot</b>	Allows the connection of a security lock to anchor the computer to a desk or other large object.
---------------------------	--------------------------------------------------------------------------------------------------

## Software

The computer's internal display panel supports high-resolution video graphics and can be set to a wide range of viewing angles for maximum comfort and readability.

<b>Operating system</b>	Windows® 7 is available. Refer to the preinstalled Software section at the front of this chapter.
<b>TOSHIBA Utilities</b>	A number of utilities and drivers are preinstalled to make your computer more convenient to use. Refer to the Utilities and Applications section in this chapter.
<b>Plug and Play</b>	When you connect an external device to the computer or when you install a component, Plug and Play capability enables the system to recognize the connection and make the necessary configurations automatically.

## Special features

The following features are either unique to TOSHIBA computers or are advanced features which make the computer more convenient to use.

Access each function using the following procedures.

\*1 To access the Power Options, click **Start → Control Panel → System and Security → Power Options**.

<b>Hot keys</b>	Hot keys are specific key combinations that let you quickly change the system configuration directly from the keyboard without running a system program.
<b>Monitor automatic power off *1</b>	This feature automatically cuts off power to the computer's display panel when there is no keyboard input for a specified time, with power being restored the next time a key is pressed. This can be specified in the Power Options.
<b>HDD automatic power off *1</b>	This feature automatically cuts off power to the hard disk drive when it is not accessed for a specified time, with power being restored when the hard disk drive is next accessed. This can be specified in the Power Options.
<b>System automatic Sleep/Hibernation Mode *1</b>	This feature automatically shuts down the system into either Sleep Mode or Hibernation Mode when there is no input or hardware access for a specified time. This can be specified in the Power Options.

<b>Keypad overlay</b>	A ten-key numeric keypad is integrated into the keyboard. Please refer to the <a href="#">Keypad overlay</a> section in Chapter 5, <a href="#">The Keyboard</a> , for information on using this feature.
<b>Power on password</b>	Two levels of password security, supervisor and user, are available to prevent unauthorized access to your computer.
<b>Instant security</b>	A specific hot key function automatically locks the system providing data security.
<b>Intelligent power supply <sup>*1</sup></b>	A microprocessor in the computer's intelligent power supply detects the battery's charge, automatically calculates the remaining battery capacity and protects electronic components from abnormal conditions such as a voltage overload from the AC adaptor. This can be specified in the Power Options.
<b>Battery save mode <sup>*1</sup></b>	This feature lets you configure the computer in order to save battery power. This can be specified in the Power Options.
<b>Low battery automatic Hibernation Mode <sup>*1</sup></b>	When battery power is exhausted to the point that computer operation cannot be continued, the system automatically enters Hibernation Mode and shuts itself down. This can be specified in the Power Options.
<b>Heat dispersal <sup>*1</sup></b>	To protect against overheating, the processor has an internal temperature sensor so that, if the computer's internal temperature rises to a certain level, the cooling fan is turned on or the processing speed is lowered. This can be specified in the Power Options.



*If the processor's temperature reaches an unacceptably high level with either setting, the computer will automatically shut down to prevent any damage - in this instance all unsaved data in memory will be lost.*

#### **TOSHIBA HDD Protection**

This feature which is for the hard disk drive models uses the acceleration sensor built in the computer to detect vibration, falls and shocks, and automatically moves the hard disk drive's read/write head to a safe position in order to reduce the risk of damage that could be caused by head-to-disk contact. Refer to the [Using the Hard Disk Drive \(HDD\) Protection](#) section in Chapter 4, [Operating Basics](#) for details.



*The TOSHIBA HDD Protection function does not guarantee that the hard disk drive will not be damaged.*

---

<b>Hibernation Mode</b>	This feature lets you turn off the power to the computer without exiting from your software. The contents of main memory are automatically saved to the hard disk drive so that when you next turn the power on again, you can continue working right where you left off. Refer to the <a href="#">Turning off the power</a> section in Chapter 3, <a href="#">Getting Started</a> , for more details.
<b>Sleep Mode</b>	If you have to interrupt your work, you can use this feature to allow you to turn off power to the computer without exiting from your software. Data is maintained in the computer's main memory so that when you next turn on the power, you can continue working right where you left off.
<b>USB Wakeup function</b>	<p>This function restores the computer from Sleep Mode depending on the external devices connected to the USB ports.</p> <p>For example, if a mouse or USB keyboard is connected to a USB port, moving the mouse/keyboard will wakeup the computer.</p> <p>The "USB Wakeup function" operates under Windows® 7 operating system and it works for all USB ports.</p>
<b>TOSHIBA PC Health Monitor</b>	The TOSHIBA PC Health Monitor software program monitors computer system functions such as power consumption, the cooling system and HDD Drop sensor. It alerts users of specific system conditions via pop-up messages. It also tracks the usage of the computer and related devices, logging the service relevant information on the computer's hard disk drive. Please refer to the <a href="#">TOSHIBA PC Health Monitor</a> section in Appendix E.
<b>TOSHIBA HDD/SSD Alert</b>	The TOSHIBA HDD/SSD Alert includes wizard functions to monitor the Disk Drive operating status.
<b>HW Setup</b>	This utility allows you to customize your hardware settings according to the way you work with the computer and the peripherals you use.

---



## TOSHIBA Value Added Package

<b>TOSHIBA Flash Cards</b>	<p>The TOSHIBA Flash Cards provide a quick way to modify selected system functions and to launch applications.</p> <ul style="list-style-type: none"> <li>■ Hot key function</li> <li>■ TOSHIBA utility launcher function</li> </ul>
<b>TOSHIBA Zooming Utility</b>	<p>This utility allows you to enlarge or reduce the icon size on the Windows Desktop, or the zoom factor associated with specific supported applications.</p>
<b>TOSHIBA PC Diagnostic Tool</b>	<p>The TOSHIBA PC Diagnostic Tool will display basic system configuration information and allow the functionality of some of the computer's built-in hardware devices to be tested.</p>

## Utilities and Applications

This section describes the pre-installed utilities that come with the computer and details how to start them. For further information on their operation, please refer to each utility's online manual, help files or README.TXT file.

<b>TOSHIBA ConfigFree</b>	<p>TOSHIBA ConfigFree is a suite of utilities that improve the ease and control of communication devices and network connections, help in the identification of communication problems and allow the creation of profiles if you need to switch between different locations and communication networks. To access this utility, click <b>Start → All Programs → TOSHIBA → ConfigFree</b>.</p>
<b>TOSHIBA Disc Creator</b>	<p>You can create CD's and DVD's in a number of formats including audio CD's that can be played on a standard CD player, and data CD's/DVD's which can store copies of the files and folders on your computer's hard disk drive. This software can be used on models with a DVD Super Multi drive.</p> <p>To start this utility, click <b>Start → All Programs → TOSHIBA → CD&amp;DVD Applications → Disc Creator</b>.</p>

<b>TOSHIBA eco Utility</b>	TOSHIBA eco Utility helps you monitor your power savings by showing approximate real time power consumption. Furthermore, it shows approximate accumulated power consumption and approximate accumulated power savings when using eco mode daily, weekly, and monthly. You can track power savings by using eco mode continuously.
<b>Toshiba LifeSpace</b>	<p>Toshiba LifeSpace is a value-added productivity application which gives you a more personalized approach to accessing your files, organizing daily activities, projects and more. Toshiba LifeSpace consists of two applications: Bulletin Board - an easy-to-use organization tool - and ReelTime - a visual timeline representation of your recently used files.</p> <p>To start these applications, click <b>Start → All programs → TOSHIBA → TOSHIBA Bulletin Board</b> or <b>Start → All programs → TOSHIBA → TOSHIBA Reeltime</b>.</p>

## Options

You can add a number of options to make your computer even more powerful and convenient to use. The following options are available:

<b>Memory kit</b>	PC2-5300 (DDR2-667) or compatible 1GB or 2GB memory module can easily be installed in the computer.
<b>Battery Pack</b>	An additional battery pack can be purchased for use as either a spare or replacement. Please refer to Chapter 6, <i>Power and Power-up Modes</i> for further information.
<b>AC Adaptor</b>	If you frequently use your computer at more than one site, it may be convenient to purchase an additional AC adaptor to be kept at each site in order to remove the need to always carry the adaptor with you.
<b>USB FDD</b>	The USB floppy diskette drive accommodates either a 1.44MB or 720KB floppy diskette through connection to one of the computer's USB ports. In use, please be aware that, while you cannot format 720KB floppy diskettes under Windows® 7, you are able to read and write to diskettes that have already been formatted.
<b>USB Optical Disc Drive</b>	The USB Optical Disc Drive can run CD/DVDs.

# Chapter 2

## The Grand Tour

This chapter identifies the various components of your computer. Become familiar with each component before you operate the computer.

### Front with the display closed

The following figure shows the computer's front with its display panel in the closed position.

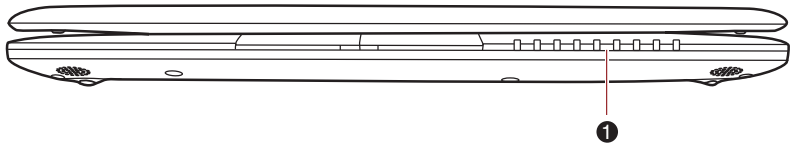

#### 1. System indicators

*Front of the computer with display closed*

### System indicators

The LED system indicators for specific computer operations glow when those operations are in progress.



*System indicators*



#### DC IN

The **DC IN** indicator normally glows green when power is being correctly supplied from the AC power adaptor. However, if the output voltage from the adaptor is abnormal, or if the computer's power supply malfunctions, this indicator will go out.

**Power**

The **Power** indicator normally glows green when the computer is turned on. However, if you turn the computer off into Sleep Mode, this indicator will flash amber - approximately two seconds on, one second off - both while the system is shutting down and while it remains in Sleep Mode.

**Battery**

The **Battery** indicator shows the condition of the battery's charge - green indicates the battery is fully charged, amber indicates the battery is charging, and flashing amber indicates a low battery condition. Please refer to Chapter 6, [Power and Power-up Modes](#) for more information on this feature.

**HDD**

The **HDD** indicator glows green whenever the computer is accessing the built-in hard disk drive.

**Bridge media slot**

The **Bridge media slot** indicator glows green when the computer is accessing the Bridge media slot.

**Wireless communication**

The **Wireless communication** indicator glows amber when the Bluetooth and Wireless LAN functions are turned on. Only some models are equipped with Bluetooth and Wireless LAN functions.

**Wireless WAN communication**

The **Wireless WAN communication** indicator glows or blinks blue when the Wireless WAN function is on. The indicator will glow or blink in order to indicate the connection status of the Wireless WAN function. A Wireless WAN module must be installed to use this function. Some models are equipped with a Wireless WAN module.

**Arrow Lock**

When the Arrow indicator lights green, you can use the dark gray labeled keys on the keypad overlay as cursor keys.

**Numeric Lock**

When the Numeric Lock indicator glows green, you can use the dark gray labelled keys on the keypad overlay for numeric input.

## Left side

The following figure shows the computer's left side.

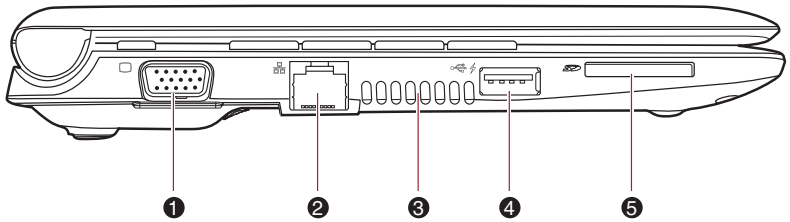

- |                          |                                        |
|--------------------------|----------------------------------------|
| 1. External monitor port | 4. Universal Serial Bus (USB 2.0) port |
| 2. LAN jack              | 5. Bridge media slot                   |
| 3. Thermal vent holes    |                                        |

*The left side of the computer*



**External monitor port** This port allows you to connect an external monitor to the computer.



**LAN jack** This jack lets you connect to a LAN. The adaptor has built-in support for Ethernet LAN (10 megabits per second, 10BASE-T) and Fast Ethernet LAN (100 megabits per second, 100BASE-TX). Refer to Chapter 4, [Operating Basics](#), for details.



- *Do not connect any cable other than a LAN cable to the LAN jack. It could cause damage or malfunction.*
- *Do not connect the LAN cable to a power supply. It could cause damage or malfunction.*

**Thermal vent holes** The thermal vent holes help keep the processor from overheating.



*Do not block the thermal vent holes. Keep foreign metal objects, such as screws, staples and paper clips, out of the cooling vents. Foreign metal objects can create a short circuit, which can cause damage and fire, possibly resulting in serious injury.*



**Universal Serial Bus (USB 2.0) port** The Universal Serial Bus port, which complies with the USB 2.0 standard, is provided on the left hand side of the computer. The port with the icon (⚡) has [USB Sleep and Charge function](#).



Keep foreign metal objects, such as screws, staples and paper clips, out of the USB connectors. Foreign metal objects can create a short circuit, which can cause damage and fire, possibly resulting in serious injury.



Please note that it is not possible to confirm the operation of all functions of all USB devices that are available. In view of this it may be noted that some functions associated with a specific device might not operate properly.



### Bridge media slot

This slot lets you insert an SD™/SDHC™ memory card and MultiMediaCard™. Refer to Chapter 8, *Optional Devices*.



Keep foreign metal objects, such as screws, staples and paper clips, out of the Bridge media slot. Foreign metal objects can create a short circuit, which can cause damage and fire, possibly resulting in serious injury.

## Right side

The following figure shows the computer's right side.

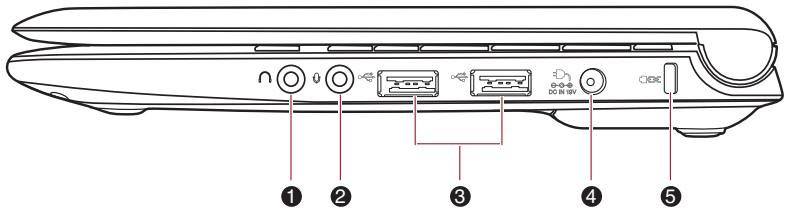

1. Headphone jack
2. Microphone jack
3. Universal Serial Bus (2.0) port
4. DC IN 19V jack
5. Security lock slot

*The right side of the computer*



### Headphone jack

A standard 3.5 mm mini headphone jack enables connection of stereo headphones or other device for audio output. When you connect headphones, the internal speaker is automatically disabled.



### Microphone jack

A standard 3.5 mm mini microphone jack enables connection of a microphone or other device for audio input.



### Universal Serial Bus (USB 2.0) port

Two Universal Serial Bus ports, which comply with the USB 2.0 standard, are provided on the right side of the computer.



### DC IN 19V jack

The AC adaptor connects to this jack in order to power the computer and charge its internal batteries. Please note that you should only use the model of AC adaptor supplied with the computer at the time of purchase - using the wrong AC adaptor can cause damage to the computer.



### Security lock slot

A security cable can be attached to this slot and then connected to a desk or other large object in order to deter theft of the computer.

## Back side

Figure 2-5 shows the computer's back side.

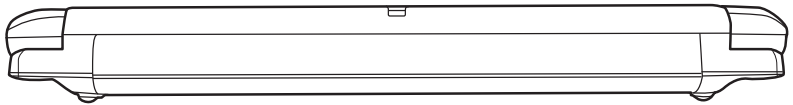

*The computer's back side*

## Underside

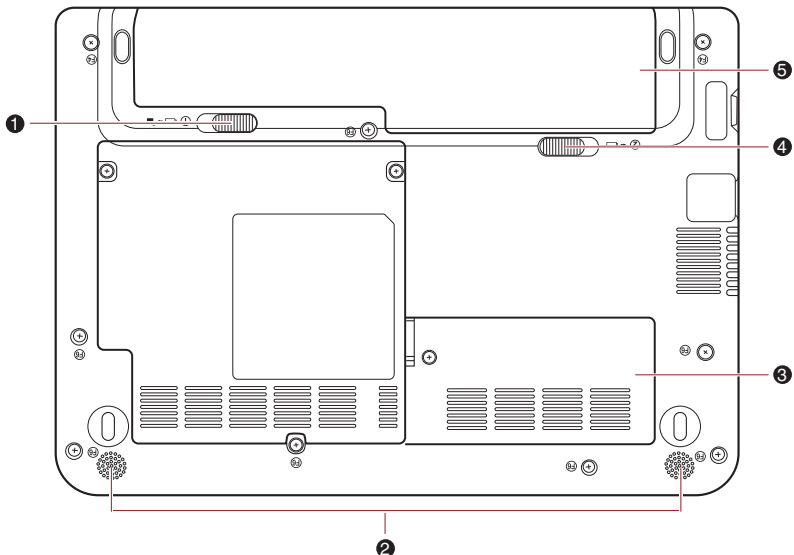

The following figure shows the underside of the computer. You should ensure that the display is closed before the computer is turned over to avoid causing any damage.



- 1. Battery safety lock
- 2. Speaker
- 3. Memory module slot
- 4. Battery release latch
- 5. Battery pack

*The underside of the computer*

---

①		<b>Battery safety lock</b>	Slide this latch into its "Unlock" position in order to release the battery pack ready for removal.
		<b>Speaker</b>	The speaker emits sound generated by your software as well as audio alarms, such as low battery condition, generated by the system.
		<b>Memory module slot</b>	The memory module slot is located here. The memory module slot allows for the replacement with an additional memory module. Please refer to the <a href="#">Additional memory module</a> section in Chapter 8, <a href="#">Optional Devices</a> for more information.
②		<b>Battery release latch</b>	Slide and hold this latch into its 'Unlock' position in order to release the battery pack ready for removal.  For more detailed information on removing the battery pack please refer to Chapter 6, <a href="#">Power and Power-up Modes</a> .
		<b>Battery pack</b>	The battery pack provides power to the computer when the AC adaptor is not connected. For more detailed information on the use and operation of the battery pack please refer to Chapter 6, <a href="#">Power and Power-up Modes</a> .

---



## Front with the display open

This section shows the computer with the display panel open. In order to open the display, lift the display panel up and position it at a comfortable viewing angle for you.

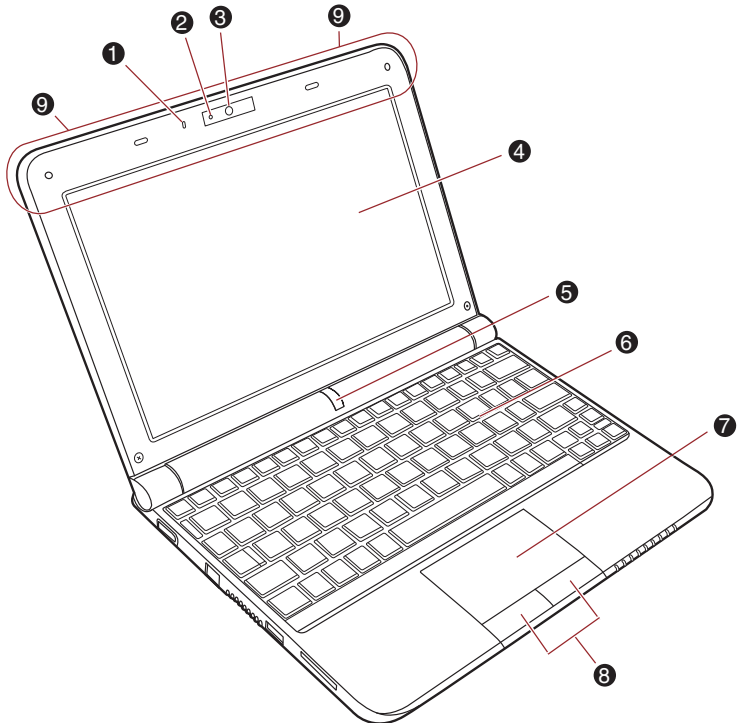

- |                   |                                        |
|-------------------|----------------------------------------|
| 1. Microphone     | 6. Keyboard*                           |
| 2. Web Camera LED | 7. Touch Pad                           |
| 3. Web Camera     | 8. Touch Pad control buttons           |
| 4. Display Screen | 9. Wireless LAN antenna (Not shown)    |
| 5. Power Button   | Wireless WAN antenna (for some models) |
|                   | (Not shown)                            |

\* Appearance of the Keyboard may be different among models.

*The front of the computer with display open*

<b>Microphone</b>	A built-in microphone allows you to import and record sounds for your application - please refer to the <i>Sound system</i> section in Chapter 4, <i>Operating Basics</i> for more information.
<b>Web Camera LED</b>	The Web Camera LED glows blue when the Web Camera is working.
<b>Web Camera</b>	<p><b>Web Camera</b> is a device that allows you to record video or take photographs with your computer. You can use it for video chatting or video conferencing using a communication tool such as <b>Windows Live Messenger</b>. <b>TOSHIBA Web Camera Application</b> will help you to add various video effects to your video or photograph.</p> <p>Enables the transmission of video and use of video chat via the internet using specialized applications.</p> <p>Ensure that you remove the protective plastic film that covers the Web Camera before using it.</p>
<b>Display screen</b>	Please be aware that, when the computer is operating on the AC adaptor, the image displayed on the internal screen will be somewhat brighter than when it operates on battery power. This difference in brightness levels is intended to save power when operating on batteries. For more information on the computer's display, please refer to the <i>Display Controller</i> section in Appendix B.
 <b>Power button</b>	<p>Press this button to turn the computer's power on and off.</p> <p>The power button is disabled while the display panel is closed.</p>
<b>Touch Pad</b>	The Touch Pad mouse control device located in the center of the palm rest is used to control the movement of the on-screen pointer. For more information, please refer to the <i>Using the Touch Pad</i> section in Chapter 4, <i>Operating Basics</i> .
<b>Touch Pad control buttons</b>	The control buttons located below the Touch Pad allow you to select menu items or manipulate text and graphics as designated by the on-screen pointer.

## Keyboard indicators

When the CAPS LOCK indicator glows, the keyboard will produce capitals when any letter is typed.

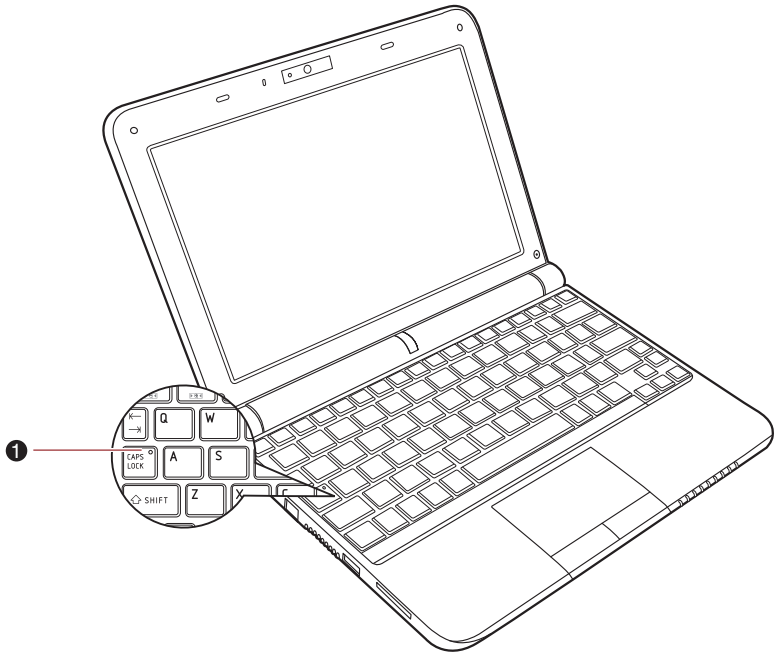

### 1. CAPS LOCK indicator

#### *Keypad indicators*

---

#### **CAPS LOCK**

This indicator glows green when letter keys are locked into their uppercase format.

---

## AC adaptor

The AC adaptor can automatically adjust to any voltage ranging from 100 to 240 volts and to a frequency of either 50 or 60 hertz, enabling you to use this computer in almost any country/region. The adaptor converts AC power to DC power and reduces the voltage supplied to this computer.

To recharge the battery, simply connect the AC adaptor to a power source and to the computer. Please refer to Chapter 6, *Power and Power-up Modes* for further information.

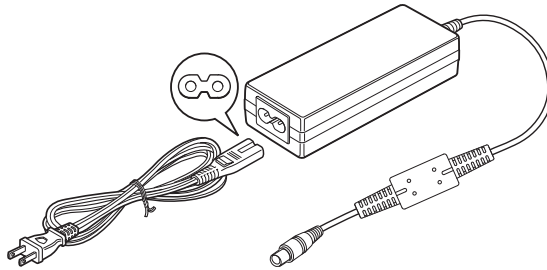

*The AC adaptor (2-pin plug)*

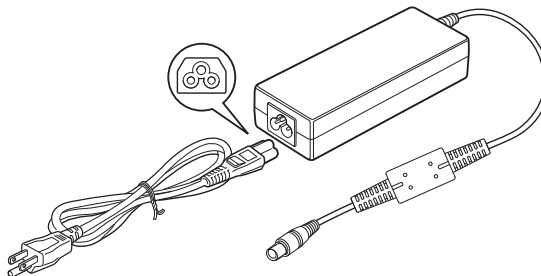

*The AC adaptor (3-pin plug)*



- Depending on the model in question, either a 2-pin or 3-pin adaptor/power lead will be bundled with the computer.
- Do not use a 3-pin to 2-pin conversion plug.
- The supplied power cord conforms to safety rules and regulations in the region the product is bought and should not be used outside of this region. In order to use the adaptor/computer in other regions, you should buy a power cord that conforms to the safety rules and regulations in that particular region.



Always use the TOSHIBA AC adaptor that was included with your computer, or use AC adaptors specified by TOSHIBA to avoid any risk of fire or other damage to the computer. Use of an incompatible AC adaptor could cause fire or damage to the computer possibly resulting in serious injury.

# Chapter 3

## Getting Started

This chapter provides basic information to start using your computer. It covers the following topics:



- *All users should be sure to read the section [Starting up for the first time](#).*
- *Be sure to read the enclosed [Instruction Manual for Safety and Comfort](#) for information on the safe and proper use of this computer. It is intended to help you be more comfortable and productive while using a notebook computer. By following the recommendations in it you may reduce your chance of developing a painful or disabling injury to your hand, arms, shoulders or neck.*
- Connecting the AC adaptor
- Opening the display
- Turning on the power
- Starting up for the first time
- Turning off the power
- Restarting the computer
- System Recovery Options
- Creating Recovery Media
- Restoring the pre-installed software from the Recovery hard disk drive
- Restoring the pre-installed software from your created Recovery Media



- *Use a anti-virus software and make sure it is updated regularly.*
- *Never format storage media without checking its content - formatting destroys all stored data.*
- *It is a good idea to periodically back up the internal hard disk drive or other main storage device to external media. General storage media is not durable or stable over long periods of time and under certain conditions may result in data loss.*
- *Before you install a device or application, save any data in memory to the hard disk drive or other storage media. Failure to do so may result in the loss of data.*

## Connecting the AC adaptor

Attach the AC adaptor when you need to charge the battery or you want to operate from AC power. It is also the fastest way to get started, because the battery pack will need to be charged before you can operate from battery power.

The AC adaptor can be connected to any power source supplying from 100 to 240 volts and 50 or 60 hertz. For details on using the AC adaptor to charge the battery pack, refer to Chapter 6, [Power and Power-up Modes](#).



- *Always use the TOSHIBA AC adaptor that was included with your computer or use AC adaptors specified by TOSHIBA to avoid any risk of fire or other damage to the computer. Use of an incompatible AC adaptor could cause fire or damage to the computer possibly resulting in serious injury. TOSHIBA assumes no liability for any damage caused by use of an incompatible adaptor.*
- *Never plug the AC adaptor into a power source that does not correspond to both the voltage and the frequency specified on the regulatory label of the unit. Failure to do so could result in a fire or electric shock, possibly resulting in serious injury.*
- *Always use or purchase power cables that comply with the legal voltage and frequency specifications and requirements in the country of use. Failure to do so could result in a fire or electric shock, possibly resulting in serious injury.*
- *The supplied power cord conforms to safety rules and regulations in the region the product is bought and should not be used outside this region. For use in other regions, please buy power cords that conform to safety rules and regulations in the particular region.*
- *Do not use a 3-pin to 2-pin conversion plug.*
- *When you connect the AC adaptor to the computer, always follow the steps in the exact order as described in the User's Manual. Connecting the power cable to a live electrical outlet should be the last step otherwise the adaptor DC output plug could hold an electrical charge and cause an electrical shock or minor bodily injury when touched. As a general safety precaution, avoid touching any metal parts.*
- *Never place your computer or AC adaptor on a wooden surface, furniture, or any other surface that could be marred by exposure to heat since the computer base and AC adaptor's surface increase in temperature during normal use.*
- *Always place your computer or AC adaptor on a flat and hard surface that is resistant to heat damage.*

*Refer to the enclosed Instruction Manual for Safety and Comfort for detailed precautions and handling instructions.*

1. Connect the power cord to the AC adaptor.

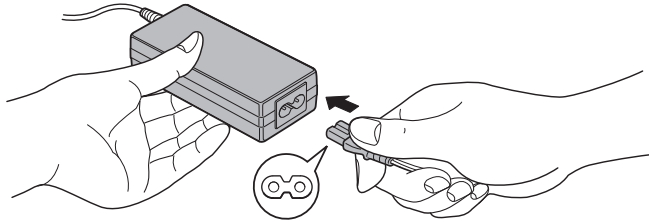

*Connecting the power cord to the AC adaptor (2-pin plug)*

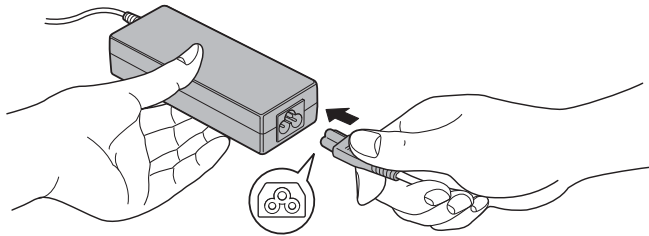

*Connecting the power cord to the AC adaptor (3-pin plug)*



*Either a 2-pin or 3-pin adaptor/cord will be included with the computer depending on the model.*

2. Connect the AC adaptor's DC output plug to the DC IN 19V jack on the right side of the computer.

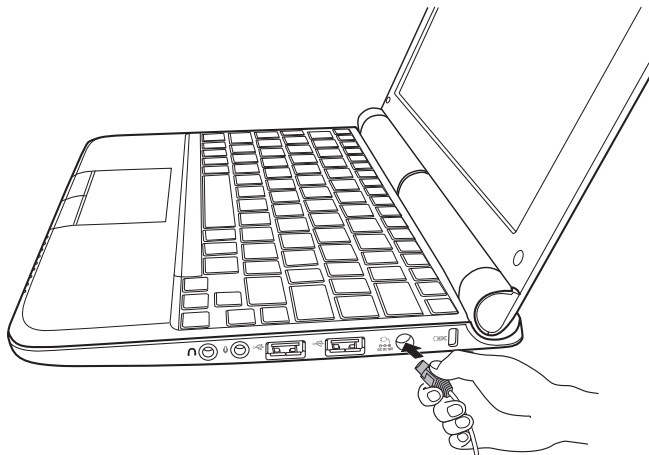

*Connecting the adaptor to the computer*

3. Plug the power cord into a live wall outlet - the **Battery** and **DC IN** indicators on the front of the computer should glow.

## Opening the display

The display panel can be opened to a wide range of angles for optimal viewing. While holding down the palm rest with one hand so that the main body of the computer is not raised, slowly lift the display panel - this will allow the angle of the display panel to be adjusted to provide optimum clarity.

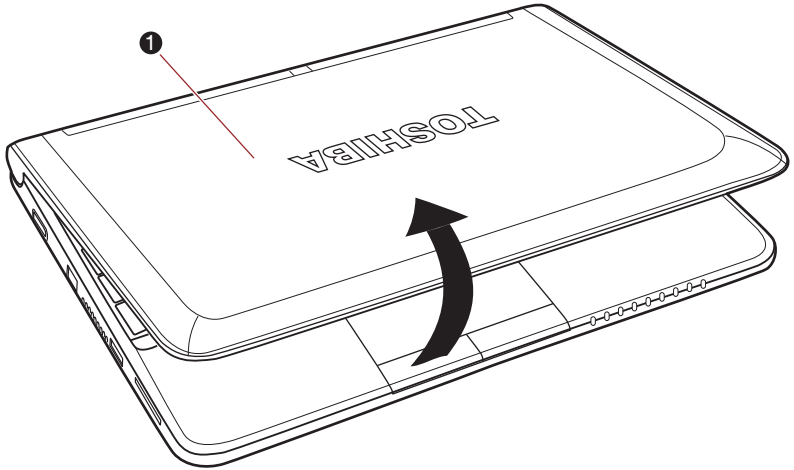

1. Display panel

### *Opening the display*



*Use reasonable care when opening and closing the display panel. Opening it vigorously or slamming it shut could damage the computer.*





- *When opening the panel, please be careful not to force it beyond the point where it moves easily.*
- *Be careful not to open the display panel too far as this could put stress on the display panel's hinges and cause damage.*
- *Do not press or push on the display panel.*
- *Do not lift the computer by the display panel.*
- *Do not close the display panel with pens or any other objects left in between the display panel and the keyboard.*
- *When opening or closing the display panel, place one hand on the palm rest to hold the computer in place and use the other hand to slowly open or close the display panel (Do not use excessive force when opening or closing the display panel).*

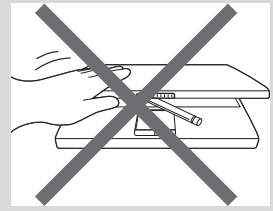
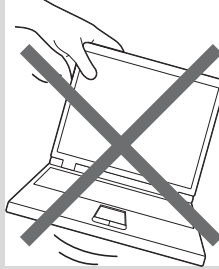
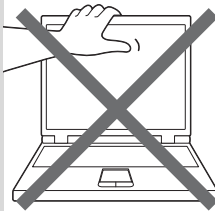

## Turning on the power

This section describes how to turn on the power - the **Power** indicator will then indicate the status. Please refer to the Monitoring of power condition section in Chapter 6, [Power and Power-up Modes](#) for more information.



- *After you turn on the power for the first time, do not turn it off until you have set up the operating system. Please refer to the section [Starting up for the first time](#) for more information.*
- *The power button is disabled while the display panel is closed.*
- *Volume cannot be adjusted during Windows Setup.*

1. Open the computer's display panel.
2. Press the computer's power button.

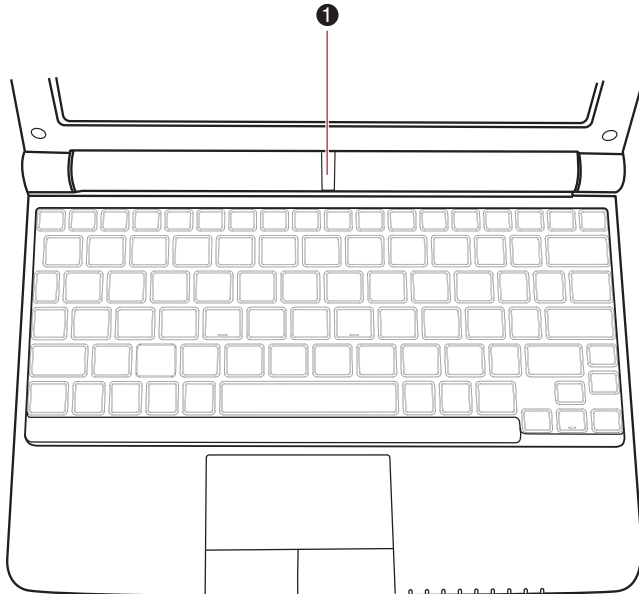

1. Power button

*Turning on the power*

## Starting up for the first time

The Windows® 7 Welcome screen will be the first screen displayed when you turn on the power. Follow the on-screen instructions on each screen in order to properly install the operating system.



*When it is displayed, be sure to read the **Software License Terms** carefully.*

## Turning off the power

The power can be turned off in one of three modes, either Shut Down Mode, Hibernation Mode or Sleep Mode.

### Shut Down Mode

When you turn off the power in Shut Down Mode no data will be saved and the computer will boot to the operating system's main screen the next time it is turned on.

1. If you have entered data, either save it to the hard disk drive or to other storage media.



- *Make sure the **Hard Disk Drive** indicator is off. If you turn off the power while a disk (disc) is being accessed, you may lose data or damage the disk.*
- *Never turn off the power while an application is running. Doing so could cause loss of data.*
- *Never turn off the power, disconnect an external storage device or remove storage media during data read/write. Doing so can cause data loss.*

2. Click Windows Start button, then click the **Shut down** button .
3. Turn off any peripheral devices connected to your computer.



*Do not turn the computer or peripheral devices back on immediately - wait a short period to avoid any potential damage.*

### Hibernation Mode

The Hibernation Mode feature saves the contents of memory to the hard disk drive when the computer is turned off so that, the next time it is turned on, the previous state is restored. Please note that the Hibernation Mode feature does not save the status of any peripheral devices connected to the computer.



- *Save your data. While entering Hibernation Mode, the computer saves the contents of memory to the hard disk drive. However, for safety sake, it is best to save your data manually.*
- *Data will be lost if you remove the battery or disconnect the AC adaptor before the save is completed. Wait for the **Hard Disk Drive** indicator to go out.*
- *Do not install or remove a memory module while the computer is in Hibernation Mode. Data will be lost.*

## Benefits of Hibernation Mode

The Hibernation Mode feature provides the following benefits:

- Saves data to the hard disk drive when the computer automatically shuts down because of a low battery condition.
- You can return to your previous working environment immediately when you turn on the computer.
- Saves power by shutting down the system when the computer receives no input or hardware access for the time period set by the System Hibernate feature.
- Allows the use of the panel power off feature.

## Starting Hibernation Mode



You can also enable Hibernation Mode by pressing **FN + F4** - please refer to Chapter 5, *The Keyboard*, for further details.

To enter Hibernation Mode, follow the steps below.

1. Click Windows Start button.
2. Point to .
3. Select **Hibernate**.

## Automatic Hibernation Mode

The computer can be configured to enter Hibernation Mode automatically. In order to define these settings, you can follow the steps as described below:

1. Open the **Control Panel**.
2. Open **System and Security** and open **Power Options**.
3. Select **Choose what the power button does**.
4. Enable the desired hibernation settings for **When I press the power button** and **When I close the lid**.
5. Click the **Save changes** button.

## Data save in Hibernation Mode

When you turn off the power in Hibernation Mode, the computer will take a moment to save the current data in memory to the hard disk drive. During this time, the **Hard Disk Drive** indicator will glow.

After you turn off the computer, and the content of memory has been saved to the hard disk drive, turn off the power to any peripheral devices.



Do not turn the computer or peripheral devices back on immediately - wait a short period to avoid any potential damage.

## Sleep Mode

In Sleep mode the power remains on, but the processor and all other devices are in Sleep mode.



*Turning Off Your Computer where Electronic Devices are Regulated or Controlled.*

*When you have to turn off your computer aboard an aircraft or in places where electronic devices are regulated or controlled, always shut down the computer completely or put the computer into Hibernation mode instead of allowing it to go into Sleep mode. Also ensure that you disable wireless communication and turn off any wireless communication devices. While in Sleep mode the computer operating system may reactivate itself to run pre-programmed tasks or to preserve unsaved data, and might interfere with aviation or other systems, possibly causing serious injury.*



- *Before entering Sleep Mode, be sure to save your data.*
- *Do not install or remove a memory module while the computer is in Sleep Mode. The computer or the memory module could be damaged.*
- *Do not remove the battery pack while the computer is in Sleep Mode (unless the computer is connected to an AC power source). Data in memory could be lost.*
- *To enable or disable wireless communication, use the Hot Key **FN + F8**. For more information see the [Hot keys](#) section in Chapter 5 .*
- *You can disable Wireless communication in BIOS Setup or HW Setup. After disabling the wireless communication function, confirm the Wireless communication indicator is turned off. If the Wireless communication indicator is turned on, the wireless communication is enabled and radio waves from the computer may affect electronic devices. For details of BIOS Setup and HW Setup, please refer to Chapter 7 .*

### **Benefits of Sleep Mode**

The Sleep Mode feature provides the following benefits:

- Restores the previous working environment more rapidly than does the Hibernation Mode feature.
- Saves power by shutting down the system when the computer receives no input or hardware access for the time period set by the System Sleep Mode feature.
- Allows the use of the panel power off feature.

## Executing Sleep Mode



You can also enable Sleep Mode by pressing **FN + F3** - please refer to Chapter 5, *The Keyboard*, for further details.

You can enter Sleep Mode in one of three ways:

1. Click Windows Start button, point to , and then click **Sleep**.
2. Close the display panel. This feature must be enabled. Refer to the Power Options in the Control Panel.
3. Press the power button. This feature must be enabled. Refer to the Power Options in the Control Panel.

When you turn the power back on, you can continue where you left when you shut down the computer.



- *When the computer is in Sleep Mode, the **Power** indicator will blink amber.*
- *If you are operating the computer on battery power, you can lengthen the overall operating time by turning it off into Hibernation Mode - Sleep Mode will consume more power while the computer is off.*

## Sleep Mode limitations

Sleep Mode will not function under the following conditions:

- Power is turned back on immediately after shutting down.
- Memory circuits are exposed to static electricity or electrical noise.

## Restarting the computer

Certain conditions require that you reset the computer, for example if:

- You change certain computer settings.
- An error occurs and the computer does not respond to your keyboard commands.

If you need to restart the computer, there are following ways this can be achieved:

1. Click **Start** then click the arrow button  and select **Restart** from the menu.
2. Press **CTRL, ALT** and **DEL** simultaneously (once) to display the menu window, then click the arrow button in the lower right corner of the screen, then select **Restart**.
3. Press the power button and hold it down for five seconds. Once the computer has turned itself off, wait between ten and fifteen seconds before turning the power on again by pressing the power button.

## System Recovery Options

A hidden partition is allocated on the hard disk drive for the System Recovery Options.

This partition stores files which can be used to repair the system in the event of a problem.



*The System Recovery Options feature will be unusable if this partition is deleted.*

## System Recovery Options

The System Recovery Options feature is installed on the hard disk when shipped from the factory. The System Recovery Options menu includes tools to repair startup problems, run diagnostics or restore the system.

See the **Windows Help and Support** content for more information about **Startup Repair**.

The System Recovery Options can also be run manually to repair problems.

The procedure is as follows. Follow the instructions shown on the on-screen menu.

1. Turn off the computer.
2. While holding the **F8** key, turn on the computer.
3. The **Advanced Boot Options** menu will be displayed.  
Use the arrow keys to select **Repair Your Computer** and press **ENTER**.
4. Follow the on-screen instructions.



*The Windows® 7 Create a System Image feature can be used on all versions of Windows® 7. However, to save the backup on a network location, the edition has to be either Professional or Ultimate.*

## Creating Recovery Media

This section describes how to create Recovery Media.



- *Be sure to connect the AC adaptor when you create Recovery Media.*
- *Be sure to close all other software programs except the Recovery Media Creator.*
- *Do not run software such as screen savers which can put a heavy load on the CPU.*
- *Operate the computer at full power.*
- *Do not use power-saving features.*
- *Do not write to the media when the anti-virus software is running. Wait for it to finish, then disable virus detection programs including any software that checks files automatically in the background.*
- *Do not use utilities, including those intended to enhance hard disk drive access speed. They may cause unstable operation and damage data.*
- *Do not shut down/log off or Sleep/Hibernate while writing or rewriting the disc.*
- *Set the computer on a level surface and avoid places subjected to vibrations such as airplanes, trains, or cars.*
- *Do not use on unstable tables or other any other unstable surfaces.*
- *You can use DVD media when you connect the external ODD.*

A recovery image of the software on your computer is stored on the hard disk drive, and can be copied to either DVD or USB Flash Memory by using the following steps:

1. Select either blank DVD or USB Flash Memory.
2. The application will allow you to choose from a variety of different media onto which the recovery image can be copied including DVD-R, DVD-R DL, DVD-RW, DVD+R, DVD+R DL, DVD+RW and USB Flash Memory.



- *Please note that some of the above media may not be compatible with the optical disc drive installed into your computer. You should therefore verify the optical disc drive supports the blank media you have chosen before proceeding.*
- *USB Flash Memory will be formatted and all the data in the USB Flash Memory will be lost when proceeding.*

3. Turn on your computer and allow it to load the Windows<sup>®</sup> 7 operating system from the hard disk drive as normal.
4. Insert the media.
  - Insert the first blank DVD into the optical disc drive tray, or
  - Insert the blank USB Flash Memory into one available USB port.
5. Double click the **Recovery Media Creator** icon on the Windows<sup>®</sup> 7 desktop, or select the application from **Start** Menu.
6. After Recovery Media Creator starts, select the type of media and the title you wish to copy, and then click the **Create** button.



## Restoring the pre-installed software from the Recovery hard disk drive

A portion of the total hard disk drive space is configured as a hidden recovery partition. This partition stores files which can be used to restore pre-installed software in the event of a problem.

If you subsequently set up your hard disk drive again, do not change, delete or add partitions in a manner other than specified in the manual, otherwise you may find that space for the required software is not available.

In addition, if you use a third-party partitioning program to reconfigure the partitions on your hard disk drive, you may find that it becomes impossible to setup your computer.



*When the sound mute feature has been activated by pressing the Mute panel (FN + ESC), be sure to disable this to allow sounds to be heard before starting the restore process. Please refer to Chapter 5, [The Keyboard](#), for further details.*

*You can not use System Recovery Options if restoring the pre-installed software without System Recovery Options.*



*When you reinstall the Windows operating system, the hard disk will be reformatted and all data will be lost.*

1. Turn off your computer.
2. While holding down 0 (zero) key on the keyboard, turn on your computer.
3. A menu will be displayed from which you should follow the on-screen instructions.

## Restoring the pre-installed software from your created Recovery Media

If the pre-installed files are damaged, you are able to either use the Recovery Media you have created or the hard disk drive recovery process to restore the computer to the state it was in when you originally received it. To perform this restoration, follow the steps below:



*When the sound mute feature has been activated by pressing the FN + ESC key, be sure to disable this to allow sounds to be heard before starting the restore process. Please refer to Chapter 5, [The Keyboard](#), for further details.*

*You can not use System Recovery Options if restoring the pre-installed software without System Recovery Options.*



*When you reinstall the Windows operating system, the hard disk will be reformatted and all data will be lost.*

1. Load the Recovery Media into the optical disc drive or USB port and turn off the computer's power.
2. While holding down **F12** key on the keyboard, turn on your computer - when **TOSHIBA Leading Innovation>>>** appears, release the **F12** key.
3. Use the up and down cursor keys to select either "optical disc drive" or "USB Flash Memory" from the menu. Please refer to the *Boot Priority* section in Chapter 7, *HW Setup and Passwords* for further information.
4. A menu will be displayed from which you should follow the on-screen instructions.



*When drivers/utilities are installed, you can setup the respective drivers/utilities from the following place.*

*To open the setup files, Click **Start → All Programs → TOSHIBA → Applications and Drivers.***

## Ordering Recovery Discs from TOSHIBA\*

You can order Product Recovery discs for your notebook from the TOSHIBA Europe Backup Media Online Shop.

*\* Please note that this service is not free-of-charge.*

1. Visit <https://backupmedia.toshiba.eu> on the Internet.
2. Follow the on-screen instructions.

You will receive your Recovery Discs within two weeks after placing your order.

# Chapter 4

## Operating Basics

This chapter describes the basic operations of your computer and highlights the precautions that should be taken when using it.

### Using the Touch Pad

To use the Touch Pad, simply touch and move your fingertip across it in the direction you want the on-screen pointer to go.

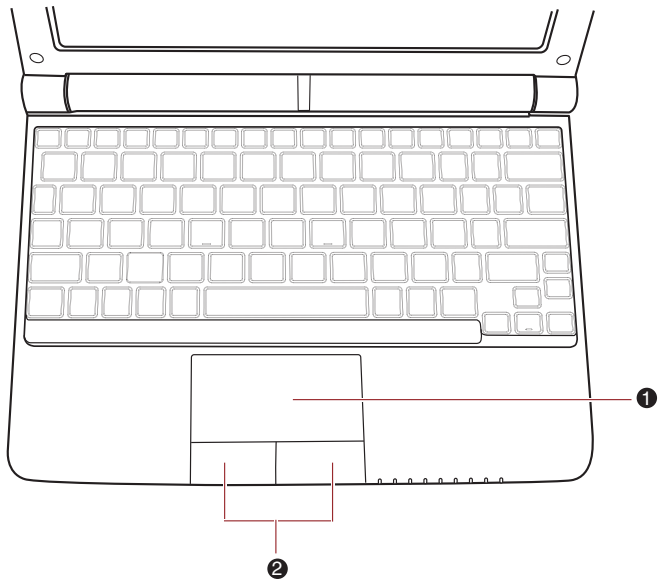

1. Touch Pad

2. Touch Pad control buttons

#### *Touch Pad and Touch Pad control buttons*

The two buttons below the Touch Pad are used like the buttons on a standard mouse - press the left button to select a menu item or to manipulate text or graphics designated by the pointer, and press the right button to display a menu or other function depending on the software you are using.



You can also tap the Touch Pad to perform functions similar to those of the left button on a standard mouse.

**Click:** Tap once

**Double-click:** Tap twice

**Drag and drop:** Tap to select the item(s) you want to move, leave your finger on the Touch Pad after the second tap and then move the item(s) to their new destination.

**Scroll:** Vertical: Move your finger up or down the right edge of the TouchPad.

Horizontal: Move your finger left or right along the bottom edge of the TouchPad.

## USB Sleep and Charge function

Your computer can supply USB bus power (DC5V) to the USB port even when the power of the computer is turned OFF. "Power OFF" includes Sleep mode, hibernation mode or shutdown state.

This function can only be used for ports that support the USB Sleep and Charge function (hereinafter called "compatible ports").

Compatible ports are USB ports that have the (⚡) symbol icon.

You can use the USB Sleep and Charge function to charge certain USB compatible external devices such as mobile phones or portable digital music players.

However, the USB Sleep and Charge function may not work with certain external devices even if they are compliant with the USB specification. In those cases, turn the power of the computer ON to charge the device.



- *The USB Sleep and Charge function only works for compatible ports. This function is disabled in the default setting.*
- *When USB Sleep and Charge function is set to [Enabled], USB bus power (DC5V) will be supplied to compatible ports even when the power of the computer is turned OFF. USB bus power (DC5V) is similarly supplied to the external devices which are connected to the compatible ports. However, some external devices cannot be charged solely by supplying USB bus power (DC5V). As for the specifications of the external devices, please contact the device manufacturer or check the specifications of the external devices thoroughly before use.*
- *Using the USB sleep and charge function to charge external devices will take longer than charging the devices with their own chargers.*
- *If USB Sleep and Charge function is enabled, the computer's battery will discharge during hibernation or when the computer is turned off. It is recommended that you connect the AC adaptor to the computer when enabling the USB Sleep and Charge function.*
- *External devices connected to the USB bus power (DC5V) function that interfaces with the power ON/OFF of the computer may always be in an operational state.*
- *When there is a current overflow of the external devices connected to the compatible ports, USB bus power (DC5V) supply may be stopped for safety reasons.*



*Metal paper clips or hair pins/clips will generate heat if they come into contact with USB ports. Do not allow USB ports to come into contact with metal products, for example when carrying the computer in your bag.*

## Starting the USB Sleep and Charge Utility

To start the utility, click **Start** → **All Programs** → **TOSHIBA** → **Utilities** → **USB Sleep and Charge**.

You can set Typical Mode/Alternate Mode/Disable USB sleep and charge function also in BIOS Setup menu. Please refer to [Accessing HW Setup](#) in Chapter 7 for how to start BIOS Setup Menu.

## Enabling USB Sleep and Charge

This utility can be used to enable and disable the USB Sleep and Charge function.

Check the "USB Sleep and Charge" check box. In the default state this function is disabled.

## Power supply mode settings

Your PC has multiple charging modes so that many different USB devices can be supported for USB Sleep and Charge function. Typical Mode (Default) is suitable for a wide range of digital audio players.

However, determining which mode is suitable for your USB device is unknown without trying. Try each mode, using the following procedure, from Typical Mode to Alternate Mode(\*1) to find the suitable mode for your USB device to charge.

This function may not be able to be used with some connected external devices even if the appropriate mode is selected. In this situation, clear the "USB Sleep and Charge" check box and stop using this function.

\*1. Some computers may not support all modes.

## Battery Settings

This utility can be used to specify the lower limit of remaining battery life for USB Sleep and Charge. Move the slider bar to specify the lower limit. If the remaining battery life falls below the setting, the "USB Sleep and Charge function" will be stopped. Unchecking the "Enable under Battery Mode" check box sets the utility to only charge when the AC adaptor is connected.

## TOSHIBA Disc Creator



*You can use TOSHIBA Disc Creator when you connect External ODD.*

Please be aware of the following limitations when you use the TOSHIBA Disc Creator:

- DVD Video cannot be created using TOSHIBA Disc Creator.
- DVD Audio cannot be created using TOSHIBA Disc Creator.
- You cannot use TOSHIBA Disc Creator's 'Audio CD for Car or Home CD Player' function to record music to DVD-R, DVD-R (Dual Layer), DVD-RW, DVD+R, DVD+R (Double Layer) or DVD+RW media.
- Do not use the 'Disc Backup' function of TOSHIBA Disc Creator in order to copy DVD Video or DVD-ROM material that has copyright protection.
- DVD-RAM discs cannot be backed up using the 'Disc Backup' function of TOSHIBA Disc Creator.
- You cannot back up CD-ROM, CD-R or CD-RW media to DVD-R, DVD-R (Dual Layer) or DVD-RW media using the 'Disc Backup' function of TOSHIBA Disc Creator.
- You cannot back up CD-ROM, CD-R or CD-RW media to DVD+R, DVD+R (Double Layer) or DVD+RW media using the 'Disc Backup' function of TOSHIBA Disc Creator.
- You cannot back up DVD-ROM, DVD Video, DVD-R, DVD-R (Dual Layer), DVD-RW, DVD+R, DVD+R (Double Layer) or DVD+RW to CD-R or CD-RW media using the 'Disc Backup' function of TOSHIBA Disc Creator.
- TOSHIBA Disc Creator cannot record in packet format.

- You might not be able to use the 'Disc Backup' function of TOSHIBA Disc Creator to back up a DVD-R, DVD-R (Dual Layer), DVD-RW, DVD+R, DVD+R (Double Layer) or DVD+RW disc that was made with other software on a different optical media recorder.
- If you add data to a DVD-R, DVD-R (Dual Layer), DVD+R or DVD+R (Double Layer) disc that you have already recorded to, you might not be able to read the added data under some circumstances. For example, it cannot be read under 16-bit operating systems, such as Windows 98SE and Windows Me, while in Windows NT4 you will need Service Pack 6 or later, and in Windows 2000, you will need Service Pack 2. In addition to this, some DVD-ROM and DVD-ROM / CD-R/RW drives cannot read this added data regardless of the operating system.
- TOSHIBA Disc Creator does not support recording to DVD-RAM discs - to achieve this you should use Windows Explorer or another similar utility.
- When you back up a DVD disc, be sure that the source drive supports recording to DVD-R, DVD-R (Dual Layer), DVD-RW, DVD+R, DVD+R (Double Layer) or DVD+RW media - if this is not the case then the source disc might not be backed up correctly.
- When you back up a DVD-R, DVD-R (Dual Layer), DVD-RW, DVD+R, DVD+R (Double Layer) or DVD+RW disc, be sure to use the same type of disc.
- You cannot partially delete any data written to a CD-RW, DVD-RW or DVD+RW disc.

## Data Verification

To verify that data has been written or rewritten correctly to a data CD/DVD you should follow the steps below before you begin the write/rewrite process:

1. Display the setting dialog box by one of the following two steps:
  - Click the settings button (  ) for writing on the main toolbar in the **Data Disc** mode.
  - Select **Setting for Each Mode Data Disc** in the **Setting** menu.
2. Mark the **Verify Written Data** check box.
3. Select **File Open** or **Full Compare** mode.
4. Click the **OK** button.

## How to learn more about TOSHIBA Disc Creator

Please refer to the Help files for additional TOSHIBA Disc Creator information.

- Opening the TOSHIBA Disc Creator Manual  
**Start → All Programs → TOSHIBA → CD&DVD Applications → Disc Creator Help**

## Using the web camera

Built-in web camera is provided with some models. This section describes the bundled webcam utility, which can capture still and video images. The web camera will auto-run when Windows starts.



*Ensure that you remove the protective plastic film that covers the Web Camera before using it.*

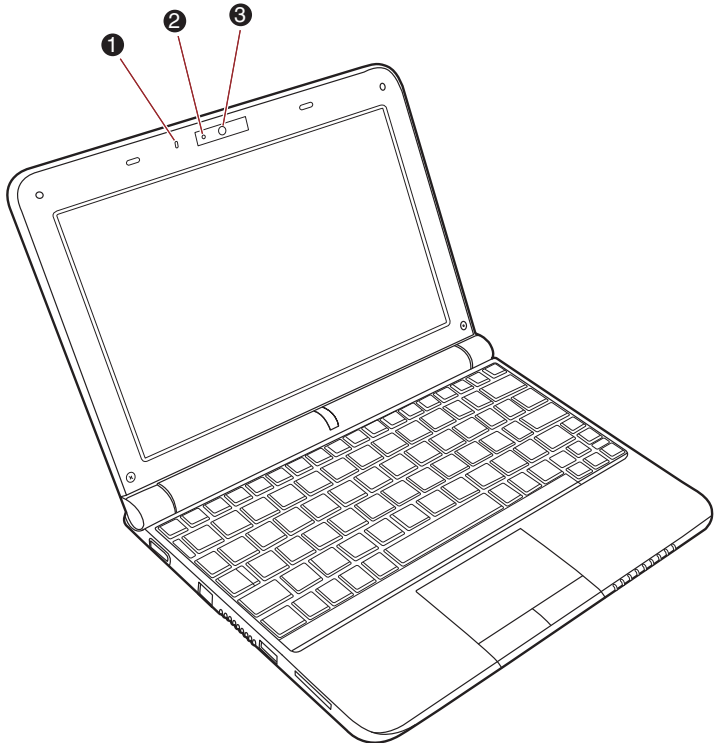

1. Microphone

2. Web Camera LED

3. Web Camera

*Web Camera*



## Using TOSHIBA Web Camera Application

TOSHIBA Web Camera Application is pre-configured to start when you turn on Windows<sup>®</sup> 7; if you need to restart it go to **Start** → **All Programs** → **TOSHIBA** → **Utilities** → **Web Camera Application**.

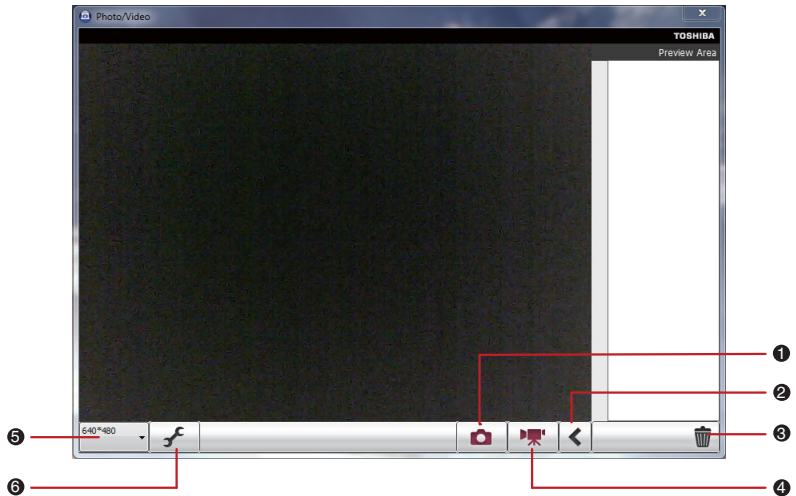

- |                            |                      |
|----------------------------|----------------------|
| 1. Capture Still Images    | 4. Video Recording   |
| 2. Open/Close Preview Area | 5. Camera Resolution |
| 3. Delete Recorded File    | 6. Capture Settings  |

### *Using the Software*

<b>Capture Still Image</b>	Click to capture a still image, and see a preview of the captured image in preview area.
<b>Open/Close Preview Area</b>	Click to open Preview Area. One more to close Preview Area.
<b>Delete Recorded File</b>	Choose a thumbnail of recorded file and click this button to delete this file from hard disk.
<b>Video Recording</b>	Click to start recording. One more to stop recording and see preview of the video in preview area.
<b>Camera Resolution</b>	Choose resolution for Preview, Capture and Record.
<b>Capture Settings</b>	Open Capture Settings dialog box. Chooses from the <b>Basic</b> tab to select photo and video saving location, select Capture Format and Video Quality.

## Using the microphone

You can use the built-in or an external microphone that connects to the microphone jack to record sounds into your applications. It can also be used to issue voice commands to applications that support such functions. Since your computer has a microphone and speaker, "feedback" may be heard under certain conditions. Feedback occurs when sound from the speaker is picked up in the microphone and amplified back to the speaker, which amplifies it again to the microphone.

This feedback occurs repeatedly and causes a very loud, high-pitched noise. It is a common phenomenon that occurs in any sound system when the microphone input is output to the speaker (throughput) and the speaker volume is too loud or too close to the microphone. You can control throughput by adjusting the volume of your speaker or through the Mute function in the Master Volume panel. Refer to your Windows documentation for details on using the Master Volume panel.

## Wireless communications

The computer's wireless communication function supports both Wireless LAN and Bluetooth devices.

### Wireless LAN

The Wireless LAN is compatible with other LAN systems based on Direct Sequence Spread Spectrum/Orthogonal Frequency Division Multiplexing radio technology that complies with the IEEE802.11 Wireless LAN standard.

- Frequency Channel Selection of 2.4GHz for 802.11b,g and n
- Roaming over multiple channels
- Card power management
- Wired Equivalent Privacy (WEP) data encryption based on an 128-bit encryption algorithm
- Wi-Fi Protected Access™ (WPA™) support
- Advanced Encryption Standard (AES) data encryption



- *The transmission speed over the wireless LAN, and the distance over which the wireless LAN can reach, may vary depending on surrounding electromagnetic environment, obstacles, access point design and configuration, client design and software/hardware configurations. The transmission rate described is the theoretical maximum speed as specified under the appropriate standard - the actual transmission speed will be lower than the theoretical maximum speed.*
- *To enable or disable wireless communication, use the Hot Key **FN+F8**. For more information see the [Hot keys](#) section in Chapter 5.*

## Security

- TOSHIBA strongly recommend that you enable encryption functionality, otherwise your computer will be open to illegal access by an outsider using a wireless connection. If this occurs, the outsider may illegally access your system, eavesdrop, or cause the loss or destruction of stored data.
- TOSHIBA is not liable for the loss of data due to eavesdropping or illegal access through the wireless LAN and the damage thereof.

## Bluetooth wireless technology

Bluetooth™ wireless technology eliminates the need for cables between your PC and other electronic devices, for example, printers and mobile phones.

You cannot use the computer's built-in Bluetooth functions and an external Bluetooth adaptor simultaneously.

For reference, Bluetooth wireless technology has the following features:

### *Worldwide operation*

The Bluetooth radio transmitter and receiver operate in the 2.4GHz band, which is license-free and compatible with radio systems in most countries in the world.

### *Radio links*

You can easily establish links between two or more devices, with these links being maintained even if the devices are not within a line-of-sight of each other.

### *Security*

Two advanced security mechanisms ensure a high level of security:

- Authentication prevents access to critical data and makes it impossible to falsify the origin of a message.
- Encryption prevents eavesdropping and maintains link privacy.

## Enable/Disable Wireless communication with hot key

You can enable or disable Wireless communication (Wireless LAN, Bluetooth) functions, with hot keys (**FN + F8**). No transmissions are sent or received when wireless communication is turned off.

- *Do not use the Wireless LAN (Wi-Fi) or Bluetooth functionalities near a microwave oven or in areas subject to radio interference or magnetic fields. Interference from a microwave oven or other source can disrupt Wireless LAN or Bluetooth operation.*
- *Turn Wireless LAN and Bluetooth functionalities off when near a person who may have a cardiac pacemaker implant or other medical electric device. Radio waves may affect pacemaker or medical device operation, possibly resulting in serious injury. Follow the instruction of your medical device when using any Wireless LAN or Bluetooth functionality.*
- *Always turn off Wireless LAN or Bluetooth functionality if the computer is near automatic control equipment or appliances such as automatic doors or fire detectors. Radio waves can cause malfunction of such equipment, possibly resulting in serious injury.*
- *It may not be possible to make a network connection to a specified network name using the ad hoc network function. If this occurs, the new network (\*) will have to be configured for all computers connected to the same network in order to re-enable network connections.  
\* Please be sure to use new network name.*

## Wireless communication indicator

The wireless communication indicator shows the status of the computer's wireless communication functions.

Indicator status	Indication
Indicator off	The wireless communication is set to off - no wireless functionality is available.
Indicator glows	Wireless communication is set to on. Wireless LAN or Bluetooth is turned on by an application.

If you used the Task Bar to disable Wireless LAN functionality, restart the computer or follow the procedures below to enable the system to recognize Wireless LAN. Click **Start** → **Control Panel** → **System and Security** → **System** → **Device Manager** → **Network adaptors** and right click the wireless device then choose Enable.

# Wireless WAN Guide

## Introduction

Depending on the model you purchased your TOSHIBA Notebook come with an installed Wireless WAN (wide area network) device. This device gives you the ability for a high-speed connection to the Internet, corporate intranet, and your email while you are away from the office. This section provides the information you need to get started and use your TOSHIBA Wireless WAN module.

## Safety Precautions

Please read the Instruction Manual for Safety and Comfort enclosed to the User's manual. It contains important safety information.

## Using your PC aboard an aircraft



*Present aviation agency regulations and airline policies typically require that you turn off your computer, disable Wireless communication in BIOS setup, and turn off any wireless devices, before boarding an aircraft.*

- *While it is foreseeable that during certain non-critical phases of your flight, certain computer and/or wireless technologies might be permitted for use on board an aircraft, use of wireless WAN communication is normally prohibited. Since this computer is equipped with the wireless WAN feature, please be sure to disable Wireless communication in BIOS setup even if use of wireless LAN and/or Bluetooth™ is permitted. For this computer model, Wireless communication in BIOS setup controls all wireless communications and wireless LAN and/or Bluetooth™ cannot be selectively turned on without also turning on wireless WAN. If the Wireless communication is enabled in BIOS setup, wireless WAN radio waves may be transmitted.*
- *Unapproved use of computer and/or wireless communication might interfere with navigation and aircraft communication systems, possibly causing serious injury.*

## Limitation of Liability

While Toshiba has made every effort at the time of publication to ensure the accuracy of the information herein, product specifications, configurations, system component/options availability are all subject to change without notice.

## Installing a SIM Card

1. Shut down the computer - make sure the Power indicator is off.
2. Remove the AC adaptor and all cables connected to the computer.



*Always make sure the display panel is closed before turning the computer upside down.*

3. Turn the computer upside down.
4. Slide the battery safety lock (1) towards the release (  ) position to make the battery release latch movable.

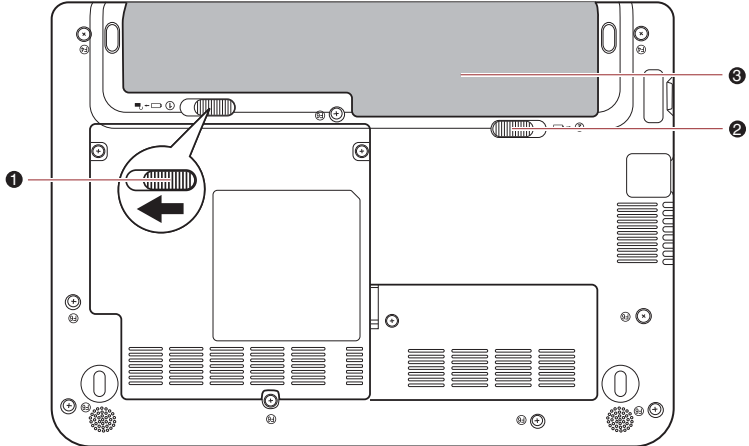

1. Battery safety lock
2. Battery release latch

3. Battery pack

#### *Releasing the battery pack*

5. Slide and hold the battery release latch (1) to disengage the battery pack and then remove it from the computer (2).
6. Locate the SIM Card Slot.

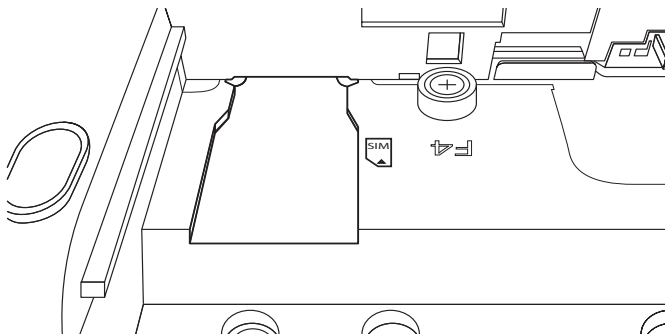

- Slide your SIM card into the SIM Card Slot with the metal connectors facing up.

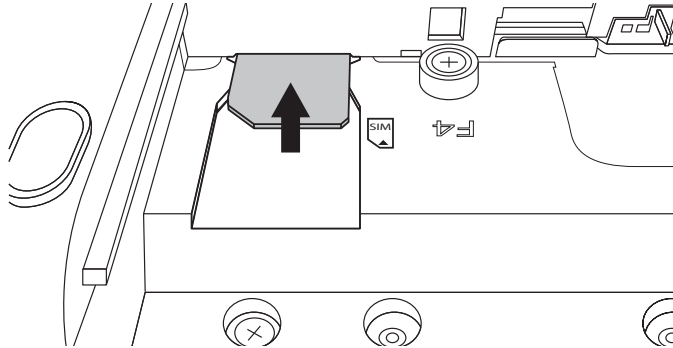

- **Never allow metal objects, such as screws, staples and paper clips, to enter the PC. Foreign metal objects can create a short circuit, which can cause PC damage and fire, possibly resulting in serious injury.**
- **Do not touch the connectors on the SIM card or on the computer. Debris on the connectors may cause access problems.**

- Insert the battery pack as far as it will go into the computer (1).
- Ensure that the battery pack is securely in place and the battery safety lock (2) is in its lock position.

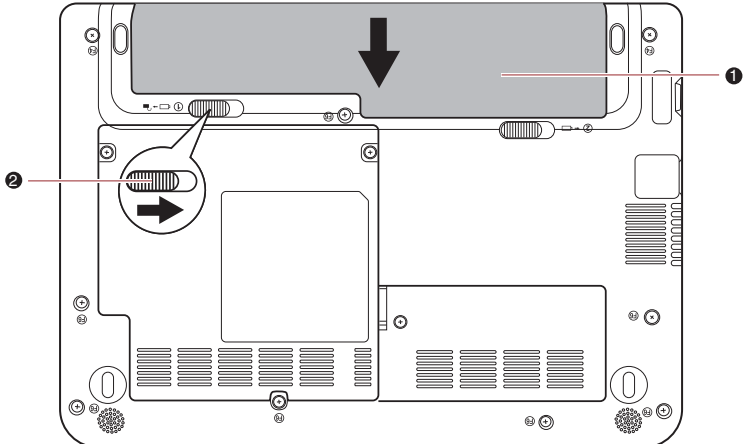

1. Battery Pack

2. Battery safety lock

*Securing the battery pack*

- Turn your computer over.

## Disabling or enabling wireless devices

**Fn + F8:** This hot key enables/disables the wireless devices installed in your computer.

The wireless modes are:

- Enable all Devices: Enables the Wi-Fi, Bluetooth® and 3G modules.
- Disable all Devices: Disables the Wi-Fi, Bluetooth® and 3G modules.
- Enable or Disable Wi-Fi: Enables or disables just the Wi-Fi module.
- Enable or Disable Bluetooth®: Enables or disables just the Bluetooth® module.
- Enable or Disable Wireless WAN: Enables or disables just the Wireless WAN module.



## Regulatory Information

FCC compliance does not apply to this product with a Wireless WAN Module installed.

Industry Canada (IC) compliance does not apply to this product with a Wireless WAN Module installed.



## LAN

The computer has built-in support for Ethernet LAN (10 megabits per second, 10BASE-T) and Fast Ethernet LAN (100 megabits per second, 100BASE-TX). This section describes how to connect/disconnect to a LAN.



*Do not install or remove a memory module while Wake-up on LAN is enabled.*



- *The Wake-up on LAN function consumes power even when the system is off. Leave the AC adaptor connected while using this feature.*
- *The Link speed (10/100 megabits per second) changes automatically depending on the network conditions (connected device, cable or noise and so on).*

### LAN cable types



*The computer must be configured properly before connecting to a LAN. Logging onto a LAN using the computer's default settings could cause a malfunction in LAN operation. Check with your LAN administrator regarding set-up procedures.*

If you are using Fast Ethernet LAN (100 megabits per second, 100BASE-TX), be sure to connect with a CAT5 cable or higher. You cannot use a CAT3 cable.

If you are using Ethernet LAN (10 megabits per second, 10BASE-T), you can connect with a CAT3 or higher cable.

### Connecting the LAN cable

To connect the LAN cable, follow the steps as detailed below:



- *Connect the AC adaptor before connecting the LAN cable. The AC adaptor must remain connected during LAN use. If you disconnect the AC Adaptor while the computer is accessing a LAN, the system may hang.*
- *Do not connect any other cable to the LAN jack except the LAN cable otherwise malfunctions or damage may occur.*
- *Do not connect any power supplying device to the LAN cable that is connected to the LAN jack otherwise malfunctions or damage may occur.*

1. Turn off the power to the computer and to all external devices connected to the computer.
2. Plug one end of the cable into the LAN jack. Press gently until you hear the latch click into place.

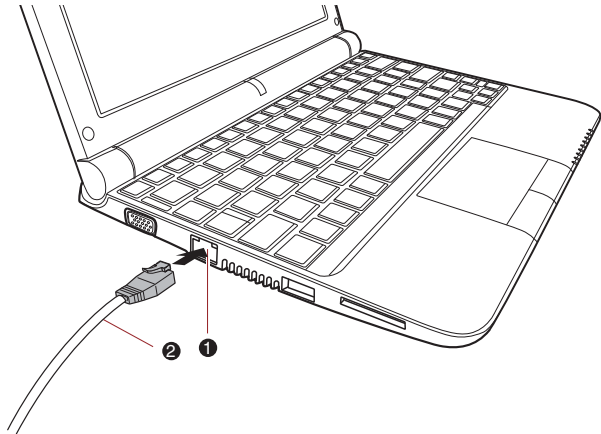

1. LAN jack

2. LAN cable

#### *Connecting the LAN cable*

3. Plug the other end of the cable into a LAN hub connector or router. Check with your LAN administrator and hardware or software vendor before using or configuring a network connection.

### **Disconnecting the LAN cable**

To disconnect the LAN cable, follow the steps as detailed below:

1. Pinch the lever on the connector in the computer's LAN jack and pull out the connector.
2. Disconnect the cable from the LAN hub or router in the same manner. Check with your LAN administrator and hardware or software vendor before disconnecting from the hub.

### **Cleaning the computer**

To help ensure long, trouble-free operation, keep the computer free of dust and dirt, and use care with all liquids around it.

- Be careful not to spill liquids into the computer. If the computer does get wet, turn the power off immediately and let the computer dry completely - in these circumstance you should get the computer inspected by an authorized service provider in order to assess the scope of any damage.
- Clean the plastics of the computer using a slightly water dampened cloth.
- You can clean the display screen by spraying a small amount of glass cleaner onto a soft, clean cloth and then wiping the screen gently with the cloth.

## Using the cleaning cloth

The cleaning cloth can be used to wipe away dust and fingerprints from the keyboard and palm rest area of your computer.



- *When wiping the keyboard, palm rest and display panel, do so gently without using excessive pressure.*
- *Do not use the cleaning cloth when it is dirty or wet.*
- *Do not use the cleaning cloth soaked with water, detergents or volatile organic solvents.*

*It is recommended that you wash the cloth if it gets soiled using a gentle, mild detergent and rinse it well. Allow it to air dry completely before using it again on your computer.*



*Never spray cleaner directly onto the computer or let liquid run into any part of it. Never use harsh or caustic chemical products to clean the computer.*

## Moving the computer

While the computer is designed for flexible day to day usage you should exercise a few simple precautions when moving it in order to help ensure trouble-free operation.

- Make sure all disk activity has ended before moving the computer - check that the HDD and other indicators on the front of the computer are off.
- Turn off (shut down) the computer.
- Disconnect the AC adaptor and all peripherals before moving the computer.
- Close the display panel.
- Do not pick up the computer by its display panel.
- Before carrying your computer, shut it down, disconnect the AC adaptor and allow it to cool down - a failure to follow this instruction may result in minor heat injury.
- Be careful not to subject the computer to impact or shock - a failure to follow this instruction could result in damage to the computer, computer failure or loss of data.
- Always use a suitable carry case when transporting the computer.
- When carrying your computer, be sure to hold it securely so that it does not fall or hit anything.
- Do not carry your computer by holding any of its protruding elements.

## Heat dispersal

To protect from overheating, the processor has an internal temperature sensor. If the computer's internal temperature rises to a certain level, the cooling fan is turned on or the processing speed is lowered. You can select whether to control the processor temperature by turning on the fan first, then if necessary, lowering the processor speed. Or, by lowering the processor speed first, then if necessary, turning on the fan. These functions are controlled within the Power Options.

When the processor temperature falls to a normal range, the fan is turned off and the processor operation returns to standard speed.



*If the processor temperature reaches an unacceptably high level with either setting, the system automatically shuts down to prevent damage. Data in memory will be lost.*

## Using the Hard Disk Drive (HDD) Protection

The hard disk drive models have a function for reducing the risk of damage on the hard disk drive.

Using an acceleration sensor built into the computer, TOSHIBA HDD Protection detects vibration, falls, shocks and similar signs of movement of the computer, and automatically moves the Hard Disk Drive head to a safe position to reduce the risk of damage that could be caused by head-to-disk contact.



*The TOSHIBA HDD Protection function does not guarantee that the hard disk drive will not be damaged.*

When vibration is detected, a message will be displayed on the screen, and the icon in the Taskbar notification area will be changed to the protection state. This message is displayed until the **OK** button is pressed or 30 seconds pass. When vibration subsides, the icon returns to the normal state.

### Taskbar icon

State	Icon	Description
Normal		TOSHIBA HDD Protection is enabled.
Protection		TOSHIBA HDD Protection is active. The hard disk drive head is in a safe position.
OFF		TOSHIBA HDD Protection is disabled.

## TOSHIBA HDD Protection Properties

You can change the TOSHIBA HDD Protection settings by using the TOSHIBA HDD Protection window. To open the window, click **Start → All Programs → TOSHIBA → Utilities → HDD Protection Settings**. The window can also be started from the icon on the Taskbar or from the **Control Panel**.

### HDD Protection

You can choose whether to enable or disable TOSHIBA HDD Protection.

### Detection Level

This function can be set to four levels. The sensitivity levels in which vibrations, impacts and their similar signs are detected can be set to OFF, 1, 2 and 3 in ascending order. Level 3 is recommended for better protection of the computer. However, when the computer is used in a mobile environment or in other unstable conditions, setting the detection level to 3 could result in frequent execution of TOSHIBA HDD Protection, which will slow Hard Disk Drive reading and writing. Set a lower detection level when the speed of Hard Disk Drive reading and writing is a priority.

Different detection levels can be set depending on whether the computer is used as handheld or mobile usages, or whether it is used in a stable environment such as on a table in the workplace or at home. By setting different detection levels for the computer depending on whether it runs with the AC power (desktop) or with batteries (handheld or mobile usage), the detection level automatically switches according to the power connection mode.

### 3D Viewer

This feature displays a 3D object on the screen which moves in according to tilting or vibration of the computer.

When the TOSHIBA HDD Protection detects computer vibration the Hard Disk Drive head is parked and the 3D object disk rotation will stop. When the head is un-parked the disk will begin to rotate again.

The **3D Viewer** can be started from the icon in the task tray.



- *This 3D object virtually represents the Computer's internal Hard Disk Drive. This representation may vary from the actual number of disks, disk rotation, head movement, part size, shape and direction.*
- *This feature may use a large amount of CPU and memory on some models. The computer may become slow or sluggish when attempting to run other applications while the 3D Viewer is displayed.*
- *Intensely shaking the computer or other subjecting it to strong impacts may cause damage to the computer.*

## Details

To open the Details window, click the **Setup Detail** button in the TOSHIBA HDD Protection Properties window.

### ***Detection Level Amplification***

When the AC adaptor is disconnected or the lid is closed, HDD Detection assumes that the computer will be carried and sets the detection level to the maximum for 10 seconds.

### ***TOSHIBA HDD Protection Message***

Specify whether to display a message when TOSHIBA HDD Protection is active.



*This function does not work when the computer starts up, in Sleep Mode, in hibernation mode, in transition to hibernation mode, recovering from hibernation mode, or power off. Be sure to not subject the computer to vibration or impact while the function is disabled.*

# Chapter 5

## The Keyboard

The computer's keyboard layouts are compatible with a 104/105-key enhanced keyboard - by pressing some keys in combination, all of the 104/105-key enhanced keyboard functions can be performed on the computer.

The number of keys available on your keyboard will depend on which country/region your computer is configured for, with keyboards being available for numerous languages.

In use there are six different types of keys, specifically typewriter keys, function keys, soft keys, Hot keys, Windows special keys and the keypad overlay.

### Typewriter keys

The typewriter keys produce the upper-case and lower-case letters, numbers, punctuation marks, and special symbols that appear on the screen. However, there are some differences between using a typewriter and using a computer keyboard:

- Letters and numbers produced in computer text vary in width. Spaces, which are created by a 'space character' may also vary depending on line justification and other factors.
- The lowercase l (el) and the number 1 (one), together with the uppercase O (oh) and the 0 (zero), are not interchangeable on computers as they are on a typewriter.
- The **CAPS LOCK** function key locks only the alphabetic characters into upper-case while the Shift Lock function on a typewriter places all keys in the shifted position.
- The **SHIFT** keys, the **Tab** key, and the **BACK SPACE** key perform the same function as their typewriter counterparts but also have special computer functions.



*Never remove the key caps on your keyboard. Doing so could cause damage to the parts under the key caps.*

## Function keys: F1 ... F12

The function keys (not to be confused with the special **FN** key) are the twelve keys at the top of your keyboard - these keys function differently from other keys.



**F1** through **F12** are called function keys because they execute programmed functions when pressed and, when used in combination with the **FN** key, those keys marked with icons also execute specific functions on the computer. Please refer to the section, *Soft keys: FN key combinations*, in this chapter for further information, taking care to note that the function executed by individual keys will depend on the software you are using.

## Soft keys: FN key combinations

The **FN** (function) is unique to TOSHIBA computers and is used in combination with other keys to form soft keys. Soft keys are key combinations that enable, disable or configure specific features.



*Please note that some software may disable or interfere with soft-key operations, and that the soft-key settings are not restored when the computer returns from Sleep Mode.*

## Emulating keys on an enhanced keyboard

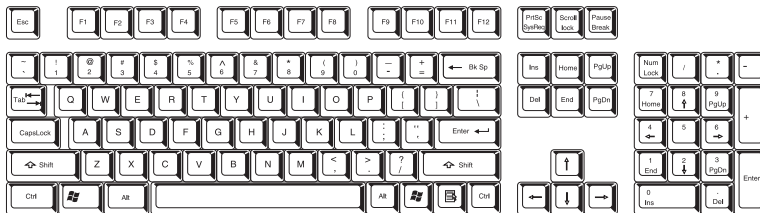

*A 104-key enhanced keyboard layout*

This computer's keyboard is designed to provide all the features of the 104-key enhanced keyboard.

Since the keyboard is smaller and has fewer keys, some of the enhanced keyboard functions must be simulated using two keys instead of one on the larger keyboard.

The **FN** key can be combined with the following keys to simulate functions similar to those of keys on the 104/105 key enhanced keyboard which are not on this computer's keyboard.



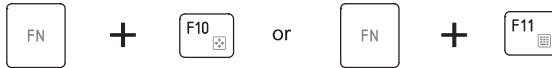

Press **FN + F10** or **FN + F11** to access the computer's integrated keypad. When activated, the keys with grey markings on their bottom edge become either numeric keypad keys (**FN + F11**) or cursor control keys (**FN + F10**). Please refer to the [Keypad overlay](#) section in this chapter for more information on how to operate these keys, taking care to note that the power on default for both settings is off.



Press **FN + F12 (ScrLock)** to lock the cursor on a specific line. The power on default is off.



Press **FN + ENTER** to simulate **ENTER** on the enhanced keyboard's numeric keypad.

## Hot keys

Hot keys (pressing **FN** + a function or **ESC** key) let you enable or disable certain features of the computer.



**Mute:** Pressing **FN + ESC** turns the volume on and off.



**Lock:** Pressing **FN + F1** enters "Lock computer mode". To restore your desktop, you need to log on again.



**Power Plan:** Pressing **FN + F2** changes the power settings.



**Sleep:** Pressing **FN + F3** switches the system to Sleep mode.



**Hibernate:** Pressing **FN + F4** switches the system to Hibernation mode.



**Output:** Pressing **FN + F5** changes the active display device.



**Brightness (Down):** Pressing **FN + F6** decreases the computer's display panel brightness in individual steps.



**Brightness (Up):** Pressing **FN + F7** increases the computer's display panel brightness in individual steps.



**Wireless:** Pressing **FN + F8** switches the active wireless devices.



- *If no wireless communication device is installed, no dialog box will appear.*
- *This hot key is available only when the wireless communication is set to enabled in BIOS Setup or HW Setup.*



**Touch Pad:** Pressing **FN + F9** enables or disables the Touch Pad function.



**Zoom:** Pressing **FN + Space** changes the display resolution.



**TOSHIBA Zooming Utility (reduce):** Pressing **FN + 1** reduces the icon size on the desktop or the font sizes within one of the supported application windows.



**TOSHIBA Zooming Utility (enlarge):** Pressing **FN + 2** enlarges the icon size on the desktop or the font sizes within one of the supported application windows.



**Volume down:** Pressing **FN + 3** to decrease the volume in increments.



**Volume up:** Pressing **FN + 4** to increase the volume in increments.

## FN Sticky key

You can use the TOSHIBA Accessibility Utility to make the **FN** key sticky, that is, you can press it once, release it, and then press an "**F Number**" key. To start the TOSHIBA Accessibility utility, click **Start → All Programs → TOSHIBA → Utilities → Accessibility**.

## Windows special keys

The keyboard provides two keys that have special functions in Windows: Windows Start Button activates the **Start** menu and the other, the application key, has the same function as the secondary mouse button.



This key activates the Windows **Start** menu.



This key has the same function as the secondary (right) mouse button.

## Keypad overlay

Your computer's keyboard does not have a separate numeric keypad but includes a numeric keypad overlay which functions like one - this is located in the center of the keyboard with the relevant functions keys having grey letters at their front edge. The overlay provides the same functions as the numeric keypad on a standard 104/105-key enhanced keyboard.

### Turning on the overlays

The numeric keypad overlay can be used for numeric data input or cursor and page control.

#### Arrow mode

To turn on Arrow Mode, press **FN + F10** - the Arrow mode indicator lights and you are able to access cursor and page control functions by using the keys. You are able to press **FN + F10** again to turn off this overlay function.

#### Numeric mode

To turn on Numeric Mode, press **FN + F11** - the Numeric Mode indicator lights and you are able to access numeric characters by using the keys. You are able to press **FN + F11** again to turn off this overlay function.

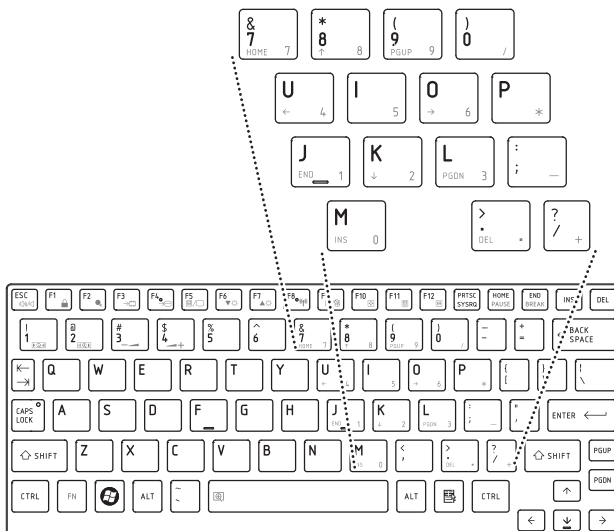

*The numeric keypad overlay*

## Temporarily using normal keyboard (overlay on)

While using the overlay, you can temporarily access the normal keyboard functions without having to turn the overlay off:

1. Hold **FN** and press any other key - this key will operate as if the overlay were off.
2. Type upper-case characters by holding **FN + SHIFT** and pressing a character key.
3. Release **FN** to continue using the selected overlay function.

## Temporarily using overlay (overlay off)

While using the normal keyboard function, you can temporarily use the keypad overlay without having to turn it on:

1. Press and hold down **FN**.
2. Check the keyboard indicators as pressing the **FN** key will turn on the most recently used overlay function - if the Numeric Mode indicator lights you can use the overlay for numeric entry, while if the Arrow Mode indicator lights, you can use the overlay for cursor and page control function.
3. Release **FN** to return to normal keyboard operation.

## Temporarily changing modes

If the computer is in **Numeric Mode**, you can switch temporarily to **Arrow Mode** by pressing a **SHIFT** key, while if it is in **Arrow Mode**, you can switch temporarily to **Numeric Mode** by also pressing a **SHIFT** key.

## Generating ASCII characters

Not all ASCII characters can be generated using normal keyboard operation, but you are able to generate these characters using their specific ASCII codes.

With the overlay on:

1. Hold down **ALT**.
2. Using the overlay keys, type the ASCII code of the character you require.
3. Release **ALT** - the ASCII character will appear on the display screen.

With the overlay off:

1. Hold down **ALT + FN**.
2. Using the overlay keys, type the ASCII code of the character you require.
3. Release **ALT + FN** - the ASCII character will appear on the display screen.

# Chapter 6

## Power and Power-up Modes

The computer's power resources include the AC adaptor and internal batteries. This chapter gives details on making the most effective use of these resources including charging and changing batteries, tips for saving battery power, and power-up modes.

### Power conditions

The computer's operating capability and battery charge status are affected by different power conditions, including whether an AC adaptor is connected, whether a battery pack is installed and what the charge level is for that battery.

		Power on	Power off (no operation)
AC adaptor connected	Battery fully charged	<ul style="list-style-type: none"> <li>Operates</li> <li>LED: <b>Battery</b> green and solid on</li> <li><b>DC IN</b> green</li> </ul>	<ul style="list-style-type: none"> <li>LED: <b>Battery</b> green and solid on</li> <li><b>DC IN</b> green</li> </ul>
	Battery partially charged or no charge	<ul style="list-style-type: none"> <li>Operates</li> <li>Charge</li> <li>LED: <b>Battery</b> amber and solid on</li> <li><b>DC IN</b> green</li> </ul>	<ul style="list-style-type: none"> <li>Charge</li> <li>LED: <b>Battery</b> amber and solid on</li> <li><b>DC IN</b> green</li> </ul>
	No battery installed	<ul style="list-style-type: none"> <li>Operates</li> <li>No charge</li> <li>LED: <b>Battery</b> off</li> <li><b>DC IN</b> green</li> </ul>	<ul style="list-style-type: none"> <li>No charge</li> <li>LED: <b>Battery</b> off</li> <li><b>DC IN</b> green</li> </ul>

		Power on	Power off (no operation)
<b>AC adaptor not connected</b>	Battery charge is above low battery trigger point	<ul style="list-style-type: none"> <li>Operates</li> <li>LED: <b>Battery</b> off</li> <li><b>DC IN</b> off</li> </ul>	
	Battery charge is below low battery trigger point	<ul style="list-style-type: none"> <li>Operates</li> <li>LED: <b>Battery</b> amber and blinking</li> <li><b>DC IN</b> off</li> </ul>	
	Battery charge is exhausted	Computer goes into Sleep Mode and shuts down	
	No battery installed	<ul style="list-style-type: none"> <li>Cannot operate</li> <li>LED: <b>Battery</b> off</li> <li><b>DC IN</b> off</li> </ul>	

Table 6-1 Power conditions

## Power indicators

As shown in the below table, the **Battery**, **DC IN** and **Power** indicators on the system indicator alert you to the computer's operating capability and battery charge status.

### Battery indicator

Check the **Battery** indicator to determine the status of the battery pack - the following indicator conditions should be noted:

<b>Blinking amber</b>	The battery charge is low, the AC adaptor must be connected in order to recharge the battery.
<b>Amber</b>	Indicates the AC adaptor is connected and the battery is charging.
<b>Green</b>	Indicates the AC adaptor is connected and the battery is fully charged.
<b>No light</b>	Under any other conditions, the indicator does not light.



*If the battery pack becomes too hot while it is being charged, the charge will stop and the **Battery** indicator will go out. When the battery pack's temperature falls to a normal range, charging will resume - this process will occur regardless of whether the computer's power is on or off.*

## DC IN indicator

Check the **DC IN** indicator to determine the power status with the AC adaptor connected - the following indicator conditions should be noted:

<b>Green</b>	Indicates the AC adaptor is connected and is correctly supplying power to the computer.
<b>No light</b>	Under any other conditions, the indicator does not light.

## Power indicator

Check the **Power** indicator to determine the power status of the computer - the following indicator conditions should be noted:

<b>Green</b>	Indicates power is being supplied to the computer and the computer is turned on.
<b>Blinking Amber</b>	Indicates that the computer is in Sleep Mode and that there is sufficient power available (AC adaptor or battery) to maintain this condition. In Sleep Mode, this indicator will turn on for two seconds and off for one second.
<b>No light</b>	Under any other conditions, the indicator does not light.

## Battery types

The computer has two different types of batteries:

- Battery pack
- Real Time Clock (RTC) battery

### Battery pack

When the AC adaptor is not connected, the computer's main power source is a removable lithium ion battery pack, also referred to in this manual as the battery. You can purchase additional battery packs for extended use of the computer away from an AC power source although you should not change the battery pack while the AC adaptor is connected.

Before you remove the battery pack, save your data and shut down the computer, or place the computer into Hibernation Mode. Please be aware that, when placing the computer into Hibernation Mode, the contents of memory will be saved to the hard disk drive, although for safety sake, it is best to also save your data manually.





- *The battery pack is a lithium ion battery, which can explode if not properly replaced, used, handled or disposed of. Dispose of the battery as required by local ordinances or regulations. Use only batteries recommended by TOSHIBA as replacements.*
- *Do not remove the battery pack while the computer is in Sleep Mode. In this mode data is stored in memory, so if the computer loses power, it will be lost.*
- *Battery type (depending on the model you purchased)*

## Real Time Clock battery

The Real Time Clock (RTC) battery provides power for the internal real time clock and calendar function and also maintains the system configuration while the computer is turned off. If the RTC battery becomes completely discharged, the system will lose this information and the real time clock and calendar will stop working - in this instance the following message will be displayed when you turn on the power:



**ERROR 0271: Check date and time settings.**

**WARNING 0251: System CMOS checksum bad - Default configuration used.**

**Press <F1> to resume, <F2> to Setup.**



*The computer's RTC battery is a lithium battery and should be replaced only by your dealer or by a TOSHIBA service representative. The battery can explode if not properly replaced, used, handled or disposed of. Dispose of the battery as required by local ordinances or regulations.*

When this error appears, the following action is recommended.

1. Connect the AC adaptor and let the battery charge for 24-hours.
2. Press **F2** to enter BIOS setup menu.
3. Set correct time and date.



*If you still see the error message after performing the above actions, please contact your TOSHIBA service representative.*

## Care and use of the battery pack

The battery pack is a vital component of portable computing and, as such, taking proper care of it will help ensure a longer operating time on battery power as well as deliver a longer life for your battery pack. The instructions detailed in this section will help to ensure safe operation and maximum performance.

Refer to the enclosed **Instruction Manual for Safety and Comfort** for detailed precautions and handling instructions.



- *Make sure the battery is securely installed in the computer before attempting to charge the battery pack. Improper installation could generate smoke or fire, or cause the battery pack to rupture.*
- *Keep the battery pack out of reach of infants and children. It can cause injury.*



- *The battery pack is lithium ion battery, which can explode if not replaced, used, handled or disposed of properly. Dispose of the battery as required by local ordinances or regulations. Use only batteries recommended by TOSHIBA as replacements.*
- *Charge the battery pack only in an ambient temperature between 5 and 35 degrees Celsius. Otherwise, the electrolyte solution might leak, battery pack performance might deteriorate and the battery life might be shortened.*
- *Never install or remove the battery pack without first turning off the power and disconnecting the AC adaptor. Never remove the battery pack while the computer is in Sleep Mode. Data will be lost.*



- *Never remove the battery pack while the Wake-up on LAN function is enabled. Data will be lost. Before you remove a battery pack, disable the Wake-up on LAN function.*

## Charging the batteries

When the power in the battery pack becomes low, the **Battery** indicator will flash amber to indicate that only a few minutes of battery power remain. If you continue to use the computer while the **Battery** indicator flashes, the computer will enable Hibernation Mode so that you do not lose any data, and automatically turn itself off.

You must recharge a battery pack when it becomes discharged.

## Procedures

To recharge a battery pack while it is installed in the computer, connect the AC adaptor to the DC IN 19V jack and plug the other end into a working outlet - the **Battery** indicator will glow amber while the battery is being charged.



*Use only the computer connected to an AC power source to charge the battery pack. Never attempt to charge the battery pack with any other charger.*

## Time

The following table shows the approximate time required to fully charge a discharged battery.

Battery type	Power on	Power off
Battery Pack (3 cell)	about 12 or longer	about 4 or longer
Battery Pack (6 cell)	about 12 or longer	about 6 or longer
RTC battery	about 24	about 24 with AC or Battery pack

*Charging time (hours)*



*Please be aware that the charging time when the computer is on is affected by ambient temperature, the temperature of the computer and how you are using the computer - if you make heavy use of external devices for example, the battery might scarcely charge at all during operation. Please refer to the section [Maximizing battery operating time](#) for further information.*

### **Battery charging notice**

The battery may not begin charging immediately under the following conditions:

- The battery is extremely hot or cold (if the battery is extremely hot, it might not charge at all). To ensure the battery charges to its full capacity, you should charge it at room temperature of between 5° to 35°C (41° to 95°F).
- The battery is nearly completely discharged. In this instance you should leave the AC adaptor connected for a few minutes and the battery should begin charging.

The **Battery** indicator may show a rapid decrease in battery operating time when you try to charge a battery under the following conditions:

- The battery has not been used for a long time.
- The battery has completely discharged and been left in the computer for a long time.
- A cool battery is installed in a warm computer.

In such cases you should follow the steps as detailed below:

1. Fully discharge the battery by leaving it in the computer with the power on until the system automatically turns itself off.
2. Connect the AC adaptor to the DC IN 19V jack of the computer, and to a wall outlet that is supplying power.
3. Charge the battery until the **Battery** indicator glows green.

Repeat these steps two or three times until the battery recovers normal capacity.

## Monitoring battery capacity

Remaining battery power can be monitored in Power Options.



- *You should wait at least 16 seconds after turning on the computer before trying to monitor the remaining operating time. This is because the computer needs this time to check the battery's remaining capacity and then calculate the remaining operating time, based on this together with the current power consumption.*
- *Please be aware that the actual remaining operating time may differ slightly from the calculated time.*
- *With repeated discharges and recharges, the battery's capacity will gradually decrease. In view of this it will be noted that an often used, older battery will not operate for as long as a new battery even when both are fully charged.*

## Maximizing battery operating time

A battery's usefulness depends on how long it can supply power on a single charge, while how long the charge lasts in a battery depends on:

- Processor speed
- Screen brightness
- System Sleep Mode
- System Hibernation Mode
- Display power off period
- Hard disk drive power off period
- How often and for how long you use the hard disk drive, optical disc and floppy diskette drives.
- How much charge the battery contained to begin with.
- How you use optional devices, such as a USB device, to which the battery supplies power.
- Whether you enable Sleep Mode, which can conserve battery power if you are frequently turning the computer off and on.
- Where you store your programs and data.
- Whether you close the display panel when you are not using the keyboard - closing the display saves power.

- The environmental temperature - operating time decreases at low temperatures.
- The condition of the battery terminals - you should always ensure the terminals stay clean by wiping them with a clean dry cloth before installing the battery pack.

## Retaining data with power off

When you turn off your computer with fully charged batteries, the batteries retain data for the following approximate time periods.

Battery type	State and Retention Time
Battery pack	1 day for 6 cell, 0.5 day for 3 cell (Sleep mode) 30 days for 3 cell, 60 days for 6 cell (shut down mode)
RTC battery	30 days

*Retention Time*

## Extending battery life

To maximize the life of your battery packs:

- At least once a month, disconnect the computer from a power source and operate it on battery power until the battery pack fully discharges. Before doing so, follow the steps as detailed below.
  1. Turn off the computer's power.
  2. Disconnect the AC adaptor and turn on the computer's power - if it does not turn on then go to Step 4.
  3. Operate the computer on battery power for five minutes. If you find that the battery pack has at least five minutes of operating time, continue operating until the battery pack is fully discharged, however, if the **Battery** indicator flashes or there is some other warning to indicate a low battery condition, go to Step 4.
  4. Connect the AC adaptor to the DC IN 19V jack of the computer, and to a wall outlet that is supplying power. The **DC IN** indicator should glow green, and the **Battery** indicator should glow amber to indicate that the battery pack is being charged, however, in the event that **DC IN** indicator does not glow this indicates that power is not being supplied - check the connections for the AC adaptor and the power cord.
  5. Charge the battery pack until the **Battery** indicator glows green.
    - If you have extra battery packs, rotate their use.
    - If you will not be using the system for an extended period, for example for more than one month, remove the battery pack from the computer.
    - Disconnect the AC adaptor when the battery is fully charged - overcharging will make the battery hot and can shorten its operating life.
    - If you are not going to use the computer for more than eight hours, disconnect the AC adaptor.
    - Store spare battery packs in a cool dry place out of direct sunlight.

## Replacing the battery pack

Please be aware that the battery pack is classified as a consumable item. The operating life of the battery pack will gradually reduce through repeated charging and discharging, and will need to be replaced when it reaches the end of its operating life. In addition to this, you might also replace a discharged battery pack with a charged spare when you are operating your computer away from an AC power source for an extended period of time.

This section explains how to remove and install the battery pack, and begins with the removal process which is detailed through the following steps.



- *Do not remove the battery pack while the computer is in Sleep Mode. Data is stored in RAM, so if the computer loses power it will be lost.*
- *In Hibernation Mode, data will be lost if you remove the battery pack or disconnect the AC adaptor before the save is completed. Wait for the **Hard Disk Drive** indicator to go out.*
- *Do not touch the battery release latch while holding the computer or the battery pack might fall out due to the unintentional release of the battery release latch and cause injuries.*

To remove a discharged battery, follow the steps as detailed below:

1. Save your work.
2. Turn the computer's power off - ensure that the **Power** indicator is off.
3. Remove all cables and peripherals that are connected to the computer.
4. Close the display panel and turn the computer upside down.
5. Slide the battery safety lock towards the release (  ) position to make the battery release latch movable.

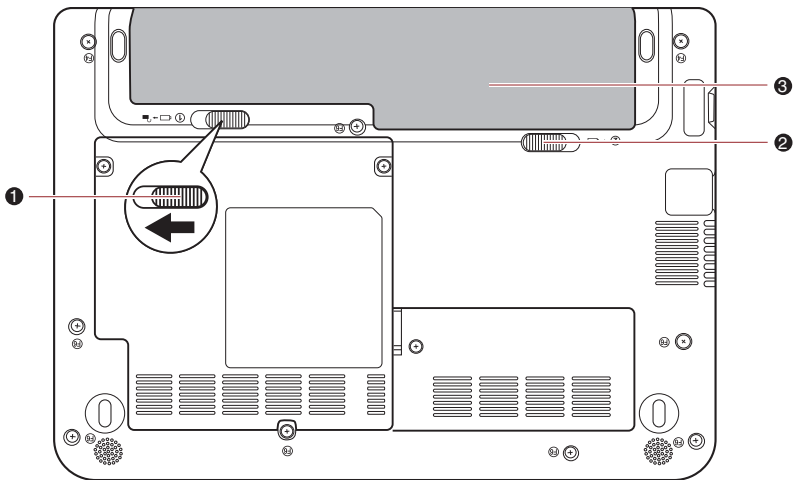

- 1. Battery safety lock
- 2. Battery release latch
- 3. Battery pack

*Releasing the battery pack (1)*

- 6. Slide and hold the battery release latch (1) to disengage the battery pack and then remove it from the computer (2).

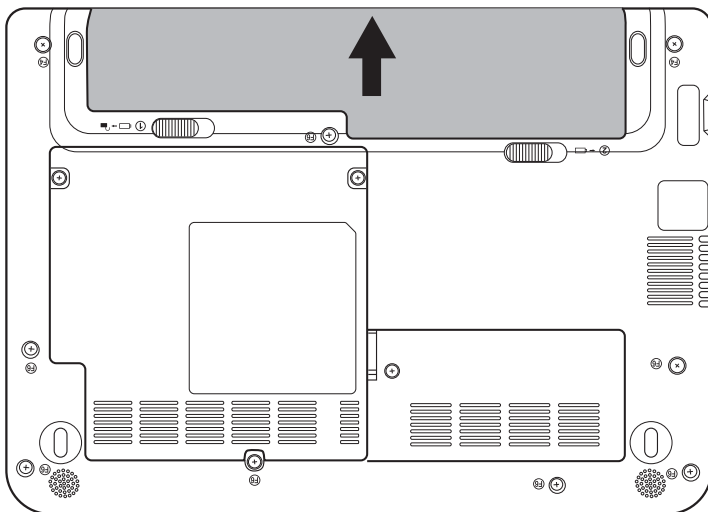

*Releasing the battery pack (2)*

To install a battery, follow the steps as detailed below:

1. Insert the battery pack as far as it will go into the computer (1).
2. Ensure that the battery pack is securely in place and the battery safety lock (2) is in its position.

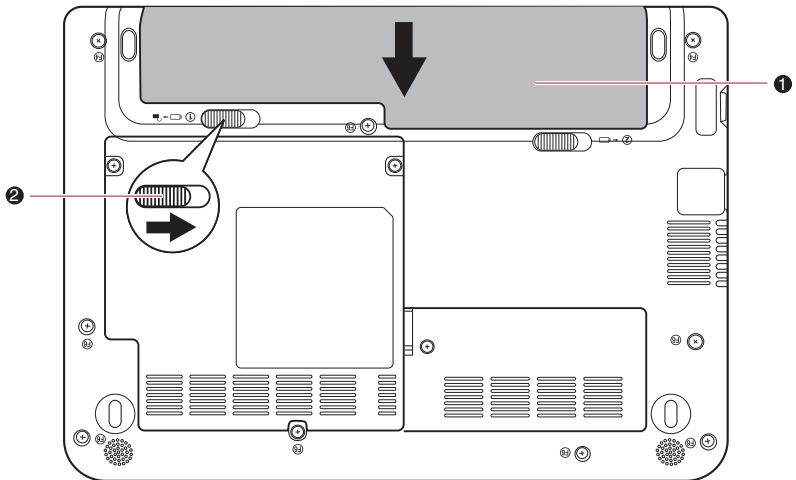

1. Battery Pack

2. Battery safety lock

*Securing the battery pack*

3. Turn your computer over.



## TOSHIBA Password Utility

The TOSHIBA Supervisor Password Utility allows you to maintain an additional level of security and provides two levels of password security: User and Supervisor.



*Passwords set in TOSHIBA Supervisor Password Utility are different from the Windows<sup>®</sup> login password.*

### User Password

To start the utility, point to or click the following items:

**Launch TOSHIBA Assist → SECURE → User Password**

#### ■ Registered

Click to register a password of up to 8 characters. After a password is set, you will be prompted to enter it when you start the computer.

#### ■ Not Registered

Click to delete a registered password. Before you can delete a password, you must first enter the current password correctly.

#### ■ Owner String (text box)

You can use this box to associate text with the password. After you enter text, click Apply or **OK**, then, each time the computer is switched on, this text will be displayed along with the prompt for the password.

### Supervisor password

If you set a supervisor password, some functions will be restricted when a user logs on with the user password. To set a supervisor password:

**TOSHIBA Assist → SECURE → Supervisor password**

This utility lets you do the following:

- Register or delete the supervisor password.
- Specify restrictions for general users.

## Starting the computer by password

If you have already registered a password, there is one way to start the computer:

- Enter the password manually.



*The password is necessary if the computer was shut down in boot mode and Hibernation mode, not in Sleep mode.*

To enter a password manually, follow these steps:

1. Turn on the power as described in Chapter 3, [Getting Started](#). The following message will appear in the LCD:

**Enter Password [xxxxxxxx]**

2. Enter the Password.
3. Press **Enter**.



*If you enter the password incorrectly three consecutive times, the computer shuts down. You must turn on the computer again and re-enter the password.*

## Power-up modes

The computer has three power-up modes:

- **Boot:** Computer shuts down without saving data. Always save your work before you turn the computer off in boot mode.
- **Hibernation:** Data in memory is saved to the hard disk.
- **Sleep:** Data is maintained in the computer's main memory.



*Refer also to the section [Turning off the power in Chapter 3, Getting Started](#).*

## Windows utilities

You can configure various settings associated with both Sleep Mode and Hibernation Mode within the Power Options. To access it, **Start** → **Control Panel** → **System and Security** → **Power Options**.

## Hot keys

You can use the **FN + F3** hot key to enter Sleep Mode or **FN + F4** to enter Hibernation Mode - please refer to Chapter 5, [The Keyboard](#) for further details.

## Panel power on/off

You can set up your computer so that power is turned off automatically when you close the display panel, and turned on again when you open it. Please note that this function is only available for Sleep Mode or Hibernation Mode, not for Boot Mode.



*If the panel power off function is enabled, and you manually shut down Windows, do not close the computer's display panel until the shut down process has been completed.*

## System auto off

This feature turns the system off automatically if it is not used for a set duration. The system shuts down in Sleep Mode or Hibernation Mode.

# Chapter 7

## HW Setup and Passwords

This chapter explains how to use TOSHIBA HW Setup program to configure your computer and how to set passwords.

### HW Setup

TOSHIBA HW Setup allows you to configure settings for General, Password, Display, Boot Priority, Keyboard, USB, LAN.



*If the supervisor password is set, access to the TOSHIBA HW Setup program can be prevented when the user password is used to log on to the computer.*

### Accessing HW Setup

Click on **Start → All Programs → TOSHIBA → Utilities** and click **HWSetup**.

### HW Setup Window

The HW Setup window contains the following tabs: General, Password, Display, Boot Priority, Keyboard, LAN, USB.

<b>OK</b>	Accepts your changes and closes the HW Setup window.
<b>Cancel</b>	Closes the window without accepting your changes.
<b>Apply</b>	Accepts all your changes without closing the HW Setup window.

### General

This window displays the BIOS version and contains two buttons:

<b>Default</b>	Return all HW Setup values to the factory settings.
<b>About</b>	Display the HW Setup version.

## Setup

This field displays BIOS Version and date.



*When finish BIOS update, please restart your computer and press **F2** into BIOS setup manual and load BIOS default one time.*

## Password

### User Password

This option allows you to set or reset the user password for power on.

<b>Not Registered</b>	Changes or remove the password. (Default)
<b>Registered</b>	Sets the password. A dialogue box will appear to allow you to set the password.

To enter a user password:

1. Select Registered to display the following prompt:

Enter Password:

Enter a password of up to 8 characters. The character string you enter is displayed as a string of asterisks. For example, if you enter a password consisting of four characters, the display is shown as:

Enter Password: \*\*\*\*

2. Click the **OK** button. The following message appears, allowing you to verify the password.

Verify Password:

3. If character strings match, the password is registered click **OK** button. If they do not match, the following message appears. You must repeat from step 1.

Entry Error!!!

To delete a user password:

1. Select Not Registered to display the following prompt:

Enter Password:

2. Enter the currently registered password. The character string you enter is displayed as a string of asterisks.

Enter Password: \*\*\*\*

3. Click the **OK** button. If the character string you enter matches the registered password, the password option is reset and the display changes to:

Not registered

If they do not match, the following message appears. You must repeat step 1.  
Incorrect Password!!!



*If you enter the password incorrectly three times in a row, the computer will shut down.*

*You will not be able to access the password option in the HW Setup. In this case you must turn the power off and back on to retry the procedure.*

4. Follow the same procedures described in the earlier section to set a new user password.

## Display

This tab allows you to customize your computer's display settings for either the internal LCD screen or for an external monitor.

### Power On Display

Allows you to set the display to be used when the computer is booted.

<b>Auto-Selected</b>	If any external display is connected, the power on display will be in external display only mode. Otherwise it will be in LCD only mode.
<b>System LCD only</b>	Irrespective of external display connection, the power on display will be in integrated LCD only mode.

## Boot Priority

### Boot Priority Options

This option sets the priority for booting the computer. Select the boot priority from the drop down list.

## Keyboard

### Wake-up on Keyboard

When this feature is enabled and the computer is in Sleep mode, you can turn on the computer by pressing any key. It is effective only for the internal keyboard and only when the computer is in Sleep mode.

<b>Enabled</b>	Enables the Wake-up on Keyboard feature.
<b>Disabled</b>	Disables the Wake-up on Keyboard function (Default).

## USB

### Legacy USB Support

Use this option to enable or disable USB Legacy Emulation. If your operating system does not support USB, you can still use a USB mouse and keyboard by setting the **USB Legacy Emulation** item to enabled.

<b>Enabled</b>	Enables the USB Legacy Emulation. (Default)
<b>Disabled</b>	Disables the USB Legacy Emulation.

## LAN

### Wake-up on LAN

This feature lets the computer's power be turned on from shutdown when it receives awake-up packet (Magic packet) from the LAN.

Regarding Wake-up on LAN from sleep or hibernation, you must check the "Allow the device to wake the computer" check box within the LAN Device properties. (This feature does not affect the Wake-up on LAN from sleep or hibernation.)

<b>Enabled</b>	Enables Wake-up on LAN from shutdown.
<b>Disabled</b>	Disables Wake-up on LAN. from shutdown. (Default)



*The Wake-up on LAN function consumes power even when the system is off. Leave the AC adaptor connected while using this feature.*



*Do not install or remove an optional memory module while Wake-up on LAN is enabled.*

### Built-in LAN

This feature enables or disables the Built-in LAN.

<b>Enabled</b>	Enables Built-in LAN function (Default).
<b>Disabled</b>	Disables Built-in LAN function.

### Wireless Communication Switch

This feature enables or disables the Wireless Communication Switch.

<b>On</b>	Enable Wireless Communication Switch function.
<b>Off</b>	Disable Wireless Communication Switch function.



*To access BIOS setup menu, press **F2** when booting up the computer.*

# Chapter 8

## Optional Devices

Optional devices can expand the computer's capabilities and its versatility. This chapter describes the connection or installation of the following devices:



*To connect optional devices (such as USB device or External monitor) to the computer, be sure to check the shape and orientation of the connector before connecting.*

### **Cards/memory**

- Bridge media slot
  - Secure Digital™ (SD) Card (SD memory card, SDHC memory card, miniSD Card, microSD Card)
  - MultiMediaCard
- Additional memory module

### **Power devices**

- Battery packs
- Universal AC Adaptor

### **Peripheral devices**

- USB floppy diskette drive
- USB optical disc drive
- External monitor

### **Other**

- Security lock



## Bridge media slot

The computer is equipped with a Bridge media slot that can accommodate some kinds of memory media with various memory capacities so that you can easily transfer data from devices, such as digital cameras and Personal Digital Assistants.



- *Keep foreign objects out of the Bridge media slot. Never allow metal objects, such as screws, staples and paper clips, to enter the computer or Keyboard. Foreign metal objects can create a short circuit, which can cause computer damage and fire, possibly resulting in serious injury.*



- *This Bridge media slot supports the following memory media.*
  - *Secure Digital (SD) Card (SD memory card, SDHC memory card, miniSD Card, microSD Card).*
  - *MultiMediaCard (MMC)*
- *To use a micro or mini SD card, an SD adaptor is required.*
- *Please note that not all memory media have been tested and verified to work correctly. Therefore, it is not possible to guarantee that all memory media will operate properly.*



Secure Digital (SD) Card



MultiMediaCard (MMC)



microSD card and adaptor

*Examples of memory media*

## Memory media

This section provides the important safety precautions in order to handle your memory media.



### ***Points to note about the SD/SDHC memory card***

SD/SDHC memory cards comply with SDMI (Secure Digital Music Initiative), which is a technology adopted to prevent unlawful copy or playback of digital music. For this reason, you cannot copy or playback protected material on another computer or other device, and you may not reproduce any copyrighted material except for your personal enjoyment.

Below is a simple explanation for distinguishing SD memory cards from SDHC memory cards.

- SD and SDHC memory cards appear the same externally.
- The logo on SD and SDHC memory cards is different, so pay careful attention to the logo when purchasing.



- The SD memory card logo is () .
- The SDHC memory card logo is () .
- The maximum capacity of SD memory cards is 2GB. The maximum capacity of SDHC memory cards is 32GB.

Card Type	Capacities
SD	8MB, 16MB, 32MB, 64MB, 128MB, 256MB, 512MB, 1GB, 2GB
SDHC	4GB, 8GB, 16GB, 32GB

### Memory media format

New media cards are formatted according to specific standards. If you wish to reformat a media card, be sure to do so with a device that uses media cards.

#### Formatting an SD/SDHC memory card

SD/SDHC memory cards are sold already formatted in conformity to specific standards. If you reformat an SD/SDHC memory card, be sure to reformat it with a device such as digital camera or digital audio player that uses the SD/SDHC memory cards, not with the format command provided within Windows.



- *Should you need to format all areas of the memory card, including the protected area, you will need to obtain an appropriate application that applies the copy protection system.*

## Additional memory module

You can replace with an additional memory in order to increase the amount of system memory that is available.

This section describes how to install and remove optional memory modules.



- *You should place a mat beneath the computer in order to prevent the computer's lid from becoming scratched or damaged when you are installing/replacing the memory module. In this instance you should avoid mats that are made of materials that hold or generate static electricity.*
- *When installing or removing a memory module, you must ensure that you do not touch any other internal areas of the computer.*



- *Use only memory modules approved by TOSHIBA.*
- *Do not try to install or remove a memory module under the following conditions.*
  - a. *The computer is turned on.*
  - b. *The computer was shut down in either Sleep or Hibernation Mode.*
  - c. *Wake-up on LAN is enabled.*
  - d. *The wireless communication is enabled.*
  - e. *USB Sleep and Charge function is enabled.*
- *Be careful not to let screws or other foreign matter fall into the computer. It could cause malfunction or electric shock.*
- *Additional memory modules are precision electronic components that may be fatally damaged by static electricity. Since the human body can carry static electricity, it is important that you discharge yourself before touching or installing any additional memory modules. To discharge your body's static electricity, simply touch any metal close to you with bare hands.*
- *Turn off the power and disconnect the AC adaptor when installing or replacing a memory module.*
- *If you use the computer for an extended period of time, the memory modules and the circuits located close to the memory modules will become hot. Allow them to cool to room temperature before you replace them.*

## Installing a memory module

To install a memory module:

1. Shut down the computer - make sure the Power indicator is off (refer to the [Turning off the power](#) section in Chapter 3, [Getting Started](#) if required).
2. Remove the AC adaptor and all cables and peripherals connected to the computer.
3. Turn the computer upside down and remove the battery pack - refer to [Replacing the battery pack](#) section in Chapter 6, [Power and Power-up Modes](#), if required.
4. Loosen the screw securing the memory module cover.

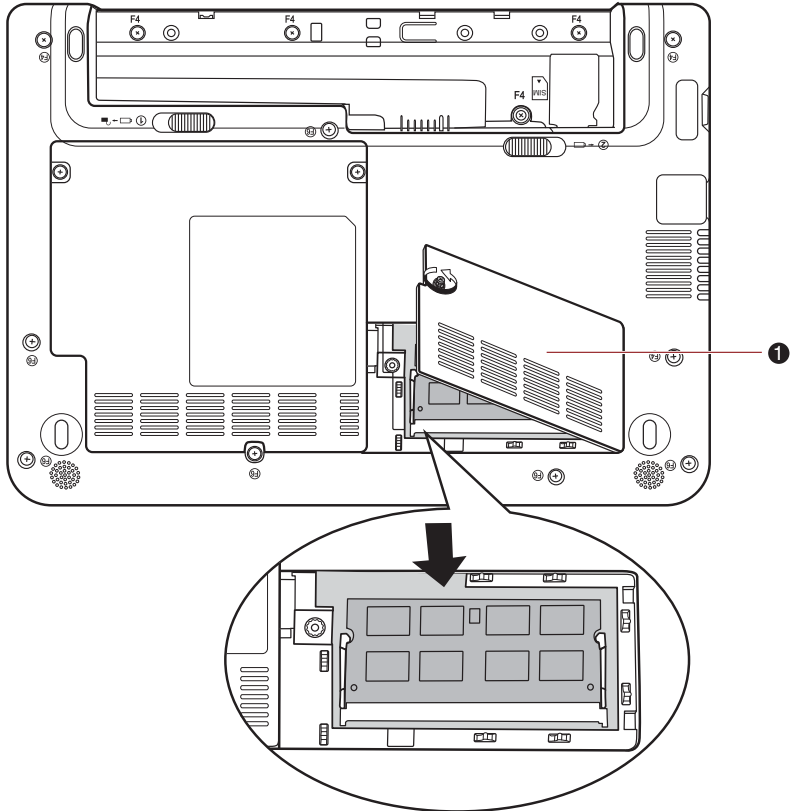

1. memory module cover

*Removing the memory module cover*

5. Align the notch of the memory module with that of the memory module slot and gently insert the module into the slot at about a 30 degree angle before gently pressing until the latches on either side snap into place.



- *Align the grooves along the edges of the memory module with the locking tabs on the connector and insert the memory module into the connector firmly - if you find it difficult to install the memory module, gently prise the locking tabs outwards using the tip of your finger. Please also ensure that you hold the memory module along its left and right hand edges - the edges with the grooves in.*



- Never allow metal objects, such as screws, staples and paper clips, to enter the computer or keyboard. Foreign metal objects can create a short circuit, which can cause computer damage and fire, possibly resulting in serious injury.
- Do not touch the connectors on the memory module or on the computer. Debris on the connectors may cause memory access problems.

6. Seat the memory module cover in place and secure it with one screw.



*Take care to ensure that the memory module cover is firmly closed.*

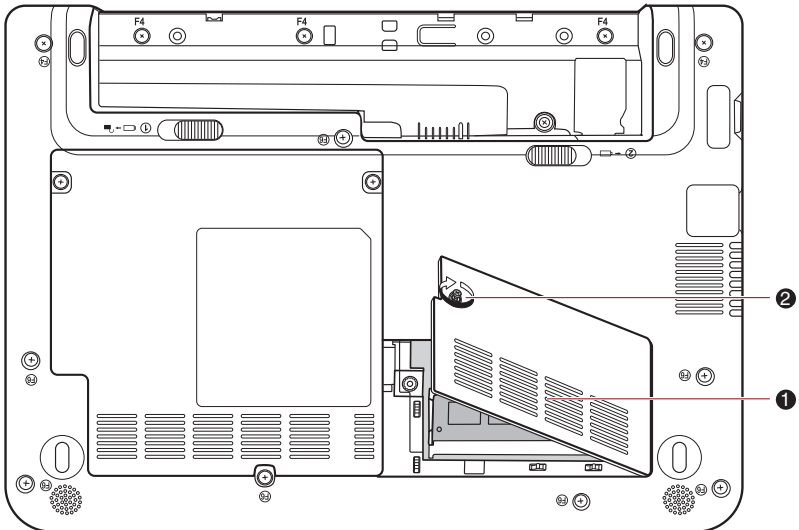

1. memory module cover
2. screw

#### *Seating the memory module cover*

7. Install the battery pack - refer to [Replacing the battery pack](#) section in Chapter 6, [Power and Power-up Modes](#), if required.
8. Turn your computer over.
9. Turn the computer on and make sure the added memory is recognized - to confirm this select **Start** → **Control Panel** → **System and Security** → **System** icon.

## Removing a memory module

To remove the memory module, follow the steps as detailed below:

1. Turn the computer off and remove all cables connected to the computer.
2. Turn the computer upside down and remove the battery pack (refer to Chapter 6, *Power and Power-up Modes*.)
3. Remove one screw securing the memory module cover.
4. Lift off the memory module cover.
5. Push the latches outward and the memory module will pop up.
6. Grasp the memory module by the sides and pull it out.
7. Seat the memory module cover in place and secure it with one screw.
8. Install the battery pack - refer to *Replacing the battery pack* section in Chapter 6, *Power and Power-up Modes*, if required.
9. Turn your computer over.

## Battery Packs

You can increase the portability of the computer with additional battery packs so that, if you're away from an AC power source and your battery runs low, you can replace it with a freshly charged battery. Please refer to Chapter 6, *Power and Power-up Modes* for further information.

## Universal AC Adaptor

If you frequently use your computer at more than one site, it may be convenient to purchase an additional AC adaptor to be kept at each site in order to remove the need to always carry the adaptor with you.

## USB floppy diskette drive

The 3 1/2" external FDD module can be connected to the USB port.

## USB optical disc drive

The USB Optical Disc Drive can be connected to the USB port.

## External monitor

An external analog monitor can be connected to the computer's external monitor port. In order to connect a monitor, follow the steps as detailed below:

1. Connect the monitor cable to the external monitor port.

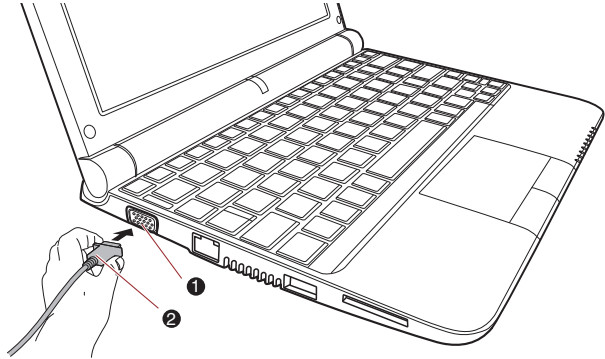

1. External Monitor port
2. Monitor cable

*Connecting the monitor cable to the external monitor port*

2. Turn the external monitor's power on.

When you turn on the power, the computer will automatically recognize the monitor and determine whether it is a color or monochrome device. In the event that you find that there are issues getting an image displayed on the correct monitor, you should consider using the **FN + F5** hot key to change the display settings.

Please refer to Chapter 5, *The Keyboard*, for further details on using hot keys to change the display setting.



*The hibernation and sleep feature can be used with an external monitor. Simply enable hibernation and sleep and the computer will maintain the data as it is displayed on the external monitor.*

## Security lock

A security locks enable you to anchor your computer to a desk or other heavy object in order to help prevent unauthorized removal or theft. The computer has a security lock slot on its right side into which you can attach one end of the security cable, while the other end attaches to a desk or similar object. The methods used for attaching security cables differ from product to product. Please refer to the instructions for the product you are using for more information.

### Connecting the security lock

In order to connect a security cable to the computer, follow the steps as detailed below:

1. Turn the computer so its right hand side faces you.
2. Align the security cable with the 'lock hole' and secure it in place.

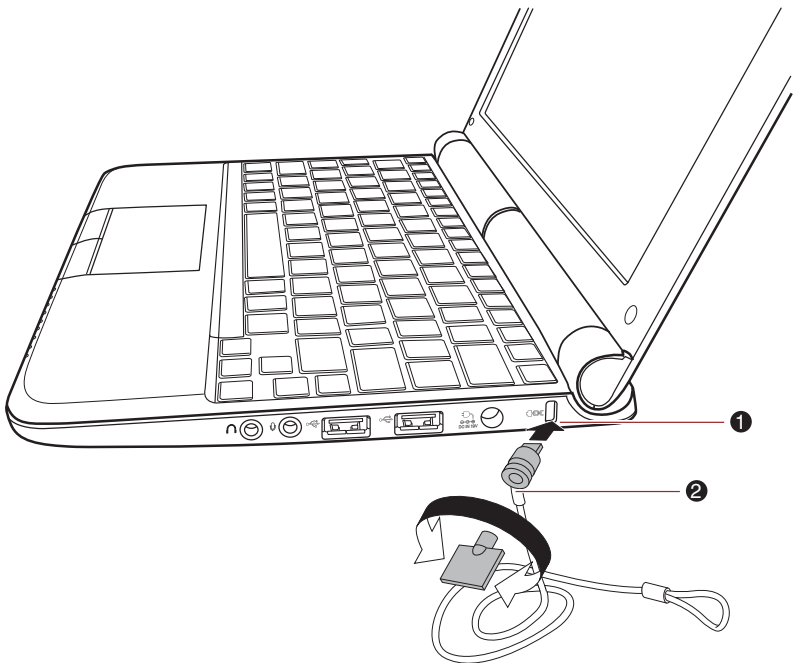

1. Security lock slot
2. Security lock

*Security lock*



# Chapter 9

## Troubleshooting

TOSHIBA designed the computer for durability. However, should problems occur, following the procedures in this chapter can help to determine the cause.

All readers should become familiar with this chapter. Knowing what might go wrong can help prevent problems from occurring.

### Problem solving process

Resolving problems will be much easier if you observe the following guidelines:

- Stop immediately when you recognize a problem exists. Further action may result in data loss or damage. You may destroy valuable problem-related information that can help solve the problem.
- Observe what is happening. Write down what the system is doing and what actions you performed immediately before the problem occurred. If you have a printer attached, print a copy of the screen using the PRTSC (Print Screen) key.

The questions and procedures offered in this chapter are meant as a guide, they are not definitive problem solving techniques. Many problems can be solved simply, but a few may require help from your dealer. If you find you need to consult your dealer or others, be prepared to describe the problem in as much detail as possible.

### Preliminary checklist

Consider the simplest solution first. The items in this checklist are easy to fix and yet can cause what appears to be a serious problem.

- Make sure you turn on all peripheral devices before you turn on the computer. This includes your printer and any other external device you are using.
- Before you attach an external device, turn the computer off. When you turn the computer back on it recognizes the new device.
- Make sure all options are set properly in the setup program.
- Check all cables. Are they correctly and firmly attached? Loose cables can cause signal errors.

- Inspect all connecting cables for loose wires and all connectors for loose pins.
- Check that your diskette is correctly inserted and that the diskette's write protect tab is correctly set.

Make notes of your observations and keep them in a permanent error log. This will help you describe your problems to your dealer. If a problem recurs, the log will help you identify the problem faster.

## Analyzing the problem

Sometimes the system gives clues that can help you identify why it is malfunctioning. Keep the following questions in mind:

- Which part of the system is not operating properly: keyboard, diskette drives, hard disk drive, printer, display. Each device produces different symptoms.
- Is the operating system configuration set properly? Check the configuration options.
- What appears on the display screen? Does it display any messages or random characters? Print a copy of the screen if you have a printer attached. Look up the messages in the software and operating system documentation. Check that all connecting cables are correctly and firmly attached. Loose cables can cause erroneous or intermittent signals.
- Do any icons light? Which ones? What color are they? Do they stay on or blink? Write down what you see.

Record your observations so you can describe them to your dealer.

---

**Software** The problems may be caused by your software or diskette. If you cannot load a software package, the media (usually a diskette) may be damaged or the program might be corrupted. Try loading another copy of the software.

If an error message appears while you are using a software package, check the software documentation. These documents usually include a problem solving section or a summary of error messages.

Next, check any error messages in the operating system documentation.

---

**Hardware** If you cannot find a software problem, check your hardware. First run through the items in the preliminary checklist above. If you still cannot correct the problem, try to identify the source. The next section provides checklists for individual components and peripherals.

---

## Hardware and system checklist

This section discusses problems caused by your computer's hardware or attached peripherals. Basic problems may occur in the following areas:

- System start-up
- Self test
- Power
- Password
- Keyboard
- LCD panel
- Hard disk drive
- Pointing device
- Touch pad device
- SD/MultiMedia Card
- External Monitor
- Sound system
- USB
- Sleep/Hibernation
- LAN
- Wireless LAN

### System start-up

When the computer does not start properly, check the following items:

- Self Test
- Power Sources
- Power-on Password

### Self test

When the computer starts up, the self-test will be run automatically, and the following will be displayed:

**TOSHIBA Leading Innovation>>>>**

This message remains on the screen for a few seconds.

If the self test is successful, the computer tries to load the operating system.

Depending on how the Boot Priority is set in the Hardware Setup, the computer tries to load first from drive A then from drive C, or first from drive C then from drive A.

If any of the following conditions are present, the self test failed:

- The computer stops and does not proceed to display information or messages.
- Random characters appear on the screen, and the system does not function normally.
- The screen displays an error message.

Turn off the computer and check all cable connections. If the test fails again, contact your dealer.

## Power

When the computer is not plugged into an AC adaptor, the battery pack is the primary power source. However, your computer has a number of other power resources, including intelligent power supply and Real Time Clock battery. These resources are interrelated and any one could affect apparent power problems. This section provides check lists for the AC adaptor and the main battery. If you cannot resolve a problem after following them, the cause could lie with another power resource. In such case, contact your dealer.

### *Overheating power down*

If the computer's internal temperature becomes too high, the computer will automatically shut down.

### *AC power*

If you have trouble turning on the computer with the AC adaptor connected. Please refer to Chapter 6, *Power and Power-up Modes* for more information.

Problem	Procedure
<b>AC adaptor doesn't power the computer</b>	<p>Check the connections. Make sure the cord is firmly connected to the computer and a power outlet.</p> <p>Check the condition of the cord and terminals. If the cord is frayed or damaged, replace it. If the terminals are soiled, wipe them with cotton or a clean cloth.</p> <p>If the AC adaptor still does not power the computer, contact your dealer.</p>

## Battery

If you suspect a problem with the battery, check the DC IN and the battery indicator. For information on indicators and battery operation see Chapter 6, *Power and Power-up Modes*.

Problem	Procedure
<b>Battery doesn't power the computer</b>	The battery may be discharged - connect the AC adaptor to recharge the battery.
<b>Battery doesn't charge when the AC adaptor is attached (Battery indicator does not glow amber).</b>	<p>If the battery is completely discharged, it will not begin charging immediately. Wait a few minutes.</p> <p>If the battery still does not charge, make sure the outlet is supplying power. Test it by plugging in an appliance. If it doesn't work, try another power source</p> <hr/> <p>Check whether the battery is hot or cold to the touch. If the battery is too hot or too cold, it will not charge properly. Make it reach room temperature.</p> <hr/> <p>Unplug the AC adaptor and remove the battery to make sure the terminals are clean. If necessary wipe them with a soft dry cloth dipped in alcohol. Connect the AC adaptor and replace the battery. Make sure it is securely seated.</p> <hr/> <p>Check the Battery indicator. If it does not glow, make the computer charge the battery for at least 20 minutes. If the Battery indicator glows after 20 minutes, let the battery continue to charge for at least another 20 minutes before turning on the computer.</p> <p>If the indicator still does not glow, the battery may be at the end of its operating life. Replace it.</p> <p>If you do not think the battery is at the end of its operating life, see your dealer.</p>
<b>Battery doesn't power the computer as long as expected</b>	<p>If you frequently recharge a partially charged battery, the battery might not charge to its full potential. Fully discharge the battery, then try to charge it again.</p> <hr/> <p>Check the power consumption settings in Power Management. Consider using a power saving mode.</p>

## Password

Problem	Procedure
<b>Cannot enter password</b>	Refer to the <i>HW Setup Window</i> section in Chapter 7, <i>HW Setup and Passwords</i> .

## Keyboard

Keyboard problems can be caused by your setup configuration. For more information refer to Chapter 5, *The Keyboard* and Chapter 7, *HW Setup and Passwords* .

Problem	Procedure
<b>Some letter keys produce numbers</b>	Check that the numeric keypad overlay is not selected. Press <b>FN + F11</b> and try typing again.
<b>Output to screen is garbled</b>	Make sure the software you are using is not remapping the keyboard. Remapping involves reassigning the meaning of each key. See your software's documentation.  If you are still unable to use the keyboard, consult your dealer

## LCD panel

Apparent LCD problems may be related to the computer's setup. Refer to Chapter 7, *HW Setup and Passwords* , for more information.

Problem	Procedure
<b>No display</b>	Press hot keys <b>FN + F5</b> to change the display priority, to make sure it is not set for an external monitor.
<b>Markings appear on the LCD screen.</b>	They might have come from contact with the keyboard or touch pad. Try wiping the LCD gently with a clean dry cloth. If markings remain, use LCD cleaner. Be sure to let the LCD dry before closing it.
<b>Problems above remain unresolved or other problems occur</b>	Refer to your software's documentation to determine if the software is causing the difficulty. Contact your dealer if the problems continue.

## Hard disk drive

Problem	Procedure
<b>Computer does not boot from hard disk drive</b>	<p>Check if a diskette is in the diskette drive or a CD/DVD is in the optical disc drive. Remove any diskette and/or CD/DVD and check the Boot priority settings. Refer to Chapter 7, <i>Boot Priority</i> section.</p> <p>There may be a problem with your operating system files. Refer to your operating system documentation.</p>
<b>Slow performance</b>	<p>The files on the hard disk drive may be fragmented - in this instance you should run the disk defragmentation utility to check the condition of your files and the hard disk drive. Please refer to the operating system's documentation or online Help File for further information on operating and using the defragmentation utility.</p> <p>As a last resort you should reformat the hard disk drive and then reload the operating system and all other files and data. If you are still unable to resolve the problem, contact your reseller, dealer or service provider.</p>

## Pointing device

If you are using a USB mouse, also refer to the *USB* section in this chapter and to your mouse documentation.

### *Touch Pad*

Problem	Procedure
<b>On-screen pointer does not respond to Touch Pad operation</b>	<p>The system might be busy. If the pointer is shaped as an hourglass, wait for it to resume its normal shape and try again to move it.</p>
<b>Double-tapping does not work</b>	<p><b>Try changing the double-click speed setting in the mouse control utility.</b></p> <ol style="list-style-type: none"> <li>1. Click <b>Start</b> → <b>Control Panel</b> → <b>Hardware and Sound</b> → <b>Mouse</b> to access the mouse control utility.</li> <li>2. Click the <b>Buttons</b> tab.</li> <li>3. Set the Double-click speed as instructed and click <b>OK</b>.</li> </ol>

Problem	Procedure
<b>The mouse pointer moves too fast or too slow</b>	<p>Try changing the speed setting in the mouse control utility.</p> <ol style="list-style-type: none"> <li>1. Click <b>Start → Control Panel → Hardware and Sound → Mouse</b> to access the mouse control utility.</li> <li>2. Click the <b>Pointer Options</b> tab.</li> <li>3. Set the speed as instructed and click <b>OK</b>.</li> </ol>

### **USB mouse**

Problem	Procedure
<b>On-screen pointer does not respond to mouse operation</b>	<p>The system might be busy. If the pointer is shaped as an hourglass, wait for it to resume its normal shape and try again to move it.</p> <hr/> <p>Make sure the mouse is properly connected to the USB port.</p>
<b>Double-clicking does not work</b>	<p>Try changing the double-click speed setting in the mouse control utility</p> <ol style="list-style-type: none"> <li>1. Click <b>Start → Control Panel → Hardware and Sound → Mouse</b> to access the mouse control utility.</li> <li>2. Click the <b>Buttons</b> tab.</li> <li>3. Set the <b>Double-click speed</b> as instructed and click <b>OK</b>.</li> </ol>
<b>The mouse pointer moves too fast or too slow</b>	<p>Try changing the speed setting in the mouse control utility.</p> <ol style="list-style-type: none"> <li>1. Click <b>Start → Control Panel → Hardware and Sound → Mouse</b> to access the mouse control utility.</li> <li>2. Click the <b>Pointer Options</b> tab.</li> <li>3. Set the speed as instructed and click <b>OK</b>.</li> </ol>
<b>The mouse pointer moves erratically</b>	<p>The mouse might be dirty. Refer to your mouse documentations for instructions on cleaning. If problems persist, contact your dealer.</p>



## SD/MultiMedia Card

Refer also to Chapter 8, *Optional Devices* .

Problem	Procedure
<b>Memory card error occurs</b>	Reseat the memory card to make sure it is firmly connected. Check the card's documentation.
<b>You cannot write to the memory card</b>	Make sure the card is not write protected.
<b>You cannot read a file</b>	Make sure the target file is on the memory card inserted in the slot. If problems persist, contact your dealer.

## External Monitor

Refer also to Chapter 8, *Optional Devices* , and to your monitor's documentation.

Problem	Procedure
<b>Monitor does not turn on</b>	Make sure that the external monitor's power switch is on. Confirm that the external monitor's power cable is plugged into a working power outlet.
<b>No display</b>	Try adjusting the contrast and brightness controls on the external monitor.
<b>Display error occurs</b>	Check that the cable connecting the external monitor to the computer is attached firmly. If problems persist, contact your dealer.

## Sound system

Problem	Procedure
<b>No sound is heard</b>	Check the software volume settings. Make sure the headphone connection is secure. Check Sound Preferences. Make sure the sound function is enabled and that settings for I/O address, Interrupt level and DMA are correct for your software and do not conflict with other hardware devices that you may have connected to the computer. If problems persist, contact your dealer.

## USB

Refer also to your USB device's documentation.

Problem	Procedure
<b>USB device does not work</b>	<p>Check for a firm cable connection between the USB ports on the computer and the USB device.</p> <p>Make sure the USB device drivers are properly installed. Refer to your Windows documentation for information on checking the drivers.</p> <hr/> <p>If you are using an operating system that does not support USB, you can still use a USB mouse and/or USB keyboard. If these devices do not work, make sure the USB KB/Mouse Legacy Emulation item in HW Setup is set to <b>Enabled</b>.</p> <hr/> <p>If problems persist, contact your dealer.</p>

## USB Sleep and Charge function

Problem	Procedure
<p><b>I cannot use the "USB Sleep and Charge function".</b></p>	<p>The setting of "USB Sleep and Charge function" may be disabled.</p> <p>Check the "USB Sleep and Charge" check box to enable this function in the TOSHIBA USB Sleep and Charge Utility.</p> <hr/> <p>When there is a current overflow of the external device connected to the compatible port, USB bus power (DC5V) supply may be stopped for safety reasons. If this happens, disconnect the external device if one is connected. After that, turn the power of the computer ON/OFF to restore the function. If this function can not be still used even if only one external device is connected, stop using the external device because its current is over the acceptable value of this computer.</p> <hr/> <p>Some external devices may not be able to use the "USB Sleep and Charge function." In this case, please try one or more of the following methods.</p> <ul style="list-style-type: none"> <li>■ Change the Power supply mode settings in the TOSHIBA USB Sleep and Charge Utility.</li> <li>■ Turn OFF the computer while external devices are connected.</li> </ul> <p>If this function can not be still used, uncheck the "USB Sleep and Charge" check box in the TOSHIBA USB Sleep and Charge Utility and stop using the function.</p>
<p><b>The battery depletes quickly even when I have turned OFF the power of the computer.</b></p>	<p>If USB Sleep and Charge function is enabled, the computer's battery will discharge during hibernation or when the computer is turned off.</p> <p>Connect the AC adaptor to the computer or uncheck the "USB Sleep and Charge" check box to disable this function in the TOSHIBA USB Sleep and Charge Utility.</p>

Problem	Procedure
<b>External devices connected to the compatible ports do not work.</b>	<p>Some external devices may not work when connected to a compatible port when the "USB Sleep and Charge function" is enabled in the TOSHIBA USB Sleep and Charge Utility.</p> <p>Reconnect the external device after turning ON the computer.</p> <p>If the external device still does not work, connect the device to an USB port that does not have the USB Sleep and Charge function-compatible icon ( ⚡ ) or uncheck the "USB Sleep and Charge" check box to disable this function in the TOSHIBA USB Sleep and Charge Utility.</p>
<b>The "USB WakeUp function" does not work</b>	<p>When "USB Sleep and Charge function" is enabled in the TOSHIBA USB Sleep and Charge Utility, the "USB WakeUp function" does not work for ports that support the USB Sleep and Charge function.</p> <p>In that case, use an USB port that does not have the USB Sleep and Charge function-compatible icon ( ⚡ ) or uncheck the "USB Sleep and Charge" check box to disable this function in the TOSHIBA USB Sleep and Charge Utility.</p>

## Sleep/Hibernation

Problem	Procedure
<b>The system will not enter sleep/ hibernation</b>	<p>Is Audio Player open? The system might not enter sleep/hibernation, if Audio Player is either playing a selection or finished playing a selection. Close Audio Player before you select sleep/hibernation.</p> <p>If problems persist, contact your dealer.</p>

## LAN

Problem	Procedure
<b>Cannot access LAN</b>	<p>Check for a firm cable connection between the LAN jack and the LAN hub.</p>
<b>Wake-up on LAN</b>	<p>Make sure the AC adaptor is connected. The Wake-up on LAN function consumes power even when the system is off.</p> <p>If problems persist, consult your LAN administrator.</p>

## Wireless LAN

If the following procedures do not restore LAN access, consult your LAN administrator. For more information on wireless communication, refer to Chapter 4, *Operating Basics*.

Problem	Procedure
<b>Cannot access Wireless LAN</b>	<p>Make sure the computer's wireless communication service is turned on.</p> <p>If problems persist, consult your LAN administrator.</p>

## Bluetooth

For more information on wireless communication, refer to Chapter 4, *Operating Basics*.

Problem	Procedure
<b>Cannot access Bluetooth device</b>	<p>Make sure the computer's wireless communication service is turned on.</p> <p>Make sure the Bluetooth Manager is running and the power to the Bluetooth device is turned on.</p> <p>Make sure no optional Bluetooth adaptors are installed in the computer. The built-in Bluetooth function and an optional Bluetooth Adpater cannot operate simultaneously.</p> <p>If problems persist, contact your dealer.</p>

## TOSHIBA support

If you require any additional help using your computer or if you are having problems operating the computer, you may need to contact TOSHIBA for additional technical assistance.

### Before you call

Some problems you experience may be related to software or the operating system so it is important that you investigate other sources of assistance first. Before contacting TOSHIBA, try the following:

- Review troubleshooting sections in the documentation supplied with your software and/or peripheral devices.
- If a problem occurs when you are running software applications, consult the software documentation for troubleshooting suggestions and consider calling the software company's technical support department for assistance.
- Consult the dealer where you purchased your computer and/or software. They are your best resource for current information and support.

## Where to write

If you are still unable to solve the problem and suspect that it is hardware related, write to TOSHIBA at the location listed in the enclosed warranty booklet or visit <http://www.toshiba-europe.com> on the Internet.

# Chapter 10

## Legal Footnotes

This chapter states the Legal Footnote(s) information applicable to TOSHIBA computers.

### CPU\*1

Central Processing Unit ("CPU") Performance Legal Footnote.

CPU performance in your computer product may vary from specifications under the following conditions:

- use of certain external peripheral products
- use of battery power instead of AC power
- use of certain multimedia, computer generated graphics or video applications
- use of standard telephone lines or low speed network connections
- use of complex modeling software, such as high end computer aided design applications
- use of several applications or functionalities simultaneously
- use of computer in areas with low air pressure (high altitude >1,000 meters or >3,280 feet above sea level)
- use of computer at temperatures outside the range of 5°C to 35°C (41°F to 95°F) or >25°C (77°F) at high altitude (all temperature references are approximate and may vary depending on the specific computer model - please refer to your PC documentation or visit the Toshiba website at <http://www.pcsupport.toshiba.com> for details).

CPU performance may also vary from specifications due to design configuration. Under some conditions, your computer product may automatically shut-down. This is a normal protective feature designed to reduce the risk of lost data or damage to the product when used outside recommended conditions. To avoid risk of lost data, always make back-up copies of data by periodically storing it on an external storage medium. For optimum performance, use your computer product only under recommended conditions. Read additional restrictions in your product documentation. Contact Toshiba technical service and support, refer to TOSHIBA support section in chapter 9, *Troubleshooting* for more information.

A 32-bit version of the operating system is preinstalled on your computer unless explicitly stated that the operating system is 64-bit. See "<http://www.pcsupport.toshiba.com>" for more information.

## Memory (Main System)\*2

Part of the main system memory may be used by the graphics system for graphics performance and therefore reduce the amount of main system memory available for other computing activities. The amount of main system memory allocated to support graphics may vary depending on the graphics system, applications utilized, system memory size and other factors.

## Battery Life\*3

Battery life may vary considerably depending on product model, configuration, applications, power management settings and features utilized, as well as the natural performance variations produced by the design of individual components. Published battery life numbers are achieved on select models and configurations tested by Toshiba at the time of publication. Recharge time varies depending on usage. Battery may not charge while computer is consuming full power. After a period of time, the battery will lose its ability to perform at maximum capacity and will need to be replaced. This is normal for all batteries. To purchase a new battery pack, see the accessories information that shipped with your computer.

## HDD drive capacity\*4

One Gigabyte (GB) means  $10^9 = 1,000,000,000$  bytes using powers of 10. The computer operating system, however, reports storage capacity using powers of 2 for the definition of  $1 \text{ GB} = 2^{30} = 1,073,741,824$  bytes, and therefore shows less storage capacity. Available storage capacity will also be less if the product includes one or more pre-installed operating systems, such as Microsoft Operating System and/or pre-installed software applications, or media content. Actual formatted capacity may vary.

## LCD

Over a period of time, and depending on the usage of the computer, the brightness of the LCD screen will deteriorate. This is an intrinsic characteristic of LCD technology.

## Graphics Processor Unit (GPU)

Graphics processor unit (GPU) performance may vary depending on product model, design configuration, applications, power management settings and features utilized. GPU performance is only optimized when operating in AC power mode and may decrease considerably when operating in battery power mode.



## Wireless LAN\*7

The transmission speed over the wireless LAN and the distance over which wireless LAN can reach may vary depending on surrounding electromagnetic environment, obstacles, access point design and configuration, and client design and software/hardware configurations. The actual transmission speed will be lower than the theoretical maximum speed.

## Non-applicable Icons

Certain notebook chassis are designed to accommodate all possible configurations for an entire product series. Therefore, please be aware that your selected model may not have all the features and specifications corresponding to all of the icons or switches shown on the notebook chassis, unless you have selected all those features.

## Copy Protection

Copy protection technology included in certain media may prevent or limit recording or viewing of the media.

## USB Sleep and Charge

The "USB Sleep and Charge function" may not work with certain external devices even if they are compliant with the USB specification. In those cases, turn the power of the computer ON to charge the device.

---

# Appendixes

## Table of Contents

<i>Appendix A</i>	<b>Specifications</b> .....	<b>A-1</b>
<i>Appendix B</i>	<b>Display Controller</b> .....	<b>B-1</b>
<i>Appendix C</i>	<b>Wireless LAN</b> .....	<b>C-1</b>
<i>Appendix D</i>	<b>AC Power Cord and Connectors</b> .....	<b>D-1</b>
<i>Appendix E</i>	<b>TOSHIBA PC Health Monitor</b> .....	<b>E-1</b>
<i>Appendix F</i>	<b>If your computer is stolen</b> .....	<b>F-1</b>

# Appendix A

## Specifications

This appendix summarizes the computer's technical specifications.

### Physical Dimensions

#### Size

Size	
<b>With 3 cell Battery</b>	266(w) × 192.3(d) × 24.2(front) × 30.8(rear) millimeters (not including parts that extend beyond the main body)
<b>With 6 cell Battery</b>	266(w) × 192.3(d) × 24.2(front) × 36.4(rear) millimeters (not including parts that extend beyond the main body)

### Environmental requirements

	Operating	Non-operating
<b>Ambient temperature</b>	5°C (41°F) to 35°C (95°F)	-20°C (-4°F) to 60°C (140°F)
<b>Relative humidity (non condensing)</b>	20% to 80%	10% to 90%
<b>Altitude (from sea level)</b>	0 to 3,000 meters	0 to 10,000 meters

### Power Requirements

Power Requirements	
<b>AC adaptor</b>	100-240 volts AC 50 or 60 hertz (cycles per second)
<b>Computer</b>	19V DC

# Appendix B

## Display Controller

### Display controller

The display controller interprets software commands into hardware commands that turn particular pixels on or off.

A high-resolution external monitor connected to the computer can display up to 1400 horizontal and 1050 vertical pixels at up to 16M colors.

The display controller also controls the video mode, which uses industry standard rules to govern the screen resolution and the maximum number of colors that can be displayed on screen.

Software written for a given video mode will run on any computer that supports the mode.

*Some of display modes might not be supported depending on the external monitor which you use.*



*If you are running some application (for example a 3D application or video playback and so on), you may notice some disturbance, flickering or frame dropping on your screen. If that occurs, adjust the resolution of display, lowering it until the screen is displayed properly.*

# Appendix C

## Wireless LAN

This appendix is intended to help you get your Wireless LAN network up and running, with a minimum of parameters.

### Card Specifications

<b>Form Factor</b>	■ Mini Card
<b>Compatibility</b>	<ul style="list-style-type: none"> <li>■ IEEE 802.11 Standard for (Revision b,g and n) Wireless LANs</li> <li>■ Wi-Fi (Wireless Fidelity) certified by the Wi-Fi Alliance. The 'Wi-Fi CERTIFIED' logo is a certification mark of the Wi-Fi Alliance.</li> </ul>
<b>Media Access Protocol</b>	■ CSMA/CA (Collision Avoidance) with Acknowledgment (ACK)

### Radio Characteristics

Radio characteristics of Wireless LAN cards may vary according to:

- Country/region where the product was purchased
- Type of product

Wireless communication is often subject to local radio regulations. Although Wireless LAN wireless networking products have been designed for operation in the license-free 2.4 GHz, local radio regulations may impose a number of limitations to the use of wireless communication equipment.



*Refer to the sheet Information to the User for regulatory information that may apply in your country/region.*

<b>R-F Frequency</b>	■ Band 2.4 GHz (2400-2483.5 MHz) (Revision b,g and n)
----------------------	-------------------------------------------------------

The range of the wireless signal is related to the transmit rate of the wireless communication. Communications at lower transmit range may travel larger distances.

- The range of your wireless devices can be affected when the antennas are placed near metal surfaces and solid high-density materials.
- Range is also impacted due to "obstacles" in the signal path of the radio that may either absorb or reflect the radio signal.

## Supported frequency sub-bands

Subject to the radio regulations that apply in your country/region, your Wireless LAN card may support a different set of 2.4 GHz channels. Consult your Authorized Wireless LAN or TOSHIBA Sales office for information about the radio regulations that apply in your country/region.

Frequency Range	Channel ID	2400-2483.5 MHz
	1	2412
	2	2417
	3	2422
	4	2427
	5	2432
	6	2437
	7	2442
	8	2447
	9	2452
	10	2457* <sup>1</sup>
	11	2462
	12	2467* <sup>2</sup>
	13	2472* <sup>2</sup>

*Table Wireless IEEE 802.11 Channels Sets (Revision b,g and n)*

When installing Wireless LAN cards, the channel configuration is managed as follows:

- For wireless clients that operate in a Wireless LAN infrastructure, the Wireless LAN card will automatically start operation at the channel identified by the Wireless LAN Access Point. When roaming between different access points the station can dynamically switch to another channel if required.
- In a Wireless LAN Access Point, the Wireless LAN card will use the factory-set default channel (printed in bold), unless the LAN Administrator selected a different channel when configuring the Wireless LAN Access Point device.

\*<sup>1</sup> Factory-set default channels

\*<sup>2</sup> Check if these channels can be used in your country/region.

# Appendix D

## AC Power Cord and Connectors

The AC input plug of power cord must be compatible with various international AC power outlets. Power cords need to meet the local standards and the specifications listed as below:

<b>Length:</b>	Minimum 1.7 meters
<b>Wire size:</b>	Minimum 0.75 mm <sup>2</sup>
<b>Current rating:</b>	Minimum 2.5 amperes
<b>Voltage rating:</b>	125 or 250 VAC (depending on country/region's power standards)

### Certification agencies

#### *Europe:*

<b>Austria:</b>	OVE	<b>Italy:</b>	IMQ
<b>Belgium:</b>	CEBEC	<b>The Netherlands:</b>	KEMA
<b>Denmark:</b>	DEMKO	<b>Norway:</b>	NEMKO
<b>Finland:</b>	FIMKO	<b>Sweden:</b>	SEMKO
<b>France:</b>	LCIE	<b>Switzerland:</b>	SEV
<b>Germany:</b>	VDE	<b>United Kingdom:</b>	BSI

#### *Outside of Europe:*

<b>U.S. and Canada:</b>	UL listed and CSA certified No. 18 AWG, Type SVT or SPT-2		
<b>China:</b>	CCC, CQC	<b>India:</b>	STQC
<b>Australia:</b>	AS		

In Europe, two conductors power cords must be VDE type, H05VVH2-F or H03VVH2-F; while three conductors be VDE type, H05VV-F.

For the United States and Canada, two pin plug configuration must be 2-15P (250V) or 1-15P (125V); while three pin be 6-15P (250V) or 5-15P (125V) as designated in the U.S. National Electrical code handbook and the Canadian Electrical Code Part II.

The following illustrations show the plug shapes for USA, Australia, Canada, United Kingdom, Europe, and China.

**USA**

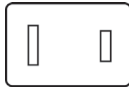

UL approved

**United Kingdom**

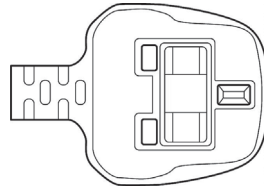

BS approved

**Australia**

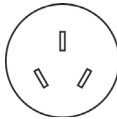

AS approved

**Europe**

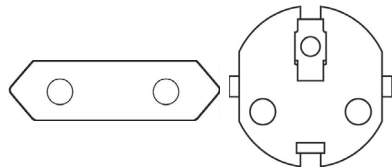

Approved by the appropriate agency

**Canada**



CSA approved

**China**

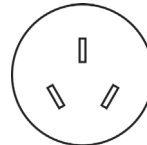

CCC approved



# Appendix E

## TOSHIBA PC Health Monitor

The TOSHIBA PC Health Monitor software program monitors computer system functions such as power consumption, the cooling system and HDD Drop sensor. It alerts users of specific system conditions via pop-up messages. It also tracks the usage of the computer and related devices, logging the service relevant information on the computer's hard disk drive.

- The collected information includes device operation time and number of actuations or status changes (i.e.: number of power button and **FN** key combination uses, AC adaptor, battery, LCD, fan, HDD, sound volume, wireless communication switch, TOSHIBA Express Port Replicator and USB information), date of initial system use, and also computer and device usage (i.e.: power settings, battery temperature and recharging, CPU, memory, backlight illumination time, and temperatures for various devices), property (e.g., product name, model number, part number, serial number, BIOS version, FW version) of the system and components (e.g., Video device, Sound device, Network device, Hard Disk drive, Solid State drive, Optical Disc drive), operating system and software information (e.g., OS version, OS install date, DirectX version, Internet Explorer version, installed update program and driver lists). The stored data uses a very small portion of the total hard disk capacity, approximately 10MB or less per year.
- This information is used to identify and provide a notification of system conditions which may effect the performance of your Toshiba computer. It may also be used to help diagnose problems should the computer require service by Toshiba or Toshiba's authorized service providers. Additionally, Toshiba may also use this information for quality assurance analysis. Subject to the use restrictions above, the HDD data logged may be transferred to entities located outside of your country or region of residence (e.g., European Union). Those countries may or may not have the same data protection laws or data protection levels as required by your home country or region.
- Once enabled, you may disable the TOSHIBA PC Health Monitor at any time by uninstalling the software via **Uninstall a program** in the **Control Panel**. Doing so will automatically delete all collected information from the HDD.
- The TOSHIBA PC Health Monitor software does not extend or modify Toshiba's obligations under its standard limited warranty in any way. Toshiba's standard limited warranty terms and limitations apply.

## Starting the TOSHIBA PC Health Monitor

The TOSHIBA PC Health Monitor can be started using the following methods:

- Click **Start** → **All Programs** → **TOSHIBA** → **Utilities** → **PC Health Monitor**.
- Click the icon in the notification area, then click the "**Click here to enable TOSHIBA PC Health Monitor.**" message when it is displayed.  
(\*)

No matter which method is used, the TOSHIBA PC Health Monitor explanation screen will be displayed.

Clicking "**Next**" will display the "**TOSHIBA PC Health Monitor Software Notice & Acceptance**" screen. Please carefully read the information displayed. Selecting "**ACCEPT**" and clicking "**OK**" will enable the program. By enabling the TOSHIBA PC Health Monitor software, you agree with these terms and conditions and to the use and sharing of the collected information. Once the program is enabled, the TOSHIBA PC Health Monitor screen is displayed, and the program will begin monitoring system functions and collecting information.

(\*) This message will no longer be displayed after clicking "**ACCEPT**" or "**DECLINE**" on the "**TOSHIBA PC Health Monitor Software Notice & Acceptance**" screen.

## If a TOSHIBA PC Health Monitor message is displayed

A message will be displayed if any changes which may interfere with the operation of the program are detected.

\* If a message is displayed, follow the instructions displayed on screen.

# Appendix F

## If your computer is stolen



*Always take care of your computer and try to prevent it from being stolen. You are the owner of a valuable technical device, which may be highly attractive to thieves, so please do not leave it unattended in a public place. To further help protect against theft, security cables can be bought for use with your notebook when it is being used at home or in the office.*

*Make a note of your computer's machine type, model number, and serial number, and put it in a safe place. You will find this information on the underside of your notebook. Please also keep the receipt of the computer you purchased.*

**Should your computer be stolen**, however, we'll help you try to find it. Before contacting TOSHIBA, please prepare the following information which is necessary to uniquely identify your computer:

- In which country was your computer stolen?
- What type of machine do you have?
- What was the model number (PA number)?
- What was the serial number (8 digits)?
- When was it stolen, i.e. date?
- What is your address, phone, and fax number?

**To register the theft on paper, please follow these procedures:**

- Fill in the TOSHIBA Theft Registration form (or a copy of it) below.
- Attach a copy of your receipt showing where your computer was purchased.
- Either fax or send the receipt and registration form to the address below.

**To register the theft online, please follow these procedures:**

- Visit <http://www.toshiba-europe.com> on the Internet. In the product area, choose **Computer Systems**.
- In the Computer Systems page, open the **Support & Downloads** menu and choose the **Stolen Units Database** option.

Your entries are used to track your computer at our service points.

**TOSHIBA Theft Registration**

Send to: TOSHIBA Europe GmbH  
Technical Service and Support  
Leibnizstr. 2  
93055 Regensburg  
Germany

Fax number: +49 (0) 941 7807 921

Country stolen:

Machine type:  
(e.g. mini NB300/  
NB305)

Model number:  
(e.g. PSA30EYXT)

--	--	--	--	--	--	--	--	--	--	--	--	--	--	--	--	--	--	--	--

Serial number:  
(e.g. 12345678G)

--	--	--	--	--	--	--	--	--	--

Date stolen:

Year

Month

Day

--	--	--	--

--	--

--	--

**Owner's details**

Last name, first name:

Company:

Street:

Postal Code/City:

Country:

Phone:

Fax:

# Glossary

The terms in this glossary cover topics related to this manual. Alternate naming is included for reference.

## *Abbreviations*

**AACS:** advanced access content system

**AC:** Alternating current

**ACPI:** Advanced Configuration and Power Interface

**ASCII:** American Standard Code for Information Interchange

**BIOS:** basic input/output system

**bps:** bits per second

**CD:** compact disc

**CD-ROM:** Compact Disc Read-Only Memory

**CD-RW:** Compact Disc-ReWritable

**CMOS:** complementary metal-oxide semiconductor

**CPU:** central processing unit

**CRT:** cathode ray tube

**DC:** direct current

**DDC:** display data channel

**DDR:** double data rate

**DIMM:** dual inline memory module

**DVD:** digital versatile disc

**DVD-R:** Digital Versatile Disc Recordable

**DVD-RAM:** Digital Versatile Disc Random Access Memory

**DVD-R (Dual Layer):** Digital Versatile Disc Recordable Dual Layer

**DVD-ROM:** Digital Versatile Disc Read Only Memory

**DVD-RW:** Digital Versatile Disc ReWritable

**DVD+R (Double Layer):** Digital Versatile Disc Recordable Double Layer

**FDD:** floppy diskette drive

**FHD:** Full High Definition

**FIR:** fast infrared

**GB:** gigabyte  
**HDD:** hard disk drive  
**HD+:** High Definition Plus  
**IDE:** integrated drive electronics  
**IEEE:** Institute of Electrical and Electronics Engineers  
**I/O:** input/output  
**IrDA:** Infrared Data Association  
**IRQ:** interrupt request  
**KB:** kilobyte  
**LAN:** local area network  
**LCD:** liquid crystal display  
**LED:** light emitting diode  
**MB:** megabyte  
**MMC:** multi media card  
**OCR:** optical character recognition (reader)  
**PCB:** printed circuit board  
**PCI:** peripheral component interconnect  
**RAM:** random access memory  
**RGB:** red, green, and blue  
**ROM:** read only memory  
**RTC:** real time clock  
**S/P DIF:** Sony/Philips Digital Interface Format  
**SDRAM:** synchronous dynamic random access memory  
**SLI:** Scalable Link Interface  
**SO-DIMM:** small-outline dual in line memory module  
**TFT:** thin-film transistor  
**UART:** universal asynchronous receiver/transmitter  
**USB:** Universal Serial Bus  
**VESA:** Video Electronic Standards Association  
**VGA:** video graphics array  
**XGA:** extended graphics array

## A

- adaptor:** A device that provides a compatible connection between two units. For example, the computer's internal display adapter receives information from the software and translates it into images on the screen. An adapter can take a number of forms, from a microprocessor to a simple connector: An intelligent adapter (one that is capable of doing some processing) may also be called a controller.
- alphanumeric:** Keyboard characters including letters, numbers and other symbols, such as punctuation marks or mathematical symbols.
- alternating current (AC):** Electric current that reverses its direction of flow at regular intervals.
- analog signal:** A signal whose characteristics such as amplitude and frequency vary in proportion to (are an analog of) the value to be transmitted. Voice communications are analog signals.
- application:** A group of programs that together are used for a specific task such as accounting, financial planning, spreadsheets, word processing and games.
- ASCII:** American Standard Code for Information Interchange. ASCII code is a set of 256 binary codes that represent the most commonly used letters, numbers, and symbols.
- asynchronous:** Lacking regular time relationship. As applied to computer communications, asynchronous refers to the method of transmitting data that does not require a steady stream of bits to be transmitted at regular time intervals.

## B

- backup:** A copy of a file, usually on a removable disk, kept in case the original file is lost or damaged.
- BIOS:** Basic Input/Output System. The firmware that controls data flow within the computer. *See also* firmware.
- binary:** The base two number system composed of zeros and ones (off or on), used by most digital computers. The right-most digit of a binary number has a value of 1, the next a value of 2, then 4, 8, 16, and so on. For example, the binary number 101 has a value of 5. *See also* ASCII.
- bit:** Derived from "binary digit," the basic unit of information used by the computer. It is either zero or one. Eight bits is one byte. *See also* byte.
- Bluetooth:** A short-range radio technology designed to simplify wireless communication among computers, communication devices and the Internet.
- board:** A circuit board. An internal card containing electronic components, called chips, which perform a specific function or increase the capabilities of the system.

- boot disk:** See system disk.
- boot:** Short for bootstrap. A program that starts or restarts the computer. The program reads instructions from a storage device into the computer's memory.
- bootable disk:** See system disk.
- bps:** Bits per second. Typically used to describe the data transmission speed of a modem.
- buffer:** The portion of the computer's memory where data is temporarily stored. Buffers often compensate for differences in the rate of flow from one device to another.
- bus:** An interface for transmission of signals, data or electric power.
- byte:** The representation of a single character. A sequence of eight bits treated as a single unit; also the smallest addressable unit within the system.

## C

- cache memory:** A section of very fast memory in which frequently used information is duplicated for quick access. Accessing data from cache is faster than accessing it from the computer's main memory. See *also* L1 cache, L2 cache.
- capacity:** The amount of data that can be stored on a magnetic storage device such as a floppy diskette or hard disk drive. It is usually described in terms of kilobytes (KB), where one KB = 1024 bytes, megabytes (MB), where one MB = 1024 KB and gigabytes (GB), where one GB = 1024 MB.
- CD-R:** A Compact Disc-Recordable disc can be written once and read many times. See *also* CD-ROM.
- CD-ROM:** A Compact Disc Read-Only Memory is a high capacity disc that can be read from but not written to. The CD-ROM drive uses a laser, rather than magnetic heads, to read data from the disc.
- CD-RW:** A Compact Disc-ReWritable disc can be rewritten many times. See *also* CD-ROM.
- CD:** An individual compact disc. See *also* CD-ROM.
- character:** Any letter, number, punctuation mark, or symbol used by the computer. Also synonymous with byte.
- chassis:** The frame containing the computer.
- chip:** A small semiconductor containing computer logic and circuitry for processing, memory, input/output functions and controlling other chips.
- click:** To press and release the pointing device's primary button without moving the pointing device. In the Windows® operating system, this refers to the pointing device's left button, unless otherwise stated. See *also* double-click.
- CMOS:** Complementary Metal-Oxide Semiconductor. An electronic circuit fabricated on a silicon wafer that requires very little power. Integrated circuits implemented in CMOS technology can be tightly packaged and are highly reliable.



- co-processor:** A circuit built into the processor that is dedicated to intensive math calculations.
- cold start:** Starting a computer that is currently off (turning on the power).
- COM1, COM2, COM3 and COM4:** The names assigned to the serial and communication ports.
- commands:** Instructions you enter at the terminal keyboard that direct the actions of the computer or its peripheral devices.
- compatibility:** 1) The ability of one computer to accept and process data in the same manner as another computer without modifying the data or the media upon which it is being transferred. 2) the ability of one device to connect to or communicate with another system or component.
- components:** Elements or parts (of a system) which make up the whole (system).
- Composite Video (YUV):** A standard video signal used to transmit images, e.g. from a VCR to a TV.
- computer program:** A set of instructions written for a computer that enable it to achieve a desired result.
- computer system:** A combination of hardware, software, firmware, and peripheral components assembled to process data into useful information.
- configuration:** The specific components in your system (such as the terminal, printer, and disk drives) and the settings that define how your system works. You use the BIOS Setup program to control your system configuration.
- controller:** Built-in hardware and software that controls the functions of a specific internal or peripheral device (e.g. keyboard controller).
- CPU:** Central Processing Unit. The portion of the computer that interprets and executes instructions.
- CRT:** Cathode Ray Tube. A vacuum tube in which beams projected on a fluorescent screen-producing luminous spots. An example is the television set.
- cursor:** A small, blinking rectangle or line that indicates the current position on the display screen.

## D

- data bits:** A data communications parameter controlling the number of bits (binary digits) used to make up a byte. If data bits = 7 the computer can generate 128 unique characters. If data bits = 8 the computer can generate 256 unique characters.
- data:** Information that is factual, measurable or statistical that a computer can process, store, or retrieve.
- DC:** Direct Current. Electric current that flows in one direction. This type of power is usually supplied by batteries.
- default:** The parameter value automatically selected by the system when you or the program do not provide instructions. Also called a preset value.

- delete:** To remove data from a disk or other data storage device. Synonymous with erase.
- device driver:** A program (called a "driver") that permits a computer to communicate with a device.
- dialog box:** A window that accepts user input to make system settings or record other information.
- Digital Audio:** An audio compression standard that enables high-quality transmission and real-time playback of sound files.
- disable:** To turn a computer option off. See *also* enable.
- disk drive:** The device that randomly accesses information on a disk and copies it to the computer's memory. It also writes data from memory to the disk. To accomplish these tasks, the unit physically rotates the disk at high speed past a read-write head.
- disk storage:** Storing data on magnetic disk. Data is arranged on concentric tracks much like a phonograph record.
- display:** A CRT, LCD, or other image producing device used to view computer output.
- documentation:** The set of manuals and/or other instructions written for the users of a computer system or application. Computer system documentation typically includes procedural and tutorial information as well as system functions.
- double click:** To press and release the pointing device's primary button rapidly twice without moving the pointing device. In the Windows® operating system, this refers to the pointing device's left button, unless otherwise stated.
- driver:** A software program, generally part of the operating system, that controls a specific piece of hardware (frequently a peripheral device such as a printer or mouse).
- DVB-T (Digital Video Broadcasting - Terrestrial):** Also known as terrestrial digital TV. Digital TV broadcasting standard.
- DVD-R (+R, -R):** A Digital Versatile Disc Recordable disc can be written once and read many times. The DVD-R drive uses a laser to read data from the disc.
- DVD-R (Dual Layer):** A disc having two layers on one side with the DVD-R storage capacity about 1.8 times larger than before. The DVD-RW drive uses a laser to read data from the disc.
- DVD-RAM:** A Digital Versatile Disc-Random Access Memory is a highcapacity, high performance disc that lets you store large volumes of data. The DVD-RAM drive uses a laser to read data from the disc.

**DVD-ROM:** A Digital Versatile Disc-Read Only Memory is a high capacity, high performance disc suitable for play back of video and other high-density files. The DVD-ROM drive uses a laser to read data from the disc.

**DVD-RW (+RW, -RW):** A Digital Versatile Disc-ReWritable disc can be rewritten many times.

**DVD:** An individual digital versatile (or video) disc. *See also* DVD-ROM.

**DVD+R (Double Layer):** A disc having two layers on one side with the DVD+R storage capacity about 1.8 times larger than before. The DVD-RW drive uses a laser to read data from the disc.

## E

**echo:** To send back a reflection of the transmitted data to the sending device. You can display the information on the screen, or output it to the printer, or both. When a computer receives back data it transmitted to a CRT (or other peripheral device) and then transmits the data to printer, the printer is said to echo the CRT.

**enable:** To turn on a computer option. *See also* disable.

**erase:** See delete.

**escape guard time:** A time before and after an escape code is sent to the modem which distinguishes between escapes that are part of the transmitted data, and escapes that are intended as a command to the modem.

**escape:** 1) A code (ASCII code 27), signaling the computer that what follows are commands; used with peripheral devices such as printers and modems. 2) A means of aborting the task currently in progress.

**execute:** To interpret and execute an instruction.

## F

**fast infrared:** An industry standard that enables cableless infrared serial data transfer at speeds of up to 4 Mbps.

**file:** A collection of related information; a file can contain data, programs, or both.

**fingerprint sensor:** The fingerprint sensor compares and analyzes the unique characteristics in a fingerprint.

**firmware:** A set of instructions built into the hardware which controls and directs a microprocessor's activities.

**flash memory:** Non-volatile memory that can be written to as well as read. Information in flash memory remains whether or not the computer is receiving power. This type of memory is used to retain your fingerprint data. *See also* memory. Compare RAM and ROM.

**floppy diskette drive (FDD):** An electromechanical device that reads and writes to floppy diskettes.

**floppy diskette:** A removable disk that stores magnetically encoded data.

**folder:** An icon in Windows used to store documents or other folders.

**format:** The process of readying a blank disk for its first use. Formatting establishes the structure of the disk that the operating system expects before it writes files or programs onto the disk.

**function keys:** The keys labeled **F1** through **F9** that tell the computer to perform certain functions.

## G

**gigabyte (GB):** A unit of data storage equal to 1024 megabytes. *See also* megabyte.

**graphics:** Drawings, pictures, or other images, such as charts or graphs, to present information.

## H

**hard disk drive (HDD):** An electromechanical device that reads and writes a hard disk. *See also* hard disk.

**hard disk:** A storage device composed of a rigid platter or platters that can be magnetically coded with data. Hard disks hold much more information than diskettes and are used for long-term storage of programs and data. The primary (or only) hard disk in a computer is usually fixed, but some computers have secondary hard disks that are removable. By default, the hard disk is referred to as drive C.

**hardware:** The physical electronic and mechanical components of a computer system: typically, the computer itself, external disk drives, etc. *See also* software and firmware.

**hertz:** A unit of wave frequency that equals one cycle per second.

**host computer:** The computer that controls, regulates, and transmits information to a device or another computer.

**hot key:** The computer's feature in which certain keys in combination with the extended function key, **FN**, can be used to set system parameters, such as speaker volume.

## I

**I/O devices:** Equipment used to communicate with the computer and transfer data to and from it.

**I/O:** Input/output. Refers to acceptance and transfer of data to and from a computer.

**IrDA 1.1:** An industry standard that enables cableless infrared serial data transfer at speeds of up to 4 Mbps.

**i.LINK (IEEE1394):** This port enables high-speed data transfer directly from external devices such as digital video cameras.

**icon:** A small graphic image displayed on the screen or in the indicator panel. In Windows, an icon represents an object that the user can manipulate.

**input:** The data or instructions you provide to a computer, communication device or other peripheral device from the keyboard or external or internal storage devices. The data sent (or output) by the sending computer is input for the receiving computer.

**instruction:** Statements or commands that specify how to perform a particular task.

**interface:** 1) Hardware and/or software components of a system used specifically to connect one system or device to another. 2) To physically connect one system or device to another to exchange information. 3) The point of contact between user, the computer, and the program, for example, the keyboard or a menu.

**interrupt request:** A signal that gives a component access to the processor.

## K

**K:** Taken from the Greek word kilo, meaning 1000; often used as equivalent to 1024, or 2 raised to the 10th power. *See also* byte and kilobyte.

**keyboard:** An input device containing switches that are activated by manually pressing marked keys. Each keystroke activates a switch that transmits a specific code to the computer. For each key, the transmitted code is, in turn, representative of the (ASCII) character marked on the key.

**kilobyte (KB):** A unit of data storage equal to 1024 bytes. *See also* byte and megabyte.

## L

**L1 cache:** Level one cache. Memory cache built into the processor to help improve processing speed. *See also* cache memory, L2 cache.

**L2 cache:** Memory cache installed on the motherboard to help improve processing speed. It is slower than L1 cache and faster than main memory. *See also* cache memory, L1 cache.

**LAN:** A group of computers or other devices dispersed over a relatively limited area and connected by a communications link that enables any device to interact with any other on the network.

**Light Emitting Diode (LED):** A semiconductor device that emits light when a current is applied.

**Liquid Crystal Display (LCD):** Liquid crystal sealed between two sheets of glass coated with transparent conducting material. The viewingside coating is etched into character forming segments with leads that extend to the edge of the glass. Applying a voltage between the glass sheets alters the brightness of the liquid crystal.

## M

**main board:** See motherboard.

**megabyte (MB):** A unit of data storage equal to 1024 kilobytes. *See also* kilobyte.

**megahertz:** A unit of wave frequency that equals 1 million cycles per second. *See also* hertz.

Memory can be volatile and hold data temporarily, such as RAM, or it can be nonvolatile and hold data permanently, such as ROM. A computer's main memory is RAM. *See* RAM, ROM.

**memory:** Typically refers to the computer's main memory, where programs are run and data is temporarily stored and processed.

**menu:** A software interface that displays a list of options on the screen. Also called a screen.

**microprocessor:** A hardware component contained in a single integrated circuit that carries out instructions. Also called the central processing unit (CPU), one of the main parts of the computer.

**mode:** A method of operation, for example, the Shut Down Mode, Sleep Mode or the Hibernation Mode.

**modem:** Derived from modulator/demodulator, a device that converts (modulates) digital data for transmission over telephone lines and then converts modulated data (demodulates) to digital format where received.

**monitor:** A device that uses rows and columns of pixels to display alphanumeric characters or graphic images. *See also* CRT.

**motherboard:** A name sometimes used to refer to the main printed circuit board in processing equipment. It usually contains integrated circuits that perform the processor's basic functions and provides connectors for adding other boards that perform special functions.

**MP3:** An audio compression standard that enables high-quality transmission and real-time playback of sound files.

## N

**network:** A collection of computers and associated devices that are connected by communications facilities. A network allows you to share data and peripheral devices, such as printers, with other users and to exchange electronic mail.

**non-system disk:** A disk for storing programs and data that cannot be used to start the computer. Compare system disk.

**nonvolatile memory:** Memory, usually read-only (ROM), that is capable of permanently storing information. Turning the computer's power off does not alter data stored in nonvolatile memory.

**numeric keypad overlay:** A feature that allows you to use certain keys on the keyboard to perform numeric entry, or to control cursor and page movement.

## O

**OCR:** Optical Character Recognition (reader). A technique or device that uses laser or visible light to identify characters and input them into a storage device.

**online state:** A functional state of a peripheral device when it is ready to receive or transmit data.

**operating system:** A group of programs that controls the basic operation of a computer. Operating system functions include interpreting programs, creating data files, and controlling the transmission and receipt (input/output) of data to and from memory and peripheral device.

**output:** The results of a computer operation. Output commonly indicates data. 1) printed on paper, 2) displayed at a terminal, 3) sent through the serial port of internal modem, or 4) stored on some magnetic media.

## P

**PAL:** PAL (Phase Alternating Line) is the dominant video and broadcasting standard in Europe.

**parity:** 1) The symmetrical relationship between two parameter values (integers) both of which are either on or off; odd or even; 0 or 1. 2) In serial communications, an error detection bit that is added to a group of data bits making the sum of the bits even or odd. Parity can be set to none, odd, or even.

**password:** A unique string of characters used to identify a specific user. The computer provides various levels of password protection such as user and supervisor.

**PCI:** Peripheral Component Interconnect. An industry standard 32-bit bus.

**peripheral:** Any device, such as a printer or joystick, that is attached to the computer and controlled by the computer's CPU.

**Péritel:** Péritel is a 21-pin connecting cable/port system that allows images and high-quality stereo sound (including Dolby® Pro-Logic sound formats) to be sent from one audio-visual device to another. It is also known as a "SCART connector" or "Euro connector".

**pixel:** A picture element. The smallest dot that can be made on a display or printer. Also called a pel.

**plug and play:** A capability with Windows that enables the system to automatically recognize connections of external devices and make the necessary configurations in the computer.

**pointing device:** Any device, such as the Touch Pad or a mouse, that enables you to move the cursor on the screen.

**port:** The electrical connection through which the computer sends and receives data to and from devices or other computers.

**Power Saver:** A TOSHIBA utility that lets you set the parameters for various power-saving functions.

**program:** A set of instructions a computer can execute that enables it to achieve a desired result. *See also* application.

**prompt:** A message the computer provides indicating it is ready for or requires information or an action from you.

## R

**Radio frequency interference (RFI) shield:** A metal shield enclosing the printed circuit boards of the printer or computer to prevent radio and TV interference. All computer equipment generates radio frequency signals. The FCC regulates the amount of signals a computing device can allow past its shielding. A Class A device is sufficient for office use. Class B provides a more stringent classification for home equipment use. TOSHIBA portable computers comply with Class B computing device regulations.

**Random Access Memory (RAM):** Volatile memory that can be written to as well as read. Volatile here means that information in RAM is lost when you turn off your computer. This type of memory is used for your computer's main memory. *See also* memory. Compare ROM.

**Read Only Memory (ROM):** Non-volatile memory that can be read but not written to. Non-volatile here means that information in ROM remains whether or not the computer is receiving power. This type of memory is used to store your computer's BIOS, which is essential instructions the computer reads when you start it up. *See also* BIOS, memory. Compare RAM.

**resolution:** A measure of the sharpness of the images that can be produced by a printer or displayed on a screen. For a printer, resolution is expressed in dots per inch (dpi). For a screen, it is expressed as the number of pixels available horizontally and vertically

**restart:** Resetting a computer without turning it off (also called "warm boot", "soft reset" or "reboot"). *See also* boot.

**RGB:** Red, green and blue. A device that uses three input signals, each activating an electron gun for a primary additive color (red, green and blue) or port for using such a device. *See also* CRT.

**RJ11:** A modular telephone jack.

**RJ45:** A modular LAN jack.

## S

**S/P DIF:** A standard of digital interface for audio.

**SCSI:** Small Computer System Interface is an industry standard interface for connection of a variety of peripheral devices.

**SD/SDHC memory card:** Secure Digital cards are flash memory widely used in a variety of digital devices such as digital cameras and Personal Digital Assistants.

**SECAM L:** SECAM (Sequential Color Memory) is a broadcasting standard used in France.



- SIO:** Serial Input/Output. The electronic methodology used in serial data transmission.
- soft key:** Key combinations that emulate keys on the IBM keyboard, change some configuration options, stop program execution, and access the numeric keypad overlay.
- software:** The set of programs, procedures and related documentation associated with a computer system. Specifically refers to computer programs that direct and control the computer system's activities. *See also* hardware.
- stop bit:** One or more bits of a byte that follow the transmitted character or group codes in asynchronous serial communications.
- synchronous:** Having a constant time interval between successive bits, characters or events.
- system disk:** A diskette that contains the operating system files needed to start the computer. Any diskette can be formatted as a system disk. A system disk is also called a "bootable disk", "boot disk" or a "startup disk." Compare non-system disk.

## T

- terminal:** A typewriter-like keyboard and CRT display screen connected to the computer for data input/output.
- TFT display:** A liquid crystal display (LCD) made from an array of liquid crystal cells using active-matrix technology with thin film transistor (TFT) to drive each cell.
- Touch Pad:** A pointing device integrated into the TOSHIBA computer palm rest.

## U

- USB:** Universal Serial Bus. This serial interface lets you communicate with several devices connected in a chain to a single port on the computer.

## V

- VGA:** Video Graphics Array is an industry standard video adaptor that lets you run any popular software.
- volatile memory:** Random access memory (RAM) that stores information as long as power is supplied to the computer.

## W

**warm start:** Restarting or resetting a computer without turning it off.

**Wi-Fi®:** A registered trademark term of the Wi-Fi Alliance that stands for Wireless Fidelity, and is another term for the communication protocol to permit an Ethernet connection using wireless communication components.

**window:** A portion of the screen that can display its own application, document or dialog box. Often used to mean a Microsoft Windows window.

**Wireless LAN:** Local Area Network (LAN) through wireless communication.

**write protection:** A method for protecting a floppy diskette from accidental erasure.

# Index

## A

- AC adaptor, 1-4
  - additional, 1-10
  - connecting, 3-2
  - DC IN 19V jack, 2-5
- ASCII characters, 5-7

## B

- Battery
  - charging, 6-5
  - extending battery life, 6-8
  - indicator, 2-2, 6-2
  - Monitoring capacity, 6-7
  - real time clock, 1-4, 6-4
  - save mode, 1-7
  - types, 6-3
- Battery Charger, 8-7
- Battery pack, 1-3, 2-6
  - additional, 8-7
  - replacing, 6-9
- Bluetooth, 1-5, 4-9
  - problems, 9-13
- Bridge media slot, 1-4, 2-4, 8-2
  - indicator, 2-2
  - using, 8-2

## C

- Cache memory, 1-2
- Cleaning the computer, 4-16
- Cooling vents, 2-3, 2-6

## D

- DC IN indicator, 2-1, 6-3
- Display, 2-7
  - brightness (down), 5-4
  - brightness (up), 5-4
  - controller, B-1
  - opening, 3-4
- Documentation list, 1-2

## E

- Enable/Disable Wireless communication with hot key, 4-10
- Equipment checklist, 1-1
- External monitor, 1-4, 2-3, 8-8

## F

- FN + 1 (TOSHIBA Zooming Utility reduce), 5-5
- FN + 2 (TOSHIBA Zooming Utility enlarge), 5-5
- FN + ENTER, 5-3
- FN + ESC (Mute), 5-3
- FN + F1 (Lock), 5-3
- FN + F10 (Arrow mode), 5-6
- FN + F11 (Numeric mode), 5-6
- FN + F12 (ScrLock), 5-3
- FN + F2 (Power Plan), 5-3
- FN + F3 (Sleep), 5-3
- FN + F4 (Hibernate), 5-4
- FN + F5 (Output), 5-4
- FN + F6 (Brightness Down), 5-4

FN + F7 (Brightness Up), 5-4  
FN + F8 (Wireless), 5-4  
FN + F9 (Touch Pad), 5-4  
FN + space (Zoom), 5-4  
Function keys, 5-2

## H

Hard disk drive  
    automatic power off, 1-6  
Heat dispersal, 1-7  
Hibernation Mode, 1-8  
Hot keys, 1-6  
    Brightness (Down), 5-4  
    Brightness (Up), 5-4  
    Hibernate, 5-4  
    Lock, 5-3  
    Mute, 5-3  
    Output, 5-4  
    Power Plan, 5-3  
    Sleep, 5-3  
    TOSHIBA Zooming Utility  
        (enlarge), 5-5  
    TOSHIBA Zooming Utility  
        (reduce), 5-5  
    Touch Pad, 5-4  
    Wireless, 5-4  
    Zoom, 5-4  
HW Setup  
    accessing, 7-1  
    general, 7-1

## I

Indicators  
    Battery, 2-2, 6-2  
    DC IN, 2-1  
    HDD/ODD/eSATA, 2-2  
    Power, 2-2

## K

Keyboard, 1-4, 5-1  
    emulating keys on  
        enhanced, 5-2  
    FN Sticky key, 5-5

Function keys F1 ... F12,  
    5-2

Hot keys, 5-3

problems, 9-6

Typewriter keys, 5-1

Windows special keys, 5-5

Keypad overlay, 1-7, 5-6

    arrow mode, 5-6

    numeric mode, 5-6

    temporarily using normal  
        keyboard (overlay  
        on), 5-7

    temporarily using overlay  
        (overlay off), 5-7

    turning on the overlays, 5-6

## L

LAN, 1-5, 4-15

    cable types, 4-15

    connecting, 4-15

    disconnecting, 4-16

    jack, 2-3

## M

Memory, 1-2

    installing, 8-4

    kit, 1-10

    removing, 8-7

Modem

    problems, 9-12

Monitor

    automatic power off, 1-6

Moving the computer, 4-17

## P

Password

    power on, 1-7

    problems, 9-6

Pointing device

    Touch Pad, 2-8, 4-1

Ports, 1-4

    External monitor, 1-4

    USB, 1-4

- Power
    - conditions, 6-1
    - Hibernation Mode, 3-7
    - indicator, 6-3
    - panel power on/off, 6-14
    - Shut Down mode (Boot Mode), 3-7
    - Sleep Mode, 3-9
    - system auto off, 6-14
    - turning off, 3-7
    - turning on, 3-5
  - Problems
    - AC power, 9-4
    - Analyzing the problem, 9-2
    - Battery, 9-5
    - Bluetooth, 9-13
    - Hard disk drive, 9-7
    - Hardware and system checklist, 9-3
    - Keyboard, 9-6
    - LAN, 9-12
    - Memory Stick/Memory Stick PRO/Memory Stick PRO Duo, 9-9
    - Overheating power down, 9-4
    - Password, 9-6
    - Power, 9-4
    - SD/SDHC memory card, miniSD/microSD Card, 9-9
    - Self test, 9-3
    - Sound system, 9-9
    - System start-up, 9-3
    - TOSHIBA support, 9-13
    - Touch Pad, 9-7
    - USB mouse, 9-8
    - Wireless LAN, 9-13
  - Processor, 1-2
- R**
- Recovery hard disk drive, 3-13
  - Recovery Media, 3-13
  - Restarting the computer, 3-10
- S**
- Security lock
    - attaching, 8-9
  - Sleep Mode, 1-8
    - setting, 3-9
    - System automatic, 1-6
  - Soft keys
    - emulating keys on
      - enhanced keyboard, 5-2
    - ENTER, 5-3
    - ScrLock, 5-3
  - Sound system, 1-4
    - Headphone (S/PDIF) jack, 1-5, 2-4
    - microphone, 2-8
    - microphone jack, 1-5, 2-4
- T**
- TOSHIBA ConfigFree, 1-9
  - TOSHIBA Disc Creator, 1-9, 4-4
  - TOSHIBA support, 9-13
  - TOSHIBA Theft Registration, F-2
  - Touch Pad, 1-3
    - using, 4-1
- U**
- USB device, 1-4
  - USB floppy diskette drive, 8-7
- V**
- Video RAM, 1-2
- W**
- Web Camera, 1-4
  - Wireless communication, 4-8
    - indicator, 4-10
  - Wireless LAN, 1-5, 4-8