

PENTAX[®]

PZ-70

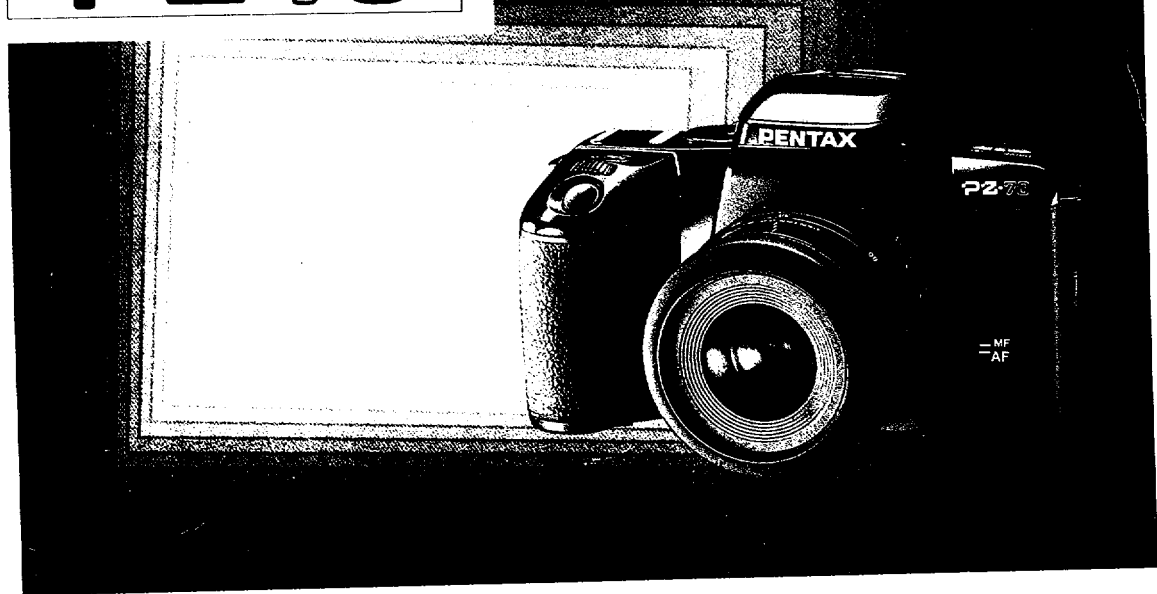

Congratulations on your purchase of this camera and welcome to the exciting world of Pentax autofocus photography! This camera is an autofocus SLR camera that offers higher levels of sophistication and performance. Incorporating a broad range of advanced technologies and highly accurate automation, this camera will perform superbly for the most exacting photographer.

Notes:

- The product pictured on the front cover shows the PZ-70 with the Pentax-F Zoom 35-80mm lens.
- Illustrations of this camera used in this manual show the camera with the Pentax-FA Power Zoom 28-80mm lens. When the PZ-70 is combined with an F Zoom lens, certain features such as Power Zooming and Auto Zooming functions are not available.

Read this instruction manual carefully to get a full explanation for operations before use.

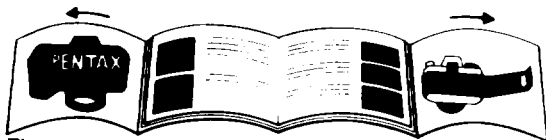

The names of the camera's working parts are listed on the front and back flaps in this operating manual. Keep the flaps unfolded for quick reference while reading this manual.

Icon indicators used in this manual

Operation direction	←
Automatic operation	←---→
Attention	⊙
Lamp blinking	☀
Correct	○
Incorrect	×

Lenses and accessories produced by other manufacturers are not made to our precise specifications and therefore, may cause difficulties with or actual damage to your Pentax camera. We do not assume any responsibility or liability for difficulties resulting from the use of lenses and accessories made by other manufacturers.

NAMES OF WORKING PARTS

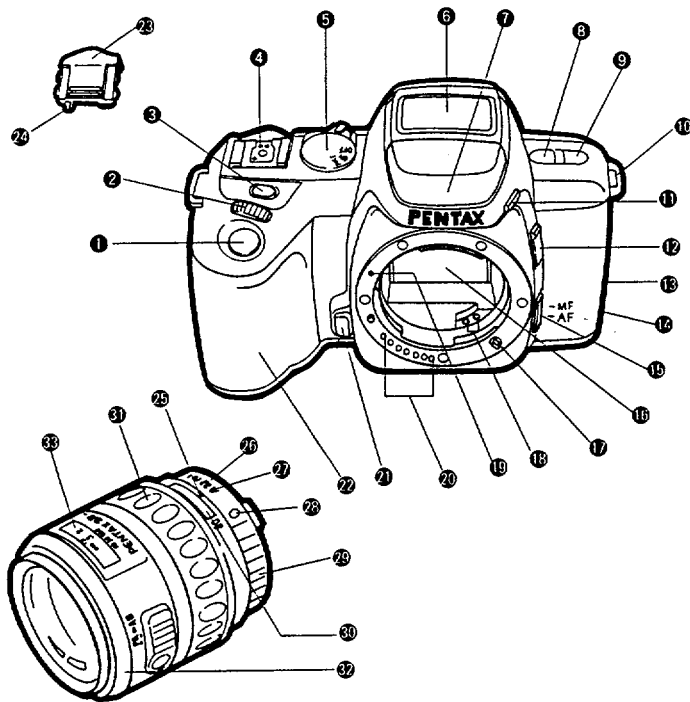

- ❶ Shutter release button
- ❷ Select dial
- ❸ Tv / Av button
- ❹ Hot shoe
- ❺ Main switch (p.18)
- ❻ LCD panel (p.6)
- ❼ Built-in flash (p.35)
- ❽ Red-eye reduction button (p.37)
- ❾ Drive button (p.64)
- ❿ Strap lug (p.13)
- ⓫ Flash pop-up button (p.35)
- ⓬ Release socket cap Fr (p.61)
- ⓭ Back cover release lever (p.19)
- ⓮ Auxiliary rewind button (p.23)
- ⓯ Focus mode switch (p.31)
- ⓰ Mirror
- ⓱ AF coupler
- ⓲ Power supply contacts
- ⓳ Lens mount index (p.16)
- ⓴ Lens information contacts
- ⓵ Lens lock button (p.17)
- ⓶ Hand grip
- ⓷ Hot shoe cover Fr (p.72)
- ⓸ Projection for rewinding film in mid. roll
- ⓹ Aperture / zoom index
- ⓺ Aperture scale
- ⓻ Aperture-A index (p.25)
- ⓼ Aperture-A lock button (p.25)
- ⓽ Aperture ring (p.25)
- ⓿ Zoom scale window (p.27)
- ⓫ Power zoom ring (p.28)
- ⓬ Focusing ring (p.43)
- ⓭ Distance scale ring window

PRECAUTIONS FOR YOUR CAMERA

Your Pentax camera is a high-precision mechanism. Handle it with great care.

Precautions when taking pictures

- Do not use the camera in a place where the camera may come in contact with rain or water because the camera is not weather resistant. Should the camera get wet from rain or splashing water, wipe it off immediately with a dry soft cloth.
- Do not drop the camera or allow it to hit a solid object. If the camera suffers a severe shock or impact, take it to a Pentax service center for inspection.
- Be careful not to subject it to strong vibrations, shock or pressure. Use a cushion to protect the camera when carrying it in a motorcycle, car, boat, etc.
- Condensation on the interior or exterior of the camera may be extremely harmful to the camera mechanism as it may cause rust. Furthermore, if the camera is taken from warm temperature to a sub-freezing one or vice versa, the formation of icelets may cause damage. In such a case, put the camera into a case or plastic bag so that any changes in temperature difference is minimized, take it out of the bag after the temperature has stabilized.

- Regular size color prints may cut off what appears on the extreme edges of the film frame. Compose your picture with margin of safety at the edges.
- When a macro or telephoto lens is used, the upper portion of the viewfinder may be darkened by the mirror. This darkening, however, does not appear on the developed photograph.

Precautions for storage

- Avoid leaving the camera for extended periods in places where the humidity and temperature are very high such as in a car.
- Do not store the camera in a closet with mothballs or in an area where chemicals are handled. Store it in a place with good air circulation to prevent the growth of fungus.

Precautions for taking care

- Never touch the shutter curtain or mirror with your finger or any other object.
- The electric circuit inside the camera contains high voltage working parts. Never attempt to disassemble it.
- Use a blower and lens brush to remove dust accumulated on the lens or viewfinder.
- Never use solvents such as paint thinner, alcohol or benzene to clean the camera.
- Electrical problems may often be caused by water, dirt or dust at points of electrical contact. Also check for battery leakage, traces of dirt or grease, or corrosion due to salinity or gas. If you cannot correct the problems, have your camera inspected at a Pentax service center. Repairs of this nature are not covered under the terms of the warranty and charges may be assessed.

Other precautions

- Temperature range at which this camera functions properly is 50°C to -10°C (122°F to 14°F).
- A camera which has been submerged in water cannot usually be repaired, if such an accident should occur, it is advisable to contact a Pentax Service Center immediately.

- To maintain optimum performance, it is recommended that the camera be inspected every one or two years. If the camera has not been used for an extended period, or is being prepared for an important photographic session, it is recommended that you have the camera inspected or test shoot with it.
- Repair made necessary due to usage of this product in an industrial or commercial application may not be covered under the term of the Pentax warranty.
- Repairs made necessary due to the camera being subjected to any of the conditions warned about in this precautions section, or any other precaution or warning throughout this instruction manual, are not covered under the terms of the warranty and charges may be assessed.

LCD : Liquid-Crystal Display

When the LCD is exposed to high temperatures over about 60°C, it may blacken, but when the temperature normalizes, it may return to normal.

PRECAUTIONS FOR BATTERY

- Use one 6V lithium battery (2CR5 type).
- Misuse of a battery can cause hazards such as leakage, overheating, explosions, etc. The battery should be inserted with the “-” and “+” sides facing correctly.
- Never try to disassemble, short or recharge the battery. Also, do not dispose the battery in fire, as it may explode.
- Battery performance may be temporarily hindered in low temperatures, but will recover in normal temperatures.
- Keep a spare battery on hand for replacement convenience when shooting outdoors or while traveling.
- If the built-in flash is used continuously, the battery may become warm, but it does not mean that the battery is faulty; it is one of the battery's characteristics.

Battery Life Using 24-exposure film rolls

General existing light photography	about 100 rolls
Flash photography (using flash 50% of the time)	about 25 rolls
Flash photography (using flash 100% of the time)	about 15 rolls
Bulb exposure time	about 12 hours

The 2CR5 battery was used under Pentax testing conditions. Actual battery life/performance may vary drastically depending on usage of Autofocus, Power zoom and external conditions such as temperature and freshness of the battery.

PRACTICAL SHOOTING GUIDE



Focusing

- Taking a picture when the main subject is not in the Autofocus frame.p.34
- Changing the in-focus range.p.54



Flash photography

- Taking a picture in low light situations.p.35
- Minimizing the red-eye effect.p.37
- Taking a portrait picture whose face is cast in shadow.p.70
- Taking a picture of people with night scenery in the background.p.71
- Taking a picture in a roomy place such as a church or wedding party place.p.72



Zooming the lens

- Making a subject larger or smaller.p.27



Exposure modes

- Taking a picture with your desired exposure setting.p.57,62
- Taking a picture of people in a backlit situation with shadow on the face.p.70



Taking pictures of people in various situations

- Taking a portrait photograph.p.39
- Taking a group photograph.p.39
- Putting yourself into a picture.p.64
- Taking a picture of people in a backlit situation with shadow on the face.p.70
- Taking a picture of people with night scenery in the background.p.71



Landscape photography

- Taking a scenic photograph that focuses from the foreground to the background.p.40
- Taking a picture of night scenery.p.60
- Taking a picture of people with night scenery.p.71



Others

- Taking a picture of a fast moving subject.p.41,52
- Taking consecutive pictures of a moving subject.p.64

TABLE OF CONTENTS

LCD panel indication	6	II. BASIC OPERATION (SHOOTING) ...	24 - 42
Viewfinder indication	7	Using the Green Operation Mode	24
Easy to use!	8	Selecting a Drive Mode	26
Camera and lens mount	10	Using the power zoom function	28
Camera functions available with various lenses	11	Holding the camera	30
How to use this operating manual	12	Selecting a Focus Mode	31
I. BASIC OPERATION (PREPARATION) 13 - 23		Autofocusing	32
Attaching the camera strap	13	Focus Lock Function	34
Loading the battery /	14	Using the Built-In-TTL Flash (RTF)	35
When the battery is exhausted	15	Red-eye Reduction Flash Function	37
Attaching the lens	16	Using the Picture Mode	38
Using the shutter release button	18	• Portrait Program Mode	39
Main switch operation	18	• Landscape Program Mode	40
Film loading	19	• Action Program Mode	41
Unloading the film	22	• Close-up Program Mode	42

III. ADVANCED OPERATION	43 - 82
Manual focusing	43
Hard-To-Autofocus Subjects	45
Selecting an Exposure Mode	48
• Programmed AE Mode	50
• Program-Shift in the Program AE Mode	51
• Shutter-Priority AE Mode	52
• Manual Exposure Mode	57
• Bulb Exposure Mode	60
About Exposure Compensation	62
Selecting a Drive Mode	63
• Using the Consecutive Shooting Mode	64
• Using the Self-Timer Mode	64
Turning off the audible PCV signal	66
Using the Built-In-Flash (RTF)	67
• Compatibility of F and FA lenses with the Built-In Flash	69

• Taking a daylight-sync flash picture	70
• Taking a slow-shutter-sync flash picture	71
A Pentax Dedicated External Flash	72
• Contrast-Control Flash Photography	75

ACCESSORIES	76
Soft case F _c	78
Effects of aperture and shutter speed	79
Depth of field	81
About the infrared index	82

IV. OTHERS	83 - 91
Troubleshooting	84
Specifications	86
Program line	88
Warranty policy	90

LCD PANEL INDICATION

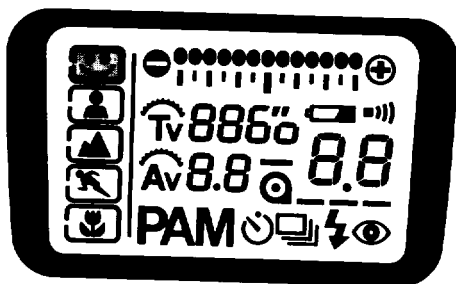

- | | | | |
|---|---|--|---|
| P | : Programmed AE (p.50) | | : Bar Graph (p.57,62) |
| A | : Shutter-Priority / Aperture-Priority AE (p.52,54) | | : T.(shutter speed) Indication |
| | : A. (aperture) Indication | | : Red-Eye Reduction Flash Indication (p.37) |
| M | : Manual Exposure (p.57) | | : Consecutive Shooting (p.64) |
| | : Shutter Speed Indication | | : Single-Frame Mode (p.63) |
| | : Aperture Indication | | : Self-Timer Shooting (p.64) |
| | : Green Operation Mode (p.24) | | : Flash Information (p.35) |
| | : Portrait Program Mode (p.39) | | : Frame Counter / Exposure Compensation (p.21,62) |
| | : Landscape Program Mode (p.40) | | : Film Status Information (p.21) |
| | : Action Program Mode (p.41) | | : Battery Exhaustion Warning (p.15) |
| | : Close-Up Program Mode (p.42) | | : Audible PCV Signal (p.66) |

VIEWFINDER INDICATION

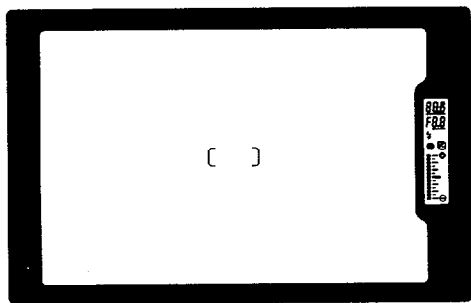

- [] : Autofocus (AF) Frame (p.32)
- 2000 : Tv Value (Shutter speed)
- F3.2 : Aperture Value
- ⚡ : Flash Status Information (p.35)
- ⬡ : In-Focus Indicator (p.32)
- ☑ : Exposure Compensation (p.62)
- 0 10 20 30 40 50 60 70 80 90 100 : Bar Graph (p.57,62)

EASY TO USE (For beginners)

1. Loading the battery

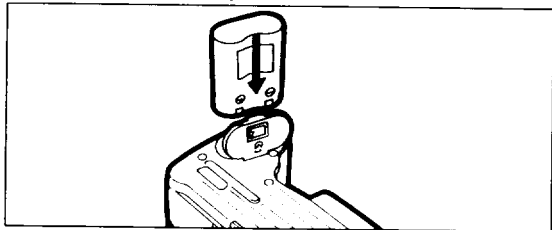

Load the battery [2CR5] according to the markings (+, -) on the battery chamber cover. (See page 14.)

2. Attaching the lens

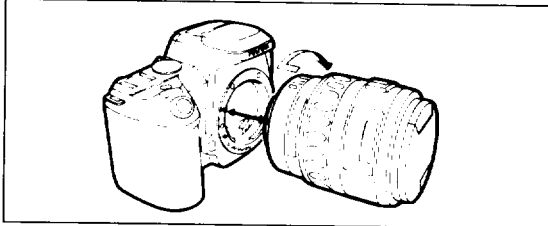

Align the red indexes on the lens and camera. Turn the lens to the right until it seats with a click. (See page 16.)

3. Positioning the aperture ring

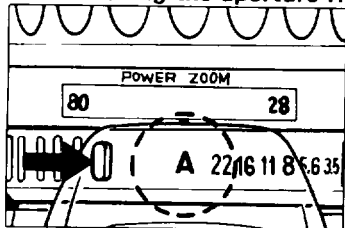

While holding down the aperture-A-lock button, turn the lens aperture ring to the [A] position. (See page 25.)

4. Setting the Green Operation Mode

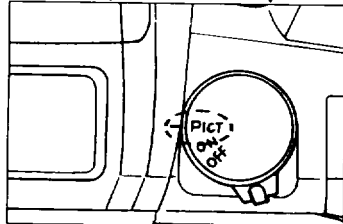

Set the camera's main switch to the [PICT] position. (See page 25.)

5. Loading film

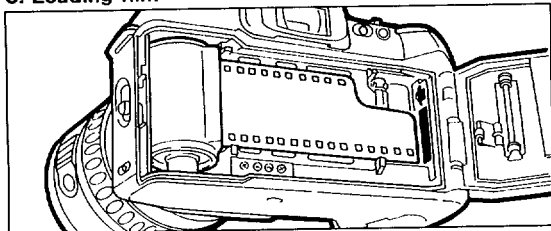

Open the back cover, insert a roll of film, align the end of the film leader with the red mark, and close the back cover. The film should advance to the first frame automatically. (See page 20.)

7. Composing the scene with the zoom ring

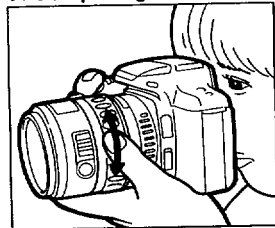

- When an FA zoom lens is attached, the power zoom function can operate.

While looking through the viewfinder, turn the zoom ring to the right or left until you obtain the desired composition. (See page 27.)

6. Selecting the Autofocus Mode

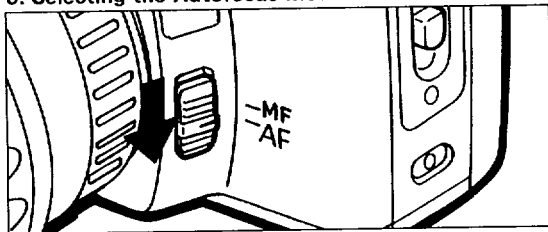

Set the focus mode switch to [AF]. (See page 31.)

8. Focus on the subject and shoot

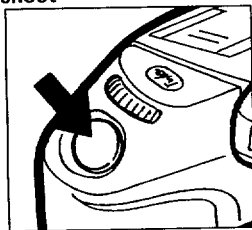

Center the AF frame [C] on the subject, depress the shutter release button halfway down to lock focus, and then depress it fully to take a photo. (See page 32.)

CAMERAS AND LENS MOUNTS

Lens Mount and Camera Body Compatibility Chart

Mount Type	Lens Type	Camera Model
(A) K_{AF2} -mount	Pentax-FA lens	Z-70/PZ-70,Z-1 _P /PZ-1 _P ,Z-1/PZ-1, Z-10/PZ-10,Z-20/PZ-20
(B) K_{AF} -mount	Pentax-F lens	SFX _N /SF1 _N , SF7/SF10, SFX/SF-1
(C) K_A mount	Pentax-A lens	Super-A / Super Program, P30 _N / P3 _N ,P30 _r
(D) K-mount	Pentax-M lens and Pentax lens	LX,K1000
(E) Screw mount	SMC TAKUMAR lens	ESII,SP

(A) through (D): basically K-mount (bayonet) lenses.

(A) and (B): autofocus lenses.

(C) through (E): non-AF (manual-focus) lenses.

(E): A screw mount lens can be fitted to the camera (A) through (D) with the optional Pentax "Mount Adapter K".

(A) through (C): have "A"(auto) position on the lens aperture ring.

Pentax FA lenses incorporate new contacts to exchange information between the camera and lens for power zoom. Pentax FA lenses operate on existing K-mount cameras. Pentax FA lenses incorporate new contacts as follows:

- Power supply contacts
- AF coupler
- Lens-information contacts

K Mount Lens Compatibility Chart

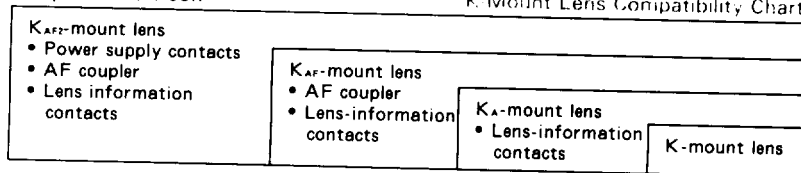

CAMERA FUNCTIONS AVAILABLE WITH VARIOUS LENSES

Function	Lens [Mount type]	FA lens [K _{AF2}]	F lens [K _{AF}]	A lens [K _A]	M lens [K]	S lens [Screw]
Autofocus (Lens only) (Lens with AF Adapter 1.7X)		○	○	×	×	×
		-	-	○*1	○*1	×
Manual focus (with FI) *2 (with Matte field)		○*3	○*3	○*3	○*3	×
		○	○	○	○	○
Power zoom		○*4	×	×	×	×
Programmed AE		○	○*5	○	×	×
Aperture-Priority AE		○	○	○	○*6	○*6
Shutter-Priority AE		○	○*5	○	×	×
Manual Exposure		○	○	○	○*6	○*6
Programmed TTL Auto Flash		○	○	○	×	×
TTL Auto Flash		○	○	○	○	○
Picture Mode		○	○	○	×	×
Multi(2)-segment metering		○	○	○	×	×
Approx. f-stop indication		○	○	×	×	×

Notes:

- * 1. Lenses with a maximum aperture of $f/2.8$ or larger. (See AF Adapter operating manual.)
- * 2. Manual focusing using the focus indicator (FI) [○] in the viewfinder.
- * 3. Lenses with a maximum aperture of $f/5.6$ or larger.
- * 4. Pentax-FA zoom lenses only.
- * 5. Exception of Pentax-F Soft 85mm/ $f2.8$.
- * 6. Lenses without the (A) position, the aperture cannot be set with the select dial.
- * 7. Only the center-weighted metering system can be used.

HOW TO USE THIS OPERATING MANUAL

This manual is organized into the following sections, allowing you to optimize the use of the camera:



**I . BASIC OPERATION
(PREPARATION) Page 13 - 23**



**III . ADVANCED OPERATIONS
Page 43 - 82**



**II . BASIC OPERATION
(SHOOTING) Page 24 - 42**



**IV . OTHER INFORMATION
Page 83 - 91**

- If you want to begin taking pictures with this new camera as soon as possible, read section I and II, "BASIC OPERATION (PREPARATION)" and "BASIC OPERATION (SHOOTING)."
These sections introduce only the basic functions of this camera. The details can be found in the section III and the section IV.

I . BASIC OPERATION (PREPARATION)

(1) ATTACHING THE CAMERA STRAP

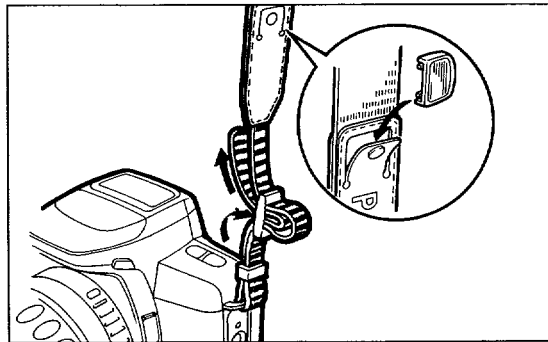

Fit the strap on the camera as illustrated.

- There is a pocket on the strap so you can store the finder cap, release socket cover or any other small accessory as illustrated.

(2) LOADING THE BATTERY

1

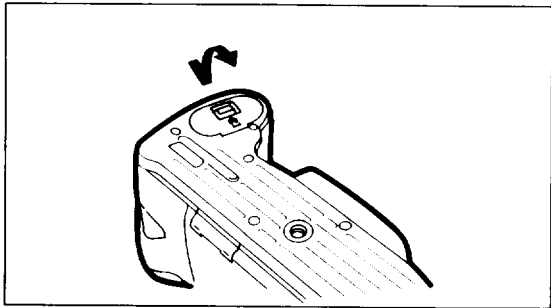

1. Open the battery chamber cover by sliding the release lever in the direction of the arrow.

- Use one 6V lithium battery [2CR5] or equivalent.

2

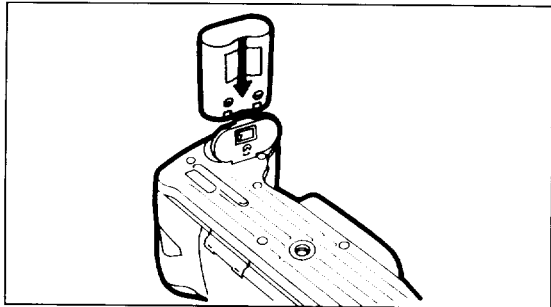

2. Load the battery according to the markings (-, +) at the bottom side of the battery chamber cover.

- When the battery is replaced, all camera settings except the exposure and film speed [ISO] return to initial settings.

3

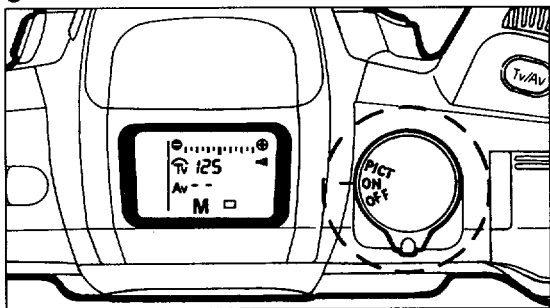



3. Set the main switch to [PICT] or [ON] and check that the LCD panel shows the information as shown above.

- The LCD display as shown above may be different if a lens is attached.

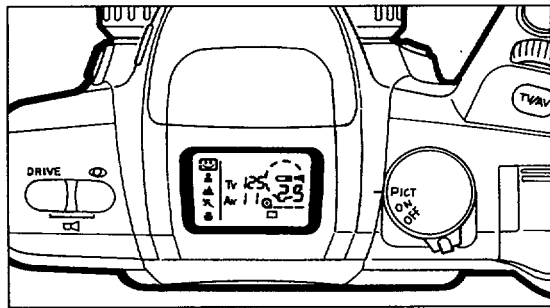
*



* Low Battery Warning
When the battery is nearly exhausted, the battery symbol [] appears on the LCD panel to warn you. Replace the battery as soon as possible.

- When the low battery warning [] starts blinking, replace the battery as soon as possible. See page page 14.

(3) ATTACHING THE LENS

1

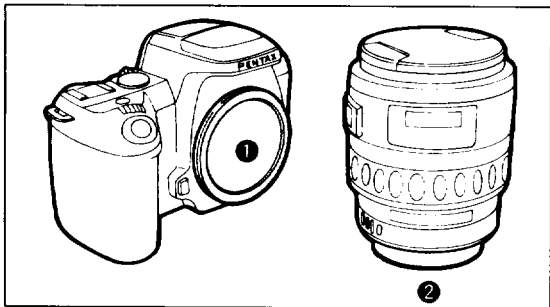

1. Remove the body mount cap ① and rear lens cap ② as shown in the illustration.

- The body mount cap is designed to protect the camera against scratches and dust at the factory. For storage, the optional accessory "Body Mount Cap K" is available.

2

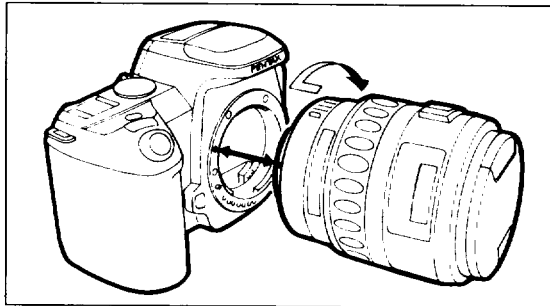

2. Align the red dots on the camera and lens mount, attach the lens to the camera body, and turn it fully to the right until you hear a click.

- Ensure that the camera's main switch is [OFF] before attaching the FA zoom to prevent unexpected operation of the zoom lens.

3

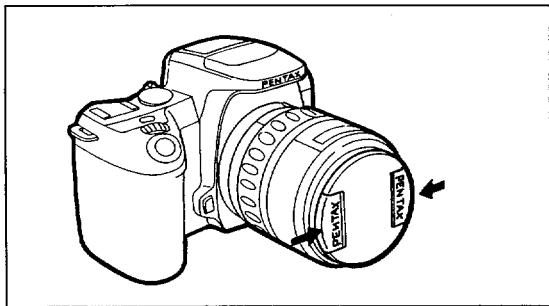

3. To remove the front lens cap, squeeze the tabs on both sides in the direction of the arrow.

- We assume no responsibility nor liability for damages resulting from the use of lenses made by other manufacturers.
- The camera body and lens mount incorporate lens information contacts and an AF coupler. Dirt, dust, or corrosion may often cause damage to the electrical system. Clean the contacts with a soft, dry cloth.

*

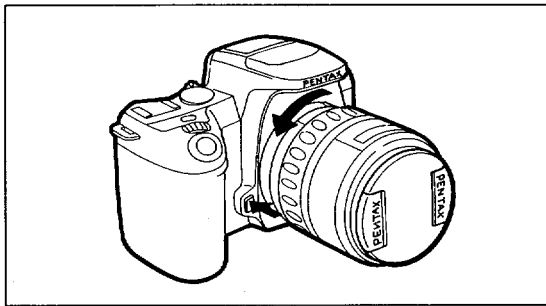

* How to remove

To remove the lens, turn it to the left while depressing the lens-lock-release button.

- To protect the contacts and AF coupler of the lens against damage after removal, be sure to set the lens down with the mount side facing upward.

(4) USING THE SHUTTER RELEASE BUTTON

The shutter release button has two positions. Depressing it down halfway (first position) turns on the exposure meter and autofocus system.

Depressing it fully (second position) allows you to release the shutter. When taking a picture, gently depress the shutter release button down to prevent camera shake.

- To prevent camera shake, depress the shutter release button gently.
- Before loading a roll of film, slowly depress the shutter release button to learn where the first position is.
- The LED indication stays on for about 10 seconds after the button is released from the halfway position. Depressing the shutter release button down halfway keeps the LED indicated.

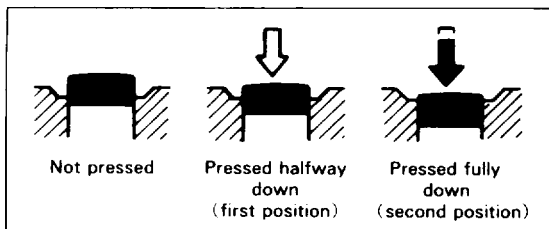

(5) MAIN SWITCH OPERATION

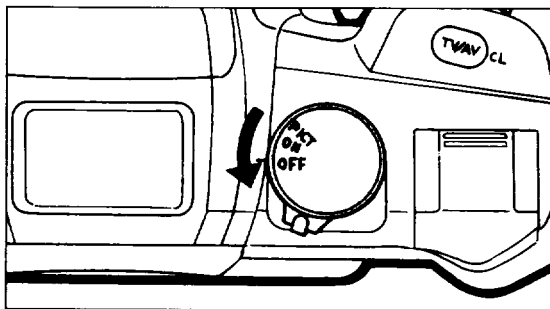

The main switch has three positions.

[PICT]: Picture mode position

5 picture modes are available when the lens aperture ring is set to [A].

[ON]: Full-feature position

All the exposure modes except for the Picture Mode are available.

[OFF]: OFF position (for when the camera is not in use.)

(6) FILM LOADING

We suggest that first you operate the camera with no film loaded to become familiar with its operation.

Automatic film speed setting

This camera is designed to use DX-coded films with ISO rating from 25 to 5000.

- When the DX-coded film is used, the correct film speed is automatically set for the camera.
- If you use a non-DX coded film, the camera automatically sets the film speed to ISO 100.
- Before loading a film for the first time after purchase, open the back cover and remove the protective card. **DO NOT TOUCH THE SHUTTER CURTAINS.**

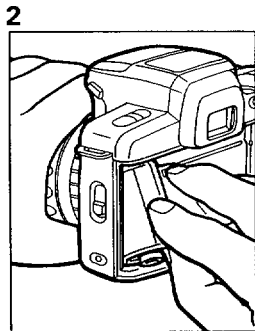
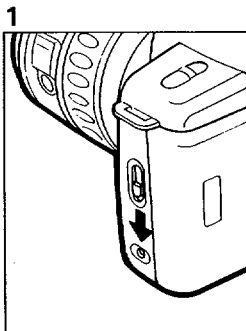
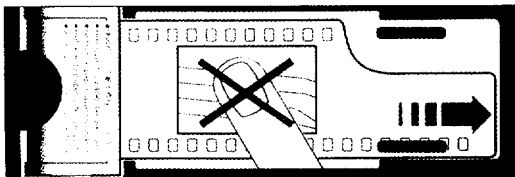

1. To open the back cover, slide the back cover release lever in the direction of the arrow.
2. Hold the film cartridge with the protruding end down. Slide the top end in the film chamber first and then push its protruding end in.

- Always load or unload a film in the shade or by using your body to shade the camera.

3

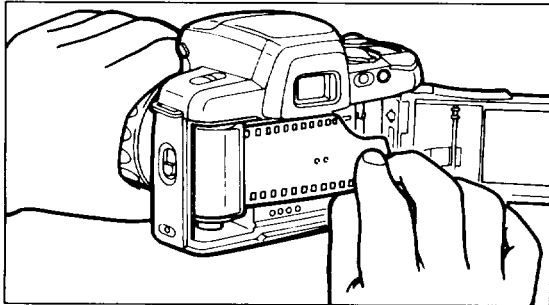

3. As shown in the illustration, pull the film leader out far enough from the cartridge to reach the take-up spool.

THE SHUTTER CURTAINS ARE FINE-PRECISION MATERIAL. DO NOT TOUCH THEM WITH YOUR FINGERS OR ANY OTHER OBJECT WHILE LOADING FILM.

- If you have pulled out too much film, push it back into the cartridge to reduce the slack.
- The DX information pins in the film chamber are used to read film speed. Keep them clean and free from scratches. To remove smudges, wipe gently with a soft, dry cloth.

4

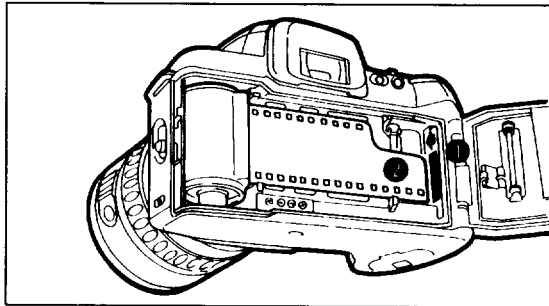

4. Align the film leader with the film leader end mark ❶ as shown.

- Make sure that the film perforations properly engage with the sprocket teeth ❷.
- The shutter curtains are fine-precision material. Do not touch them with your fingers or any other object while loading film.
- If the film leader is extremely bent, straighten it or cut off the bent portion.

Film loaded with slack No!

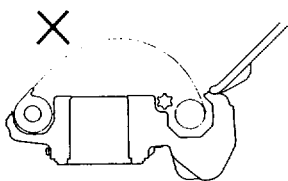

Film loaded flat Yes!

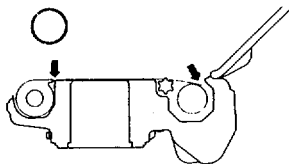

5

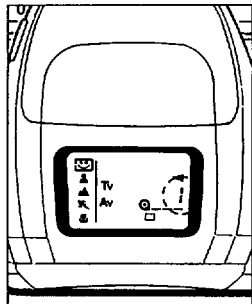
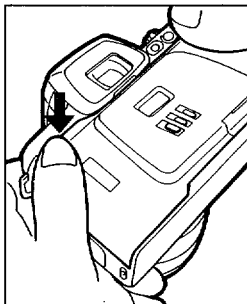

5. Close the back cover and set the main switch to [ON] or [PICT]. The film automatically advances to the first frame.

- Check that [f] and [Q_ _ _] are displayed on the LCD panel.

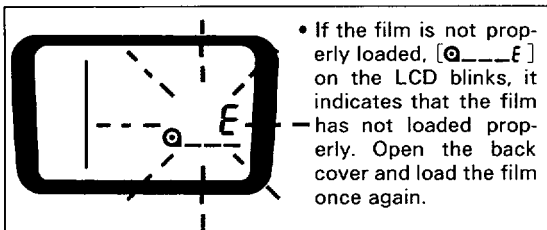

(7) UNLOADING FILM

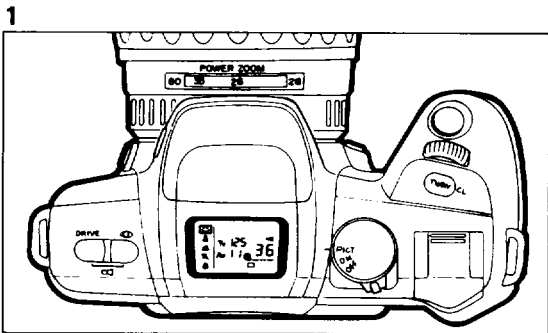

1. After the last frame of the roll is exposed, the camera rewinds the film automatically.

- During rewinding, [---] blinks on the LCD panel, indicating that the film is being rewound.
- The exposure counter counts frame numbers in reverse.
- Never open the back cover until the whole film roll is rewind.
- When removing the film from the camera, protect it from exposure to direct sun light.

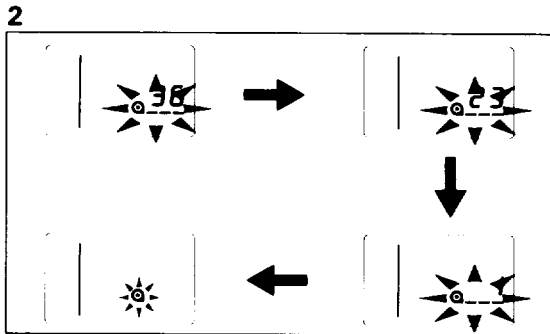

2. When the film is fully rewound, only [] blinks on the LCD panel.

3

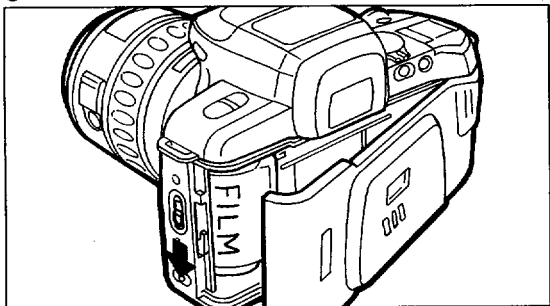

3. Open the back cover and remove the film.

- A roll of 24-exposure film takes about 15 seconds to be rewound.
- When the camera is not in use, set the main switch to the [OFF] position.
- Before opening the back cover, check that [●] is blinking.
- The shutter may be released a frame or more even after the specified number of frames have been used up as indicated by the number of frames on the film cartridge. However, those extra frames may be lost in the processing. When you take important pictures, rewind the film when the film reaches the end of the frame.

*

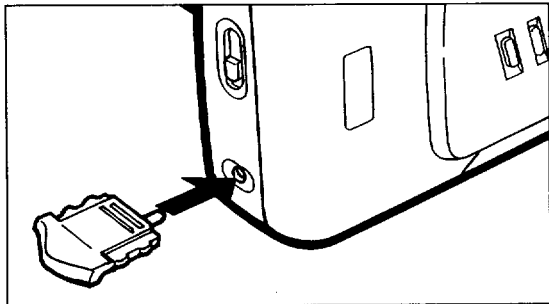

* Rewinding a Roll of Film in Mid-Roll

If you wish to unload the film before exposing all the frames, use this function.

Set the main switch to the [ON] or [PICT] position, and then depress the auxiliary rewind button with the protruding part of the Hot Shoe Cover F_r.

- Before opening the back cover, check that [●] is blinking.

II . BASIC OPERATION (SHOOTING)

(1) USING THE GREEN OPERATION MODE

PURPOSE

For easy picture taking, use the Green Operation Mode. In the Green Operation Mode position, the camera automatically selects the best combination of aperture and shutter speed setting allowing you to take pictures simply by depressing the shutter release button.

- See page 38, 48 and 49 for other available exposure modes.
- In the Green Operation Mode, the Program-Shift and exposure compensation functions do not operate.

1

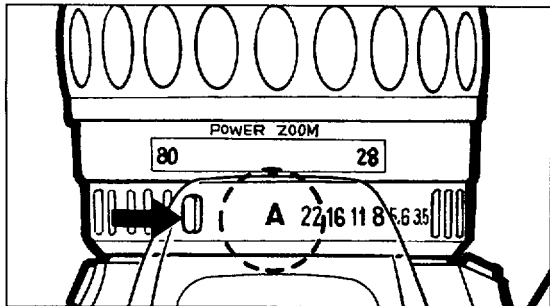

HOW to Set

1. Turn the aperture ring to the [A] position as shown in the illustration.

- To move the lens aperture ring to the [A (Auto)] position, turn the aperture ring while holding down the aperture-A lock button.

2

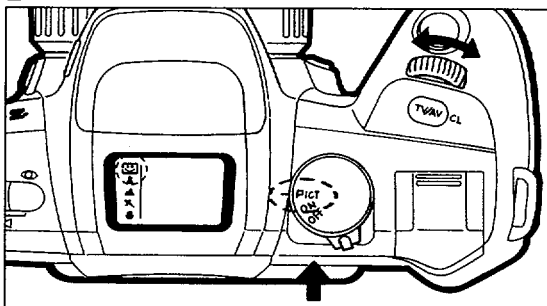



2. Set the main switch to [PICT]. While holding down the mode set button, turn the select dial until [] superimposes on [] on the LCD panel.

(2) SELECTING A DRIVE MODE

This camera has a total of three drive modes as shown.

Types of Drive Modes

-  Single-frame drive mode
One picture is taken at each press of shutter release button.
-  Consecutive drive mode
Pictures can be taken consecutively while holding down the shutter button. See page 64.
-  Self-timer drive mode
A picture can be taken with a 12-second-delay. See page 64.

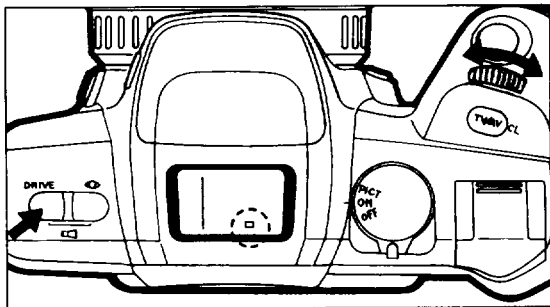

Setting the Drive Mode

While holding down the drive button, turn the select dial to set the desired drive mode.

- For normal picture taking, set the drive mode at .

(3) USING ZOOM LENSES



Telephoto



Wide angle

Using the zoom function makes the subject appear larger (telephoto) or smaller (wide angle) in the viewfinder. Turn the zoom ring to the desired position and depress the shutter release button to take a picture.

- The smaller the number shown in the zoom scale window, the wider the angle. Conversely, the larger the number, the more magnified the image appears.
- Using a Pentax-FA zoom lens with this camera allows you to use the power zoom (motorized zoom) function.
- When mounting lenses other than Pentax-FA zoom lenses, zoom the lens manually. For more details on the manual zoom operation, see page 29.

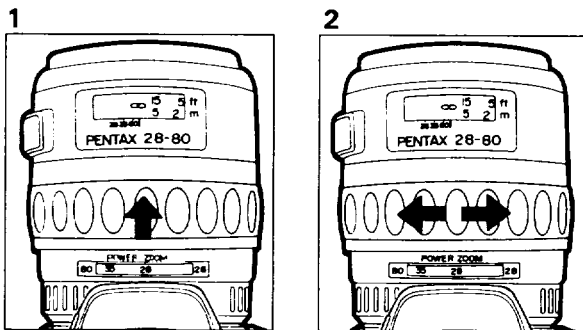

Using the Power Zoom Function

Note:

Only Pentax-FA zoom lenses offer the power zoom function.

1. Push the power zoom ring forward until the words **POWER ZOOM** appear beneath the power zoom ring.
2. Turning the power zoom ring to the right brings the subject closer (telephoto) and turning it to the left makes the subject smaller (wide angle). To stop zooming, release the power zoom ring.

- Three zooming speeds are available. Turning the power zoom ring fully to the right or left, zooms the lens quickly. Turning it slightly gives you slow operation. At an intermediate position, the lens zooms at medium speed.
- Zooming the lens with the power zoom function automatically focuses the lens on the subject. However, for final focusing, depress the shutter release button halfway down to focus the subject.
- When the main switch is turned off while a Pentax-FA zoom lens is in use, the lens automatically retracts to its shortest physical length.

1

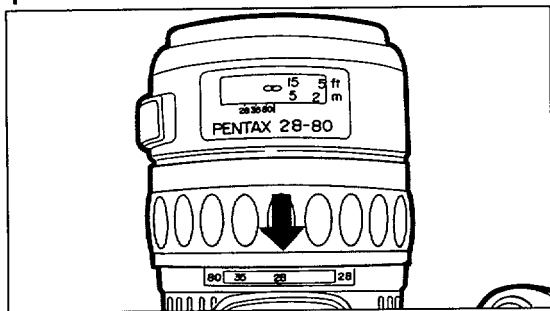

Using the Manual Zoom Function

1. Pull the power zoom ring toward the camera body until the words **[POWER ZOOM]** are hidden.

2

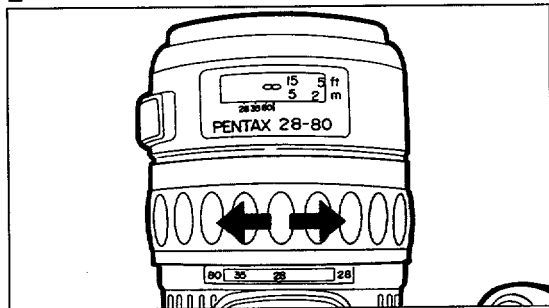

2. Turning the zoom ring to the right makes the subject appear larger (telephoto) and turning it to the left makes the subject appear smaller (wide angle).

(4) HOLDING THE CAMERA

Camera held horizontally



For best results, be sure to hold the camera correctly as shown in the illustrations.

Hold the camera firmly, with your left hand supporting the camera and lens as shown in the illustrations.

While taking a picture, hold your breath and gently depress the shutter release button. (Sudden force on the shutter release button will cause camera shake, making the picture blurred.)

Camera held vertically

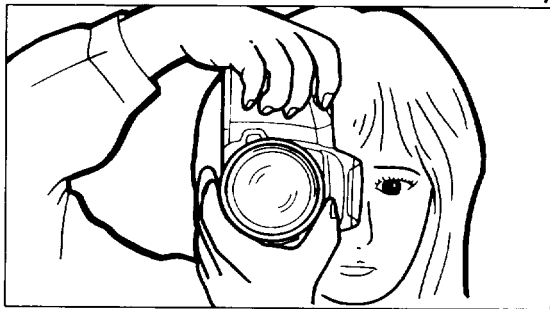

- To reduce camera shake, support your body or the camera on a solid object - a table, tree, or the wall of a building, for instance.
- When using a ultra-telephoto lens, a tripod that is heavier than the total weight of the camera and lens is recommended to avoid camera shake.

(5) SELECTING A FOCUS MODE

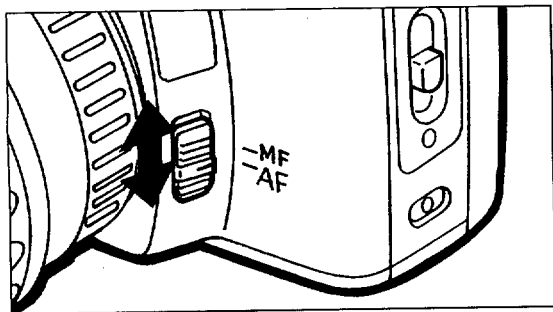

The focus mode switch has two positions as shown in the illustration.

- For an autofocus operation, set the focus mode switch to [AF].

About the Focus Mode Switch

[AF]: Autofocus

When you depress the shutter release button halfway down, the lens automatically focuses.

[MF]: Manual focus

You can focus on a subject manually. Select this position when the subject is difficult to focus. See page 45 for "HARD-TO-AUTOFOCUS SUBJECTS".

(6) AUTOFOCUSING



Set the focus mode switch to **AF**.



1. Center the autofocus frame [] over the main subject. When the shutter release button is depressed halfway down, the lens automatically focuses.
2. When the subject is in focus, the focus indicator [] lights up with the audible PCV signal.

- When the shutter release button is depressed halfway down, the shutter speed and aperture setting are displayed in the viewfinder and the LCD panel.
- When [] blinks in the viewfinder and the LCD panel, the use of the built-in flash is recommended. For more details on the built-in flash, see page 35.
- The audible PCV signal can be turned off. See details on page 66.
- During an autofocus operation, the focusing ring should not be obstructed with your fingers, hands, or any other objects.

The focus indicator [] blinks when the camera is not able to obtain proper focus for one of the following reasons.

- ① The subject is too close. Adjust the camera-to-subject distance.
- ② The subject is difficult to autofocus. See "HARD-TO-AUTOFOCUS" on page 45.

3. To release the shutter, gently depress the shutter release button fully down.

- The shutter cannot be released if the subject is out of focus.
- Depress the shutter release button halfway down. While [] is on, the camera-to-subject distance is fixed (focus lock).
- Once [] is lit in the viewfinder, the focus is fixed. To focus on another subject, lift your finger off the shutter release button.
- When the drive mode is set at the consecutive mode [], the lens focuses each time you release the shutter.
- When using the SMC Pentax-F Soft 85mm f/2.8 lens, set the aperture between f/2.8 and f/4.5. See page 47 for details.
- When the main subject is off the autofocus frame, use the focus-lock technique to bring the main subject into focus. See "Focus Lock Function" on page 34.

Predictive Autofocus Mode

When the camera senses subject movement during the autofocus operation, the camera will automatically switch the focus mode to the predictive autofocus mode to measure the speed of a moving subject, and predict where it will be at the moment of shutter release, to maintain sharp focus on wherever the subject may move.

- If the subject is moving too fast, the shutter may not be released.

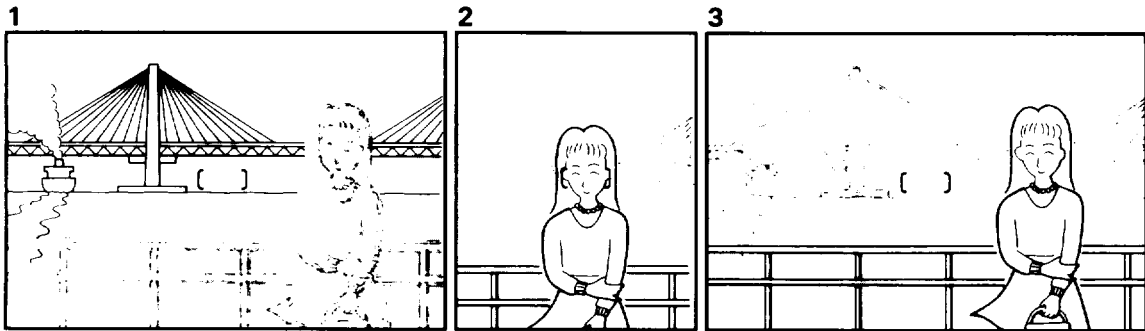

Focus Lock Function

Purpose

The camera focuses with the autofocus frame in the center of the viewfinder. When the main subject is off the autofocus frame, the main subject will not be focused properly. Use the focus lock technique to bring the main subject into focus.

How to Use

1. When the composition does not allow the autofocus frame to be placed over the most important subject in the picture, the camera will focus on the background as shown in the illustration.

2. To prevent this, center the autofocus frame on the main subject and keep depressing the shutter release button halfway down. The in-focus indicator remains on, indicating that the focus is temporarily locked.
3. While holding the shutter release button halfway down, re-aim the camera or recompose the picture, then depress the shutter release button all the way to release the shutter.

- Lifting your finger off the shutter release button clears the in-focus indicator [] in the viewfinder and cancels the focus lock function.
- To refocus on another subject, lift your finger off the shutter release button.

(7) USING THE BUILT-IN RETRACTABLE TTL FLASH (RTF)

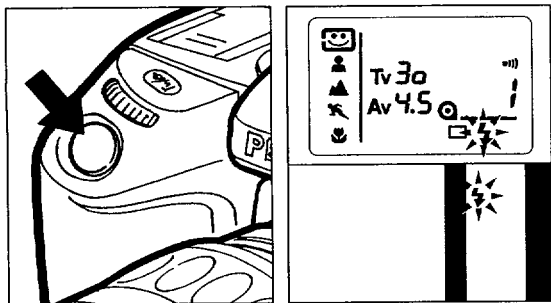

The Flash-Recommended Indicator

If the built-in flash is recommended for use, the flash-recommended indicator [⚡] starts blinking in the viewfinder and the LCD panel when the shutter release button is depressed halfway down.

- When a subject is shot in dark or in a backlit situation in the Programmed AE Mode, the Picture Mode (including the Green Operation Mode) or the Aperture-Priority AE Mode, the flash-recommended indicator [⚡] in the viewfinder and on the LCD panel recommends the use of the built-in flash. In the Shutter-Priority AE Mode or Manual Exposure Mode, the flash-recommended indicator appears only when a subject is shot in a backlit situation.

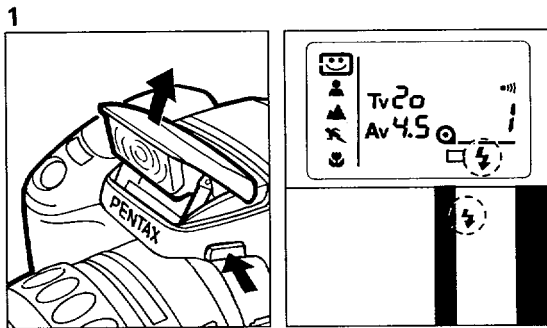

1. Push the flash pop-up button to activate the flash.

- The flash unit starts charging automatically. When it is fully charged, [⚡] appears on the LCD panel. When the shutter release button is depressed halfway down, [⚡] also appears in the viewfinder. The shutter cannot be released until the flash is fully charged.
- When the shutter release button is depressed halfway down, the shutter speed and the aperture setting appear in the viewfinder and the LCD panel.

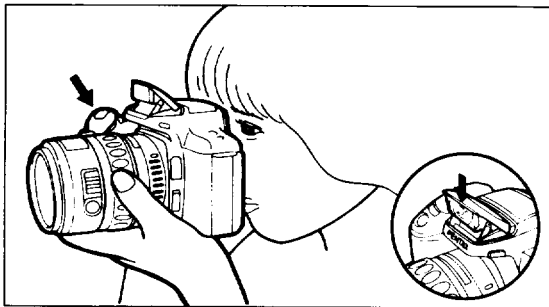

2. Depress the shutter release button fully, and the flash unit discharges. After using the flash, retract the built-in flash by pressing it down into the camera body.

Flash effective range for Programmed TTL Auto Flash with ISO 100 film used

Maximum Lens Aperture	Effective Range
f/1.4	approx. 0.9 - 4.6m (3.0 - 15.1ft)
f/2	approx. 0.8 - 3.7m (2.6 - 12.1ft)
f/2.8	approx. 0.7 - 3.3m (2.3 - 10.8ft)
f/3.5, f/4.7	approx. 0.7 - 2.9m (2.3 - 9.5ft)
f/5.6	approx. 0.7 - 2.3m (2.3 - 7.5ft)

The effective range of the flash depends on the maximum aperture of the lens in use. A lens with a maximum aperture of f/1.4 is marked as 1:1.4 on its barrel.

- This effective range table is only applicable when the exposure mode is set at the Picture Mode including the Green Operation Mode, or Programmed AE Mode. When any other exposure mode is used, see page 68.
- The minimum effective range is always 0.7m (2.6ft) even when using a lens with a maximum aperture of f/2.8 or smaller.

When a subject is shot at a distance closer than 0.7m (2.6ft), the correct exposure cannot be obtained, and you will see vignetting in the picture corners.

Inappropriate Lens Warning

When using inappropriate F- or FA- lenses, [⚡] in the viewfinder and on the LCD panel appear when the shutter release button is depressed halfway down.

- For more details on COMPATIBILITY OF F AND FA LENSES WITH THE BUILT-IN FLASH, see page 69.
- Taking a picture while this warning is displayed will cause vignetting in the picture corners or semi-circular vignetting at the bottom of the picture.
- Keep in mind that when lens other than an F or FA is in use, this warning will not be displayed.
- Do not use a lens hood as it may obstruct the light coming from the flash.
- If you load an ISO 400 film, see page 68 on the built-in flash effective range for the Programmed TTL Auto Flash.

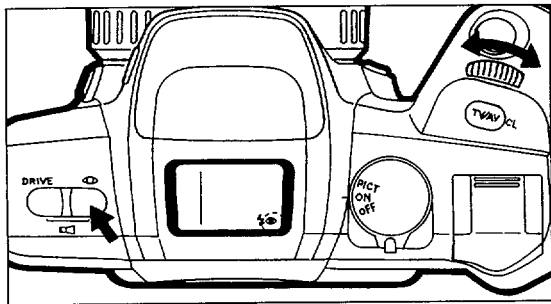

Red-eye Reduction Flash Function About Red-eye Phenomenon

Shooting portraits with flash in a dark environment often results in the subject's eyes to turn out reddish in the print. This phenomenon, commonly known as "Red-Eye", is caused by the reflection of the electric flash in the retina. It can be reduced by taking a photo in a bright light condition or by shooting with a wider angle lens at a closer distance when using a zoom lens, or by employing the red-eye reduction flash feature. When using a Pentax dedicated flash unit off the camera, it may also help to position the flash as far away from the camera as possible.

Red-eye Reduction Flash Function

This camera includes a red-eye reduction flash function, which reduces the red-eye phenomenon by the preflash. With this mode, the preflash is discharged just before the shutter is released to close the pupil of the eye and then the main flash is discharged. It can reduce the red-eye effect.

How to Set

While holding down the red-eye reduction button, turn the select dial until [👁] appears on the LCD panel.

- When the red-eye reduction button is depressed, [👁] will appear on the LCD panel.
- When the AF500FTZ is attached and the slave flash function is in use, the Red-eye reduction flash function cannot be used as the slave flash is discharged when the preflash of the built-in flash is discharged.
- When only a dedicated flash is in use and is discharged, the red-eye reduction display on the LCD panel is disregarded.

How to Cancel

- To cancel the red-eye reduction flash function, while holding down the red-eye reduction button, turn the select dial to erase [👁] from the LCD panel.

(8) USING THE PICTURE MODE

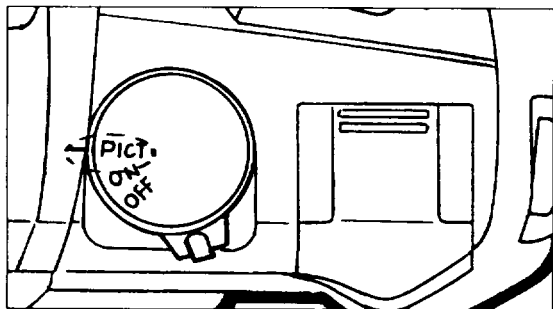

The Picture Mode has a total of 5 modes which are easily selected by superimposing [] on the mode display on the LCD panel, allowing you to use these highly advanced photographic technique effortlessly. See details for each mode on Page 39 - 42 and the Green Operation Mode on page 24.

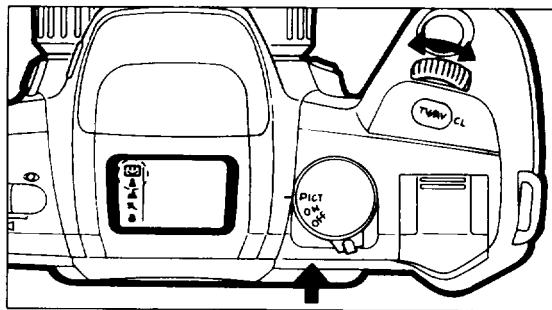

How to Set

Turn the lens aperture ring to the [A] position.

1. Set the main switch to [PICT].
2. To set the desired picture mode, turn the select dial while depressing the mode set button until [] superimposes on one of the picture mode displays.

- The Program-Shift cannot be used in the Picture Mode.

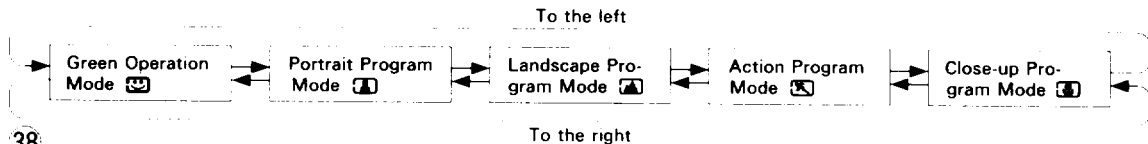

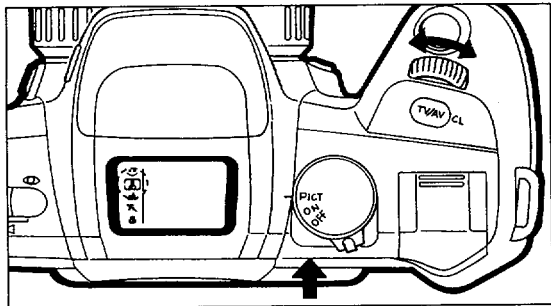

Portrait Program Mode



This mode is excellent for portrait photography.

How to Set



Turn the select dial while holding down the mode set button until  superimposes on .

In this mode, the telephoto lens produces a portrait in crisp focus against the out-of-focus background, while the wide angle lens enables you to shoot group photography or snapshots in sharp and clear focus with the extended depth-of-field.

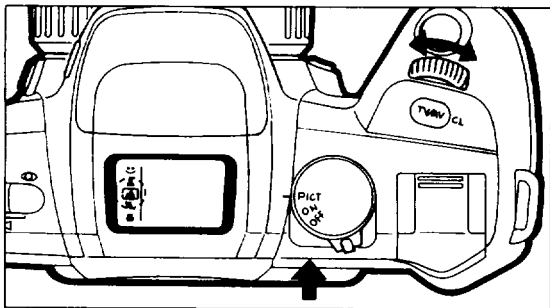
Landscape Program Mode



How to Set

Turn the select dial while holding down the mode set button until  superimposes on .

This mode is ideal for landscape photography and scenic snapshots.

This mode ensures that the foreground, middle and background are focused sharply throughout the image field, making it ideal for landscapes and scenic snapshots.

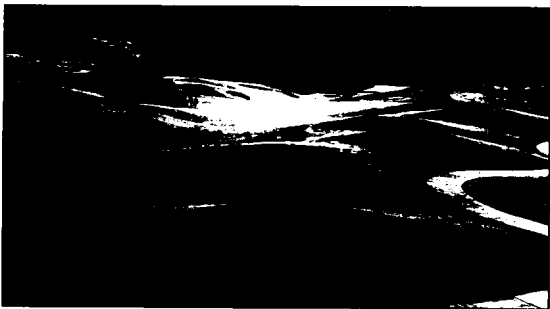

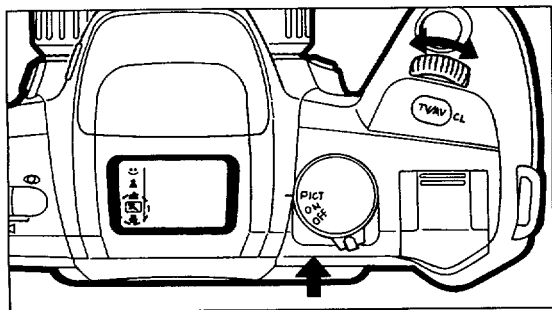

Action Program Mode



This mode selects a faster shutter speed to capture a moving subject.

How to Set

Turn the select dial while holding down the mode set button until  superimposes on .

This mode freezes the action and prevents blurred images. This mode is especially convenient for active photography. It is also suitable for portraits with a blurred background.



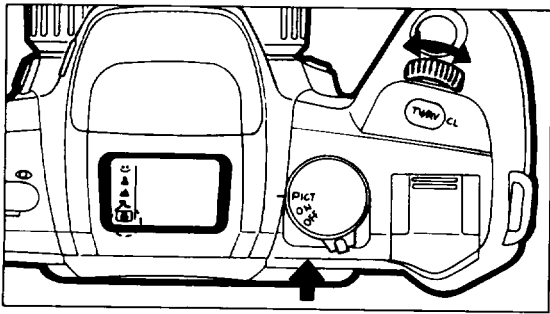

Close-up Program Mode []



This mode is useful for close-up photography.

How to Set

Turn the select dial while holding down the mode set button until [] superimposes on [].

This mode favors smaller apertures to maximize the depth of field, ensuring sharp focus of a close-up subject.



III. ADVANCED OPERATIONS

(1) MANUAL FOCUSING

Using a manual-focus lens

When mounting a non-autofocus lens with a maximum aperture of $f/5.6$ or larger ($f/1.2$ to $f/5.6$), you can use the manual focus mode to focus the lens with the aid of the in-focus indicator [O] in the viewfinder.

How to Focus

1. Set the focus mode switch to [MF].
 2. While looking through the viewfinder, turn the focusing ring to the right or left while holding the shutter release button halfway down.
 3. When the subject comes into focus, the in-focus indicator [O] lights up in the viewfinder. Depress the shutter release button fully to take a photograph.
- When using an autofocus lens, you can also use this method if the focus mode switch is set to [MF].
 - If an old type screw-mount lens is used with an optional Mount Adapter K, the in-focus indicator in the viewfinder cannot be used.
 - When the subject comes into focus, the focus indicator [O] lights up in the viewfinder and an audible PCV signal is heard. The audible PCV signal can be canceled. See page 66.

When the autofocus mode or the in-focus indicator is unsuitable for focusing

When the autofocus function or the viewfinder's in-focus indicator [O] cannot be used for focus confirmation for the following reasons, focus on the subject in the manual focus mode with the aid of the matte field in the viewfinder as you would with a non-AF SLR camera.

- a) The in-focus indicator blinks because the subject is difficult to autofocus.
- b) The maximum aperture of the lens in use is smaller than $f/5.6$.
- c) A bellows 100mm $f/4$, Shift 28mm $f/3.5$ (shifted), or Reflex lens is in use.
- d) An old type screw-mount lens fitted with an optional "Mount Adapter K".

1

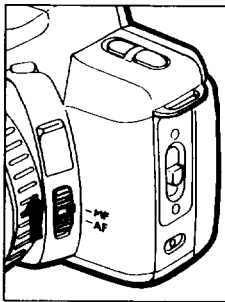

2

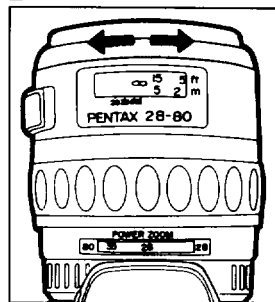

How to focus on the subject

1. Set the focus mode switch to [MF].
2. While looking through the viewfinder, turn the focusing ring to the right or left until the image in the viewfinder is clearest.

(2) HARD-TO-AUTOFOCUS SUBJECTS

Using the snap-in focus function

When the subject comes into the point where the prefocus was set, the shutter is automatically released.

How to Use:

1. Use a non-autofocus lens.
2. Set the focus mode switch to [AF].
3. Focus at the point where you wish to capture the subject.
4. Using the optional "Cable Switch F", keep the trigger release button depressed so that the autofocus and metering systems stay active.
5. The camera releases the shutter automatically when the subject comes into focus at the point selected.

The autofocus system is highly precise, but not perfect. Depending on the brightness, contrast, shape, and size of your subject, the autofocus system may not operate. In such a case, use the focus-lock technique (see page 34.) on a subject near the actual one and equidistant from the lens, or set the focus mode switch to [MF] and use the manual focus mode to focus the lens on the subject with the aid of the matte field in the viewfinder (see page 43).

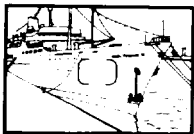

The subjects which may fool the autofocus system include:

- a) Extremely low-contrast subjects such as a white wall in the autofocus frame [C].
- b) Subjects which don't reflect much light in the autofocus frame [C].
- c) Subjects which are moving too fast.
- d) Subjects with horizontal lines or with finely complex or detailed patterns in the autofocus frame [C].
- e) Multiple subjects in the foreground and background of the autofocus frame [C].
- f) Subjects positioned against reflected light or strong backlight or with extremely bright backgrounds.

Notes on Accessories

The following conditions do not allow autofocusing or manual focusing which uses the in-focus indicator in the viewfinder. Use the manual focus mode to focus on the subject with the aid of a matte field surrounding the autofocus frame.

- a) When using special effect filters or "Magic Image Attachment" or "Stereo Adapter".
- b) When using Extension Tubes or an Auto Bellows for close-up photography.

Note on the SMC Pentax F SOFT 85mm f/2.8 lens

When shooting at a distance closer than approx. 1.5m (4.9ft), set the lens to a manual f-stop setting between f/2.8 and f/4.5. A smaller aperture (f/5.6 to f/32) may cause the autofocus system and the viewfinder's in-focus indicator to malfunction. To remedy this problem, temporarily set the lens to f/4.5. After focusing on the subject, lock focus, and set the lens to the required f-stop.

Using Polarizing Filter

When using an ordinary polarizing filter; a half mirror incorporated into the autofocus system reduces the effectiveness of the autofocus function when used in combination with an ordinary polarizing filter. Use a **CIRCULAR POLARIZING FILTER** for autofocus operation.

(3) SELECTING AN EXPOSURE MODE

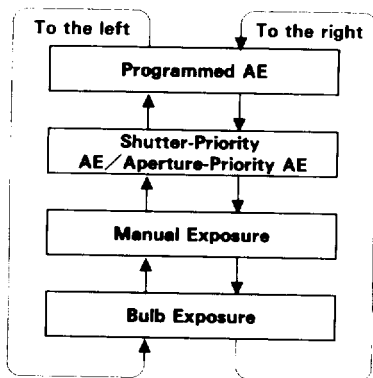

With the lens aperture ring set at the **A** position
Set the main switch to **[ON]** (full-feature position).

With the lens aperture ring at the **[A (auto)]** position,
the exposure mode switches as shown at left in accordance
with the rotation of the select dial while holding down
the mode set button.

- If the main switch is set to **[PICT]**, only the Picture Mode can be selected. See the Picture Mode on page 38.

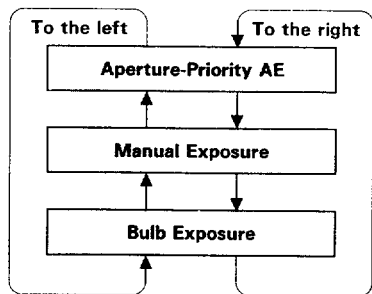

When the lens aperture ring set at other than the A position

Set the main switch to [ON] or [PICT].

With the lens aperture ring set at other than the A position, the exposure mode switches as shown at left in accordance with the rotation of the select dial while holding down the mode set button.

Turn the lens aperture ring from [A] to a manual f-stop setting when using the following accessories.

- Accessories such as the Extension Tube Set which do not allow the automatic diaphragm control for exposure.
- Old type flash units which do not allow the use of the [A] position of the lens aperture ring.

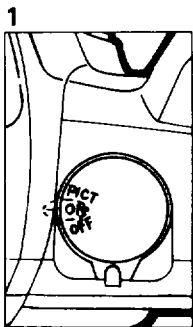

Using the Programmed AE Mode

Purpose

The camera selects the optimum combination of the shutter speed and the aperture setting automatically, making it easy to take a good photograph by just a depression of the shutter release button.

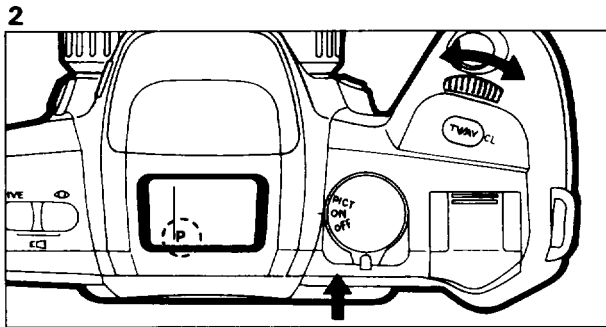

How to Set

Set the lens aperture ring to the [A (auto)] position.

1. Set the main switch to [ON].
2. While holding down the mode set button, turn the select dial until [P] appears in the LCD panel.

- When the shutter release button is halfway depressed, the shutter speed and aperture setting will be displayed in the viewfinder and the LCD panel.

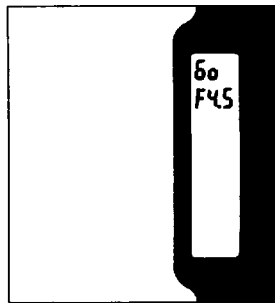

*

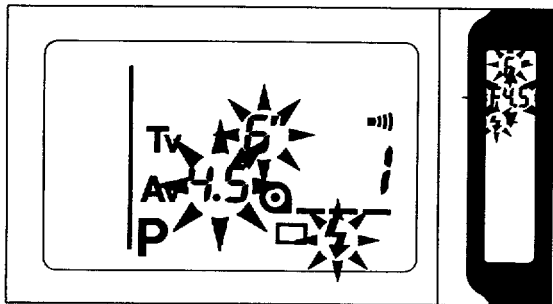

* Exposure Warning

If the subject is too bright or dark, the shutter speed and aperture setting will blink in the viewfinder and the LCD panel. Use an ND (neutral density) filter if the subject is too bright. Use a flash if the subject is too dark.

Program-Shift when the Programmed-AE Mode is in use

Purpose

The Program-Shift means that the shutter speed/aperture combination is changed while maintaining the same exposure value to increase or decrease the shutter speed/aperture effects. For further information on the Program-Shift, see page 79 and 80.

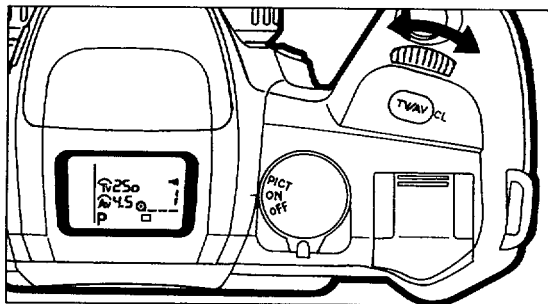

How to Shift

Turning the select dial to the right changes the shutter speed to a fast speed (opening the aperture), turning the select dial to the left changes the shutter speed to a slower speed (closing the aperture).

- When the program is shifted, [⤴] appears on the LCD panel and the bars appear underneath the shutter speed and the aperture value in the viewfinder.
- You can shift the program only within the proper exposure range.

How to Cancel

The Program-Shift can be canceled by depressing the [Tv/Av] button.

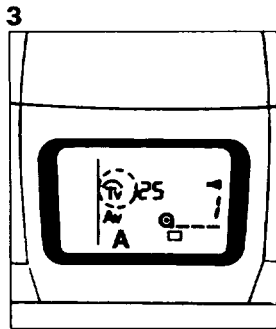
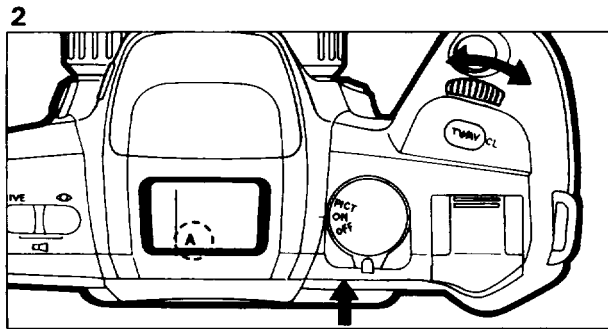
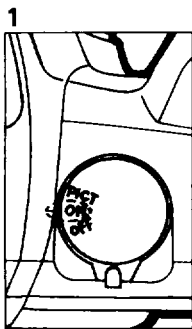

Using the Shutter-Priority AE Mode

Purpose

When the desired shutter speed is selected, the appropriate aperture is automatically set by the camera for a proper exposure according to the brightness of the subject. This mode is suitable for freezing the action with a fast shutter speed or capturing a flowing dynamic image with a slow shutter speed. For details on the effect of the shutter speed, see page 79.

How to Set

Set the lens aperture ring to [A (auto)].

1. Set the main switch to [ON].
2. While holding down the mode set button, turn the select dial till [A] appears on the LCD panel.
3. Depress the Tv/Av button to make [Tv] appear above [A] indication on the LCD panel.

4

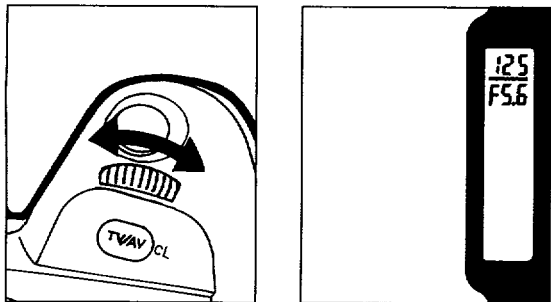

4. Select the desired shutter speed with the select dial.

- The bar underneath the shutter speed will be displayed in the viewfinder.
- When the shutter release button is depressed halfway down, the shutter speed and the aperture setting will be displayed in the viewfinder and on the LCD panel.

*

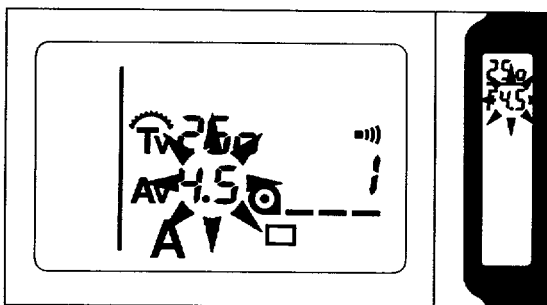

* Exposure Warning

If the subject is too bright or dark, the shutter speed and aperture setting in the viewfinder and on the LCD panel blink. When the subject is too bright, choose a faster shutter speed. If it is too dark, choose a slower shutter speed. When the shutter speed indication stops blinking, you can take a picture. If both selected shutter speed and aperture blink, it means that the exposure is out of metering range, unable to obtain a correct exposure even the shutter speed is adjusted: use an ND (neutral density) filter if the subject is too bright or a flash if it is too dark.

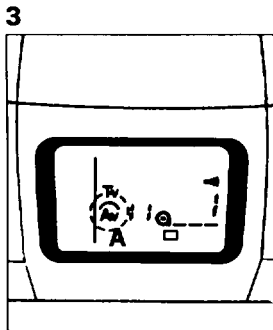
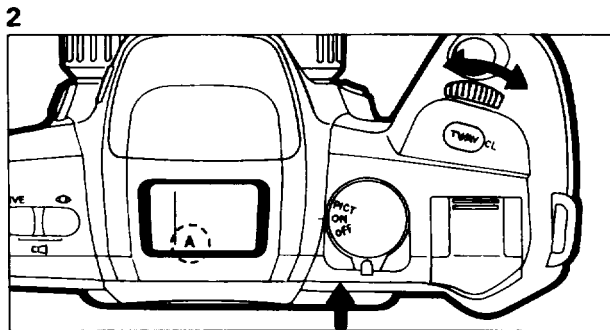
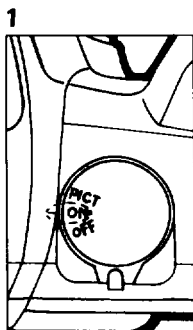

Using the Aperture-Priority AE Mode

Purpose

When the desired aperture is selected, an appropriate shutter speed is automatically set by the camera for a proper exposure. This mode is ideal for shooting landscapes with an increased depth of field, or a portrait against a blurred background. For details on the effect of the aperture setting, see page 80.

How to Set

Set the lens aperture ring to [A (auto)].

1. Set the main switch to [ON].
2. While holding down the mode set button, turn the select dial until [A] appears on the LCD panel.
3. Depress the Tv/Av button to make [A] appear above the Av indication on the LCD panel.

4

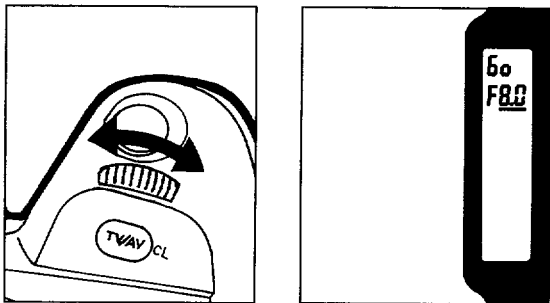

4. Select the aperture setting by the select dial.

- The bar will be displayed underneath the aperture setting in the viewfinder.
- When the shutter release button is halfway depressed, the shutter speed and aperture setting will be displayed in the viewfinder and on the LCD panel.

*

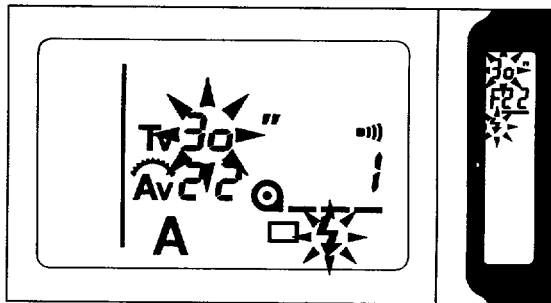

* Exposure Warning

If the subject is too bright or dark, the selected shutter speed will blink in the viewfinder and on the LCD panel as a warning as shown. When the subject is too bright, choose a smaller aperture; when it is too dark, choose a large aperture. When the shutter speed indication stops blinking, you can take a picture. If both shutter and aperture blink, it means that the exposure is out of metering range, unable to obtain a correct exposure even if the aperture is adjusted. Use an ND (neutral density) filter if the subject is too bright or a flash if it is too dark.

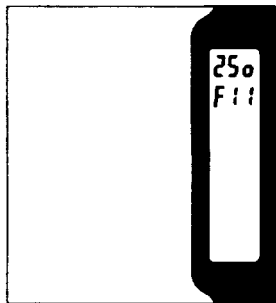
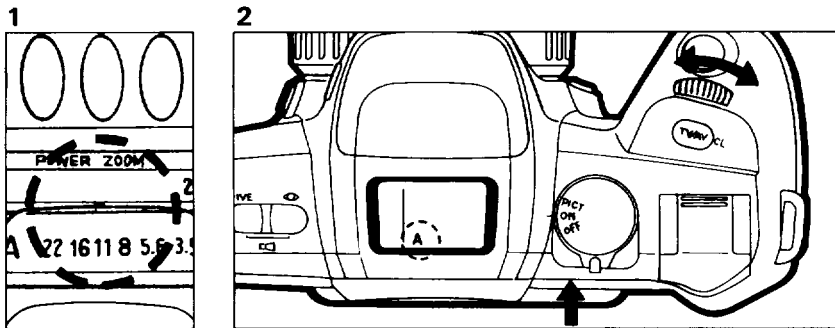

When the Lens Aperture Ring is set at a position other than **A** (Auto).

The Aperture-Priority AE Mode can be set even if the lens aperture ring is set at a position other than **A**. Set the main switch to **[ON]** or **[PICT]**.

How to Set

1. Turn the lens aperture ring to a position other than **[A]**.
 2. While holding down the mode set button, turn the select dial until **[A]** appears on the LCD panel.
- When the shutter release button is halfway depressed, the shutter speed will be displayed in the viewfinder and on the LCD panel.

- When an F or FA lens is used, an approximate aperture indication will appear on the LCD panel when the shutter release button is halfway depressed. When other than an F or FA lens is used, no approximate aperture indication will appear in the viewfinder nor on the LCD panel.
- When a lens without information contacts is used, the center-weighted metering mode is used instead of the multi-metering mode.
- When the $f/1.2$ lens is in use with the lens aperture ring set other than the **A** position, the center-weighted metering mode will be set instead of the multi-metering mode. As the exposure will come out 1 to 1.5 stops over, set the lens aperture ring to **A** or adjust the exposure deliberately 1 to 1.5 stops under.

Exposure Warning

The exposure warning is as explained on page 55.

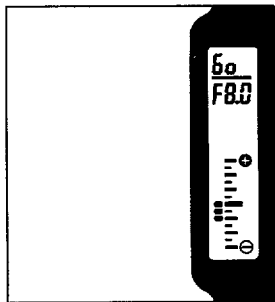
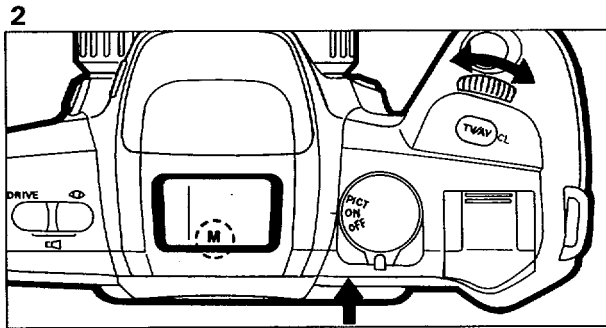
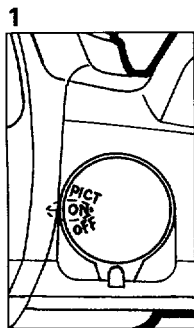

Using the Manual Exposure Mode

Purpose

The manual exposure mode is a convenient exposure mode for taking pictures always the same shutter speed and the aperture setting combination, or taking a creative under or overexposure photograph.

How to Set

When the lens aperture is set to [A]

1. Set the main switch to [ON].
2. While holding down the mode set button, turn the select dial until [M] appears on the LCD panel.

- The shutter speed, aperture setting, and the bar graph will be displayed on the LCD panel.
- When the shutter release button is halfway depressed, the shutter speed, aperture setting and the bar graph will also be displayed in the viewfinder.



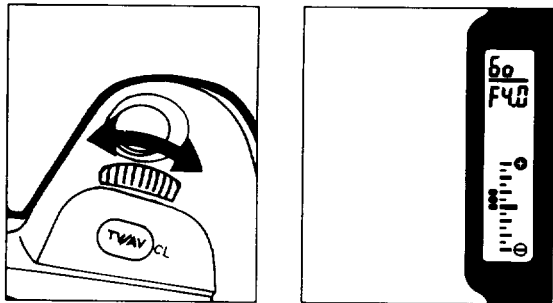





3



3. Select the desired shutter speed and the aperture with the select dial.

• When you change the shutter speed, depress the Tv/Av button to display [] above the TV on the LCD panel (The bar appears underneath the shutter speed in the viewfinder). Then turn the select dial to change the shutter speed.

When you change the aperture setting, depress the the Tv/Av button until [] appears above the Av on the LCD panel (The bar appears underneath the aperture value in the viewfinder). Then turn the select dial to change the aperture setting.

- When the dots are displayed to the [] side on the bar graph, it indicates overexposure and when displayed to the [] side, it indicates underexposure. Moving one dot on the bar graph indicates 0.5 step (0.5EV). However, when under or over exposure is set beyond +3 or -3 steps (3EV), [] or [] indicator will blink.
- When the hyper button [] is depressed, [] is displayed on the LCD panel, the shutter speed remains unchanged while the aperture is adjusted for a correct exposure: when [] is displayed on the LCD panel, the aperture remains unchanged while the shutter speed is adjusted for a correct exposure (HYPER MANUAL).
- When the hyper button [] is depressed, the dots in the viewfinder and on the LCD panel move into the center of the bar graph to indicate that a correct exposure is obtained.
- In the manual exposure mode, when the shutter release button is depressed while depressing the Hyper button [], the shutter speed and aperture setting will be changed to obtain a correct exposure even if the brightness of the subject is changed. The exposure is adjusted in a similar manner to as when the Programmed AE mode is set.
- If the subject is too bright or dark, and both shutter speed and aperture blink in the viewfinder and on the LCD panel, it means that the exposure is out of metering range, unable to obtain a correct exposure. Use an ND (neutral density) filter if the subject is too bright or a flash if it is too dark.

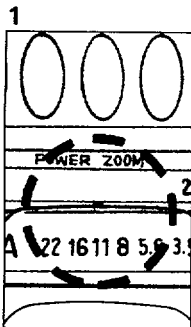

1 When the lens aperture ring is at a position other than "A" (auto).

(Set the main Switch to ON or PICT.)

How to Set

1. Turn the lens aperture ring to a position other than [A].
2. While holding down the mode set button, turn the select dial until [M] appears on the LCD panel.
3. Adjust the aperture with the lens aperture ring and the shutter speed with the select dial.

- The shutter speed and bar graph will be displayed on the LCD panel.
- When the shutter release button is depressed halfway down, the shutter speed and the bar graph will be displayed in the viewfinder.

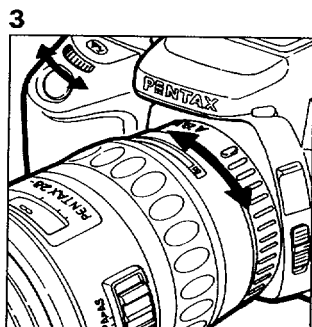
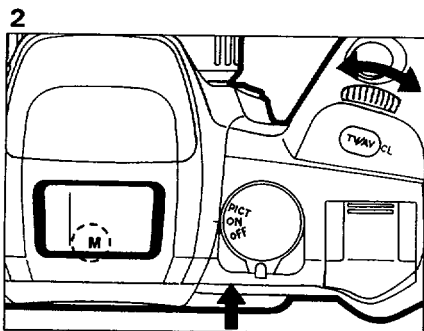

- When the shutter release button is depressed halfway down with an F or FA lens in use, an approximate aperture indication and shutter speed will appear in the viewfinder and the LCD panel. With other lenses, no indication will appear.
- Adjust the exposure in a similar manner as when the lens aperture is set at "A" (Auto). Depressing the hyper button [H] will immediately adjust the shutter speed for a correct exposure (Hyper Manual).
- When a lens without information contacts is used, the center weighted metering mode is set instead of the multi-metering mode.
- When using a Pentax A f/1.2 lens with the lens aperture ring set other than the A position, the center weighted metering mode will be set instead of the multi-metering mode. As the exposure will come out 1 to 1.5 stops over, set the lens aperture ring to [A], or adjust the exposure deliberately 1 to 1.5 stops under.
- The exposure warning is as explained on page 58.



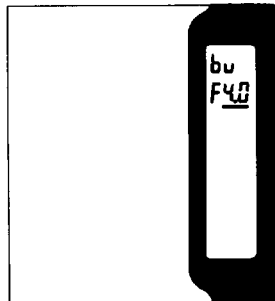
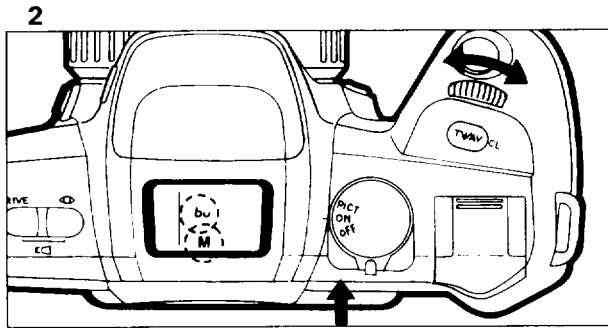
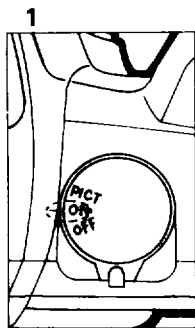

Bulb Exposure Mode

Purpose

This mode is useful for long exposures required for shooting fireworks and night scenes. The shutter remains open as long as the shutter release button is held down.

How to Set

When the lens aperture ring is set at **A**.

1. Set the main switch to **ON**.
2. While holding down the mode set button, turn the select dial until **M** and **bu** appear on the LCD panel.

- The aperture will be displayed on the LCD panel.
- When the shutter release button is depressed halfway down, **bu** and the approximate aperture will be displayed in the viewfinder.



3

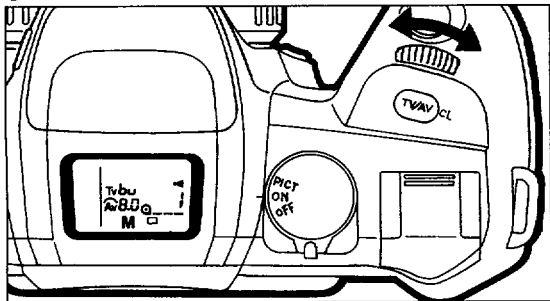

3. Adjust the desired aperture with the select dial.

- The bar appears underneath the aperture in the viewfinder.
- When using this mode, use a steady tripod to prevent camera shake and attach the optional "Cable Switch F" after detaching the Release Socket Cap F_r.
- Up to approx. 12 hours of time exposure are possible at room temperatures with a new lithium battery.

How to Set

With the lens aperture ring at a position other than "A" (auto)

1. Set the main switch to [ON] or [PICT].
2. Turn the lens aperture ring to a position other than [A].
3. While holding down the mode set button, turn the select dial until [M] and [bu] appear on the LCD panel.

- When the shutter release button is depressed halfway down, [bu] will be displayed in the viewfinder.
- When the shutter release button is depressed with an F or FA lens is used, an approximate aperture will appear in the viewfinder and the LCD panel. With other lenses, no approximate aperture will appear.
- When using this mode, use a steady tripod to prevent camera shake and attach the optional "Cable Switch F" after detaching the Release Socket Cap F_r.
- Up to approx. 12 hours of time exposure are possible at room temperatures with a new lithium battery.



(4) ABOUT EXPOSURE COMPENSATION

1

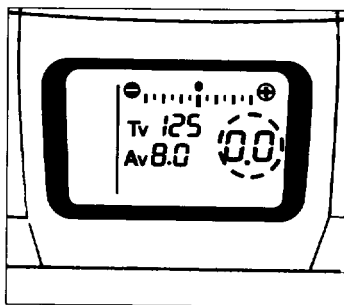
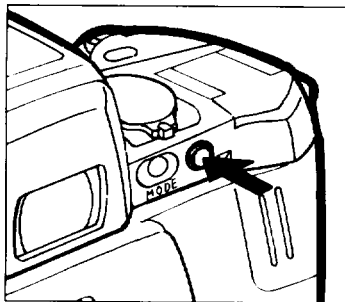

2

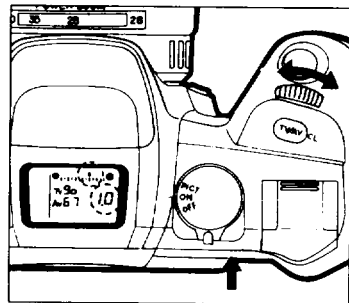

Purpose

The exposure compensation allows to deliberately overexposure (brighten) or underexposure (darken) a subject.

How to Set

1. When the hyper button  is depressed, the compensation value and the bar graph will be displayed on the LCD panel.
2. While depressing the hyper button, turn the select dial to set the desired compensation value.

- The exposure compensation does not work in the Green Operation Mode, Manual Exposure Mode and Bulb Exposure Mode.
- The exposure compensation range is in the range from 3EV to -3EV in 0.5EV step.
- When the exposure compensation is in use, the bar graph and dot are displayed on the LCD panel.  is displayed in the viewfinder.
- Moving one dot on the bar graph indicates 0.5EV step.

How to Cancel

To cancel the exposure compensation, reset the compensation value to 0.0 by depressing the Tv Av button while holding down the hyper button.

- The exposure compensation will not be canceled even if the main switch is set to **OFF**.

(5) SELECTING A DRIVE MODE

This drive mode has a total of three drive modes as shown.

Types of Drive Modes

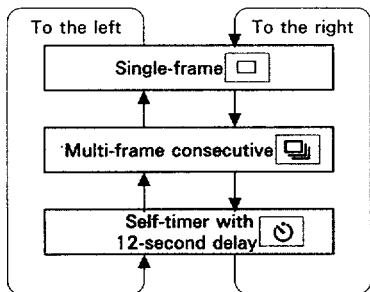

- [□] : One picture is taken at each press of shutter release button.
- [📷] : Pictures can be taken consecutively while holding down the shutter release button. See page 64.
- [🕒] : A picture is taken with a 12-second-delay. See page 64.

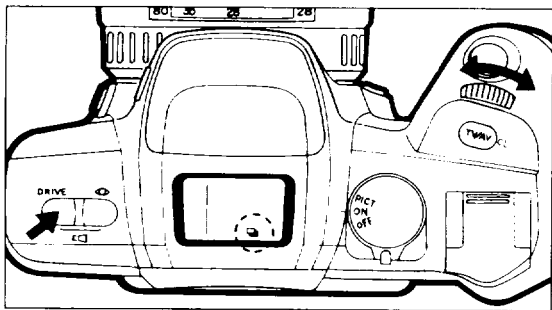

1 Consecutive Photography

Pictures can be taken consecutively while the shutter release button is held down.

How to Set

While holding down the drive button, turn the select dial until  appears on the LCD panel.

- The camera focuses on the subject frame by frame in this mode.
- The shutter cannot be released while the built-in flash is being charged.

1

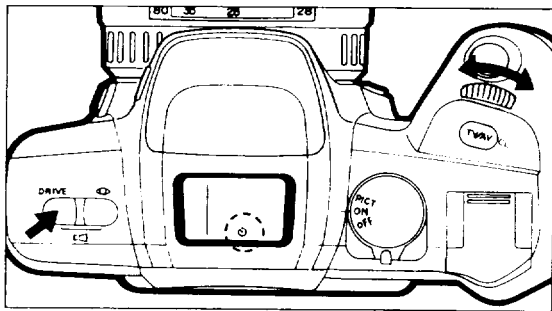

2 Self-Timer Mode

The self-timer mode delays the shutter release, and is useful for taking group shots including the photographer. The shutter will be released about 12 seconds later.

How to Set

1. While holding down the drive button, turn the select dial until  appears on the LCD panel.

2

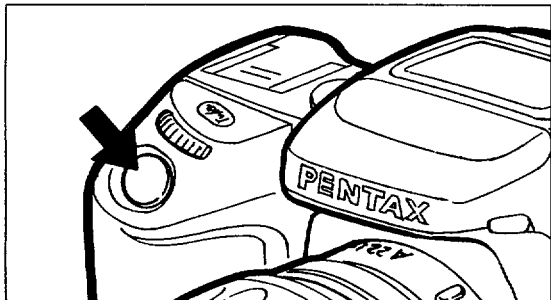

2. Focus on the subject first with the autofocus frame by depressing the shutter release button halfway down, and then depress the shutter release button fully. The self-timer is now activated.

- The shutter will be released about 12 seconds later.
- When the self-timer is in operation, the audible PCV signal is heard at a faster rate for the last two seconds.

How to Cancel

To cancel the self-timer operation after it has been activated before a picture is taken, move the main switch to the [OFF] position.

*

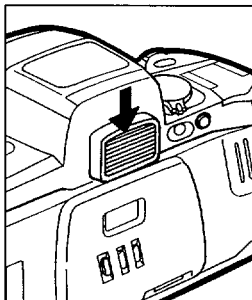

* If you back away from the viewfinder during self-timer operation, underexposure may result due to light entering the camera through the viewfinder. Attach the supplied finder cap as shown in the illustration.

* When using accessories such as the "Correction Lens M" and "Findercap", remove the Eyecup F. The Eyecup F comes from the factory fitted to the camera's viewfinder accessory grooves.

- When you want use an Eyecup in combination with a "Correction Lens M", combine the optional "Eyecup M II" with "Correction Lens for 67".

*

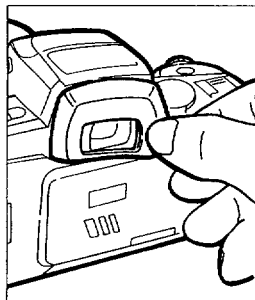

(6) TURNING OFF THE AUDIBLE PCV SIGNAL

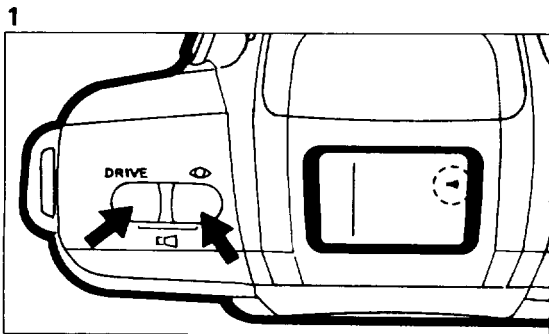

The audible PCV signal when the subject is in focus can be turned off.

How to Set

1. Depress the red-eye reduction button and the drive button simultaneously so that only  appears on the LCD panel.

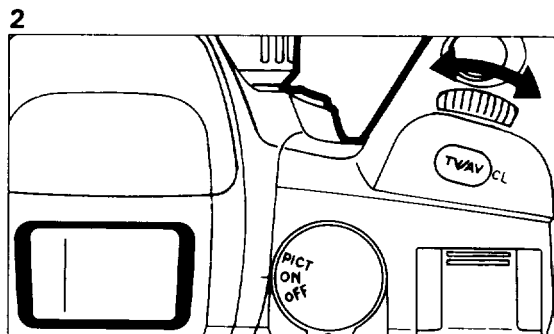

2. While holding these two buttons down, turn the select dial to erase  from the LCD panel.

- To return the audible PCV signal, turn the select dial while holding down the red-eye reduction button and drive button simultaneously.

(7) USING THE BUILT-IN FLASH (RTF)

With the Picutre Mode including the Green Operation Mode or the Programmed AE Mode in use

- The camera automatically chooses an optimum combination of shutter speed and aperture according to the subject brightness, allowing you to take a flash photograph with ease. The shutter speed automatically changes in the range of $1/100$ sec. to a slower speed which does not cause camera shake. The slowest shutter speed depends on the focal length of the lens fitted to the camera. When a non-AF lens is used, or the Action Program Mode is used, the camera uses the shutter speed of $1/100$ second.
- In the Programmed AE Mode, a shutter speed/aperture combination can be changed by turning the select dial. The Program-Shift works in the aperture range that couples with a shutter speed of $1/100$ sec. or slower. For further details on the program shift, see page 51.

Shutter-Priority AE Mode

The shutter speed can be changed in the range from $1/100$ to a slower shutter speed when the built-in flash is used. In the Shutter-Priority AE shutter speed Mode, the aperture automatically changes according to the ambient brightness, making the flash photography easy.

Aperture-Priority AE Mode

To take pictures with a selected in-focus depth of field, or change the distance to the subject, the flash can be discharged at a desired aperture. In the Aperture-Priority AE Mode, the shutter speed automatically changes with the ambient brightness, making flash photography easy. The shutter speed changes in the range from $1/100$ sec. to a slower shutter speed which does not cause camera shake. The slowest shutter speed depends on the focal length of the lens in use. The shutter speed of $1/100$ sec. is automatically set when a non-autofocus lens or the Action Program Mode is in use.

- When using the built-in flash in the Manual Exposure Mode, any combination usage of the aperture and shutter speed slower than $1/100$ can be selected.

Calculating the flash effective distance according to the camera-to-subject distance.

Maximum flash distance Guide Number : Selected aperture

Minimum flash distance Maximum flash distance : 5 *

When the distance to the subject is less than 0.7m (2.3ft), flash cannot be used. If the flash is used within that distance, it causes vignetting in the picture corners, light is distributed unevenly and the picture may be overexposed.

- The value 5 used in the formula above was obtained from the built-in flash.

The guide numbers (GN) depend upon the film speed used as shown below.

ISO25 • GN6.5	ISO200 • GN18
ISO50 • GN9.2	ISO400 • GN26
ISO100 • GN13	

If an ISO100 film is in used at an aperture of f2.8, the flash effective distance is obtained as follows:

Guide Number (13) = $f/2.8 \times 4.6m$
 $4.6 \div 5 = 0.92m$

Thus, the flash effective distance is from approx. 0.92m to 4.6m.

Calculating the aperture according to the camera-to-subject distance

Aperture = Guide Number \div Camera-to-subject distance

If the calculated aperture value is the one other than an f-stop on the aperture ring, for instance $f/3$, choose the next smallest aperture ring (f2.8 in this case).

Built-in Flash effective range for Programmed TTL Auto Flash with ISO 400 film used

Maximum Lens Aperture	Effective Range
f/1.4	approx. 0.9 - 6.5m (3.0 - 21.3ft)
f/2	approx. 0.8 - 5.8m (2.6 - 19.0ft)
f/2.8	approx. 0.7 - 4.6m (2.3 - 15.1ft)
f/3.5, f/4.7	approx. 0.7 - 4.6m (2.3 - 15.1ft)
f/5.6	approx. 0.7 - 4.6m (2.3 - 15.1ft)

COMPATIBILITY OF F AND FA LENSES WITH THE BUILT-IN FLASH

[○=compatible ×=incompatible because of vignetting]

Lens name	Compatibility
FA20mm f/2.8	×
FA*24mm f/2	×
F.FA 28mm f/2.8	○
F.FA 50mm f/1.4	○
F.FA 50mm f/1.7	○
FA*85mm f/1.4	○
F.FA 135mm f/2.8	○
FA*200mm f/2.8	○
FA*300mm f/2.8	×
F.FA*300mm f/4.5	×
F.FA*600mm f/4	×
F.FA MACRO 50mm f/2.8	○
F.FA MACRO 100mm f/2.8	○
F Soft 85mm f/2.8	○

Lens name	Compatibility
F Fish-Eye Zoom 17-28mm f/3.5-4.5	×
F Zoom 24-50mm f/4	○*1
FA*Zoom 28-70mm f/2.8	×
FA Zoom 28-80mm f/3.5-4.7	△*2
F Zoom 28-80mm f/3.5-4.5	△*3
FA Zoom 28-105mm f/4-5.6	△*4
F Zoom 35-70mm f/3.5-4.5	○
F Zoom 35-80mm f/4-5.6	○
F Zoom 35-105mm f/4-5.6	○
F Zoom 35-135mm f/3.5-4.5	○
FA Zoom 70-200mm f/4-5.6	○
F Zoom 70-210mm f/4-5.6	○
FA*Zoom 80-200mm f/2.8	△*5
F Zoom 80-200mm f/4.7-5.6	○
FA Zoom 100-300mm f/4.5-5.6	○
F.FA* Zoom 250-600mm f/5.6	×

- *1 : The focal length between 28-50mm, vignetting will NOT occur. But, inappropriate lens warning appears at the focal length between 24-35mm.
- *2 : Vignetting will occur at the focal length between 28-35mm. With the focal length set at 35mm, it will occur when the camera-to-subject distance is closer than 1.5m.
- *3 : Vignetting will occur at the focal length between 28-35mm. With the focal length set at 35mm, it will occur when the camera-to-subject distance is closer than 1.2m.
- *4 : Vignetting will occur at the focal length between 28-35mm. With the focal length set at 35mm, it will occur when the camera-to-subject distance is closer than 3m. With the focal length set at 40mm, it will occur when the camera-to-subject distance is closer than 1m. Vignetting will not occur at the focal length from 50mm to telephoto side.
- *5 : Vignetting will occur at the focal length between 80-135mm.



Without Daylight-Sync



With Daylight-Sync

Daylight-Synchro Shooting

Purpose

In bright daylight conditions, when a portrait picture is taken with a person's face cast in shadow, discharging the flash will expose the face without any shadow.

How to Set

Daylight-synchro photography is obtained in the same manner as the normal flash photography, so you simply depress the shutter release button.

- If the background is too bright, it may be overexposed.



Slow-Speed-Sync Shooting

Purpose

It is possible to photograph subjects and background in a balanced way by using the flash to properly expose the foreground subject and a slow-shutter-speed to expose the low light background.

How to Set

With the Manual Exposure Mode set

1. Depress the flash pop-up button to activate the built-in flash.
2. Set the camera's exposure mode to the Manual Exposure Mode.
3. Select an appropriate shutter speed/aperture combination for a correct exposure.
4. Take a picture.

How to Set

With the Shutter-Priority AE Mode set

1. Set the camera's exposure mode to the Shutter-Priority AE Mode.
2. Set the desired shutter speed.
 - When the aperture in the viewfinder and the LCD panel blink, a correct exposure will not be obtained for the background. Adjust the shutter speed until it stops blinking.
3. Depress the flash-pop up button to activate the built-in flash.
4. Take a picture.
 - In the Slow-Speed-Sync Shooting Mode, use of a tripod is recommended to prevent camera shake.

(8) USING A PENTAX DEDICATED EXTERNAL FLASH

If the built-in flash is not powerful enough, a Pentax dedicated external flash should be used.

Using the TTL Auto Flash

1. Remove the hot shoe cover F_1 and attach a Pentax dedicated flash unit.
2. Turn ON the flash.
3. Set the flash to the TTL Auto Mode.
4. Ensure that the flash is fully charged.
5. Focus on the subject and take a flash photograph.

- When the flash is fully charged, the ready lamp on the flash unit lights up. When the shutter release button is depressed halfway down, [] appears in the viewfinder indicating the flash is ready to discharge.
- Using the dedicated flash in each exposure mode is the same manner as use of the built-in flash, see page 67 to 71.

Multi-burst flash with the Pentax dedicated flash

When discharging more than 2 Pentax dedicated flashes, make sure that they are the same type of the flashes (refer to the overview of Flash Function on page 73.), combine the Type B with Type C or Type D with Type E. The built-in flash can be operated with any type of Pentax TTL dedicated flash unit.

Overview of Flash Function

CAMERA FUNCTION	TYPE A	TYPE B	TYPE C	TYPE D	TYPE E
After the flash is charged, the camera automatically switches to the flash-sync speed.	○	○	○	○	○
Automatic aperture setting in the Picture Mode, Programmed AE Mode or Shutter-Priority AE mode.	○	○	○	○*1	○*1
Flash confirmation signal in the viewfinder		○	○		
TTL auto flash	○	○	○	○*2	
Slow-speed sync in the Shutter-Priority AE Mode or Manual Exposure Mode	○	○	○	○	○*3
AF spotbeam		○	○		
Trailing-shutter-curtain flash sync (*4)	*5	○	○		
Contrast-control flash mode (*4)		○			

TYPE A : Built-in flash

TYPE B : AF500FTZ (*6), AF330FTZ

TYPE C : AF400FTZ, AF240FT

 TYPE D : AF400T, AF280T, AF200T, AF080C,
 AF140C, AF200S_A

TYPE E : AF200S, AF160, AF140,

 *2. Only the AF200S_A flash does not operate.

*3. Only the manual mode can be used.

*4. The shutter speed is 1/60 or slower.

 *5. Trailing-shutter curtain sync combined with
 TYPE B or TYPE C flash.

*6. Multi-burst and slave-synch flash are possible.

Using other type of a flash

 Use of non-Pentax flash units may damage the camera.
 For the best results, use the Pentax dedicated flash unit.

Notes:

- *1. When using a Type D flash (except AF200S_A) in the MS (manual sync) or M (manual) modes, or when using a Type E flash : set the camera's exposure mode to the Aperture-Priority AE, Manual or Bulb Mode. The Program, and Shutter-Priority AE modes cannot be used because the actual required aperture value may change.

AF500FTZ and AF330FTZ

- These flash units feature a built-in infrared spotbeam to assist the autofocus system in dim light and low-contrast conditions.
- The auto zoom function will automatically adjust the angle of discharge according to the lens focal length only when an F or FA lens is used.
- The AF500FTZ features a wireless slave-sync flash function.
- The flash effective range appears on the LCD panel only when an A, F, or FA lens is in use.
- Multiple flash burst on a single frame is possible with the AF500FTZ.
- These flash units feature the contrast control synch flash. See page 75 for more details.
- In the Picture Mode including the Green Operation Mode, Programmed AE, Shutter-Priority AE, or Aperture-Priority AE, even when the flash unit is set to the Manual, the TTL flash mode will be set automatically.
- When the flash is charged and left unused for about 3 minutes, the power automatically switches off to save battery power. Depressing the shutter release button halfway down will restart charging of the flash units.

AF240FT, AF400FTZ

- These flash units feature a built-in infrared spotbeam to assist the autofocus system in dim light and low-contrast conditions.
- In the Picture Mode, Programmed AE, Shutter-Priority AE, or Aperture-Priority AE, even when the flash unit is set to the manual position, the TTL Auto Flash Mode will be set automatically on the flash unit.
- When the flash unit is charged and left unused for about 5 minutes, the power automatically switches off to save battery power. Depressing the shutter release button halfway down will restart charging of the flash unit.

AF200T, AF280T, and AF400T

- If the TTL auto mode is selected, these flash units can be used for daylight-sync shooting, because the shutter speed is adjusted according to the ambient brightness. The slower shutter speed varies according to the lens focal length. However, when a non-autofocus lens is in use or the Action Program Mode is in use, the shutter speed is set to 1/100 of second. The aperture value will also be fixed but is changed depending on what ISO film is loaded.

- When using the Three-Level Auto (red, green, and yellow settings) mode, the aperture value is adjusted as shown in the table. When the flash is fully charged, the shutter speed also varies within the shutter speed range of 1/100 to a slower speed which does not cause camera shake. The slowest shutter speed varies according to the lens focal length. When a non-autofocus lens or the Action Program Mode is in use, the shutter speed will be set to 1/100 of second.

	AF200T	AF280T	AF400T
Red	f/2.8	f/4	f/4
Green	f/5.6	f/8	f/8
Yellow			f/11

with ISO 100

Notes on Pentax dedicated flash units

When the built-in flash is used in combination with a Pentax dedicated flash unit, if the trailing-shutter-curtain sync mode is set for the dedicated flash unit, the built-in flash also operates in the trailing-shutter curtain sync. mode. Ensure that both flash units are fully charged before releasing the shutter.

Contrast-Control Flash Photography

Using the AF330FTZ or AF500FTZ in combination with the built-in flash allows twin flash photography (contrast-control flash photography). This is based on the difference between the amount of light discharged from two units.

1. Put the AF500FTZ or AF330FTZ in the Contrast-Control Sync Flash Mode.
2. Ensure that both flash units are fully charged and then shoot.

- The ratio of the amount of flash light is 1 (built-in flash) : 2 (dedicated flash unit).
- When the AF500FTZ or AF330FTZ is used off the camera, the effect of contrast control is increased. Use an optional "Hot Shoe Adapter F" (uses two pcs. for the AF330FTZ) and "Extension Cord 5P" to connect the dedicated flash unit to the camera. Do not combine an accessory with a different number of contacts such as a "Hot Shoe Grip" as a malfunction may occur.
- In the Contrast-Control Sync Flash Mode, the top flash sync speed is 1/60 of second.

(9) ACCESSORIES (OPTION)

A number of dedicated accessories are available for this camera. For details, please see our brochures.

- **Cable Switch F**

A shutter release cord designed for use with the Z-70 PZ-70, Z-1_P PZ-1_P, Z-1 PZ-1, Z-20 PZ-20, Z-10 PZ-10.

- **Magnifier F_B**

A viewfinder accessory for magnifying the central area of the viewfinder.

- **AF500FTZ**

A TTL Auto Zoom flash with a built-in AF spotbeam and large guide number 50 in meters. It features slave sync flash function, multiple flash burst, contrast-control sync flash, leading/trailing-curtain-sync flash mode.

- **AF330FTZ**

A TTL Auto Zoom flash with a built-in AF spotbeam and guide number 33 in meters. It features contrast control flash sync, leading/trailing-curtain-sync flash mode.

- **Hot Shoe Adapter F and Extension Cord F5P**

An adapter and cord which allow the AF240FT, AF330FTZ, AF400FTZ and AF500FTZ to be used off the camera, while maintaining full electronic coupling to the camera.

- **AF Adapter 1.7X**

An adapter for autofocus photography using K_A- or K-mount lenses with a maximum aperture of f/2.8 or larger.

- **Macro Flash AF140C**

A TTL macro flash unit with a guide number 14 in meters.

- **Refconverter A**

Right angle finder which attaches to the grooves on both sides of the viewfinder. The viewfinder magnification is able to switch from 1X to 2X.

- **Filters**

Skylight, Cloudy, UV, Y2, O2, R2, and Circular Polarizing Filter are available. Each filter provides in sizes of 49mm, 52mm, 67mm and 77mm.

Notes on Accessories

- “Auto Bellows A” cannot be used in combination with the double cable release. When taking a vertical photograph, position the camera with the grip facing upward.
- When vertically positioning the camera with the tripod mount of the Pentax-F* 300mm f/4.5 ED(IF) lens with the grip facing downward, the tripod mount may hit the camera body. Position the camera with the grip facing upward.
- When attaching the “ADAPTER K FOR 645 LENS” to the camera body, the camera shift lock screw of the lens may hit the camera body. To avoid this, change the position of the fixing screw.
- When mounting the Reflex 1000mm f/11 or 2000mm f/13.5 lens to the camera body, the camera position shift lock screw of the lens may strike the camera body. To prevent this, change the position of the screw.
- When the AF200S_A, AF200T, AF280T, AF240Z, AF240FT or AF400FTZ is attached to the camera's hot shoe, the camera's main switch and Tv/Av button may be difficult to access.

(10) CAMERA CASE (SOFT CASE F_c)

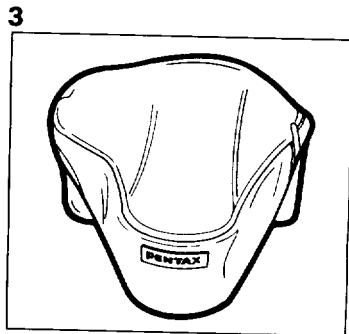
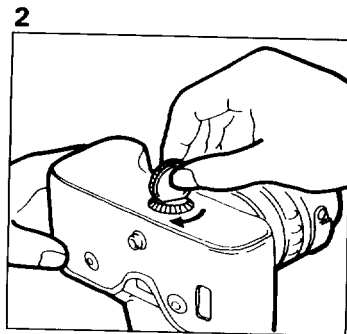
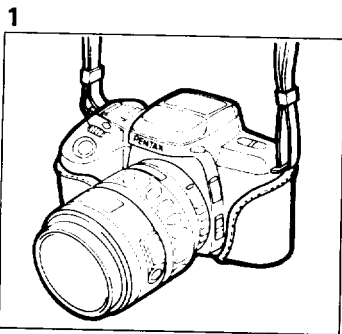

The soft case is available as an option and consists of a front and a back cover.

1. Open the front cover and place the camera body in the back cover.
2. Fasten the back cover to the camera body by tightening the fitting screw in the tripod socket.

- The front case of Z-70/PZ-70 camera is the same front case (F_cS, F_cM or F_cL) as the Z-10/PZ-10 and Z-20/PZ-20 cameras. Choose one of the front cases in accordance with the table to the right.

Front case comes in three sizes, S, M and L.

Case	Applicable F, FA-lens
F _c S	20mm, 28mm, 50mm f/1.4, f/1.7, Fish-Eye Zoom 17-28mm, Zoom 35-80mm
F _c M	24mm, Macro 50mm, 135mm, Zoom 28-70mm f/4, Zoom 28-80mm, Soft 85mm
F _c L	85mm f/1.4, Macro 100mm, Zoom 28-105mm, Zoom 70-200mm, F Zoom 80-200mm

(11) EFFECT OF APERTURE AND SHUTTER SPEED



High shutter speed



Slow shutter speed

A correct exposure is established by a combination of shutter speed and aperture setting according to the subject brightness. Actually, there are many correct combinations of shutter speed and aperture for a particular subject brightness. Different shutter speed and aperture settings produce different effects.

Effect of Shutter Speed

The shutter speed determines the film exposure time, or the amount of light striking the film as the shutter stays open for its designated time. If the subject is moving, its image will be blurred at a slow speed. In contrast, choosing a high shutter speed allows a frozen image to be taken of a moving subject. A high shutter speed also prevents camera shake. It is possible to enhance the motion of a wave or a waterfall by blurring the movement using a slow shutter speed.



Closed-down aperture



Open aperture

Effect of Aperture

The aperture increases or reduces the amount of reflected light from an object which passes through the lens, controlling how much light strikes the film. If the aperture is opened up to increase the amount of light, objects in front of and behind an in-focus subject will not be focused. That is, the range of focus (depth of field) becomes small. If the aperture is closed down to reduce the amount of light, the depth of field increases. For instance, if you shoot a person against a landscape with the aperture open, the landscape in front of and behind the person will be blurred, making the person appear to rise out of the landscape. By contrast, closing down the aperture increases the in-focus range.

(12) DEPTH OF FIELD

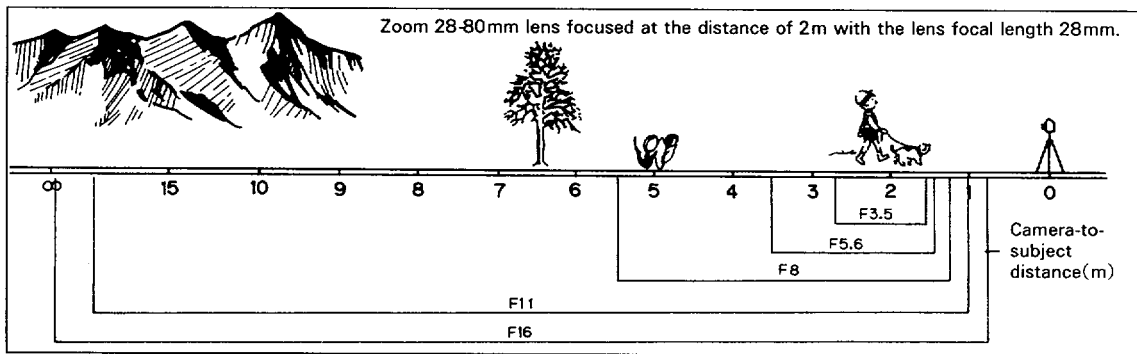

Depth of field refers to the range around the optimum focusing point of the subject in which the elements at different distances are in focus. The depth of field increases as the aperture is closed down, the focal length of the lens becomes shorter, or the subject is positioned farther away.

The Range Allowed for Focusing

The in-focus range varies depending on the aperture in use.

Zoom lenses do not have a depth-of-field scale for mechanical considerations.

(13) INFRARED INDEX

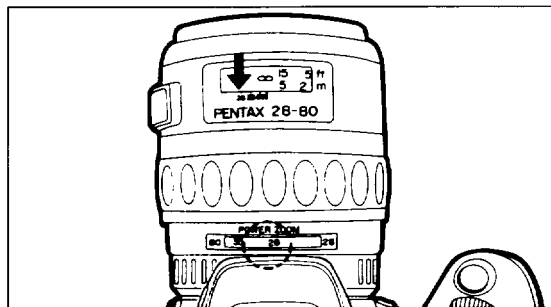

When infrared film and an R2" or "O2" filter are used, the focal point is different from that of ordinary film (exposed in visible light) is used. The autofocus system cannot compensate for this difference automatically.

1. Focus on a subject as usual.
2. Set the focus mode switch to **MF** and turn the focusing ring to the left by distance indicated on the infrared index.

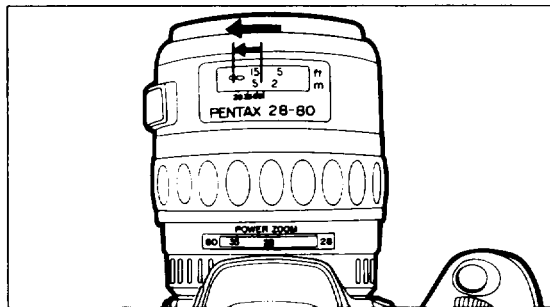

- As shown in the illustration, if 28 is read from the zoom scale, adjust the distance scale to 28 on the infrared index (red line).
- In the autofocus mode, the focus cannot be compensated for infrared photography.
- To set the proper exposure level for infrared pictures, refer to the instructions accompanying the film. The Programmed AE Mode does not give a correct exposure. Use the Manual Exposure Mode.

IV OTHERS























TROUBLESHOOTING

What appears troublesome may be easily remedied. Here are some problems that may occur and their remedies. Before contacting a Pentax service center, check the following items.

Symptoms	Causes	Remedies	Reference
The shutter does not release.	The main switch is [OFF].	Turn ON the main switch.	P.18
	The low battery warning [] appears.	Replace the battery.	P.14
	The battery is improperly installed.	Install the battery properly.	P.14
	The self-timer mode is being set.	Cancel the self-timer mode.	P.64
	The built-in flash is being charged.	Wait until the flash is fully charged.	P.35
Indicators do not appear on the LCD panel.	The main switch is not [ON].	Turn ON the main switch.	P.18
	No battery has been installed.	Install the battery.	P.14
	The battery is improperly installed.	Install the battery properly.	P.14
	The battery is dead.	Replace the battery.	P.14
The camera does not focus.	AF frame [] is not placed over the subject.	Move the camera until the AF frame [] covers the subject.	P.32
	The subject is too close.	Increase the camera-to-subject distance.	P.32
	The focus mode is set to [MF].	Set the focus mode switch to [AF].	P.31
	The subject is difficult to autofocus.	Use the focus-lock technique or focus manually using the matte field.	P.34 P.44
[] blinks in the viewfinder.	The subject is too close or difficult to autofocus.	Use the focus-lock technique or focus manually using the matte field.	P.34 P.44
The built-in flash does not charge.	The battery is dead.	Replace the battery.	P.14

Symptoms	Causes	Remedies	Reference
The exposure compensation cannot be set.	The main switch is set to the Green Operation Mode.	Set the main switch to [ON].	P.38
	The exposure mode is set to the manual exposure.	Set the exposure mode other than the manual exposure mode.	P.48 P.49
The power zoom system does not function.	The lens is in the manual zoom mode.	Push the power zoom ring forward until the words [POWER ZOOM] appear.	P.28
The lens focuses when zooming.	The camera focuses automatically when the power zoom is operated.		

SPECIFICATIONS

Type:	TTL autofocus, auto-exposure 35mm SLR with built-in TTL auto flash (RTF)
Format:	24x36mm
Usable Film:	35mm perforated cartridge film. DX-coded film with ISO 25-5000; non-DX coded films are set to ISO 100.
Exposure Mode:	Picture Mode (Green Operation Mode, Portrait Program Mode, Landscape Program Mode, Action Program Mode, Close-up Program Mode), Programmed AE Mode (Program-Shift is available), Shutter-Priority AE Mode, Aperture-Priority AE Mode, Manual Exposure Mode, Bulb Mode
Shutter:	Electronically controlled vertical-run focal-plane shutter, Electromagnetic release. Speed range:(1)Auto 1/2000-30 sec.(stepless),(2)Manual 1/2000-30 sec.(3)Bulb, Shutter lock by turning the main switch off.
Lens Mount:	Pentax K _{AF2} bayonet mount(K-mount with AF coupler, lens information contacts and power contacts)
Compatible Lens:	Pentax K _{AF2} -, K _{AF1} -, K _A -, and K-mount lenses are usable. Autofocus is possible using AF Adapter with K _A -mount lenses.
Autofocus System:	TTL phase-matching system, AF operational brightness range: EV0 to 18(at ISO 100 with f/1.4 lens), Focus lock available using shutter release button, Focus Mode: AF(predictive AF provided), Manual[MF]
Power Zoom:	3-Speed Intelligent Power Zoom lens with built-in motor with FA zoom lens
Viewfinder:	Penta-mirror finder, Natural-Bright-Matte focusing screen, Field of view:92%, Magnification:0.77X(with 50mm lens at ∞), Diopter: -1diopter.
Viewfinder Indication:	Focus Information:In-focus (Green lamp [ is lit), front or back focus signals and unable-to-focus indicator (Green lamp blinks), Shutter speed indication, Aperture indication, Flash ready indication [] is lit, Bar graph(exposure compensation), Over or Under exposure indication in Manual Exposure Mode, [] exposure compensation indication,
External LCD panel Indication:	[] = Green Operation Mode, [] = Portrait Program Mode, [] = Landscape Program Mode, [] = Action Program Mode, [] = Close-up Program Mode, [] = Programmed-AE Mode, [] = Shutter-Priority/Aperture-Priority AE Modes, [] = Manual Exposure Mode, [] = Bulb Exposure, [] = Film status information, [] = Battery exhaustion warning, [] = Built-in flash ready indication, [] = blinks rapidly Inappropriate lens warning, [] = Self-timer shooting, [] = PCV signal information, [] = Av value, [] = Tv value, [] = Red-eye reduction flash mode, [] = Single frame shooting mode, [] = Consecutive shooting mode, Exposure compensation value 0.3 to +0.3, Shutter speed indication 2000 to 30", Aperture value indication - f/1.2 to 90, Bar graph - Exposure compensation value, Over or under exposure indication in manual mode,

- Self-timer :** Electronically-controlled type with delay time of 12 sec. Start by depressing of shutter release button, Operation confirmation: By PCV beep tone. Cancelable after operation
- Mirror :** Quick-return mirror with AF secondary mirror
- Film Loading:** Film advances automatically to 1st frame after back cover is closed, Film information is provided
- Film Wind & Rewind:** Auto wind/rewind and rewind stop by built-in motor, Consecutive or Single advance mode, Approx.1.8 frames/sec.(consecutive mode), Auto rewinding starts at end of roll, Film rewind/completion of rewinding is displayed on the LCD panel, Auxiliary rewind button will rewind film in mid-roll
- Exposure Meter:** TTL multi(2)-segment metering, Metering range from EV1 to EV21 at ISO100 with 50mm f/1.4 lens
- Exposure compensation:** + / - 3EV in 0.5EV step increments
- Flash :** Series-control, Retractable TTL Auto Flash (RTF), Guide number:13 (ISO100/m), Illumination angle: Covers 28mm lens angle of view, Automatic switch to flash-sync-speed in the range from 1/100 to a slower speed, Day-light-sync flash, Slow-speed-sync flash, Contrast-control-flash sync (ISO range=25-400),
- Flash sync :** Hot shoe with X-contact with couples with Pentax dedicated auto flashes, ISO range=25-800
- Power Source:** One 6V lithium battery (2CR5 or equivalent)
- Battery Exhaustion Warning:** Battery exhaustion symbol [] is lit (blinking when the shutter is locked; no indication on the right-hand edge of the viewfinder.)
- Dimension and Weight:** 146.0mm(W)x93.0mm(H)x66.5mm(D) (5.7"x3.7"x2.6") 450g(15.9 oz) body only without lithium battery
- Supplied Accessories:** Hot Shoe Cover Fr, Release Socket Cap Fr, Camera Strap Fo, Eye Cup Fr, Finder Cap

SPECIFICATIONS ARE SUBJECT TO CHANGE AT ANY TIME WITHOUT NOTIFICATION OR ANY OBLIGATION ON THE PART OF THE MANUFACTURER.

Normal / Green Operation Mode Program Line

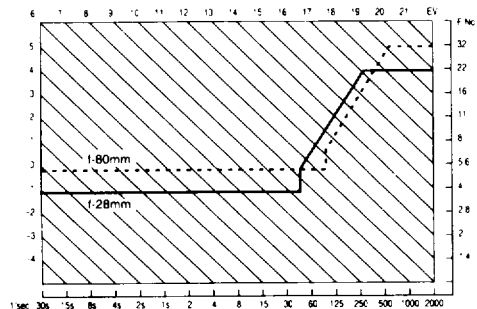

At ISO 100 with FA28 - 80mm f/3.5 - 4.7 lens

Landscape Mode Program Line

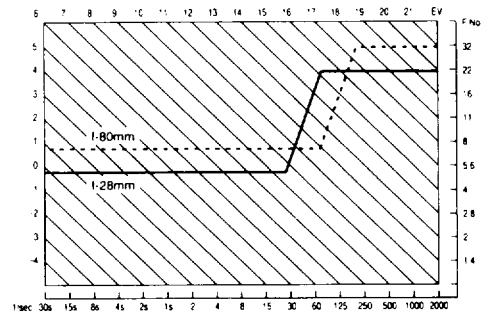

At ISO 100 with FA28 - 80mm f/3.5 - 4.7 lens

Portrait Program Mode Program Line

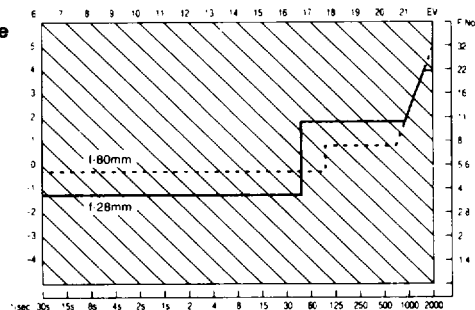

At ISO 100 with FA28 - 80mm f/3.5 - 4.7 lens

Action Program Mode Program Line

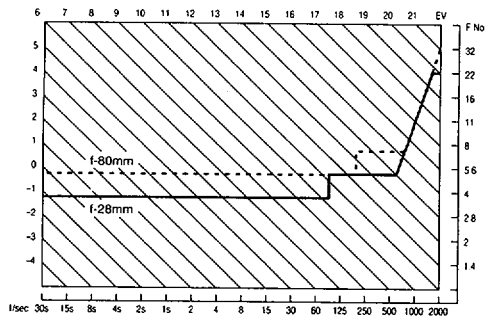

At ISO 100 with FA28 - 80mm $f/3.5 - 4.7$ lens

Close-up Program Mode Program Line

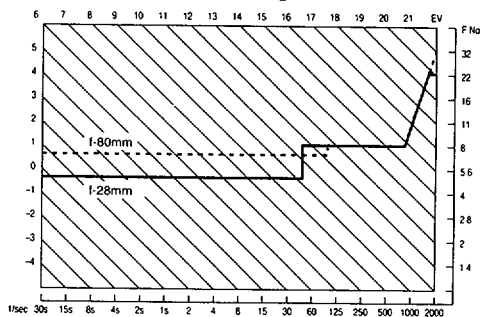

At ISO 100 with FA28 - 80mm $f/3.5 - 4.7$ lens

WARRANTY POLICY

All Pentax cameras purchased through authorized bona fide photographic distribution channels are guaranteed against defects of material or workmanship for a period of twelve months from date of purchase. Service will be rendered, and defective parts will be replaced without cost to you within that period, provided the equipment does not show evidence of impact, sand or liquid damage, mishandling, tampering, battery or chemical corrosion, operation contrary to operating instructions, or modification by an unauthorized repair shop. The manufacturer or its authorized representatives shall not be liable for any repair or alterations except those made with its written consent and shall not be liable for damages from delay or loss of use or from other indirect or consequential damages of any kind, whether caused by defective material or workmanship or otherwise; and it is expressly agreed that the liability of the manufacturer or its representatives under all guarantees or warranties, whether expressed or implied, is strictly limited to the replacement of parts as hereinbefore provided. No refunds will be made on repairs by non-authorized Pentax service facilities.

Procedure During 12-month Warranty Period

Any Pentax which proves defective during the 12-month warranty period should be returned to the dealer from whom you purchased the equipment or to the manufacturer. If there is no representatives of the manufacturer in your country, send the equipment to the manufacturer, with postage prepaid. In this case, it will take a considerable length of time before the equipment can be returned to you owing to the complicated customs procedures required. If the equipment is covered by warranty, repairs will be made and parts replaced free of charge, and the equipment will be returned to you upon completion of servicing. If the equipment is not covered by warranty, regular charges of the manufacturer or of its representatives will apply. Shipping charges are to be borne by the owner. If your Pentax was purchased outside of the country where you wish to have it serviced during the warranty period, regular handling and servicing fees may be charged by the manufacturer's representatives in that country. Notwithstanding this, your Pentax returned to the manufacturer will be serviced free of charge according to this procedure and warranty policy.

In any case, however, shipping charges and customs clearance fees to be borne by the sender. To prove the date of your purchase when required, please keep the receipt or bills covering the purchase of your equipment for at least a year. Before sending your equipment for servicing, please make sure that you are sending it to the manufacturer's authorized representatives or their approved repair shops, unless you are sending it directly to the manufacturer. Always obtain a quotation for the service charge, and only after you accept the quoted service charge, instruct the service station to proceed with the servicing.

The local warranty policies available from Pentax distributors in some countries can supersede this warranty policy. Therefore, we recommend that you review the warranty card supplied with your product at the time of purchase, or contact the PENTAX distributor in your country for more information and to receive a copy of the warranty policy.

STATEMENT OF FCC COMPLIANCE

This device complies with Part 15 of the FCC Rules. Operation is subject to the following two conditions : (1) This device may not cause harmful interference, and (2) this device must accept any interference received, including interference that may cause undesired operation.

Changes or modifications not approved by the party responsible for compliance could void the user's authority to operate the equipment.

This equipment has been tested and found to comply with the limits for a Class B digital device, pursuant to part 15 of the FCC Rules. These limits are designed to provide reasonable protection against harmful interference in a residential installation. This equipment generates, uses and can radiate radio frequency energy and, if not installed and used in accordance with the instructions, may cause harmful interference to radio communications. However, there is no guarantee that interference will not occur in a particular installation. If this equipment does cause harmful interference to radio or television reception, which can be determined by turning the equipment off and on, the user is encouraged to try to correct the interference by one or more of the following measures :

- Reorient or relocate the receiving antenna.
- Increase the separation between the equipment and receiver.
- Consult the dealer or an experienced radio/TV technician for help.

This Class B digital apparatus meets all requirements of the Canadian Interference-Causing Equipment Regulations.

NAMES OF WORKING PARTS II

- ① Rewind shaft
- ② Shutter curtains
- ③ Eyecup F (p.65)
- ④ Viewfinder eyepiece
- ⑤ Viewfinder accessory groove (p.65)
- ⑥ Hyper button (p.59,62)
- ⑦ Mode set button (p.25)
- ⑧ Film information window
- ⑨ Pressure plate
- ⑩ Back cover (p.19)
- ⑪ Back cover release pin
- ⑫ Film leader end mark (p.20)
- ⑬ Take-up spool (p.20)
- ⑭ Sprocket (p.20)
- ⑮ Battery chamber cover (p.14)
- ⑯ Tripod socket
- ⑰ Date back contacts
- ⑱ DX-information pin (p.20)
- ⑲ Film chamber

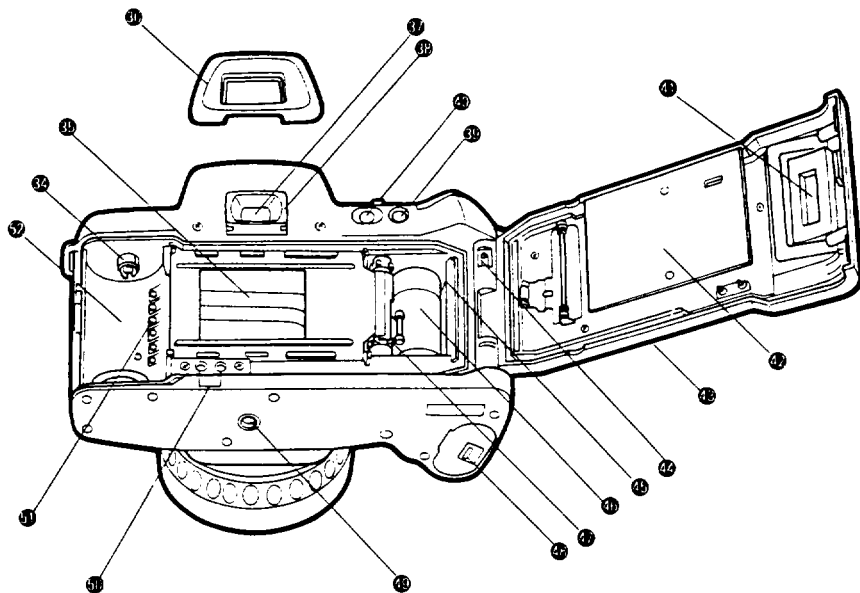



Asahi Optical Co., Ltd. 41-1 Nagata-cho 1-chome, Chiyoda-ku, Tokyo 100, JAPAN

Pentax Europe n.v. Weveldlaan 35, 1930 Zaventem, BELGIUM

Pentax GmbH. Julius-Vosseler-Strasse 104, D-22527 Hamburg, GERMANY

Pentax U.K. Limited. Pentax House, Heron Drive, Langley, Slough SL3 8PN, U.K.

Pentax France S.A. 12-14 rue Jean Poulmarch, 95106 Argenteuil Cedex, FRANCE

Pentax Benelux B.V. (for Netherlands) Spinnveld 25, 4815 HR Breda, NETHERLANDS

(for Belgium & Luxemburg) Weveldlaan 35, 1930 Zaventem, BELGIUM

Pentax (Schweiz) AG Industriestrasse 2, 8305 Dietlikon, SWITZERLAND

Pentax Scandinavia AB Bolandsgatan 15C, 75127 Lppsala, SWEDEN

Pentax Corporation 35 Inverness Drive East, Englewood, Colorado 80117, U.S.A.

Pentax Canada Inc. 3131 Universal Drive, Mississauga, Ontario L4X 2E5, CANADA