

OPERATING INSTRUCTIONS

CF-35 Series

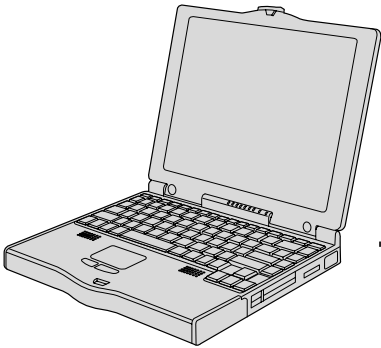

Contents

Getting Started	
Read Me First	5
First-time Operation	6
Operation	
Starting Up/Shutting Down	9
Computing On the Road	12
Using the Battery Pack	15
Security Measures	17
Infrared Data Communications	21
Add-ons/Peripherals	22
Usage, Carrying and Maintenance	27
Troubleshooting	
Computer Diagnosis	28
Dealing with Problems	29
Reinstalling Software	32
Appendix	
Windows 95 Setup Procedure	35
Setup Utility	36
Specifications	38
LIMITED USE LICENSE AGREEMENT	40
Index	43

CF-35 Quick Guide

(On-line manual on the hard disk)

Click  on the screen.



-Contents-

- CF-35 Readme
- Key Combinations
- Indicators

Customer's Record

Model No. _____ Dealer's Name _____
Serial No. _____
or
Code No. _____ Dealer's Address _____
Date of Purchase _____

Introduction

Thank you for purchasing the Panasonic CF-35 series computer. Please read the operating instructions thoroughly for proper operation of your new computer.





Illustrations in this Manual

- NOTE** : **NOTE** provides a useful fact or helpful information.
- CAUTION** : **CAUTION** indicates a condition that may result in minor or moderate injury.
- WARNING** : **WARNING** indicates a hazard that may result in moderate or serious injury, or even death.

[Start]-[Shut Down] : This illustration means to click [Start], then to click [Shut Down]
(For some applications, you may need to double-click.)

 : This illustration means to press the [Enter] key.

 +  : This illustration means to press [Fn], and while holding down on [Fn], to press [F2].

- Your manual uses  and  for explanation purposes. However, some computers may have the  and  keys instead.
- This manual covers several computer models. Items marked with the **CF-35******* indication apply to the specified model(s) only.

Copyright

This manual is copyrighted by Matsushita Electric Industrial Co., Ltd. with all rights reserved. No part of this manual may be reproduced in any form without the prior written permission of Matsushita Electric Industrial Co., Ltd.
No patent liability is assumed with respect to the use of the information contained herein.

©Matsushita Electric Industrial Co., Ltd. 1997. All Rights Reserved.

Disclaimer

Computer specifications and manuals are subject to change without notice. Matsushita Electric Industrial Co., Ltd. assumes no liability for damage incurred directly or indirectly from errors, omissions or discrepancies between the computer and the manuals.

Trademarks

PS/2™ is a trademark of International Business Machines Corporation.

Microsoft®, MS-DOS® and Windows® are registered trademarks of Microsoft Corporation of the United States and/or other countries.

Pentium® is a registered trademark, and MMX™ is a trademark of Intel Corporation.

TranXit™ is a trademark of Puma Technology, Inc.

PhoenixCard Manager™ is a trademark of Phoenix Technologies Ltd.

Panasonic® is a registered trademark of Matsushita Electric Industrial Co., Ltd.

Lithium Battery

Lithium Battery!

This computer contains a lithium battery to enable the date, time, and other data to be stored in it.

Should only be exchanged by service personnel.

Warning! Risk of explosion from incorrect installation or mis-application!

Litium batteri!

Denna dator innehåller ett litium batteri som används för att lagra datum, tid och annan data.

Bör endast bytas av servicepersonal. Explosionsfara vid felaktig hantering.

For U.S.A.

Federal Communications Commission Radio Frequency Interference Statement

Note: This equipment has been tested and found to comply with the limits for a Class B digital device, pursuant to Part 15 of the FCC Rules. These limits are designed to provide reasonable protection against harmful interference in a residential installation. This equipment generates, uses and can radiate radio frequency energy and, if not installed and used in accordance with the instructions may cause harmful interference to radio communications. However, there is no guarantee that interference will not occur in a particular installation. If this equipment does cause harmful interference to radio or television reception, which can be determined by turning the equipment off and on, the user is encouraged to try to correct the interference by one or more of the following measures:

- Reorient or relocate the receiving antenna.
- Increase the separation between the equipment and receiver.
- Connect the equipment into an outlet on a circuit different from that to which the receiver is connected.
- Consult the Panasonic Service Center or an experienced radio/TV technician for help.

Warning

To assure continued compliance, use only shielded interface cables when connecting to a computer or peripheral. Also, any changes or modifications not expressly approved by the party responsible for compliance could void the user's authority to operate this equipment.

This device complies with Part 15 of the FCC Rules. Operation is subject to the following two conditions:

- (1) This device may not cause harmful interference, and
- (2) This device must accept any interference received, including interference that may cause undesired operation.



For U.K.

FOR YOUR SAFETY PLEASE READ THE FOLLOWING TEXT CAREFULLY

This appliance is supplied with a moulded three pin mains plug for your safety and convenience.

A 3 amp fuse is fitted in this plug.

Should the fuse need to be replaced please ensure that the replacement fuse has a rating of 3 amps and that it is approved by ASTA or BSI to BS 1362.

Check for the ASTA mark  or the BSI mark  on the body of the fuse.

If the plug contains a removable fuse cover you must ensure that it is refitted when the fuse is replaced.

If you lose the fuse cover the plug must not be used until a replacement cover is obtained.

A replacement fuse cover can be purchased from your local Panasonic Dealer.

IF THE FITTED MOULDED PLUG IS UNSUITABLE FOR THE SOCKET OUTLET IN YOUR HOME THEN THE FUSE SHOULD BE REMOVED AND THE PLUG CUT OFF AND DISPOSED OF SAFELY.

THERE IS A DANGER OF SEVERE ELECTRICAL SHOCK IF THE CUT OFF PLUG IS INSERTED INTO ANY 13 AMP SOCKET.

If a new plug is to be fitted please observe the wiring code as shown below.

If in any doubt please consult a qualified electrician.

Important

The wires in this mains lead are coloured in accordance with the following code:

Blue:	Neutral
Brown:	Live

As the colours of the wires in the mains lead of this apparatus may not correspond with the coloured markings identifying the terminals in your plug, proceed as follows:

The wire which is coloured Blue must be connected to the terminal which is marked with the letter N or coloured BLACK.

The wire which is coloured Brown must be connected to the terminal which is marked with the letter L or coloured RED.

Under no circumstances should either of these wires be connected to the earth terminal of the three pin plug, marked with the letter E or the Earth Symbol .

The mains plug on this equipment must be used to disconnect the mains power.

Please ensure that a socket outlet is available near the equipment and shall be easily accessible.

How to replace the fuse

Open the fuse compartment with a screwdriver and replace the fuse.

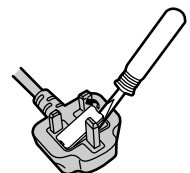

Warnings

- This equipment is not designed for connection to an IT power system.
(An IT system is a system having no direct connections between live parts and Earth; the exposed-conductive-parts of the electrical installation are earthed.
An IT system is not permitted where the computer is directly connected to public supply systems in the U.K.)
- Disconnect the mains plug from the supply socket when the computer is not in use.

This equipment is produced to BS800/1983.

For Germany

Warnung bezüglich der Lithiumbatterie (Sicherungsbatterie)

Lithiumbatterie!

Dieser Computer enthält eine Lithiumbatterie zur Sicherung von Datum und Uhrzeit der eingebauten Uhr sowie anderer Systemdaten im Speicher bei einer Unterbrechung der Hauptstromversorgung. Diese Sicherungsbatterie darf nur von Kundendienstpersonal ausgewechselt werden.

Warnung! Bei falschem Gebrauch besteht Explosionsgefahr!

Entsorgung gebrauchter Batterien nach Angaben des Herstellers.

For France

Avertissement concernant la pile au lithium (pile de sauvegarde)

Pile au lithium!

Le micro-ordinateur renferme une pile au lithium qui permet de sauvegarder certaines données comme la date et l'heure notamment. Elle ne devra être remplacée que par un technicien qualifié.

Avertissement! Risque d'explosion en cas de non respect de cette mise en garde!

Precautions

Usage

Avoid Extreme Heat and Cold

Do not store or use the computer in locations exposed to heat, direct sunlight, or extreme cold. Avoid moving the computer between locations with large temperature differences.

Operation: 5 °C to 35 °C (41 °F to 95 °F)

Storage: -20 °C to 60 °C (-4 °F to 140 °F)



Avoid Direct Sunlight on the LCD Panel

The LCD panel should not be exposed to direct sunlight or ultraviolet light.



Avoid Humidity Liquids and Dust

Do not store or use the computer in locations exposed to high humidity, liquids (including rain) or dust.



Prevent Shock

Avoid subjecting the computer to severe vibrations or impact. Do not place the computer inside a car trunk.

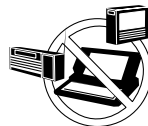

Avoid Radio Frequency Interference

Do not place the computer near a television or radio receiver.

Handling



Avoid Magnetic Fields

Keep the computer away from magnets.



Avoid Stacking

Do not place heavy objects on top of the computer.



Keep Small Objects Away

Do not insert paper clips or other small objects into the computer.



Do Not Disassemble the Computer

Do not attempt to disassemble your computer.



Avoid Excessive Force to the LCD Panel



Do not apply excessive downward force on the display when it is completely opened, especially when plugs and/or cables are connected to the rear of the computer.

Cables

Use of an interface cable longer than 3 m (9.84 feet) is not recommended.

Read Me First

Saving Data on the Hard Disk

- **Do not expose your computer to shock.**
Please use care when handling your computer, shock may damage your hard disk or make your software applications and data unusable.
- **Do not power down your computer while software applications are running or HDD indicator () is on.**
Properly shut Windows* down to avoid problems ([Start]-[Shut Down]).
- **Save all valuable data to floppy disks.**
Backing up data to floppy disks will limit damage should trouble occur to your computer or should you inadvertently change or erase data.
- **Use the security function for all important data.**
 page 17 - Security Measures

* This computer uses Microsoft® Windows® 95 Operating System.

Saving Data on Floppy Disks

- **Do not power down your computer or press the floppy disk drive eject button while the FDD indicator () is on.**
Doing so may damage the data on the floppy disk and render the disk useless.
- **Use care when handling floppy disks.**
To protect the data on your floppy disks or to prevent a floppy disk from becoming stuck in your computer, avoid the following:
 - Sliding the shutter on the floppy disk manually.
 - Exposing the disk to a magnetic field.
 - Storing the disk in locations prone to high temperatures, low pitched noise, dampness, or dust.
 - Applying more than one label on the disk.
- **Confirm the contents of a floppy disk before formatting it.**
Confirm that no important data is on the disk, because all data on the disk will be erased.
- **Use the write-protect tab.**
This is a must for preserving important data. This prevents your data from being erased or overwritten.

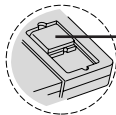

Write Enable

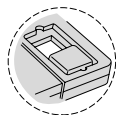

Write Disable

Computer Viruses

- **Users are advised to purchase the latest versions of virus protection software and use them regularly.**
We recommend you run the software:
 - When booting your computer.
 - After receiving data.We recommend that you check data received on floppy disks or from external sources, such as data downloaded from the Internet, e-mail, etc. (For compressed files, please uncompress them before running a check).

- **Disk Utilities not conforming to FAT32 should not be used in the computer.**

Running such programs may result in the incorrect display of hard disk drive (HDD) content or damage to data on the HDD. For more information, please read the "CF-35 Readme" in the "CF-35 series Quick Guide" (Click ).



- **Do not add the check mark to [DMA] in [Start] - [Settings] - [Control Panel] - [System] - [Device Manager] - [Disk drives] - [GENERIC IDE DISK TYPE**] - [Settings].**

It may damage to data on the hard disk.

Internet Explorer 4.0

Only CF-35PJJ8C*M/CF-35PJJ8C*E comes with Internet Explorer 4.0 already installed.

Internet Explorer 4.0 places a tremendous load on the system in order to execute the wide variety of functions that it provides. As a result, some unexpected faults may occur. If any of these faults occurs, try using the software with some Internet Explorer 4.0 functions turned off. (See Internet Explorer Help for more details.)

- **It takes a long time to reboot or the computer locks up.**
Delete the check mark for [Internet Explorer Channel Bar] in [Control Panel] - [Display] - [Web], then press .
- **The software cannot be upgraded (installed).**
At the [Welcome - Microsoft Internet Explorer] which appears at startup, delete the check mark for [Show this next time you log in] and restart the computer.
- **A system module error occurs.**
Set [(None)] for [Wallpaper] in [Control Panel] - [Display] - [Background].
- **Performing the above steps does not solve the problem.**
Uninstall Internet Explorer 4.0 with the following step. Select [Microsoft Internet Explorer 4.0] in [Start] - [Settings] - [Control Panel] - [Add/Remove Programs] - [Install/Uninstall] and press [Add/Remove]. Follow the on-screen instructions.
- **If a window with the message [Version Conflict] appears during the installation process (network card and application installation), select .**
Proper operation may not be possible if  is selected.

First-time Operation





It's now time to get started. Please read the steps below to help you learn what parts are included, and to gain an understanding of some basic computer-related operations.

1 Confirm the inclusion of all parts

Make sure the parts shown in the figure have been supplied. If any of them is missing or is not working properly, please consult your nearest Panasonic dealer.

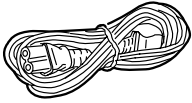
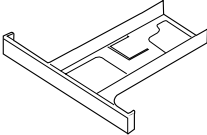
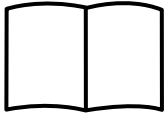
CAUTION

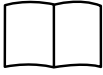
Please prepare 8 2HD formatted floppy disks to create backup disks of the Panasonic and the other utilities (☞ page 8; step 6). These backup disks are to be used when reinstallation of the Panasonic and the other utilities becomes necessary.

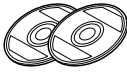
AC Adapter 1	AC Cord 1
 <p>CF-AA1526</p>	
Dummy FDD 1	Operating Instructions 1
 <p>For use in place of your floppy drive (☞ page 22)</p>	
TranXit 1	Windows 95 System Pack 1
  <p>Registration Card Accessory Catalogue</p>	<p>(Microsoft Corporation)</p>   <p>First-step Guide Registration Card</p>  <p>CD-ROM CF-35PJ8C*M/CF-35PJ8C*E ... 2 discs For all other models 1 disc</p>

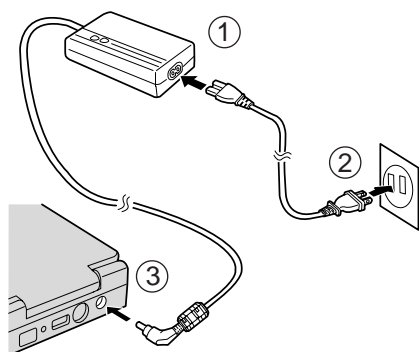

2 Connect your computer to a power outlet

CAUTION

Handling the AC adapter

- Do not twist or pull the AC power cord forcefully. Doing so may damage the connections.
- Use only the specified AC adapter (factory control number: CF-AA1526) with your computer. Using an AC adapter other than the one supplied might damage the battery and/or the computer.
- When the DC plug is not connected to the computer, disconnect the AC cord from your AC wall outlet as well. If the cord is kept connected, a very low level of power equivalent to approximately 1.1 watts* will be consumed.

*When the battery pack is not recharging or fully charged

- Problems such as sudden voltage drops/surges may arise during periods of thunder and lightning. Since this could adversely affect your computer, the uninterruptible power source (UPS) is highly recommended.
- Please make sure that the ferrite core is always attached to the plug of the AC adapter and in its proper position.

- ① The ferrite core can be removed by unlatching the clamps with a pair of mini-pliers, etc.

Clamps

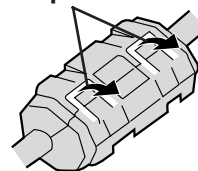

- ② When reattaching the ferrite core, match the end of the ferrite core to the third groove from the bottom of the plug (see diagram) before closing it.

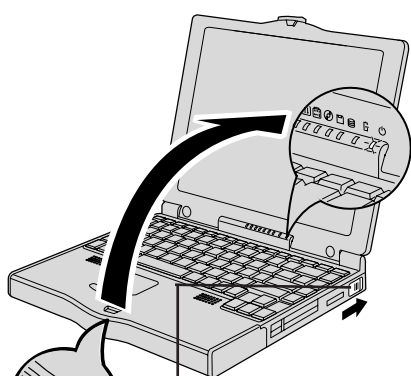
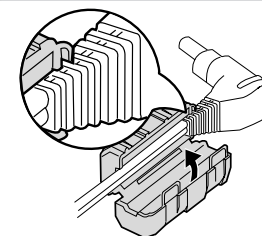

Latch

Move the power switch toward the rear direction and hold one second until the power indicator (⏻) goes on before releasing it.

3 Read the LIMITED USE LICENCE AGREEMENT (📄 page 34)

To open the display, slide the latch located at the front and lift open the display. Before removing the seal covering the power switch, please read the LIMITED USE LICENSE AGREEMENT. Removal of this seal indicates agreement to the terms specified. After you have agreed to the terms, you may turn your computer on.

CAUTION

- Do not slide the power switch repeatedly.
- After you have turned your computer off, you must wait ten seconds before you can turn it back on.

First-time Operation

4 Set Windows up

The [Windows 95 Setup] will run after the computer is turned on. Simply follow the on-screen instructions.

NOTE

- Please read the supplemental "Windows 95 Setup Procedure" for a more detailed explanation (☞ page 35).
- Moving the cursor (☞) or clicking buttons can be done through the touch pad (☞ page 10).
- If the display is dim or the sound quality is not right, you can adjust the brightness or contrast (for DSTN display models only) and volume (☞ page 39).

CF-35PJ8C*/M/CF-35PJ8C*/E only ▶
(For all other models, go to Step 6)

5 Close Internet Explorer 4.0

At the [Welcome - Microsoft Internet Explorer], select ☒ at the upper right portion to close the screen.

6 Double-click (Panasonic Setup icon) on Windows

(To create the backup disks and setup the factory-set)

Eight 2HD formatted floppy disks need to be prepared. Simply follow the on-screen instructions. The eight disks will contain the following (the check boxes ☐ are for you to confirm copy of the disks).

- Firstaid FD 1 disk
- Panasonic Tools Disk 1 disk
- TranXit Disk (1, 2) 2 disks
- Drivers Disk (1, 2) 2 disks
- PhoenixCard Manager™ 95 Disk (1, 2) 2 disks

CAUTION

- Restarting the system may take some time.
- Please store the backup disks in a safe place. They will enable you to return your computer to factory default settings should any problems occur.
- Do not remove the floppy disk while the FDD indicator (☐) is on, power down your computer or use the suspend function (☞ page 10).

● Inserting a floppy disk

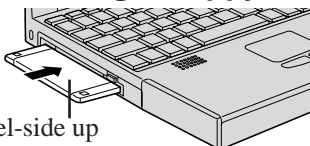

Label-side up

Label on the top surface, and inserting the shutter-side headfirst.

● Ejecting a floppy disk

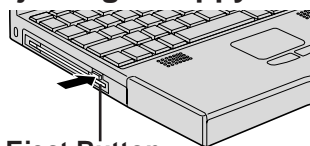

Eject Button

NOTE

About the CF-35 series Quick Guide

- This is available as an on-line guide which includes information on the key input commands, LED indicators and the "CF-35 Readme". The "CF-35 Readme" also contains detailed information.
- For the Quick Guide, we recommend setting the Desktop area to "800 by 600 pixels" or more, and the Color palette to "High Color (16 bits)" or more.

About Internet Explorer 4.0

Please select the item that you want to open from the menu on the [Welcome - Microsoft Internet Explorer].

CF-35PJ8C*/M/CF-35PJ8C*/E only ▶

This concludes the first-time use operation guidelines.

Starting Up/Shutting Down

Starting Up

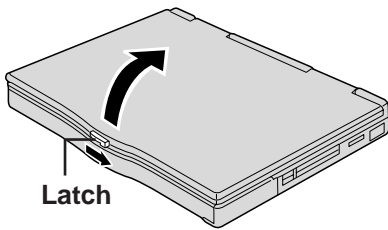

1 Open up the display

Slide the latch as shown and lift open the display.

NOTE

Do not turn on the computer with the LCD panel closed if an external monitor is not connected. The computer will not power on.

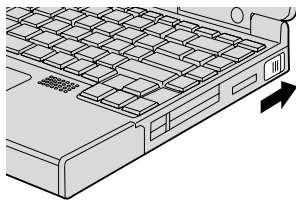

2 Turn your computer on

Move the power switch toward the rear direction and hold one second until the power indicator (⏻) goes on before releasing it.

CAUTION

- Do not slide the power switch repeatedly.
- After you have turned your computer off, you must wait ten seconds before you can turn it back on.
- If the computer does not turn on when the power is switched on, the temperature of the CPU has exceeded its normal operating temperature. In this case, a function designed to prevent it from overheating is triggered automatically and prevents the computer from turning on. Should this happen, allow the computer to cool down then switch the power on again.

If the computer still does not turn on, please consult your nearest Panasonic dealer.

● If is displayed,

you must first enter your User Password (☞ page 17).

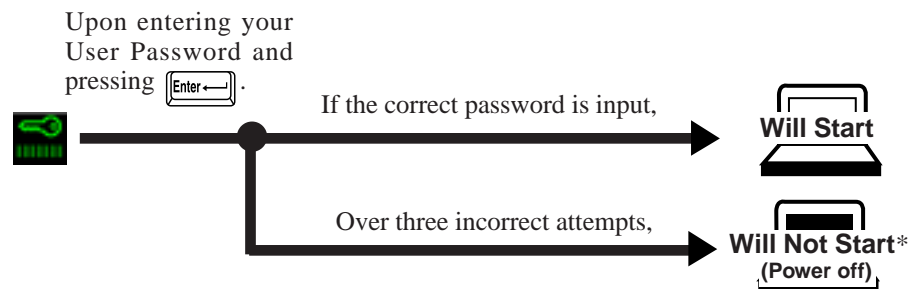

* If you are starting from the suspend mode (☞ page 10), if after three attempts the correct password is not input, or if no password is entered for about a minute, the computer returns to the suspend mode.

NOTE

If the display on the right appears, the network password has been set. To read and write data to other computers, the correct password must be entered.



● When an application or file that was previously displayed appears on your screen,

this means the suspend or hibernation mode (☞ page 10) has been set.

3 Select your application

You are able to start working on your computer.

Starting Up/Shutting Down

Using the Touch Pad

● Moving the cursor

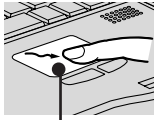

Work Surface

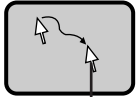

Cursor

Use the touch pad to move the cursor on the display and perform normal computer operations. It is not necessary to apply too much pressure on the work surface.

CAUTION

- Leaving your finger on the touch pad for more than 15 seconds will put your computer in the Calibration mode. In this mode, there are instances where even if you slide your finger on the work surface, the cursor will not move. In such cases, you have to lift your finger from the work surface and apply your finger to the work surface again.
- When using drawing applications like Paint, please try to draw in the center of the work surface. There are cases where lines drawn later appear to have been drawn incorrectly.

● Clicking



One tap

or



One tap

● Double-clicking

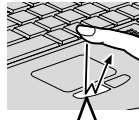

Two quick taps

or



Two quick taps

● Dragging



While holding down the button, moving your finger on the work surface

or

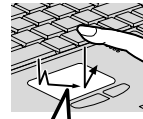

Two quick taps, but on the second tap leaving your finger down (applying pressure) and moving it on the work surface. One tap when your finger will "drop" the object.

NOTE

To change the touch pad settings, select [Mouse] in [Start] - [Settings] - [Control Panel]. Even if [Left-handed] is selected in the mouse settings, tapping the touch pad will have the same effect as clicking the left button of the touch pad.

Shutting Down (power off your computer)

1 To shut down, save all data and select [Shut Down] from the [Start] menu

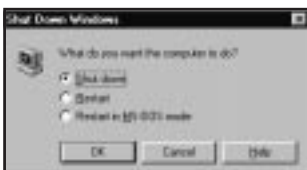

NOTE

From the keyboard, you may choose to press down on  then select [Shut Down].



(The display varies depending on the models.)

2 Confirm shutdown

Select [Shut down] (or [Shut down the computer?]), then press  (or ).

Your computer will power off automatically.

(In the OFF state, if you are not recharging your battery pack or if the pack is fully charged, your computer and the AC adapter consume approximately 1.1W.)

● Restarting your computer (without shutting down)

Select [Restart] (or [Restart the computer?]), then press  (or .

NOTE

To quickly resume computer operation after shutting down, the suspend and hibernation functions are available. ( below)

Starting Up Your Computer Quickly

If you want to immediately start up and continue an application after shutting down your computer, you can do so by using the suspend or hibernation function.

● Differences between suspend function and hibernation function

Function	Where data is saved to	Speed	Requires power supply
Suspend function	Memory	Fast	Yes (if power is cut, all data is lost)
Hibernation function	Hard disk	Somewhat slow	Power not required to maintain data



Power Switch

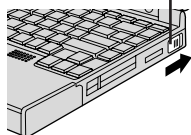

Do not touch the power switch while your computer is entering the hibernation mode.



Shutting Down

● Using the suspend function

NOTE

You can use the suspend function by selecting [Suspend]* from [Start] menu.

* [Suspend] is deleted from the [Start] menu by unchecking [Allow Windows to manage power use on this computer.] in [Start] - [Settings] - [Control Panel] - [Power] or by unchecking [Show suspend command on Start menu] in [Advanced].

● Using the hibernation function

It is necessary to set the hibernation function using the Setup Utility.

- 1 Run the Setup Utility (☞ page 36)
- 2 Using and , select [Power Management] then press
- 3 Using and , select [Power Switch], set [Hibernation] with , then press
- 4 Close the Setup Utility (☞ page 36)

CAUTION

- Save all data before powering off your computer.
- When restarting from or shutting down to the suspend or hibernation mode, do not touch the touch pad (or move the mouse (serial or PS/2 type) if one is connected). There are cases where these devices will fail to operate; you will have to restart your computer using the keyboard (☞ page 10).
- Do not power off during the following periods (you may corrupt your data or file):
 - While the FDD indicator (), HDD indicator () or CD-ROM indicator () (CD-ROM drive is an optional part) is on.
 - While playing/recording audio files.
 - While communications software is being used.
- Do not use the suspend or hibernation function when using an OS other than Windows 95, the diagnostics program (DIAG35), or the Setup Utility, or when experiencing static electricity or noise.
- If you hold down on the , or to enter the suspend or hibernation mode, after resuming operation, you must press the same key. For example, if you hold down on the key while sliding the power switch, upon resuming, if you do not press the key again, only capital letters will result from typing.
- If your computer locks up, press the reset button. All data is lost when this button is pressed.
- In the suspend mode, power is consumed. If PC cards (e.g., modem card) are inserted, more of that power is consumed. When all power has been consumed, all data at shutdown is lost since it is retained in memory. We therefore recommend plugging in the AC adapter when using the suspend function.
- When the file in the external devices such as a CD-ROM drive, external hard disk, or ATA cards is opened, the suspend or hibernation function may not work. In such cases, close the file.
- SCSI cards may not recover operation after entering the suspend or hibernation mode. If this occurs, restart the computer.

Power Switch

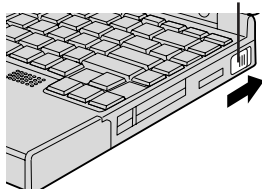

Resuming Operation

If is displayed upon sliding the power switch, your password has been set (☞ page 9).

CAUTION

When operation resumes, serial devices such as a mouse or modem, or your PC Cards may not work. In such cases, you will need to restart your computer or reinitialize the individual devices.

Computing On the Road





One of the main features of notebook-type computers is that you have the power of computing away from your home or office. In the following, information is provided on how to maximize use of the battery pack which is necessary for such computing.

● Four Important Points

- POINT 1** Be sure to charge your battery before and after use.
- POINT 2** To get the maximum use of your battery, set the power management mode.
- POINT 3** Check to see that you have your AC adapter with you before leaving your home or office.
Purchasing an extra battery (CF-VZS351) or the optional battery charger (CF-VCB251A) is highly recommended.
- POINT 4** Always watch your battery level!

Conserving Power

Things to Remember















- **Leave your computer off when it is not in use** (☞ page 10)
- **Adjust the brightness (dark) with**  +  (☞ page 39)
- **Before stepping away from your computer, press**  +  **to put your computer in the standby mode**
The standby mode helps you conserve power by cutting off power to the hard disk drive's motor and LCD. To resume, you may press any key.
- **In the power management mode, the setting of [Advanced] is recommended** (☞ page 13)
With the Setup Utility, you can set the [Advanced] mode. This mode allows you to maximize power save regardless of whether you are using only the battery pack or the AC adapter.
- **Setting the hibernation timeout** (☞ page 13)
The hibernation function (☞ page 10) allows you to save power by automatically cutting off power when the computer is idle or there is no access to individual devices for 4 or 16 minutes. If [Advanced] or [Standard (Battery/AC adapter)] is selected for [Power Saving], the hibernation timeout function will go into effect for both the battery pack and the AC adapter. If, however, [Standard (Battery)] or [OFF] is selected for [Power Saving], it will go into effect only during operation by the battery. The standby timeout function is automatically set when [Advanced] or [Standard] is set. Note that the standby timeout precedes the hibernation timeout.
It should be noted that for some applications, the hibernation timeout will not work properly.

NOTE



If you plan to use only the battery pack or set the power management, it is necessary to check [Allow Windows to manage power use on this computer] in [Start] - [Settings] - [Control Panel] - [Power]. If no check is added, the hibernation timeout will not occur.

Setting Power Management

(How to set [Advanced] and the hibernation timeout)

- 1 Run the Setup Utility (☞ page 36)
- 2 Using  and , select [Power Management] then press 
- 3 Using  and , select [Power Saving] then set [Advanced] with 
(To avoid setting the hibernation timeout, press  and proceed on to step 6.)
- 4 Using  and , select [Power Switch] then set [Hibernation] with 
- 5 Using  and , select [Hibernation Timeout], set either [4 min] or [16 min] with  then press 
- 6 Close the Setup Utility (☞ page 36)

NOTE

If you would like to temporarily disable your power management settings, press  + . When pressed again, or when the computer is restarted (including suspend or hibernation function), the settings are enabled.

● Power Management settings

Power Management	Functions automatically set	CPU Speed Change Mode	HDD Motor Timeout	Standby Timeout
Advanced		Enable	1 min	1 min
Standard (Battery/AC adapter)		Enable	1 min	2 min
Standard (Battery)*		Enable	1 min	2 min
OFF		Disable	Never	Never

* Enabled only when the battery itself is being used.

- CPU Speed Change Mode : In this mode, the CPU is automatically stopped when there are no operations.
- HDD Motor Timeout : When the hard disk drive is not accessed for more than a minute, power to the motor is shut off.
- Standby Timeout : When the computer is idle or a device is not accessed for one or two minutes, the computer enters the standby mode (☞ page 12).





CAUTION

When you need a network environment.

Be sure to disable hibernation timeout settings in the Setup Utility .

After resuming operation from the hibernation mode, the network connection may be severed or the computer will not work properly.

In communications when a device like a high-speed modem or ISDN terminal adapter is connected to the serial port, etc.

There are times when high-speed communication is adversely affected if the power management function is enable. Please confirm that  is displayed for a few seconds by pressing  +  to disable the power management function. After you have finished using a communication device, you can enable the power management function by pressing  + .

Key operation and music playback

When the power saving function is running, the keyboard and mouse operations may feel sluggish. Also, music may not play correctly when entering the standby mode during operation.

Computing On the Road

Battery Status

Use the Battery Indicator () to Check on the Battery Status

Battery Indicator	Battery Status
Orange*	Charging
Green*	Fully-charged
Red	Battery charge is low (the charge is less than approx. 9% capacity)
Blinking red*	Battery pack or charger may not be working properly. Check your connections. If the problem persists, consult your nearest Panasonic dealer.
Blinking orange for 5 seconds after the AC adapter is connected*	Unable to recharge due to violation of temperature limits ( page 15)

* When the AC adapter is connected.

NOTE

When using the optional CD-ROM pack:

Recharging is temporarily stopped when the drive is being accessed. In this case, the battery indicator goes off temporarily.

In addition, recharging is temporarily discontinued when the CD-ROM AutoPlay function is enabled. For more information, please read the operating instructions that are supplied with the CD-ROM pack.

● Getting a detailed reading

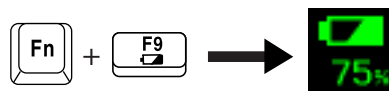

NOTE

- When the battery indicator remains red (or a 99% reading is displayed) for an extended period of time, the actual remaining battery level and the displayed level may differ. Should this occur, charge the battery until the indicator is green, then completely discharge the battery.
- When the battery pack is not in the computer,  is displayed.

When the Remaining Battery Charge Becomes Low



save your data and power off your computer

Perform the following:

- Plug in the AC adapter, and fully charge your battery.
- Use a spare battery if you have one.
- If you have neither the AC adapter nor an extra battery, power the computer off.

● If the hibernation function is set



** When disabling the speakers with the Setup Utility (or pressing  + ), the warning beep is also disabled.

● If the hibernation function is not set

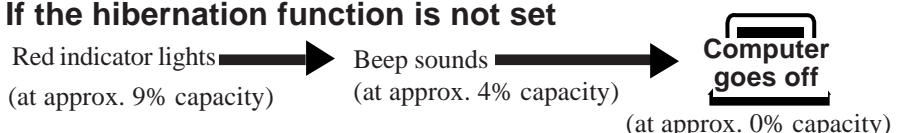

Using the Battery Pack

Precautions

- Care should be exercised with regard to the following in order to avoid the possibility of liquid leakage, overheating, or bursting.
 - Do not throw the battery pack into a fire or expose it to heat.
 - Do not place the battery pack together with articles such as necklaces or hairpins when carrying or storing.
 - Do not insert sharp objects into the battery pack, expose it to bumps or shocks, deform, disassemble, or modify it.
 - Do not short the positive (+) and negative (-) contacts.
 - The battery pack is a rechargeable battery intended for use with the CF-35 series or the specified charger (CF-VCB251A). Do not use it with a computer other than the one for which it was designed.
 - Do not charge, use or leave the battery pack for extended periods where it will be exposed to direct sunlight, in a hot place (in an automobile on a sunny day, for example), or in a cold place.
- Do not touch the terminals on the battery pack. The battery pack may no longer function properly if the contacts are dirty or damaged.
- Do not expose the battery to water, or allow it to become wet.
- Do not put the battery into a microwave oven or a pressurized chamber.
- This computer prevents overcharging of the battery by recharging only when the remaining power is less than approx. 95% of capacity.
- If the battery should leak and some of the fluid get into your eyes, do not rub your eyes. Immediately flush eyes with clear water and see a doctor for medical treatment as soon as possible.
- Should the battery emit an abnormal odor, become hot to the touch, become discolored, change shape, or become in any way different from normal, remove it from the unit or charger and discontinue use.
- If the battery pack will not be used for a long period of time (a month or more), charge the battery pack until the remaining battery become 30% to 40% and store it in a cool, dry place.

NOTE

- The battery pack may become warm during recharging or normal use. This is completely normal.
- Recharging will not commence outside of the allowable temperature range (5 °C to 35 °C (41°F to 95 °F)). To allow the battery to charge, adjustments have to be made to the temperature. Once the allowable range requirement is satisfied, charging begins automatically. Note that the recharging time varies based on the usage conditions.
- If the temperature is low, the operating time is shortened. Therefore, please use the computer within the allowable temperature range.
- Although the battery has not begun to run down, the battery indicator may light up red or emit a beep. This indicates a significant rise in the temperature of the battery pack. This is typically caused by the fact that the battery pack has been delivering a high level of power because the computer has been used with the display at the brightest setting and with the power-saving function off. In order to protect the battery pack from temperature rises, the computer's processing speed is automatically reduced and the battery temperature is brought down. It is also a good idea to connect the AC adapter, set the power-saving function, and turn down the brightness of the display. When the temperature has dropped, the computer's regular processing speed will be restored.

Using the Battery Pack

Replacing the Battery Pack

When the charge provided by your battery pack is supplied for only a short period of time, even after fully charging according to the instructions, it may be time to replace your battery pack. The battery pack is a consumable item and therefore will require replacement (CF-VZS351).

CAUTION

The charging terminal of the battery pack is used for charging using the battery charger (CF-VCB251A), which is sold separately. Never connect anything to the charging terminal other than the exclusive adapter that is supplied with the battery charger. Doing so could damage the device connected to the battery pack, the cable, and the battery pack itself, as well as resulting in overheating or bursting.

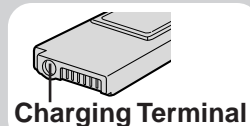

1 Power off your computer (☞ page 10)

Do not shut down using the suspend mode.

CAUTION

In the suspend mode, do not remove/change the battery pack. Removing the pack in the suspend mode will erase your data and may damage the computer.

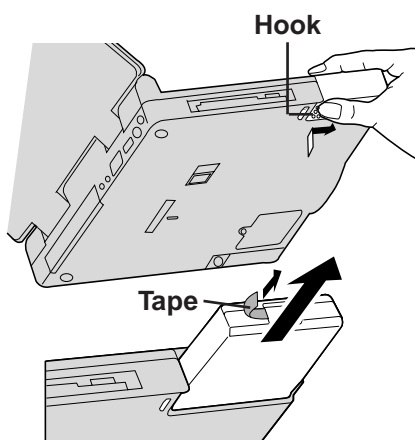

2 Remove the battery pack cover

Open your display. After pressing the hook on the bottom of the computer, slide to remove the cover.

3 Taking out the battery pack

Pull the tape on the battery pack and remove it from the computer.

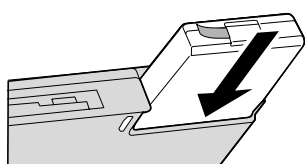

Inserting a battery pack

Push the pack in until it is in place.

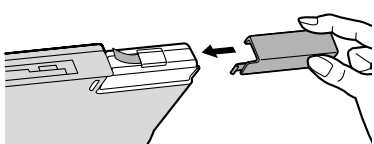

4 Reattach the battery pack cover

Slide the cover in until it snaps into place.

CAUTION

- Make sure to properly remove and reattach the cover. Using excessive force (e.g., trying to snap it back into place) may cause the cover to break.
- An improperly attached cover may allow your battery pack to fall out while you are carrying your computer.

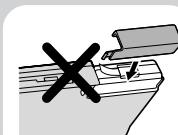

NOTE

Besides the AC adapter (CF-AA1526) an optional battery charger (CF-VCB251A) is available. This device is convenient in that it allows you to charge another battery pack while you are using the computer.

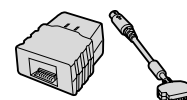

Security Measures

To prevent unauthorized access of your computer the various security measures are provided below.

Situation	Function to use	Reference
You do not want your computer to be used without permission	User Password	☞ below
Same as above, but while you're away temporarily	Coffee break Password	☞ page 18
You want to prevent theft or damage to data by using a floppy disk	Prevent operation by using a floppy disk	☞ page 19
	Remove floppy disk drive	☞ page 22
You do not want your Supervisor Setup changed without permission	Supervisor Password	☞ page 19
You want to prevent theft of your computer	Use a security lock	☞ page 39

When you do not want your computer to be used without permission

Set the User Password.

Without the password, access to your computer is impossible.

● When the User Password is set

Upon entering your User Password and pressing .



If the correct password is input,









Over three incorrect attempts,





* If you are starting from the suspend mode (☞ page 10), if after three attempts the correct password is not input, or if no password is entered for about a minute, the computer returns to the suspend mode.

Setting the user password (enabling, changing, disabling)

- 1 Run the Setup Utility (☞ page 36)
- 2 Using  and , select [System Setup] then press .
- 3 Using  and , select [User Password] then press .
- 4 ● To enable or change your password





Enter your password at the [Enter User Password], then press .

CAUTION

- Your password will not be displayed on the screen.
- Please limit your password to seven characters. Note that there is no distinction between upper and lower case letters.
- White colored keys can be used. Note that space bar and function keys cannot be used.
- Do not input your password while holding down on the  or .
- Use only the upper horizontal row of numeric keys to input user passwords. The numeric keys combined with alphabet keys on the lower keyboard cannot be used.
- Do not forget your password. If a password is forgotten you will be unable to use your computer.

● To disable your password

Using the  and  keys, select [Delete User Password] then press . Go to step 7.

- 5 Re-enter your password at the [Enter User Password Again] (This is for confirmation purposes.)
- 6 Using  and , select [Set User Password] then press .
- 7 At the confirmation screen, press .

Security Measures

8 Press  to end the password setting procedure

9 Close the Setup Utility ( page 36)

CAUTION

To prevent the changing of your password without permission



- When running the Setup Utility program, do not leave your computer even for a short time.
- Set the User Password Protection option ( page 20).

You do not want your computer to be used without permission while away temporarily

You should set the “Coffee break Password” (Note that you must first set the User Password). When you input your selected key combination, the computer locks (key input, use of the touch pad and use of an external mouse are no longer possible).





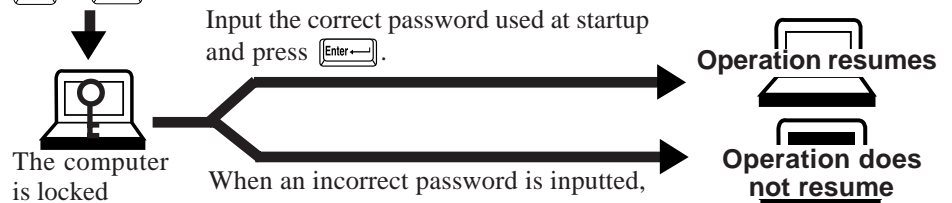

● When the coffee break password is set

When leaving your desk

 +  +  (Example of a selected key combination)



CAUTION

- Do not leave your computer just after sensitive data had been shown on the screen.
- It is impossible to lock your computer from an external device, such as a mouse connected through the serial port.
- During the coffee break,  is displayed on the screen. If the operations described below are performed during the coffee break, the  indication may disappear. In order to quit the coffee break and begin using the computer, input your password.
 - If a different popup window is displayed by using the  +  or  +  key combination.
 - If the computer is returned from the standby mode.
 - If the serial mouse is moved.

Setting the Coffee break Password (enabling or disabling)

1 Set the User Password ( page 17 step 1 to 7), if it hasn't already

2 ● To enable the Coffee break Password

Using  and , select [Coffee break Password] then set [Enable] with .

● To disable the Coffee break Password

Using  and , select [Coffee break Password] then set [Disable] with .
Go to step 4.

3 Using  and  keys, select [Key Combination for Coffee break] then set your combination of keys with .

4 Press  to end the password setting procedure

5 Close the Setup Utility ( page 36)

When you want to prevent theft of or damage to data by using a floppy disk

You may choose to protect the data on your computer from being accessed illegally or overwritten accidentally by using a floppy disk. You can also set your computer to be unbootable from a floppy disk.

NOTE

To prevent the use of floppy disks altogether, you may also choose to remove the floppy disk drive (☞ page 22).

● Preventing the use of a floppy disk

This error message is displayed.

Even when one tries to access a floppy disk,

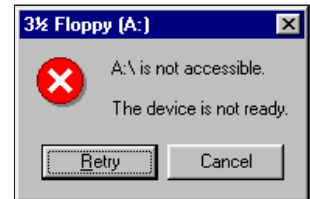

Procedure

- 1 Run the Setup Utility (☞ page 36)
- 2 Using and , select [Supervisor Setup] then press
- 3 Using and , select [Boot Up Drive] then set either [HDD → FDD] or [CDD → FDD → HDD] with

CAUTION

When changing to [HDD → FDD] or [CDD → FDD → HDD] setting, to continue read/write operation from a floppy disk and to use the hard disk drive or CD-ROM to start, press and go to step 5.

- 4 Using the and , select [Floppy Operation], set [Disable] with then press
- 5 Close the Setup Utility (☞ page 36)

When you do not want your Supervisor Setup changed without permission

Set the Supervisor Password. After it has been set, no changes can be made to the Supervisor settings unless the password is entered.

● When the supervisor password is set

In the Setup Utility (☞ page 36),

if is displayed,

Input the correct supervisor password and press ,

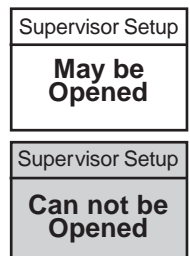

When the supervisor password is incorrect or when the user password is entered, (Or, even when the correct supervisor password is entered. (☞ page 31))

(There are cases in which the Supervisor Setup does not appear on the main screen (☞ page 36)).







NOTE

You may wish to protect the User Password (☞ page 20).



Security Measures

Setting the Supervisor Password



(enabling, changing, disabling)

- 1 Run the Setup Utility (☞ page 36)
- 2 Using  and , select [Supervisor Setup] then press .
- 3 Using  and , select [Supervisor Password] then press .
- 4 ● To enable or change your supervisor password
Enter your password at the [Enter Supervisor Password], then press .

CAUTION

- Your password will not be displayed on the screen.
- Please limit your password to seven characters. Note that there is no distinction between upper and lower case letters.
- White colored keys can be used. Note that space bar and function keys cannot be used.
- Do not input your password while holding down on the  or .
- Use only the upper horizontal row of numeric keys to input user passwords. The numeric keys combined with alphabet keys on the lower keyboard cannot be used.
- Do not forget your password. If a password is forgotten you will be unable to use your computer.

● To disable your supervisor password



Using  and , select [Delete Supervisor Password] then press . Go to step 7.





5 Re-enter your password at the [Enter Supervisor Password Again]

(This is for confirmation purposes.)

NOTE

When you do not want the User Password enabled, changed, or disabled without permission,

use  and  to select [User Password Protection], then set [Enable] with .

- 6 Using  and , select [Set Supervisor Password] then press .
- 7 At the confirmation screen, press .
- 8 Press  to end the password setting procedure
- 9 Close the Setup Utility (☞ page 36)

Infrared Data Communications

Your computer is equipped with an infrared communications port enabling you to transfer data without a cable.

Preparations for Infrared Data Communications

- Set the address of your infrared communications port to enable.
- Position your computer so that the port is face-to-face with the port of another computer.
- Be sure the computers are not in direct contact with one another.
- A port-to-port distance of 20 to 50 cm (8 to 20 inches) is recommended.

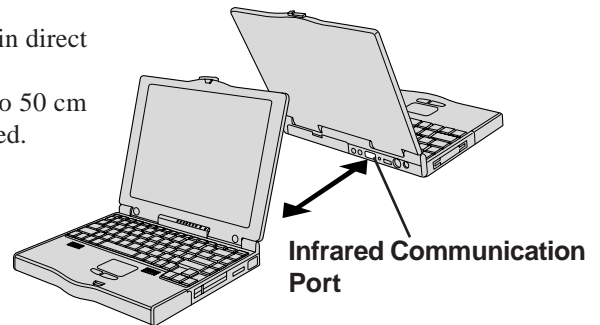

CAUTION

In the Setup Utility, select [IrDA] in the [Supervisor Setup] and set [Automatic (PnP)] or [2F8]. Setting [OFF] will make infrared data communications impossible.

Problems with infrared data communications

- An object is located between both ports.
- There are other electronic devices nearby causing interference, such as, a television, VCR, wireless headphone, etc.
- Direct sunlight or white glowing light, such as fluorescent lighting; can cause interference with communications between the ports.

Running TranXit™

TranXit comes preinstalled and allows you to perform infrared data communications such as transfer data and update information between two computers. Note that both computers need to have TranXit installed and running.

Running the program

Select [TranXit] from [Start] - [Programs] - [TranXit].

NOTE

Online help is available on how to use TranXit. Click [TranXit Quick Reference Guide] in [Start] - [Programs] - [Panasonic]. (Reinstalling TranXit; page 34)



Setting or changing the “Computer Name”

It is necessary to assign a different “Computer Name” to each computer; select [Computer Name] in [Setup] to change the name.

CAUTION

- In [Control Panel]-[Add New Hardware], if [Infrared] is added, TranXit can not be used. For TranXit to be operable, [Infrared] must not be set.
- Exit TranXit software before entering the suspend or hibernation mode. Start TranXit again after the computer resumes.

Add-ons/Peripherals

Devices capable of being used by your computer are listed in the table below.

Device(s)	Where to connect	Reference
CD-ROM drive (CF-VCD351)	Multimedia Pocket	☞ below
PC Cards (Modem, LAN, SCSI, etc.)	PC Card Slots	☞ page 23
Serial Devices (Mouse, Modem, etc.)	Serial Port	☞ page 39
Extra Memory	RAM Module Slot	☞ page 24
Port Replicator (CF-VEB351)	Expansion Bus Connector	☞ page 25
External Display	Ext. Display Port	☞ page 25
Printer	Parallel Port	☞ page 25
Keyboard, External Mouse [Type PS/2], etc.	Ext. Keyboard/Mouse Port	☞ page 39
Speaker/Headphone	Headphone Jack	☞ page 39
Microphone	Microphone Jack	☞ page 39

Using a CD-ROM Drive

You may use an optional CD-ROM pack (CF-VCD351) by removing your floppy disk drive from the multimedia pocket. Should you decide to install the CD-ROM pack, it will function as an internal CD-ROM drive. For more information, please read the manual that accompanies the CD-ROM pack.

Installing/Removing the Unit

1 Power off your computer (☞ page 10)

Do not shut down using the suspend or hibernation mode.

CAUTION

Do not install or remove peripherals while your computer is in the suspend or hibernation mode; abnormal operation may result.



2 Removing the unit

Turn your computer over, slide the MP release lever using thumb and remove the unit.

CAUTION

- Please handle the unit as shown (holding both sides). Otherwise, the unit may be damaged.
- Do not allow dust to enter the multimedia pocket. Use of the dummy FDD is highly recommended when the floppy disk drive is not installed. When inserting the dummy FDD, first make sure the guide and groove match and then push the guide part of the dummy FDD in.

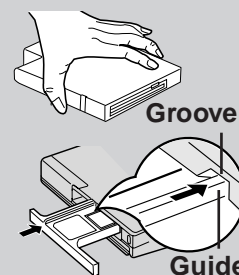

The lever will return to this position (right-side).

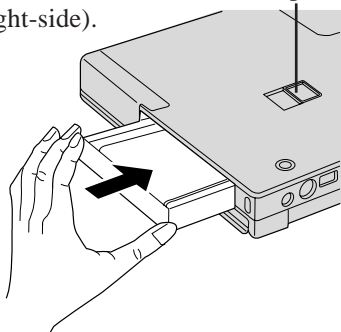

● Installing the unit

After the lever returns to its original position, continue pushing in the unit from both edges until it is firmly set.

3 Turn your computer on

CAUTION

You may use the floppy disk drive as an external unit that is connected through the parallel port, by using an optional FDD cable (CF-VCF351). Some precautions are necessary, as described below, since problems may arise.

- Do not move the drive while accessing data on the floppy disk.
- Firmly hold both sides of the drive when removing a disk. Excessive force on top should be avoided.

NOTE

Even after installing the CD-ROM Pack, [Removable Disk (A:)] is displayed in [My Computer], but access is not possible. Select [Cancel].

Using PC Cards

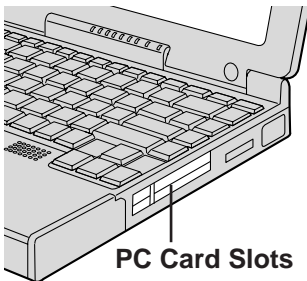

Your computer has two PC Card slots. These slots conform to the PC Card Standard; therefore, communications and SCSI devices may be utilized. The slot allows you to use two Type I or Type II cards (or one Type I and one Type II), or one Type III card.

● Type I or II

Two cards can be used simultaneously.

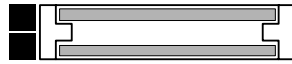

● Type III

One card can be used only in the bottom slot.



Bottom Slot

CAUTION

- Please check the PC Cards' specifications. Be sure the total operating current does not exceed the specified limit. Damage may result otherwise.
Allowable Current (total for two slots) : 3.3 V: 400 mA, 5 V: 400 mA, 12 V: 120 mA
- There are times when both a Type I card and a Type II card will not work at the same time.
- SRAM and FLASH ROM (except for ATA interface) cards are not supported.
- When using a CardBus type card, use only that card; do not insert any other PC Cards.
- **Only the bottom slot can support a Zoomed Video (ZV) card.**

Installing/Removing the PC Card

1 Power off your computer (☞ page 10)

Do not shut down using the suspend or hibernation mode.

CAUTION

- Do not install or remove peripherals while your computer is in the suspend or hibernation mode; abnormal operation may result.
- Before removing a PC Card, go to [Socket Status] (in [Start] - [Settings] - [Control Panel] - [PC Card (PCMCIA)]), select the PC Card slot and press [Stop].

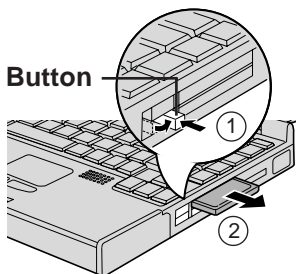

2 Removing the PC Card (or the dummy card)

Pull the button out and then press it.

NOTE

Dummy cards are provided at the time of purchase. They provide protection for the PC Card slots against such things as dust.

● Installing the PC Card

Simply slide the PC Card in until it snaps into place.

Please refer to the manual for each card on how to install the card (insertion is typically label-side up).

3 Turn your computer on

There are some PC Cards that require special or updated device driver be installed. Follow the instructions on the screen and read any related manuals on how to install these device drivers.

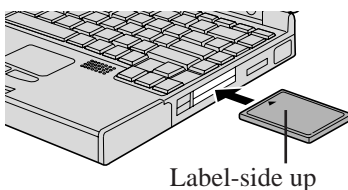

NOTE

- You may need to install a driver from the Windows 95 CD-ROM (included) or a PC Card's floppy disk. Simply follow the on-screen instructions and read the PC Card's operation manual on how to install the driver.

PhoenixCard Manager95:

- Follow the installation procedure below only if you will be using the ZV card. Otherwise, do not perform the installation; abnormal operation may result.

1 Set [Sound Chip] to [Automatic (PnP)] in the Setup Utility.

2 Select [Start] - [Run] and type [c:\util\phoenix\disk1\setup.exe] press , and then follow the on-screen instructions.

If PhoenixCard Manager95 has been reinstalled, follow the instructions in "Installing PhoenixCard Manager95" on page 34.

- After PhoenixCard Manager95 has been installed, make sure to power off the computer before installing or removing the card. Also, do not use the suspend or hibernation functions if the card is installed.

Add-ons/Peripherals

Adding Memory

CAUTION

RAM modules are extremely sensitive to static electricity. There are cases where static electricity generated by the human body has adversely affected such modules. In addition, it is easy to damage the RAM modules or internal components of the computer. Therefore, when installing or removing a RAM module, handle the module with extreme care.

RAM module specifications

144 pins, 60/70 ns, 3.3 V,
SO-DIMM, EDO

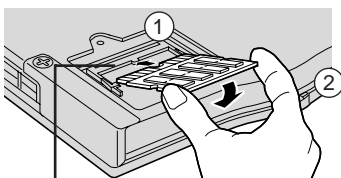
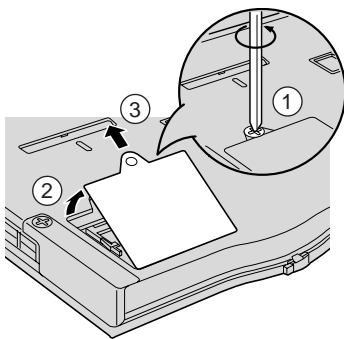

RAM Module Slot

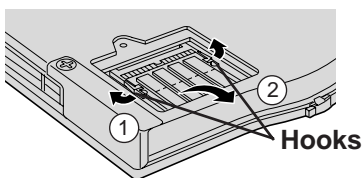

Hooks

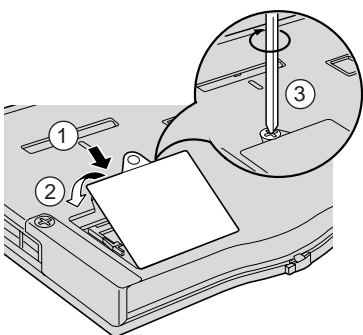

Installing/Removing the RAM Module

1 Power off your computer (page 10)

Do not shut down using the suspend or hibernation mode.

CAUTION

Do not install or remove peripherals while your computer is in the suspend or hibernation mode; abnormal operation may result.

2 Remove the memory cover after removing the screw holding it in place

Turn your computer over and use a screwdriver to remove the screw.

CAUTION

Do not touch the terminals or internal components, insert objects other than the module, or allow foreign particles to enter. Doing so has been known to cause damage, fire or electric shock.

3 Installing the RAM module

- 1 Slide the module in at an angle.
- 2 Snap the module into place by pushing it down.

Removing the RAM module

- 1 Open the left and right hooks.
- 2 Gently remove the RAM module from the slot.

4 Put the cover back into place, then fasten the screw

5 Turn your computer on

Connecting a Port Replicator

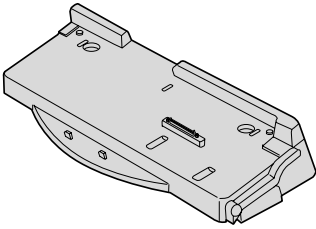

A port replicator is available as an option (CF-VEB351). This device eliminates the hassles of having you connect/disconnect the various cables when carrying your computer around and allows a variety of peripherals to be connected including a headphone or microphone, etc.

The port replicator connects to the expansion bus connector on the bottom of your computer. When your computer is not connected to the port replicator, be sure that the expansion bus connector on the bottom of the computer is covered.

For more detailed information, please refer to the operation manual for the port replicator.

Using an External Display

1 Power off your computer (page 10)

Do not shut down using the suspend or hibernation mode.

CAUTION

Do not install or remove peripherals while your computer is in the suspend or hibernation mode; abnormal operation may result.

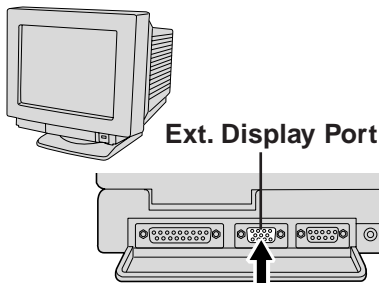

2 Connect the external display to your computer

NOTE

For more detailed information, please refer to the operation manual for the external display.

3 Turn on the display, then turn on your computer

● To display on both the LCD of your computer and the external display

1 Run the Setup Utility (page 36).

2 Using  and , select [System Setup] then press .

3 Using  and , select [Display], set [Simultaneous] with  then press .

4 Close the Setup Utility (page 36).

5 Select your external display

Set your external display for [Models] in [Start] - [Settings] - [Control Panel] - [Display] - [Settings] - [Advanced Properties] - [Monitor] - [Change] - [Show all devices], then press .

Using a Printer

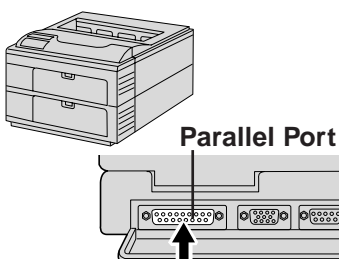

1 Power off your computer (page 10)

Do not shut down using the suspend or hibernation mode.

CAUTION

Do not install or remove peripherals while your computer is in the suspend or hibernation mode; abnormal operation may result.

2 Connect the printer to your computer

NOTE

Some printer cables may be difficult to connect, and may require removal of the rear cover. Take care not to lose the cover.

3 Turn on the printer, then turn on your computer

Add-ons/Peripherals

4 Setting your printer

Go to [My Computer] - [Printers]. Find your printer's icon, double-click on it, and click [File] - [Set As Default]. If no icon is available, select [Add Printer] and install the driver program.

NOTE

You may need to install a driver for your printer. Simply follow the on-screen instructions and refer to the operation manual for the printer on how to install the driver.

To change your hard disk, consult your nearest Panasonic Dealer or authorized Service Center

CAUTION

To Customers:

- To change your hard disk, consult your nearest Panasonic dealer or authorized Service Center.
- Be sure to back up all important data before the change.

To Technicians (at a Panasonic dealer or authorized Service Center):

Be careful when replacing the hard disk. The hard disk is extremely sensitive to shock. In addition, static electricity could later affect some internal components.

Installing/Removing the hard disk

(For technicians at Panasonic dealer or authorized Service Center)

1 Power off your computer (☞ page 10)

Do not shut down using the suspend or hibernation mode.

CAUTION

Do not install or remove peripherals while your computer is in the suspend or hibernation mode; abnormal operation may result.

2 Loosen the screw, then take off the cover

Turn your computer over. Then, loosen the screw with a screwdriver and with the display slightly open, remove the cover.

3 Removing the hard disk

Pull the tape attached to the hard disk to disconnect the connector on the hard disk from the connector on the computer. Next, remove the hard disk from the pocket.

Installing the hard disk

Make sure the hard disk connector is located on the top side. Push the disk in so that it connects firmly with the connector on the computer.

4 Put the cover back into place, then fasten the screw

With the display slightly open, reattach the cover.

CAUTION

Set the hard disk tape as shown so that it does not get in the way when replacing the cover.

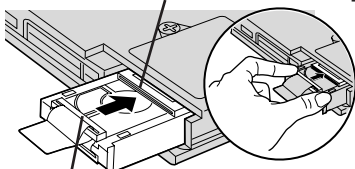
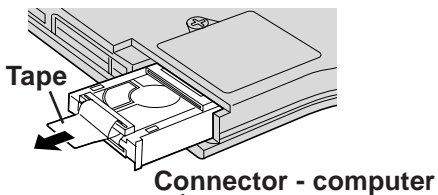
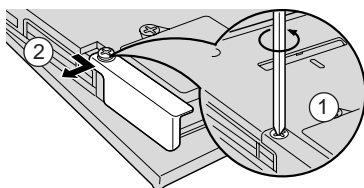
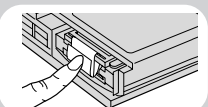

Connector - hard disk

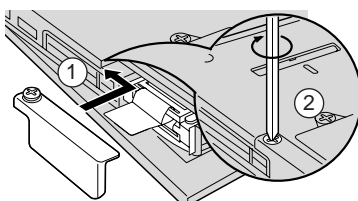

Usage, Carrying and Maintenance

Usage Environment

● Environment

- Place the computer on a flat stable surface.
- In use: Temperature: 5 °C to 35 °C
(41 °F to 95 °F)
Humidity: 30% to 80% RH
(No condensation)
- Not in use: Temperature: -20 °C to 60 °C
(-4 °F to 140 °F)
Humidity: 30% to 90% RH
(No condensation)

● Places not to use your computer

- Such areas may result in damage to the computer.



Areas exposed to direct sunlight



Areas with electronic equipment
These areas may interfere with your display or cause your computer to produce strange sounds.

Areas with extremely high/low temperatures

- Do not leave things near the computer that are sensitive to heat. During operation, the computer can become quite hot.

Carrying

- It is a good idea to make backup copies on floppy disks and carry them with you.
- Do not leave a floppy disk in the drive while transporting your computer.
- Do not carry your computer when it is ON.
- Remove all cables before transporting your computer. Having the optional Port Replicator (page 25) is very convenient.
- We recommend preparing a fully charged battery (and optional charger, if possible). When transporting spare batteries inside a package, briefcase, etc., it is recommended that the batteries be stored in a plastic bag.
- Do not carry the computer while the display is open, or carry it by gripping the display.
- Do not put anything (e.g., a piece of paper) between the display and keyboard.
- Do not drop or hit your computer against solid objects.
- If you have occasion to ship your computer, make absolutely sure that it is packed with adequate protection.

When flying

Always carry your computer with you. Never check it with luggage.

Maintenance

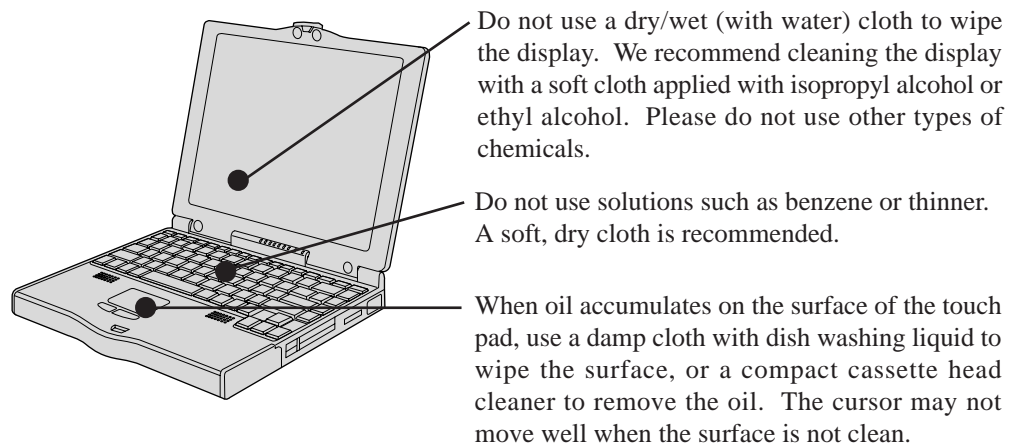

Computer Diagnosis

List of Error Codes

If a problem occurs with your hardware, [POST Start up Error(s)] is displayed along with the error code(s), follow the on-screen instructions.

Setup: Setup Utility (☞ page 36) is started. Run [Load Default Settings (PnP)].
Next the Setup Utility must be run again to input the appropriate operating environment settings.

Exit: Ignore the error message(s), and restart the computer.

Code	Description
062	Boot failure--default configuration used
101	System Board Failure
102	System Board Failure
106	System Board Failure
114	Adapter ROM Error
151	System Board Failure
161	Bad CMOS Battery
162	Configuration Change Has Occurred
162	Configuration Error
163	Date and Time Incorrect
173	Configuration Change Has Occurred
201	Memory Size Error
301	Keyboard Error
303	Keyboard Error
604	Diskette Drive Error
605	Diskette Drive Error
1780	Hard Disk Error
1800	PCI Error
1801	PCI Error
1802	PCI Error
1803	PCI Error
1804	PCI Error
1805	PCI Error
1962	IPL Error
8601	Pointing Device Error
19990301	IPL Error
19990305	IPL Error

Using the Self-diagnosis Program

Follow the procedure below to check whether each part of your computer is operating properly.

- 1** To run the program, insert the Firstaid FD you created into the floppy disk drive, then turn your computer on
- 2** When the display below is shown, select [1. Boot]
 1. Boot
 2. Restore HDD to factory default (For beginners)
 3. Restore HDD to factory default (For advanced users)
- 3** At the MS-DOS prompt (A:\WINDOWS\COMMAND>), input the following:







diag35 

Follow the messages on the screen.

Dealing with Problems

When a problem occurs, please refer to this page. If you think it has to do with the software application you are using, please read the related manual. If for some reason you still cannot figure out the problem, please consult your nearest Panasonic dealer.

● Starting Up

<p>The power indicator (🔌) or battery indicator (🔋) is not lit</p>	<ul style="list-style-type: none"> ● Check the cable connection for the AC adapter (📖 page 7). ● Check to see if a fully charged battery is properly installed (📖 page 16). ● Pressing the reset button will solve the problem (📖 page 39).
<p> is displayed</p>	<p>Please input your password. If you have forgotten it, consult your nearest Panasonic dealer.</p>
<p> is not displayed (Once this icon is executed, it will not be displayed later)</p>	<p>If before you double-click  it disappears, select [Start]-[Run], input [c:\util\avapp\psetup.bat], and press . Follow the message on the screen.</p>
<p> is not displayed</p>	<p>Select [Start]-[Run], input [c:\util\avapp>manual\seticon.bat], and press .</p>
<p>[Post Start Up Error(s)] is displayed</p>	<p>📖 page 28</p>
<p>The pre-memory count, Windows startup, or an operation is extremely slow</p>	<p>Run [Load Default Settings (PnP)] in the Setup Utility. This will restore the Setup Utility's settings to their default values (except the password settings), then the Setup Utility must be run once again for you to input the appropriate operating environment settings. (The processing speed depends on the application software used, so this operation may not cause the processing speed to increase.)</p>
<p>The date and time are incorrect</p>	<ul style="list-style-type: none"> ● You can set the date and time through [Date/Time] in [Start] - [Settings] - [Control Panel]. Another way is with the DATE and TIME commands in MS-DOS. ● If you continue to experience problems, the internal battery maintaining the clock may need to be replaced. Please consult your nearest Panasonic dealer.

● Battery Indicator

<p>The red battery indicator lights or the beeps sound while the computer is in use.</p>	<ul style="list-style-type: none"> ● The battery level is low. Connect the AC adapter or replace the battery pack with a fully charged one. If you have neither the adapter nor an extra battery, save your data and power off your computer. ● The temperature has risen due to a big load. Attach the AC adapter to take the load off the pack.
<p>The red indicator blinks</p>	<ul style="list-style-type: none"> ● The battery pack or recharging function may be defective. Quickly remove the battery pack and disconnect the AC adapter, then connect them again. ● If the problem persists, consult your nearest Panasonic dealer.
<p>The red indicator lights for an extended period of time</p>	<p>When the battery pack is fully charged, turn on your computer, unplug the AC adapter, and then completely discharge the battery.</p>
<p>After the AC adapter is connected, the orange indicator blinks five times</p>	<p>Unable to charge because of an improper temperature range (📖 page 15).</p>

Dealing with Problems

● Display

<p>No display after powering on;</p>	<ul style="list-style-type: none"> ● The brightness can be adjusted with + . Dark▶ Bright For models with an DSTN display, you can adjust the contrast with + / . ● When purchasing the computer, the display setting has been preset for an external display. If you connect the external display, the screen is displayed on the external display. ● When there is no display to an external display, <ul style="list-style-type: none"> • Check your cable connection for an external display. • Confirm your display is on. ● If your computer is connected to an external display and the internal LCD has been set to "off", and the computer is placed in the hibernation or suspend mode, the internal LCD will remain in the "off" mode if the external display is not connected when the computer is restarted. In this case, re-connect the external display and reboot the computer.
<p>The power has not been cut, but after a certain period of time, there is no display</p>	<ul style="list-style-type: none"> ● Has the computer been set to the power-saving mode? To resume operation of your computer, press any key. ● To save power, your computer may have automatically entered the hibernation mode.
<p>An afterimage appears</p>	<p>If an image is displayed for a prolonged period of time, an afterimage may appear. This is not a malfunction. The afterimage will disappear when a different screen is displayed.</p>
<p>The motion of a mouse cursor is not smooth</p>	<p>[Start]-[Settings]-[Control Panel]-[Mouse]-[Motion] and check [Show pointer trails].</p>



● Disk Operations

<p>Cannot read/write to a floppy disk</p>	<ul style="list-style-type: none"> ● Has the floppy disk been correctly inserted? ● Has the floppy disk been correctly formatted? ● Your floppy disk drive may not have been properly set in the multimedia pocket. ● Has the Setup Utility been used to set [Floppy Operation] to [Enable]?
<p>Unable to write to a floppy disk</p>	<p>Is the floppy disk write-protected?</p>
<p>How to format a floppy disk is unclear</p>	<p>Select [Format] in [My Computer] - [3 1/2 Floppy (A:)] - [File]. After confirming the disk volume and format type, click </p>
<p>Unable to read/write to the hard disk</p>	<ul style="list-style-type: none"> ● Your drive or file may not have been properly set. ● Check to see if the hard disk is full. ● Your hard disk content may be corrupted. Consult your nearest Panasonic dealer.

● Character Input

<p>Unable to input anything but numerals</p>	<p>If and are on, the Numeric Key Pad is ON. To switch it OFF, press + .</p>
<p>Only capital letters are being input</p>	<p>If is on, the Caps Lock is ON. To switch it OFF, press .</p>
<p>How to input European characters (ß, à, ç) or symbols is unclear</p>	<p>Select [Start] - [Run], input [c:\windows\charmap.exe] and press . The Character Map will be displayed. Point to the desired font name and select it.</p>

● Setup Utility

 is displayed	Enter the User Password or Supervisor Password. If you have forgotten it, consult your nearest Panasonic dealer.
[Supervisor Setup] is not displayed in the menu	At the start of the program when  is displayed, you have to enter the Supervisor Password. When both the User Password and Supervisor Password have been set, if you enter the User Password, [Supervisor Setup] will not be displayed (☞ page 36). If [Supervisor Setup] is not displayed even after entering the Supervisor Password, you have to disable the User Password. Run the Setup Utility program again, and input the Supervisor Password.
[User Password] cannot be selected	[User Password Protection] in [Supervisor Setup] may be enabled.
[Coffee break Password] or [Key Combination for Coffee break] cannot be selected	You need to set the User Password.
[Supervisor Password] cannot be set	If the User Password has been set first, the Supervisor Password can not be the same as the User Password. Another password needs to be entered.

● Connecting Peripherals

Your peripheral does not work (An error occurs while installing the driver)	You need to use drivers conforming to Windows 95 Version 4.00.950B (OSR-2). Some earlier drivers will no longer work. For more information, please ask the manufacturer of the driver in question.
Unable to print	<ul style="list-style-type: none"> ● Check the computer-printer connection. ● Make sure the printer is on. ● Make sure the printer is in the online state. ● Make sure paper is in the printer tray and there is no paper jam. ● Has the Setup Utility been used to set [Parallel Port (Address)] to [Automatic (PnP)], [378] or [3BC]?
The cursor does not move from mouse operations	<ul style="list-style-type: none"> ● The Coffee break Password may be set. ● Check your mouse connections, then reboot the computer from the keyboard. From the keyboard, you may choose to press down on  then select [Shut Down].
The device connected to the serial port does not work	<ul style="list-style-type: none"> ● Check the connection. ● Confirm that the device driver for the serial port works. Please refer to the reference manual for the device. ● Confirm that two mouse devices are not connected, one through the ext. keyboard/mouse port and the other through the serial port. ● Try setting the [Touch Pad] to Disable in the Setup Utility. ● Has the Setup Utility been used to set [Serial Port] to [Automatic (PnP)] or [3F8]?
A PC Card does not work	<ul style="list-style-type: none"> ● Make sure the card is properly inserted. ● Confirm that the card conforms to the PC Card Standard. ● A driver for Windows 95 may need to be installed. ● Note that after a driver is installed, the computer must be rebooted. ● Check that the proper port settings have been made. ● Read the PC Card's manual. Or, you may need to call the source of the PC Card.
You do not know the available RAM module	☞ page 24
The RAM module has not been recognized	Make sure the RAM module has been properly inserted.
The address map for IRQ, I/O port address, etc. is unclear	Check the address map by going to [View Resources] in [Start] - [Settings] - [Control Panel] - [System] - [Device Manager] - [Computer] - [Properties].

Reinstalling Software

Before Reinstallation

● Preparation

- You will need the CD-ROM included in the Windows 95 System Pack and the following 8 backup disks you made earlier.

- **Firstaid FD (1 disk)**
- **Panasonic Tools Disk(1 disk)**
- **Drivers Disk 1/2 (2 disks)**
- **TranXit Disk (2 disks)**
- **PhoenixCard Manager Disk (2 disks)**

If you have not created these disks, a message will appear at startup urging you to make backup copies. If there is no message, backup copies have already been created.

If for some reason, you do not have these disks or one of them is corrupted, please consult your nearest Panasonic dealer.

- The CD-ROM pack (CF-VCD351) and FDD cable (CF-VCF351) are required for the following reinstallation procedure. Mount the CD-ROM pack in the multimedia pocket and connect the FDD cable to the floppy disk drive. (Refer to the operating instructions of the CD-ROM pack and FDD cable for details.)

● Important

- Save all important data. If reinstallation is carried out, all data existing prior to the installation will be lost. The reinstallation will return the computer to factory condition.
- Be sure to remove all PC Cards and disconnect all peripherals (except for the CD-ROM pack and FDD cable) before the reinstallation procedure.
- Be sure the AC adapter is connected until completing reinstallation.

Reinstalling

● Windows 95 (HDD format)

Two options are available, one for beginners and the other for advanced users.

- **For beginners:** **Returning to factory default condition.**
- **For advanced users:** **Returning the primary MS-DOS partition only to a condition similar to the factory default in cases where the hard disk has been divided into multiple partitions.**

CAUTION

If the hard disk has been compressed, first remove the disk compression.

- 1 Insert the Firstaid FD, and turn the computer on, then run the Setup Utility. (☞ page 36)
- 2 Select [Load Default Settings (PnP)], then press . At the confirmation message, press .
- 3 Close the Setup Utility (☞ page 36); this screen should appear.

```
Microsoft Windows 95 Startup Menu
-----
1. Boot
2. Restore HDD to factory default (For beginners)
3. Restore HDD to factory default (For advanced users)
Enter a choice: 1
```

- 4 **For beginners:** select [2. Restore HDD to factory default (For beginners)].
For advanced users: select [3. Restore HDD to factory default (For advanced users)].

At the confirmation message, press . Simply follow the on-screen instructions.

- Then, when the [Microsoft Windows 95 Startup Menu] appears, for beginners, select [2. Restore HDD to factory default (For beginners)]. For advanced users, select [3. Restore HDD to factory default (For advanced users)].
- If the computer asks you to insert the Win95 Setup CD-ROM, please set the Windows 95 CD-ROM that comes with this computer. After inserting the Windows 95 CD-ROM, Windows setup will start automatically. (The whole process will take approximately one hour).

NOTE







- With the exception of the instruction below, please select all default values displayed by the Setup Wizard. Be sure to add the check mark to [Sound, MIDI, or Video Capture Card] at the [Analyzing Your Computer].
- Have a blank disk on hand to create a "Windows 95 Startup Disk". Immediately after creating this disk, enter the Firstaid FD into the floppy disk drive and press . (Note: A system error will result if the Firstaid FD is not inserted. If this occurs, insert the Firstaid FD and press [Retry].)

- 5 At the [Finishing Setup], remove the floppy disk and press . Windows will restart after all the settings have automatically been made.
- 6 At the [Date/Time Properties], press .
- 7 At the [Add Printer Wizard], press .
- 8 When the display appears indicating the establishment of the system settings, press . The computer will reboot. (When the welcome screen appears, press .)







● System setup

- 9 In [Start] - [Run], input [c:\install.bat] then press . Rebooting will be done automatically.
- 10 In [Start] - [Programs] - [Windows Explorer], delete two files named [install] on the C: drive.



● Device Manager 1

- 11 In [Start] - [Settings] - [Control Panel] - [System] - [Device Manager] - [View devices by connection], select [PCI bus] in [Plug and Play BIOS], press , then press .
- When the message appears to reboot your computer, press . Rebooting will be done automatically.
 - If the computer asks you to insert the Windows 95 CD-ROM, please set the CD-ROM and press .
 - At the [New Hardware Found], [L:\WIN95] is displayed. Rewrite this to [D:\WIN95].
 - Then, when the [Version Conflict] appears, select .
- 12 Press  at the [Update Device Driver Wizard of Intel 82371AB PCI Bus Master IDE Controller] and .
- If [Update Device Driver Wizard of Intel 82371AB PCI Bus Master IE Controller] is not displayed, please go to step 13 after step 11.



● Video driver

- 13 Press  at the [Update Device Driver Wizard of Standard PCI Graphics Adapter (VGA)].
- 14 Select , input [c:\util\drivers\video], and press . Then, press .
- 15 At the [Insert Disk], select .
- 16 At the [Copying Files], type [c:\util\drivers\video] and press . The display will ask you to restart Windows, press  (at times, the message may appear a few times).











● Power Management

- 17 Delete the check mark for [When powered by AC power] and [When powered by batteries] in [Start] - [Settings] - [Control Panel] - [Power] - [Disk Drives], then press .
- 18 Set [Mobile or docking system] in [Control Panel] - [System] - [Performance] - [File System] - [Typical role of this machine], and then press .





● Device Manager 2

- 19 Add the check mark for [Get IRQ table from PCIBIOS 2.1 call] in [Device Manager] - [System devices] - [PCI bus] - [IRQ Steering], then press .
- 20 At the [System Properties], press . The display will ask you to restart Windows. Remove the floppy disk and press .



● Sound Driver

- 21 In [Control Panel] - [System] - [Device Manager], for each item in [Sound, Video and Game Controller], press  to delete it, then press  to confirm the deletion.
- Select [PCMCIA socket] and if the [PCIC or compatible PCMCIA controller] is displayed, perform a similar delete operation.
- 22 At the [System Properties], press .
- 23 In [Start] - [Shut Down], select [Restart the computer?] then press .
- 24 At the [Update Device Driver Wizard of Unknown Devices], press .
- 25 Select , type [c:\util\drivers\sound], then press .
- 26 At the [Update Device Driver Wizard of YAMAHA OPL3-SAx Sound System], press  then press  at the [Insert Disk].
- 27 At the [Copying Files], type [c:\util\drivers\sound] for the source then press .
- 28 In [Control Panel] - [Power] - [OPL3-SAx power management], set [Non Power Save mode] then press [Apply]. Then press .

● Display

- 29 Set [High Color (16 bit)] for [Color palette] in [Control Panel] - [Display] - [Settings]. Next, set [Super VGA 1024 X 768] for [Models] in [Advanced Properties] - [Monitor] - [Change], then press .
- 30 After pressing , at the [Display Properties] press .
- 31 In [Start] - [Run], type [c:\util\updates\rmm2upd.exe] then press . Simply follow the on-screen instructions.

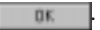
● CD-ROM drive

- 32 In [Control Panel] - [System] - [Device Manager] - [CDROM] - [MATSHITA UJDCD8710] - [Settings], delete the check mark for [Auto insert notification], then set [L:] for [Reserved drive letters] then press .
- 33 At the [System Properties], press . When the message appears to reboot your computer, press . Rebooting will be done automatically.

CAUTION

In [Control Panel]-[Add New Hardware], if [Infrared] is added, TranXit can not be used. For TranXit to be operable, [Infrared] must not be set.



Reinstalling Software

NOTE

Some Windows applications differ in use from their factory-set state. To add or delete items from the menu, select [Add/Remove Programs] in [Start] - [Settings] - [Control Panel].

Installing TranXit

If necessary, install TranXit with the following steps.

- 1 Insert TranXit Disk 1 into the drive and select [Start] - [Settings] - [Control Panel] - [Add/Remove Programs].
- 2 Select [Install/Uninstall] - [Install] and press .
- 3 Type "a:\install", press , then follow the on-screen instructions.

NOTE

To return to factory condition:



Set [Infrared] for [Connection Type] in [Connection Setup] and press [Setup Connection]. Next, set [COM2] for [Port] and [Panasonic Notebook Computer] for [Models] in [Infrared device]. Select default values for all other settings.

Installing PhoenixCard Manager95

If necessary, install PhoenixCard Manager95 with the following steps.

CAUTION

Follow the installation procedure below only if you will be using the ZV card. Otherwise, do not perform the installation; abnormal operation may result.



- 1 Insert PhoenixCard Manager95 Disk 1 into the drive and select [Start] - [Settings] - [Control Panel] - [Add/Remove Programs].
- 2 Select [Install/Uninstall] - [Install] and press .
- 3 Type [a:\setup], press , then follow the on-screen instructions.

Installing Internet Explorer







Reinstalling Windows 95 causes an older version of Internet Explorer to be installed.

To return the computer to the state it was in when you purchased it, follow the steps below to install the newer version Internet Explorer.

CF-35PJJ8C*M/CF-35PJJ8C*E

- 1 Insert the Internet Explorer CD-ROM included in the Windows 95 System Pack into the drive and select [Start] - [Settings] - [Control Panel] - [Add/Remove Programs].
- 2 Select [Install/Uninstall] - [Install] and press .
- 3 Type [L:\setup.exe], press , then follow the on-screen instructions.

For all other models

- 1 Insert the Windows 95 CD-ROM included in the Windows 95 System Pack into the drive and select [Start] - [Settings] - [Control Panel] - [Add/Remove Programs].
- 2 Select [Install/Uninstall] - [Install] and press .
- 3 Type [L:\other\ie302\msie302.exe], press , then follow the on-screen instructions.
When the message appears to reboot your computer, press . Rebooting will be done automatically.
- 4 Select [Add/Remove Programs] - [Install/Uninstall] - [Install] and press . Type [c:\util\ie302\auth2all.exe], press , then follow the on-screen instructions.
When the message appears to reboot your computer, press . Rebooting will be done automatically.

NOTE

At the time of purchase, the [CF-35 series Quick Guide] can be found under [Favorites] in the Internet Explorer program. If reinstallation is carried out for your computer, this file will no longer be available. You may reinstall this file with following steps if necessary.

- 1 Select [Internet Explorer].
- 2 At the [Address], type [file://c:\util\avapp\manual\manual.htm].
- 3 Once the page is displayed, select [Favorites] - [Add to favorites] and input the name. Then press .

Windows 95 Setup Procedure

This procedure explains step 4 on page 8 in more detail.

1 Select settings for your region, then press

2 Select your keyboard layout, then press
(for U.S.A.: United States 101, for U.K.: British)

3 Enter your name and your company's name, then press

The License Agreement will be displayed.

4 After reading the agreement, select [I accept the agreement] or [I don't accept the agreement] then press

If the former is selected, the [Certificate of Authenticity] will appear. If the latter is selected, the Windows setup will be aborted.

5 Input the Product Number written on the "Certificate of Authenticity" located in the "Introducing Microsoft Windows 95 book" that comes with this computer. After doing so, press

6 Press

7 If the instruction to restart appears, press

8 Insert the correct time, date and time zone and click
You can also complete these settings at a later time.

9 If you want to complete the printer settings, press



Simply follow the on-screen instructions.

If not, press





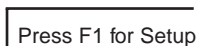

You can also complete these settings at a later time.

Setup Utility

Running the Setup Utility

To run the Setup Utility, you need to restart your computer. → Upon seeing this message  → press 

NOTE

- The Setup Utility will not be run if  is not pressed soon after the computer restarts. In this case, you need to restart your computer again.
- If  is displayed, enter your password.
If both the [User Password] and [Supervisor Password] have been set, after entering the User Password, [Supervisor Setup] will not be displayed on the main screen.
To display the [Supervisor Setup]:
 - 1 Use  + Power Switch to turn your computer off.
 - 2 Restart the computer and press  when [Press F1 for Setup] is displayed.
 - 3 When  is displayed, enter the Supervisor Password.
- For more details, on-line help is available; press .

<Main Screen>

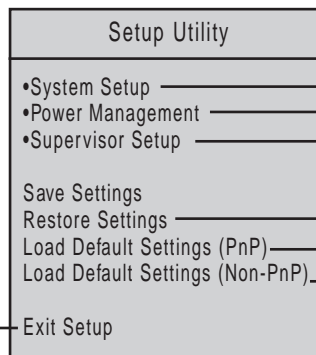





Return to the state existing at the time of Setup Utility startup, or to the settings saved with [Save Settings].

Set default settings.







- (PnP) denotes “for Windows 95”.
- (Non-PnP) denotes “for other than Windows 95”.
- When the Supervisor Password has been set, input of the password is necessary.

Program Completion

- Hibernation settings ( page 11)
 - Power Management settings ( page 13)
 - Security Settings ( page 17)
 - Add-ons/Peripherals Settings ( page 22)
- After you have completed all settings, you may exit the Setup Utility program.

NOTE

Key Operations

- | | |
|--|---|
|  : To display the corresponding “help” file. |  : To move among the items. |
|  : To make a selection. |  : To move among the values of each item. |
|  : To display previous screen (To exit the program at the main screen). |  : To return to the setting before a change. |
| |  : To set the default values. |

Closing the Program

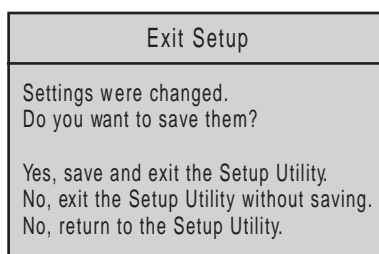

NOTE

If the User Password has been set, the password must be entered before Windows can start.

(The display may be different if no changes to the settings are made.)

System Setup	
NumLk	[ON]
Touch Pad	[Enable]
Speakers	[Enable]
Display	[External Monitor]*1
• User Password	
Coffee break Password*2	[Enable]
Key Combination for Coffee break*3	[Alt+Ctrl+F9]

Setting the User Password (☞ page 17)
 (Unable to select when the User Password Protection has been set.)

User Password	
User Password Status	Disable
Enter your new User Password twice.	
Enter User Password	[]
Enter User Password Again	[]
Set User Password	
Delete User Password	

Power Management	
Power Saving	[Standard (Battery)]
CPU Speed Change Mode	Enable
HDD Motor Timeout	1 min
Standby Timeout	2 min
Power Switch	[Hibernation]
Hibernation Timeout*4	[4 min]

☞ page 13

Sets the function of the power switch.

Able to set how long the interval will be until hibernation.

Supervisor Setup	
Parallel Port (Address)	[Automatic (PnP)]
Parallel Port Mode	[Bidirectional]
Serial Port	[Automatic (PnP)]
Sound Chip	[Enable]
Sound Blaster Compatible I/O	[Automatic (PnP)]
WSS CODEC I/O	[Automatic (PnP)]
Sound IRQ-A	[Automatic (PnP)]
Sound IRQ-B	[Automatic (PnP)]
Sound DMA	[Automatic (PnP)]
IrDA	[Automatic (PnP)]
Floppy Operation	[Enable]
Boot Up Drive	[FDD → HDD]
• Supervisor Password	
User Password Protection	[Disable]

CF-35PJJ8C*M/CF-35PJJ8C*E

Sound DMA-A
 Sound DMA-B

[Automatic (PnP)]
 [Automatic (PnP)]

Setting Supervisor Password (☞ page 20)

Supervisor Password	
Supervisor Password Status	Disable
Enter your new Supervisor Password twice.	
Enter Supervisor Password	[]
Enter Supervisor Password Again	[]
Set Supervisor Password	
Delete Supervisor Password	

*1 When no external display is connected, display will be through the LCD.

*2 Can only be selected when the [User Password] has been set.

*3 Can only be selected when the [Coffee break Password] has been set.

*4 Can only be selected when the [Power Switch] has been set [Hibernation].

Specifications

Main Specifications

Model No.	CF-35PJJ8CAM/CF-35PJJ8CAE	CF-35KJF4BAM/CF-35KJF4BAE
CPU	Pentium® Processor with MMX™ technology 200 MHz	Pentium® Processor with MMX™ technology 150 MHz
Cache Memory (second cache memory)	32 KB (256 KB)	32 KB (256 KB)
EDO Memory (Expandable to)	32 MB (96 MB Max.)	16 MB (80 MB Max.)
Video Memory	1.1 MB	1.1 MB
LCD	Type	12.1" (TFT)
	Displayed Colors	640 X 480 dots 256/65536/262144 colors
	800 X 600 dots	256/65536 colors
Hard Disk Drive (including about 110 MB used specifically by the system)	3GB*	2GB*

* 1GB = 10⁹ bytes









Other Specifications

Keyboard	Windows 95 keyboard (for U.S.A.: 87 keys, for U.K.: 88 keys)			
Floppy Disk Drive	720 KB/1.44 MB (two-mode)			
Slots	PC Card Slots	Two Type I or Type II, or one Type III		
		Allowable current (total for two slots)	3.3 V: 400 mA, 5 V: 400 mA, 12 V: 120 mA	
	RAM Module Slot	144-pin, 3.3-V, SO-DIMM		
	Multimedia Pocket	One slot (floppy disk drive included)		
Interface	Parallel Port	Dsub 25-pin female		
	Ext. Display Port	Mini Dsub 15-pin female		
	Serial Port	Dsub 9-pin male		
	Microphone Jack	Miniature jack, 3.5 DIA Input impedance 600 Ω, Input voltage range 0.01 Vp-p		
	Headphone Jack	Miniature jack, 3.5 DIA Impedance 32 Ω, Output Power 3mW (Impedance 32 Ω) X 2		
	Infrared Communication Port	Data transmission speed: CF-35PJJ8C*M/CF-35PJJ8C*E: 4 Mbps For all other models: 115.2 kbps		
	Ext. Keyboard/Mouse Port	Mini DIN 6-pin female		
	Expansion Bus Connector	Dedicated 100-pin female		
Speakers	Stereo Speakers (built in)			
Sound	16 bits, 44.1 kHz PCM/FM sound (Sound Blaster PRO Compatible)			
Software	Operating System	Microsoft® Windows® 95 (FAT32 File System)		
	Utility Programs	Diagnostics program, TranXit program, PhoenixCard Manager program		
Battery	Battery Pack	Lithium Ion 10.8 V, 3300 mAh		
	Operating Time	Approx. 2.5 - 5.0 hours*		
	Charging Time	Power On	Approx. 4.5 hours*	
		Power Off	Approx. 2.5 hours*	
	Clock Battery	Coin type lithium battery 3.0 V		
	Operating Time	Approx. 10 years		
AC Adapter	Input	100 -240 V AC, 50 / 60 Hz	Output 15.1 V DC, 2.6 A	
Power Consumption	Approx. 35 W** (maximum when recharging in the OFF state)			
Physical Dimensions (W X H X D)	297 mm X 37.5 mm X 230 mm (11.7" X 1.5" X 9.1")			
Weight	Approx. 2.2 kg (Approx. 4.9 lbs) (With the floppy disk drive installed)			

* Varies depending on the usage conditions.

** Approx. 1.1 W when the battery pack is fully charged (or not being charged) and the computer is OFF.

LED Indicators (located below the display; explanation is from the left side)

   	Green	Lit when the corresponding modes have been set.
  	Green	Lit during access of the corresponding devices.
	Battery Status	
	Green	Power On

Names and Functions of Parts

CF-35EJC4BAM/CF-35EJC4BAE	CF-35EVC4BAM
Pentium® Processor 133 MHz	Pentium® Processor 133 MHz
16 KB (256 KB)	16 KB
16 MB (80 MB Max.)	16 MB (80 MB Max.)
1.1 MB	1.1 MB
12.1" (TFT)	12.1" (DSTN)
256/65536/262144 colors	256/65536/262144 colors
256/65536 colors	256/65536 colors
1.44GB*	1.44GB*

Display		
Brightness Adjustment	Dark.....▶ Bright	
Contrast Adjustment (for DSTN display models only)	Darker contrast	
	Lighter contrast	

LED Indicators

☞ page 38

Speakers

- To adjust the volume*, select the on the task bar then [Volume Control].
* You may also use the function keys to perform this operation (or).
 - Speakers on/off :
- (The beep sound comes out from the left speaker (and headphone). The sound level cannot be changed.)

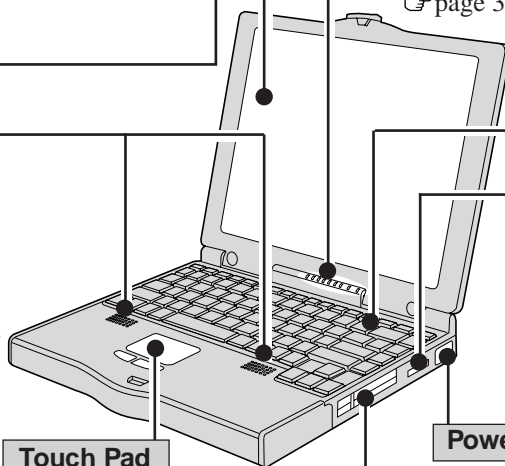

Keyboard

Ventilation Hole

These holes allow heat to exit.

CAUTION

Do not block or place the computer in a location that may prevent proper ventilation.

Touch Pad

☞ page 10

Power Switch

PC Card Slots

CardBus Compatible
(Confirmation with the dealer required beforehand.)
☞ page 23

Security Lock

A Kensington cable can be connected to prevent theft of your computer.

Multimedia Pocket

☞ page 22

Battery Pack

☞ page 15

Infrared Communication Port

☞ page 21

Serial Port

Parallel Port

☞ page 25

Ext. Display Port

☞ page 25

Microphone Jack

Headphone Jack

Use this connector to connect headphones or amplifier-equipped speakers. Audio output from the internal speaker is disabled when headphones or outside speakers are connected.

USB Port: No software is provided.

Ext. Keyboard/Mouse Port

In some circumstances, if a PS/2 external mouse with a serial interface conversion function is connected to the port, it may not operate normally.

DC-IN Jack

Reset Button

When resetting your computer, use a dull pointed object like a ball point pen. Do not use a pencil. Pencil lead can break off inside the computer and damage the computer's circuit.

Expansion Bus Connector

☞ page 25

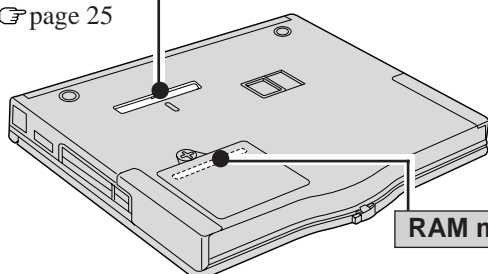

RAM module slot

☞ page 24

CAUTION

If a problem occurs but your computer does not lock, we recommend not resetting the machine. Pressing the reset button will cause you to lose data if an application is open.

LIMITED USE LICENSE AGREEMENT

THE SOFTWARE PROGRAM(S) ("PROGRAMS") FURNISHED WITH THIS PANASONIC® PRODUCT ("PRODUCT") ARE LICENSED ONLY TO THE END-USER ("YOU"), AND MAY BE USED BY YOU ONLY IN ACCORDANCE WITH THE LICENSE TERMS DESCRIBED BELOW. YOUR USE OF THE PROGRAMS SHALL BE CONCLUSIVELY DEEMED TO CONSTITUTE YOUR ACCEPTANCE OF THE TERMS OF THIS LICENSE.

Matsushita Electric Industrial Co., Ltd. ("MEI") has developed or otherwise obtained the Programs and hereby licenses their use to you. You assume sole responsibility for the selection of the Product (including the associated Programs) to achieve your intended results, and for the installation, use and results obtained therefrom.

LICENSE

- A. MEI hereby grants you a personal, non-transferable and non-exclusive right and license to use the Programs in accordance with the terms and conditions stated in this Agreement. You acknowledge that you are receiving only a LIMITED LICENSE TO USE the Programs and related documentation and that you shall obtain no title, ownership nor any other rights in or to the Programs and related documentation nor in or to the algorithms, concepts, designs and ideas represented by or incorporated in the Programs and related documentation, all of which title, ownership and rights shall remain with MEI.
- B. You may use the Programs only on the single Product which was accompanied by the Programs.
- C. You and your employees and agents are required to protect the confidentiality of the Programs. You may not distribute or otherwise make the Programs or related documentation available to any third party, by time-sharing or otherwise, without the prior written consent of MEI.
- D. You may not copy or reproduce, or permit to be copied or reproduced, the Programs or related documentation for any purpose, except that you may make one (1) copy of the Programs for backup purposes only in support of your use of the Programs on the single Product which was accompanied by the Programs. You shall not modify, or attempt to modify, the Programs.
- E. You may transfer the Programs and license them to another party only in connection with your transfer of the single Product which was accompanied by the Programs to such other party. At the time of such a transfer, you must also transfer all copies, whether in printed or machine readable form, of every Program, and the related documentation, to the same party or destroy any such copies not so transferred.
- F. You may not remove any copyright, trademark or other notice or product identification from the Programs and you must reproduce and include any such notice or product identification on any copy of any Program.

YOU MAY NOT REVERSE ASSEMBLE, REVERSE COMPILE, OR MECHANICALLY OR ELECTRONICALLY TRACE THE PROGRAMS, OR ANY COPY THEREOF, IN WHOLE OR IN PART.

YOU MAY NOT USE, COPY, MODIFY, ALTER, OR TRANSFER THE PROGRAMS OR ANY COPY THEREOF, IN WHOLE OR IN PART, EXCEPT AS EXPRESSLY PROVIDED IN THE LICENSE.

IF YOU TRANSFER POSSESSION OF ANY COPY OF ANY PROGRAM TO ANOTHER PARTY, EXCEPT AS PERMITTED IN PARAGRAPH E ABOVE, YOUR LICENSE IS AUTOMATICALLY TERMINATED.

TERM

This license is effective only for so long as you own or lease the Product, unless earlier terminated. You may terminate this license at any time by destroying, at your expense, the Programs and related documentation together with all copies thereof in any form. This license will also terminate effective immediately upon occurrence of the conditions therefor set forth elsewhere in this Agreement, or if you fail to comply with any term or condition contained herein. Upon any such termination, you agree to destroy, at your expense, the Programs and related documentation together with all copies thereof in any form.

YOU ACKNOWLEDGE THAT YOU HAVE READ THIS AGREEMENT, UNDERSTAND IT AND AGREE TO BE BOUND BY ITS TERMS AND CONDITIONS. YOU FURTHER AGREE THAT IT IS THE COMPLETE AND EXCLUSIVE STATEMENT OF THE AGREEMENT BETWEEN US, WHICH SUPERSEDES ANY PROPOSAL OR PRIOR AGREEMENT, ORAL OR WRITTEN, AND ANY OTHER COMMUNICATIONS BETWEEN US, RELATING TO THE SUBJECT MATTER OF THIS AGREEMENT.

Beschränkte Benutzerlizenz-Vereinbarung

Das (die) mit diesem Panasonic®-Produkt (im weiteren als "Produkt" bezeichnet) gelieferte(n) Programm(e) (im weiteren als "Programme" bezeichnet) wird (werden) nur für den Gebrauch durch den Endnutzer (im weiteren als "der Käufer" bezeichnet) lizenziert und darf (dürfen) ausschließlich gemäß den unten aufgeführten Lizenzbedingungen benutzt werden. Der Gebrauch der Programme durch den Käufer gilt als konkludente Zustimmung des Käufers zu den Bestimmungen dieser Lizenz.

Die Programme wurden von Matsushita Electric Industrial Co., Ltd. (im weiteren als "MEI" bezeichnet) entwickelt oder sie wurden auf andere Weise von MEI erworben, und MEI lizenziert die Programme hiermit für den Gebrauch des Käufers. Der Käufer übernimmt die alleinige Verantwortung dafür, daß die Wahl des Produkts (einschließlich der zugehörigen Programme) die beabsichtigten Zwecke erfüllt, sowie für die Installation, den Gebrauch und die damit erzielten Ergebnisse.

Lizenz

- A. Hiermit erteilt MEI dem Käufer das persönliche, nicht übertragbare und nicht ausschließliche Recht und die Lizenz zur Nutzung der Programme gemäß den Bestimmungen und Bedingungen dieser Vereinbarung. Der Käufer bestätigt, daß er lediglich eine BESCHRÄNKTE LIZENZ ZUM GEBRAUCH der Programme und der dazugehörigen Dokumentation erhält und daß mit dieser Lizenz kein Rechtsanspruch, kein Besitzanspruch und keine anderen Rechte verbunden sind, weder auf die Programme und die dazugehörige Dokumentation, noch auf die Algorithmen, Konzepte, Ausführungen und Ideen, die von den Programmen und der dazugehörigen Dokumentation dargestellt werden oder in diese aufgenommen sind, und daß alle Rechte bei MEI verbleiben.
- B. Der Käufer darf die Programme nur mit genau dem Produkt verwenden, zu dessen Lieferumfang die Programme gehören.
- C. Der Käufer und seine Angestellten und Bevollmächtigten sind zum Schutz der Vertraulichkeit der Programme verpflichtet. Der Käufer darf die Programme und die dazugehörige Dokumentation ohne vorherige schriftliche Genehmigung von MEI nicht an Dritte weitergeben oder sie auf andere Weise, einschließlich von Time-Sharing, Dritten zugänglich machen.
- D. Der Käufer darf die Programme und die dazugehörige Dokumentation zu keinerlei Zwecken kopieren oder reproduzieren und darf auch nicht zulassen, daß sie von anderen kopiert oder reproduziert werden, außer daß der Käufer eine (1) Kopie der Programme ausschließlich für Sicherungszwecke und nur zur Unterstützung der Verwendung der Programme mit genau dem Produkt erstellen darf, zu dessen Lieferumfang die Programme gehören. Der Käufer darf die Programme weder modifizieren noch solche Modifikationen versuchen.
- E. Der Käufer darf die Programme und eine diesbezügliche Benutzerlizenz nur zusammen mit der Übergabe genau des Produktes, zu dessen Lieferumfang die Programme gehören, an einen Dritten übergeben. Zur Zeitpunkt einer solchen Übergabe ist der Käufer verpflichtet, sämtliche von ihm erstellten Kopien, sowohl in gedruckter, als auch in Maschinensprache abgefaßter Form, jedes einzelnen Programms und der dazugehörigen Dokumentation an die gleiche Person zu übergeben und alle nicht übergebenen Kopien zu zerstören.
- F. Der Käufer darf kein Copyright, Warenzeichen oder keine andere Bekanntmachung oder Produktkennzeichnung von den Programmen entfernen und muß jede solche Bekanntmachung oder Produktkennzeichnung auf jeder Kopie eines der Programme reproduzieren.

Der Käufer darf die Programme und davon erstellten Kopien, weder insgesamt noch teilweise, nicht im Reversierverfahren assemblieren, kompilieren oder auf mechanischem bzw. elektronischen Wege abtasten. Der Käufer darf die Programme und deren erstellte Kopien, weder insgesamt noch teilweise benutzen, kopieren, modifizieren, verändern oder weitergeben, es sei denn dies ist im Rahmen dieser Lizenz gestattet.

Falls der Käufer eine Kopie eines der Programme, außer gemäß Absatz E, an Dritte weitergibt, wird diese Lizenz automatisch außer Kraft gesetzt.

Laufzeit der Lizenz

Diese Lizenz ist nur so lange gültig, wie der Käufer das Produkt zu eigen hat oder im Leasing-Verfahren betreibt, falls sie nicht vorher widerrufen wird. Der Käufer darf diese Lizenz zu einem beliebigen Zeitpunkt aufheben, indem er die Programme und die dazugehörige Dokumentation zusammen mit allen davon in jeglicher Form erstellten Kopien auf eigene Kosten zerstört. Diese Lizenz wird außerdem mit sofortiger Wirkung aufgehoben, wenn eine der oben aufgeführten Bedingungen eintritt oder der Käufer irgendetwas Bestimmungen oder Bedingungen dieser Lizenzvereinbarung verletzt. Der Käufer verpflichtet sich, nach einer solchen Aufhebung der Lizenz die Programme und die dazugehörige Dokumentation zusammen mit allen davon in jeglicher Form erstellten Kopien auf eigene Kosten zu zerstören.

Der Käufer bestätigt, diese Vereinbarung gelesen und verstanden zu haben, und verpflichtet sich, ihre Bestimmungen und Bedingungen einzuhalten. Der Käufer bestätigt weiterhin, daß es sich bei der vorliegenden Vereinbarung um eine vollständige und ausschließliche Aufzeichnung der Vereinbarung zwischen dem Käufer und MEI handelt, die alle Vorschläge oder früheren Vereinbarungen, in mündlicher oder schriftlicher Form, sowie jegliche Unterredungen zwischen dem Käufer und MEI in Bezug auf die Gegenstände der vorliegenden Vereinbarung ablöst.

Contrat de licence d'usage limité

Le(s) logiciel(s) (les "Logiciels") fournis avec ce produit Panasonic® (le "Produit") sont exclusivement concédés en licence à l'utilisateur ultime ("vous"), et ils ne peuvent être utilisés que conformément aux clauses contractuelles ci-dessous. En utilisant les logiciels, vous vous engagez de manière définitive à respecter les termes, clauses et conditions des présentes.

Matsushita Electric Industrial Co., Ltd. ("MEI") a mis au point ou obtenu les Logiciels et vous en concède l'utilisation par les présentes. Vous assumez l'entière responsabilité du choix de ce Produit (y compris des Logiciels associés) pour obtenir les résultats escomptés, ainsi que de l'installation, de l'utilisation et des résultats obtenus.

Licence

- A. MEI vous octroie par les présentes le droit et la licence personnels, non cessibles et non exclusifs d'utiliser les Logiciels conformément aux termes, clauses et conditions de ce Contrat. Vous reconnaissez ne recevoir qu'un droit limité d'utiliser les Logiciels et la documentation les accompagnant et vous vous engagez à n'obtenir aucun droit de titre, propriété ni aucun autre droit vis-à-vis des Logiciels et de la documentation les accompagnant ni vis-à-vis des algorithmes, concepts, dessins, configurations et idées représentés par ou incorporés dans les Logiciels et la documentation les accompagnant, dont les titres, propriété et droits resteront tous à MEI.
- B. Vous ne pouvez utiliser les Logiciels que sur le Produit unique qui est accompagné par les Logiciels.
- C. Vous et vos employés ou agents êtes requis de protéger la confidentialité des Logiciels. Vous ne pouvez ni distribuer ni mettre les Logiciels et la documentation les accompagnant à la disposition d'un tiers, par partage de temps ou de quelque autre manière que ce soit, sans l'autorisation écrite préalable de MEI.
- D. Vous ne pouvez ni copier ni reproduire ni permettre la copie ni la reproduction des Logiciels ni de la documentation les accompagnant pour quelque fin que ce soit, à l'exception d'une (1) copie des Logiciels à des fins de sauvegarde uniquement pour soutenir votre utilisation des Logiciels sur le Produit unique qui est accompagné par les Logiciels. Vous ne pouvez ni modifier ni tenter de modifier les Logiciels.
- E. Vous ne pouvez céder les Logiciels et en octroyer la licence à une autre partie qu'en rapport avec votre cession du Produit unique qui est accompagné par les Logiciels à cette autre partie. Au moment de cette cession, vous devez céder également toutes les copies, que ce soit sous forme imprimée ou lisible par la machine, de tous les Logiciels ainsi que de la documentation les accompagnant, à la même partie ou détruire les copies non cédées.
- F. Vous ne pouvez retirer aucune marque de droits d'auteur, marque ou autre ni aucune identification de produit des Logiciels et vous devez reproduire et inclure toutes ces notices ou identifications de produit sur toutes les copies des Logiciels.

Vous ne pouvez assembler en sens inverse, compiler en sens inverse ni retracer les Logiciels ni aucune de leurs copies, de façon électronique ou mécanique, en tout ou en partie.

Vous ne pouvez utiliser, copier, modifier, altérer ni céder les Logiciels ni aucune de leurs copies, en tout ou en partie, à l'exception de ce qui est expressément stipulé dans ce contrat.

Si vous cédez la possession de toute copie ou de tout Logiciel à une autre partie, à l'exception de ce qui est autorisé au paragraphe E ci-dessus, votre licence est automatiquement résiliée.

Termes, clauses et conditions

Cette licence n'est effective que pour la durée de possession ou de crédit-bail du Produit, à moins d'une résiliation antérieure. Vous pouvez résilier cette licence à tout moment en détruisant, à vos frais, les Logiciels et la documentation les accompagnant avec toutes leurs copies, sous quelque forme que ce soit. Cette licence sera également résiliée, avec application immédiate, si les conditions de résiliation définies ailleurs dans ce contrat se sont réalisées ou si vous ne respectez pas les termes, clauses et conditions qui y sont contenues. Au moment de la résiliation, vous acceptez de détruire, à vos frais, les Logiciels et la documentation les accompagnant avec toutes leurs copies, sous quelque forme que ce soit.

Vous reconnaissez avoir lu ce contrat, en avoir compris toute la substance et avoir accepté de respecter ses termes, clauses et conditions. Vous reconnaissez en outre qu'ils sont la description complète et exclusive du contrat conclu entre nous, contrat qui remplace et annule toute proposition ou contrat précédent, écrit ou oral, et toute autre communication entre nous, relativement à l'objet du présent contrat.

Index

A

AC adapter 6,7,38
AC cord 6

B

Battery indicator 14,29
Battery pack 15,16,38,39
Battery status 14
Brightness adjustment 39

C

CD-ROM drive 22
CF-35 series Quick Guide 8
CPU 38
CPU speed change mode 13
Clicking 10
Coffee break password 18
Computer Viruses 5
Conserving power 12
Contrast adjustment 39

D

DC-IN jack 39
DIAG35 28
Display 25,30,39
Displayed colors 38
Double-clicking 10
Dragging 10

E

Error codes 28
Expansion bus connector 25,38,39
Ext. display port 25,38,39
Ext. keyboard/mouse port 38,39
External display 25

F

FDD cable 22
Firstaid FD 8,28,32
Floppy disk 5,8,19
Floppy disk drive 22,38
Floppy operation 19
Format 30

H

Hard disk drive (HDD) 5,26,38
HDD motor timeout 13
Headphone jack 38,39
Hibernation function 10,11
Hibernation timeout 12

I

I/O port address 31
Infrared communication port 21,38,39
Infrared data communications 21
IRQ 31

K

Keyboard 38,39

L

LED indicators 38,39
Limited use license agreement 40
Load default settings 36

M

Microphone jack 38,39
Multimedia pocket 22,38,39

N

Network password 9

P

Panasonic Setup icon 8
Parallel port 25,38,39
PC Card 23
PC Card slots 23,38,39
Peripherals 22,31
Port replicator 25
Power indicator 7,9
Power switch 7,9,39
Printer 25

S

Saving data 5
Security lock 39
Security measures 17
Self-diagnosis program 28
Serial port 38,39
Setup utility 31,36
Shutting down 10,11
Speakers 38,39
Standby mode 12
Standby timeout 13
Starting up 9,29
Supervisor password 19,20
Supervisor setup 19
Suspend function 10,11

R

RAM module 24
RAM module slot 24,38,39
Reinstalling software 32
Reset button 39
Restarting 10

T

TranXit 6,21,34

U

User password 17









V

Ventilation hole 39
Volume 39

W

Windows 95 setup 8,35
Write-protect tab 5

LED indicators

       38
 14,38
 7,9,38



As an ENERGY STAR Partner, Panasonic has determined that this product meets the ENERGY STAR guidelines for energy efficiency.

Outline of the International ENERGY STAR Office Equipment Program

The international ENERGY STAR Office Equipment Program is an international program that promotes energy saving through the use of computers and other office equipment. The program backs the development and dissemination of products with functions that effectively reduce energy consumption. It is an open system in which business proprietors can participate voluntarily. The targeted products are office equipment such as computers, displays, printers, facsimiles, and copiers. Their standards and logos are uniform among participating nations.