



Mobile Laptop 900™

Pentium M Model (Model # HK1223)



Motorola, Inc.

All rights reserved

Owner's Manual R01
Part No.: DDN 7415

ML900
Operation Manual
(Pentium M Model # HK1223)

Part Number:799001147001
(April 2006)

R01

TRADEMARKS

All brand and product names are trademarks or registered trademarks of their respective companies.

NOTE

Information in this manual is subject to change without notice.

COPYRIGHT

Copyright © 2005 Motorola Inc. All rights reserved. No part of this manual may be transmitted, stored in a retrieval system, or translated into any language or computer language, in any form or by any means, without the prior written permission of Motorola Inc.

Regulations Information

Class B Regulations

USA

Federal Communications Commission Radio Frequency Interference Statement

NOTE

This equipment has been tested and found to comply with the limits for a Class B digital device pursuant to Part 15 of the FCC Rules. These limits are designed to provide reasonable protection against harmful interference in a residential installation. This equipment generates, uses, and can radiate radio frequency energy and, if not installed and used in accordance with the instructions, may cause harmful interference to radio communications. However, there is no guarantee that interference will not occur in a particular installation. If this equipment does cause harmful interference to radio or television reception, which can be determined by turning the equipment off and on, the user is encouraged to try to correct the interference by one or more of the following measures:

- Reorient or relocate the receiving antenna.
- Increase the separation between the equipment and receiver.
- Connect the equipment into an outlet on a circuit different from that to which the receiver is connected.

- Consult the dealer or an experienced radio/TV technician for help.

Any changes or modifications not expressly approved by the manufacturer could void the user's authority to operate the equipment.

Please note:

The use of a non-shielded interface cable with this equipment is prohibited.

Wireless LAN Module Statement

FCC CAUTION:

This device complies with Part 15 of the FCC Rules. Operation is subject to the following two conditions: (1) this device may not cause harmful interference, and (2) this device must accept any interference received, including interference that may cause undesired operation.

FCC RF Exposure Statement

This equipment complies with FCC RF exposure limits set forth for an uncontrolled environment. This equipment should be installed and operated with a minimum distance of 20cm between the radiator and your body.

To assure continued compliance, any changes or modifications not expressly approved by the party responsible for compliance could void the user's authority to operate this equipment.

Canada

Canadian Department of Communications Radio Interference Regulations Class B Compliance Notice

This Class B digital apparatus meets all requirements of the Canada Interference-Causing equipment regulations.

Cet appareil numérique de Classe B respecte toutes les exigences du Règlement Canadien sur le matériel brouilleur.

This digital apparatus does not exceed the Class B limits for radio noise emissions from digital apparatus set out in the Radio Interference Regulations of the Canadian Department of Communications.

Le présent appareil numérique n'émet pas de bruits radioélectriques dépassant les limites applicables aux appareils numériques de la classe B prescrites dans le Règlement sur le brouillage radioélectrique édicté par le ministère des Communications du Canada.

Canada Radio Frequency Interference Requirements

To prevent radio interference to the licensed service, this device is intended to be operated indoors and away from windows to provide maximum shielding. Equipment (or its transmit antenna) that is installed outdoors is subject to licensing.

Pour empêcher que cet appareil cause du brouillage au service faisant l'objet d'une licence, il doit être utilisé à l'intérieur et devrait être placé loin des fenêtres afin de fournir un écran de blindage maximal. Si le matériel (ou son antenne d'émission) est installé à l'extérieur, il doit faire l'objet d'une licence.

SAFE USAGE NOTIFICATION:

For reason of personal safety and optimal radio performance, Motorola has designed the ML900 with an intended purpose and position of use either in a secured vehicle docking station or on the top of an office desk.

Motorola strongly recommends using this product in a vehicle only when it is physically-secured in a lock or assured-stationary location as failure to do so may cause the product to cause harm in accidents or other conditions.

Product Safety and RF Exposure Information



Caution

BEFORE USING THIS RUGGEDIZED LAPTOP, READ THIS SECTION WHICH CONTAINS IMPORTANT OPERATING INSTRUCTIONS FOR SAFE USAGE AND RF ENERGY AWARENESS AND CONTROL INFORMATION FOR COMPLIANCE WITH RF ENERGY EXPOSURE LIMITS IN APPLICABLE NATIONAL AND INTERNATIONAL STANDARDS.

Compliance with RF Energy Exposure Standards

Note: This ruggedized laptop is intended for general population, consumer or similar use; where users are not necessarily aware of the potential for exposure and may not exercise control over their exposure.

This product safety section includes useful information about RF exposure and helpful instructions on how to control your RF exposures.

For additional information on exposure requirements or other training information, visit <http://www.motorola.com/rfhealth>.

Electromagnetic Interference / Compatibility

NOTE: Nearly every electronic device is susceptible to electromagnetic interference (EMI) if inadequately shielded, designed or otherwise configured for electromagnetic compatibility.

Facilities

To avoid electromagnetic interference and/or compatibility conflicts, turn off your ruggedized laptop and/or integrated radios in any facility where posted notices instruct you to do so. Hospitals or health care facilities may be using equipment that is sensitive to external RF energy.

Aircraft

When instructed to do so, turn off your ruggedized laptop and/or integrated radios when on board an aircraft. Any use of a laptop or radio must be in accordance with applicable regulations per airline crew instructions.

Medical Devices

Pacemakers

Keep the antennas of this data terminal at least 8 inches or 20cm away from any person's body. Along with ensuring compliance with the RF energy exposure limits (as instructed in the RF Energy Exposure section previously), this separation distance meets or exceeds the distance recommendation of pacemaker manufacturers and the FCC to avoid interference with pacemakers.

Hearing Aids

Some digital wireless radios may interfere with some hearing aids. In the event of such interference, you may want to consult your hearing aid manufacturer to discuss alternatives.

Other Medical Devices

If you use any other personal medical device, consult the manufacturer of your device to determine if it is adequately shielded from RF energy. Your physician may be able to assist you in obtaining this information.

Driver Safety

Always abide by the laws and regulations on the use of computers and/or integrated radios in the area where you drive.

When using your laptop and/or radio while driving, please:

- Give full attention to driving and to the road.
- Pull off the road and park before using the equipment if driving conditions so require.

Operational Warnings

For Vehicles with an Air Bag

Do not place a ruggedized laptop in the area over an air bag or in the air bag deployment area. Air bags inflate with great force. If a ruggedized laptop is placed in the air bag deployment area and the air bag inflates, the laptop may be propelled with great force and cause serious injury to occupants of the vehicle.

Potentially Explosive Atmospheres

Turn off your ruggedized laptop prior to entering any area with a potentially explosive atmosphere. Do not remove, install, or charge batteries in such areas. Sparks in a potentially explosive atmosphere can cause an explosion or fire resulting in bodily injury or even death.

The areas with potentially explosive atmospheres referred to above include fuelling areas such as below decks on boats, fuel or chemical transfer or storage facilities, areas where the air contains chemicals or particles, such as grain, dust or metal powders. Areas with potentially explosive atmospheres are often but not always posted.

Blasting Caps and Areas

To avoid possible interference with blasting operations, turn off your ruggedized laptop when you are near electrical blasting caps, in a blasting area, or in areas posted: "Turn off two-way radio". Obey all signs and instructions.

Operational Cautions

Antennas

Do not use the integrated radios of any ruggedized laptop that has a damaged antenna. If a damaged antenna comes into contact with your skin, a minor burn can result.

Batteries

All batteries can cause property damage and/or bodily injury such as burns if conductive materials such as jewelry, keys, or beaded chains touch exposed terminals. The conductive material may complete an electrical circuit (short circuit) and become quite hot. Exercise care in handling any charged battery, particularly when placing it inside a pocket, purse, or other container with metal objects.

LICENSE AGREEMENT

MOTOROLA, INC. (“MOTOROLA”) IS WILLING TO LICENSE THE SOFTWARE EMBEDDED IN THE ENCLOSED PRODUCT (THE “SOFTWARE”) TO YOU ONLY ON THE CONDITION THAT YOU ACCEPT ALL OF THE TERMS CONTAINED IN THIS LICENSE AGREEMENT (“AGREEMENT”). PLEASE READ THE TERMS CAREFULLY. YOUR USE OF THE PRODUCT WITH THE EMBEDDED SOFTWARE WILL INDICATE YOUR ASSENT TO THEM. IF YOU DO NOT AGREE TO THESE TERMS, THEN MOTOROLA IS UNWILLING TO LICENSE THE SOFTWARE TO YOU, IN WHICH EVENT YOU SHOULD NOT USE THE PRODUCT WITH THE EMBEDDED SOFTWARE AND YOU SHOULD RETURN IT TO THE PLACE FROM WHICH IT WAS ACQUIRED, AND YOUR MONEY WILL BE REFUNDED.

Section 1 GRANT OF LICENSE

Motorola hereby grants to You a personal, non-exclusive, non-transferable right to use the Software subject to the Conditions Of Use set forth in Section 2 below and the terms and conditions of this Agreement.

Section 2 CONDITIONS OF USE

- 2.1 Use of the Software outside of the conditions set forth herein is strictly prohibited and will be deemed a breach of this Agreement.
- 2.2 You shall use the Software (i) only for Your internal business purposes; (ii) only as described in the Software or product documentation; and (iii) in strict accordance with this Agreement.
- 2.3 You shall not transfer, download, copy, distribute, sublicense, modify, adapt, merge with other software, reverse engineer, prepare derivative works of, de-compile or disassemble any Software for any reason.
- 2.4 You shall not remove, destroy, or alter any proprietary markings or legends placed upon or contained within the Software, related materials or documentation.

2.5 You shall not export, re-export, resell, ship or divert or cause to be exported, re-exported, resold, shipped, or diverted, directly or indirectly, the Software under this Agreement.

Section 3 TITLE AND OWNERSHIP

Title to all copies of Software will not pass to You at any time and remains vested exclusively in Motorola or the copyright owner. Motorola or the copyright owner owns and retains all of its proprietary rights in any form concerning the Software, including all rights in patents, patent applications, inventions, copyrights, trade secrets, trademarks, trade names, and other intellectual properties. Nothing in this Agreement is intended to restrict the proprietary rights of Motorola or the copyright owner or to grant by implication or estoppel any proprietary rights. All intellectual property developed, originated, or prepared by Motorola or the copyright owner in connection with providing the Software, products, or related services to You remains vested exclusively in Motorola or the copyright owner, and this Agreement does not grant to You any shared development rights of intellectual property.

Section 4 CONFIDENTIALITY

You acknowledge that all Software contains valuable proprietary information and trade secrets and that unauthorized or improper use of Software will result in irreparable harm to Motorola for which monetary damages would be inadequate and for which Motorola will be entitled to immediate injunctive relief. Accordingly, You will limit access to Software to employees and agents who need to use the Software for Your internal business purposes, and You will take appropriate action with those employees and agents to preserve the confidentiality of Software, using the same degree of care to avoid unauthorized or improper disclosure as You use for the protection of Your own proprietary software, but in no event less than reasonable care. Notwithstanding anything to the contrary herein, You shall have no obligation to preserve the confidentiality of any proprietary information that (i) was in the public domain at the time of disclosure; (ii) entered the public domain through no fault of You; (iii) was given to You free of any obligation to keep it confidential; (iv) is independently developed by You; or (v) is disclosed as required by law provided that You notify Motorola prior to such disclosure and provide Motorola with a reasonable opportunity to respond.

Section 5 RIGHT TO USE MOTOROLA'S NAME

You shall not, during the term of this Agreement or thereafter, use any trademark of Motorola, or any word or symbol likely to be confused with any Motorola trademark, either alone or in any combination with another word or words.

Section 6 PAYMENT

The rights granted hereunder are contingent upon payment for the product in which the Software is embedded.

Section 7 TERM AND TERMINATION

Your right to use Software will begin when You begin using the product with the embedded Software, which constitutes acceptance of the terms and conditions herein, and will continue in perpetuity unless terminated as set forth herein. Your right to use Software will terminate immediately without notice upon a breach of this Agreement by You. Otherwise, this Agreement may be terminated by either party upon thirty (30) days prior written notice. Within thirty (30) days after termination of this Agreement, You will certify to Motorola in writing that through Your best efforts, and to the best of Your knowledge, the original and all copies, in whole in part, in any form, of the Software and all related material and documentation, have been destroyed.

Section 8 MAINTENANCE

Motorola shall not be responsible for maintenance or field service of the Software under this Agreement.

Section 9 NO WARRANTY

MOTOROLA DOES NOT WARRANT THAT THE SOFTWARE WILL MEET YOUR REQUIREMENTS, OR THAT THE OPERATION OF THE SOFTWARE WILL BE UNINTERRUPTED OR ERROR-FREE. MOTOROLA DISCLAIMS ALL WARRANTIES, EXPRESS OR IMPLIED, INCLUDING THE IMPLIED WARRANTIES OF MERCHANTABILITY AND FITNESS FOR A PARTICULAR PURPOSE.

Section 10 LIMITATION OF LIABILITY

MOTOROLA'S TOTAL LIABILITY UNDER THIS AGREEMENT FOR DAMAGES SHALL NOT EXCEED THE TOTAL AMOUNT PAID BY YOU FOR THE SOFTWARE UNDER THIS AGREEMENT. IN NO EVENT WILL MOTOROLA BE LIABLE FOR INCIDENTAL, CONSEQUENTIAL, INDIRECT, SPECIAL, OR PUNITIVE DAMAGES.

Section 11 U.S. GOVERNMENT

If You are a unit or agent of the U.S. Government, You acknowledge Motorola's representation that the Software represents "Commercial Computer Software" and that the Government's use of the Software shall be subject to "Restricted Rights", as provided in DFARS 252.227-7013 (c) (1) (ii), or FAR 52.227-19.

Section 12 GOVERNING LAW

This Agreement shall be governed by the laws of the United States of America to the extent that they apply and otherwise by the laws of the State of Illinois.

Section 13 ASSIGNMENT

This Agreement may not be assigned or otherwise transferred by You.

Section 14 SURVIVAL OF PROVISIONS

The parties agree that where the context of any provision indicates an intent that it shall survive, the term of this Agreement then it shall survive.

Section 15 ENTIRE AGREEMENT:

This Agreement contains the parties' entire agreement regarding Your use of Software and may be amended only in a writing signed by both parties, except that Motorola may modify this Agreement as necessary to comply with applicable laws and regulations including FCC regulations.

Section 16 THIRD-PARTY SOFTWARE

The Software may contain one or more items of third-party software supplied by other third-party suppliers. The terms of this Agreement govern Your use of any third-party software UNLESS A SEPARATE THIRD-PARTY SOFTWARE LICENSE IS INCLUDED WITH THIS PACKAGE, IN WHICH CASE YOUR USE OF THE THIRD-PARTY SOFTWARE WILL THEN BE GOVERNED BY THE SEPARATE THIRD-PARTY LICENSE.

IF THE FOREGOING TERMS AND CONDITIONS ARE ACCEPTABLE TO YOU, YOU AGREE THAT YOUR USE OF THE PRODUCT WITH THE EMBEDDED SOFTWARE WILL INDICATE YOUR ACCEPTANCE OF THIS AGREEMENT.

IF THE FOREGOING TERMS AND CONDITIONS ARE NOT ACCEPTABLE TO YOU, THEN MOTOROLA IS UNWILLING TO LICENSE THE SOFTWARE TO YOU, IN WHICH EVENT YOU SHOULD NOT USE THE PRODUCT WITH THE EMBEDDED SOFTWARE AND YOU SHOULD RETURN IT TO THE PLACE FROM WHICH IT WAS ACQUIRED, AND YOUR MONEY WILL BE REFUNDED.

COMPUTER SOFTWARE COPYRIGHTS

The Motorola products described in this instruction manual may include copyrighted Motorola computer programs stored in semiconductor memories or other media. Laws in the United States and other countries preserve for Motorola certain exclusive rights for copyrighted computer programs, including the exclusive right to copy or reproduce in any form the copyrighted computer program. Accordingly, any copyrighted Motorola computer programs contained in the Motorola products described in this instruction manual may not be copied or reproduced in any manner without the express written permission of Motorola. Furthermore, the purchase of Motorola products shall not be deemed to grant either directly or by implication, estoppels or otherwise, any license under the copyrights, patents or patent applications of Motorola, except for the normal non-exclusive, royalty free license to use that arises by operation of law in the sale of a product.

This Warranty applies within the fifty(50) United States' the District of Columbia and Canada.

LIMITED WARRANTY

MOTOROLA COMMUNICATION PRODUCTS

If the affected product is being purchased pursuant to a written Communications System Agreement signed by Motorola, the warranty contained in that written agreement will apply. Otherwise, the following warranty applies.

I. WHAT THIS WARRANTY COVERS AND FOR HOW LONG:

Motorola Inc. or if applicable, Motorola Canada Limited ("Motorola",) warrants the Motorola manufactured radio communications product, including original equipment crystal devices and channel elements ("Product"), against material defects in material and workmanship under normal use and service for a period of Three (3) Years from the date of shipment.

Motorola, at its option, will at no charge either repair the Product (with new or reconditioned parts), replace it with the same or equivalent Product (using new or reconditioned Product), or refund the purchase price of the product during the warranty period provided purchaser notifies Motorola according to the terms of this warranty. Repaired or replaced Product is warranted for the balance of the original applicable warranty period. All replaced parts of the Product shall become the property of Motorola.

This express limited warranty is extended by Motorola to the original end user purchaser purchasing the Product for purposes of leasing or for commercial, industrial, or governmental use only, and is not assignable or transferable to any other party. This is the complete warranty for the Product manufactured by Motorola. Motorola assumes no obligations or liability for additions or modifications to this warranty unless made in writing and signed by an officer of Motorola. Unless made in a separate written agreement between Motorola and the original end user purchaser, Motorola does not warrant the installation maintenance or service of the Product.

Motorola cannot be responsible in any way for any ancillary equipment not furnished by Motorola which is attached to or used in connection with the product, or for operation of the Product with any ancillary equipment, and all such equipment is expressly excluded from this

warranty. Because each system which may use the Product is unique, Motorola disclaims liability for range, coverage, or operation of the system as a whole under this warranty.

II. GENERAL PROVISIONS:

This warranty sets forth the full extent Motorola's responsibilities regarding the product. Repair replacement or Refund of the purchase price, at Motorola's option, is the exclusive is the exclusive remedy. THIS WARRANTY IS GIVEN IN LIEU OF ALL OTHER EXPRESS WARRANTIES.

MOTOROLA DISCLAIMS ALL OTHER WARRANTIES OR CONDITIONS, EXPRESS OR IMPLIED INCLUDING THE IMPLIED WARRANTIES OR CONDITIONS OF MERCHANTABILITY AND FITNESS FOR A PARTICULAR PURPOSE. IN NO EVENT SHALL MOTOROLA BE LIABLE FOR DAMAGES IN EXCESS OF THE PURCHASE PRICE OF THE PRODUCT FOR ANY LOSS OF USE, LOSS OF TIME, INCONVENIENCE, COMMERCIAL LOSS, LOST PROFITS OR SAVINGS OR OTHER INCIDENTAL, SPECIAL INDIRECT OR CONSEQUENTIAL DAMAGES ARISING OUT OF THE USE OR INABILITY TO USE SUCH PRODUCT TO THE FULL EXTENT SUCH MAY BE DISCLAIMED BY LAW.

III. How TO GET WARRANTY SERVICE:

Purchaser must notify Motorola's representative or call Motorola's Customer Response Center at 1.800.247.2346 within the applicable warranty period for information regarding warranty service.

IV. WHAT THIS WARRANTY DOES NOT COVER:

- A) Defects or damage resulting from use of the Product in other than its normal and customary manner.
- B) Defects or damage from misuse, accident, water, or neglect.
- C) Defects or damage from improper testing, operation, maintenance, installation, alteration, modification, or adjustment.
- D) Breakage or damage to antennas unless caused directly by defects in material workmanship.
- E) A Product subjected to unauthorized Product modifications, disassemblies or repairs (including, without limitation, the addition to the Product of non-Motorola supplied equipment) which adversely affect performance of the Product or interfere with Motorola's normal warranty inspection and testing of the Product to verify any warranty claim.
- F) Product which has had the serial number removed or made illegible.
- G) Accessories, including batteries carry their own separate limited One (1) year warranty.
- H) Freight costs to the repair depot.

- I) A Product which, due to illegal or unauthorized alteration of the software/firmware in the Product, does not function in accordance with Motorola's published specifications or with the FCC type acceptance labeling in effect for the Product at the time the Product was initially distributed from Motorola.
- J) Scratches or other cosmetic damage to Product surfaces that do not affect the operation of the Product.
- K) That the software in the product will meet the purchaser's requirements or that the operation of the software will be uninterrupted or error-free.
- L) Normal and customary wear and tear.
- M) Non-Motorola manufactured equipment unless bearing a Motorola Part Number in the form of an alphanumeric number (i.e., TDE6030B).

V. GOVERNING LAW

In the case of a Product sold in the United States and Canada, this Warranty is governed by the laws of the State of Illinois and the Province of Ontario respectively.

VI. PATENT AND SOFTWARE PROVISIONS:

Motorola will defend, at its own expense, any suit brought against the end user purchaser to the extent that it is based on a claim that the Product or its parts infringe a United States patent, and Motorola will pay those costs and damages finally awarded against the end user purchaser in any such suit which are attributable to any such claim, but such defense and payments are conditioned on the following:

- A) That Motorola will be notified promptly in writing by such purchaser of any notice of such claim;
- B) That Motorola will have sole control of the defense of such suit and all negotiations for its settlement or compromise; and
- C) Should the Product or its parts become, or in Motorola's opinion be likely to become, the subject of a claim of infringement of a United

States patent, that such purchaser will permit Motorola, at its option and expense, either to procure for such purchaser the right to continue using the product or its parts or to replace or modify the same so that it becomes non-infringing or to grant such purchaser a credit for the Product or its parts as depredated and accept its return. The depreciation will be an equal amount per year over the lifetime of the product or its parts as established by Motorola.

Motorola will have no liability with respect to any claim of patent infringement which is based upon the combination of the Product or its parts furnished hereunder with software, apparatus or devices not furnished by Motorola, nor will Motorola have any liability for the use of ancillary equipment or software not furnished by Motorola which is attached to or used in connection with the Product. The foregoing states the entire liability of Motorola with respect to infringement of patents by the Product or any of its parts thereof.

About the Battery

Caution Texts Concerning Lithium Batteries

DANISH

ADVARSEL!

Lithiumbatteri – Eksplosionsfare ved fejlagtig håndtering. Udskiftning må kun ske med batteri af samme fabrikat og type. Levér det brugte batteri tilbage til leverandøren.

NORWEGIAN

ADVARSEL:

Eksplosjonsfare ved feilaktig skifte av batteri. Benytt samme batteritype eller en tilsvarende type anbefalt av apparatfabrikanten. Brukte batterier kasseres i henhold til fabrikantens instruksjoner.

SWEDISH

VARNING:

Explosionsfara vid felaktigt batteribyte. Använd samma batterityp eller en ekvivalent typ som rekommenderas av apparattillverkaren. Kassera använt batteri enligt fabrikantens instruktion.

FINNISH

VAROITUS:

Paristo voi räjähtää, jos se on virheellisesti asennettu. Vaihda paristo ainoastaan valmistajan suosittelemaan tyyppiin. Hävitä käytetty paristo valmistajan ohjeiden mukaisesti.

ENGLISH

CAUTION:

Danger of explosion if battery is incorrectly replaced. Replace only with the same or equivalent type recommended by the equipment manufacturer. Discard used batteries according to manufacturer's instructions.

DEUTSCH

VORSICHT:

Explosionsgefahr bei unsachgemäßem Austausch der Batterie. Ersatz nur durch denselben oder einen vom Hersteller empfohlenen gleich-wertigen Typ. Entsorgung gebrauchter Batterien nach Angaben des Herstellers.

FRENCH

ATTENTION:

Il y a danger d'explosion s'il y a remplacement incorrect de la batterie. Remplacer uniquement avec une batterie du même type ou d'un type équivalent recommandé par le constructeur. Mettre au rebut les batteries usagées conformément aux instructions du fabricant.

Attention (for USA Users)

The product that you have purchased contains a rechargeable battery. The battery is recyclable. At the end of its useful life, under various state and local laws, it may be illegal to dispose of this battery into the municipal waste stream. Check with your local solid waste officials for details in your area for recycling options or proper disposal.

About the Modem

Caution

1. Never install telephone wiring during a lightning storm.
2. Never install telephone jacks in wet locations unless the jack is specifically designed for wet locations.
3. Never touch uninsulated telephone wires or terminals unless the telephone line has been disconnected at the network interface.
4. Use caution when installing or modifying telephone lines.
5. Avoid using the telephone function (other than a cordless-type) during an electrical storm. There may be a remote risk of electric shock from lightning.
6. Do not use the telephone function to report a gas leak in the vicinity of the leak.
7. Do not use this product near water, for example near a bathtub, wash bowl, kitchen sink or laundry tub, in a wet basement or near a swimming pool.

About the AC Adapter

1. Use only the AC adapter supplied with your computer. Use of another type of AC adapter will result in malfunction and/or danger.
2. Do not use the adapter in a high moisture environment. Never touch the adapter when your hands or feet are wet.
3. Allow adequate ventilation around the adapter when using it to operate the device or charge the battery. Do not cover the AC adapter with paper or other objects that will reduce cooling. Do not use the AC adapter while it is inside a carrying case.

4. Connect the adapter to a proper power source. The voltage requirements are found on the product case and/or packaging.
5. Do not use the adapter if the cord becomes damaged.
6. Do not attempt to service the unit. There are no serviceable parts inside. Replace the unit if it is damaged or exposed to excess moisture.

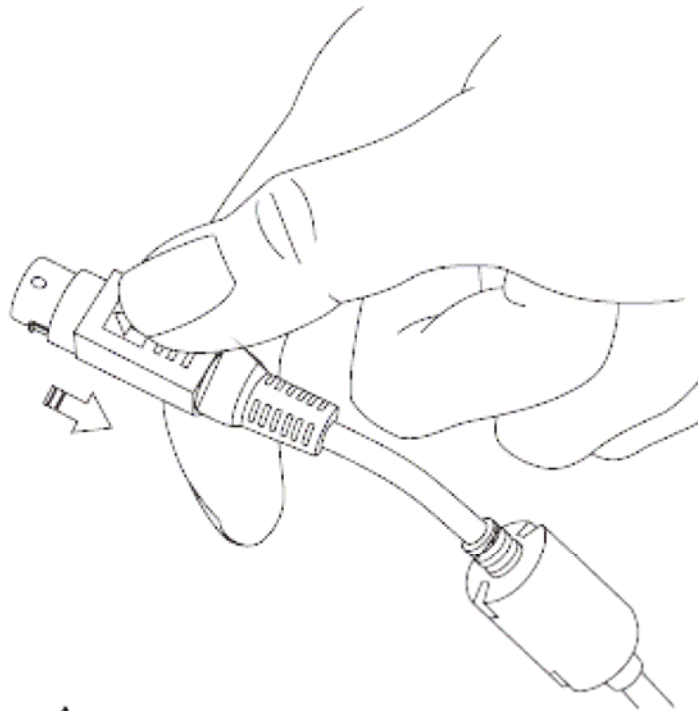

⚠ CAUTION! DO NOT PULL THE WIRE TO UNPLUG!

Table of Contents

Preface	vii
Chapter 1 Getting Started	1-1
Getting the Computer Running	1-2
Unpacking	1-2
Connecting to AC Power	1-3
Opening the Cover	1-4
Turning On and Off the Computer	1-5
Taking a Look at the Computer	1-6
Right-Side Components	1-6
Left-Side Components	1-7
Rear Components	1-8
Front Components	1-9
Bottom-Side Components	1-10
Top-open Components	1-12
Where to Go from Here	1-14
Chapter 2 Operating Your Computer	2-1
Starting and Stopping the Computer	2-2
Starting the Computer	2-2
Stopping the Computer	2-2
Using the Keyboard	2-4
Typewriter Keys	2-4
Cursor-Control Keys	2-5

Numeric Keypad	2-5
Euro Symbol	2-6
Windows Keys	2-6
Function Keys	2-6
Fn Key.....	2-7
Hot Keys	2-7
Using the Touchpad.....	2-9
Configuring the Touchpad	2-11
Using the Touchscreen (option).....	2-12
Using the Hard Disk Drive	2-13
Using the DVD/Combo/DVD Dual Drive.....	2-14
Installing the DVD/Combo/DVD Dual Drive.....	2-15
Inserting and Removing a CD.....	2-16
Using the Video Features.....	2-17
Configuring the Display Modes.....	2-18
Using the Audio Features	2-19
Connecting Audio Devices	2-20
Using the Communication Features.....	2-21
Using the LAN.....	2-21
Using the Wireless LAN	2-22
Using the Wireless Modem.....	2-25
Using the GPS.....	2-27
Using MESH Modem.....	2-28
Using the Bluetooth.....	2-28

Chapter 3 Managing Power3-1

AC Adapter.....	3-2
Battery Pack.....	3-3
Charging the Battery Pack	3-3
Initializing the Battery Pack.....	3-4
Checking the Battery Level.....	3-4
Replacing the Battery Pack.....	3-5
Battery Low Signals and Actions.....	3-6
Power Management	3-7
Hibernation	3-8

Power-Saving Tips.....	3-9
Chapter 4 Expanding Your Computer.....	4-1
Connecting an External Monitor.....	4-2
Connecting a USB Device	4-3
Connecting a Serial Device.....	4-4
Connecting an IR Device.....	4-5
Connecting a Bluetooth-compliant Device (option)	4-7
Connecting a Video Capture Device.....	4-10
System Memory Upgrade	4-11
Chapter 5 Setup Configuration Utility (SCU).....	5-1
When and How to Use the SCU Program.....	5-2
When to Use.....	5-2
Starting SCU	5-2
Moving Around and Making Selections	5-4
Main Menu.....	5-5
Advanced Menu.....	5-8
Security Menu.....	5-9
Boot Menu	5-13
Exit Menu	5-14
Chapter 6 Installing Software Drivers.....	6-1
How to Use the Driver CD.....	6-2
Installing the Fingerprint Driver	6-6
Installing the Video Capture Driver	6-10
Chapter 7 Caring for the Computer	7-1
Protecting the Computer	7-2
Using the Password	7-2
Using an Anti-Virus Strategy	7-2
Taking Care of the Computer	7-3
Location Guidelines	7-3
General Guidelines.....	7-3
Cleaning Guidelines	7-4

Battery Pack Guidelines.....	7-4
When Traveling	7-5
Chapter 8 Troubleshooting.....	8-1
Preliminary Checklist	8-2
Solving Common Problems.....	8-3
Battery Problems.....	8-4
Bluetooth Problems.....	
DVD/Combo/DVD Dual Drive Problems	8-4
Display Problems	8-5
Fingerprint Recognition Problems	8-7
Hardware Device Problems.....	8-7
Hard Disk Drive Problems.....	8-7
Infrared Problems.....	8-8
Keyboard, Mouse, and Touchpad Problems	8-8
LAN Problems	8-9
WLAN Problems.....	8-9
Modem Problems	8-9
Power Management Problems.....	8-11
Printer Problems.....	8-12
Software Problems	8-12
Sound Problems	8-13
Startup Problems.....	8-14
Other Problems	8-15
Resetting the Computer	8-16
Appendix A Specifications	A-1
Appendix B Fingerprint Recognition System	B-1
Finger Placement	B-2
Using the Fingerprint Recognition System Utility	B-3

Preface

This manual contains information that will help you operate the computer. It is divided into 8 chapters and 3 appendices.

Chapter 1, **Getting Started**, takes you through the process of setting up the computer and identifying its external components.

Chapter 2, **Operating Your Computer**, tells you how to use the computer's components and features.

Chapter 3, **Managing Power**, provides information on power.

Chapter 4, **Expanding Your Computer**, provides information on installing and using peripheral devices.

Chapter 5, **SCU (Setup Configuration Utility)**, describes the SCU program that configures the computer's BIOS settings.

Chapter 6, **Installing Software Drivers**, describes how to install the drivers and utilities supplied with the computer.

Chapter 7, **Caring for the Computer**, gives you tips in care and maintenance.

Chapter 8, **Troubleshooting**, gives solutions to common problems you may encounter when using the computer.

Appendix A, **Specifications**, gives a brief specification of the computer.

Appendix B, **Fingerprint Recognition System**, provides information on using the system's fingerprint recognition system.

Notational Conventions

Throughout this manual, the following conventions are used to distinguish elements of text.

| NOTE: identifies additional information that requires special attention.

| CAUTION: identifies important information which, if not followed, may result in loss of data or damage to the computer.

Keyboard keys are shown in a bold typeset. For example:

Press **Enter** to complete.

When keys are joined by a plus sign (+), press the first key, and, while keeping the first key down, press the remaining keys, finally release all the keys. When necessary, keys are also shown in graphics.

A title, command, setup item, or button that you can see on the screen is shown in boldface. A value or an option that you can select for a setup item is shown in italic. For example:

Select **Power Management**, set it to *Enabled*, and then click the **OK** button.

Getting Started

Congratulations on purchasing this computer.

This high performance notebook computer is especially designed for the practical applications of warehouses, automobiles, vehicles, public security, repairing, assisting the handicapped, and other demanding situations where conventional notebook computers just cannot measure up.

This chapter first tells you step by step how to get the computer up and running. You will find instructions for these procedures:

- Unpacking
- Connecting to AC power
- Opening the cover
- Turning on the computer
- Turning off the computer

Then, you will find a section briefly introducing the external components of the computer. And the last section navigates you to the information you may need after the computer is ready for use.

Getting the Computer Running

This section guides you through the procedures for getting the computer ready for operation.

Unpacking

After unpacking the shipping carton, you should find these standard items:

- Notebook computer
- Accessories:
 - AC adapter (100~240 VAC, 50/60 Hz)
 - AC power cord (US/CE/UK/SA)
 - Battery
 - RGB-to-DVI Adapter
 - CD including Drivers and User Manual
 - Windows XP Operating System CD

Inspect all the items. If any item is damaged or missing, notify your dealer immediately.

Keep the shipping carton and packing materials in case you need to ship or store the computer in the future.

Connecting to AC Power

The computer operates either on the external AC power or internal battery power. It is suggested that you use AC power when you start up the computer for the first time.

CAUTION: Use only the AC adapter included with your computer. Using other AC adapters may damage the computer.

NOTE:

Power Supply Cord: (optional) Detachable, minimum 1.5 m long. Listed, rated minimum 125 V, 7 A, having a 2/18 AWG, type SVT flexible cord. One end terminates with a parallel blade, molded-on, attachments plug with a 7 A, 125 V (NEMA 1-15P) configuration; other end terminates with a molded-on appliance coupler.

Alternative: (optional) Detachable, maximum 4.5 m (14.76 ft) long. Listed, rated minimum 250 V, 6 A, having a 3/18 AWG, type SVT flexible cord. One end terminates with a Tandem blade, grounding, listed molded-on, attachments plug with a 6 A, 250 V (NEMA 6-15P) configuration; other end terminates with a molded-on appliance coupler.

1. Make sure the computer is turned off.
2. Plug the DC cord of the AC adapter to the power connector on the rear side of the computer (❶).
3. Plug the female end of the AC power cord to the AC adapter and the male end to an electrical outlet (❷).

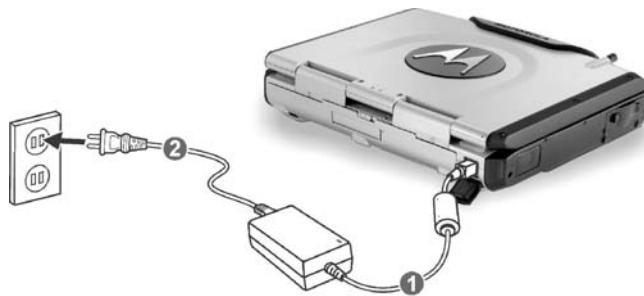

4. When the AC adapter is connected, the indicator on the AC adapter lights up, indicating that power is being supplied from the electrical outlet to the AC adapter and onto your computer. Now, you are ready to turn on the computer.

CAUTION:

- When you disconnect the AC adapter, disconnect from the electrical outlet first and then from the computer. A reverse procedure may damage the AC adapter or the computer.
- When unplugging the connector, always hold the plug head. Never pull on the cord.

NOTE: When the AC adapter is connected, it also charges the battery pack. For information on using battery power, see Chapter 3.

Opening the Cover

CAUTION: Be gentle when opening and closing the cover. Opening it vigorously or slamming it shut could damage the computer.

1. Open the top cover by pulling on the handle, inserting your index finger, and then pulling on the cover latch.



2. Lift up the cover. You can tilt the cover forward or backward for optimal viewing clarity.

Turning On and Off the Computer

Turning On

1. Make sure the computer has a charged battery or is connected to an AC power supply.
2. Press the power button.



3. Each time the computer is turned on, it performs a Power-On Self Test (POST), and the operating system such as Windows should start.

Turning Off

To turn off the computer safely, use the “Shut Down” command of your operating system.

NOTE: There are other ways you can stop the computer so that you will be back to where you left off when you next turn on the computer. (See “Stopping the Computer” in Chapter 2 for information.)

CAUTION: If you have to turn the computer on again immediately after turning it off, wait for at least five seconds. Turning the computer off and on rapidly can damage it.

Taking a Look at the Computer

This section identifies the external components of the computer and briefly describes the function of each component.

NOTE: Depending on the model you purchased, the appearance of your computer may not exactly be the same as those shown in this manual.

Right-Side Components



Ref	Component	Description	See Also
❶	PC Card Slot	Accepts a PC card for additional functions.	P. 4-6
❷	RJ-11 Connector	Connects the telephone line.	P. 2-19
❸	USB Ports	Each of the two ports connects a USB device, such as a USB floppy drive, printer, digital camera, joystick, and more.	P. 4-3
❹	RJ-45 Connector	Connects the LAN cable. Includes a Link Indicator and an Active Indicator.	P. 2-21
❺	DVD/Combo/DVD Dual Drive	Accepts a compact disc (CD) for installing or loading software, accessing data, and playing music/video.	P. 2-15



Left-Side Components

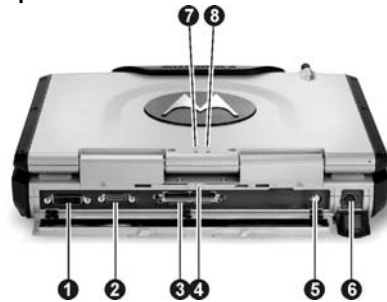

Ref	Component	Description	See Also
①	IR Transceiver	Connects an IrDA-compliant device for wireless data transfer.	P. 4-5
②	Bluetooth Transceiver (option)	Connects a bluetooth-capable device for wireless data transfer.	P. 4-5
③	Microphone Connector	Connects an external microphone.	P. 2-20
④	Keyboard BIOS Reset Switch	Use this to turn off the system when resetting the system using Ctrl+Alt+Del does not work.	P. 8-15
⑤	Audio Output Connector	Connects a set of headphones, external speakers with amplifier, or an audio recording device.	P. 2-20

Rear Components



Ref	Component	Description	See Also
①	DVI-I Port	Connects an external monitor with a DVI interface.	P. 4-2
②	Serial Port	Connects a serial device, such as an external modem.	P. 4-4
③	Docking Port	For connecting to a Port Replicator / car mount (both are available as an option).	
④	Rear Cover Latch	Locks the rear cover.	
⑤	AV Input Port	Connects to a video recording device.	P. 4-7
⑥	Power Connector	Connects the AC adapter.	P. 1-3
⑦	AC Power Indicator 	Glows green when the computer is using AC power. Blinks amber (orange) when the computer, using AC power, is in Standby mode.	P. 1-3
⑧	Battery Charge Indicator 	Glows green when the battery is fully charged and connected to AC power. Glows amber (orange) when the battery is being charged.	P. 3-3

Front Components



Ref	Component	Description	See Also
①	Wireless Modem Antenna	Serves as the antenna for the optional wireless modem (RDLAP, GPRS, iDEN, and CDMA).	P. 2-24
②	Stereo Speaker Set	Sends out sound and voice from the computer.	P. 2-19
③	Handle	Allows you to carry your computer for an easy grip.	
④	Wireless LAN Antenna	Serves as the antenna for the WLAN. It is built-in the cover latch	P. 2-22
⑤	GPS Antenna (option)	Serves as the antenna for the Global Positioning System (GPS). It is built-in the top cover latch.	P. 2-25
⑥	Top Cover Latch	Locks the top cover.	P. 1-4

Bottom-Side Components

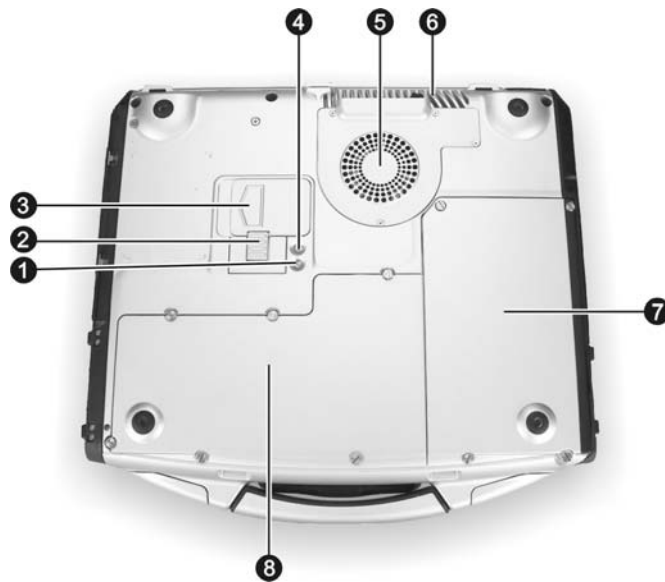











Ref	Component	Description	See Also
①	X-bay Module Antenna Connector	Serves as the interface between the system and antenna of the optional X-bay module.	
②	DVD/Combo/DVD Dual Drive Lock/Unlock Switch	Allows you to lock the DVD/Combo/DVD Dual drive in place.	P. 2-15
③	DVD/Combo/DVD Dual Drive Eject Latch	Allows you to remove the DVD/Combo/DVD Dual drive.	P. 2-15
④	GPS Antenna Connector	Serves as the interface between the system and external GPS antenna.	P. 2-25

Ref	Component	Description	See Also
⑤	CPU Socket and Sealed CPU Cooling Fan	Inside is the CPU of your computer and cooling fan to protect it from overheating.	
⑥	Ventilation Openings	Do not cover or block the ventilation openings for air circulation thus preventing overheating.	
⑦	Battery Pack	Supplies power to your computer when external power is not connected.	P. 3-3
⑧	X-bay Interface (top right)	Connects additional wireless modem (GPRS/GSM or iDEN).	
	Mini PCI Slot (bottom right)	Inside is the Mini PCI slot for using an optional Mini PCI card.	
	Hard Disk Drive Compartment (top left)	Contains the hard disk drive of your computer.	P. 2-13
	Memory Slot (bottom left)	Contains the memory slot for expanding the memory size of your computer.	P. 4-8

Top-open Components



Ref	Component	Description	See Also
①	Fingerprint Scanner	Contains the fingerprint sensor.	P. B-1
②	Keyboard	Serves as the data input device of the computer.	P. 2-4
③	Power Button	Turns the computer power ON and OFF.	P. 1-5

Ref	Component	Description	See Also
④	Device Indicators	Show the current status of the computer's devices.	
		Power on / Standby mode indicator	P. 1-3
		Hard disk drive in-use indicator	P. 2-13
		Num Lock indicator	P. 2-6
		Caps Lock indicator	P. 2-4
		Scroll Lock indicator	P. 2-4
⑤	LCD Screen	Displays the output of the computer.	P. 2-17
⑥	Light Sensor	Automatic light sensor for dimming the display's backlight. Will function only if your system comes with the optional sunlight readable transfective LCD display and/or keyboard with optional backlight function.	P. 2-17
⑦	Touchpad	Serves as the pointing device of the computer.	P. 2-9
⑧	Device Indicators	Show the current status of the computer's devices.	
		DVD/Combo/DVD Dual drive in-use indicator	P. 2-14
		Blinks amber (orange) when the battery is almost completely discharged.	P. 3-3
		Battery charge indicator – Glow green when the battery is fully charged and connected to AC power. Glow amber (orange) when the battery is being charged.	P. 3-3
		Touchpad indicator – Glow red when the touchpad is disabled. Can be enabled/disabled using the hot keys Fn+F7.	P. 2-9
		AC in and HDD heater on indicator – Glow green when the computer is connected to AC power. Blink red when the hard disk heater is on.	P. 1-5 P. 2-13

Where to Go from Here

As your computer is ready for operation, you may want to do any of the following now:

For this purpose...	Do this...
To know more about the computer...	Go on to the next chapter.
To install the operating system if your dealer has not already done so...	See the operating system manual.
To know more about the operating system...	Read the operating system manual.
To install the drivers if your dealer has not already done so...	See Chapter 6.
To set a power-on password...	See "Security Menu" in Chapter 5.
To charge the battery pack for the first time...	See "Charging the Battery Pack" in Chapter 3.

Operating Your Computer

This chapter provides information about the use of the computer.

If you are new to computers, reading this chapter will help you learn the operating basics. If you are already a computer user but are new to notebook computers, you may choose to read only the parts containing information unique to your computer.

Described in this chapter are the operating basics of these components:

- Keyboard
- Touchpad
- Touchscreen
- Hard disk drive
- DVD/Combo/DVD Dual drive

And these features:

- Starting and stopping the computer
- Video features
- Audio features
- Communication features

Starting and Stopping the Computer

There are a number of ways to start and stop the computer.

Starting the Computer

You always start the computer using the power button.

A computer starts up with an operating system (OS) existing on the storage device such as the hard disk; or from a CD if you have the respective modules installed. The computer will automatically load the OS after you turn it on. This process is called booting.

NOTE: An operating system is the platform for all your software application programs to run on. The most widely used operating system today is Microsoft Windows.

Stopping the Computer

When you finish a working session, you can stop the computer by turning off the power or leaving the computer in Standby or Hibernation mode:

To stop in this mode...	Do this...	To start up or resume again
Off	Follow the shutdown procedure of your operating system. This can prevent loss of unsaved data or damage to your software programs. If the system is locked up because of hardware or software problems, press the power button to turn off the computer.	Press the power button.
Standby	Depending on your settings in Windows, you can place the computer in Standby mode by: <ul style="list-style-type: none">• Closing the display cover• Pressing the power button	Press any key.

To stop in this mode...	Do this...	To start up or resume again
Hibernation	Depending on your settings in Windows, you can place the computer in Hibernation mode by: <ul style="list-style-type: none">• Closing the display cover.• Pressing the power button	Press the power button.

If you choose to stop in Standby or Hibernation mode, you can return to where you left off the next time you start up the computer. (See “Power Management” in Chapter 3 for more information.)

Using the Keyboard

Your keyboard has all the standard functions of a full-sized computer keyboard plus a Fn key added for specific functions.

The standard functions of the keyboard can be further divided into four major categories:

- Typewriter keys
- Cursor-control keys
- Numeric keys
- Function keys

Typewriter Keys

Typewriter keys are similar to the keys on a typewriter. Several keys are added such as the Ctrl, Alt, Esc, and lock keys for special purposes. When the lock keys (Caps Lock, Num Lk, and Scroll Lk) are pressed, their corresponding indicators light up.

The Control key is normally used in combination with other keys for program-specific functions. The Alternate key is normally used in combination with other keys for program-specific functions. The Escape key is usually used for stopping a process. Examples are exiting a program and canceling a command. The function depends on the program you are using.

Cursor-Control Keys

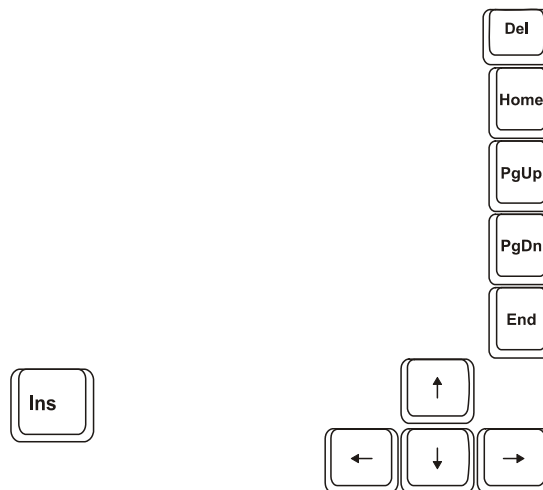

NOTE: The word "cursor" refers to the indicator on the screen that lets you know exactly where on your screen anything you type will appear. It can take the form of a vertical or horizontal line, a block, or one of many other shapes.

Numeric Keypad

A 15-key numeric keypad is embedded in the typewriter keys as shown next:

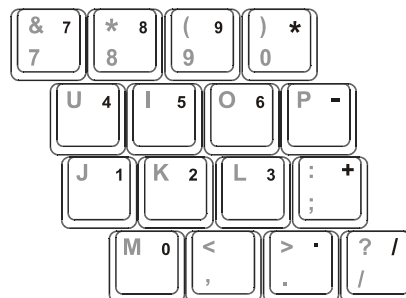

Numeric keys facilitate entering of numbers and calculations. When Num Lock is on, the numeric keys are activated; meaning you can use these keys to enter numerals.

NOTES:



- When the numeric keypad is activated and you need to type the English letter in the keypad area, you can turn Num Lock off or you can press **Fn** and then the letter without turning Num Lock off.
- Some software may not be able to use the numeric keypad on the computer. If so, use the numeric keypad on an external keyboard instead.



Euro Symbol

You can press the Euro dollar sign € on the keyboard.

- To press the Euro sign on the keyboard, hold down either of the **Alt** keys and type **0128** on the numeric keypad of your keyboard.
- To press the Euro sign on an UK keyboard, hold down the **Alt Gr** key and press **4** (which has an Euro sign on it).

Windows Keys

The keyboard has two keys that perform Windows-specific functions:  Windows Logo key and  Application key.

The  Windows Logo key opens the Start menu and performs software-specific functions when used in combination with other keys. The  Application key usually has the same effect as a right mouse click. (See your Windows manual for more information.)

Function Keys

On the top row of the keys are the function keys: F1 to F12. Function keys are multi-purpose keys that perform functions defined by individual programs.















Fn Key









The Fn key, at the lower left corner of the keyboard, is used with another key to perform the alternative function of a key. The letter “Fn” and the alternative functions are identified by the color of blue on the keytop. To perform a desired function, first press and hold Fn, then press the other key.

Hot Keys

Hot keys refer to a combination of keys that can be pressed any time to activate special functions of the computer. Most hot keys operate in a cyclic way. Each time a hot key combination is pressed, it shifts the corresponding function to the other or next choice.

You can easily identify the hot keys with the icons imprinted on the keytop. The hot keys are described next.

Key	Description
 	Switches the optional keyboard backlight function on/off with 10 levels of brightness in-between.
 	Decreases the sound volume.
 	Increases the sound volume.
 	Decreases the LCD brightness.
 	Increases the LCD brightness.
 	Switches the touchpad on and off.
 	Switches LCD off and on.

Key	Description
 	<p>Switches the display output to one of the following when an external device is connected.</p> <p>Upon booting the system with CRT:</p> <pre> graph LR A[] --> B[LCD] B --> C[LCD & CRT] C --> D[] D --> E[CRT] E --> B </pre> <p>Upon booting the system with DVI:</p> <pre> graph LR A[] --> B[LCD] B --> C[LCD & DVI] C --> D[] D --> E[DVI] E --> B </pre> <p>NOTES:</p> <ul style="list-style-type: none"> • When in full screen DOS mode, or when playing DVD or MPEG file, display switching is not allowed. • If the display mode is set to 256 colors or lower, or in DOS mode, there will be only two modes for selecting: CRT only and LCD & CRT. • This function only applies to Plug & Play CRT monitors.
 	<p>Serves as the sleep button that you can define with Windows' Power Management. (See the "Power Management" in Chapter 3.)</p>
 	<p>Switches the LCD backlight on and off.</p>
 	<p>Switches the optional GPS function on and off.</p>

Using the Touchpad

CAUTION: Do not use a sharp object such as a pen on the touchpad. Doing so may damage the touchpad surface.

NOTES:

- By default, the touchpad is disabled. Use the **Fn+F7** hot keys to enable/disable this function. The touchpad indicator found on the keyboard panel glows red when it is disabled.
- For optimal performance of the touchpad, keep your fingers and the pads clean and dry. When tapping on the pad, tap lightly. Do not use excessive force.

The touchpad is a pointing device that allows you to communicate with the computer by controlling the location of the pointer on the screen and making selection with the buttons.



The touchpad consists of a rectangular pad and four buttons. To use the touchpad, place your forefinger or thumb on the pad. The rectangular pad acts like a miniature duplicate of your display. As you slide your fingertip across the pad, the pointer (also called cursor) on the screen moves accordingly. When your finger reaches the edge of the pad, simply relocate yourself by lifting the finger and placing it on the other side of the pad.

Here are some common terms that you should know when using the touchpad:

Term	Action
Point	Move your finger on the pad until the cursor points to the selection on the screen.
Click	Press and release the left button. –or– Tap gently anywhere on the pad.
Double-click	Press and release the left button twice in quick succession. –or– Tap twice on the pad rapidly.
Drag and drop	Press and hold the left button, then move your finger until you reach your destination (drag). Finally, release the button (drop) when you finish dragging your selection to the destination. The object will drop into the new location. –or– Gently tap twice on the pad and on the second tap, keep your finger in contact with the pad. Then, move your finger across the pad to drag the selected object to your destination. When you lift your finger from the pad, the selected object will drop into place.
Scroll	To scroll is to move up and down or left and right in the working area on the screen. The scroll button located between the two buttons under the touchpad can be used to move vertically in a convenient way. Press the upper part of the scroll button to move up and the lower part of the scroll button to move down. –or– To move vertically, place your finger on the right edge of the pad and slide your finger up and down along the edge. To move horizontally, place your finger on the bottom edge of the pad and slide your finger left and right. This function works only after you install the touchpad driver supplied with the computer and it may not work for all applications.

TABLE NOTE: If you swap the left and right buttons, “tapping” on the touchpad as an alternative method of pressing the left button will no longer be valid.

Configuring the Touchpad

You may want to configure the touchpad to suit your needs. For example, if you are a left-handed user, you can swap the two buttons so that you can use the right button as the left button and vice versa. You can also change the size of the on-screen pointer, the speed of the pointer, and so on.

To configure the touchpad, you can use the standard Microsoft or IBM PS/2 driver if you are using Windows. However, you can install the touchpad driver supplied with your computer to take advantage of more powerful features. (For information on installing the driver, see “How to Use the Driver CD” in Chapter 6.)

This section needs to be looked at.

Using the Touchscreen (option)

CAUTION: Do not use a sharp object such as a ballpoint pen or pencil on the touchscreen. Doing so may damage the touchscreen surface.

The touchscreen is a touch-sensitive device that allows you to communicate with the computer by controlling the location of the pointer on the screen and making selection with the buttons.

The touchscreen allows you to easily use the computer without a mouse or touchpad.

Here are some common terms that you should know when using the touchscreen:

Term	Action
Click/Point	Tap gently on the touchscreen.
Double-click	Tap twice on the touchscreen rapidly.
Drag and drop	Press lightly on the touchscreen and move your finger until you reach your destination (drag). Finally, release your finger (drop) when you finish dragging your selection to the destination. The object will drop into the new location.
Scroll	<p>To scroll is to move up and down or left and right in the working area on the screen.</p> <p>To move vertically, place your finger on the right edge of the touchscreen and slide your finger up and down along the edge. To move horizontally, place your finger on the bottom edge of the touchscreen and slide your finger left and right.</p> <p>This function works only after you install the touchscreen driver supplied with the computer and it may not work for all applications.</p>

Using the Hard Disk Drive

Your computer comes with a hard disk drive as drive C. A hard disk drive is a storage device with non-removable, rotating, magnetic storage platters inside it. It is where your operating system and application software programs are stored.

Your hard disk drive is a 2.5-inch IDE (Integrated Drive Electronics) hard disk drive. This type of drive embodies the latest in fast, reliable mass storage by integrating all the control circuitry necessary for operation directly onto the drive itself. This allows the drive manufacturer to carefully optimize drive performance.



*AC in /
HDD heater on
indicator*

The system comes with a built-in heater that automatically turns on for low temperature operation. The AC in / HDD heater on indicator blinks red when heater is on. In low temperature environments, the user is recommended to operate the system using AC power to conserve battery life.

CAUTION:

- Make regular backups of your data files from your hard disk drive to CD discs or other storage media.
- Never try to remove or install the hard disk drive while the computer is powered on. Doing so can result in loss of data, and can damage the computer and the hard disk drive's sensitive circuitry.
- Never turn off or reset the computer while the hard disk drive in-use indicator is on.

Using the DVD/Combo/DVD Dual Drive

Depending on the model, your computer comes with a DVD, Combo, or DVD Dual drive located on the right side of the computer. This drive is usually configured as drive D.

The drive uses removable 5.25-inch silver discs, which look like standard music CDs. It is an ideal medium to use for distributing multimedia because of the huge amount of data that a disc can store.

Depending on the model, your drive is one of the following:

- **DVD drive** can read DVD (Digital Versatile Disc) discs in addition to CDs, audio CDs, CD-R, and CD-RW discs.
- **Combo drive** can work both as a DVD drive and CD-RW drive.
- **DVD Dual drive** aside from working as a Combo drive, can also write to DVD-R, DVD-RW, DVD+R, DVD+RW discs.

NOTE: If the DVD/Combo/DVD Dual drive would be operating for more than half an hour (such as showing a DVD title), use the AC power source instead of the battery. If not, the battery may run out of power before the operation is complete.

CAUTION:

1. When inserting a disc, do not use force.
2. Make sure the disc is correctly inserted into the tray, and then close the tray.
3. Do not leave the DVD tray open. Also, avoid touching the lens in the tray with your hand. If the lens becomes dirty, the drive may malfunction.
4. Do not wipe the lens using materials with rough surface (such as paper towel). Instead, use a cotton swab to gently wipe the lens.

FDA regulations require the following statement for all laser-based devices:
"Caution, Use of controls or adjustments or performance of procedures other than those specified herein may result in hazardous radiation exposure."

NOTES:

- This product incorporates copyright protection technology that is protected by method claims of certain U.S. patents and other intellectual property rights owned by Macrovision Corporation and other rights owners. Use of this copyright protection technology must be authorized by Macrovision Corporation, and is intended for home and other limited viewing uses only unless otherwise authorized by Macrovision Corporation. Reverse engineering or disassembly is prohibited.

- The DVD/Combo/DVD Dual drive is classified as a Class 1 laser product. This label is located on the DVD/Combo/DVD Dual drive.

CLASS 1 LASER PRODUCT
LASER KLASSE 1

Installing the DVD/Combo/DVD Dual Drive

To install the DVD/Combo/DVD Dual drive:

1. Insert the DVD/Combo/DVD Dual drive into the DVD drive bay located on the right side of the computer.



2. Slide the DVD drive lock/unlock switch to the lock position to secure the DVD/Combo/DVD Dual drive in place.



Inserting and Removing a Disc

Follow this procedure to insert or remove a disc.

1. Turn on the computer.
2. Press the eject button and the DVD tray will slide out partially. Gently pull on it until it is fully extended.
3. To insert a disc, place down the disc in the tray with its label facing up. Slightly press the center of the tray until it clicks into place.

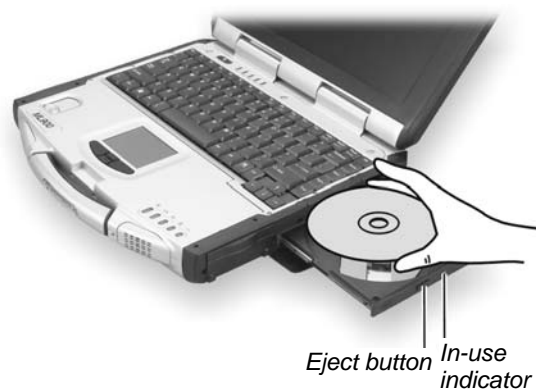

To remove a disc, hold the disc by its outer edge and lift it up from the tray.

4. Gently push the tray back into the drive.

NOTE: In the unlikely event that you are unable to release the DVD tray by pressing the eject button, you can manually release the DVD. (See "DVD/Combo/DVD Dual Drive Problems" in Chapter 8.)

Using the Video Features

The video subsystem of your computer features:

12.1-inch Display:

- 12.1-inch TFT (Thin-Film Transistor) color LCD display with 1024×768 XGA (eXtended Graphics Array) resolution
- 64 MB integrated video memory
- Simultaneous display on LCD and external monitor, which is useful when you have a presentation as you can control the screen from your computer and face the audience at the same time.
- Dual view capability, which allows you to expand your desktop on the screen to another display device so that you have more desktop space to work on.
- Power Management.
- Polarizer touchscreen function (option).

Transmissive and hi-contrast LCD display (option).

13.3-inch Display:

- 13.3-inch TFT (Thin-Film Transistor) color LCD display with 1024×768 XGA (eXtended Graphics Array) resolution
- 64 MB integrated video memory
- Simultaneous display on LCD and external monitor, which is useful when you have a presentation as you can control the screen from your computer and face the audience at the same time.
- Dual view capability, which allows you to expand your desktop on the screen to another display device so that you have more desktop space to work on.
- Power Management.
- Polarizer touchscreen function (option).

NOTES:

- Before using the dual view capability, the video driver supplied with your computer must be installed.
- System enters Standby/Hibernation mode when the LCD is closed. If you want to use the computer with the LCD closed, set *Do Nothing* to the “When I close the lid of my portable computer” option in the **Power Options** Properties. Thus the computer does not enter Standby or Hibernation mode when the LCD is closed.

Configuring the Display Modes

NOTE: To take advantage of the enhanced video capabilities, the video driver supplied with your computer must be installed.

Your computer has been set to a default resolution and number of colors before shipment. You can view and change display settings through your operating system. See your operating system documentation or online help for specific information.

For displaying in higher resolutions, you can connect an external CRT monitor that supports higher resolutions. (See “Connecting an External Monitor” in Chapter 4 for more information.)

The following table lists the display modes supported by your computer.

Display Mode		LCD Only	CRT Only	Simultaneous Display
Resolution	Colors			
800×600	16-bit	√	√	√
	32-bit	√	√	√
1024×768	16-bit	√	√	√
	32-bit	√	√	√

TABLE NOTES:

- 16-bit = High Color or 65,536 (64 K) colors; 32-bit = True Color 16,770,000 (16 M) colors.
- When using CRT only, the resolution would depend on the supported resolution by the CRT.

Using the Audio Features

NOTES:

- To take advantage of the enhanced audio capabilities, the audio driver supplied with your computer must be installed (see chapter 6 for details).
- If you experience interference while recording, try lowering the microphone recording volume.

The audio subsystem of your computer features:



- Digital audio and analog mixing functions required for recording and playing sound on your computer
- Microsoft Windows Sound System support
- A set of speakers (❶)
- External audio connectors (❷)



Ways of playing and recording sound vary with the operating system used. See your operating system documentation or online help for specific information.

Connecting Audio Devices

For higher audio quality, you can send or receive sound through external audio devices.

- **Microphone Connector** () can be connected to an external microphone for recording voice or sound.
- **Audio Output Connector** () can be connected to the line-in connector of powered speakers with built-in amplifiers, headphones, or earphone set.

NOTE: When using external speakers/headphones or microphone, you cannot use the internal one.

Using the Communication Features

Using the LAN

NOTE for Windows 2000: To take advantage of the LAN feature, the LAN driver supplied with your computer must be installed.

The internal 10/100Base-T Ethernet LAN (Local Area Network) module allows you to connect your computer to a network. It supports data transfer rate up to 100 Mbps.

To connect the network cable to the LAN module, connect one end of the LAN cable to the RJ-45 connector on the computer and the other end to the network hub.



- | | |
|------------------|---|
| Link Indicator | Glows green when the system has an available connection to LAN. |
| Active Indicator | Blinks green when the system is accessing the LAN. |



Using the Wireless LAN (option)

Depending on your model, an internal Mini PCI wireless LAN (WLAN) card may have been pre-installed by your computer manufacturer at the factory. This card allows you to access corporate networks or the Internet in a wireless environment.

The WLAN features include:

- Peer-to-Peer (Ad-Hoc) and Access Point (Infrastructure) modes support
- WEP (Wired Equivalent Privacy) 64/128-bit data encryption
- 802.11a+b+g mode

Band	Indicates the wireless band of the current connection
Supported Data rates	Rates at which the wireless adapter can send and receive data. Displays the speed in Mbps or the frequency being used. <ul style="list-style-type: none">• 802.11a-6,9,11,12,18, 24,36,48,and 54• 802.11b-1,2,5.5, and 11• 802.11g-1,2,5.5,9,11, 12,18,24,36,48,and 54
Radio Frequency	Display the frequency of the current wireless connection. <ul style="list-style-type: none">• 2.457 GHz
Channel Number	Displays the transmit and receive channel.
Network Authentication	Displays Open, Shared WPA-Enterprise, WPA-Personal modes. Displays the 802.11

	authentication used by the currently used profile. Refer to Security Setting for more information.
CCX Version	Version of the Cisco Compatible Extensions of this wireless connection.
CCX TPC	Cisco Compatible Extensions Power Levels.
CCX Power Levels	0.2 0.4,1.0,6.3,100.0 Mw.
Access Point MAC Address	The Media Access Control (MAC) address for the associated access point.
Mandatory Access Point	Displays “None” if not enabled. If enabled, the access point MAC address is displayed. This option directs the wireless adapter to connect to an access point using a specific MAC address (48-bit 12 hexadecimal digits, for example, 00:06:25:0E:9D:84).
	Close page.
	Displays the help information for this page.
Close	Close p
Help	Displays the help information for this page

To take advantage of the WLAN feature, make sure that the WLAN driver is installed correctly. (See Chapter 6 for more information.) If your

WLAN card was provided by your dealer instead of the computer manufacturer, contact your dealer for the correct driver to use.

It takes approximately 30 seconds for your computer to make a successful WLAN connection and approximately 10 seconds to disconnect.

NOTE: The FAA (Federal Aviation Agency) has deemed it unsafe to operate wireless devices in aircraft as this may interfere with flight safety. Remember to select turn off wireless LAN when using your computer in the airplane.

Connecting to a Wireless Network Need to show Intel Proset not Windows

1. Double-click the **Wireless Network Connection** icon  located on your Windows system tray. If any wireless network is detected, the following window appears on screen.

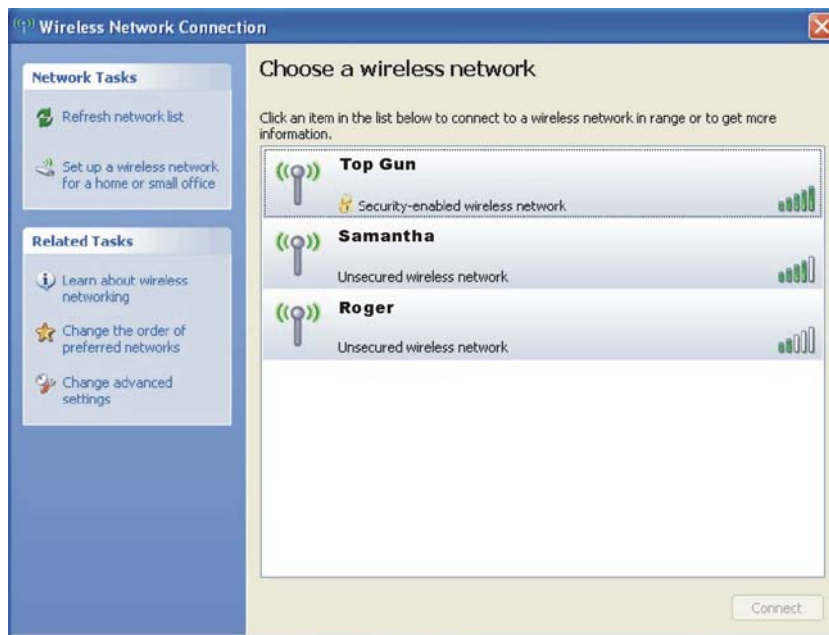

2. Select a wireless network to connect to by clicking on a selection, then click on **Connect**.

3. Depending on the settings, you may be asked to enter a WEP key (refer to your Windows online help for more information on setting a wireless network connection).

Using the Modem

NOTE: To take advantage of the modem feature, the modem driver supplied with your computer must be installed.

The internal 56 K fax/data modem allows you to use the telephone line to communicate with others by fax, email, or connect to an online service or bulletin board.

To connect the telephone line to the modem, connect one end of the modem cable to the RJ-11 connector on the computer and the other end to the phone line.



NOTES:

- When using communication software, you may have to disable power management.
- Set the COM port of the modem to COM3.
- Set parameters such as modem speed (baud rate) and line type (pulse dialing or tone dialing).
- Do not enter Standby mode when using communication software.

Using the Wireless Modem PRM240 (option)

The PRM240 is a radio modem intended for use on Motorola's Private DataTAC data communications network.

It is primarily designed to be integrated into customer equipment as an OEM modem. There are two versions available, an 800MHz version (A band) and a 900 MHz version (B band).

The modem interfaces to the equipment's controller by using the data interface port. The protocol supported over this link is a Native Control Language (NCL).

Although the modem has embedded software, it has built in application software. All application software must be separately installed and run from the device to which the modem is connected.

Features

The PRM240 Modem has the following features:

- Serial communications interference port (TTL level)
- Indicator lights shown the status of the network coverage and power supply.
- Four configurable digital Input/outputlines for external control/monitoring
- Software configurable RF calibration adjustments to suit specificnetworks
- High sensitivity reception
- Small footprint and low profile design
- Low-voltage and low standaby current consumption for battery based products
- Auto-wake up of host on incoming messages
- Roaming capabilities as used in DataTAC network
- Easy to install, service and update

FeaturesThe PRM240 modem is easily connected to many other devices and can be incorporated into a variety package formats. The modem has a TTL serial port.

Using the GPS (option)

Navigation and positioning are crucial to so many activities and yet the process has always been quite cumbersome. To try to figure out where you are and where you are going, you need GPS technology.

The Global Positioning System (GPS) is a worldwide radio-navigation system formed from a constellation of 24 satellites and their ground stations. GPS uses these "man-made stars" as reference points to calculate positions accurate to a matter of meters. In fact, with advanced forms of GPS you can make measurements to better than a centimeter! In a sense it is like giving every square meter on the planet a unique address.

Here's how GPS works in five logical steps:

- The basis of GPS is "triangulation" from satellites.
- To "triangulate," a GPS receiver measures distance using the travel time of radio signals.
- To measure travel time, GPS needs very accurate timing that it achieves with some tricks.
- Along with distance, you need to know exactly where the satellites are in space. High orbits and careful monitoring are the secret.
- Finally you must correct for any delays the signal experiences as it travels through the atmosphere.

Five broad categories of GPS application:

- Location – determining a basic position
- Navigation – getting from one location to another
- Tracking – monitoring the movement of people and things
- Mapping – creating maps of the world

Timing – bringing precise timing to the world

Using the MESH Modem (option)

Motorola's MESH networking technology enables users to wirelessly access critical broadband applications seamlessly - anytime and anywhere. Whether utilizing predeployed infrastructure or an instant, adhoc broadband network formed with other users, Motorola's MESH networking technology delivers real-time data to detect, prevent and respond. Key features of MESH include:

- Advanced Encryption Standard (AES) Support for Wi-Fi Clients
- Layer 2 Multicast Support
- Network Time Protocol (NTP) Support
- Differentiated Services using IP quality of Service (QoS) Support
- Over-the-Air Software upgrade Support
- MAC Access Control lists
- Web (HTTP) based management interface
- SNMP agent for remote management
- Firmware Upgrades via TFTP

Using the Bluetooth (option)

NOTE: To take advantage of the Bluetooth feature, the Bluetooth driver supplied with your computer must be installed.

Your computer is compliant with Bluetooth Class 1. To ensure interoperability between other devices supporting Bluetooth technology,

check with the manufacturers of other devices to determine their compatibility with your computer.

NOTES:

- There may be restrictions on using Bluetooth technology in some locations. Check with your local authorities or service provider.
- Features using Bluetooth technology, or allowing such features to run in the background while using other features, increase the demand on battery power and reduces the battery life.

Bluetooth technology enables wireless connections between electronic devices. A Bluetooth connection can be used to send files or to connect wirelessly to compatible devices using Bluetooth technology, such as cellular phones and PDAs.

Since devices using Bluetooth technology communicate using radio waves, your computer and the other devices do not need to be in direct line-of-sight. Your computer and the other device only need to be within a maximum of 10 meters of each other, although the connection can be subject to interference from obstructions such as walls or from other electronic devices.

Managing Power

Your computer operates either on external AC power or internal battery power.

This chapter tells you how you can effectively manage power. To maintain optimal battery performance, it is important that you use the battery in the proper way.

The topics in this chapter include:

- What is an AC adapter
- How to charge the battery pack
- When and how to initialize the battery pack
- How to check the battery level
- How to replace the battery pack
- What happens when the battery is low and what actions to take
- What is Power Management
- How to save power

AC Adapter

CAUTION:

- The AC adapter is designed for use with your computer only. Connecting the AC adapter to another device can damage the adapter.
- The AC power cord supplied with your computer is for use in the country where you purchased your computer. If you plan to go overseas with the computer, consult your dealer for the appropriate power cord.
- When you disconnect the AC adapter, disconnect from the electrical outlet first and then from the computer. A reverse procedure may damage the AC adapter or computer.
- When unplugging the connector, always hold the plug head. Never pull on the cord.

The AC adapter serves as a converter from AC (Alternating Current) to DC (Direct Current) power because your computer runs on DC power, but an electrical outlet usually provides AC power. It also charges the battery pack when connected to AC power.

The AC adapter operates on any voltage in the range of 100 ~ 240 V AC.

Battery Pack

The battery pack is the internal power source for the computer. It is rechargeable using the AC adapter.

The operating time of a fully charged battery pack depends on how you are using the computer. When your applications often access peripherals, you will experience a shorter operating time. In low temperature environments, the user is recommended to turn on the system using AC power

NOTE: Care and maintenance information for the battery is provided in the "Battery Pack Guidelines" section in Chapter 7.

Charging the Battery Pack

NOTES:

- Charging will not start if the battery's temperature is below -5 °C (23 °F) or above 46 °C (115 °F).
- The thermal protection of battery pack is 75 °C (167°F) for both Charge and discharger mode. In any case, once the temperature of battery pack reach to 75°C(167°F), the battery pack will cut off the output and input MOSFET immediately, the means is battery stop the charge and discharge. If this happens, the battery pack may be damaged. Please contact your dealer.
- During charging, do not disconnect the AC adapter before the battery has been fully charged; otherwise you will get a prematurely charged battery.

To charge the battery pack, connect the AC adapter to the computer and an electrical outlet. Battery status indicator () will light amber when battery is charging, and light green when battery is charged full. Battery low indicator will blink amber when battery capacity is below 10 percentages.

It takes approximately 180 minutes (3 hours) to charge the battery pack when the computer is off and 240 minutes (4 hours) to fully charge the battery pack when the computer is on.

CAUTION: After the computer has been fully recharged, do not immediately disconnect and reconnect the AC adapter to charge it again. Doing so may damage the battery.

NOTE: The battery level may automatically lessen due to the self-discharge process (0.21% per day), even when the battery pack is fully charged (100%). This happens no matter if the battery pack is installed in the computer.

Initializing the Battery Pack



You need to initialize a new battery pack before using it for the first time or when the actual operating time of a battery pack is much less than expected.

Initializing is the process of fully charging, discharging, and then charging. It can take several hours.

1. Make sure the computer power is turned off. Connect the AC adapter to fully charge the battery pack.
2. After the battery pack is fully charged, turn on the computer.
3. Disconnect the AC adapter and leave the computer on until the battery is fully discharged. The computer will shut down automatically.
4. Connect the AC adapter to fully charge the battery pack.

Checking the Battery Level

NOTE: Any battery level indication is an estimated result. The actual operating time can be different from the estimated time, depending on how you are using the computer.

You can check the approximate battery level using the battery meter function of the operating system. To read the battery level in Windows, click the  icon on the taskbar. (Click the  icon if the computer is using AC power.)

Replacing the Battery Pack

CAUTION:

- There is danger of explosion if the battery is incorrectly replaced. Replace the battery only with the computer manufacturer's optional battery packs. Discard used batteries according to the dealer's instructions.
- Do not attempt to disassemble the battery pack.

If you often rely on battery power for a long period of time while traveling, you may consider the purchase of an additional battery pack from your dealer and keep it with you in a fully charged state as a backup.

To replace the battery pack, follow these steps:

1. Make sure the computer is not turned on or connected to AC power.
2. Remove the four screws and lift the battery pack compartment cover to take it off the computer.

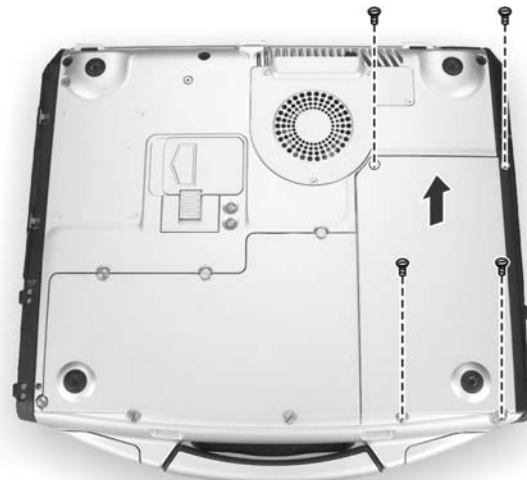

3. Pull on the ribbon and take the battery pack off the computer.
4. Insert the new battery pack into the compartment.

5. Replace the battery pack compartment cover and secure the four screws.

Battery Low Signals and Actions

Battery Low occurs when the battery has approximately 10% (Windows default setting) of its charge remaining. The computer gives warning beeps or messages and the Battery Power Indicator () blinks amber (orange) to alert you to take actions.

NOTE: You can set up your threshold and signals of Battery Low under Windows.

Immediately save your data upon Battery Low. The remaining operating time depends on how you are using the computer. If you are using the audio subsystem, hard or DVD/Combo/DVD Dual drives, the battery might run out of charge very quickly.

Always respond to Battery Low by placing your computer on Standby or Hibernation mode, turning off the computer, or connecting the AC adapter.

If you do not take any action, the computer will automatically hibernate and turn off.

CAUTION: If you fail to save your data when the battery completely runs out of charge, then you lose your data.

Power Management

Your computer supports ACPI (Advanced Configuration and Power Interface) for power management. The power management feature allows you to reduce the power consumption for energy saving.

With an ACPI-compliant operating system such as Windows 2000 and Windows XP, power supply to different computer components is controlled on an as-needed basis. This allows maximum power conservation and performance at the same time.

In general, Windows' power management works in this way:

What...	When...
Power to the hard disk is turned off	When the hard disk has been idle for a set period.
Power to the display is turned off	When the display has been idle for a set period.
The computer enters Standby mode. The hard disk and display are turned off and the entire system consumes less power.	When the entire system has been idle for a set period.
	When you press Fn+F10. *
	When you close the cover. *
The computer enters Hibernation mode. (See the next subsection for more information.)	When you press the power button. *
	When you press Fn+F10. *
	When you close the cover. *

* depends on your settings in Windows.

For detailed information on power management, see Windows' Help.

Hibernation

Hibernation is a very useful feature. People frequently open many applications when they use computers. It takes some time to get all these applications open and running, and normally they all have to be closed before the system can be turned off.

When you use the hibernation feature, you do not have to close the applications. The computer stores the state of your computer to a file on the hard disk and then shut down. The next time you turn on your computer, you return to exactly where you left off.

Power-Saving Tips

In addition to your computer's automatic power management, you can do your part to maximize the battery's operating time by following these suggestions.

- Do not disable Power Management.
- Decrease the LCD brightness to the lowest comfortable level.
- Disable the serial port if no device is connected to this port. (See "Advanced Menu" in Chapter 5.)
- If you work with an application that uses the serial port or features wireless connectivity (LAN/WLAN/modem/GPS/Bluetooth), exit the application when you finish using it.
- Turn off the computer when you are not using it.



Expanding Your Computer

You can expand the capabilities of your computer by connecting other peripheral devices. When using a device, be sure to read the instructions accompanying the device together with the relevant section in this chapter.

This chapter gives guidelines on installing and using these devices:

- External monitor
- USB device
- Serial device
- IR device
- Video capture device

Connecting an External Monitor

If you want the benefits of a larger display screen with higher resolution, you can connect an external CRT monitor that supports the DVI interface to your computer.

Follow this procedure to connect an external monitor:

1. Make sure that the computer is not turned on.
2. Plug the monitor's signal connector to the computer's DVI-I port.

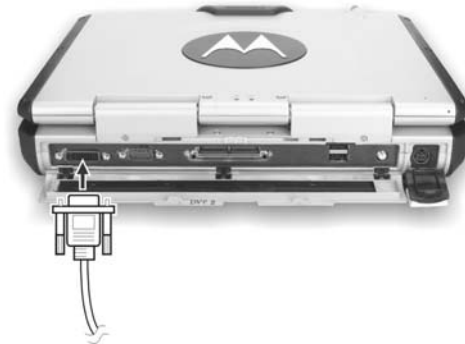

3. Plug one end of the monitor's power cord into the power socket on the monitor and the other end to an electrical outlet.
4. To use the monitor, turn on the monitor before turning on the computer.
5. The monitor should respond by default. If not, you can switch the display to the monitor or to both (simultaneous display), or to multi-display by pressing Fn+F9. In Windows, you can also change the display through the settings in **Display Properties**.
6. You can change display settings through your operating system. See your operating system documentation or online help for specific information.

CAUTION: Do not disconnect the external monitor while the computer is in Standby mode or Hibernation mode. If no external monitor is connected when the computer resumes, the LCD remains blank and the output is not displayed.

Connecting a USB Device

Your computer has two USB ports that supports transfer rates up to 12 MB/s for USB 1.1 devices and 480 MB/s for USB 2.0 devices, such as digital camera, scanner, printer, modem, and mouse.

USB is specified to be an industry standard extension to the PC architecture. It supports “Plug-and-Play” technology so you can install and remove USB devices without turning off the computer. With its multiple connection capability, up to 127 devices can be connected in a daisy-chain configuration. In addition, you can use a USB hub that converts a single USB connector into multiple ports where USB devices can be connected.

To connect a USB device, simply plug the device cable into one of the USB ports with the USB “converging arrows” symbol facing up.



Connecting a Serial Device

Your computer has a serial port for connecting a serial device such as an external modem.

Follow this procedure to connect a serial device:

1. Make sure the “COM1 Settings” item is set properly in the SCU program. (See “Advanced Menu” in Chapter 5 for information.)
2. Plug the device cable to the serial port on the rear of the computer.
3. Turn on the computer.



NOTE: Portable modems that derive power through the serial port cannot be used with the computer. Instead, use a modem that is powered by its own internal battery or external AC power.

Connecting an IR Device

Your computer has an IR (infrared) port for connecting an infrared-equipped device wirelessly such as another computer, printer, or PDA (Personal Digital Assistant).

Follow this procedure to connect an IR device:

1. Under Windows, make sure that the IrDA Fast Infrared Port is set to HP HSDL-2300/3600.
2. Make sure that the “COM Ports” and its “COM2 (FIR) Settings” items are set properly in the SCU program. (See “Advanced Menu” in Chapter 5 for information.)
3. When using the IR port:
Place the transmitting device where its IR port faces the IR port of your computer within the effective range – within ± 20 -degrees vertical angle and within ± 20 -degrees horizontal angle at no greater than 0.8~1.0 meter distance.
Place the receiving device where the IR port of your computer faces its IR port within the effective range – within ± 15 -degrees vertical angle and within ± 15 -degrees horizontal angle at no greater than 0.8~1.0 meter distance.
4. To take advantage of IR communications, you need a third party software.

NOTES: During infrared communication, take note of the following:

- Do not move the computer and IR device.
- Do not enter Standby mode.
- Do not use a cell phone or another IR device near the computer.
- Avoid strong light such as sunlight or fluorescent light.
- Disable the screen saver.



Connecting a Video Capture Device

NOTE: To take advantage of the AV input port, the Video Capture driver supplied with your computer must be installed (see chapter 6 for details).

Your computer has an AV input port on the rear of the computer for connecting a video capture device such as high-quality CCD, as well as consumer electronic equipment such as DVCAM and VCR.

To connect a video capturing device, simply plug the device cable to the AV input port (conexant 878A PCI; BNC-type) of the system.



System Memory Upgrade

You can upgrade your computer by changing system memory to a maximum of 2 GB on the two 200-pin DDR SO-DIMM slots. However, to avoid damage during the installation procedure, please ask your dealer for help.

Setup Configuration Utility (SCU)

SCU is a program for configuring the BIOS (Basic Input/Output System) settings of the computer.

BIOS is a layer of software, called firmware, that translates instructions from other layers of software into instructions that the computer hardware can understand. The BIOS settings are needed by your computer to identify the types of installed devices and establish special features.

This chapter tells you how to use the SCU program.

When and How to Use the SCU Program

When to Use

You need to run the SCU program when:

- You see an error message on the screen requesting you to run Setup.
- You want to restore the factory default settings.
- You want to modify some specific settings according to the hardware.
- You want to modify some specific settings to optimize system performance.

Starting SCU

NOTES:

- The Setup screens shown in this chapter are for your reference only. The actual items or settings on your computer may differ.
- The Setup program may have been updated after the publication of this manual.
- The settings you select in your operating system might override similar settings in Setup.

To run SCU, press F2 when the prompt appears in the lower left corner of the screen during system startup. The prompt shows up on the screen for only a few seconds. You must press F2 quickly. The SCU menu appears as shown next.

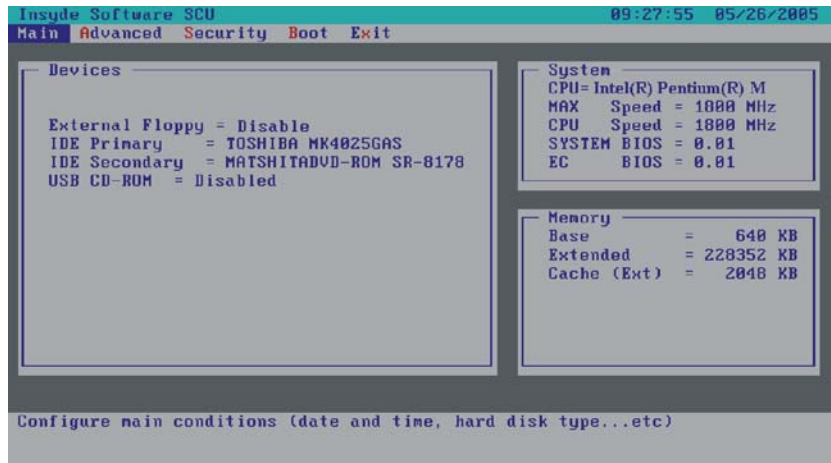

Moving Around and Making Selections

A brief description of keyboard usage is listed next:

Key	Function
←, →	Selects a menu title.
↑, ↓	1) Selects an item or option. 2) Brings up/down the value.
Enter	1) Brings up the sub-menu when available. 2) Opens or closes the options window when an item is selected.
Tab	Jumps from one item to another.
Esc	1) Exits the SCU program. 2) Returns to the previous menu if in a sub-menu. 3) Closes the options window if one is open.

Main Menu

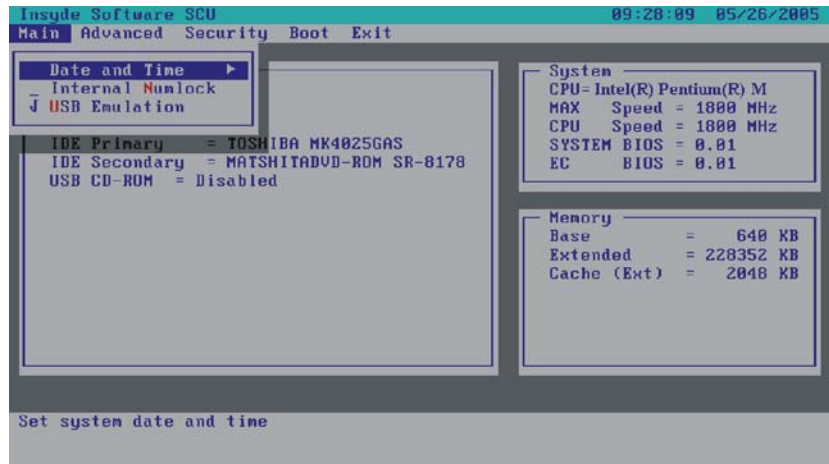

Date and Time

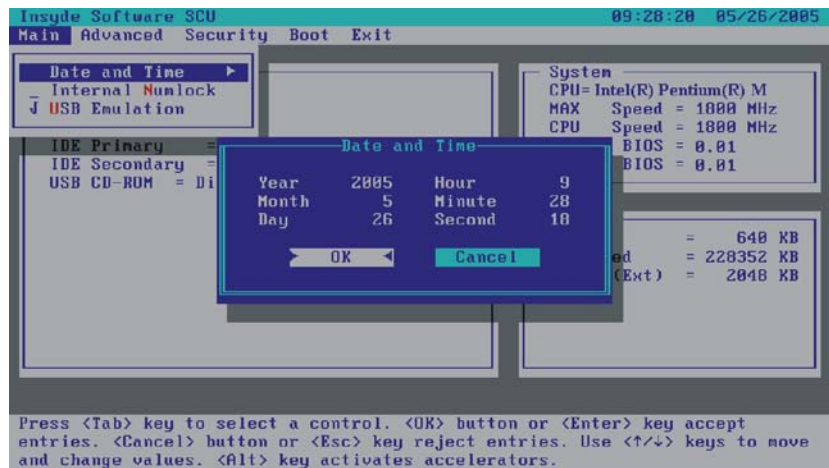

Sets the system time (Hour, Minute, Second) and date (Month, Day, Year).

Internal Numlock

Sets if you can enter a number when Num Lock is turned off. When this item is enabled, you can press and hold Fn, and then press a letter key to enter a number even if Num Lock is turned off. When this item is disabled, you cannot enter a number with the above method. A check mark (✓) indicates enabled while underline (⏟) indicates disabled. Default setting is enabled.

USB Emulation

Enables or disables the system's support for the USB port in DOS mode. A check mark (✓) indicates enabled while underline (⏟) indicates disabled. Default setting is enabled.

Advanced Menu

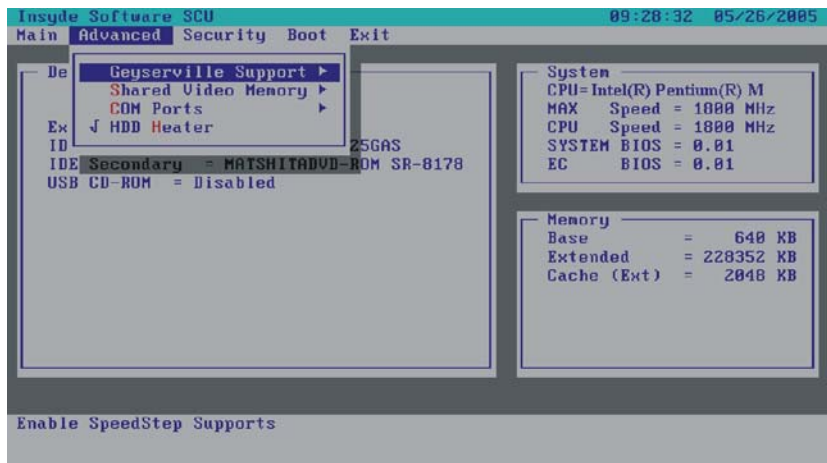

Geyserville Support

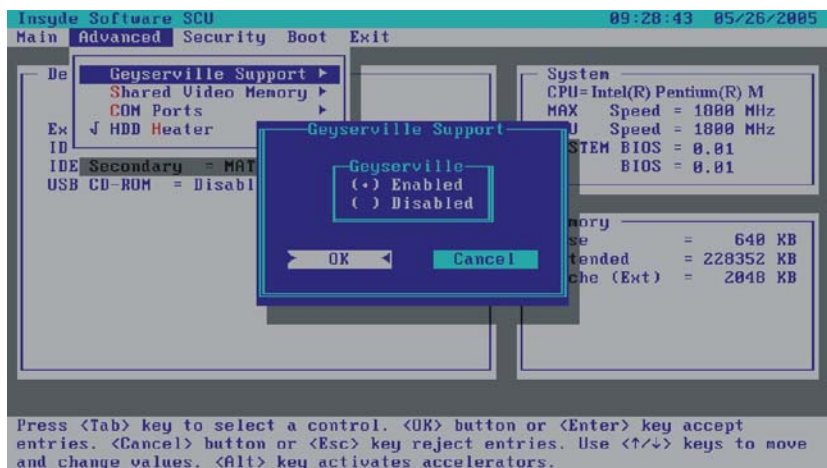

Enables or disables the Geyserville feature of the CPU. The Geyserville feature helps conserve battery life by decreasing the CPU's running speed under certain conditions while still maintaining a high performance. If this item is enabled, the CPU will automatically change its speed whenever necessary based on the "Power Scheme" setting in Windows' Control Panel. If this item is disabled, the CPU will always run in the lowest speed. The options are *Enabled* and *Disabled*. The default setting is *Enabled*.

| NOTE: This item is available only when the CPU supports the Geyserville feature.

Shared Video Memory

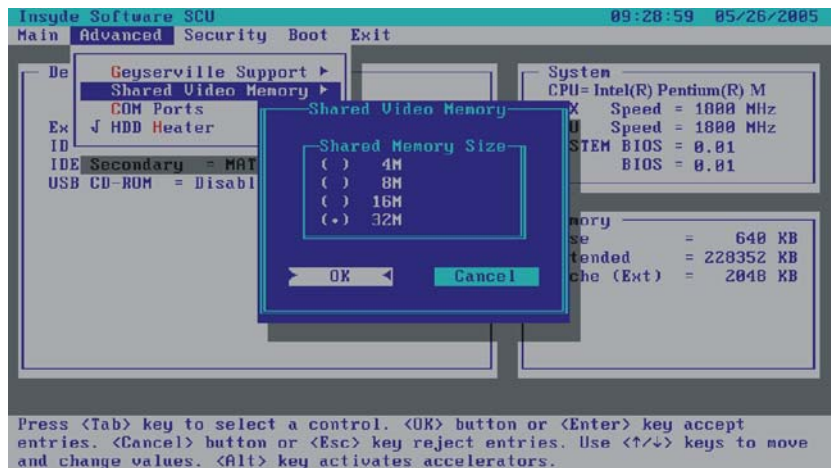

Sets the shared memory size of the video controller. The options are *4M*, *8M*, *16M*, and *32M*. Default setting is *32M*.

COM Ports



Allows you to configure the COM ports of the computer.

COM1 / 2 (FIR) / 3 / 5 / 6 Settings sets the I/O (Input/Output) address and the Interrupt ReQuest line (IRQ) settings of the COM ports. The options are *Disabled*; *COM1, 3F8, IRQ4*; *COM2, 2F8, IRQ3*; *COM3, 3E8, IRQ6*; *COM5, 3E0, IRQ5*; *COM6, 2E0, IRQ10*.

HDD Heater

Sets if the system automatically turns on the built-in hard disk drive heater for low temperature operation. A check mark (✓) indicates enabled, while underline (⎵) indicates disabled.

NOTES:

- To use the HDD heater feature, the MTCCTRL driver supplied with your computer must be installed (see chapter 6 for details).
- Disable this item to conserve energy when using battery power.

Security Menu

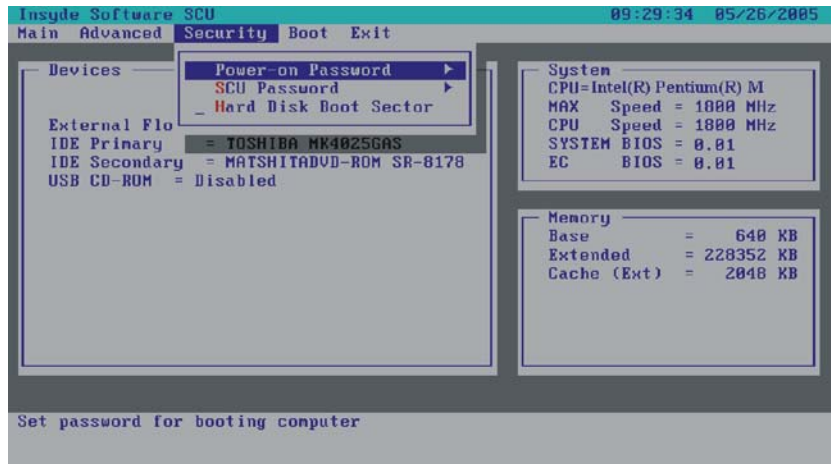

Power-on Password

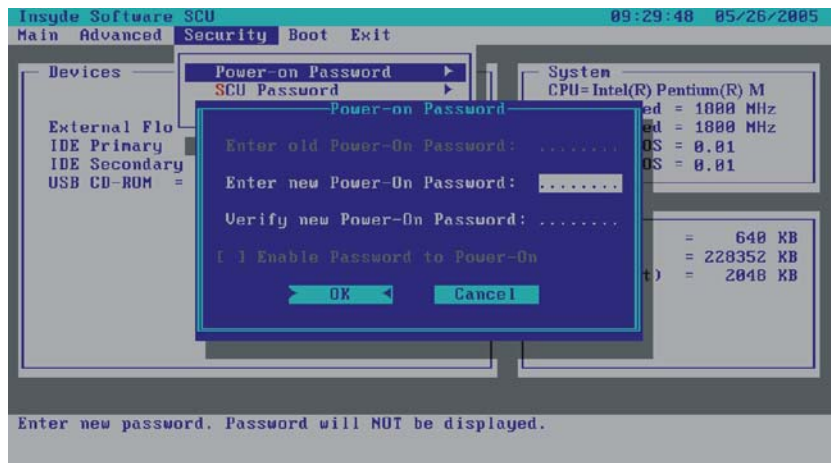

Allows you to set the password for your system. When typing the password, first make sure that Num Lock is off, then type your password in the entry fields and press Enter. Confirm your password by typing it again and pressing Enter. If the **Enable Password to Power-on** sub-item is enabled, the set password is always required to boot the computer.

SCU Password

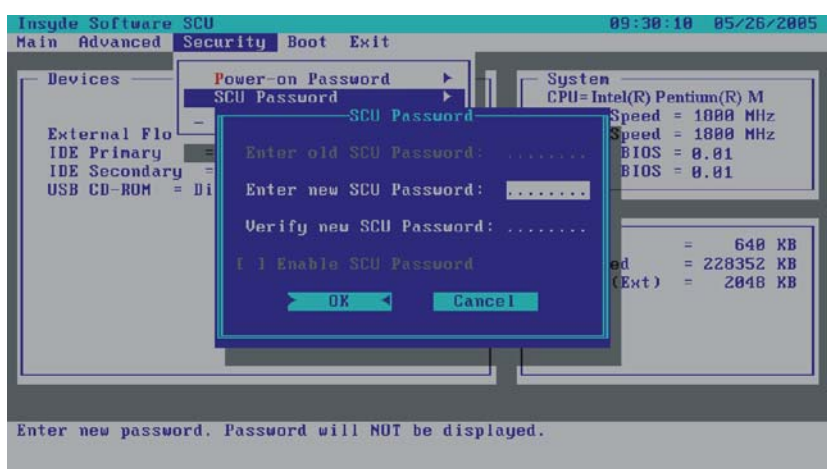

Allows you to set the password for entering SCU Setup. When typing the password, first make sure that Num Lock is off, then type your password in the entry fields and press Enter. Confirm your password by typing it again and pressing Enter. If the **Enable SCU Password** sub-item is enabled, the SCU password is always required to enter SCU Setup.

Hard Disk Boot Sector

Sets if a warning message will appear when the hard disk boot sector (partition table) has been changed. A checkmark (✓) indicates enabled, while an underline () indicates disabled. The default setting is disabled.

CAUTION: Set this item to disabled before installing an operating system, running Fdisk or Format program. Otherwise, the intended action will fail.

Boot Menu



Boot Sequence

Sets the first, second, third, and fourth booting device. The system will try to boot from the first device but if it is not available, will try the next boot device. If you set the first boot device to *LAN Boot*, the system will boot from the LAN server first. The options are *Hard Disk Drive*, *CD-ROM Drive*, *Floppy Disk Drive*, and *LAN Boot*. The default setting is *Floppy Disk Drive*, *Hard Disk Drive*, *CD-ROM Drive*, then *LAN Boot*.

NOTE: If you set all booting options to the same device, then the computer will try to boot from that device only.

Exit Menu

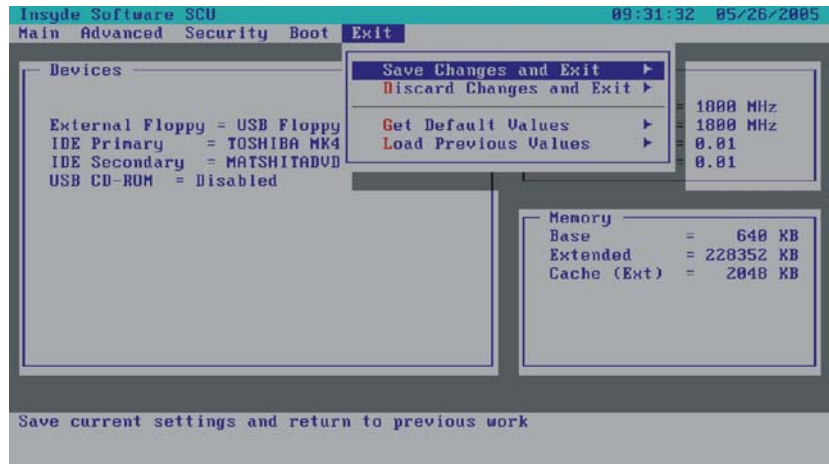

Save Changes and Exit

Saves the changes you have made and exit the SCU program.

Discard Changes and Exit

Exits the SCU program without saving the changes you have made.

Get Default Values

Loads factory default values for all the items.

Load Previous Values

Restores previous values for all the items.

Installing Software Drivers

To take full advantage of the unique features of your computer, some operating systems require custom software, known as drivers, to be installed.

If you purchased the computer with Windows pre-installed, your dealer may have already installed the drivers. If not, you need to install the drivers using the driver CD supplied with your computer.

This chapter describes how to install the drivers.

How to Use the Driver CD

NOTES:

- The drivers may have been updated after this manual was published. For driver upgrade, please contact your dealer.
- You can always find `README` or document files on the driver CD. These files contain the latest information from the software supplier. Please read the files together with this chapter.
- This driver CD supports Windows 2000 and Windows XP only.
- The available items may differ according to your computer model and operation system.

An autorun program is provided on the driver CD to help you easily install the drivers. As you insert the driver CD, the autorun program automatically starts. If you need to start the program manually, run the **Autorun.exe** program from the Setup directory of the driver CD.

The main screen appears as shown next:



Drivers on the First Page

To install the necessary driver, just click on the particular option and follow the onscreen instructions to continue and complete installation.

<i>Device Driver</i>	Installs the device drivers (chipset, VGA, LAN, audio, modem, etc.).
<i>Video Capture</i>	Shows you the instructions on installing the driver that allows you to connect a video capture device through the AV input port.
<i>Fingerprint</i>	Shows you the instructions on installing the driver that allows you to use the fingerprint recognition system and its application software.
<i>Bluetooth</i>	Allows you to connect to Bluetooth-compliant devices.
<i>Touchpad</i>	Allows you to take full advantage of the touchpad and the scroll button features.
<i>Browse CD</i>	Allows you to view the Operation Manual on screen. Browses the contents of this CD.

Upon clicking “Next Page,” the following screen appears:

Drivers on the Second Page



IrDA	Connects an IrDA-compliant device for wireless data transfer
<i>PROSet</i>	Installs the WLAN Utility that allows your system to connect wirelessly to the Internet.
<i>SpeedStep</i>	Allows you to use the SpeedStep function of the computer (for Windows 2000 only).
<i>USB-to-LAN</i>	Allows you to use the network function of the computer when the optional docking station is connected.
<i>MotoCtrl</i>	Installs the Motorola proprietary control utility
PCMCIA	Installs the PCMCIA driver that allows you to use the pc card slot to access optional PC cards.
XBayCtrl	Installs the X-bay control utility.

Drivers on the Three Page

TouchScreen

Click on the TouchScreen button to install touch screen driver.

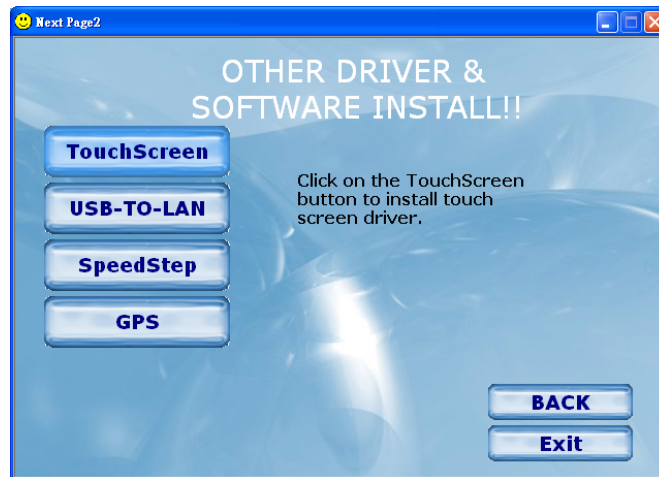

GPS

Click on the GPS button to on installing the GPS DRIVER..

Install Touch Screen Driver for Windows 2000, Windows XP

1. After the system has finished rebooting, click on the “PenMount Monitor icon located on the taskbar to bring up the “PenMount Control Panel.”
2. Select the “Standard Calibration” folder and click on “OK” button.

When the “PENMOUNT Control Panel” dialog box appears, click on the “Calibrate” folder and click on the “Standard Calibration” button.

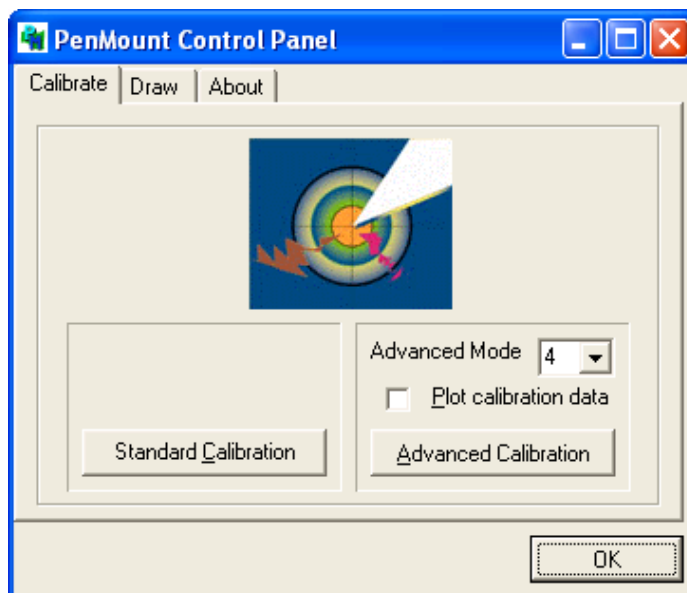

3. If you need 4,9,16,25 dot of the calibrate, we suggest select “Advanced Calibration” button to calibrate.
4. Click on the four sides (points) and the plus-sign “+” on the screen to calibrate your “PENMOUNT” pen for use on the computer.

NOTE

1. If you play game with CRT or DVI monitor, please select “Twin” to display the screen.



2. When you use Windows Media Player to play a video file, the screen may flash in a very short time. This behavior can occur if there are problems with video. To resolve the issue, you could set the configuration in Windows Media Player, use the following steps:

Step 1. In Windows Media Player, SELECT [Tools] -> [Options...]

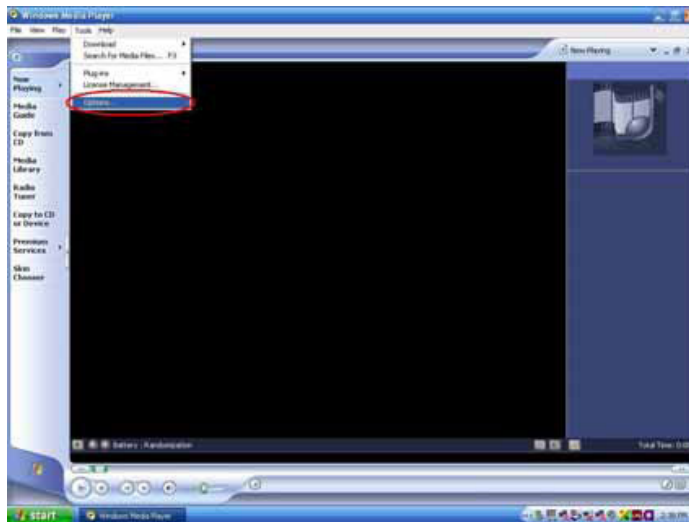

Step 2. SELECT [Performance] -> Click [Advanced...]

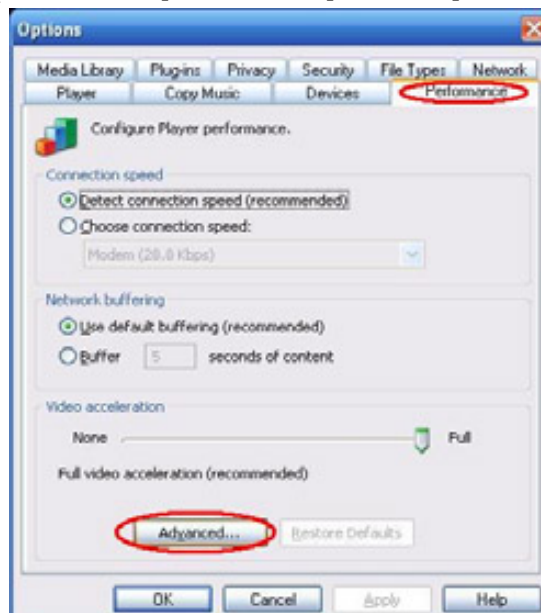

3. CANCEL [Use overlays]->Click [OK].

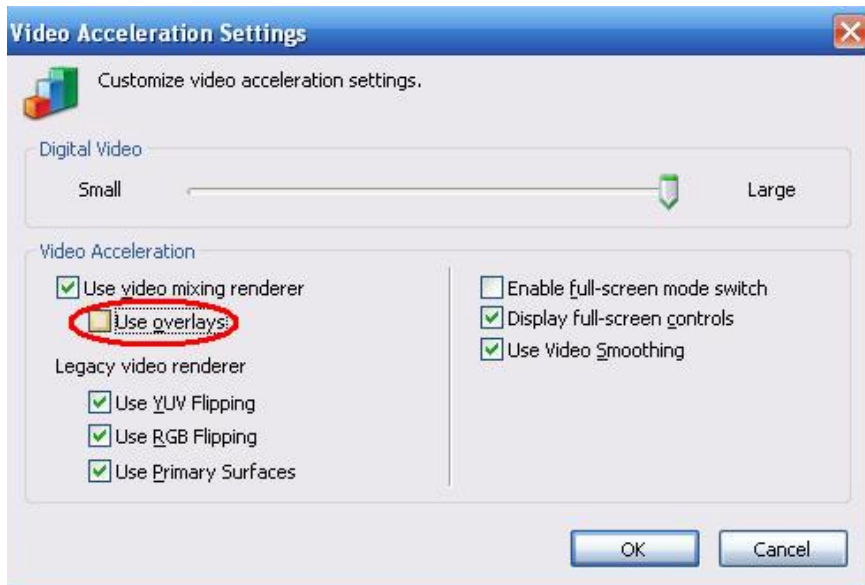

Step 4. Close the Windows Media Player, and then restart the Windows Media Player.

1. Panel Calibration

Standard Calibration

The Standard Calibration function lets you match the touch screen to your display so that the point you touch is accurately tracked on screen. Standard calibration only requires four points for calibration and one point for confirmation. Under normal circumstances Standard Calibration is all you need to perform an accurate calibration.

Advanced Calibration

The Advanced Calibration function improves the accuracy of calibration by using more involved engineering calculations. Use this function only if you have tried the Standard Calibration and there is still a discrepancy in the way the touch screen maps to the display. You can choose 4, 9, 16 or 25 points to calibrate, though we suggest that you first try 9 points, if it is still not tracking well then try 16 or 25 points. The more points you use for calibration, the

greater the accuracy. Errors in calibration may occur due to viewing angle, or individual skill, and there may be little difference in using 16 or 25 points. Note that a stylus is recommended for the most accurate results.

If there is distortion problem in your touch panel, please use the Advance Calibration function.

Standard Calibration is basic calibration function and cannot correct touch panel distortion problems.

Advance Calibration improves touch panel distortions due to its high precision technology.

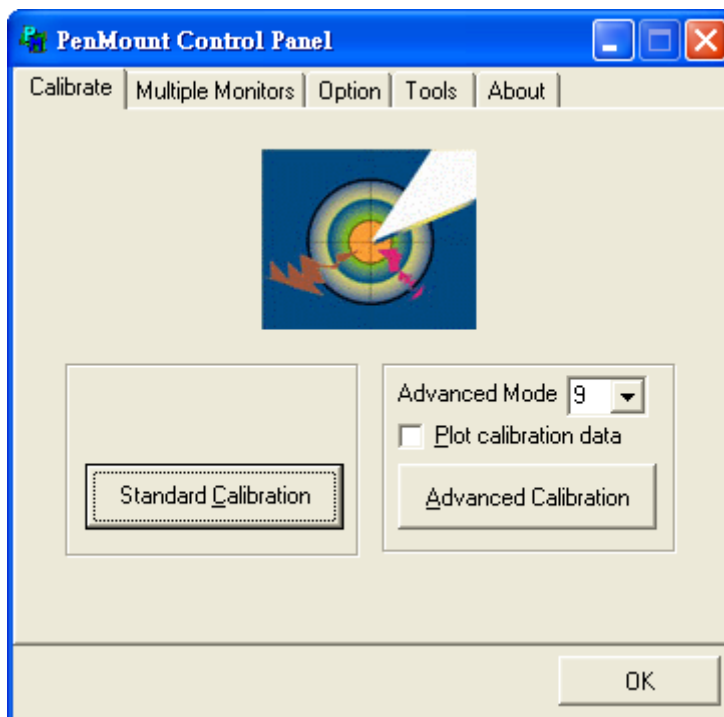

2. Please cancel the function “Automatic Rotation Detection”. (See Fig1)

Because use the function key “Fn + F9 “(CRT/LCD/Simulscan toggle) system standard will appear a calibration screen. (See Fig2)

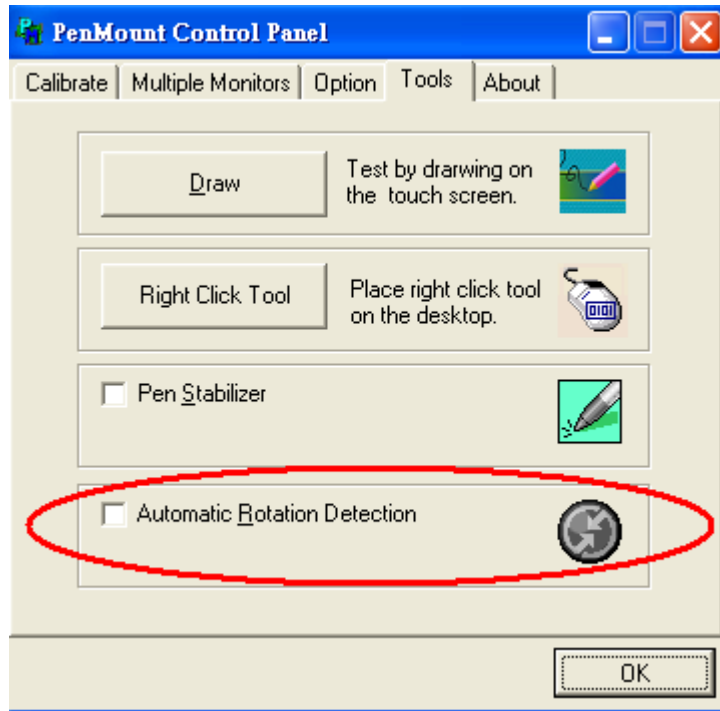

Fig1



3. If the Graphics Controller setting “Extended Desktop” and Primary Device is Monitor , the Touch Screen setting you need to select “Multiple Monitor Support” → Map Touch Screens. (See Fig1)

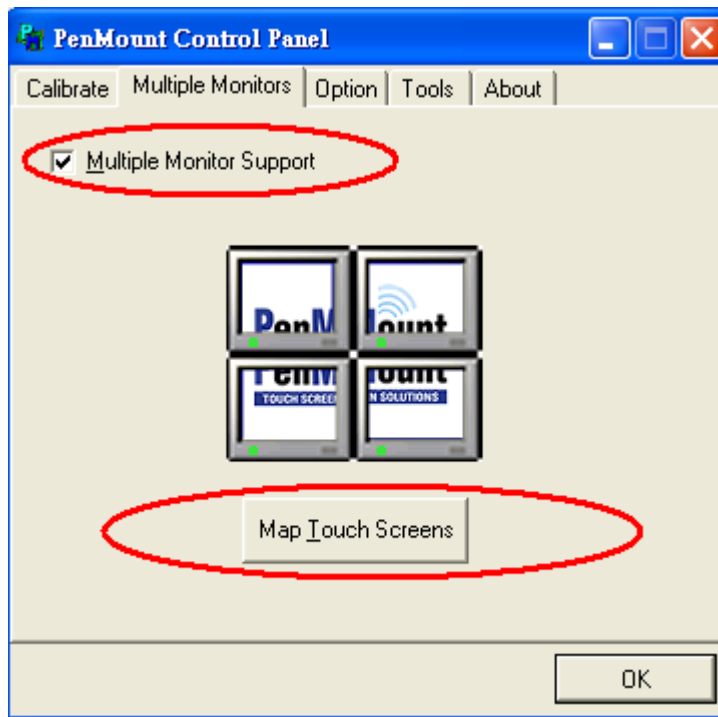

Fig1

PS. If your O.S. shutdown and docking un-dock and then enter system, please re- Calibration your panel.

1. Panel Calibration

Standard Calibration

The Standard Calibration function lets you match the touch screen to your display so that the point you touch is accurately tracked on screen. Standard calibration only requires four points for calibration and one point for confirmation. Under normal circumstances Standard Calibration is all you need to perform an accurate calibration.

Advanced Calibration

The Advanced Calibration function improves the accuracy of calibration by using more involved engineering calculations. Use this function only if you have tried the Standard Calibration and there is still a discrepancy in the way the touch screen maps to the display. You can choose 4, 9, 16 or 25 points to calibrate, though we suggest that you first try 9 points, if it is still not tracking well then try 16 or 25 points. The more points you use for calibration, the greater the accuracy. Errors in calibration may occur due to viewing angle, or individual skill, and there may be little difference in using 16 or 25 points. Note that a stylus is recommended for the most accurate results.

If there is distortion problem in your touch panel, please use the Advance Calibration function.

Standard Calibration is basic calibration function and cannot correct touch panel distortion problems.

Advance Calibration improves touch panel distortions due to its high precision technology.

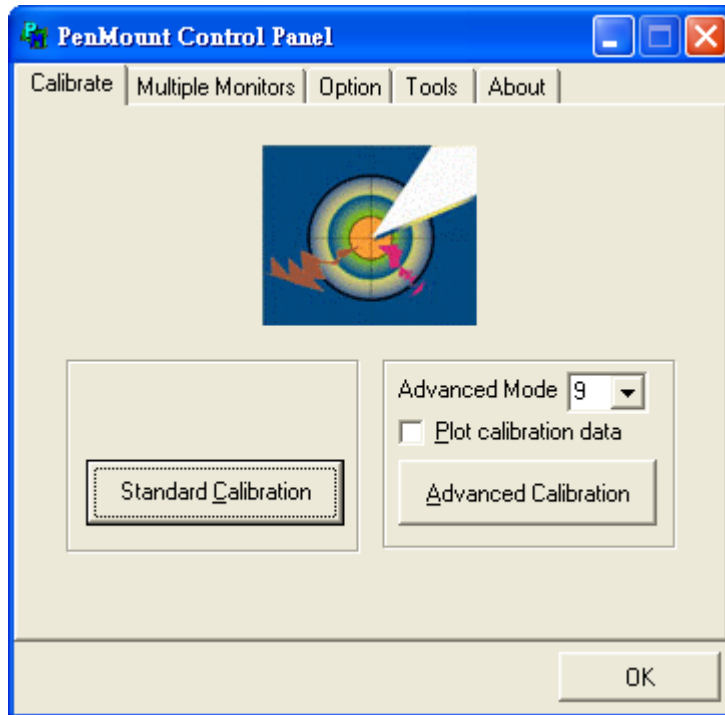

2. Please cancel the function “Automatic Rotation Detection”. (See Fig1)

Because use the function key “Fn + F9 “(CRT/LCD/Simulscan toggle)
system standard will appear a calibration screen. (See Fig2)

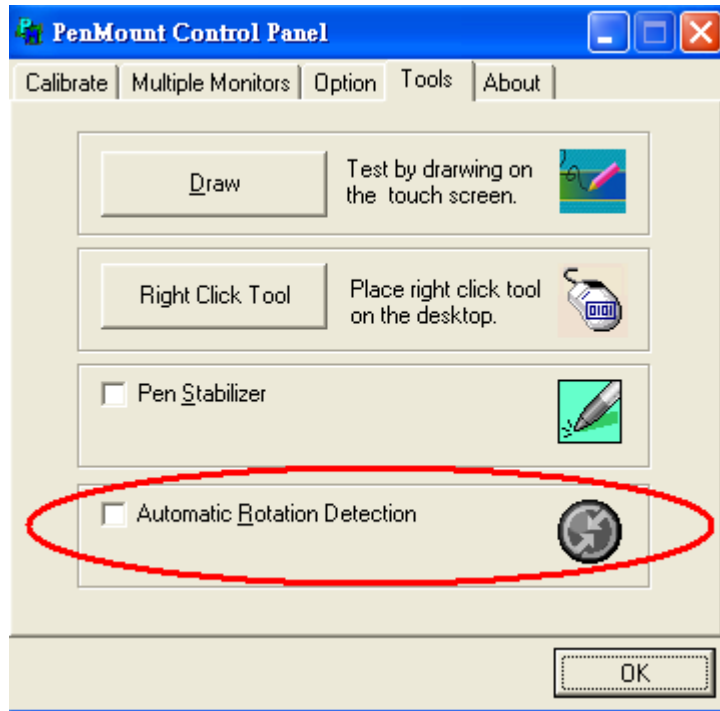

Fig1



Fig2

3. If the Graphics Controller setting “Extended Desktop” and Primary Device is Monitor , the Touch Screen setting you need to select “Multiple Monitor Support” → Map Touch Screens. (See Fig1)

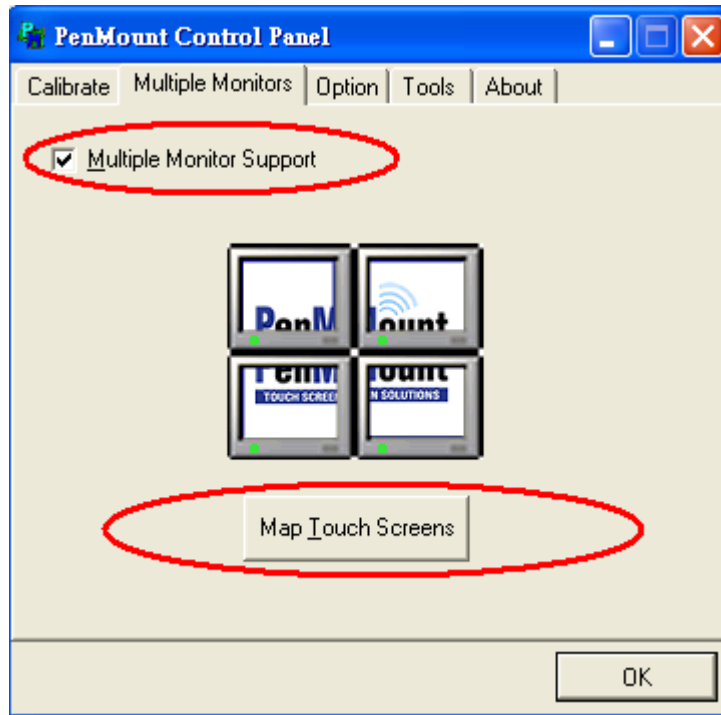

Fig1

PS. If your O.S. shutdown and docking un-dock and then enter system, please re- Calibration your panel.





Caring for the Computer

Taking good care of your computer will ensure a trouble-free operation and reduce the risk of damage to your computer.

This chapter gives you guidelines covering these areas of maintenance:

- How to protect the computer
- What to note when using and storing the computer
- How to clean the computer
- What to note when using the battery pack
- What to note when traveling with the computer

Protecting the Computer

To safeguard the integrity of your computer data as well as the computer itself, you can protect the computer in several ways as described in this section.

Using the Password

The power-on password protects your computer against unauthorized use. If the password is set, the prompt requesting for the password appears on the screen whenever the computer is turned on.

The password is set via the SCU program. See “Security Menu” in Chapter 5 for instructions.

Using an Anti-Virus Strategy

New viruses are always being developed nowadays and they are attacking computers even more easily with emails so commonly used worldwide.

The Security feature of the SCU program protects the boot sector of the hard disk. To enable the function, see “Security Menu” in Chapter 5 for instructions.

You can also install a virus-detecting program to monitor potential viruses that could damage your files.

Taking Care of the Computer

Location Guidelines

- Use the computer where the temperature is between 0 °C (32 °F) and 50 °C (122 °F).
- Avoid placing the computer in a location subject to high humidity, extreme temperatures, mechanical vibration, direct sunlight, or heavy dust.
- Do not cover or block any ventilation openings on the computer. For example, do not place the computer on a bed, sofa, rug, or other similar surface. Otherwise, overheating may occur which may result in damage to the computer.
- Keep the computer at least 13 cm (5 inches) away from electrical appliances that can generate a strong magnetic field such as a TV, refrigerator, motor, or a large audio speaker.
- Do not move the computer abruptly from a cold to a warm place. A temperature difference of more than 10 °C (18 °F) will cause condensation inside the unit, which may damage the storage media.
- Do not place the computer on an unsteady surface.

General Guidelines

- Do not place heavy objects on top of the computer as this may damage the display.
- The screen surface is easily scratched. Do not use paper towels to clean the display. Avoid touching it with a ballpoint pen or pencil.
- To maximize the life of the backlight in the display, allow the backlight to automatically turn off as a result of power management. Avoid using a screen saver or other software that prevents the power management from working.

Cleaning Guidelines

- Never clean the computer with its power on.
- Use a soft cloth moistened with water or a non-alkaline detergent to wipe the exterior of the computer.
- Gently wipe the display with a soft, lint-free cloth. Do not use alcohol or detergent on the display.
- Dust on the IR/Bluetooth port can interfere with data transfer. Wipe the port with a soft, dry cloth.
- Dust or grease on the touchscreen can affect its sensitivity. Clean the touchscreen by using adhesive tape to remove the dust and grease on its surface.

Battery Pack Guidelines

- Recharge the battery pack when it is nearly discharged. When recharging, make sure the battery pack is fully charged. Doing so may avoid harm to the battery pack.
- Operate the computer with the battery pack installed even when using external power. This ensures that the battery is fully charged.
- If you will not be using the computer for a long period of time (more than two weeks), remove the battery pack from the computer.
- If you remove the battery pack, make sure the battery terminals do not contact any conductors such as metal objects or water. Otherwise, the battery may become unusable as a result of a short circuit.
- If you need to store the battery pack, store it in a cool, dry place. Never allow the temperature to exceed 70 °C (158 °F).
- Do not leave the battery pack in storage for more than 3 months without recharging it.

When Traveling

- Before traveling with your computer, make a backup of your hard disk data into optical discs or other storage devices. As an added precaution, bring along an extra copy of your important data.
- Make sure the battery pack is fully charged.
- Make sure the computer is turned off.
- Do not leave objects that will press onto the display.
- Disconnect the AC adapter from the computer and take it with you. Use the AC adapter as the power source and as a battery-charger.
- Hand-carry the computer. Do not check it in as luggage.
- Allow extra time for airport security. Many airports inspect electronic devices carefully.
- When going through airport security, it is recommended that you send the computer and USB disks through the X-ray machine (the device you set your bags on). Avoid the magnetic detector (the device you walk through) or the magnetic wand (the hand-held device used by security personnel).
- If you plan to travel abroad with your computer, consult your dealer for the appropriate AC power cord for use in your country of destination.



Troubleshooting

Hardware, software, or a combination of both can cause computer problems. When you encounter any problem, it might be a typical problem that can easily be solved.

This chapter tells you what actions to take when solving common computer problems. It is divided into three sections:

- Preliminary checklist
- Solving common problems
- Resetting the computer

Preliminary Checklist

Here are helpful hints to follow before you take further actions when you encounter any problem:

- Try to isolate which part of the computer is causing the problem.
- Make sure that you turn on all peripheral devices before turning on the computer.
- If an external device has a problem, make sure that the cable connections are correct and secure.
- Make sure that the configuration information is properly set in the SCU program.
- Make sure that all the device drivers are correctly installed.
- Make notes of your observations. Are there any messages on the screen? Do any indicators light? Do you hear any beeps? Detailed descriptions are useful to the service personnel when you need to consult one for assistance.

If any problem persists after you follow the instructions in this chapter, contact an authorized dealer for help.

Solving Common Problems

For easy reference, the problems are divided into these categories.

Problem Type	Go to
Battery Problems	P. 8-4
Bluetooth Problems	P. 8-4
DVD Drive Problems	P. 8-4
Display Problems	P. 8-5
Fingerprint Recognition Problems	P. 8-7
Hardware Device Problems	P. 8-7
Hard Disk Drive Problems	P. 8-8-7
Infrared Problems	P. 8-8
Keyboard, Mouse and Touchpad Problems	P. 8-9-8
LAN Problems	P. 8-9
WLAN Problems	P. 8-10-9
Modem Problems	P. 8-10-9
Power Management Problems	P. 8-12-11
Software Problems	P. 8-12
Sound Problems	P. 8-13
Startup Problems	P. 8-13-14
Other Problems	P. 8-14-15

Battery Problems

The battery does not charge (Battery Charge indicator does not light amber).

- Make sure that the AC adapter is properly connected.
- Make sure that the battery is not too hot or cold. Allow time for the battery pack to return to room temperature.
- Make sure that the battery pack is installed correctly.
- Make sure that the battery terminals are clean.

The operating time of a fully charged battery becomes shorter.

- If you often partially recharge and discharge, the battery might not be charged to its full potential. Initialize the battery to solve the problem. (See “Initializing the Battery Pack” in Chapter 3 for instructions.)

The battery operating time indicated by the battery meter does not match the actual operating time.

- The actual operating time can be different from the estimated time, depending on how you are using the computer. If the actual operating time is much less than the estimated time, initialize the battery. (See “Initializing the Battery Pack” in Chapter 3 for instructions.)

Bluetooth Problems

I cannot connect to another Bluetooth-enabled device.

- Make sure that both devices have activated Bluetooth.
- Make sure that the distance between the two devices are not over 10 meters or that there are no walls or other obstructions between the devices.
- Make sure that the other device is not in “Hidden” mode.
- Make sure that both devices are compatible.

I cannot end a Bluetooth connection.

- If another device is connected to your computer, you can either end the connection using the other device or by deactivating Bluetooth.

DVD Drive Problems

The DVD drive cannot read a disc.

- Make sure that the disc is correctly seated in the tray, with the label facing up.
- Make sure that the disc is not dirty. Clean the disc with a disc cleaning kit, available in most computer stores.
- Make sure that the DVD drive driver is installed correctly.
- Make sure that the computer supports the disc or the files contained.

You cannot eject a disc.

- The disc is not properly seated in the drive. Manually release the disc following the method described next:
 1. Turn off the system.
 2. Insert a small rod, such as a straightened paperclip, into the drive's manual eject hole and push firmly to release the tray.
 3. Pull the tray out until fully extended, and then remove the disc.



Display Problems

Nothing appears on the screen.

- If the power-on indicator is not on, check the electrical outlet, the plugs and power cords.
- If the power button does not respond to a light touch, press the button firmly.
- If you are using battery power, make sure that it has a charge remaining and that it is installed correctly.
- During operation, the screen may automatically turn off as a result of power management. Press any key to see if the screen comes back.
- The brightness level might be too low. Increase brightness by pressing Fn+F6.
- The display output might be set to an external device. To switch the display back to the LCD, press Fn+F9, or change the display through the settings in **Display Properties**.
- Reset the computer by pressing the keyboard BIOS reset switch on the left side of the computer or by pressing Ctrl+Alt+Del keys.
- Try turning the computer off, wait for a few seconds, then turn it back on.

The characters on the screen are dim.

- Adjust the brightness and/or contrast.

Bad dots appear on the display at all times.

- A small number of missing, discolored, or bright dots on the screen are an intrinsic characteristic of TFT LCD technology. It is not regarded as a LCD defect.

Resolution cannot be adjusted to desired setting.

- Make sure that the video driver is installed correctly.

The external monitor displays nothing.

- Make sure that the monitor is turned on.

- Make sure that the monitor's signal cable is properly connected.
- Switch the display to the monitor by pressing Fn+F9, or change the display through the settings in **Display Properties**.

Simultaneous display/multi-display does not work.

- Make sure that you turn on the external monitor before turning on the computer.
- Press Fn+F9 to toggle through the display options or change the settings in **Display Properties** in Windows.

Fingerprint Recognition Problems

The fingerprint recognition application does not work.

- Make sure that the necessary driver is correctly installed.
- Make sure that your finger is properly placed on the surface of the sensor.

Hardware Device Problems

The computer does not recognize a newly installed device.

- The device may not be correctly configured in the SCU program. Run the SCU program to identify the new type.
- Make sure if any device driver needs to be installed. (Refer to the documentation that came with the device.)
- Make sure if the device needs any jumper or switch settings. (Refer to the documentation that came with the device.)
- Check the cables or power cords for correct connections.
- For an external device that has its own power switch, make sure that the power is turned on.

Hard Disk Drive Problems

The hard disk drive error message appears on the screen.

- Insert a bootable diskette and check the integrity of your hard drive.
- The hard disk drive has defects. Ask your dealer for help.

The hard disk drive operations seem slow.

- The data files stored on the hard disk drive may be fragmented. Use a tool such as Window's **Disk Defragmenter** to defragment the files.

The hard disk drive in-use indicator glows without blinking.

- The data files stored on the hard disk drive may be fragmented. Use a tool such as Window's **Disk Defragmenter** to defragment the files.

Infrared Problems

The IR port does not work.

- Make sure that the IR ports of the two device face each other within a ± 15 -degrees angle and 1 meter (3 feet) distance and there are no obstructions in between.
- Make sure that the device connected is using an equivalent speed.
- Make sure that the IrDA Fast Infrared Port is set to HP HSDL-2300/3600.
- Make sure that the IR port is set correctly in the SCU program.
- If you are printing to an infrared printer, make sure that the appropriate driver is installed.
- If you are using any file transfer functions, make sure that both the computer and the IR device have the appropriate software running.
- Make sure that there is no device radiating infrared rays, such as remote-controlled devices or wireless headphones, near the computer or device.
- Make sure that no direct sunlight or fluorescent lamps are near the computer or device.

- Make sure that the IR ports are clean.

Keyboard, Mouse and Touchpad Problems

The keyboard does not respond.

- Try connecting an external keyboard. If it works, contact an authorized dealer, as the internal keyboard cable might be loose.

The numeric keypad is disabled.

- Make sure that the Num Lk is switched on. (Check if the Num Lock Indicator  glows or not.)

The external keyboard does not work.

- Make sure that the keyboard cable is properly connected.

The USB mouse does not work.

- Make sure that the mouse cable is properly connected.

The touchpad does not work, or the pointer is difficult to control with the touchpad.

- Make sure that the touchpad is clean.

LAN Problems

I cannot access the network.

- Make sure that the LAN driver is correctly installed.
- Make sure that the LAN cable is properly connected to the RJ-45 connector and the network hub.
- Make sure that the network configuration is appropriate.
- Make sure that the user name or password is correct.

WLAN Problems

I cannot use the WLAN feature.

- Make sure that the Mini PCI WLAN card is correctly installed.
- Make sure that the necessary driver(s) is correctly installed.
- Make sure that the WLAN feature is turned on.

Transmission quality is poor.

- Your computer may be in an out-of-range situation. Move your computer closer to the Access Point or another WLAN device it is associated with.
- Check if there is high interference around the environment and solve the problem as described next.

Radio interference exists.

- Move your computer away from the device causing the radio interference such as microwave oven and large metal objects.
- Plug your computer into an outlet on a different branch circuit from that used by the affecting device.
- Consult your dealer or an experienced radio technician for help.

I cannot connect to another WLAN device.

- Make sure that the WLAN feature is turned on.
- Make sure that the SSID setting is the same for every WLAN device in the network.
- Your computer is not recognizing changes. Restart the computer.
- Make sure that the IP address or subnet mask setting is correct.

I cannot communicate with the computer in the network when Infrastructure mode is configured.

- Make sure that the Access Point your computer is associated with is powered on and all the LEDs are working properly.

- If the operating radio channel is in poor quality, change the Access Point and all the wireless station(s) within the BSSID to another radio channel.
- Your computer may be in an out-of-range situation. Move your computer closer to the Access Point it is associated with.
- Make sure that your computer is configured with the same security option (encryption) to the Access Point.
- Use the Web Manager/Telnet of the Access Point to check whether it is connected to the network.
- Reconfigure and reset the Access Point.

I cannot access the network.

- Make sure that the necessary driver(s) is correctly installed.
- Make sure that the network configuration is appropriate.
- Make sure that the user name or password is correct.
- You have moved out of range of the network.
- Turn off power management.

Modem Problems

The modem does not work.

- Make sure that the modem driver is correctly installed.
- Make sure that the COM port in the communication software is correctly set.
- Turn off power management.

Power Management Problems

The computer does not enter Standby or Hibernation mode automatically.

- If you have a connection to another computer, the computer does not enter Standby or Hibernation mode if the connection is actively in use.
- Make sure that the Standby or Hibernation time-out is enabled.

The computer does not enter Standby or Hibernation mode immediately.

- If the computer is performing an operation, it normally waits for the operation to finish.

The computer does not resume from Standby or Hibernation mode.

- The computer automatically enters Standby or Hibernation mode when the battery pack is empty. Do any one of the following:
 - Connect the AC adapter to the computer.
 - Replace the empty battery pack with a fully charged one.

The computer does not enter Hibernation mode with the Fn+F10 hot keys.

- Make sure that the Hibernation function is specified for the sleep button.

Software Problems

An application program does not work correctly.

- Make sure that the software is correctly installed.
- If an error message appears on the screen, consult the software program's documentation for further information.
- If you are sure the operation has stop, reset the computer. (See "Resetting the Computer" later in this chapter.)

Sound Problems

No sound is produced.

- Make sure that the volume control is not set too low.
- Make sure that the audio driver is correctly installed.
- Make sure that the computer is not in Standby mode.
- If using an external speaker, make sure that the speaker is properly connected.

Distorted sound is produced.

- Make sure that the volume control is not set too high or too low. In most cases, a high setting can cause the audio electronics to distort the sound.

The sound system does not record.

- Adjust the playback or recording sound levels.

The external microphone or audio device does not work.

- Make sure that the microphone is connected to the proper connector on the computer.
- Make sure that your computer is equipped with the driver needed.
- Click the speaker symbol on the taskbar and check the Windows volume control.
- Check the volume control of your computer.

Startup Problems

When you turn on the computer, it does not respond and the Power Indicator does not light green.

- If you are using an external AC power, make sure that the AC adapter is correctly and securely connected. If so, make sure that the electrical outlet works properly.

- If you are using the battery power, make sure that the battery is not discharged.

When you turn on the computer, it stops after POST.

- Restart your computer.

Other Problems

The date/time is incorrect.

- Correct the date and time via the operating system or SCU program.
- After you have performed everything as described above and still have the incorrect date and time every time you turn on the computer, the RTC (Real-Time Clock) battery is at the end of its life. Call an authorized dealer to replace the RTC battery.

Resetting the Computer

You may have to reset (reboot) your computer on some occasions when an error occurs and the program you are using hangs up.

If the system operation seems to hang up, first wait. It is possible that the system is processing data. Periodically check the hard disk drive in-use indicator, if it flashes irregularly, the program may be accessing data and preventing you from using the keyboard. If you are sure the operation has stopped and you cannot use the “restart” function of the operating system, reset the computer.

Reset the computer by any one of these methods:

- Press Ctrl+Alt+Del.
- If the above action does not work, turn off the system. Wait for at least five seconds and turn it on again.
- If the above does not work, insert a small rod, such as a straightened paper clip, into the keyboard BIOS reset switch on the left side of the computer and press firmly. The system will shut down. Wait for at least five seconds and turn it on again.



CAUTION: Resetting will cause any unsaved data to be lost.



Specifications

NOTE: Specifications are subject to change without any prior notices.

Parts		Specifications
CPU		Intel Mobile Pentium Dothan Processor-M series, μ -FCPGA package, 1.8 GHz; Front Side Bus (FSB) 400 MHz, 21 W thermal ceiling
Cache Memory		L2 2 MB on-die
ROM BIOS		512 KB Flash EEPROM, system and VGA BIOS, ACPI 2.0, PC2001-compliant
RAM	System	Two 200-pin 200/266/333 MHz DDR SO-DIMM sockets, maximum 2 GB (standard 256 MB)
	Video	64 MB (shared system memory)
Display	Panel	12.1-inch XGA transmissive LCD, polarizer touchscreen, high contrast (option)
		13.3-inch TFT color LCD display, polarizer touchscreen
	Video controller	855GME, integrated 32-bit 3D/2D gfx core with Dynamic Video Memory technology, supports DirectX® 8.1, dual view function, LCD/CRT simultaneous display capability
	Video port	DVI-I port, video capture
Audio	Controller	ALC202 codec, AC97 Rev.2.2 support, two 2-watt stereo speakers built-in
	Ports	Two audio ports for Mic-in / Line-out
Keyboard		Full travel waterproof with membrane cover, rubber keyboard and backlight feature (option)
Pointing device		Four buttons touchpad
Storage device	Hard disk drive	2.5-inch, Ultra DMA support, damper protection, Flash Ultra DMA M-system (option), built-in system heater for low temperature function (option)
	Optical drive	DVD drive / Combo drive / DVD Dual drive
I/O ports		Serial port, two USB ports, IR port, docking port with guide-pin, two antenna ports, RJ-45 port, RJ-11 port, fingerprint sensor (option)

Parts		Specifications
Communications	Modem	56 K (V.90/V.92; 28,000 ~ 56,000 bits/s data rates)
	LAN	10/100 Base-T Ethernet
	Others (options)	Wireless LAN 802.11a/b/g using diversity antennas GPS Lassen IQ module Bluetooth Class 1 Wireless modem in X-Bay module
Power	AC adapter	Input: 100~240 V AC, 50~60 Hz universal adapter Output: 19 V DC / 90 W
	Battery	Smart Li-ion battery 11.1 V / 6000 mAH (9 cells)
Dimension (W×D×H)		11.8×9.5×2.3 inch (300×241×58 mm)
Weight		9.9 lb (4.5 kg)
Environment	Temperature	Operating: 0 °C (32 °F) to 50 °C (122 °F) Storage: -40 °C (-40 °F) to 70 °C (158 °F)
	Humidity	Operating: 5 % to 95 % RH, non-condensing
	Altitude	Operating: 15,000 ft Storage: 40,000 ft (2,000 ft/min change rate)
	Shock	Operating: 20 g Storage: 50 g
	Vibration	Operating: 10~55 Hz / 0.075, 55~500 Hz / 1 g Storage: 10~55 Hz / 0.15, 55~500 Hz / 2 g
	Drop	Survives 3 ft drop on steel plate

Fingerprint Recognition System

Your system features a fingerprint recognition system designed for computer security. It provides a high level of user convenience and gives you a set of powerful tools for securing your computer and protecting your private data. The system can:

- display fingerprint images derived from the sensor IC
- enroll new users
- extract fingerprint templates from raw images, and store them in a local database
- match live-scan fingerprints against the local database

Finger Placement

When placing a finger to be enrolled or identified, slide the cover to expose the sensor matrix surface, then use a light, but firm and steady pressure.



Avoid moving your finger during the scan, and be sure that you are making contact with the “sensor matrix” and with the surrounding drive ring (the light-colored surface surrounding the matrix). The system works best when it has a “core” image (the center of your fingerprint, which is approximately opposite the line of the cuticle of your fingernail).

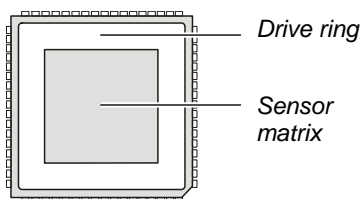

Using the Fingerprint Recognition System Utility

NOTE: To take advantage of the fingerprint recognition system, the driver and utility supplied with your computer must be installed (see chapter 6 for details).

Double-click on the icon located on your Windows' system tray. The main menu appears.

The following program options are available:

- **Enroll** – allows the sensor IC to acquire fingerprint images, process it into the essential template data, and then insert it into the database together with an associated User ID and other optional information.
- **Identify** – is used to compare the finger presented to the sensor against all of the other fingerprints currently entered in the database (known as *one-to-many* search).
- **Validate ID** – is used to perform a *one-to-one* verification to ascertain if the person whose finger is placed on the sensor is in fact the same as the person enrolled under a particular User ID.
- **Data Capture** – a viewing facility that is used to display (or capture) a continuous series of real-time images of a fingerprint.
- **Database** – is used to review, delete, and otherwise manage the contents of the database.

NOTE: For an online Help information on using the application, click on "Help" located on the menu bar, then "Aware User's Guide."

A `Readme.txt` file is also located on your driver CD for late-breaking news, known bugs, work-arounds, and other additions, deletions, or discrepancies in the application program.