

*NEC MobilePro™ Series of Handheld Personal Computers*

# MOBILEPRO 880



U S E R ' S   G U I D E

**NEC**

## **Proprietary Notice and Liability Disclaimer**

The information disclosed in this document, including all designs and related materials, is the valuable property of NEC Computers Inc. (hereinafter “NECC”) and/or its licensors. NECC and/or its licensors, as appropriate, reserve all patent, copyright and other proprietary rights to this document, including all design, manufacturing, reproduction, use, and sales rights thereto, except to the extent said rights are expressly granted to others.

The NECC product(s) discussed in this document are warranted in accordance with the terms of the Warranty Statement accompanying each product. However, actual performance of each such product is dependent upon factors such as system configuration, customer data, and operator control. Since implementation by customers of each product may vary, the suitability of specific product configurations and applications must be determined by the customer and is not warranted by NECC.

To allow for design and specification improvements, the information in this document is subject to change at any time, without notice. Reproduction of this document or portions thereof without prior written approval of NECC is prohibited.

NEC and MobilePro are registered trademarks or trademarks of NEC Corporation and/or one or more of its subsidiaries. All are used under license.

Microsoft, MS, MSN, PowerPoint, ActiveX, ActiveSync, Outlook, InkWriter, Windows, Windows NT, Visual Basic, Visual C++, and the Windows logo are either registered trademarks or trademarks of Microsoft Corporation in the United States and/or other countries. Microsoft products are licensed to OEMs by Microsoft Licensing, Inc., a wholly owned subsidiary of Microsoft Corporation.

All other product, brand, or trade names used in this publication are the trademarks or registered trademarks of their respective trademark owners.

First Printing — March 2000

Copyright 2000  
NEC Computers Inc.  
15 Business Park Way  
Sacramento, CA 95828  
All Rights Reserved

---

# Contents

## Using This Guide

Text Conventions .....	viii
------------------------	------

## 1 Getting Started

Welcome.....	1-2
Unpacking Your MobilePro .....	1-3
Getting to Know Your MobilePro .....	1-4
Accessories .....	1-5
Installing and Charging the Battery .....	1-5
Connecting the AC Adapter .....	1-7
Taking a Quick Tour.....	1-10
Introducing the Software.....	1-10
Connecting to Your PC via Serial.....	1-11
Verifying PC Connection Settings .....	1-12
Ensuring the Availability of the Serial Port.....	1-12
Connecting the PC Connect Cable .....	1-13
Installing Microsoft ActiveSync .....	1-15
Network Requirements .....	1-16
Installing ActiveSync.....	1-17
Creating a Partnership .....	1-18
Verifying Synchronization Settings.....	1-18
Connecting to Your PC via Infrared .....	1-19
Modifying PC Connection Settings.....	1-20
Setting the Infrared Connection Speed .....	1-20
Enabling the Infrared Port.....	1-21
Installing Microsoft ActiveSync .....	1-22
Network Requirements .....	1-23
Installing ActiveSync.....	1-24
Creating a Partnership .....	1-25
Verifying Synchronization Settings.....	1-25
Synchronizing with Your Host PC .....	1-26
Synchronizing via the Serial Port.....	1-26
Synchronizing via the Infrared Port .....	1-27
Resynchronizing Your MobilePro.....	1-27

---

Using other Communication Devices .....	1-27
Connecting Remotely .....	1-27
Getting Help .....	1-28

## **2 Introducing the NEC MobilePro**

Identifying System Features .....	2-2
Around the Front of the System .....	2-2
Display Panel.....	2-2
Keyboard Panel and Base Unit.....	2-4
Around the Back of the System.....	2-6
Around the Left Side of the System .....	2-7
Around the Right Side of the System .....	2-8
Around the Bottom of the System.....	2-9
Opening the Display Panel.....	2-10
Using the Stylus.....	2-10
Using MobilePro's Power Sources .....	2-11
Determining Battery Status.....	2-11
Recharging the Main Battery Pack.....	2-12
Recharging the Backup Battery.....	2-13
MobilePro Power Management.....	2-13
Battery Replacement .....	2-14
Removing and Inserting the Battery Pack.....	2-14
Battery Precautions.....	2-17
Caring for the MobilePro .....	2-18
Precautions.....	2-18
Storage Requirements.....	2-19
Routine Cleaning.....	2-20

## **3 Introducing Windows CE**

Windows CE Operating System .....	3-2
Using Windows CE.....	3-2
Tapping .....	3-2
Selecting Objects .....	3-3
Dragging and Dropping .....	3-3
Windows CE Desktop .....	3-4
Pocket Applications.....	3-6
Printing Features .....	3-8
Network Capabilities .....	3-10

---

Creating a Network (Ethernet) Connection.....	3-10
Microsoft ActiveSync .....	3-11
Backing Up and Restoring Data.....	3-12
Using Microsoft ActiveSync.....	3-12
Using b SQUARE <sup>®</sup> bUseful <sup>™</sup> Backup Plus.....	3-13
Software Applications.....	3-14
Using the Bonus Software CD.....	3-14
Online Help .....	3-16

## **4 Using the NEC MobilePro**

Powering On and Off .....	4-2
Making Display Panel Adjustments.....	4-4
Backlight.....	4-5
Automatic Off .....	4-5
Automatic On.....	4-6
Enabling the Suspend Switch.....	4-7
Using the Keyboard .....	4-9
Using Application Shortcut Keys.....	4-10
Default Function Keys.....	4-12
Display Panel Icons .....	4-12
Adjusting MobilePro Settings .....	4-13
Assigning User Software Icons.....	4-14
Connecting the VGA Cable .....	4-15
Using the Voice Recorder .....	4-17
Menu.....	4-18
Using PC Cards .....	4-18
Inserting PC Cards .....	4-19
Removing PC Cards .....	4-20
Using CompactFlash Cards .....	4-20
Inserting CompactFlash Cards.....	4-21
Removing CompactFlash Cards.....	4-22
Using the IR Port .....	4-22
Upgrading ROM.....	4-24
Resetting the MobilePro.....	4-26
Using the Soft Reset Button.....	4-27
Using the Full Reset Button.....	4-28

---

## **5 Setting Up a Remote Connection**

Preparing for Connection Setup.....	5-2
Connecting the Internal Modem .....	5-3
Connecting to an Internet Service Provider.....	5-4
Connecting to a Remote Access Server .....	5-6
Sending and Receiving Email.....	5-7
Activating a Connection.....	5-9

## **A Troubleshooting**

## **B Specifications**

## **Index**

---

# Using This Guide

The *NEC MobilePro™ 880 User's Guide* gives you the information you need to maximize the use of your NEC MobilePro 880 Professional PC Companion. Read this guide to familiarize yourself with the MobilePro and its features. For specific information, see the following.

- Chapter 1, “Getting Started,” provides all the information you need to get your MobilePro 880 working and synchronized with your host PC.
- Chapter 2, “Introducing the NEC MobilePro,” introduces you to the MobilePro features, battery recharging, and general unit care.
- Chapter 3, “Introducing Windows CE,” provides an overview of Microsoft® Windows® CE and Windows CE applications.
- Chapter 4, “Using the NEC MobilePro,” shows you how to power on and off, make display panel adjustments, install PC and CompactFlash™ cards, and more.
- Chapter 5, “Setting Up a Remote Connection,” describes how to configure service connections for an internet service provider, a remote access service, and how to configure email for each new service connection.
- Appendix A, “Troubleshooting,” walks you through some common problems and possible solutions.
- Appendix B, “Specifications,” details the hardware specifications for your MobilePro.

---

## Text Conventions

To make this guide as easy to use as possible, text is set up as follows.

- Warnings, cautions, and notes have the following format:

---

 **WARNING**

Warnings alert you to situations that could result in serious personal injury or loss of life.

---

---

 **CAUTION**

Cautions indicate situations that can damage the system hardware or software.

---

---

 **Note:** Notes give particularly important information about whatever is being described.

---

- Names of keys are printed as they appear on the keyboard, for example, **Ctrl**, **Alt**, or **Enter**.
- Text that you must type or keys that you must press are presented in bold type. For example, type **dir** and press **Enter**.



# 1

## Getting Started

- Welcome
- Unpacking Your MobilePro
- Getting to Know Your MobilePro
- Installing and Charging the Battery
- Connecting the AC Adapter
- Taking a Quick Tour
- Introducing the Software
- Connecting to Your PC via Serial
- Connecting to Your PC via Infrared
- Synchronizing with your Host PC
- Getting Help

---

# Welcome

Congratulations on purchasing your NEC MobilePro 880 Professional PC Companion powered by the Microsoft® Windows CE operating system. The size and capabilities of this device let you keep your most important business and personal information up-to-date and close at hand. Microsoft ActiveSync™ increases the power of your device by letting you synchronize the information on your host PC with your device. Picture yourself in the following situations:

- You're on a business trip, getting important customer feedback to discuss with your colleagues back in the office. Using Calendar, Contacts, and Inbox, you schedule a meeting and send it to your colleagues while still on the road.
- You are on the road taking customer orders. Using Pocket Access, you create records for each customer order. At night, you connect to your network and update the global database with your new orders. You also download updates to the product information database that you use when making sales.
- During a few spare minutes in the airport, you check your e-mail and send a note to your daughter wishing her luck at the gymnastics meet. (Requires access to an analog phone line or wireless modem card and subscription to an internet service provider or corporate network server.)

Before you start using your device, you will need to install batteries, turn it on, and adjust the screen contrast.

---

# Unpacking Your MobilePro

Your NEC MobilePro ships with a number of accessories. When you unpack the NEC MobilePro, verify that you have all of the items listed below and that they are in good condition. If anything is missing or damaged, contact the vendor who sold you the unit.

---

 **Note:** Do not attempt to use the unit without the batteries installed. Be sure you have completed the sections, “Installing and Charging the Battery,” “Connecting the AC Adapter,” and “Taking a Quick Tour,” in Chapter 1.

---

- NEC MobilePro 880 (a stylus ships in a holder in the MobilePro)
- NEC MobilePro AC Adapter
- NEC MobilePro VGA Cable
- NEC MobilePro PC Connect Cable (serial cable)
- NEC MobilePro RJ-11 (telephone cable)
- One (1) rechargeable Lithium-Ion Battery pack (main battery)
- Microsoft ActiveSync CD
- NEC MobilePro Bonus Software CD<sup>1</sup>
- *NEC MobilePro 880 User's Guide* (this document)
- *Introduction to Your MobilePro Power System* sheet
- NEC MobilePro Release Notes

<sup>1</sup> For U.S. and Canada distribution only.

---

# ***Getting to Know Your MobilePro***

The NEC MobilePro 880 offers you a portable system designed for synchronization with your host PC. Standard features include a VR4121, 168-MHz, 32 MB RAM, a 9.4-inch SVGA DSTN, 64K color, enhanced touch screen, a V.90 internal modem, a built-in microphone, internal speaker, and Type I/II PC card and CompactFlash™ Type II card support.

*NEC MobilePro 880*



With your NEC MobilePro you can edit, create, send, and receive documents including text, spreadsheets, presentations, and email, manage your schedule and contacts, access the internet with the internal modem, and synchronize data with your host PC.

---

## ***Accessories***

The NEC MobilePro 880 ships with the following accessories:

- AC adapter
- PC Connect (serial port) cable
- RJ-11 Telephone cable
- VGA Monitor cable

For a comprehensive list of MobilePro accessories, refer to the MobilePro desktop. Tap Start, Help, and double tap the MobilePro Accessories link.

## ***Installing and Charging the Battery***

Follow these steps to install and charge the main battery.



### **CAUTION**

Use only the MobilePro 880 battery (MC/BA11A) in the MobilePro 880 system (MC/R730A). Do not use the MobilePro 800 battery (MC/BA11) in the MobilePro 880 system. Use of the MobilePro 800 battery in the MobilePro 880 system may cause battery damage and/or system data loss.

---

- 
1. Unpack the contents of the MobilePro carton and locate the unit and the Lithium-Ion battery pack.

*Lithium-Ion battery pack*

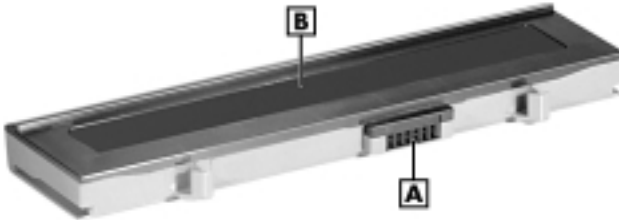

**A** – Battery connectors **B** – Lithium-Ion battery pack

2. Insert the Lithium-Ion battery pack in the bay and slide the battery in the direction of the arrow, as indicated in the following figure.

*Inserting the battery pack*

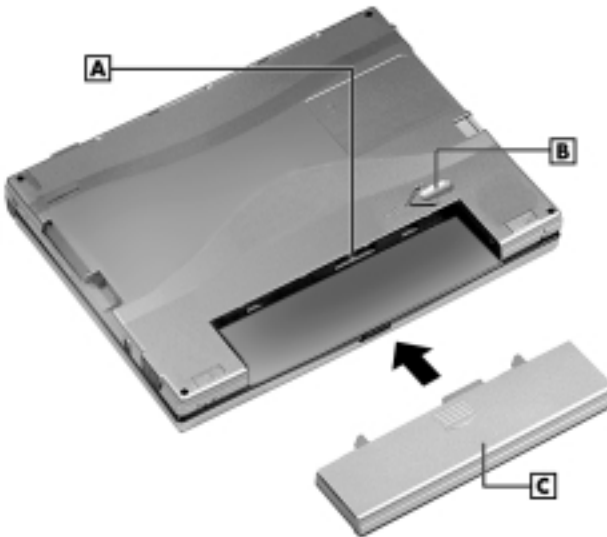

**A** – Battery connectors **B** – Battery release latch **C** – Lithium-Ion battery pack

- 
3. Firmly press the battery until it is securely connected in the bay.
  4. Connect the AC adapter to begin charging the battery. Refer to the next section, “Connecting the AC Adapter,” for connection information.

The color of the left status LED changes from amber to green when the battery is fully charged.

---

 **Note:** Before using the system for the first time, allow ten hours for both the main and the backup batteries to fully charge, even if the indicator on the front of the MobilePro lights green before the full ten hours are passed. You must repeat this full ten hour charge cycle, only if the backup battery becomes fully discharged.

To protect your data, do not use the system until the backup battery is charged. Recharge the battery whenever the battery charging LED lights amber.

---

## ***Connecting the AC Adapter***

NECC recommends using the AC adapter if you

- are recharging the main battery pack or the backup battery.
- are using PC cards or Compact Flash™ cards.
- are using the internal modem.
- have your MobilePro on for long periods.



## CAUTION

Follow these precautions whenever you use the AC adapter and the NEC MobilePro.

- When using the AC adapter, make sure the AC outlet is near the NEC MobilePro and is easily accessible.
  - Keep the main battery installed when running on AC power.
  - When communicating or sending transmissions for a long time, use the AC adapter to conserve power.
- 

Follow these steps to connect the AC adapter.

1. Insert the plug on the AC adapter cable into the AC power port on the left side of the NEC MobilePro.

### *Connecting the AC adapter*

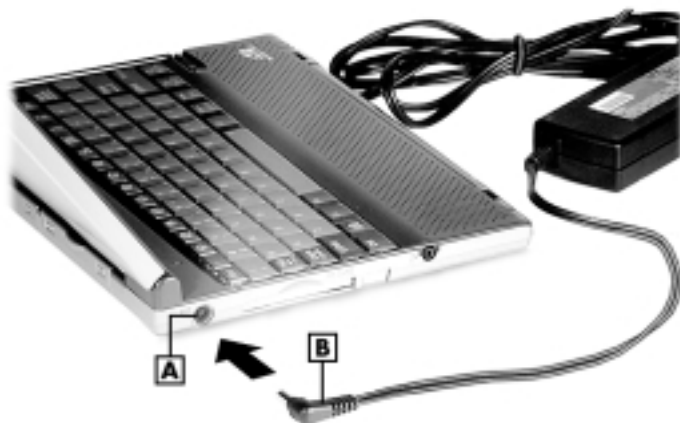

A – AC power port    B – AC adapter cable

2. Plug the AC adapter into a working AC outlet.



- 
3. Power on the NEC MobilePro using the Power button at the top right corner of the keyboard.

Using AC power saves battery life when you are on the go and ensures that the backup battery maintains its charge and helps prevent data loss.



## CAUTION

If you power off, then quickly power on the NEC MobilePro, your system may erroneously report the presence of CompactFlash cards.

In addition, repeatedly powering off and quickly powering on, may cause data loss. NECC recommends that you wait ten seconds after powering off, before powering on the NEC MobilePro.

---

Continue working with the NEC MobilePro 880 as it charges and leave it connected to AC power after the light turns green.

---

 **Note:** Before using the system for the first time, allow ten hours for both the main and the backup batteries to fully charge, even if the indicator on the front of the MobilePro lights green before the full ten hours are passed.

---

---

## ***Taking a Quick Tour***

This section takes you through the process of setting up your system for the first time.

1. Open the display panel to start your NEC MobilePro 880 for the first time.

Press the Power button if the system does not start automatically.

2. Follow the on-screen instructions to calibrate the touch screen. Press **Ctrl Alt =** to recalibrate at any time.
3. Be sure to enter your name, local city, and set the clock for your local time.
4. Be sure to specify a country for modem use. For details, see the section, “Adjusting MobilePro Settings,” in Chapter 4.

## ***Introducing the Software***

Your NEC MobilePro 880 features the latest version of Microsoft Windows CE software along with additional applications on the accompanying CDs.

Your NEC MobilePro 880 software includes:

- Microsoft ActiveSync CD (Install on your host PC for access and synchronization.)
- Microsoft Windows CE pre-loaded (in ROM) applications.
- Bonus Software CD (For U.S. and Canada distribution, only.)

For more information about your MobilePro software, refer to Chapter 3, “Introducing Windows CE.”

---

# ***Connecting to Your PC via Serial***

The MobilePro is designed to be a companion PC. Most users want to synchronize the MobilePro 880 with a host PC. The latest work done on either the MobilePro or the host PC automatically appears on both machines, once the synchronization process occurs.

The following section provides an overview of the synchronization process, using the serial port, followed by detailed instructions for each stage of the process.

Follow these procedures to configure your MobilePro for synchronization using the serial port.

- Verify the accuracy of the PC Connection default settings on your MobilePro.
- Ensure the availability of the serial port on your host PC.
- Connect the PC Connect (serial) cable to your host PC and to your MobilePro.
- Install Microsoft ActiveSync on your host PC.
- Create a partnership between your host PC and your MobilePro.
- Verify that the desired synchronization services are configured.

---

## ***Verifying PC Connection Settings***

Your MobilePro ships with PC Connection default settings. Follow these steps to verify the accuracy of the PC Connection settings.

1. Tap Start, Settings, Control Panel.
2. Double tap the Communications icon and select the PC Connection tab.
3. Verify the following settings.
  - “Allow connection with desktop computer when device is attached” is checked.
  - “Connect using Serial Port @ 115K” displays. (Change this setting to 115K, if necessary. If synchronization is unsuccessful, revert to the default setting of 19200.)

Proceed to the next section to check the availability of the serial port on your host PC.

## ***Ensuring the Availability of the Serial Port***

The serial port on your host PC must be available for synchronization with your NEC MobilePro. Follow these steps to ensure the availability of the serial port.

1. Access the Setup utility on your host PC to verify that the port is enabled.
2. Check the Windows device manager on your host PC to identify potential conflicts for the serial port.
  - Go to Start, Settings, Control Panel.

- 
- Double click the System icon and select the Device Manager tab.
  - Check the Ports listing to determine if any conflicts exist (another device is assigned to or using the serial port). The port may be flagged with an exclamation point, for example, if any conflicts exist.
  - If another device is assigned to or is using the serial port, you must reassign the device to free up the serial port for MobilePro synchronization.

Proceed to the next section to connect the PC connect cable.

## ***Connecting the PC Connect Cable***

Before installing Microsoft ActiveSync, follow these instructions to connect the PC Connect (serial) cable that ships with your MobilePro to both your MobilePro and to your host PC.

1. Locate and open the serial port cover on the back of your MobilePro.

- 
2. Align and attach the PC Connect cable to the serial port on the MobilePro. (If your cable is labeled, insert the cable with the word Up visible on the top. If your cable has an arrow near the connector, insert the cable with the arrow visible on top.)

*Connecting the PC connect cable*



3. Connect the other end of the cable to the 9-pin serial port on your host PC. If your host PC has a 25-pin serial port, use an adapter (available in most computer stores).

Proceed to the next section to install Microsoft ActiveSync.

---

 **Note:** Before connecting the PC Connect cable to the serial port on your host PC, be sure that the serial port is enabled in the host PC's BIOS setup and that no conflicts exist for the port. For details, see a previous section in this chapter, "Ensuring the Availability of the Serial Port."

---



## CAUTION

Be sure to properly align the cable connectors and ports. Incorrect connection can damage the MobilePro and the computer.

---

### ***Installing Microsoft ActiveSync***

You must install Microsoft ActiveSync on your host PC to enable synchronization with your MobilePro. The Microsoft ActiveSync CD that ships with your MobilePro contains the ActiveSync software designed for synchronization with Microsoft Office components. The following procedure assumes Microsoft Outlook as the host PC synchronization component.

Before attempting to install ActiveSync, perform the following procedure on the Windows 95/98 host PC.



**Note:** For host PCs running Windows NT and Windows 2000, see your operating system documentation, network administrator, or contact NECC Support Services at **1-800-632-4525**.

---

1. On the host PC, click Start, Settings, and Control Panel on the taskbar.
2. Click on the network icon.
3. Click on ADD.
4. Under the Configuration tab, click on Protocol.
5. Click on Microsoft.
6. Select TCP/IP.
7. When the Select Device screen appears, select Microsoft.

---

8. Select Dial-Up Adapter.

9. Reboot the system.

### *Network Requirements*

If your host PC is connected to a network, configure one of the following before installing Microsoft ActiveSync:

- Configure a WINS server on the host PC's network, or,
- Configure the host PC's IP address on the MobilePro as follows:
  1. Tap Start, Settings, Control Panel, and double tap the network icon.
  2. Highlight NE2000 Compatible Ethernet Driver and select the Properties button.
  3. In the IP address tab, select (place a dot beside) "Obtain an IP address via DHCP."
  4. Select the Name Servers tab and enter the host PC's IP address in the "Primary WINS" field.

To identify the host PC's IP address, run an IP config utility. In Windows 98 and 95, run Win IP Config. In Windows NT, run IP Config. If you need assistance, see your network administrator.



---

## Installing ActiveSync

Follow these steps to install Microsoft ActiveSync for synchronization with Microsoft Outlook. The installation sequence may vary depending upon the Microsoft components installed on your host PC.

---

 **Note:** If your host PC uses the Windows NT operating system, you must install Windows NT Networking before installing Microsoft ActiveSync to your host PC.

---

1. Insert the Microsoft ActiveSync CD in the CD-ROM drive of your host PC.
  - If auto insert is enabled on your host PC, the setup window appears.
  - If auto insert is not enabled, go to Start, Run, browse for the CD-ROM drive, and run the setup.exe file.

2. Click Next to start the setup wizard.

The Selection Installation folder appears.

3. Click Next to accept the default installation folder or modify the folder destination and click Next.

The Get Connected window appears.

4. Read the instructions about connecting your device and click Next.

The host PC verifies the availability of a COM port and polls the MobilePro for synchronization settings. The New Partnership window appears.

Proceed to the next section to complete the installation.

---

## ***Creating a Partnership***

Once the host PC verifies the availability of a COM port and polls the MobilePro for synchronization settings, the New Partnership window appears.

1. Click Next to display the Select Synchronization Settings window.
2. Select the desired synchronization settings and click Next.  
The Setup Complete window appears.
3. Click Finish to complete the installation process.

## ***Verifying Synchronization Settings***

Look for the new Microsoft ActiveSync desktop icon on your host PC. Follow these steps to verify the synchronization settings on the MobilePro.

1. Double click the ActiveSync icon.
2. Click Tools, Options and verify that the desired synchronization services are checked. Modify the selections as required.

---

 **Note:** By default, synchronization of email messages is not checked. Be sure to select the checkbox for this service if you want to synchronize email between your MobilePro to your host PC.

---

---

Once installed, Microsoft ActiveSync automatically synchronizes your MobilePro 880 with your host PC's Microsoft Outlook email, contacts, calendar, and task list each time you attach the PC Connect cable to the MobilePro 880 and the host PC.

---

 **Note:** Whenever possible Microsoft ActiveSync automatically translates files and email attachments during synchronization. This allows you to use the MobilePro to view and work with files created on your host PC with Microsoft Word, Excel, and PowerPoint, among others.

However, as noted in the readme.doc file on the Microsoft ActiveSync CD, PowerPoint files created or modified on the MobilePro are not translated for viewing or modification on your host PC. This limitation does not apply to Pocket Word or Pocket Excel files.

---

## ***Connecting to Your PC via Infrared***

If your host PC is not equipped with a serial port or the serial port(s) is in use, use the infrared port to synchronize the NEC MobilePro with your host PC.

The following section provides an overview of the synchronization process, using the infrared port, followed by detailed instructions for each stage of the process.

Follow these procedures to configure your MobilePro for synchronization using the infrared port.

- Modify the PC Connection default settings on your MobilePro.
- Set the infrared connection speed.

- 
- Enable the infrared port on your host PC.
  - Install Microsoft ActiveSync on your host PC.
  - Create a partnership between your host PC and your MobilePro.
  - Verify that the desired synchronization services are configured.

## ***Modifying PC Connection Settings***

Your MobilePro ships with PC Connection default settings. Follow these steps to modify the PC connection settings.

1. Tap Start, Settings, Control Panel, Communications.
2. Select the PC Connection tab.
3. Select the Change tab, use the dropdown box to change the setting to Infrared port, and click OK.

Proceed to the next section to set the infrared connection speed, if necessary.

## ***Setting the Infrared Connection Speed***

Your NEC MobilePro supports both SIR (115 Kbps) and FIR (4 Mbps) IR communications. Follow these steps to set the infrared connection speed.

1. Tap Start, Settings, Control Panel, and double tap MobilePro Settings.
2. Select the IrDA tab and select the appropriate infrared connection speed. The infrared connection speed on your NEC MobilePro must be compatible with the infrared connection speed on your host PC.

- 
3. Tap OK and close the Control Panel.

Proceed to the next section to enable the infrared port on your host PC.

## ***Enabling the Infrared Port***

The infrared port on your host PC must be available for synchronization with your NEC MobilePro. Follow these steps to enable the infrared port.

1. Access the setup utility on your host PC to verify that the port is enabled. If required, select FIR support in Setup.
2. Set up infrared software components on your host PC. In the Windows environment:
  - Go to Start, Settings, Control Panel.
  - If infrared is disabled, select the options tab and place a check in the box "Enable infrared communications."
  - Place a check in the boxes, "Search and provide status for devices in range," and "Install software for Plug and Play devices within range."
  - Uncheck the box, "Limit connection speed to."
3. Click Apply and click OK.
4. Check the device manager on your host PC to identify potential conflicts for the infrared port.
  - Double click the System icon and select the Device Manager tab.
  - Check the Ports listing to determine if any conflicts exist (another device is assigned to or is using the infrared port). The port may be flagged with an exclamation point, for example, if any conflicts exist.

- 
- If another device is assigned to or is using the infrared port, you must reassign the device to free up the infrared port for MobilePro synchronization.

## 5. Reboot your host PC.

Once the system restarts, an infrared icon (gray vertical bar with a red bump) appears in the system taskbar. If there is an X to the right of the icon, infrared is not enabled. Repeat steps 1-4 to enable infrared.

## ***Installing Microsoft ActiveSync***

You must install Microsoft ActiveSync on your host PC to enable synchronization with your MobilePro. The Microsoft ActiveSync CD that ships with your MobilePro contains the ActiveSync software designed for synchronization with Microsoft Office components. The following procedure assumes Microsoft Outlook as the host PC synchronization component.

Before attempting to install ActiveSync, perform the following procedure on the Windows 95/98 host PC.

---

 **Note:** For host PCs running Windows NT and Windows 2000, see your operating system documentation, network administrator, or contact NECC Support Services at **1-800-632-4525**.

---

1. On the host PC, click Start, Settings, and Control Panel on the taskbar.
2. Click on the network icon.
3. Click on ADD.
4. Under the Configuration tab, click on Protocol.

- 
5. Click on Microsoft.
  6. Select TCP/IP.
  7. When the Select Device screen appears, select Microsoft.
  8. Select Dial-Up Adapter.
  9. Reboot the system.

### *Network Requirements*

If your host PC is connected to a network, configure one of the following before installing Microsoft ActiveSync:

- Configure a WINS server on the host PC's network, or,
- Configure the host PC's IP address on the MobilePro as follows:
  1. Tap Start, Settings, Control Panel, and double tap the network icon.
  2. Highlight NE2000 Compatible Ethernet Driver and select the Properties button.
  3. In the IP address tab, select (place a dot beside) "Obtain an IP address via DHCP."
  4. Select the Name Servers tab and enter the host PC's IP address in the "Primary WINS" field.

To identify the host PC's IP address, run an IP config utility. In Windows 98 and 95, run Win IP Config. In Windows NT, run IP Config. If you need assistance, see your network administrator.

---

## Installing ActiveSync

Follow these steps to install Microsoft ActiveSync for synchronization with Microsoft Outlook. The installation sequence may vary depending upon the Microsoft components installed on your host PC.

---

 **Note:** If your host PC uses the Windows NT operating system, you must install Windows NT Networking before installing Microsoft ActiveSync to your host PC.

---

1. Insert the Microsoft ActiveSync CD in the CD-ROM reader of your host PC.
  - If auto insert is enabled on your host PC, the setup window appears.
  - If auto insert is not enabled, go to Start, Run, browse for the CD-ROM drive, and run the setup.exe file.
2. Click Next to start the setup wizard.

The Selection Installation folder appears.
3. Click Next to accept the default installation folder or modify the folder destination and click Next.

The Get Connected window appears.
4. Place the NEC MobilePro so that the infrared port is within range of the host PC infrared port and read the instructions about connecting your device. Click Next.
5. On the NEC MobilePro, tap Start, Programs, Communication, and PC Link.



---

The host PC verifies the availability of an infrared port and polls the MobilePro for synchronization settings. The New Partnership window appears.

Proceed to the next section to complete the installation.

## ***Creating a Partnership***

Once the host PC verifies the availability of an infrared port and polls the MobilePro for synchronization settings, the New Partnership window appears.

1. Click Next to display the Select Synchronization Settings window.
2. Select the desired synchronization settings and click Next.  
The Setup Complete window appears.
3. Click Finish to complete the installation process.

## ***Verifying Synchronization Settings***

Look for the new Microsoft ActiveSync desktop icon on your host PC. Follow these steps to verify synchronization settings on the MobilePro.

1. Double click the ActiveSync icon.
2. Click Tools, Options and verify that the desired synchronization services are checked. Modify the selections as required.

Once installed, Microsoft ActiveSync automatically synchronizes your MobilePro 880 with your host PC's Microsoft Outlook email, contacts, calendar, and task list each time you attach the PC Connect cable to the MobilePro 880 and the host PC.

---

 **Note:** Whenever possible Microsoft ActiveSync automatically translates files and email attachments during synchronization. This allows you to use the MobilePro to view and work with files created on your host PC with Microsoft Word, Excel, and PowerPoint, among others.

However, as noted in the readme.doc file on the Microsoft ActiveSync CD, PowerPoint files created or modified on the MobilePro are not translated for viewing or modification on your host PC. This limitation does not apply to Pocket Word or Pocket Excel files.

---

## ***Synchronizing with Your Host PC***

Once your MobilePro is configured for synchronization with your host PC, synchronization occurs when the ActiveSync components on the NEC MobilePro and on the host PC are activated. When synchronizing via the serial port, the process occurs automatically. When synchronizing via the infrared port, manual intervention is required. Refer to the next two sections for details about synchronizing with your host PC.

### ***Synchronizing via the Serial Port***

Once the MobilePro is configured for synchronization the synchronization process automatically occurs each time you connect the MobilePro to your host PC, via the serial port. In addition, you can manually initiate the synchronization process using Microsoft ActiveSync on your host PC. Simply open the ActiveSync window, click File, and click Synchronize.

---

## ***Synchronizing via the Infrared Port***

Once the MobilePro is configured for synchronization via infrared, the ActiveSync component on the MobilePro must be manually activated to initiate the synchronization process. Simply tap Start, Programs, Communication, ActiveSync to initiate synchronization via infrared.

## ***Resynchronizing Your MobilePro***

Once synchronized, you may need to re-establish communication between the MobilePro and your host PC if you soft reset the MobilePro or you warm boot your host PC. To re-establish communication between the MobilePro and your host PC, do one of the following:

- Disconnect, then reconnect the PC Connect (serial) cable.
- Power off, then power on the MobilePro unit.

## ***Using other Communication Devices***

During synchronization, the PC Connect (serial) cable must be connected to your host PC. However, you must disconnect the serial cable before using the internal modem, IR port or a network card in your MobilePro.

## ***Connecting Remotely***

In addition to using your MobilePro as a companion PC, when you travel you can connect by modem directly to an internet service provider or a network remote access server, to get email and to view web pages.

Refer to Chapter 5, “Setting Up a Remote Connection” for details.

---

# Getting Help

The following table provides a comprehensive list of where you can get help on your MobilePro 880, the software, connections, accessories, and support.

## Help Resources

Item	Resource
MobilePro Operation	<b>MobilePro User's Guide</b>
Windows CE	<b>Windows CE Main Help</b> Help file included with Windows CE. Tap Start then Help on the MobilePro desktop taskbar. <b>Microsoft Windows CE for the Handheld PC Home</b> <a href="http://www.microsoft.com/windowsce">http://www.microsoft.com/windowsce</a> <b>Microsoft Windows CE for the Handheld PC Frequently Asked Questions</b> <a href="http://support.microsoft.com/support/windowse/faq/default.asp">http://support.microsoft.com/support/windowse/faq/default.asp</a> <b>Microsoft Windows CE for the Handheld PC Newsgroups</b> <a href="http://support.microsoft.com/support/news/Ngrresults.asp?D=wce">http://support.microsoft.com/support/news/Ngrresults.asp?D=wce</a> <b>Chris De Herrera's Windows CE Website Home</b> <a href="http://www.cewindows.net">http://www.cewindows.net</a>
ActiveSync (formerly Windows CE Services)	<b>ActiveSync Help</b> After installing ActiveSync on your host PC, click on Start/Programs/ActiveSync to open the ActiveSync window. Select Help from the menu bar and click on Microsoft ActiveSync Help.
Pocket Word, Excel, Access, PowerPoint, Internet Explorer, Inbox, Calendar, Contacts, Tasks	<b>Microsoft Windows CE for the Handheld PC Highlights</b> <a href="http://support.microsoft.com/support/default.asp?PR=wce&amp;FR=0&amp;SD=SO&amp;">http://support.microsoft.com/support/default.asp?PR=wce&amp;FR=0&amp;SD=SO&amp;</a>
Connecting to Internet Service Providers	<b>Chris De Herrera's Windows CE Website ISP Settings</b> <a href="http://www.cewindows.net/wce/isp.htm">http://www.cewindows.net/wce/isp.htm</a>

---

## Help Resources

Item	Resource
Software and Hardware Resources	<b>Microsoft Windows CE for the Handheld PC Resource Guide</b> <a href="http://windowsce.resourceguide.net">http://windowsce.resourceguide.net</a> (For PC cards, Compact Flash cards, network adapters, wireless modems, software, and more.)  <b>Microsoft Windows CE for the Handheld PC Product Locator</b> <a href="http://windowsce.microsoft.com/reftool/search/s_hsw.asp">http://windowsce.microsoft.com/reftool/search/s_hsw.asp</a>
MobilePro Accessories <sup>1</sup>	<b>NEC Computers Inc. Accessories</b> <a href="http://www.nec-computers.com/accessories_category.asp">http://www.nec-computers.com/accessories_category.asp</a> <sup>2</sup>
MobilePro Technical Support, Warranty Service <sup>1</sup>	<b>NEC Computers Inc. MobilePro Support</b> <a href="http://support.neccsdeast.com/common/csdnew.asp">http://support.neccsdeast.com/common/csdnew.asp</a>  <b>NEC Computers Inc. Support Telephone Numbers</b> 800-632-4525, fax: 801-981-3133
MobilePro Homepage	<b>NEC Computers Inc. MobilePro Home</b> <a href="http://www.nec-computers.com/store/product_line.asp?prod_line_no=4">http://www.nec-computers.com/store/product_line.asp?prod_line_no=4</a> <sup>2</sup>

<sup>1</sup> For U.S. and Canada only. If you purchased and are using this computer outside the U.S. and Canada, then a local service may apply. Contact a local NECC dealer in your country.

<sup>2</sup> World Wide Web address subject to change.

# 2

## **Introducing the NEC MobilePro**

- Identifying System Features
- Opening the Display Panel
- Using the Stylus
- Using the MobilePro's Power Sources
- Caring for the MobilePro

---

# Identifying System Features

The NEC MobilePro 880 is compact with features on every side. The next few sections provide figures and feature descriptions.

## *Around the Front of the System*

The following sections describe front features beginning with the display panel.

### *Display Panel*

Your NEC MobilePro 880 comes with a 9.4-inch display panel that you can adjust for a comfortable viewing position. See the section, “Making Display Panel Adjustments,” in Chapter 4, for information about adjusting the panel brightness.

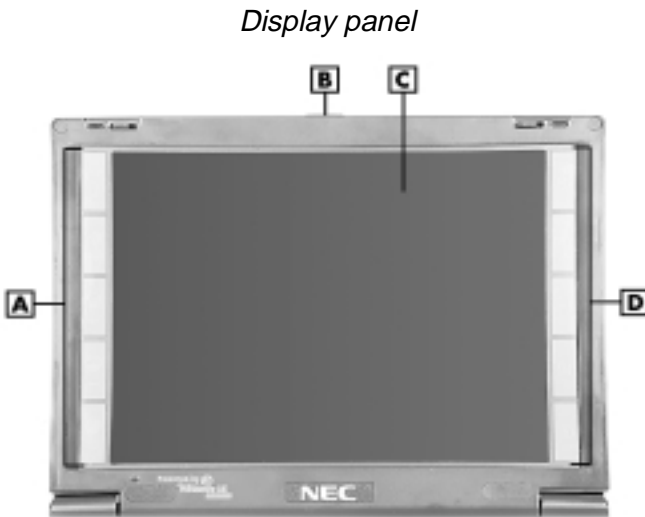

**A** – System Information icons   **B** – Display panel latch   **C** – Display panel  
**D** – User software icons

- 
- System Information Icons — provide direct access to the following system functions:
    - World Clock
    - MobilePro Settings
    - Battery/Power Status
    - System Memory
    - Volume Control
  
  - Display Panel Latch — secures the display panel when it is closed.
  
  - Display Panel (with built-in touch screen) — provides a clear view of information stored or input into the unit. The touch screen lets you activate functions by touching the screen with the stylus or your fingertip.
  
  - User Software Icons — allow you to configure direct access to five system functions or programs of your choice. For details about defining these icons, refer to the section, “Adjusting MobilePro Settings,” in Chapter 4.



---

## Keyboard Panel and Base Unit

The NEC MobilePro keyboard panel and base unit provide the features shown in the following figure. Features are described after the figure.

*Keyboard panel and base unit*

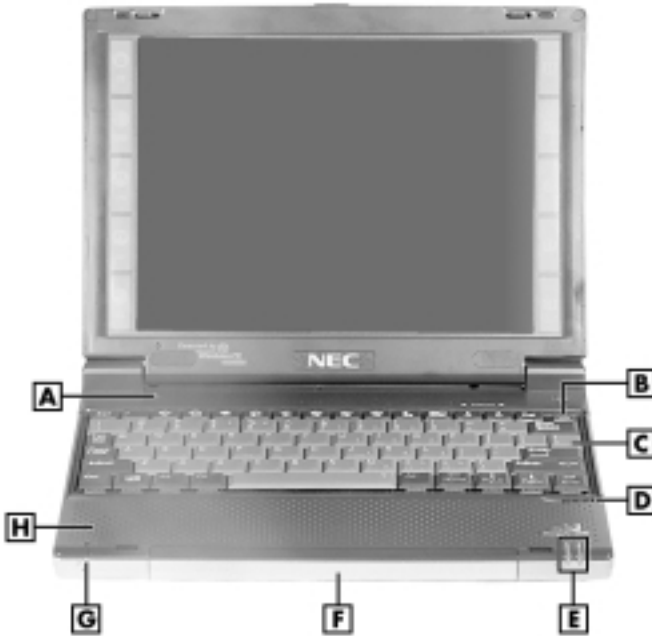

**A** – Suspend switch   **B** – Power button   **C** – Keyboard  
**D** – Stylus   **E** – Status LEDs   **F** – Main battery pack  
**G** – Microphone   **H** – Speaker

- Suspend Switch — Shuts off the backlight when the LCD panel is closed. Puts the MobilePro into a suspend state when the lid is closed (if enabled in MobilePro Settings).
- Power Button — allows you to power on and off the unit when it is open.

- 
- Keyboard — lets you enter data with your fingertips.
  - Stylus — a “pen” that serves as an input device for the touch screen. Remove the stylus from its holder to use it.
  - Status LEDs — keeps you informed of the system's power status and notifies you about scheduled appointments.

### *Status LEDs*

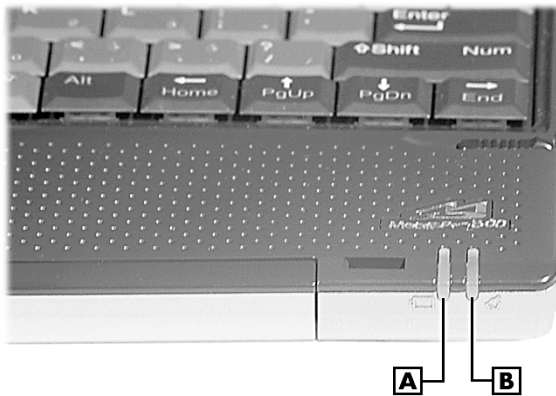

**A** – Battery Charging LED   **B** – Notification LED

#### — Battery Charging LED

- lights amber when the battery is charging.
- lights green when the battery is fully charged.

#### — Notification LED — flashes amber as a reminder of appointments, pages, etc.

- Main Battery Pack — provides battery power to the NEC MobilePro when away from an AC power source.
- Microphone — lets you record your voice.

- 
- **Speaker** — lets you listen to digital audio. You can program MobilePro audio to remind you of appointments, notify you of operation events, or play application-associated sounds.

## ***Around the Back of the System***

The back of the NEC MobilePro offers the features shown in the following figure. Features are described after the figure.

*Features on the back of the system*

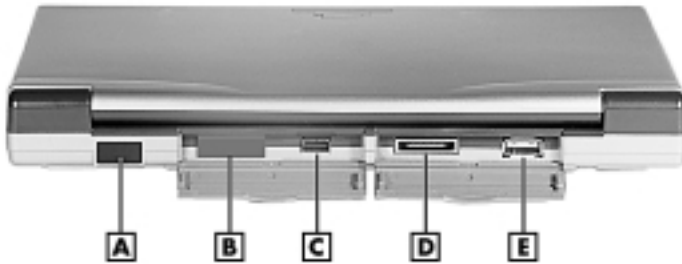

**A** – IR port   **B** – Not used   **C** – VGA port  
**D** – Serial port   **E** – USB port

- **Infrared (IrDA) Port** — allows the MobilePro to communicate without cables with similarly equipped devices, including other MobilePros.
- **Not used in some models.**
- **VGA Port** — provides a connection point for the VGA cable, for use with an external monitor.
- **Serial Port** — provides a connection point for the PC Connect cable.

- 
- **USB Port** — allows you to connect a USB mouse to your NEC MobilePro.

## ***Around the Left Side of the System***

The left side of your NEC MobilePro offers the features shown in the following figure. Features are described after the figure.

*Left side features*



**A** – AC power port   **B** – PC card slot   **C** – PC card eject button  
**D** – Earphone microphone jack

- **AC Power Port** — lets you connect the AC adapter to run your unit on AC power.
- **PC card Slot** — lets you install one Type I or Type II PC card.
- **PC Card Eject Button** — allows you to remove an installed PC card.
- **Earphone Microphone Jack** — lets you connect the earphone microphone accessory to your NEC MobilePro.

---

## ***Around the Right Side of the System***

The right side of your NEC MobilePro offers the features shown in the following figure. Features are described after the figure.

*Right side features*

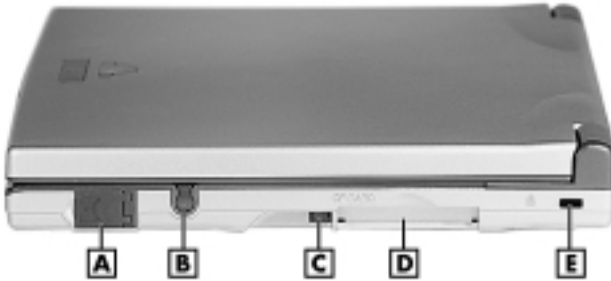

**A** – Modem port   **B** – Stylus slot   **C** – CompactFlash card eject button  
**D** – CompactFlash card slot   **E** – Kensington lock

- **Modem Port** — provides connection access to the internal modem using the RJ-11 telephone cable.
- **Stylus Slot** — houses the unit's pointing device.
- **CompactFlash Card Eject Button** — allows you to remove an installed CompactFlash card.
- **CompactFlash Card Slot** — lets you install one CompactFlash card.
- **Kensington® Lock** — provides additional security with the installation of a Kensington Lock.

---

## ***Around the Bottom of the System***

The bottom of the NEC MobilePro offers the features shown in the following figure. Features are described after the figure.

*Features on the bottom of the system*

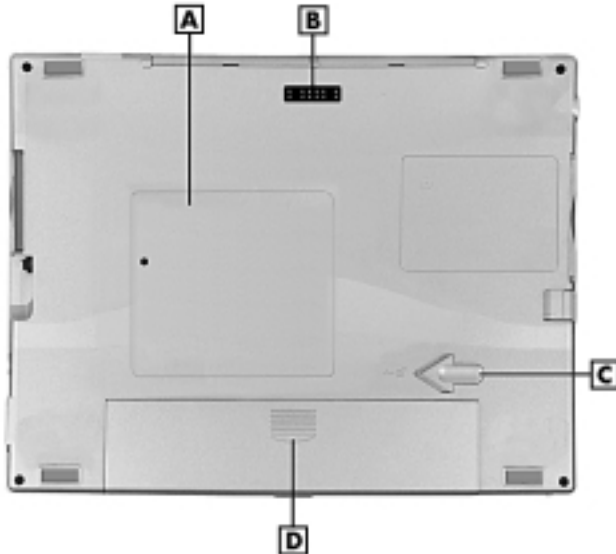

**A** – ROM/RAM bay cover   **B**– Docking cradle connector  
**C** – Battery release latch   **D** – Lithium-Ion battery pack

- ROM/RAM Bay Cover — protects the ROM/RAM bay and the installed ROM/RAM modules.
- Docking Cradle Connector — allows you to connect the NEC MobilePro to a Docking Cradle.
- Battery Release Latch — allows you to release and remove the battery.

- 
- **Lithium-Ion Battery Pack** — provides battery power to the NEC MobilePro when away from an AC power source.

## ***Opening the Display Panel***

Follow these steps to open the display panel.

1. Slide the display panel latch to the right.
2. Lift the display panel up and towards the back of the system.



### **CAUTION**

When the NEC MobilePro is not in use or when you are carrying it, keep the display panel closed. This helps prevent accidental damage to the touch screen or keyboard.

Dropping the MobilePro may cause display panel damage.

---

## ***Using the Stylus***

Follow these steps to use the stylus.

1. Open the MobilePro display panel.
2. Locate the stylus holder on the lower right of the base unit. To remove the stylus, slide it away from the unit.



## CAUTION

Although you can use your fingertip to activate the touch screen, never use hard-pointed or sharp objects. These objects can damage the touch screen.

---

3. Gently touch the pointed tip of the stylus to the screen to select an object. When you are done using the stylus, return it to its convenient holder in the MobilePro.

## ***Using MobilePro's Power Sources***

The NEC MobilePro 880 can be powered using the AC adapter or the system's main battery, making it a truly portable system. The MobilePro also contains an internal data backup battery that recharges whenever the unit is connected to an AC power source. Read the following sections for information about using the NEC MobilePro's power sources.

### ***Determining Battery Status***

You can determine battery status by using the battery icon on the left side of the display panel or through the power icon on the lower right side of the taskbar. The icon on the taskbar displays as an electrical plug when the battery is fully charged (battery charging LED lights green) or as a battery while charging (battery charging LED lights amber).

To display battery status, use one of the following methods:

- Tap the battery icon on the left side of the MobilePro display panel.
- Double tap the battery/plug icon on the taskbar, if present.



---

## **Recharging the Main Battery Pack**

The main battery pack contains rechargeable Lithium-Ion cells. Recharge a battery pack when the system displays a low battery warning.

To recharge a battery pack installed in the battery bay, connect the AC adapter. See “Connecting the AC Adapter” in Chapter 1.

The battery charging LED indicates the charging status of the main battery pack when the NEC MobilePro is connected to an AC power source. The LED status displays as follows:

- Lights amber while charging.
- Lights green when fully charged.

It takes approximately 4.5 hours to recharge a fully depleted battery pack regardless of the system's power state. However, if the main battery has been depleted for a prolonged period, you must also allow time for the backup battery to fully recharge (see the section, “Recharging the Backup Battery”).

---

 **Note:** Through normal use, the capacity of a battery pack gradually declines. Depending upon use, a battery pack should recharge from full depletion approximately 300 times during the life of the battery. Should you notice that the battery does not stay charged as long as expected, it is probably necessary to replace the battery with a new one. Please refer to the section “Battery Replacement” later in this chapter.

---

---

## ***Recharging the Backup Battery***

The backup battery charges while the main battery is charging. It usually takes approximately 4.5 hours to recharge both the main and backup batteries together.

A full 10 hours charging time is required under either of these circumstances:

- this is the first time you have used your MobilePro
- the main battery has been in a depleted state for a prolonged period.

In these cases allow ten hours for both the main and backup batteries to charge, even if the LED indicator on the front of the MobilePro lights green before the full ten hours are passed.

To protect your data, do not use the system until the backup battery is charged.

To recharge the main and backup batteries, connect the AC adapter. See the section, “Connecting the AC Adapter” in Chapter 1.

## ***MobilePro Power Management***

When your MobilePro is connected to an AC power source and the main battery is removed from the system, be sure to replace the main battery before disconnecting the AC adapter to prevent *possible data loss*.



## CAUTION

The MobilePro's internal data backup battery provides power to maintain the memory contents for a limited period of time when the main battery is removed and the unit is not connected to an AC power source. The backup battery does not provide sufficient power to operate the system.

Do not remove the main battery from the unit for an extended period of time unless the unit is connected to an AC power source. The backup battery is not user replaceable.

---

## ***Battery Replacement***

Note the following when replacing batteries:

- If the main battery becomes weak, the MobilePro automatically turns off. Recharge or replace the main battery immediately if the power goes off.
- The MobilePro has a built-in backup battery that maintains your data for several hours whenever the main battery is depleted or removed. The backup battery is recharged whenever the unit is connected to an AC power source.
- If you fail to replace a depleted main battery for an extended period of time and the back-up battery is weak, the contents of the MobilePro memory and all user data may be lost.

## ***Removing and Inserting the Battery Pack***

Should you notice the life of a charged battery pack is short, replace it with a new one. Follow these instructions to replace a battery pack.

- 
1. Save your data, turn off unit power, and close the display panel. Disconnect any cables attached to the unit, such as the serial cable.

---

 **Note:** If you receive messages indicating that both the main battery and the backup battery are very low, immediately connect the AC adapter to charge both batteries.

---

2. Have a Lithium-Ion battery pack available.
3. Remove the battery pack as follows:
  - Locate the release latch on the bottom of the system.
  - Slide the release latch in the direction of its arrow and hold it.
  - Remove the battery from its bay.

*Removing the battery pack*

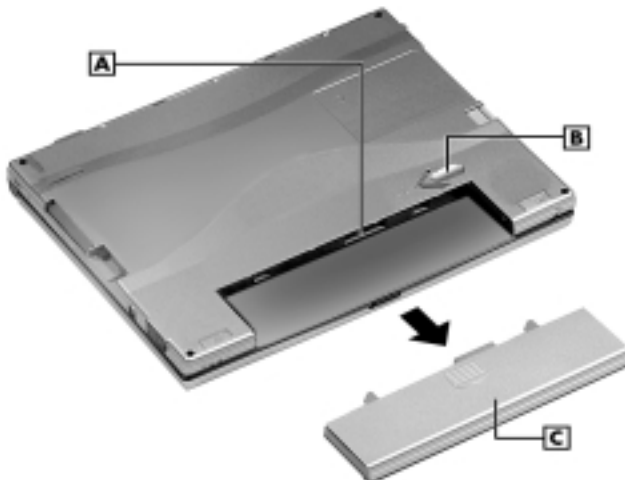

A – Battery connectors B - Battery release latch C - Lithium-Ion battery pack

---

4. Insert a new battery pack as follows:

- Insert the new Lithium-Ion battery pack in the bay and slide the battery in the direction of the arrow, as indicated in the following figure.

*Inserting the battery pack*

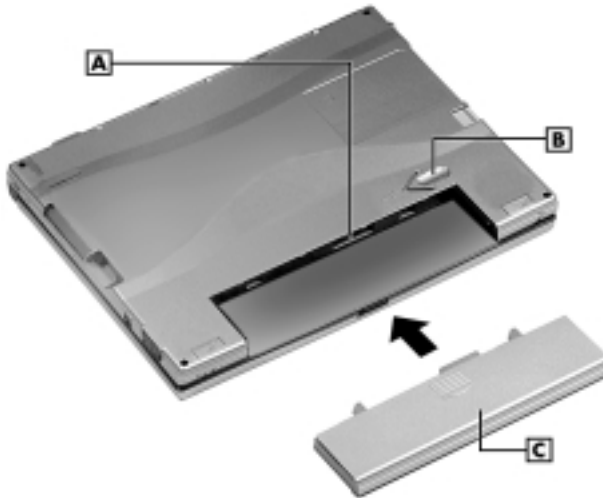

**A** – Battery connectors **B** - Battery release latch **C** - Lithium-Ion battery pack

- Firmly press the battery until it is securely connected in the bay.
5. Charge the battery. See the sections earlier in this chapter, "Recharging the Main Battery" and "Recharging the Backup Battery."

---

## **Battery Precautions**

Read the following battery handling precautions to ensure your safety.

---

### **WARNING**

Adhere to these warnings when handling batteries. Failure to do so may result in personal injury.

- There is a danger of explosion if the battery is incorrectly replaced. Replace only with the same type recommended by the manufacturer.
  - Discard used batteries according to the manufacturer's instructions. Never dispose of batteries by burning them.
  - Dispose of used batteries promptly.
  - Keep batteries away from children.
  - Do not subject batteries to impact.
  - Do not subject batteries to heat sources including direct sunlight, open fires, microwave ovens, and high-voltage containers.
  - Do not recharge batteries unless they are specifically designed for recharging.
  - Do not disassemble batteries.
  - Do not solder or puncture batteries.
  - Do not use a battery that is damaged or deformed, has any rust on its casing, is discolored, overheats, or emits a foul odor.
-

---

# ***Caring for the MobilePro***

The NEC MobilePro is a durable, dependable unit built for extensive use and travel. Follow these guidelines to maintain the condition and performance of your MobilePro.



## **CAUTION**

Immediately turn off and unplug the MobilePro under the following conditions:

- The power cord is damaged or frayed.
  - Liquid spills on or into the unit.
  - Someone drops the unit or damages the casing.
- 

## ***Precautions***

Follow these precautions when using your MobilePro and AC adapter.

- Always plug the AC adapter cord into an easily accessible outlet. It is important to be able to easily shut off power by unplugging the AC adapter if needed.
- Avoid dropping or bumping the MobilePro or the AC adapter.
- Do not stack heavy objects on the MobilePro or the AC adapter.
- When using the AC adapter, make sure the power source falls within the unit's compatible range of 100-240 volts AC. Never use the AC adapter if the voltage falls outside of this range. (Watch for this when traveling to other countries.)

- 
- Turn off the MobilePro power before attaching or removing devices.
  - Do not push any foreign objects into the MobilePro bays, connectors, and slots.
  - Avoid using the unit or AC adapter for extended periods in direct sunlight.
  - Do not use the unit in humid or dusty environments.
  - Turn off the MobilePro power before cleaning the system.
  - Avoid exposing the MobilePro or AC adapter to extreme changes in temperature or humidity. If it is unavoidable, allow your MobilePro to adjust to room temperature before use.
  - When cleaning the system, use a soft, clean, slightly damp, almost dry cloth. Avoid wiping the display surface with abrasive material, including rough fabric. Do not use a cleaning solution; this may damage the plastic.
  - If the AC adapter becomes extremely hot, unplug the adapter and let it cool.
  - Keep the AC adapter away from the IrDA port to ensure stable communication/transfer operations.

## ***Storage Requirements***

Store the NEC MobilePro and AC adapter in an environment that meets the following conditions.

- Maintain storage temperatures between 14°F and 140°F (-10°C and 60°C).





## CAUTION

If the temperature of the NEC MobilePro suddenly rises or falls (for example, when you move the system from a cold place to a warm place) vapor condenses inside the system. Turning on the unit under this condition can damage the internal system components.

Before turning on the NEC MobilePro, wait until the unit's internal temperature equalizes with the new environment and any internal humidity evaporates.

---

- Keep the storage area free from vibration and magnetic fields.
- Keep the MobilePro and its components away from organic solvents or corrosive gases.
- Avoid leaving the MobilePro and its components in direct sunlight or near heat sources.

## ***Routine Cleaning***

Clean or dust your system as follows.



## CAUTION

Never use harsh solutions, household cleaners, or spray cleaners that contain caustic materials on the MobilePro.

These cleaners are usually high in alkalinity, which is measured in pH. Using these cleaners can cause the plastic surface to crack or discolor.

---

- 
- Display screen — Carefully wipe the LCD screen with a soft cloth or a screen wipe designed for that purpose. Special screen wipes are available through your local computer dealer.
  - Unit case — NECC recommends that you carefully wipe the case with a slightly damp, almost dry cloth.

# 3

## **Introducing Windows CE**

- Windows CE Operating System
- Microsoft ActiveSync
- Software Applications
- Online Help

---

# ***Windows CE Operating System***

Windows CE is the smallest member of the Windows operating system family using the Windows 95 interface. What exactly does smallest mean? It means mobility and portability provided through a reduced code base. This code base is completely 32-bit; it is multithreaded, multitasking and runs on different processors such as the NEC VR4121 MIPS processor.

Your MobilePro does not have a hard disk drive. The operating system and preloaded applications are deployed on a Read-Only Memory (ROM) module; files that you work on are stored in Random Access Memory (RAM) on a RAM module.

The power of Windows CE is enhanced through its design to easily link with your host PC to synchronize your data. For more information about setting up your MobilePro for synchronization, see the section, “Connecting to Your PC,” in Chapter 1.

## ***Using Windows CE***

Windows CE is similar to Windows 95. However, some actions are executed differently, as indicated in the following sections.

### ***Tapping***

Your NEC MobilePro comes with a stylus, a pen-like device that allows you to touch, tap, or double tap objects on the MobilePro touch screen. The touch, tap, and double tap act just like a point, click, and double click of a mouse.

---

To simulate the click of the right mouse button, hold down the **Alt** key while you tap or drag the object with the stylus.

Finally, never use a metal object in place of the stylus. Metal objects may scratch the surface of the touch screen.

### *Selecting Objects*

You can select objects in Windows CE by tapping the object(s) with the stylus. To select multiple contiguous items, hold down the **Shift** key while tapping the first and last items. To select multiple non-contiguous items, hold down the **Ctrl** key while tapping each item.

To move the blinking cursor while editing text in a program, simply tap the screen at the desired (new) location.

### *Dragging and Dropping*

Dragging and dropping works just like in Windows 95. To drag an object, tap the object with the stylus and hold the stylus against the screen. Continue to hold as you slide the object across the screen. Lift the stylus from the screen when the object is in the desired location.

To copy an object, simply hold down the **Ctrl** key as you drag the object, as indicated in the previous section.



- 
- Internet Explorer — Provides web access once you are connected to the Internet via the MobilePro's built-in modem and an internet service provider.
  - Inbox — Allows you to send and receive email messages on your NEC MobilePro. Refer to Chapter 5, “Setting Up a Remote Connection,” for details about configuring your MobilePro to send and receive email.
  - Calendar — Lets you schedule appointments, meetings, and other events and provides a variety of ways to display the stored information.
  - Contacts — Maintains a list of names, both business and personal, for easy access while at home or on the road.
  - Tasks — Provides a portable “to do” list for keeping track of all of your tasks.
  - Microsoft Pocket Word — Allows you to create and edit documents on your MobilePro.
  - Microsoft Pocket Excel — Allows you to view or draft spreadsheets.
  - Microsoft Pocket PowerPoint — Lets you quickly and easily deliver a professional online presentation.
  - Microsoft Pocket Access — Allows you to access and synchronize information from other data bases.
  - Microsoft Voice Recorder — Allows you to record voice memos.
  - NEC Where to Get Help — Provides a comprehensive list of help resources for your MobilePro, the software, connections, and more.
  - MobilePro Fax — Allows you to send and receive faxes.

- 
- bUseful Backup Plus — Allows you to backup and restore your MobilePro data.
  - bUseful Script — Allows you to automate tasks such as logging on to an ISP, retrieving email, and more.

---

 **Note:** The bUseful Scripts provided in ROM are for example, only. Before using the scripts, modify the scripts to suit your own needs.

---

In addition, your NEC MobilePro includes additional utilities accessible through the Start, Programs menu.

- ASL Connect Client for Windows CE — Provides automatic backup, restore, and synchronization features.
- Citrix ICA Client — Provides a setup wizard to configure the Citrix ICA thin client for connectivity to the MetaFrame server component.

### *Pocket Applications*

While Windows CE applications do not have all the features you may expect to see in applications on other Windows systems, these applications provide many powerful features adapted for the mobile environment.

Your MobilePro, with its larger keyboard, highly visible display, and longer battery life, allows you to obtain full advantage of the CE-based applications. Write complete, well-formatted reports, take detailed notes, and work on spreadsheet data as you travel.

Microsoft provides a complete suite of applications ready for you to use. These applications are available as a desktop icon or accessible through Start, Programs in the Accessories, Communication, or Games folders.



- 
- **Calendar** — Allows you to track your appointments and create meeting requests.
  - **Contacts** — Lets you store important information about your friends and colleagues.
  - **Inbox** — Allows you to send and receive email.
  - **Tasks** — Gives you a place to create a portable "to do" list.
  - **Microsoft Pocket Access** — Provides a data base program for the mobile professional allowing you to update and query data while you are on the road.
  - **Microsoft Pocket Excel** — Provides spreadsheet and data base functions for budgeting and other data tasks.
  - **Microsoft InkWriter<sup>®</sup>** — Lets you create handwritten or typed notes and drawings.
  - **Microsoft Pocket PowerPoint** — Provides an easy, portable solution for desktop presentations.
  - **Microsoft Voice Recorder** — Provides an easy way to quickly capture thoughts, reminders, ideas, and phone numbers.
  - **Microsoft Pocket Word** — Provides many features of Microsoft Word including document formatting and spell-checking. Copy documents from your host PC for editing or draft documents on your MobilePro for later completion on your host PC.
  - **ActiveSync** — Lets you initiate synchronization with your host PC.
  - **PC Link** — Allows you to initiate a connection with your host PC.

- 
- Remote Networking — Allows you to configure remote access accounts for connecting to your ISP, your local area network, and more.
  - Terminal — Lets you view and download files from a bulletin board or to send and receive email.
  - World Clock — Allows you to set the time, date, and alarm for your home city and a city that you are visiting.
  - Solitaire — Provides entertainment while on the road.

For more information about each of the applications, just click the question mark or select the help button when using each application.

You can also use many other applications with Windows CE for faxing and data transfer. A number of these are on your Bonus Software CD. See the section later in this chapter, “Software Applications,” for more information.

## ***Printing Features***

Windows CE provides printing capability using Hewlett-Packard (HP) PCL Level 3 and compatible printing devices that support serial or infrared connection. Using a serial cable or infrared transfer you can print a variety of high-quality documents directly from the MobilePro including:

- Pocket Word and Pocket Excel files
- Contacts and Task lists
- A view of your schedule or agenda in Calendar
- Inbox messages

---

Follow these steps to print documents using your MobilePro.

1. Open the desired Pocket application.
2. Tap File and tap Print.  
The print dialog box appears.
3. Select the appropriate printer setting, “PCL Laser,” “PCL Inkjet,” or “MobilePro Fax.”
4. Select the appropriate port setting, COM1 : 57600, COM1 : 9600, IrDA, LPT1, or Network.
5. Select other printing attributes as required.
6. Tap OK.

---

 **Note:** See the Bonus Software CD for installation and use of a wider range of high-speed printer drivers.

---

---

 **Note:** With the optional printer cable (MC-RC3E) connected to the serial port of your NEC MobilePro, you can print to a supported, high-speed parallel printer.

For information about MobilePro accessories, access the web site [www.nec-computers.com](http://www.nec-computers.com).

---

For additional details about using the IR port for printing and transferring data, refer to the section, “Using the IR Port,” in Chapter 4.

---

## ***Network Capabilities***

Your MobilePro takes full advantage of the networking capability offered through Windows CE and the PC card port. The operating system supports Ethernet LAN and serial line interface protocol (SLIP) used with Cellular Digital Packet data (CDPD) so you can have cable- or wireless-based network communications using an Ethernet LAN PC card. In addition, you can use CompactFlash type II Ethernet cards on your NEC MobilePro.

## ***Creating a Network (Ethernet) Connection***

To create a network (Ethernet) connection, you must install and configure an Ethernet card. The drivers for the card may already exist on your device. NECC also has included drivers for the Proxim RangeLAN2.

- 1.** Insert the Ethernet card into your device and connect it to your network cable. You must have an NE2000-compatible Ethernet card, one of the wireless Ethernet cards described above, or have installed drivers supplied with the card.

You may see a message warning about battery power. If you have an A/C adapter, plug it into your device.

- 2.** In the Settings dialog box, enter the information for your server. Most networks use DHCP, so you should not have to change these settings. See your network administrator if you need assistance.

If the Settings dialog box does not appear, go to Start, Settings, Control Panel, and double tap Network. Select your Ethernet driver, select Properties, and configure the appropriate settings.

- 
3. Tap OK, twice, select the Identification tab, and enter your name, password, and domain. Click OK, then close the Control Panel.
  4. Remove and reinsert the Ethernet card when prompted.

Once you have configured your Ethernet connection, use Internet Explorer on your MobilePro to surf the net or to send and receive email. For details about configuring email, see Chapter 5, "Setting Up a Remote Connection."

## ***Microsoft ActiveSync***

The Windows CE operating system and your MobilePro provide a powerful, portable extension to your host PC. This PC-companion capability comes through the Microsoft ActiveSync software.

Microsoft ActiveSync provides the communication link between your MobilePro and host PC. The ActiveSync technology provides synchronization between files on your MobilePro and host PC keeping up-to-date copies of email and documents in both locations.

You can also backup and restore data and files and install new applications using Microsoft ActiveSync. For additional information about Microsoft ActiveSync, double click the ActiveSync desktop icon on your host PC that appears after installing ActiveSync.

---

## ***Backing Up and Restoring Data***

To prevent data loss, frequently back up your NEC MobilePro data. You can backup all data to your host PC in two convenient ways.

- Use Microsoft ActiveSync on your host PC.
- Use the bUseful Backup Plus application on your MobilePro desktop.

### ***Using Microsoft ActiveSync***

The Microsoft ActiveSync backup and restore feature creates a complete duplicate of all data stored on your NEC MobilePro. If you routinely connect to your host PC, this is the best method of data backup. The backup file is saved on the hard disk of your host PC.

When you restore data from a backup file created by Microsoft ActiveSync, all data on your NEC MobilePro is replaced by the data in the backup file. All data on your MobilePro is overwritten including files you created, settings that you changed or programs that you installed since the last backup.

To access the Microsoft ActiveSync backup feature, double click the ActiveSync icon on your host PC. Click Tools, then click Backup/Restore. Follow the on-screen instructions to complete the backup process. For more information about Microsoft ActiveSync backup and restore, see the online Help file.

---

## *Using bSQUARE® bUseful™ Backup Plus*

bUseful Backup Plus provides a convenient way for you to back up or restore your MobilePro data while traveling or away from your host PC. Back up data to a PC card or CompactFlash card for secure storage.

Follow these steps to use bUseful Backup Plus to backup or restore files.

- 1.** Double tap the bUseful Backup Plus icon on your MobilePro desktop.
- 2.** Select the backup or restore option when the backup wizard appears and click Next.
- 3.** Select the type of backup or restore that you want and click Finish.
- 4.** Click Browse and enter the name of the file(s) that you wish to backup or restore.
- 5.** Click OK, twice, to initiate the backup or restore.

For more information about bUseful Backup Plus, see the online Help file.

---

# Software Applications

A variety of software applications are provided on the Bonus Software CD that ships with your NEC MobilePro 880. These applications let you take full advantage of your MobilePro capabilities.

## Using the Bonus Software CD

Use the Bonus Software CD to install your choice of the included software applications. Your NEC MobilePro does not include a CD-ROM drive. The Bonus Software CD is designed for use on your host PC. Before installing the software applications from the Bonus Software CD, first connect your MobilePro to your host PC. When you install an application to the host PC, the installation process automatically installs the application to your NEC MobilePro.



**Note:** Before using the Bonus Software CD to install additional applications, you must first install Microsoft ActiveSync on your host PC.

---

Follow these steps to use the Bonus Software CD.

1. Insert the Bonus Software CD to the CD-ROM drive in your host PC.
  - If auto insert is enabled on your host PC, the CD automatically plays and the introduction screen appears.
  - If auto insert is not enabled, tap Start, Run, browse for the CD-ROM drive, and run the setup file.
2. Move your cursor over the application list at the left side of the screen to select an application for installation.



- 
3. Click the selected application title to initiate the installation program.
  4. Read the license agreement, that only appears the first time that you launch the Bonus Software CD, and click OK.
  5. Follow the on-screen instructions to install the software applications.

---

 **Note:** When installing some applications from the NEC Bonus Software CD using a Windows NT host PC, the installation process may proceed slowly. The progress bar that appears on the screen during installation may seem to stop for a period of 30 to 90 seconds. Be patient! This is normal and the installation process will complete successfully.

---

Once installed on your NEC MobilePro, the software application is stored in RAM. Refer to each application's online help for details about how to use the application.

---

 **Note:** Be sure to keep your main battery pack charged to maintain all applications stored in RAM.

If your main battery pack loses its charge, applications stored in RAM may be lost. Once lost, you must reinstall the desired software applications.

---

---

## ***Online Help***

Your NEC MobilePro and Windows CE provide a variety of online help resources. In addition, Microsoft ActiveSync on your host PC provides its own online help file.

Follow these instructions to find your online help resources.

- **NEC Where to Get Help**— Double tap the NEC Where to Get Help icon on your MobilePro desktop.
- **MobilePro Accessories**— Tap Start, Help, and double tap the MobilePro Accessories link.
- **Windows CE Main Help** — Tap Start, then Help on the Windows CE taskbar.
- **Application-specific Help** — Just tap the question mark in the upper right-hand corner of the taskbar in each of the Pocket applications.
- **Microsoft ActiveSync Help** — On your host PC, double click the ActiveSync desktop icon, click Help, and select the Microsoft ActiveSync Help Topics.

# 4

## Using the NEC MobilePro

- Powering On and Off
- Making Display Panel Adjustments
- Using the Keyboard
- Adjusting MobilePro Settings
- Using the Voice Recorder
- Using PC Cards
- Using CompactFlash Cards
- Using the IR Port
- Upgrading ROM
- Resetting the MobilePro

---

# Powering On and Off

Power on the NEC MobilePro as follows.



## CAUTION

Do not attach a USB mouse to the MobilePro system before powering on the system for the first time. If the USB mouse is connected, it prevents you from calibrating the touch screen.

---



## CAUTION

If you power off, then quickly power on the NEC MobilePro, your system may erroneously report the presence of CompactFlash cards.

In addition, repeatedly powering off and quickly powering on, may cause data loss. NECC recommends that you wait ten seconds after powering off, before powering on the NEC MobilePro.

---

1. Slide the display panel latch to the right. Lift the display panel up towards the rear of the unit.



## CAUTION

Do not push the display panel beyond its pre-designed stop point as you open the panel.

---

- 
2. Locate and press the Power button. To power off the unit, press the Power button a second time.

*Powering on and off*



A – Power button

---

 **Note:** The first time you install the main battery, the MobilePro automatically powers on when you open the display panel.

The first time you power on the MobilePro, the screen contrast may need adjustment. Refer to the following section, “Making Display Panel Adjustments,” for details.

---

If the MobilePro is not used for a specific length of time, it automatically shuts off. You can select how long the unit remains on, when running on battery power, through the Power selection in the Windows CE Control Panel. On the Windows CE desktop, tap Start, Settings, then select Control Panel. Double tap the Power icon and select the Power Off tab to designate a power off time.

---

 **Note:** As a general operation rule, frequently back up and synchronize data between your MobilePro and your host PC.

Synchronization occurs each time you connect your MobilePro to your host PC, once initial synchronization is configured. For details, see, “Connecting to Your PC,” in Chapter 1.

For details about backing up and restoring data, see the section, “Backing Up and Restoring Data,” in Chapter 3.

---

## ***Making Display Panel Adjustments***

You can adjust the brightness of the display panel in the NEC MobilePro using two function keys located at the top right of the keyboard. *Increasing panel brightness can dramatically lower battery life.*

Follow these steps to adjust the display panel brightness.

1. Open the display panel and power on the unit.

- 
2. Press the brightness up or brightness down keys as required.

### *Adjusting the brightness*



A – Brightness up B – Brightness down

## ***Backlight***

You can conserve battery life by configuring your NEC MobilePro to automatically turn off the display panel's backlight.

### *Automatic Off*

Follow these steps to configure the backlight for automatic turn off.

1. Tap Start, Settings, then select Control Panel.
2. Double tap the Display icon and select the Backlight tab.

- 
3. Tap the desired selections to place a check beside the selection. Use the dropdown boxes to select the desired time settings.

### *Backlight settings*

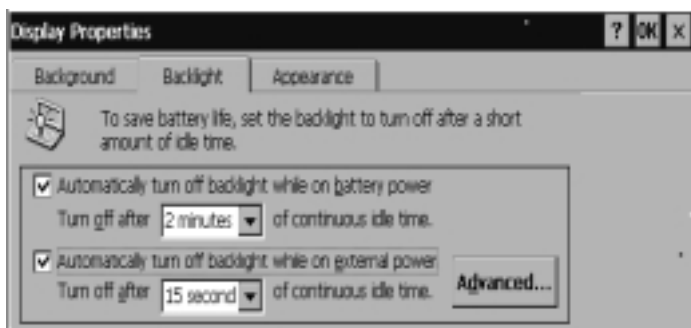

### *Automatic On*

In addition, you can configure the NEC MobilePro to turn on the backlight automatically. Follow these steps to configure the backlight for automatic turn on.

1. Tap the Advanced tab, shown in the previous figure, to access the Advanced backlight settings.



- 
2. Tap the desired selections to automatically turn on the backlight either while on battery power or when connected to an AC power source.

*Advanced backlight settings*

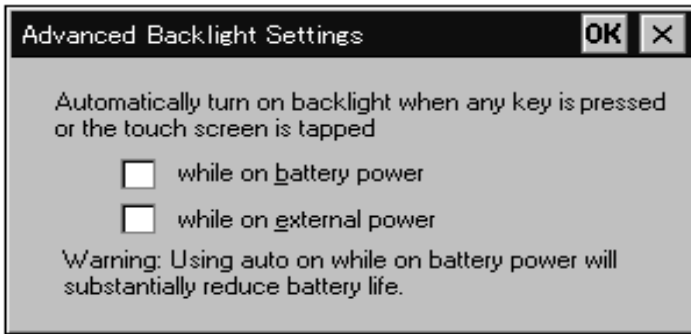

---

**! WARNING**

Using auto on while on battery power substantially reduces battery life.

---

## ***Enabling the Suspend Switch***

You can configure your NEC MobilePro to power on or off by simply opening or closing the display cover. The Suspend switch acts as a switch for both the power and the display panel.

Opening the NEC MobilePro powers on the unit. To power on the unit while it is open, use the Power button.

Closing the MobilePro powers off the unit and insures that the backlight is off as well.

---

Follow these steps to enable the Suspend switch.

1. Tap Start, Settings, then select Control Panel.
2. Double tap the MobilePro Settings icon to launch the dialog box shown in the following figure.

Be sure to select the “LCD Suspend/Resume” tab.

*Power off settings*

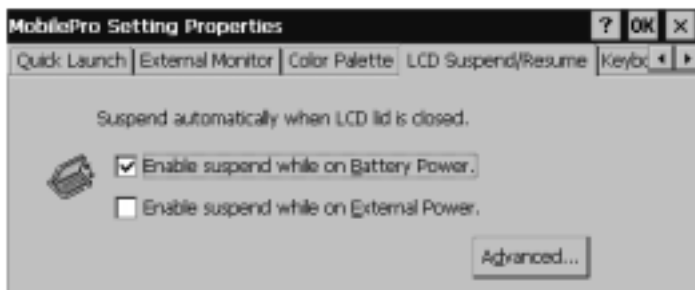

3. Select either “Enable suspend while on Battery Power” or “Enable suspend while on External Power,” or both, to enable the Suspend switch.

---

 **Note:** Your NEC MobilePro will not automatically suspend during synchronization, while running on battery power, unless the battery charge is at a very low status. You may want to connect your MobilePro to an AC power source before synchronizing with your host PC.

---

---

## Using the Keyboard

The NEC MobilePro keyboard is equipped with many features including:

- Application shortcut keys
- Brightness up/down keys
- Cursor control keys
- Control keys
- Windows key

Feature keys are located as shown in the following figure. Key operations are described after the figure.

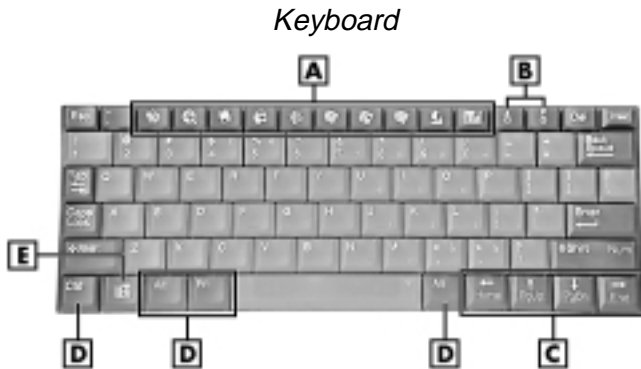

**A** - Applications shortcut keys   **B** - Brightness up/down keys  
**C** - Cursor control keys   **D** - Control keys   **E** - Windows key

- Application shortcut keys — Ten application shortcut keys allow you to launch applications directly from the keyboard. For details about each key, refer to the section that follows, “Using Application Shortcut Keys.”
- Brightness up/down keys — Use the brightness up/down keys to adjust the NEC MobilePro's panel brightness.

- 
- **Cursor Control Keys** — Cursor control keys let you position the cursor on the screen where you want. The cursor indicates where the next typed text is inserted.
  - **Control Keys** — **Ctrl**, **Alt**, **Fn**, and **Shift** are controls used in conjunction with other keys to change their functions. To use control keys, press and hold the Control key while pressing another key.
  - **Windows Key** — You can use the Windows key to display the Start menu.















## ***Using Application Shortcut Keys***

The NEC MobilePro provides application shortcut keys located at the top of the keyboard. Use these keys to launch applications directly from the keyboard. The key defaults are listed in the following table.

---

## ***Default Application Shortcut Keys***

---

<b>Icon</b>	<b>Application</b>
	Inbox
	Microsoft Internet Explorer
	Calendar
	Contacts
	Tasks
	Microsoft Pocket Word
	Microsoft Pocket Excel
	Microsoft Pocket PowerPoint
	Voice Recorder
	Microsoft Pocket Access
Ctrl + 	
	Calculator
	Brightness Up
	Brightness Down

---

---

## ***Default Function Keys***

In addition to the application shortcut keys, your NEC MobilePro is equipped with default function keys as described in the following table.

### ***Default Function Keys***

<b>Key</b>	<b>Function</b>
Fn + Space	Backlight On/Off
Fn + Shift	Num Lock
Fn + 4	Pound Key
Fn + 5	Euro
Alt + <	Contrast Up
Alt + >	Contrast Down
Alt + Left Arrow	Home
Alt + Right Arrow	End
Alt + Up Arrow	PgUp
Alt + Down Arrow	PgDn

## ***Display Panel Icons***

The NEC MobilePro 880 is equipped with 10 icons that provide shortcuts to system functions and user-selected applications.

The left side of the MobilePro's display panel has five system information icons that provide shortcut access to the following functions:

- World Clock
- MobilePro Settings
- Battery/Power Status
- System Memory
- Volume Control

---

The right side of the MobilePro's display panel has five user software icons that provide shortcut access to five user-selected applications. To configure the user software icons, double tap the MobilePro Settings applet and select the Quick Launch tab. For more details, refer to the following section.

## ***Adjusting MobilePro Settings***

Your NEC MobilePro is equipped with a desktop icon labeled MobilePro Settings. To access MobilePro Settings, simply tap the MobilePro Settings system information icon on the left side of the display panel, to display the applet's window. For more details, simply tap the "?" to view the online help.

The MobilePro Settings applet allows you to configure a variety of properties on your NEC MobilePro and includes the following features.

- Quick Launch — Allows you to customize the user software icons.
- External Monitor — Allows you to display the same image on both the display panel and an external monitor.
- Color Palette — Lets you select a 256-color display or the default 64K color display.
- LCD Suspend/Resume — Allows you to designate a suspend option for the display panel lid, when closed.
- Keyboard Layout — Allows you to select for a U.S. or international keyboard.
- IrDA — Allows you to select the speed for IR transfer.
- Built-in Modem — Allows you to specify a country for use of the built-in modem.



## CAUTION

Select the appropriate country setting for your built-in modem to ensure compliance with the country's telephone lines. An incorrect country setting may damage your device or the telephone line.

The list of compliant countries outside the U.S. and Canada is subject to change. For the latest list of compliant countries outside the U.S. and Canada, refer to NECC's web site at [www.nec-computers.com](http://www.nec-computers.com).

---

## ***Assigning User Software Icons***

The user software icons located on the right side of the MobilePro's display panel are assigned through the MobilePro Settings applet in the Control Panel. Using this applet, you can manually assign programs to the icons, numbered 1-5.

Follow these steps to assign the user software icons.

1. Tap Start, Settings, then select Control Panel.
2. Double tap the MobilePro Settings icon to launch the dialog box illustrated in the following figure.
3. Select the Quick Launch tab, if necessary.

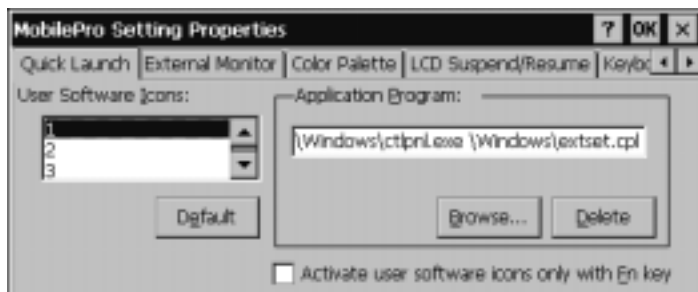



- 
4. Scroll or tap, then highlight the number of the user software icon that you want to assign. Assign an application using the following buttons.
    - Default — selects the factory-assigned application. (Shipping default for icons 1-5 is the MobilePro Settings applet.)
    - Browse — opens a directory dialog that allows you to locate the application that you want to assign.
    - Delete — removes the currently assigned application.
  5. Click OK to complete your assignments.

## ***Connecting the VGA Cable***

The VGA cable lets you connect the MobilePro directly to a MultiSync monitor that has VGA output. Use an external monitor to enhance your MobilePro display.

Follow these steps to connect the VGA cable.

1. Tap Start, Settings, Control Panel.
2. Double tap the MobilePro Settings icon and select the External Monitor tab.
3. Tap to place a check mark in the box “Display LCD on External Monitor,” and tap OK.
4. Use the soft reset button to reset the MobilePro and implement the new setting. For instructions about resetting the MobilePro, refer to the section, “Resetting the MobilePro,” in Chapter 4.
5. Power off the MobilePro.
6. Locate the VGA port cover on the back of the MobilePro and open it.

- 
7. Align and attach the connector on the MobilePro VGA cable to the VGA port on the left side of the MobilePro.

*Connecting the VGA cable*

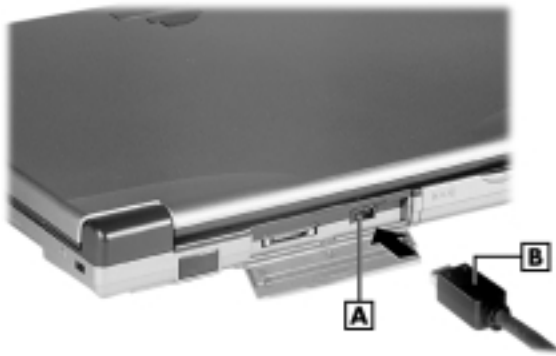

A – VGA port B – VGA cable

8. Connect the other end of the VGA cable to the monitor cable connector.



**CAUTION**

Be sure to properly align the cable connectors and ports. Incorrect connection can damage the MobilePro and the monitor.

---

9. Power on the MobilePro and the external monitor.



**CAUTION**

When the setting, “Display LCD on External Monitor,” is selected, the MobilePro uses more power than normal. To conserve power, be sure to deselect this setting when not using an external monitor.

---

---

## ***Using the Voice Recorder***

The NEC MobilePro features a voice recorder application that lets you record and play voice memos. Recording is dictation quality only and not intended for musical recording. Recording voice memos with the NEC MobilePro is easy.

Follow these steps to record with the Microsoft Voice Recorder.

- 1.** Tap Start, Programs, Accessories, then select Microsoft Voice Recorder or double tap the desktop icon on your MobilePro.
- 2.** Hold your NEC MobilePro with the microphone facing you.
- 3.** Tap the record button (red dot) and speak into the microphone.
- 4.** When you are finished recording, tap the Stop button (black square). A beep sounds when the recording stops.

To play back your recording, tap to highlight your selection and tap the Play button (green triangle) or simply double tap your selection.

You may want to modify the recording format to improve the quality of playback. To modify the recording format, tap Tools, Recording Format and use the dropdown box to change the format to PCM and to modify the Attributes to a higher sampling rate.

---

 **Note:** Recording works best if you position the microphone about three inches away from your mouth while speaking.

Memory required for voice memo storage varies depending on user settings.

---

## **Menu**

The Voice Recorder provides a variety of menu selections under the File, Control, and Tools selections. Refer to the online help provided with the voice recorder application for details about its use. Just tap the question mark icon in the upper right-hand corner of the screen to access the online help.

## **Using PC Cards**

Your NEC MobilePro comes with a PC card slot that supports one Type I or one Type II PC card. All PC cards are approximately the same size, have a standard 68-pin connector and vary only in thickness. PC cards add a variety of storage and communication functionality to your MobilePro.



### **CAUTION**

Windows CE supports the hot swapping of PC cards. However, to avoid data loss, do not remove a PC card while in use.

---

When using a PC card in the MobilePro, we recommend that you also use AC power. The batteries alone may not provide enough power for some PC cards to operate properly.

---

 **Note:** We recommend using the AC adapter when using PC cards or the internal modem. Using the adapter can help you avoid potential data loss caused by the high-energy consumption of some PC cards.

---

## ***Inserting PC Cards***

Follow these steps to install a PC card.

1. With the PC card facing up, insert the card into the PC card slot on the left side of the system.

*Inserting a PC card*



2. Verify that the PC card is securely in the slot.



### **CAUTION**

Make sure you align the PC card correctly for insertion. Inserting a PC card incorrectly can damage the card and/or the NEC MobilePro.

---

---

## Removing PC Cards

Follow these steps to remove a PC card from the MobilePro.

1. Locate the PC card eject button beside the PC card slot and press it to release the card from the slot.
2. Once the card is released, pull it the rest of the way out of the slot.

## Using CompactFlash Cards

Your NEC MobilePro comes with a CompactFlash card slot that supports one Type I or Type II CompactFlash card. A CompactFlash card provides a storage device for your MobilePro and when inserted, creates a *Storage Card 2* folder. To view the contents of the folder, double tap the My Handheld PC icon on your MobilePro desktop, then double tap the Storage Card 2 folder.



### CAUTION

Windows CE supports the hot swapping of CompactFlash cards. However, to avoid data loss, do not remove a CompactFlash card while in use.

---

When using a CompactFlash card in the MobilePro, also use AC power. The batteries alone may not provide enough power for some CompactFlash cards to operate properly.



**Note:** Use the AC adapter when using CompactFlash cards to avoid potential data loss caused by the high-energy consumption of some CompactFlash cards.

---

---

## ***Inserting CompactFlash Cards***

Follow these steps to install a CompactFlash card.

1. With the CompactFlash card facing up, insert it into the CompactFlash card slot on the right side of the system.

*Inserting a CompactFlash card*



---

 **Note:** When you insert a CompactFlash card, a button pops out of the card bay. Pivot the button towards the left side of the unit until it fits into the recessed space next to the slot.

---

2. Verify that the CompactFlash card is securely in the slot.



### **CAUTION**

Make sure you align the CompactFlash card correctly for insertion. Inserting a CompactFlash card incorrectly can damage the card and/or the MobilePro.

---

---

## ***Removing CompactFlash Cards***

Follow these steps to remove a CompactFlash card from the MobilePro.

---

 **Note:** Pivot the CompactFlash card button out of the recessed space before beginning the following procedure.

---

1. Save your data if you are storing it on the inserted CompactFlash card.
2. Press the button beside the CompactFlash card.
3. When the card pops out slightly, pull it out of the slot.

## ***Using the IR Port***

With the NEC MobilePro, you can send and receive data to and from another similarly equipped device using the infrared (IrDA) communication port. In addition, you can use the IR port to synchronize data with your host PC, in place of using the PC Connect (serial) cable.

Before using the NEC MobilePro for IrDA communication, first configure/enable the IR port on your host system, then install Microsoft ActiveSync on your host system.

---

 **Note:** If you configure/enable the IrDA port on your host system after installing Microsoft ActiveSync, you must re-install Microsoft ActiveSync before establishing IrDA communication between systems.

---



---

Follow these steps to use the IR port to communicate with another MobilePro or your host PC.

1. Remove the PC Connect (serial) cable from the MobilePro before attempting IrDA communication.
2. Open the display panels on the two units that you want to use for communication.
3. Position the MobilePro units so that the IR ports face each other. Position the units from 2 to 20 inches apart.
4. Be sure that nothing obstructs the path between the IR ports on both units, and that the ports are aligned properly.
5. Send your data by using the “Send To” selection in the Windows CE Windows Explorer File menu.
6. Highlight the file you want to transfer and choose “Infrared Recipient” from the Send To selections.

Your file is transferred to the other device. The receiving device uses the File/Receive command to receive the infrared transmission.



**Note:** If the units are too far apart or if something blocks the path between the two ports, data may not be sent or received correctly.

---

---

# Upgrading ROM

You can upgrade the NEC MobilePro ROM by replacing the currently installed ROM module with an upgraded ROM module (when available).

---

 **Note:** Be sure to synchronize your MobilePro data with your host PC and perform a backup of your MobilePro data before upgrading your ROM module. You may need to copy some files back to your MobilePro following this upgrade procedure.

---

---

 **Note:** Before handling any internal components, discharge electricity from yourself and your clothing by touching a nearby metal surface.

---

Follow these steps to upgrade your MobilePro ROM module.

1. Save your data to a host PC, power off the MobilePro, and close the display panel.
2. Disconnect any peripheral devices attached to the MobilePro, such as the AC adapter.
3. Remove the battery pack. For details, see the section, “Removing and Inserting the Battery Pack,” in Chapter 2.

- 
4. Turn over the MobilePro and locate the screw that secures the ROM bay cover.
  5. Using a small screwdriver, remove the screw and the bay cover. (The MobilePro does not power on when the bay cover is removed.)

*ROM bay cover*



**A** – ROM bay cover

6. With the small screwdriver, remove the two screws on the ROM module.
7. Gently lift up the ROM module to disconnect it from its connector and remove it from the bay.
8. Insert the upgraded ROM module into the bay, aligning the connector on the module with the one in the bay.
9. Gently press on the module just above the connectors until the connection is secure.
10. Replace the two screws to secure the upgraded ROM module.

- 
11. Replace the bay cover and cover screw.
  12. Push the full reset button. For details about using the full reset button, refer to the section later in this chapter, “Using the Full Reset Button.”
  13. After one minute or more, install the battery pack.

---

 **Note:** The MobilePro does not power on unless the ROM/RAM bay cover is secure.

---

## ***Resetting the MobilePro***

Occasionally you may need to reset your NEC MobilePro. For instance, you may need to reset after restoring data from your host PC, after modifying the MobilePro's configuration, when you are unable to power on using the Power button, or when the operating system stops responding.

The NEC MobilePro is equipped with two reset buttons: a soft reset button and a full reset button. Read the following descriptions to better understand the functions of and the differences between the buttons.

- **Soft Reset Button** — The soft reset button allows you to restart the NEC MobilePro operating system while preserving any saved data. This method is similar to a “warm boot” on your host PC.
- **Full Reset Button** — The full reset button restores your system to its original shipping configuration, erasing all information that you have entered.

---

 **Note:** To ensure the safety of your information at all times, you should perform regular backups of your MobilePro information to your host PC. For more information, see the section, “Backing Up and Restoring Data,” in Chapter 3.

---

## ***Using the Soft Reset Button***

Before using the soft reset button to reset the MobilePro, close any open files or applications, if possible. When you soft reset the MobilePro, you may lose open/unsaved files.

Follow these steps to use the soft reset button to reset the MobilePro.

- 1.** Open the display panel and remove the stylus from its holder.
- 2.** Power on the MobilePro.
- 3.** Locate the soft reset button above the top right of the keyboard.

- 
4. Using the stylus, press the soft reset button. (You may need to press the button more than once.) This resets the unit.

*Soft reset button*



A – Soft reset button

### ***Using the Full Reset Button***

Use the full reset button only when your unit does not respond after doing all of the following:

- Installing a charged battery.
- Connecting the unit to an AC power source.
- Using the soft reset button to reset the system.



## **CAUTION**

Using the full reset button to reset your MobilePro returns your unit to its original shipping configuration. All data and applications are erased from RAM. All open/unsaved files are lost and all user specific data such as contacts, tasks, etc., are erased.

You can only restore data that has been backed up to your host PC. For more information, see the section, "Backing Up and Restoring Data," in Chapter 3.

---

The full reset button is located inside of the main battery's bay. Follow these steps to remove the battery before using the full reset button to reset the NEC MobilePro.

- 1.** Open the display panel and remove the stylus from its holder.

---

2. Remove the battery pack as follows:

- Locate the battery release latch on the bottom of the system.
- Slide the release latch in the direction of its arrow and hold it.
- Remove the battery from the bay.

*Removing the battery pack*

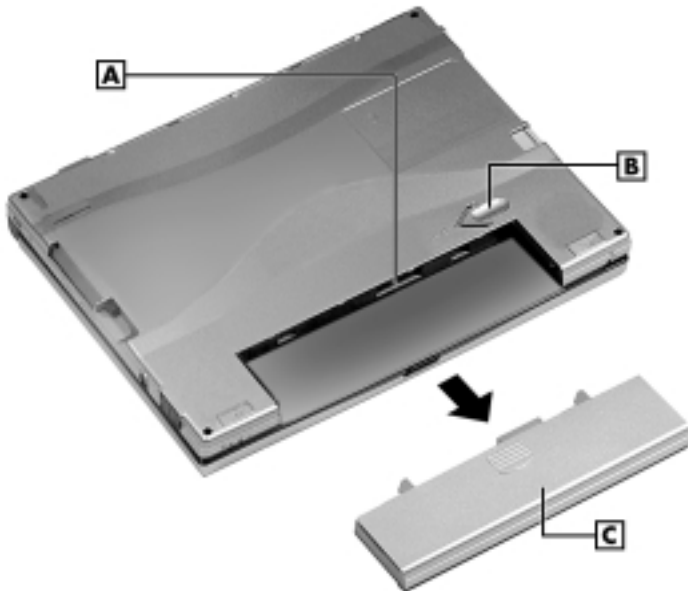

**A** – Battery connectors **B** – Battery release latch **C** – Battery pack



- 
3. Locate the full reset button inside of the battery bay, as indicated in the following figure.

*Full reset button*

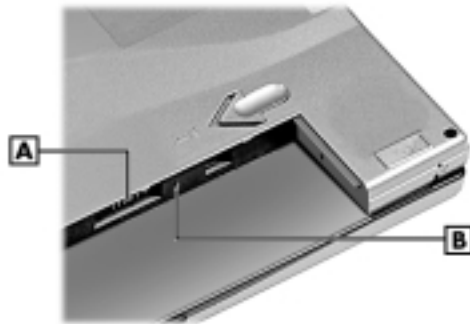

**A** – Battery connectors   **B** – Full reset button

4. Remove the USB mouse, if connected.
5. Using the stylus, press the full reset button. This resets the unit and restores your system to its original shipping configuration.

You may be able to use a recent backup of your data to restore your system to a more recent configuration. Refer to the section, “Backing Up and Restoring Your Data,” in Chapter 3 for details about backing up and restoring your MobilePro.

# 5

## Setting Up a Remote Connection

- Preparing for Connection Setup
- Connecting the Internal Modem
- Connecting to an Internet Service Provider (ISP)
- Connecting to a Remote Access Server (RAS)
- Sending and Receiving Email
- Activating a Connection

---

# ***Preparing for Connection Setup***

Before you set up a dial-up connection for an internet service provider (ISP) or remote access server (RAS), and the associated email properties, you need the following:

- a modem (your NEC MobilePro is equipped with an internal data/fax modem).
- an ISP or RAS account.
- configuration information from your ISP or network administrator that may include some or all of the following:
  - the dial-up telephone number
  - TCP/IP settings
  - port settings
  - a user name and password, if required.

You must create a new connection for each ISP or RAS account that you want to establish. Once you have created a connection for an ISP, RAS, etc., you can define an email account for each connection, if so desired. Follow the instructions in the sections that follow “Connecting to an ISP,” “Connecting to a RAS,” and “Sending and Receiving Email” to create the desired connections.

---

## ***Connecting the Internal Modem***

Follow these steps to connect an RJ-11 telephone cable to the internal modem.

1. Locate the modem cover on the right side of the NEC MobilePro and open it.
2. Carefully plug the RJ-11 telephone cable into the modem connector.

*Connecting the telephone cable*



---

**WARNING**

Do not connect the internal modem to a digital private branch exchange connector, or the digital side of an integrated digital network. Use only analog phone connections. Failure to do so may result in explosion or fire and will damage your modem.

During thunderstorms be sure to disconnect the modem phone cable from the NEC MobilePro. Failure to do so may result in explosion or fire.

---

3. Connect the other RJ-11 connector into an active (analog) phone jack.

Now you are ready to create a connection for an ISP or RAS account!

## ***Connecting to an Internet Service Provider***

Once you have established an account with an ISP and gathered the necessary configuration information, you are ready to create a connection on your MobilePro for your ISP account.

Your Bonus Software CD may contain the application, Ruksun<sup>®</sup> ConnectForce<sup>™</sup> that enables you to automate the ISP setup procedure described below and includes a database of phone numbers and communication settings for a number of popular ISPs.

---

Follow these steps to create a new connection for your ISP account.

1. Tap Start, Programs, Communication, then select Remote Networking.
2. Double tap the Make a New Connection icon.
3. Enter a name for the new connection.
4. Select Dial-Up Connection as the connection type and tap Next.
5. Use the dropdown box to select Internal Modem on COM 4 and tap Configure.
6. Select the required port settings and call options. Tap OK.
7. Tap TCP/IP Settings and configure the required General Settings and Name Servers. Tap OK.
8. Tap Next and enter the required dial-up telephone number. Tap Finish.

Once your ISP connection is established you can configure your MobilePro for sending and receiving email through your ISP. Follow the instructions in “Sending and Receiving Email” and “Activating a Connection,” later in this chapter, to send and receive email through your ISP.

For ISP settings, access:

<http://www.cewindows.net/wce/isp.htm/>. Although not an official NECC web site, this site contains important information about ISP settings.

---

# ***Connecting to a Remote Access Server***

Once you establish an account with your RAS and gather the necessary configuration information, you are ready to create a connection on your MobilePro for your RAS account.

Follow these steps to create a new connection for your RAS account.

- 1.** Tap Start, Programs, Communication, then select Remote Networking.
- 2.** Double tap the Make a New Connection icon.
- 3.** Enter a name for the new connection.
- 4.** Select Dial-Up Connection as the connection type and tap Next.
- 5.** Use the dropdown box to select Internal Modem on COM 4 and tap Configure.
- 6.** Select the required port settings and call options. Tap OK.
- 7.** Tap TCP/IP Settings and configure the required General Settings and Name Servers. Tap OK.
- 8.** Tap Next and enter the required dial-up telephone number. Tap Finish.

Once your RAS connection is established you can configure your MobilePro for sending and receiving email through your RAS. Follow the instructions in “Sending and Receiving Email” and “Activating a Connection,” later in this chapter, to send and receive email through your RAS.

---

## ***Sending and Receiving Email***

Before configuring the necessary email service information you need some or all of the following settings:

- POP3 Host.
- Your user id.
- Your password, if required.
- SMTP host.
- Your email address.

To send and receive email through your ISP or RAS account, you must configure the services properties through your Inbox. Follow these steps to configure the email services information.

1. Double tap Inbox, tap Services, and tap Options.
2. On the Services tab, tap Add.
3. Select the desired service type and enter the service name.
4. Tap OK.
5. Enter the information provided by your ISP provider or network administrator.

The Mail Services Definition screen consists of Required information and Optional information. Fill in all information as provided by your ISP or network administrator.

- Enter ISP information as follows:
  - POP3 Host - ISP POP3 Host name.
  - User ID - Your user id.



- 
- Password - Your password, if required.
  - Domain (Windows NT).
  - SMTP Host - SMTP Host name.
  - Return Address - Your email address. (If in a unix environment <your email address>).
- Enter RAS (Exchange server) information as follows:
    - POP3 Host - Exchange server name.
    - User ID - Domain\your user id\exchange alias.
    - Password - Your password, if required.
    - Domain (Windows NT).
    - SMTP Host - Exchange server name.
    - Return Address - Your email address. (If in a unix environment <your email address>).
- Enter IMAP4 information as follows:
    - Server
    - User ID
    - Password
    - Domain (Windows NT)
    - SMTP Host - Exchange server name.
    - Return Address - Your email address. (If in a unix environment <your email address>).

---

 **Note:** If you experience difficulty sending email, check your optional configuration settings. If you experience difficulty receiving email, check your required configuration settings.

---

## ***Activating a Connection***

Once you create a new connection for each desired service, activate the connection with that service to open communication and send or receive email.

Follow these steps to activate a connection.

1. Double tap the Inbox icon.
2. Tap Services and verify that the service you want to connect is selected.

The currently selected service displays in the dropdown box and is designated with a dot. If necessary, modify your selection before connecting and tap OK.

3. Tap Services (again, if necessary) and tap Connect.

The connection dialog box displays and may prompt you to enter a password. Otherwise, the connection dialog box displays the connection progress and indicates when the connection is successful.

4. Enter your password, if required.

Once the connection is established, you are ready to send and receive email.

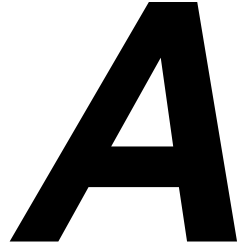

# Troubleshooting

Your NEC MobilePro 880 Professional PC Companion is designed to provide many hours of service while you are at home or on the road.

For optimum performance, frequently back up and synchronize the MobilePro data with your host PC. Then if something happens, most of your data is still available. If you have problems, check the information in the following table for possible solutions.

## *Troubleshooting*

<b>Problem</b>	<b>Resolution</b>
The MobilePro has no power.	Check the main battery. If you are using an AC adapter, make sure the connections are correct and secure. Check that the ROM bay cover is secure.
Nothing appears on the screen.	Try pressing the Power button again (the unit might have turned itself off if it was not used for a specified time). Adjust the contrast. Check the power connections. Try recharging the main battery. Check that the ROM bay cover is secure.

---

## ***Troubleshooting***

<b>Problem</b>	<b>Resolution</b>
A low battery message appears.	Recharge the main battery.
When using a PC card, such as a modem, the unit powers off.	Connect the AC adapter to the unit when using PC cards that require large amounts of energy.
The AC adapter doesn't work.	Make sure that the main battery is installed.  Check that the AC adapter connections are secure.  Verify that the AC outlet being used is working. Do this by plugging in another electric device, such as a lamp.
The keyboard doesn't respond.	Press the soft reset button to reset the unit.  If you have installed handwriting recognition software, be sure that you have not set the "disable keyboard" parameter in that software.
The serial port doesn't work.	Check that the cable connections are secure.
The IrDA port doesn't work.	Check that nothing obstructs the path between the transmitting and receiving IR ports.  Check the information in "Using the IR Port," in Chapter 4.
The PC card cannot be accessed.	Make sure the card is inserted correctly and seated properly.  Connect the unit to AC power using the adapter. Some cards do not operate properly unless the AC adapter is connected.

---

---

## ***Troubleshooting***

<b>Problem</b>	<b>Resolution</b>
The touch screen does not respond.	<p>Press <b>Ctrl Alt =</b> to calibrate the stylus input. Follow the on-screen instructions to complete the recalibration procedure.</p> <p>Press the soft reset button to reset the unit.</p>
The soft reset button does not respond.	<p>Remove the main battery. Reinstall the battery and make sure it is seated properly. Try resetting the unit again.</p> <p>If the soft reset button at the top of the keyboard does not respond, use the full reset button inside the battery bay. Refer to the section, "Resetting the MobilePro," in Chapter 4.</p> <p><b>Caution:</b> This second procedure may result in the loss of the memory contents including all stored data, settings, and files.</p> <p>Be sure to make regular backups.</p>

---

**For further assistance, call NECC Support Services at  
1-800-632-4525**

---

 **Note:** If you purchased and are using this computer outside of the U.S. and Canada, please contact the local NECC office or their dealers for support and service.

---

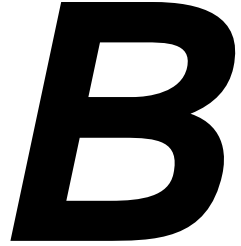

# Specifications

The following specifications are standard except where noted.

## **Display**

9.4-inch, DSTN, SVGA, 800x600, 64K color, liquid crystal display (LCD), with backlight, touch screen

## **CPU**

NEC VR4121, 168-MHz processor, optimized for Windows CE

## **User Data Entry Methods**

- 78-key QWERTY keyboard with stylus
- 17.5 mm alpha key pitch
- Touch screen (input via stylus)

## **Random Access Memory (RAM)**

32 megabytes (MB); standard

## **Read-Only Memory (ROM)**

24 megabytes (MB); replaceable

## **Microphone**

One internal microphone

---

## Speaker

One built-in speaker

## Infrared (IrDA) Communication

- Baud rate — SIR, FIR, 4 Mbps maximum
- Distance — 2 to 20 inches

## Serial Interface

Baud rate — 115.2 Kbps maximum

## I/O Ports

- Serial port (Direct Cable connection)
- IrDA port
- VGA port (output)
- Earphone Microphone
- USB port
- Modem port
- Power port (DC in)

## Modem

- Data - V. 90, 56 Kbps (AT command)
- Fax - 14.4 Kbps (Fax control command Class I)

---

 **Note:** Download speed is limited to 53 Kbps. Upload speed is limited to 33.6 Kbps. Actual speeds may vary depending upon line conditions.

The built-in modem requires a compatible service provider.

---

---

### PC Card Slot

One Type I or Type II PC card slot

### CompactFlash Card Slot

One Type I or Type II CompactFlash card slot

### Power

- Main battery — one rechargeable Lithium-Ion (Li-Ion) battery pack (included).
- Memory backup — approximately 7 days (with depleted main battery) at ambient temperature of 73°F (23°C).



**Note:** The period for safe memory backup can vary with ambient temperature and other factors. Always make sure your MobilePro is powered off before you store it, and always recharge your MobilePro as soon as possible after depleting the main battery.

---

### Recharge Time

- Use the AC adapter to recharge the MobilePro main battery and the backup battery.
- Recharging time is approximately 4.5 hours when the system is on or off.
- The backup battery usually recharges while the main battery is recharging.
- Initial charge time for the main battery and the backup battery is approximately 10 hours with the system off.
- The system must be charged for 10 hours if the main battery is depleted for a prolonged period.



---

### **Accessories (ship with system)**

- AC adapter — Listed Direct Plug-In Power Unit
  - Input Voltage - 100 to 240V AC; 60Hz, 13W
  - Output Voltage – 13.5V DC, 35.1W
- Rechargeable Lithium-Ion Battery Pack
- PC Connect (serial) Cable
- RJ-11 Telephone Cable
- VGA Cable
- Stylus

### **Dimensions**

- 9.64 in. (w) x 7.4 in. (d) x 1.0 in. (h)
- 245 mm (w) x 189 mm (d) x 26.6 mm (h)

### **Weight**

- 2.43 lb.
- 1100 grams

### **Operating Environment**

- Temperature — 32° to 104°F (0° to 40°C)
- Humidity — 35% to 85% (No condensation)

### **Storage Environment**

- Temperature — 14° to 140°F (-10° to 60°C)
- Humidity — 35% to 85% (No condensation)

### **Available Options**

- AC Adapter (MC-BA12)
- PC Connect (serial) Cable (S1424-12S)

- 
- VGA Cable (S1424-12V)
  - Stylus Pack (S1424-17A)
  - Deluxe Carrying Case (290-01500-000)
  - Li-Ion Battery Pack (MC-BA11A)
  - Earphone Microphone (MC-EM1)
  - 16 MB CompactFlash card (050-00054-000)
  - High-Speed Printer Cable (MC-RC3E)

---

# Index

## A

- AC adapter, 1-8
  - connecting, 1-8
- AC power port, 2-7
- Accessories, 1-5, B-4
- Activating a connection, 5-9
- Adjusting
  - MobilePro settings, 4-13
  - panel brightness, 4-4
- Assigning user software icons, 4-14
- Auto Suspend, 4-7
- Available options, B-4

## B

- Backing up and restoring data, 3-12
- Backlight settings, 4-5
- Battery
  - determining status, 2-11
  - installing and charging, 1-6
  - pack, 2-5
  - precautions, 2-17
  - recharging, 2-12
  - release latch, 2-9
  - removing and inserting, 2-14
  - replacement, 2-14
- Bonus Software CD
  - software applications, 3-14
  - using, 3-14
  - using with Windows NT, 3-15

## C

- Caring for the MobilePro, 2-18

## CompactFlash cards

- inserting, 4-21
- removing, 4-22
- slot, 2-8

## Connecting

- AC adapter, 1-8
- activate a connection, 5-9
- internet service provider (ISP), 5-4
- modem, 5-3
- PC Connect cable, 1-13
- preparation, 5-2
- remote access server (RAS), 5-6
- VGA cable, 4-15
- via infrared, 1-19
- via serial, 1-11

## Creating a partnership, 1-25

## D

- Determining battery status, 2-11
- Display panel, 2-2
- Docking cradle connector, 2-9

## E

- Earphone microphone jack, 2-7
- Enabling the suspend switch, 4-7

## F

### Features

- AC power port, 2-7
- battery release latch, 2-9
- CompactFlash card slot, 2-8
- display panel, 2-3
- display panel icons, 2-3
- display panel latch, 2-3

---

- docking cradle connector, 2-9
- earphone microphone, 2-7
- IR port, 2-6
- Kensington lock, 2-8
- keyboard, 2-5
- Lithium-Ion battery, 2-10
- main battery pack, 2-5
- microphone, 2-5
- modem port, 2-8
- PC card eject button, 2-7
- PC card slot, 2-7
- power button, 2-4
- ROM/RAM bay cover, 2-9
- serial port, 2-6
- speaker, 2-6
- status LEDs, 2-5
- stylus, 2-5
- stylus slot, 2-8
- suspend switch, 2-4
- USB port, 2-7
- user-defined icons, 2-3
- VGA port, 2-6
- Full reset button, 4-26
  - using, 4-28
- Function keys, 4-12

## **G**

Getting help, 1-28

## **I**

- Infrared port
  - enabling, 1-21
  - host PC, 1-21
  - NEC MobilePro, 1-20

## **Inserting**

- CompactFlash cards, 4-21
- PC cards, 4-19

## **Installing**

- Microsoft ActiveSync, 1-16,  
1-23

## **Installing Microsoft ActiveSync**

- Windows NT, 1-17

- IR port, 2-6

## **K**

- Kensington lock, 2-8

## **Keyboard, 2-5**

- application shortcut keys, 4-9
- brightness keys, 4-9
- control keys, 4-10
- cursor control keys, 4-10
  - using, 4-9
- Windows key, 4-10

## **L**

- Lithium-Ion battery, 2-10

## **M**

- Main Battery Pack, 2-5

- Microphone, 2-5

## **MobilePro**

- power management, 2-13
- settings, 4-13

- Modem port, 2-8

## **N**

- NECC support services, A-3

## **O**

- Online help, 3-16

- Opening the display panel, 2-10

## **P**

- Panel brightness, 4-4

## **PC cards**

- eject button, 2-7
- inserting, 4-19

---

- removing, 4-20
- slot, 2-7
- PC Connect cable
  - when using other communication devices, 1-27
- PC Connection settings
  - infrared connection, 1-20
- Pocket applications, 3-6
- Power button, 2-4
- Precautions, 2-18
- Printing, 3-8
- Problem solving, A-1

## **R**

- Removing
  - CompactFlash cards, 4-22
  - PC cards, 4-20
- Reset button
  - full reset, 4-26
  - soft reset, 4-26
- Resetting the MobilePro, 4-26
- Resynchronizing your MobilePro, 1-27
- ROM/RAM bay cover, 2-9
- Routine cleaning, 2-20

## **S**

- Sending and receiving email, 5-7
- Serial port, 2-6
- Setting up a remote connection, 1-27
- Soft reset button, 4-26
  - using, 4-27
- Software applications, 3-14
- Speaker, 2-6
- Specifications
  - accessories (shipped with system), B-4
  - battery, B-3

- CompactFlash card slot, B-3
- CPU, B-1
- dimensions, B-4
- display panel, B-1
- I/O ports, B-2
- infrared (IR) port, B-2
- microphone, B-1
- modem, B-2
- operating environment, B-4
- PC card slot, B-3
- RAM, B-1
- ROM, B-1
- serial, B-2
- speaker, B-2
- storage environment, B-4
- weight, B-4
- Status LEDs, 2-5
- Storage requirements, 2-19
- Stylus, 2-5
  - slot, 2-8
- Suspend, 4-7
  - switch, 2-4
- Synchronizing
  - after rebooting host PC, 1-27
  - after resetting MobilePro, 1-27
- System features
  - back, 2-6
  - bottom, 2-9
  - front, 2-2
  - keyboard panel and base unit, 2-4
  - left, 2-7
  - right, 2-8

## **T**

- Troubleshooting, A-1

---

## **U**

Unpacking your MobilePro, 1-3

Upgrading ROM, 4-24

USB port, 2-7

User software icons, 4-14

Using

- application shortcut keys, 4-10

- infrared (IR) port, 4-22

- MobilePro power sources, 2-11

- stylus, 2-10

- voice recorder, 4-17

- Windows CE, 3-2

## **V**

Verifying

- PC connection settings, 1-12

- synchronization settings, 1-18,  
1-25

VGA port, 2-6

Voice

- memos, 4-17

- recording, 4-17

## **W**

Windows CE

- applications, 3-6

- backing up and restoring data,  
3-12

- desktop, 3-4

- operating system, 3-2

- overview, 3-2

- printing, 3-8

## Battery Replacement

A lithium battery in some computers maintains system configuration information. In the event that the battery fails to maintain system configuration information, NECC recommends that you replace the battery. For battery replacement information, call your local NECC dealer.

---

### **WARNING**

There is a danger of explosion if the battery is incorrectly replaced. Replace only with the same or equivalent type recommended by the manufacturer. Discard used batteries according to the manufacturer's instructions.

---

### **AVERTISSEMENT**

Il y a danger d'explosion s'il y a remplacement incorrect de la batterie. Remplacer uniquement avec une batterie du même type ou d'un type recommandé par le constructeur. Mettre au rebut les batteries usagées conformément aux instructions du fabricant.

---

## Battery Disposal

The main battery is a Lithium-Ion battery.

The sub-battery is a Nickel-Metal Hydride battery.

Do not place used batteries in your regular trash.

The incineration, landfilling, or mixing of batteries with the municipal solid waste stream is **prohibited by law** in most areas.

Contact your local waste management officials for other information regarding the environmentally sound collection, recycling, and disposal of used batteries. If you purchased or are using this computer outside of the U.S. or Canada, contact a local NECC dealer in your country.

**(For United States Use Only)**

**Federal Communications Commission  
Radio Frequency Interference Statement**

---

 **WARNING**

Changes or modifications to this unit not expressly approved by the party responsible for compliance could void the user's authority to operate the equipment.

---

 **Note:** This equipment has been tested and found to comply with the limits for a Class B digital device, pursuant to Part 15 of the FCC Rules. These limits are designed to provide reasonable protection against harmful interference in a residential installation. This equipment generates, uses and can radiate radio frequency energy and, if not installed and used in accordance with the instructions, may cause harmful interference to radio communications.

---

However, there is no guarantee that interference will not occur in a particular installation. If this equipment does cause harmful interference to radio or television reception, which can be determined by turning the equipment off and on, the user is encouraged to try to correct the interference by one or more of the following measures.

- Reorient or relocate the receiving antenna.
- Increase the separation between the equipment and receiver.
- Connect the equipment to an outlet on a circuit different from the one to which the receiver is connected.

Use shielded and properly grounded I/O cables and power cable to ensure compliance of this unit to the specified limits of the rules.



## FCC PART 68

This equipment complies with Part 68 of FCC rules. On the bottom of this equipment is a label that contains, among other information, the FCC registration number and ringer equivalence number (REN) for this equipment. If requested, this information must be provided to the telephone company.

All applicable registration jack USCOs, any facility interface codes and service order codes associated with the service the equipment must be connected.

The REN is used to determine the quantity of devices that may be connected to the telephone line. Excessive RENs on the telephone line may result in the devices not ringing in response to an incoming call. In most, but not all areas, the sum of the RENs should not exceed five (5). To be certain of the number of devices that may be connected to the line, as determined by the total RENs contact the telephone company to determine the maximum REN for the calling area.

If the MobilePro causes harm to the telephone network, the telephone company will notify you in advance that temporary termination of service may be required. But if advance notice isn't possible, the telephone company will notify the customer as soon as possible. Also, you will be advised of your right to file a complaint with the FCC if you believe it is necessary.

The telephone company may make changes in its facilities, equipment, operations, or procedures that could affect the operation of the equipment. If this happens, the telephone company will advise you in advance to make the necessary modifications to maintain uninterrupted service.

If you have trouble with the MobilePro, please contact NECC Support Services at 1-800-632-4525 for repair and warranty information. If the trouble is impacting the telephone network, the telephone company may request you remove the equipment from the network until the problem is resolved.

The equipment cannot be used with public coin telephones provided by the telephone company. Connection to Party Line Service is subject to state tariffs. (Contact the state public utility commission, public service commission or corporation commission for information.)

The Telephone Consumer Protection Act of 1991 makes it unlawful for any person to use a computer or other electric device to send any message via a telephone fax machine unless such message clearly contains in a margin at the top or bottom of each transmitted page or on the first page of the transmission, the date and time it is sent and an identification of the business or other entity, or other individual sending the message and the telephone number of the sending machine or such business, other entity, or individual. In order to program this information into your MobilePro refer to the MobilePro FAX help files on the MobilePro desktop. If you are using a different communication software program, refer to its manual.

 **Note:** The Industry Canada label identifies certified equipment.

---

This certification means that the equipment meets telecommunications network protective, operational and safety requirements as prescribed in the appropriate Terminal Equipment Technical Requirements document. The Department does not guarantee the equipment will operate to the user's satisfaction.

Before installing this equipment, users should ensure that it is permissible to be connected to the facilities of the local telecommunications company. The equipment must also be installed using an acceptable method of connection. The customer should be aware that compliance with the above conditions may not prevent degradation of service in some situations.

Repairs to certified equipment should be coordinated by a representative designated by the supplier. Any repairs or alterations made by the user to this equipment, or equipment malfunctions, may give the telecommunications company cause to request the user to disconnect the equipment.

Users should ensure for their own protection that the electrical ground connections of the power utility, telephone lines and internal metallic water pipe system, if present, are connected together. This precaution may be particularly important in rural areas.



### **CAUTION**

Users should not attempt to make such connections themselves, but should contact the appropriate electric inspection authority, or electrician, as appropriate.

---

---

 **Note:** The Ringer Equivalence Number (REN) assigned to each terminal device provides an indication of the maximum number of terminals allowed to be connected to a telephone interface. The termination on an interface may consist of any combination of devices subject only to the requirement that the sum of the Ringer Equivalence Number of all the devices does not exceed 5."

---

(For Canadian Use Only)

This Class B digital apparatus meets all requirements of the Canadian Interference-Causing Equipment Regulations.

---

Cet appareil numérique de la classe B respecte toutes les exigences du Règlement sur le matériel brouilleur du Canada.

### **FCC WARNING**

Changes or modifications not expressly approved by the party responsible for compliance could void the user's authority to operate the equipment.

Properly shielded and grounded cables and connectors must be used for connection to host computer and/or peripherals in order to meet FCC emission limits.

AC adapter with ferrite core must be used for RF interference suppression.

NEC Computers Inc.

## DECLARATION OF CONFORMITY

*We, the Responsible Party*

NEC Computers Inc.  
15 Business Park Way  
Sacramento, CA 95828

*declare that the product*

NEC MobilePro 880

is in conformity with part 15 of the FCC Rules.  
Operation of this product is subject to the following  
two conditions: (1) this device may not cause harmful  
interference, and (2) this device must accept any  
interference received, including interference that may  
cause undesired operation.

Product Type: HandHeld PC  
Equipment Classification: Class B peripheral