

JVC

SERVICE MANUAL

Mobile mini note PC

MP-XV941DE, MP-XV841DE, MP-XV841GB, MP-XV841GBEX, MP-XV841US

Area Suffix

DE ----- Germany
GB ----- U.K.
US ----- U.S.A.

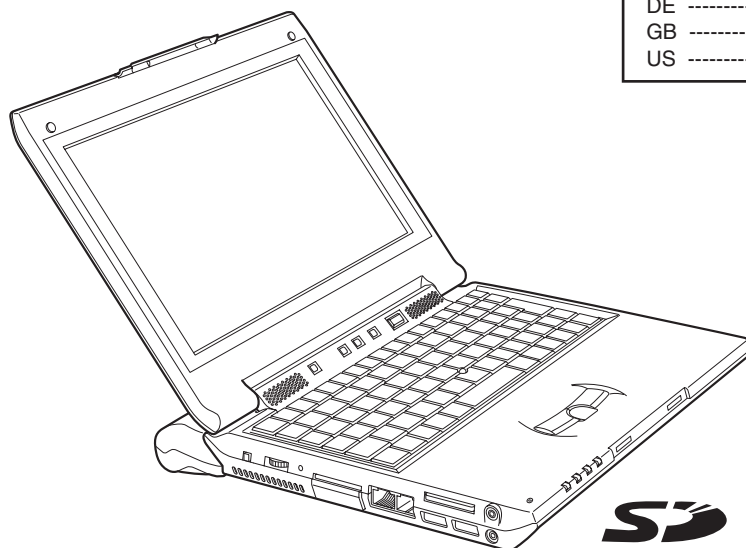

TABLE OF CONTENTS

1	PRECAUTION.....	1-2
2	SPECIFIC SERVICE INSTRUCTIONS.....	1-2
3	DISASSEMBLY.....	1-3
4	ADJUSTMENT.....	1-10
5	TROUBLESHOOTING.....	1-11

**SECTION 1
PRECAUTION**

This service manual does not describe PRECAUTION.

**SECTION 2
SPECIFIC SERVICE INSTRUCTIONS**

This service manual does not describe SPECIFIC SERVICE INSTRUCTIONS.

SECTION 3 DISASSEMBLY

3.1 Disassembly procedure

3.1.1 Removing the DIMM cover(See Figure 1)

- (1) Remove three screws **A** from the DIMM cover on the bottom of the main unit.
- (2) Remove the DIMM cover by lifting it up from the gap **a**.

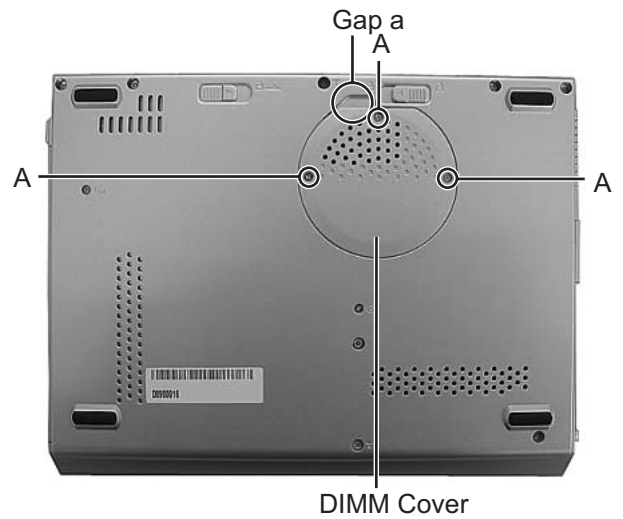

Fig.1

3.1.2 Removing the DVD drive unit(See Figure 2)

- Prior to the following procedure, DIMM cover should be removed.
- (1) Remove two screws **B**, which are attached to the DVD drive unit, from the bottom of the main unit.
 - (2) Push part **b** in the direction indicated by the arrow, then pull out the DVD drive unit by sliding outward.

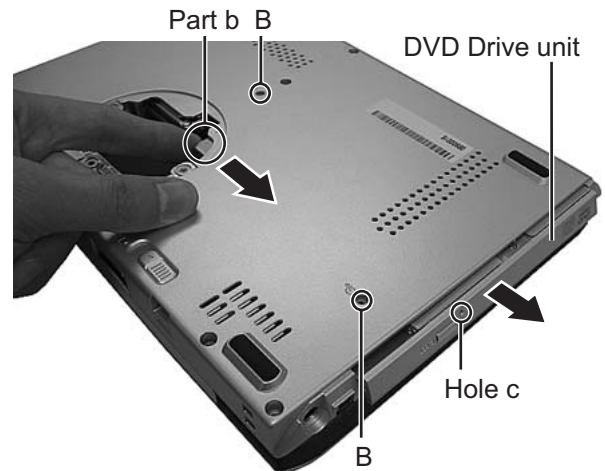

Fig.2

3.1.3 Removing the fitting(See Figure 2, Figure 3)

- Prior to the following procedure, DVD drive unit should be removed.
- (1) Eject the tray by inserting a piece of fine wire into the small hole **c**.
 - (2) Disengage three tabs **d**, and then disengage one hook **e**.
- * Pay special attention not to damage either the tabs or the hooks.**

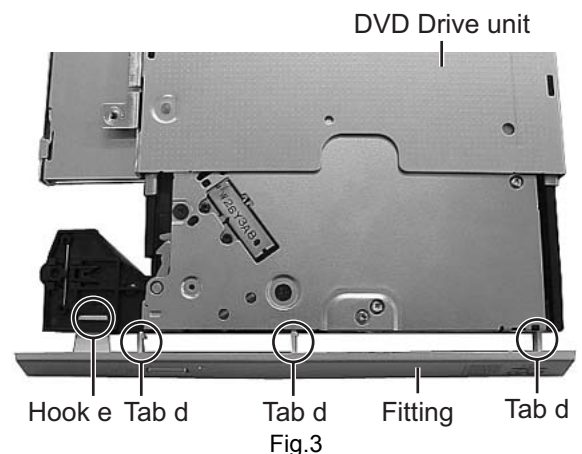

Fig.3

3.1.4 Removing the keyboard assembly(See Figure 4 , Figure 5,Figure 6)

- (1) Individually push three latches f in the upper part of the keyboard with a single-slotted or flat screwdriver, and then lift the keyboard assembly upward.



Fig.4



Fig.5

- (2) Pull out the card wires from the connectors [CON6](#) and [CON8](#) on the main board respectively.

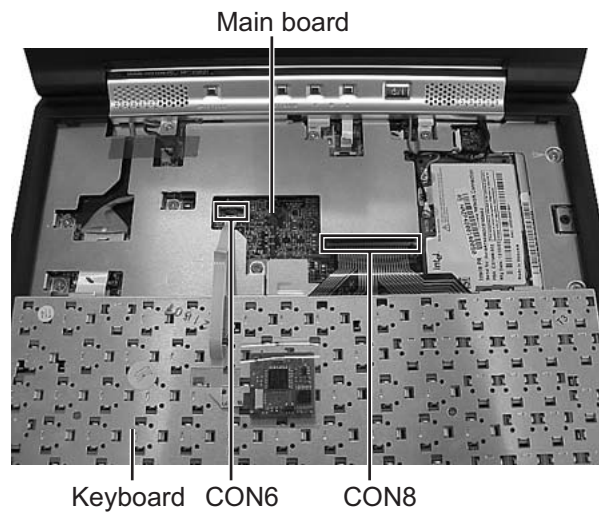

Fig.6

3.1.5 Removing the hinge cover(See Figure 7 ,Figure 8, Figure 9)

- (1) Remove one screw **C** and two screws **B** from the hinge cover.
C :short D :long
- (2) Disconnect one card wire from the connector **CON5** on the main board.

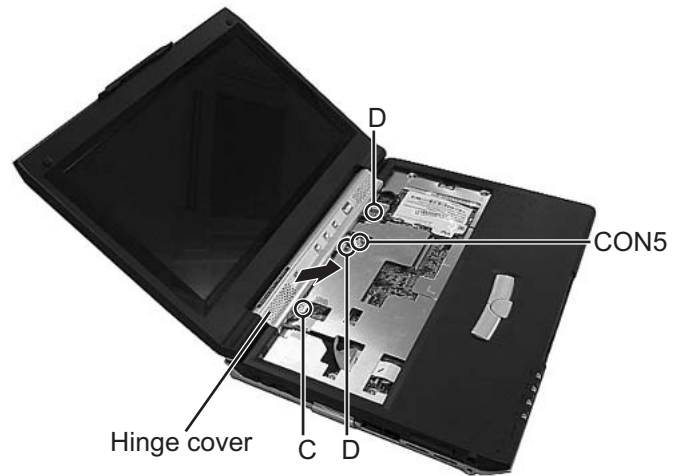

Fig.7

- (3) Remove one screw **E** from the bottom of the main unit.

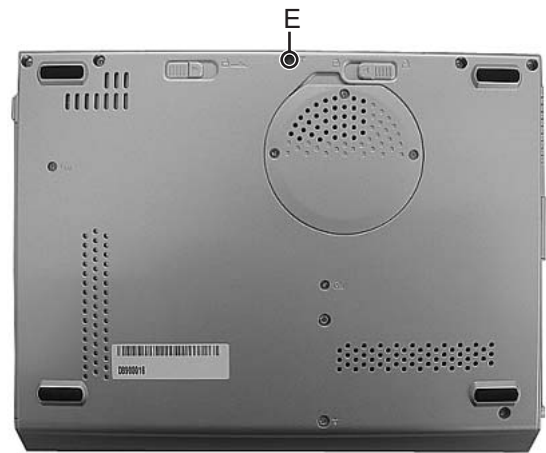

Fig.8

- (4) Leave the LCD panel open. Release four tabs **g** on the hinge cover by slowly inserting a single-slotted or flat screwdriver into the slot of the battery terminal.

***Please make sure not to damage either the hinge cover or the bottom case when releasing the tabs.**

- (5) Slowly remove the hinge cover in the direction indicated by the arrow.

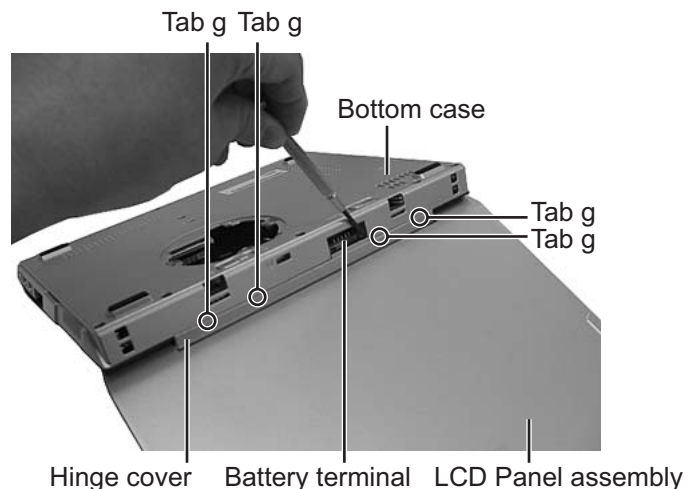

Fig.9

3.1.6 Removing LCD panel assembly(See Figure 10 and Figure 11)

- Prior to the following procedure, the keyboard assembly and the hinge cover should be removed.

- (1) Disconnect each wire from the connectors [CON2](#) and [CON9](#) on the main board.
- (2) Remove two wires from the connector on the wireless LAN board.

***Connect grey wire to the AUX terminal, and black wire to the MAIN terminal for reassembly.**

- (3) Remove two screws **F** which are attached to the hinge.

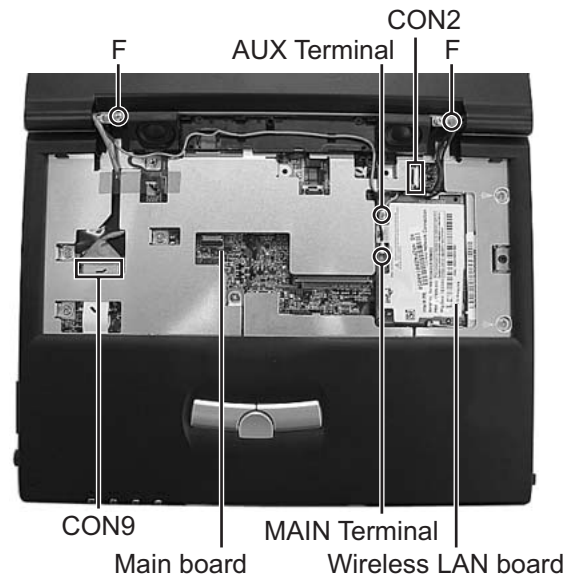

Fig.10

- (4) Remove two screws **G** which are attached to the hinge from the bottom of the main unit.

- (5) Pull out the hinge by moving the LCD panel unit upward.

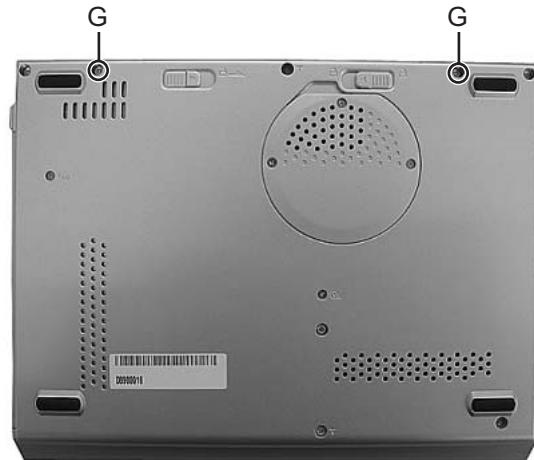

Fig.11

3.1.7 Removing the top case(See Figure 12 and Figure 13)

- Prior to the following procedure, the LCD panel assembly should be removed.

- (1) Remove four screws **H** and two screws **I** from the shield plate.
H:long I:short
- (2) Remove two screws **J** that are attached to the top case assembly.
J : black
- (3) Disconnect wires from each connector [CON3](#), [CON4](#), and [CON10](#) on the main board.

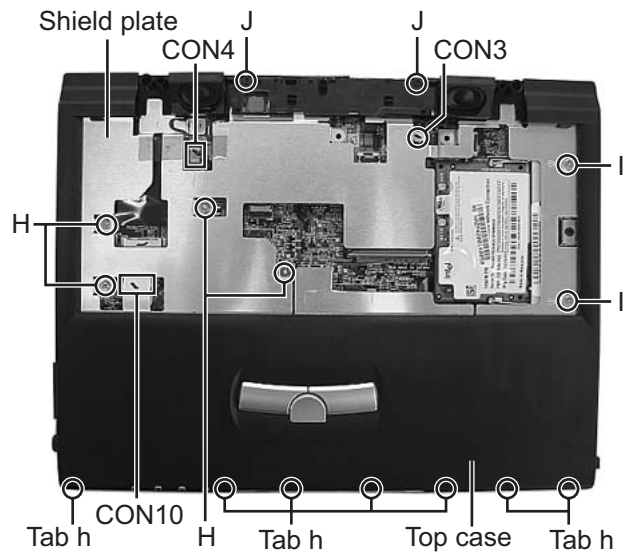

Fig.12

- (4) Remove four screws **K** and one screw **L** from the bottom of the main unit.
K : long L : short
- (5) Release seven tabs **h** on the top case.



Fig.13

3.1.8 Removing the main board(See figure 14)

- Prior to the following procedure, LCD panel assembly and top case assembly should be removed.

- (1) Remove four screws **M** and one screw **N** from the main board.
M : silver N : black

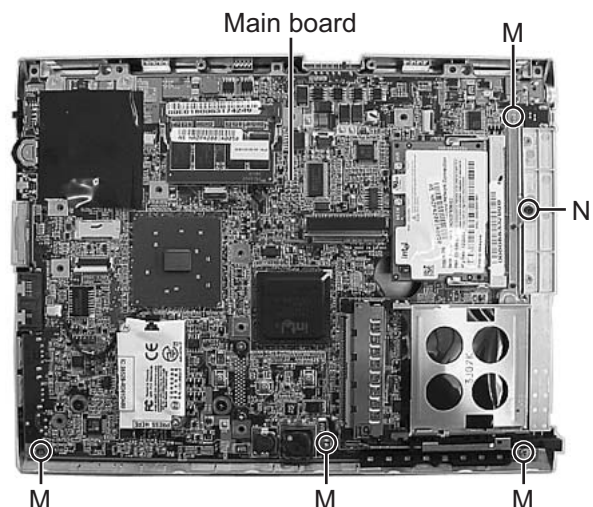

Fig.14

3.1.9 Removing the parts on the main board(See Figure 15 and Figure 16)

- Prior to the following procedure, main board should be removed.

*Removing the hard disc drive.

- (1) Pull out the flexible wire from the connector [CON25](#) on the main board.

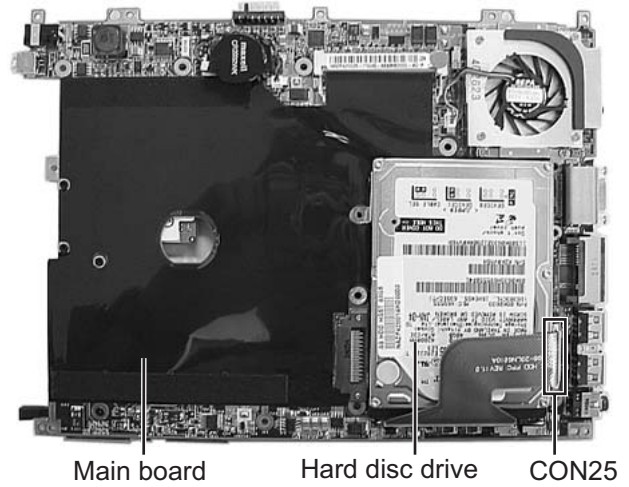

Fig.15

- (2) Remove two screws **O** that are attached to the hard disc drive.

*Removing the built in memory card and wireless LAN card.

- (1) Release the catches on both sides of the memory card **i**. Pull out the memory card as it pops up.
- (2) Release the catches on both sides of the wireless LAN card **j** and remove the wireless LAN card as the same way as removing the memory card .

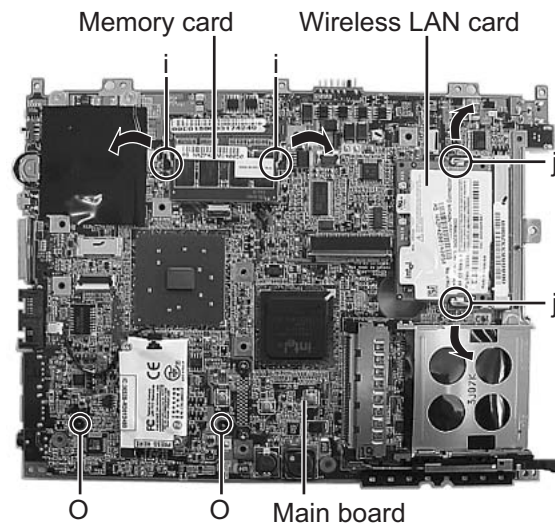
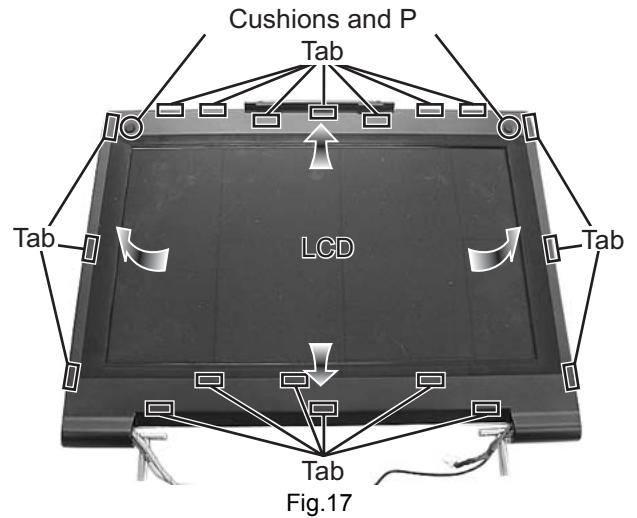

Fig.16

3.1.10 Removing LCD panel assembly(See Figure 17, Figure 18)

- Prior to the following procedure, LCD panel assembly should be removed.
 - (1) With a sharp pointed tool, take the cushions off. (Cushions are fixed with adhesive tape.)
 - (2) Remove two screws **P** that are attaching the LCD panel frame.
 - (3) Release the tabs on the frame by pushing the LCD panel frame outward .



- (4) Remove two screws **Q** from the LCD.
- (5) Remove the socket wire from the connector [CN2](#) on the inverter board.

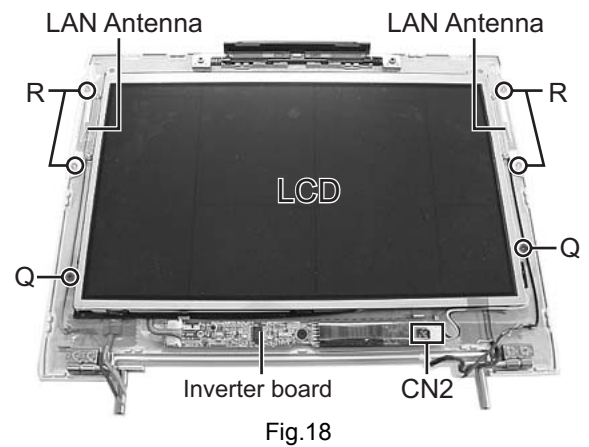

3.1.11 Removing the LAN antenna(See Figure 18)

- Prior to the following procedure, LCD should be removed.
 - (1) Remove four screws **R** that are attached to the LAN antennas.
 - (2) Remove the tape which fixes the LAN antenna if required.

SECTION 4 ADJUSTMENT

This service manual does not describe ADJUSTMENT.

SECTION 5

TROUBLESHOOTING

5.1 Preinstallation procedure

No data including Windows XP has been recorded in service parts HDD. It is necessary to put data in HDD[Preinstall] after HDD is replaced.

The following materials are needed

- a disc for installing HD Image

Procedure

- (1) Turn the power of the main unit off.
- (2) Eject the tray by inserting a pin into the hole on the fitting. Refer to [Removing the fitting] in Disassembly section.
- (3) Set the HD image installation disc and then close the tray.
- (4) Shortly after pressing the power button, "Press any key to continue...." is displayed in the bottom of the screen. Press any key.
- (5) "Power Quest Image Center" will run to start the preinstallation.
- (6) "Finish Q:\>" is displayed when the preinstallation is completed. Remove the disc by pushing the EJECT button on the fitting.
- (7) Push the power button to turn OFF.
 - What is Power Quest Image Center ?
Operation of data input by using a software Image Center made by Power Quest.

5.2 BIOS update procedure

After the main board replacement, conform BIOS version to the previous BIOS version. (However, if the client wish an update, comply with the client's request.) When BIOS update is required as a result of modification, refer to JVC homepage for detail.

Notice for BIOS update

- Make sure to exit all the applications or programs that are running. Resident software such as antivirus software must also be either finished or canceled.
- Disconnect all the peripheral appliances, modem cables, and LAN cables.
- Do not perform system shutdown, reset operation, or power cut off during the update procedure as it may disable restart function.
- Cancel all the passwords on the BIOS or HDD when starting BIOS, and then perform the update procedure.
- Make sure to connect to AC adapter and fit with a fully loaded battery when updating. (Prepare two ways of power supply in case of power down, adapter dropout, or battery shortage.)

The following materials are needed

- USB connection floppy disc drive (Provision from JVC)
- A_FLASH2 disc (Provision from JVC)
- BIOS update file (Download from JVC homepage)

Update procedure

1. BIOS update disc creation

- (1) Download an update file from JVC homepage.
- (2) Save the updated file to the route of A_FLASH2 disc.

2. Start from the USB connected floppy disc drive.

- (1) Insert BIOS update disc into the floppy disc drive and connect it to the PC via USB.
- (2) Press the button to turn on and to start DOS. [A:\>_] is displayed on the screen.

3. Execution

- (1) Input[aflash2]after [A:\>_] then press Enter key.[ACPI BIOS Flash Memory Write V2.05] will start running.
- (2) Display on the screen is as shown below, input [2] then press Enter Key.

Choose one of the followings :

- 1.Save current BIOS to file
- 2.Updata BIOS to flash Memory

Enter choice [2]

- (3) Display on the screen is as shown below, input the update file name.

(e.g.) 0201j3n.rom

•If you input a wrong file name, [FILE NOT OPEN]will be displayed on the screen. Press any key to start again and input the correct file name.

Please input file name of new BIOS : _

- (4) Input [Y] answering the question on the screen shown as below. The update will start.

Are your sure to replace BIOS? (Y/N) : [Y]

- (5) When the update is completed properly, [Successfully! press any key to continue.] is displayed. Press any key to return to the initial screen.

- (6) Press [ESC]key to return to DOS screen. Turn the switch off to finish the procedure.

5.3 Diagnosis on HDD

By operating this procedure, HDD failure is self diagnosed.

The following materials are needed. (Provision from JVC)

- USB connection floppy disc drive
- Drive Fitness Test disc

Diagnosis procedure

1. Start from USB connected floppy disc drive.

- (1) Insert Drive Fitness Test disc into the floppy disc drive and connect the floppy disc drive to the PC via USB.
- (2) Press the power button to turn the PC on. The PC DOS 7.0 Startup Menu will start running shortly. Input [2] and press ENTER key.

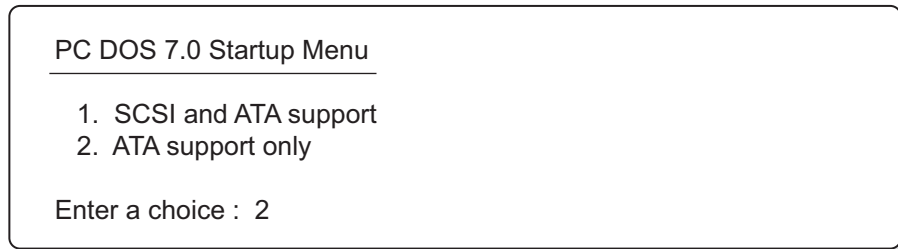

2. Execution

- (1) When [License Agreement] is displayed, input [A].

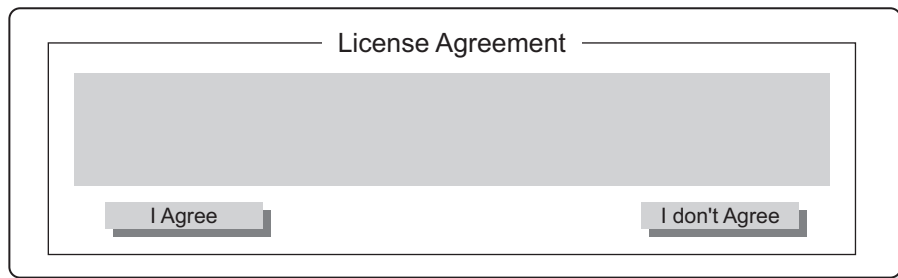

- (2) When [Device List] is displayed, select [Primary Master] and input [Y].

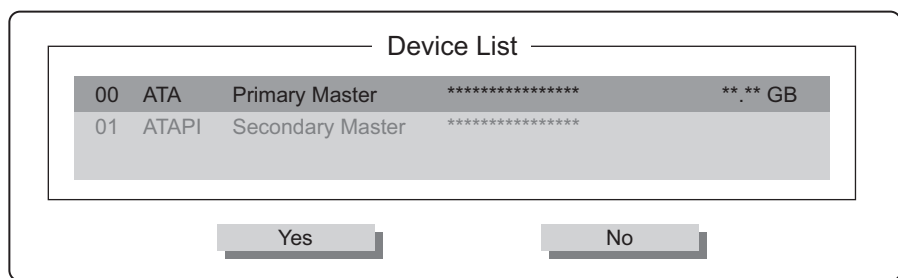

- (3) The screen returns to [Device List] confirmation display. Input [A].

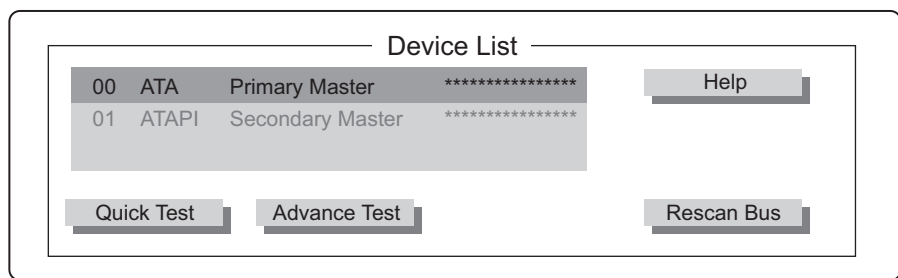

(4) When [Advanced Test] is displayed, input [S].

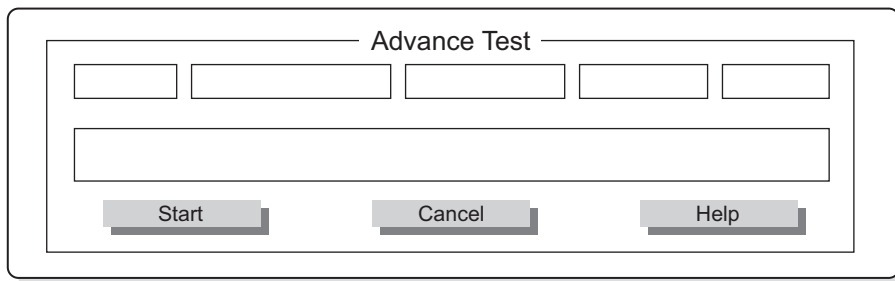

(5) [Test Results] is displayed. If no bad sector is detected on the HDD, [Operation completed successfully] is displayed. As a result the HDD has been diagnosed as proper.

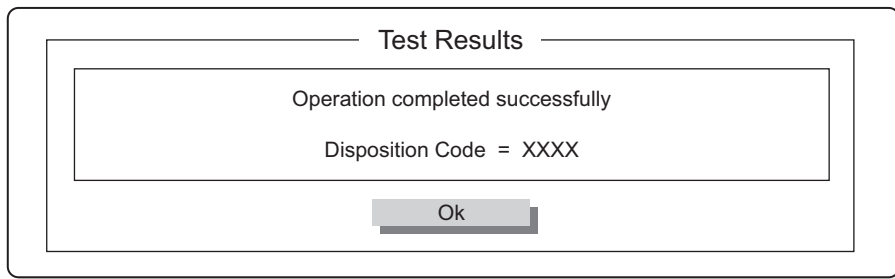

(6) Input [O], to return to [Device List] display. Press [Alt] key and [X] at the same time, [Confirmation] screen is displayed. Next input [Y].

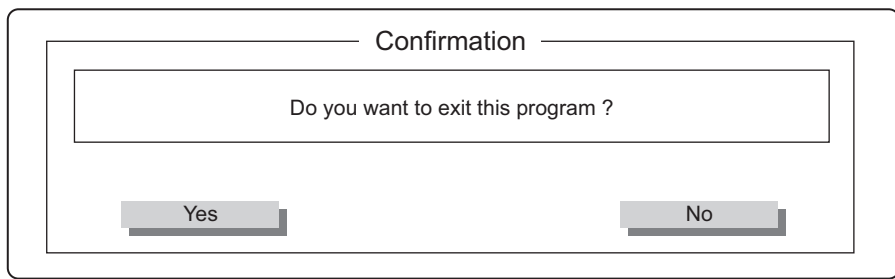

(7) When [Exit] screen is displayed, press power button to turn the PC off to finish the procedure.

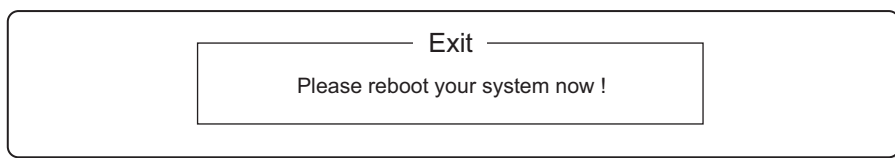

5.4 Caution in replacing a bottom case

- **COA LABEL**

[LE40888-002A/COA LABEL PRO] can not be reused. When replacing the bottom case, COA LABEL is also needed.

- **Serial label**

Serial labels with model names and serial numbers are not stocked as service parts. Reuse the serial label. Use glue remover when removing the serial label.

Parts No:UN-001

Parts name:SUBSIDIARY MATERIAL

Removing the serial label

- (1) Drip a few drops of glue remover onto the spatula .
- (2) Immediately remove the serial label slowly and carefully with a spatula.
- (3) If any stickiness left on the surface of the label, drip few more drops of glue remover and wipe with some tissue paper.

5.5 Main board replacing procedure

- (1) Replace parts from the previous MAIN BOARD.
 - Replace [HDD].
 - Replace [LAN BOARD ASSY].
 - Replace an expansion memory. (If there is any)
- (2) Adjust after the main board replacement.
 - Conform the BIOS version to the previous MAIN BOARD.
 - If the client wish an update, comply with the client's request.
- (3) Perform an operation check after the replacement of the main board.
 Perform an operation check according to the [Operation check item list after the repair is completed].

5.6 Operation check item list after the repair is completed

	Item	Contents	Required equipment
1	IEEE1394	Is the digital video camera recognized, when it is connected to IEEE1394 port?	JVC digital video camera
2	PC CARD SLOT	Is the PC card which is corresponding to Card Bus recognized, when it is inserted into PC CARD SLOT?	PC card, that is corresponding to Card Bus, on the market.(e.g. 100Mbase-T LAN card)
3	USB	Is the mouse recognized, when it is connected to USB?	USB mouse on the market (Low transfer rate)
4	MIC	Can the sound be recorded, when a MIC on the market is connected?	MIC on the market
5	HEADPHONE	Can the sound be heard, when a headphone on the market is connected?	Headphone on the market
6	LAN	Is the network recognized, when it is connected to LAN?	Network
7	WIRELESS LAN	Is the network recognized, when it is connected to WIRELESS LAN? Does WIRELESS LAN ON/OFF switch work?	Network, Access point for WIRELESS LAN
8	MODEM	Can the MODEM be connected to the Internet through the telephone line?	Telephone line. PPP account to connect dialup with the Internet.
9	DC in	Can AC be driven?	General power supply
10	BATTERY	Is the outer battery recognized? Can battery be driven? Can it be switched to charge mode?	Outer battery
11	RESET	Is RESET effective?	
12	KEYBOARD	Is the key input effective?	
13	STICK	Does the STICK work?	
14	THREE BOTTON	Does each button operate normally?	
15	SPEAKER	Is the sound emitted from both channels of the SPEAKER?	
16	RUNNING	Is there any trouble when it is continuously played back by Windows Media Player for eight hours?	
17	SD CARD SLOT	Is SD card recognized, when it is inserted into SD CARD SLOT?	
18	BUILT-IN MIC	Can it record sound?	
19	VOLUME	Is the VOLUME controllable?	
20	BRIGHTNESS CONTROL	Is the BRIGHTNESS controllable?	
21	DOCKING BOARD	Do both USB terminal and VGA terminal function, when a port replicator MP-DPX1is connected?	
22	ODD	Can it be opened and closed? Can playback be done with the play button on the TOP CASE?	
23	FAN	Is there any abnormal noise or operation?	



JVC

Victor Company of Japan, Limited
AV & MULTIMEDIA COMPANY MOBILE IT CATEGORY 1644, Shimotsuruma, Yamato, Kanagawa 242-8514, Japan

(No.XE003)