

# Multimedia User Guide

© Copyright 2008 Hewlett-Packard  
Development Company, L.P.

Microsoft, Windows, and Windows Vista are either trademarks or registered trademarks of Microsoft Corporation in the United States and/or other countries.

The information contained herein is subject to change without notice. The only warranties for HP products and services are set forth in the express warranty statements accompanying such products and services. Nothing herein should be construed as constituting an additional warranty. HP shall not be liable for technical or editorial errors or omissions contained herein.

First Edition: June 2008

Document Part Number: 469009-001

## Product notice

This user guide describes features that are common to most models. Some features may not be available on your computer.



---

# Table of contents

## 1 Multimedia features

Identifying your multimedia components .....	2
Using the media button .....	4
Adjusting the volume .....	5
Using the media activity functions .....	6
Using the media activity buttons .....	6
Previous/rewind button .....	6
Play/pause button .....	6
Next/fast forward button .....	7
Stop button .....	7
Using the media activity hotkeys .....	7

## 2 Multimedia software

Using QuickPlay software .....	9
Using other preinstalled multimedia software .....	10
Installing multimedia software from a disc .....	11

## 3 Audio

Connecting external audio devices .....	13
Checking your audio functions .....	14

## 4 Video

Connecting an external monitor or projector .....	16
Connecting an HDMI device .....	17
Configuring the audio using HDMI (select models only) .....	17
Watching TV .....	19

## 5 Optical drive

Identifying the installed optical drive .....	21
Using optical discs .....	22
Selecting the right disc .....	23
CD-R discs .....	23
CD-RW discs .....	23

DVD±R discs .....	23
DVD±RW discs .....	23
LightScribe DVD+R discs .....	23
HD DVD discs and Blu-ray Disc .....	24
Playing music .....	25
Watching a movie .....	26
Changing DVD region settings .....	27
Creating or “burning” a CD or DVD .....	28
Removing an optical disc (CD or DVD) .....	29

## 6 Webcam

Webcam tips .....	31
Adjusting webcam properties .....	32

## 7 Troubleshooting

The optical disc tray does not open for removal of a CD or DVD .....	34
The computer does not detect the optical drive .....	35
A disc does not play .....	36
A disc does not play automatically .....	37
A DVD movie stops, skips, or plays erratically .....	38
A DVD movie is not visible on an external display .....	39
The process of burning a disc does not begin, or it stops before completion .....	40
A device driver must be reinstalled .....	41
Obtaining the latest HP device drivers .....	41
Obtaining the latest Windows device drivers .....	42

<b>Index .....</b>	<b>43</b>
--------------------	-----------

---

# 1 Multimedia features

Your computer includes multimedia features that allow you to listen to music, watch movies, and view pictures. Your computer may include the following multimedia components:

- Optical drive for playing audio and video discs
- Integrated speakers for listening to music
- Integrated microphone for recording your own audio
- Integrated webcam that allows you to capture and share video
- Preinstalled multimedia software that allows you to play and manage your music, movies, and pictures
- Multimedia buttons and hotkeys that provide fast access to multimedia tasks

---

 **NOTE:** Your computer may not include all of the components listed.

---

The following sections explain how to identify and use the multimedia components included with your computer.

# Identifying your multimedia components

The following illustration and table describe the multimedia features of the computer.



Component	Description
(1) Internal microphones (2)	Record sound.
(2) Webcam light	Turns on when video software accesses the webcam.
(3) Webcam	Captures video.
(4) Volume scroll zone	Adjusts speaker volume. Slide your finger to the left to decrease volume and to the right to increase volume. You can also tap the minus sign on the scroll zone to decrease volume, or tap the plus sign on the scroll zone to increase volume.
(5) Speakers (2)	Produce sound.
(6) Audio-out (headphone) jacks (2)	Produce sound when connected to optional powered stereo speakers, headphones, earbuds, a headset, or television audio.

**NOTE:** When a device is connected to the headphone jack, the computer speakers are disabled.



Component	Description
(7) Audio-in (microphone) jack	Connects an optional computer headset microphone, stereo array microphone, or monaural microphone.
(8) Volume mute button	Mutes and restores speaker sound.

## Using the media button

The function of the media button varies by model and installed software. With this button, you can watch movies, listen to music, and view pictures.



Pressing the media button launches the QuickPlay program.

 **NOTE:** If the computer has been set up to require a logon password, you may be asked to log on to Windows. QuickPlay opens after you log on. Refer to the QuickPlay software Help for more information.

# Adjusting the volume

You can adjust the volume using the following controls:

- Computer volume buttons:
  - To mute or restore volume, press the mute button **(1)**.
  - To decrease volume, press the volume down button **(2)**, or slide your finger across the volume scroll zone from right to left.
  - To increase volume, press the volume up button **(3)**, or slide your finger across the volume scroll zone from left to right.

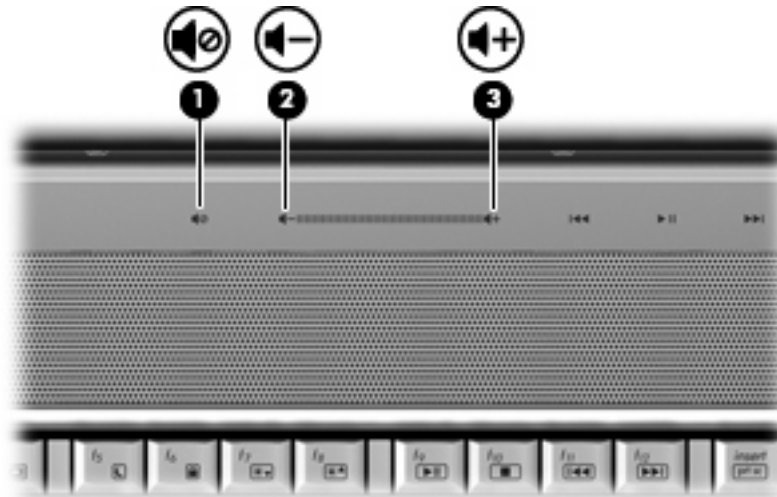

- Windows® volume control:
  - a. Click the **Volume** icon in the notification area, at the far right of the taskbar.
  - b. Increase or decrease the volume by moving the slider up or down. Click the **Mute** icon to mute the volume.

– or –

- a. Right-click the **Volume** icon in the notification area, and then click **Open Volume Mixer**.
- b. In the Device column, increase or decrease the volume by moving the slider up or down. You can also mute the volume by clicking the **Mute** icon.

If the Volume icon is not displayed in the notification area, follow these steps to add it:

- a. Right-click in the notification area, and then click **Properties**.
  - b. Click the **Notification Area** tab.
  - c. Under System icons, select the **Volume** check box.
  - d. Click **OK**.
- Program volume control:

Volume can also be adjusted within some programs.

## Using the media activity functions

The media activity buttons (select models only) and the media activity hotkeys control the play of an audio CD or a DVD in the optical drive.

### Using the media activity buttons

The following illustration and tables describe the functions of the media activity buttons when a disc is in the optical drive.

- Previous/rewind button (1)
- Play/pause button (2)
- Next/fast forward button (3)
- Stop button (4)

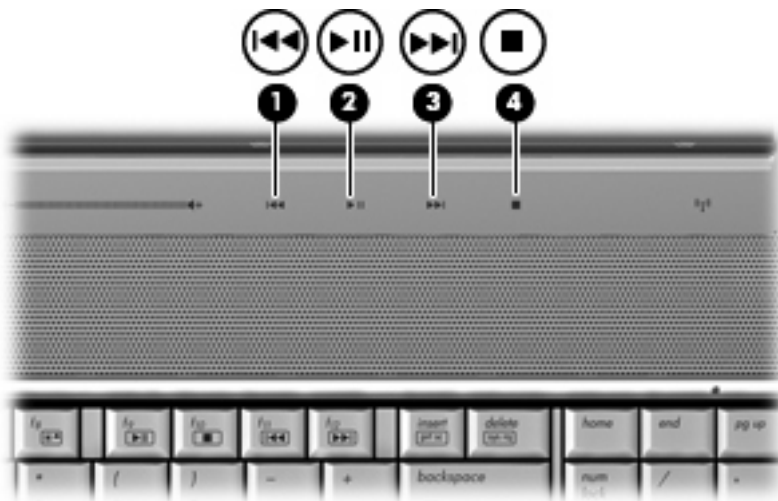

### Previous/rewind button

Disc status	Button	Function
Playing	Previous/rewind button	Plays a previous track or chapter.
Playing	fn + previous/rewind button	Rewinds the playback.

### Play/pause button

Disc status	Button	Function
Not playing	Play/pause button	Plays the disc.
Playing	Play/pause button	Pauses the playback.

## Next/fast forward button

Disc status	Button	Function
Playing	Next/fast forward button	Plays the next track or chapter.
Playing	fn + next/fast forward button	Fast forwards the playback.

## Stop button

Disc status	Button	Function
Playing	Stop button	Stops the playback.

## Using the media activity hotkeys

A media activity hotkey is a combination of the **fn** key (1) and a function key (2).

- When an audio CD or a DVD is not playing, press **fn+f9 (3)** to play the disc.
- When an audio CD or a DVD is playing, use the following hotkeys:
  - To pause or resume playing the disc, press **fn+f9 (3)**.
  - To stop the disc, press **fn+f10 (4)**.
  - To play the previous track of an audio CD or the previous chapter of a DVD, press **fn+f11 (5)**.
  - To play the next track of an audio CD or the next chapter of a DVD, press **fn+f12 (6)**.



---

## 2 Multimedia software

Your computer includes preinstalled multimedia software that allows you to play music, watch movies, and view pictures. The following sections provide details about QuickPlay and other preinstalled multimedia software.

# Using QuickPlay software

QuickPlay turns your computer into a mobile entertainment center. With QuickPlay, you can enjoy music and DVD movies. You can also play and sing along with karaoke CDs (select models only) and view and record live TV. QuickPlay includes the following features:

- Internet TV—Classic oldies, a range of TV shows and channels, as well as the HP-TV channel streamed in full-screen to computers with an Internet connection.
- Playlist upload support:
  - Upload your QuickPlay photo playlists to Internet photo albums, such as Snapfish.
  - Upload your QuickPlay video playlists to YouTube.
  - Export your QuickPlay playlist to the CyberLink DVD Suite.
- Pandora Internet radio (North America only)—Listen to music selected just for you, streamed from the Internet.

To start QuickPlay:

- ▲ Press the media button on your computer.

For more information on using QuickPlay, refer to the software Help.

## Using other preinstalled multimedia software

To locate other preinstalled multimedia software:

- ▲ Select **Start > All Programs**, and then open the multimedia program you want to use. For example, if you want to use Windows Media Player to play an audio CD, click **Windows Media Player**.

---

 **NOTE:** Some programs may be located in subfolders.

---



## Installing multimedia software from a disc

To install any multimedia software from a CD or DVD, follow these steps:

1. Insert the disc into the optical drive.
2. When the installation wizard opens, follow the on-screen instructions.
3. Restart the computer if you are prompted to do so.

---

 **NOTE:** For details about using software included with the computer, refer to the software manufacturer's instructions, which may be provided with the software, on disc, or on the manufacturer's Web site.

---

---

## 3 Audio

Your computer enables you to use a variety of audio features:

- Play music using your computer speakers and/or connected external speakers
- Record sound using the internal microphone or connect an external microphone
- Download music from the Internet
- Create multimedia presentations using audio and images
- Transmit sound and images with instant messaging programs
- Stream radio programs (select models only) or receive FM radio signals
- Create or “burn” audio CDs

# Connecting external audio devices

 **WARNING!** To reduce the risk of personal injury, adjust the volume before putting on headphones, earbuds, or a headset. For additional safety information, refer to the *Regulatory, Safety and Environmental Notices*.

---

To connect external devices such as external speakers, headphone, or a microphone, refer to the information provided with the device. For best results, remember the following tips:

- Be sure that the device cable is securely connected to the correct jack on your computer. (Cable connectors are normally color-coded to match the corresponding jacks on the computer.)
- Be sure to install any drivers required by the external device.

 **NOTE:** A driver is a required program that acts like a translator between the device and the programs that use the device.

---

## Checking your audio functions

To check the system sound on your computer, follow these steps:

1. Select **Start > Control Panel**.
2. Click **Hardware and Sound**.
3. Click **Sound**.
4. When the Sound window opens, click the **Sounds** tab. Under **Program**, select any sound event, such as a beep or alarm, and click the **Test** button.

You should hear sound through the speakers or through connected headphones.

To check the record functions of the computer, follow these steps:

1. Select **Start > All Programs > Accessories > Sound Recorder**.
2. Click **Record** and speak into the microphone. Save the file to your desktop.
3. Open Windows Media Player or QuickPlay and play back the sound.

---

 **NOTE:** For best results when recording, speak directly into the microphone and record sound in a setting free of background noise.

---

- ▲ To confirm or change the audio settings on your computer, right-click the **Sound** icon on the taskbar, or select **Start > Control Panel > Hardware and Sound > Sound** icon.

---

# 4 Video

Your computer enables you to use a variety of video features:

- Watch movies
- Play games over the Internet
- Edit pictures and video to create presentations
- Connect external video devices
- Watch TV, including high-definition TV (select models only)

## Connecting an external monitor or projector

The external monitor port connects an external display device such as an external monitor or a projector to the computer.

- ▲ To connect a display device, connect the device cable to the external monitor port.

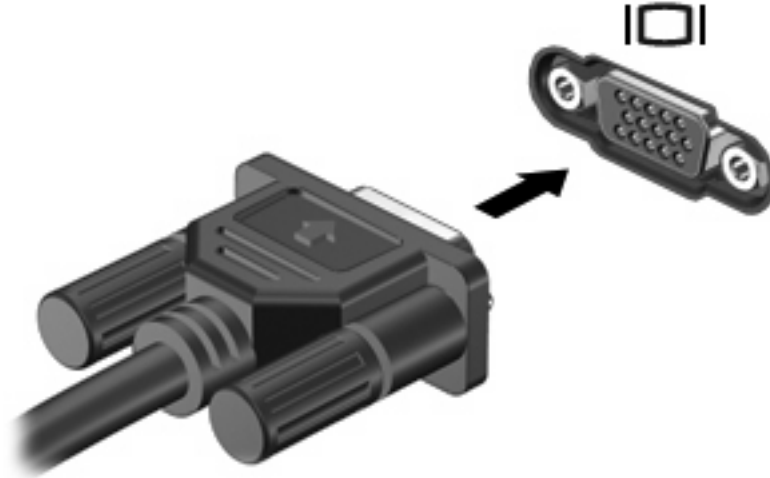

---

 **NOTE:** If a properly connected external display device does not display an image, press **fn+f4** to transfer the image to the device. Repeatedly pressing **fn+f4** alternates the screen image between the computer display and the device.

---

## Connecting an HDMI device

The computer includes an HDMI (High Definition Multimedia Interface) port. The HDMI port connects the computer to an optional video or audio device, such as a high-definition television, or any compatible digital or audio component.

The computer can support one HDMI device connected to the HDMI port, while simultaneously supporting an image on the computer display or any other supported external display.

 **NOTE:** To transmit video signals through the HDMI port, you need an HDMI cable (purchased separately), available from most electronics retailers.

To connect a video or audio device to the HDMI port:

1. Plug one end of the HDMI cable into the HDMI port on the computer.

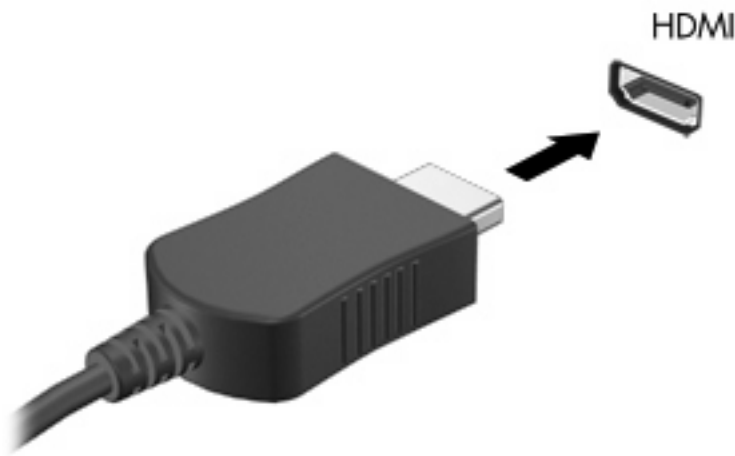

2. Connect the other end of the cable to the video device, according to the device manufacturer's instructions.
3. Press **fn+f4** on the computer to switch the image between the display devices connected to the computer.

## Configuring the audio using HDMI (select models only)

To configure, first connect an audio or video device, such as a high-definition TV, to the HDMI port on your computer, and for best results use QuickPlay as your media program.

You must also determine what type of graphics card is installed on your computer, and then configure the default audio playback device according to that graphics card.

### Determining the type of graphics card installed on your computer

- ▲ Check the label on the computer keyboard.

– or –

1. Select **Start > Computer > System properties**.
2. In the left pane, click **Device Manager**, and then click **Display adapters**.

### **Setting HDMI as the default audio playback device**

1. Select **Start > Control Panel > Hardware and Sound > Sound** icon.
2. Click the **Playback** tab, click **Digital Output Device (HDMI)**, and then click **Set Default**.
3. Click **OK**.
4. Start QuickPlay, or if it is already running, close it, and then restart it.



## Watching TV

Your computer may have an integrated TV tuner (select models only), or you may have an optional external TV tuner. A TV tuner enables you to watch, record, and pause live TV on the computer. In addition, if your computer includes an integrated TV tuner, then two remote controls are included in the box with the computer.

- **HP Mobile Remote Control**—Provides remote control of some features such as audio and video disc playback and can be stored in the Express Card slot.
- **HP Media Remote Control**—Provides more comprehensive remote control of features such as viewing TV and is larger than the HP Mobile Remote Control.

Before you can watch TV on the computer, be sure that you have set up the TV tuner according to the instructions provided in the printed *Notebook Essentials* guide included with the computer or in the user guide included with your optional external TV tuner.

You can view TV in QuickPlay TV mode, using a TV tuner or live streaming over the Internet. You can also schedule recordings and view recorded TV shows on your computer.

 **NOTE:** Some features of QuickPlay TV mode, such as Internet streaming, may not be available in all regions and may also require additional hardware or services, such as a high-speed Internet connection.

QuickPlay TV mode supports the following options:

- **Slingbox**—Plays current TV broadcasts from your home TV.
- **EPG**—Displays the EPG (electronic program guide).
- **Live TV**—Plays live TV broadcasts.
- **Recorded TV**—Displays programs recorded from the TV.
- **Schedule**—Displays all current recording schedules.
- **Internet TV**—Plays current TV broadcasts from the Internet.

This section explains how to watch TV using the HP Media Remote Control.

To view live television, follow these steps:

1. Press the TV button on the HP Media Remote Control to open the QuickPlay TV mode.
2. Use the arrow keys to select the source name, and then press the OK button. The TV broadcast begins to play in the preview window.
3. To watch in full-screen format, press the right arrow to move the cursor to the preview window, and then press the OK button.

 **NOTE:** You can also use the keyboard to perform these steps.

To view a previously recorded TV program, follow these steps:

1. Press the TV button on the HP Media Remote Control to open the QuickPlay TV mode.
2. Use the arrow keys to select Recorded TV, and then press the OK button. The console is refreshed to display a list of any programs you have recorded.

3. Use the arrow keys to select the program you want to view, and then press the OK button. The recorded program begins to play in the preview window.
4. To watch in full-screen format, press the right arrow to move the cursor to the preview window and then press the OK button.

---

 **NOTE:** You can also use the keyboard to perform these steps.

---

For more information on using QuickPlay to watch TV, refer to the QuickPlay software help.

---

# 5 Optical drive

Your computer includes an optical drive that expands the functionality of the computer. Identify what kind of device is installed in your computer to see its capabilities. The optical drive allows you to read data discs, play music, and watch movies. If your computer includes a Blu-ray Disc ROM Drive or an HD DVD Drive, then you can also watch high-definition video from disc.

## Identifying the installed optical drive

▲ Select **Start > Computer**.

You will see a list of all the devices installed on your computer, including your optical drive. You may have one of the following types of drives:

- DVD-ROM Drive
- DVD±RW/R and CD-RW Combo Drive
- DVD±RW/R and CD-RW Combo Drive with Double-Layer (DL) support
- HD DVD-R Drive with SuperMulti DVD±R/RW Double Layer (DL) support
- HD DVD-ROM Drive with SuperMulti DVD±R/RW Double Layer (DL) support
- LightScribe DVD±RW/R and CD-RW Combo drive with Double-Layer (DL) support
- Blu-ray Disc ROM Drive with SuperMulti DVD±R/RW Double Layer (DL) support

---

 **NOTE:** Some of the drives listed above may not be supported by your computer.

---

## Using optical discs

An optical drive, such as a DVD-ROM drive, supports optical discs (CDs and DVDs). These discs store information, such as music, photos, and movies. DVDs have a higher storage capacity than CDs.

Your optical drive can read standard CD and DVD discs. If your optical drive is a Blu-ray Disc ROM Drive, it can also read Blu-ray discs. If your optical drive is an HD DVD drive, it can also read HD DVD discs.

 **NOTE:** Some of the optical drives listed may not be supported by your computer. The listed drives are not necessarily all of the supported optical drives.

Some optical drives can also write to optical discs as described in the following table.

Optical drive type	Write to CD-RW	Write to DVD $\pm$ RW/R	Write to DVD+R DL	Write label to LightScribe CD or DVD $\pm$ RW/R	Write to HD DVD
DVD $\pm$ RW/R and CD-RW Combo Drive	Yes	Yes	No	No	No
DVD $\pm$ RW/R and CD-RW Combo Drive with DL support	Yes	Yes	Yes	No	No
HD DVD-R Drive with SuperMulti DVD $\pm$ R/RW DL support	Yes	Yes	Yes	No	Yes
HD DVD-ROM Drive with SuperMulti DVD $\pm$ R/RW DL support	Yes	Yes	Yes	No	No
LightScribe DVD $\pm$ RW/R and CD-RW Combo Drive with DL support	Yes	Yes	Yes	Yes	No
Blu-ray Disc ROM Drive with SuperMulti DVD $\pm$ R/RW DL support	Yes	Yes	Yes	No	No

 **CAUTION:** To prevent possible audio and video degradation, loss of information, or loss of audio or video playback functionality, do not initiate Sleep or Hibernation while reading or writing to a CD or DVD.

To prevent loss of information, do not initiate Sleep or Hibernation when writing to a CD or DVD.

## Selecting the right disc

An optical drive supports optical discs (CDs and DVDs). CDs, used to store digital data, are also used for commercial audio recordings and are convenient for your personal storage needs. DVDs are used primarily for movies, software, and data backup purposes. DVDs are the same form factor as CDs but have at least 8 times the storage capacity.

 **NOTE:** The optical drive on your computer may not support all the types of optical discs discussed in this section.

---

### CD-R discs

Use CD-R (write-once) discs to create permanent archives and to share files with virtually anyone. Typical uses include the following:

- Distributing large presentations
- Sharing scanned and digital photos, video clips, and written data
- Making your own music CDs
- Keeping permanent archives of computer files and scanned home records
- Offloading files from your hard drive to free up disk space

After data is recorded, it cannot be erased or written over.

### CD-RW discs

Use a CD-RW disc (a rewritable version of a CD) to store large projects that must be updated frequently. Typical uses include the following:

- Developing and maintaining large documents and project files
- Transporting work files
- Making weekly backups of hard drive files
- Updating photos, video, audio, and data continuously

### DVD±R discs

Use blank DVD±R discs to permanently store large amounts of information. After data is recorded, it cannot be erased or written over.

### DVD±RW discs

Use DVD±RW discs if you want to be able to erase or write over data that you saved earlier. This type of disc is ideal for testing audio or video recordings before you burn them to a CD or DVD that cannot be changed.

### LightScribe DVD+R discs

Use LightScribe DVD+R discs for sharing and storing data, home videos, and photos. These discs are read-compatible with most DVD-ROM drives and set-top DVD video players. With a LightScribe-enabled drive and LightScribe software, you can write data to the disc and then add a designer label to the outside of the disc.

## HD DVD discs and Blu-ray Disc

HD DVD is a high-density disc format designed for the storage of large amounts of data and high-definition video. The capacity for an HD DVD is 15 gigabytes (GB) for single layer and 30 GB for dual layer, about three times the capacity of a standard DVD.

Also called BD, Blu-ray Disc is a high-density optical disc format for the storage of digital information, including high-definition video. A single-layer Blu-ray Disc can store 25 GB, over five times the size of a single-layer DVD at 4.7 GB. A dual-layer Blu-ray Disc can store 50 GB, almost 6 times the size of a dual-layer DVD at 8.5 GB.

Typical uses include the following:

- Storage of large amounts of data
- High-definition video
- Video games

## Playing music

1. Turn on the computer.
2. Press the release button **(1)** on the optical drive bezel to release the disc tray.
3. Pull out the tray **(2)**.
4. Hold the disc by the edges and position the disc label-side up over the tray spindle.

---

 **NOTE:** If the tray is not fully accessible, tilt the disc carefully to position it over the spindle.

---

5. Gently press the disc **(3)** down onto the tray spindle until the disc snaps into place.

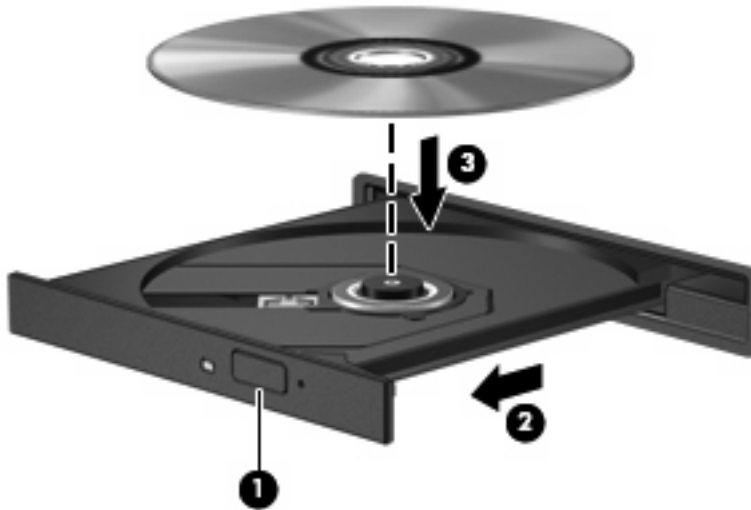

6. Close the disc tray.
7. If you have not yet configured AutoPlay, the AutoPlay dialog box opens and asks how you want to use the media content. Choose QuickPlay or Windows Media Player, both preinstalled on your computer.

---

 **NOTE:** After you insert a disc, a short pause is normal.

---

If Sleep or Hibernation is initiated during playback of a disc, you may experience the following behaviors:

- Your playback may be interrupted.
- You may see a warning message asking if you want to continue. If this message is displayed, click **No**.
- You may need to restart the CD or DVD to resume playback.

## Watching a movie

Your optical drive allows you to watch movies from a disc. You can also watch high-definition movies from a disc if your computer includes an optional Blu-ray Disc ROM Drive or an optional HD DVD Drive.

1. Turn on the computer.
2. Press the release button **(1)** on the optical drive bezel to release the disc tray.
3. Pull out the tray **(2)**.
4. Hold the disc by the edges and position the disc label-side up over the tray spindle.

---

 **NOTE:** If the tray is not fully accessible, tilt the disc carefully to position it over the spindle.

---

5. Gently press the disc **(3)** down onto the tray spindle.

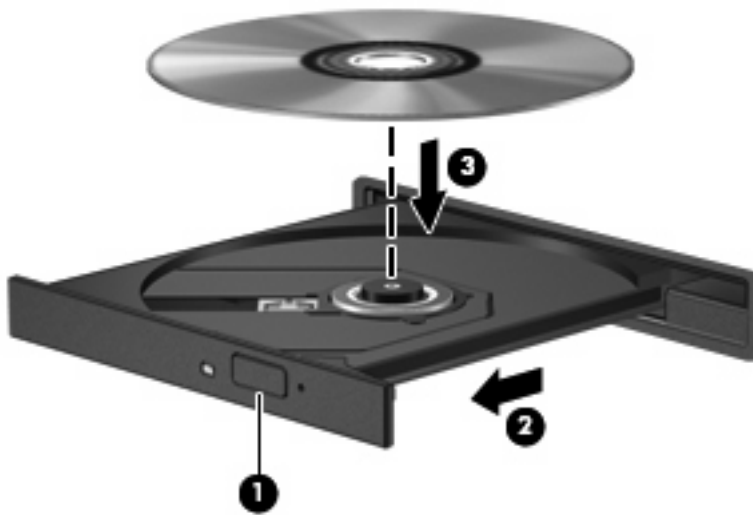

6. Close the disc tray.
7. Launch the DVD playback feature in QuickPlay by doing one of the following:  
Press the DVD button on the control panel  
– or –  
Press the media button, and then click the DVD icon and follow the instructions on the screen.

---

 **NOTE:** To watch a high-definition movie, you must use QuickPlay software.

---



# Changing DVD region settings

Most DVDs that contain copyrighted files also contain region codes. The region codes help protect copyrights internationally.

You can play a DVD containing a region code only if the region code on the DVD matches the region setting on your DVD drive.

---

△ **CAUTION:** The region settings on your DVD drive can be changed only 5 times.

The region setting you select the fifth time becomes the permanent region setting on the DVD drive.

The number of region changes remaining is displayed on the DVD Region tab.

---

To change settings through the operating system:

1. Select **Start > Computer > System properties**.
2. In the left pane, click **Device Manager**.

---

 **NOTE:** Windows includes the User Account Control feature to improve the security of your computer. You may be prompted for your permission or password for tasks such as installing software, running utilities, or changing Windows settings. Refer to Windows Help for more information.

---

3. Click the "+" sign next to **DVD/CD-ROM drives**.
4. Right-click the DVD drive for which you want to change region settings, and then click **Properties**.
5. Make the desired changes on the **DVD Region** tab.
6. Click **OK**.

## Creating or “burning” a CD or DVD

If your computer includes a CD-RW, DVD-RW, or DVD±RW optical drive, you can use software such as Windows Media Player or CyberLink Power2Go to burn data and audio files, including MP3 and WAV music files. To burn video files to a CD or DVD, use MyDVD.

Observe the following guidelines when burning a CD or DVD:

- Before burning a disc, save and close any open files and close all programs.
- A CD-R or DVD-R is usually best for burning audio files because after the information is copied, it cannot be changed.

---

 **NOTE:** You cannot create an audio DVD with CyberLink Power2Go.

---

- Because some home and car stereos will not play CD-RWs, use CD-Rs to burn music CDs.
- A CD-RW or DVD-RW is generally best for burning data files or for testing audio or video recordings before you burn them to a CD or DVD that cannot be changed.
- DVD players used in home systems usually do not support all DVD formats. Refer to the user guide that came with your DVD player for a list of supported formats.
- An MP3 file uses less space than other music file formats, and the process for creating an MP3 disc is the same as the process for creating a data file. MP3 files can be played only on MP3 players or on computers with MP3 software installed.

To burn a CD or DVD, follow these steps:

1. Download or copy the source files into a folder on your hard drive.
2. Insert a blank CD or DVD into the optical drive.
3. Select **Start > All Programs**, and then select the name of the software you want to use.

---

 **NOTE:** Some programs may be located in subfolders.

---

4. Select the kind of CD or DVD you want to create—data, audio, or video.
5. Right-click **Start**, click **Explore**, and navigate to the folder where the source files are stored.
6. Open the folder, and then drag the files to the drive that contains the blank optical disc.
7. Initiate the burning process as directed by the program you have selected.

For specific instructions, refer to the software manufacturer's instructions, which may be provided with the software, on disc, or on the manufacturer's Web site.

---

△ **CAUTION:** Observe the copyright warning. It is a criminal offense, under applicable copyright laws, to make unauthorized copies of copyright-protected material, including computer programs, films, broadcasts, and sound recordings. Do not use this computer for such purposes.

---

## Removing an optical disc (CD or DVD)

1. Press the release button (1) on the drive bezel to release the disc tray, and then gently pull out the tray (2) until it stops.
2. Remove the disc (3) from the tray by gently pressing down on the spindle while lifting the outer edges of the disc. Hold the disc by the edges and avoid touching the flat surfaces.

 **NOTE:** If the tray is not fully accessible, tilt the disc carefully as you remove it.

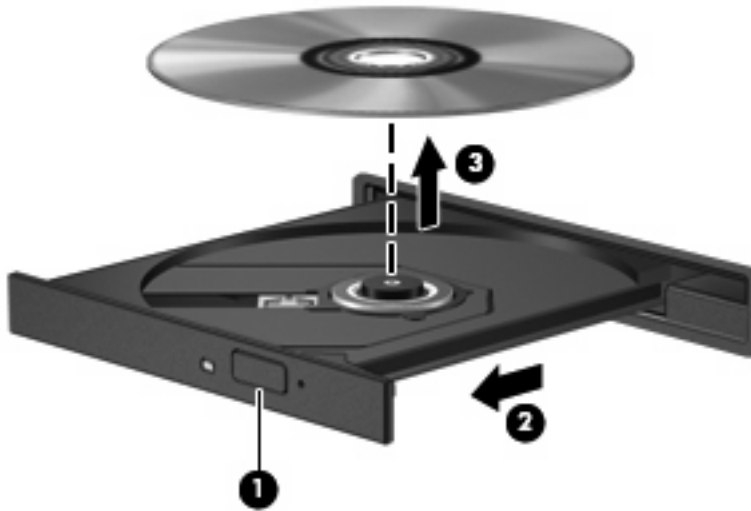

3. Close the disc tray and place the disc in a protective case.

---

## 6 Webcam

Your computer includes an integrated webcam, located at the top of the display. The webcam is an input device that allows you to capture and share video. Preinstalled CyberLink YouCam software provides new features that expand the webcam experience.

To access the webcam and CyberLink YouCam software, select **Start > All Programs > CyberLink YouCam > YouCam**.

---

 **NOTE:** The first time you access the YouCam software, you may experience a brief delay as the software loads.

---

Using YouCam as your default webcam software enables you to experiment with the following features:

- **Video**—Record and play back webcam video. You can also e-mail or upload video to YouTube, using the icon on the software interface.
- **Streaming video**—When you open your instant message program, YouCam displays a floating toolbar that lets you add graphic effects.
- **Special effects**—Add frames, filters, and emoticons to your snapshots and video.
- **Snapshots**—Take single frame or “burst” webcam shots in rapid succession.
- **Connect**—E-mail photos and video using the icon on the software interface.

---

 **NOTE:** For details about using webcam software, refer to the software manufacturer's instructions, which may be provided with the software, on disc, or on the manufacturer's Web site.

---

## Webcam tips

For optimum performance, observe the following guidelines while using the webcam:

- Be sure that you have the latest version of an instant message program before starting a video conversation.
- The webcam may not work properly across some network firewalls.

 **NOTE:** If you are having trouble viewing or sending multimedia files to someone on another LAN or outside your network firewall, temporarily disable the firewall, perform the task you want to perform, and then reenable the firewall. To permanently resolve the problem, reconfigure the firewall as necessary, and adjust the policies and settings of other intrusion detection systems. For additional information, contact your network administrator or IT department.

- Whenever possible, place bright light sources behind the camera and out of the picture area.

## Adjusting webcam properties

You can adjust webcam properties using the Properties dialog box, which is accessible from various programs that use the integrated camera, usually from a configuration, settings, or properties menu:

- **Brightness**—Controls the amount of light that is incorporated into the image. A higher brightness setting creates a brighter image; a lower brightness setting creates a darker image.
- **Contrast**—Controls the difference between lighter and darker areas on the image. A higher contrast setting intensifies the image; a lower contrast setting maintains more of the original information's dynamic range but leads to a flatter image.
- **Hue**—Controls the aspect of color that distinguishes it from another color (what makes a color red, green, or blue). Hue is distinct from saturation, which measures the intensity of the hue.
- **Saturation**—Controls the strength of color in the final image. A higher saturation setting creates a bolder image; a lower saturation setting creates a more subtle image.
- **Sharpness**—Controls the definition of edges in an image. A higher sharpness setting creates a more defined image; a lower sharpness setting creates a softer image.
- **Gamma**—Controls the contrast affecting the mid-level grays or midtones of an image. Adjusting the gamma of an image allows you to change the brightness values of the middle range of gray tones without dramatically altering the shadows and highlights. A lower gamma setting makes grays look black, and makes dark colors even darker.
- **Backlight Comp**—Compensates in cases where a subject with a large amount of background light would otherwise be obscured by blooming or silhouetting.

For information about using the webcam, select **Start > Help and Support**.

---

# 7 Troubleshooting

The following sections describe several common issues and resolutions.

## The optical disc tray does not open for removal of a CD or DVD

1. Insert the end of a paper clip (1) into the release access in the front bezel of the drive.
2. Press in gently on the paper clip until the disc tray is released, and then pull out the tray (2) until it stops.
3. Remove the disc (3) from the tray by gently pressing down on the spindle while lifting the outer edges of the disc. Hold the disc by the edges and avoid touching the flat surfaces.



**NOTE:** If the tray is not fully accessible, tilt the disc carefully as you remove it.

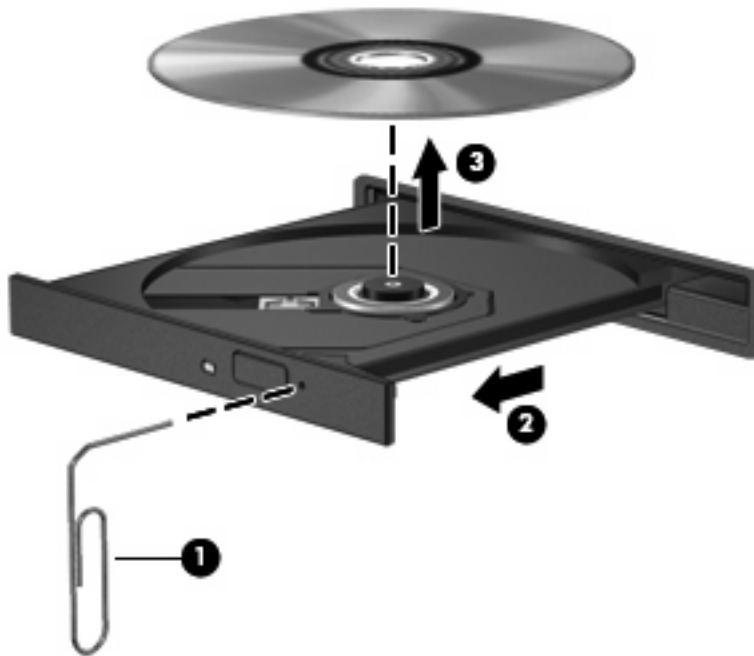

4. Close the disc tray and place the disc in a protective case.



## The computer does not detect the optical drive

If Windows does not detect an installed device, the device driver software may be missing or corrupted. If you suspect that the DVD/CD-ROM drive is not being detected, verify that the optical drive is listed in the Device Manager utility.

1. Remove any discs from the optical drive.
2. Click **Start** and type `device manager` in the **Start Search** box.

As you type, search results are listed in the pane above the box.

3. In the results pane, click **Device Manager**. If prompted by User Account Control, click **Continue**.
4. In the Device Manager window, click the plus sign (+) next to **DVD/CD-ROM drives**, unless a minus sign (-) is already showing. Look for an optical drive listing.

If the drive is not listed, install (or reinstall) the device driver as instructed in “A device driver must be reinstalled” found later in this section.

## A disc does not play

- Save your work and close all open programs before playing a CD or a DVD.
- Log off the Internet before playing a CD or a DVD.
- Be sure that you insert the disc properly.
- Be sure that the disc is clean. If necessary, clean the disc with filtered water and a lint-free cloth. Wipe from the center of the disc to the outer edge.
- Check the disc for scratches. If you find scratches, treat the disc with an optical disc repair kit available at many electronics stores.
- Disable Sleep mode before playing the disc.

Do not initiate Hibernation or Sleep while playing a disc. Otherwise, you may see a warning message asking if you want to continue. If this message is displayed, click **No**. After you click No, the computer may behave in either of the following ways:

- Playback may resume.
  - or –
  - The playback window in the multimedia program may close. To return to playing the disc, click the **Play** button in your multimedia program to restart the disc. In rare cases, you may need to exit the program and then restart it.
- Increase system resources:
    - Turn off printers and scanners, and unplug cameras and portable handheld devices. Disconnecting these Plug and Play devices frees up valuable system resources and results in better playback performance.
    - Change desktop color properties. Because the human eye cannot easily tell the difference between colors beyond 16 bits, you should not notice any loss of color while watching a movie if you lower system color properties to 16-bit color, as follows:
      1. Right-click on a blank area of the computer desktop, and select **Personalize > Display Settings**.
      2. Set **Colors** to **Medium (16 bit)**, if this setting is not already selected.

## A disc does not play automatically

1. Click **Start** and type `autoplay` in the **Start Search** box.

As you type, search results are listed in the pane above the box.

2. In the results pane, click **Autoplay**. If prompted by User Account Control, click **Continue**.
3. Select the check box for **Use AutoPlay for all media and devices**, and then click **Save**.

A CD or DVD should now start automatically when it is inserted into the optical drive.

## A DVD movie stops, skips, or plays erratically

- Press the **Play** button. You may have accidentally paused the movie.
- Clean the disc.
- Conserve system resources by trying the following suggestions:
  - Log off the Internet.
  - Change the color properties of the desktop:
    1. Right-click on a blank area of the computer desktop, and select **Personalize > Display Settings**.
    2. Set **Colors** to **Medium (16 bit)**, if this setting is not already selected.
  - Disconnect external devices, such as a printer, scanner, camera, or handheld device.

## A DVD movie is not visible on an external display

1. If both the computer display and an external display are turned on, press **fn+f5** one or more times to switch between the 2 displays.
2. Configure the monitor settings to make the external display primary:
  - a. Right-click on a blank area of the computer desktop, and select **Personalize > Display Settings**.
  - b. Specify a primary display and a secondary display.

---

 **NOTE:** When using both displays, the DVD image will not appear on any display designated as the secondary display.

---

To get information about a multimedia question not covered in this guide, go to **Start > Help and Support**.

## The process of burning a disc does not begin, or it stops before completion

- Be sure that all other programs are closed.
- Turn off Sleep mode and Hibernation.
- Be sure that you are using the right kind of disc for your drive. See your user guides for more information about disc types.
- Be sure that the disc is inserted properly.
- Select a slower write speed and try again.
- If you are copying a disc, save the information on the source disc to your hard drive before trying to burn the contents to a new disc, and then burn from your hard drive.
- Reinstall the disc-burning device driver located in the DVD/CD-ROM drives category in Device Manager.

## A device driver must be reinstalled

1. Remove any discs from the optical drive.
2. Click **Start** and type `device manager` in the **Start Search** box.  
As you type, search results are listed in the pane above the box.
3. In the results pane, click **Device Manager**. If prompted by User Account Control, click **Continue**.
4. In Device Manager, click the plus sign (+) next to the type of driver you want to uninstall and reinstall (for example, DVD/CD-ROMs, Modems, and so on) unless the minus sign (-) is already showing.
5. Click a listed driver, and press the `delete` key. When prompted, confirm that you want to delete the driver, but do not restart the computer.  
Repeat for any other drivers you want to delete.
6. In the Device Manager window, click the **Scan for hardware changes** icon in the toolbar. Windows scans your system for installed hardware and installs default drivers for anything requiring drivers.  

---

 **NOTE:** If you are prompted to restart the computer, save all open files, and then continue with the restart.

---
7. Reopen Device Manager, if necessary, and then verify that the drivers are once again listed.
8. Try running your program again.

If uninstalling and reinstalling the default device drivers does not correct the problem, you may need to update your drivers using the procedures in the following section.

## Obtaining the latest HP device drivers

You can obtain the latest HP device drivers in either of the following ways:

- Using the HP Update Utility
- Using the HP Web site

To use the HP Update Utility:

1. Select **Start > All Programs > HP > HP Update**.
2. On the HP Welcome screen, click **Settings** and select a time when the utility should check for software updates on the Web.
3. Click **Next** to immediately check for HP software updates.

To use the HP Web site:

1. Open your Internet browser, go to <http://www.hp.com/support>, and select your country or region.
2. Click the option for software and driver downloads, type your computer model number in the search box, and then press `enter`.

– or –

If you want a specific SoftPak, enter the SoftPak number in the Search box, press `enter`, and follow the instructions provided. Proceed to step 6.

3. Click your specific product from the models listed.
4. Click the Windows Vista® operating system.
5. When the list of drivers is displayed, click an updated driver to open a window containing additional information.
6. Click **Install now** to install the updated driver without downloading the file.

– or –

Click **Download only** to save the file to your computer. When prompted, click **Save** and then select a storage location on your hard drive.

After the file is downloaded, navigate to the folder where the file was stored, and double-click the file to install.

7. If prompted to do so, restart your computer after the installation is complete, and then verify the operation of the device.

## Obtaining the latest Windows device drivers

You can obtain the latest Windows device drivers by using Microsoft® Update. This Windows feature can be set to automatically check for and install updates for the Windows operating system and other Microsoft products.

To use Microsoft Update:

1. Open your Internet browser and go to <http://www.microsoft.com>.
2. Click **Security & Updates**.
3. Click **Microsoft Update** to get the latest updates for your computer operating system, programs, and hardware.
4. Follow the on-screen instructions to install Microsoft Update. If prompted by User Account Control, click **Continue**.
5. Click **Change settings** and select a time for Microsoft Update to check for updates to the Windows operating system and other Microsoft products.
6. If prompted to do so, restart your computer.



# Index

## A

- audio devices, connecting
  - external 13
- audio features 12
- audio functions, checking 14
- audio-in (microphone) jack 3
- audio-out (headphone) jacks 2

## B

- Blu-ray disc 24
- buttons
  - media 4
  - next/fast forward 6
  - play/pause 6
  - previous/rewind 6
  - stop 6
  - volume 5
  - volume mute 3

## C

- CD
  - burning 28
  - inserting 25
  - removing 29
- CD drive 22
- checking audio functions 14
- configuring HDMI 17

## D

- device drivers
  - HP drivers 41
  - Windows drivers 42
- drives, optical drive 22
- DVD
  - burning 28
  - changing region setting 27
  - inserting 25
  - removing 29
- DVD drive 22
- DVD region settings 27

## E

- earbuds 2
- external audio devices, connecting 13
- external monitor port 16

## H

- HD DVD disc 24
- HDMI
  - configuring 17
  - connecting 17
- HDMI port 17
- headphone (audio-out) jacks 2
- headphones 2
- high-definition devices, connecting 17

## I

- internal microphone, identifying 2
- issues, resolving 33

## J

- jacks
  - audio-in (microphone) 3
  - audio-out (headphone) 2

## M

- media activity buttons 6
- media activity hotkeys 7
- media button 4
- microphone, internal 2
- monitor, connecting 16
- movie, watching 26
- multimedia buttons 4
- multimedia components, identifying 2
- multimedia software 8, 10
- multimedia software, installing 11
- music, playing 25
- mute button, identifying 3

## O

- optical disc
  - Blu-ray 24
  - HD DVD 24
  - inserting 25
  - removing 29
  - using 22, 23
- optical drive
  - identifying 21
  - using 21

## P

- ports
  - HDMI 17
- ports, external monitor 16
- projector, connecting 16

## Q

- QuickPlay software 9

## R

- region codes, DVD 27

## S

- software
  - installing 11
  - multimedia 10
  - QuickPlay 9
  - Windows Media Player 10
- speakers 2

## T

- tips, webcam 31
- troubleshooting
  - device driver 41
  - disc burning 40
  - disc play 36, 37
  - DVD movie play 38
  - external display 39
  - HP device drivers 41

- optical disc tray 34
- optical drive detection 35
- Windows drivers 42
- TV, watching 19

## V

- video features 15
- volume 5
- volume buttons 5
- volume mute button, identifying 3
- volume scroll zone, identifying 2

## W

- watching TV 19
- webcam 2
- webcam light 2
- webcam properties, adjusting 32
- webcam tips 31
- webcam, using 30

