

Getting Started

HP Notebook

© Copyright 2011 Hewlett-Packard Development Company, L.P.

Bluetooth is a trademark owned by its proprietor and used by Hewlett-Packard Company under license. Microsoft and Windows are U.S. registered trademarks of Microsoft Corporation. SD Logo is a trademark of its proprietor.

The information contained herein is subject to change without notice. The only warranties for HP products and services are set forth in the express warranty statements accompanying such products and services. Nothing herein should be construed as constituting an additional warranty. HP shall not be liable for technical or editorial errors or omissions contained herein.

First Edition: May 2011

Document Part Number: 636770-001

Product notice

This guide describes features that are common to most models. Some features may not be available on your computer.

Software terms

By installing, copying, downloading, or otherwise using any software product preinstalled on this computer, you agree to be bound by the terms of the HP End User License Agreement (EULA). If you do not accept these license terms, your sole remedy is to return the entire unused product (hardware and software) within 14 days for a refund subject to the refund policy of your place of purchase.

For any further information or for requesting a full refund of the computer, please contact your local point of sale (the seller).

Safety warning notice

 **WARNING!** To reduce the possibility of heat-related injuries or of overheating the computer, do not place the computer directly on your lap or obstruct the computer air vents. Use the computer only on a hard, flat surface. Do not allow another hard surface, such as an adjoining optional printer, or a soft surface, such as pillows or rugs or clothing, to block airflow. Also, do not allow the AC adapter to come into contact with the skin or a soft surface, such as pillows or rugs or clothing, during operation. The computer and the AC adapter comply with the user-accessible surface temperature limits defined by the International Standard for Safety of Information Technology Equipment (IEC 60950).

Table of contents

1 Welcome	1
Finding information	2
2 Getting to know your computer	4
Top	4
TouchPad	4
Lights	5
Buttons	7
Keys	8
Front	9
Right side	10
Left side	11
Display	13
Rear	14
Bottom	15
3 Networking	16
Using an Internet service provider (ISP)	17
Connecting to a wireless network	17
Connecting to an existing WLAN	17
Setting up a new WLAN network	18
Configuring a wireless router	19
Protecting your WLAN	19
4 Keyboard and pointing devices	20
Using the keyboard	21
Using the action keys	21
Using pointing devices	22
Setting pointing device preferences	22
Using the TouchPad	22
Turning the TouchPad off and on	23

Navigating	23
Selecting	24
Using TouchPad gestures	24
Scrolling	25
Pinching/Zooming	25
Rotating	26
5 Maintenance	27
Inserting or removing the battery	27
Replacing or upgrading the hard drive	29
Removing the hard drive	29
Installing a hard drive	31
Adding or replacing memory modules	33
Updating programs and drivers	37
Routine care	38
Cleaning the display	38
Cleaning the TouchPad and keyboard	38
6 Backup and recovery	39
Restore	40
Creating restore media	40
Performing a system restore	41
Restoring using the dedicated recovery partition (select models only)	41
Restoring using the restore media	42
Changing the computer boot order	43
Backing up and recovering your information	43
Using Windows Backup and Restore	44
Using Windows system restore points	45
When to create restore points	45
Create a system restore point	45
Restore to a previous date and time	45
7 Customer support	46
Contacting customer support	47
Labels	48
8 Specifications	49
Input power	50
Operating environment	51

1 Welcome

- [Finding information](#)

After you set up and register the computer, it is important to take the following steps:

- **Connect to the Internet**—Set up your wired or wireless network so that you can connect to the Internet. For more information, refer to [Networking on page 16](#).
- **Update your antivirus software**—Protect your computer from damage caused by viruses. The software is preinstalled on the computer and includes a limited subscription for free updates. For more information, refer to the *HP Notebook Reference Guide*. For instructions on accessing this guide, refer to [Finding information on page 2](#).
- **Get to know your computer**—Learn about your computer features. Refer to [Getting to know your computer on page 4](#) and [Keyboard and pointing devices on page 20](#) for additional information.
- **Find installed software**—Access a list of the software preinstalled on the computer. Select **Start > All Programs**. For details about using the software included with the computer, refer to the software manufacturer's instructions, which may be provided with the software or on the manufacturer's Web site.

Finding information

The computer comes with several resources to help you perform various tasks.

Resources	For information about
<i>Quick Setup</i> poster	<ul style="list-style-type: none">• How to set up the computer• Help to identify computer components
<i>Getting Started</i> To access this guide: Select Start > Help and Support > User Guides . – or – Select Start > All Programs > HP > HP Documentation .	<ul style="list-style-type: none">• Computer features• How to connect to a wireless network specifications• How to use the keyboard and pointing devices• How to replace or upgrade the hard drive and memory modules• How to perform a backup and recovery• How to contact customer support• Computer specifications
<i>HP Notebook Reference Guide</i> To access this guide: Select Start > Help and Support > User Guides . – or – Select Start > All Programs > HP > HP Documentation .	<ul style="list-style-type: none">• Power management features• How to maximize battery life• How to use the multimedia features of the computer• How to protect the computer• How to care for the computer• How to update the software
Help and Support To access Help and Support, select Start > Help and Support . NOTE: For country- or region-specific support, go to http://www.hp.com/support , select your country or region, and follow the on-screen instructions.	<ul style="list-style-type: none">• Operating system information• Software, driver, and BIOS updates• Troubleshooting tools• How to access technical support
<i>Regulatory, Safety, and Environmental Notices</i> To access this guide: Select Start > Help and Support > User Guides . – or – Select Start > All Programs > HP > HP Documentation .	<ul style="list-style-type: none">• Regulatory and safety information• Battery disposal information

Resources	For information about
<p><i>Safety & Comfort Guide</i></p> <p>To access this guide:</p> <p>Select Start > Help and Support > User Guides.</p> <p>– or –</p> <p>Select Start >All Programs > HP > HP Documentation.</p> <p>– or –</p> <p>Go to http://www.hp.com/ergo.</p>	<ul style="list-style-type: none"> • Proper workstation setup, posture, health, and work habits • Electrical and mechanical safety information
<p><i>Worldwide Telephone Numbers</i> booklet</p> <p>This booklet is provided with your computer.</p>	<p>HP support telephone numbers</p>
<p>HP Web site</p> <p>To access this Web site, go to http://www.hp.com/support.</p>	<ul style="list-style-type: none"> • Support information • Ordering parts and finding additional help • Accessories available for the device
<p><i>Limited Warranty*</i></p> <p>To access the warranty:</p> <p>Select Start > Help and Support > User Guides > View Warranty Information.</p> <p>– or –</p> <p>Select Start > All Programs > HP > HP Documentation > View Warranty Information.</p> <p>– or –</p> <p>Go to http://www.hp.com/go/orderdocuments.</p>	<p>Warranty information</p>
<p>*You may find the expressly provided HP Limited Warranty applicable to your product located with the electronic guides on your computer and/or on the CD/DVD provided in the box. Some countries/regions may provide a printed HP Limited Warranty in the box. In countries/regions where the warranty is not provided in printed format, you may request a printed copy at http://www.hp.com/go/orderdocuments or write to:</p>	
<ul style="list-style-type: none"> • North America: Hewlett-Packard, MS POD, 11311 Chinden Blvd, Boise, ID 83714, USA • Europe, Middle East, Africa: Hewlett-Packard, POD, Via G. Di Vittorio, 9, 20063, Cernusco s/Naviglio (MI), Italy • Asia Pacific: Hewlett-Packard, POD, P.O. Box 200, Alexandra Post Office, Singapore 911507 	
<p>Please include your product number, warranty period (found on your serial number label), name, and postal address.</p>	

2 Getting to know your computer

- [Top](#)
- [Front](#)
- [Right side](#)
- [Left side](#)
- [Display](#)
- [Rear](#)
- [Bottom](#)

Top

TouchPad





Component	Description
(1)  TouchPad light	Turns the TouchPad on and off. Quickly double-tap the TouchPad light to turn the TouchPad on and off.
(2) TouchPad zone	Moves the pointer and selects or activates items on the screen.

Component		Description
(3)	Left TouchPad button	Functions like the left button on an external mouse.
(4)	Right TouchPad button	Functions like the right button on an external mouse.

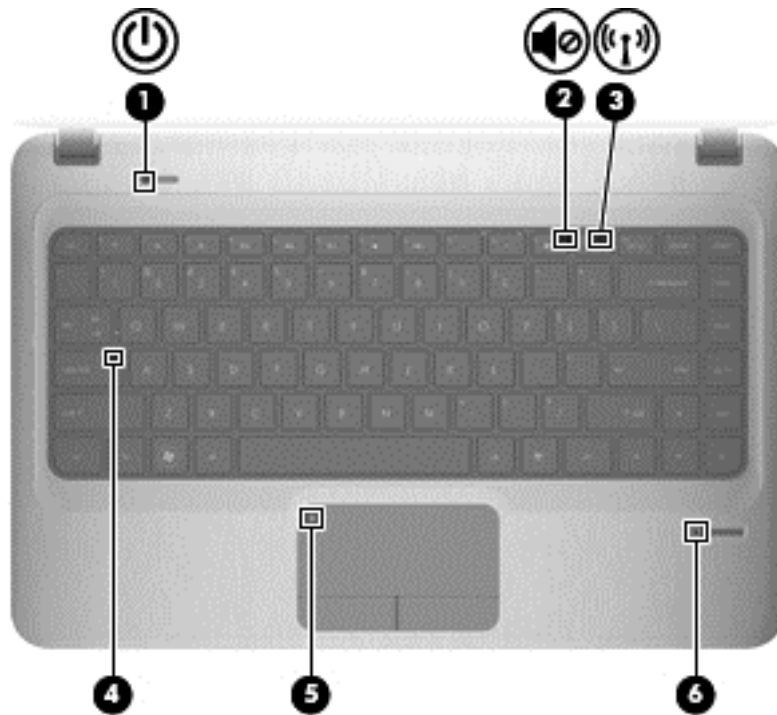
Lights



Component		Description
(1)	 Power light	<ul style="list-style-type: none"> White: Power is on. Blinking white: The computer is in the Sleep state. Off: The computer is off or in Hibernation. <p>NOTE: Another power light is located on the left side of the computer.</p>
(2)	 Mute light	<ul style="list-style-type: none"> Amber: Computer sound is off. Off: Computer sound is on.
(3)	 Wireless light	<ul style="list-style-type: none"> White: An integrated wireless device, such as a wireless local area network (WLAN) device and/or a Bluetooth® device, is on. Amber: All wireless devices are off.
(4)	Caps lock light	<ul style="list-style-type: none"> White: Caps lock is on. Off: Caps lock is off.

Component		Description
(5)	TouchPad light	<ul style="list-style-type: none">• Amber: The TouchPad is off.• Off: The TouchPad is on.
(6)	Fingerprint reader light	<ul style="list-style-type: none">• White: Fingerprint read is good.• Amber: Fingerprint read is bad.



Buttons

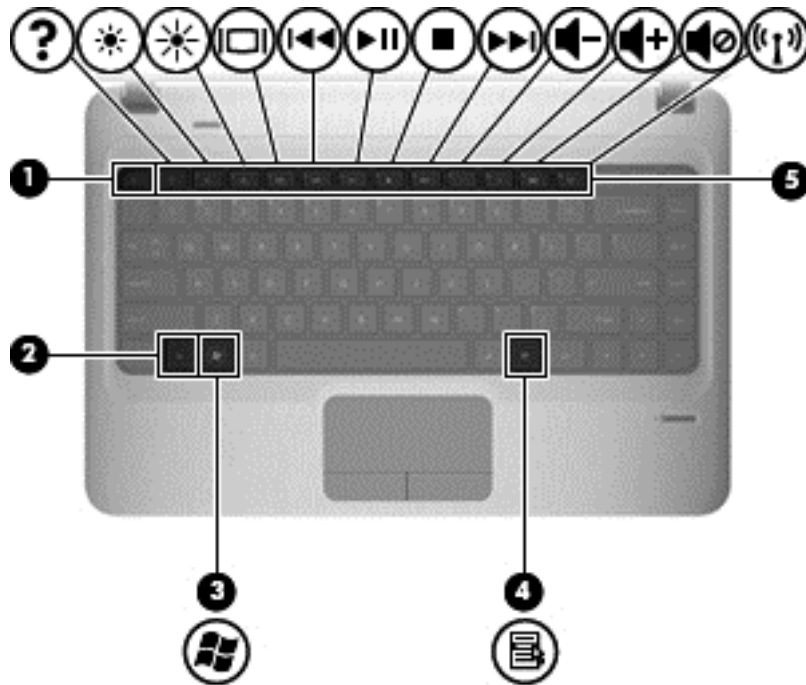

Component	Description
(1)  Power button	<ul style="list-style-type: none">• When the computer is off, press the button to turn on the computer.• When the computer is on, press the button briefly to initiate Sleep.• When the computer is in the Sleep state, press the button briefly to exit Sleep.• When the computer is in Hibernation, press the button briefly to exit Hibernation.
(2) Fingerprint reader	<p>If the computer has stopped responding and Windows® shutdown procedures are ineffective, press and hold the power button for at least 5 seconds to turn off the computer.</p> <p>To learn more about your power settings, select Start > Control Panel > System and Security > Power Options, or refer to the <i>HP Notebook Reference Guide</i>.</p> <p>Allows a fingerprint logon to Windows, instead of a password logon.</p>

Keys



Component	Description
(1) <code>esc</code> key	Displays system information when pressed in combination with the <code>fn</code> key.
(2) <code>fn</code> key	Executes frequently used system functions when pressed in combination with the <code>esc</code> key.
(3)  Windows logo key	Displays the Windows Start menu.
(4)  Windows applications key	Displays a shortcut menu for items beneath the pointer.
(5) Action keys	Execute frequently used system functions.



Front



Component	Description
(1) Digital Media Slot	Supports the following digital card formats: <ul style="list-style-type: none"><li data-bbox="842 531 1038 552">• MultiMediaCard<li data-bbox="842 579 1126 600">• Secure Digital (SD) Card<li data-bbox="842 630 1382 678">• Secure Digital High Capacity (SDHC) Memory Card (standard and large size)
(2) Speakers (2)	Produce sound.

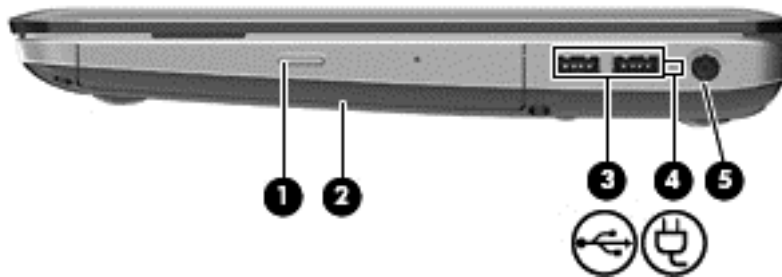





Right side

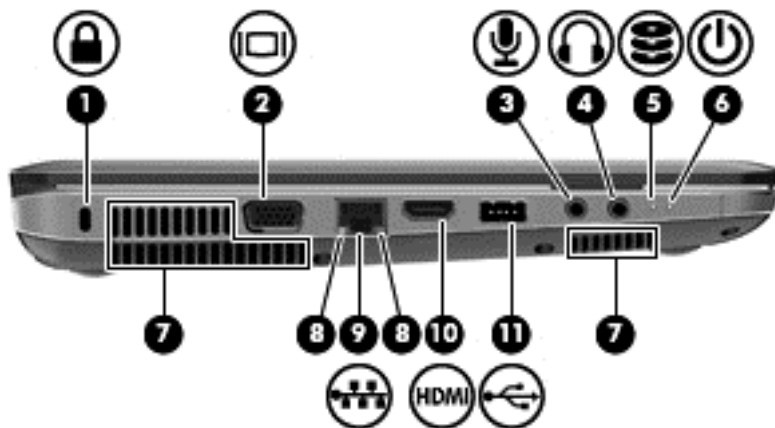



Component	Description
(1) Optical drive light	<ul style="list-style-type: none">• On: The optical drive is being accessed.• Off: The optical drive is idle.
(2) Optical drive	Reads and writes to an optical disc.
(3)  USB ports (2)	Connect optional USB devices.
(4) Battery light	<ul style="list-style-type: none">• White: The computer is connected to external power and the battery is fully charged.• Amber: A battery is charging.• Blinking: The battery has reached a low or critical battery level or there is a battery error.
(5)  Power connector	Connects an AC adapter.

Left side



Component	Description
(1) 	<p>Security cable slot</p> <p>Attaches an optional security cable to the computer.</p> <p>NOTE: The security cable is designed to act as a deterrent, but it may not prevent the computer from being mishandled or stolen.</p>
(2) 	<p>External monitor port</p> <p>Connects an external VGA monitor or projector.</p>
(3) 	<p>Audio-in (microphone) jack</p> <p>Connects an optional computer headset microphone, stereo array microphone, or monaural microphone.</p>
(4) 	<p>Audio-out (headphone) jack</p> <p>Produces sound when connected to optional powered stereo speakers, headphones, ear buds, a headset, or television audio.</p> <p>WARNING! To reduce the risk of personal injury, adjust the volume before putting on headphones, earbuds, or a headset. For additional safety information, refer to the <i>Regulatory, Safety and Environmental Notices</i>.</p> <p>NOTE: When a device is connected to the jack, the computer speakers are disabled.</p>
(5) 	<p>Drive light</p> <ul style="list-style-type: none"> Blinking white: The hard drive is being accessed. Amber: HP ProtectSmart Hard Drive Protection has temporarily parked the hard drive. <p>NOTE: For information on HP ProtectSmart Hard Drive Protection, refer to the <i>HP Notebook Reference Guide</i>.</p>
(6) 	<p>Power light</p> <ul style="list-style-type: none"> White: The computer is on. Blinking white: The computer is in the Sleep state. Off: The computer is off or in Hibernation.
(7) Vents (3)	<p>Enable airflow to cool internal components.</p> <p>NOTE: The computer fan starts up automatically to cool internal components and prevent overheating. It is normal for the internal fan to cycle on and off during routine operation.</p>

Component		Description
(8)	RJ-45 (network) lights	<ul style="list-style-type: none">• White: The network is connected.• Amber: The network is showing activity.
(9)	 RJ-45 (network) jack	Connects a network cable.
(10)	 HDMI	Connects an optional video or audio device, such as a high-definition television, or any compatible digital or audio component.
(11)	 USB port	Connects optional USB devices.

Display

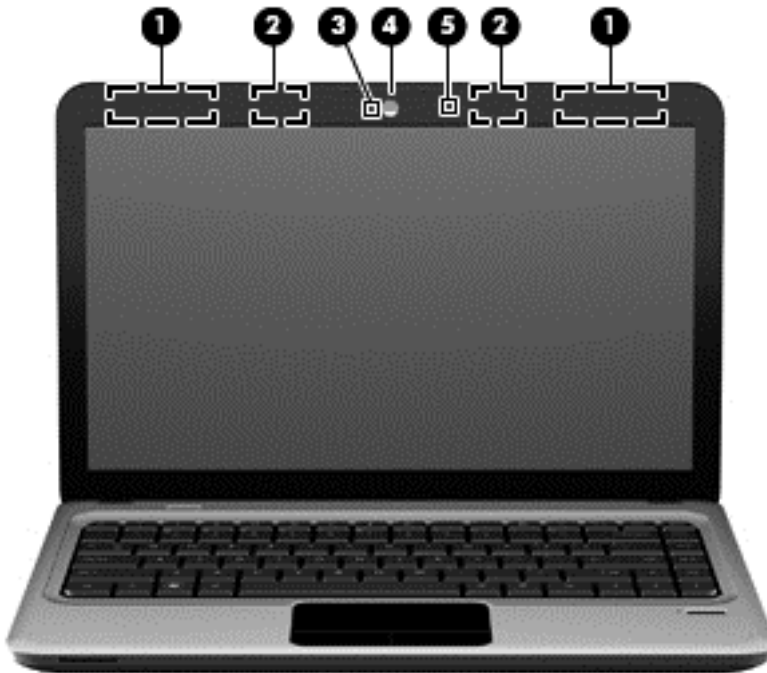

Component	Description
(1) WWAN antennas (2)* (select models only)	Send and receive wireless signals to communicate with wireless wide-area networks (WWAN).
(2) WLAN antennas (2)*	Send and receive wireless signals to communicate with wireless local area networks (WLAN).
(3) Webcam light	On: The webcam is in use.
(4) Webcam	Records video and captures still photographs. To use the webcam, select Start > All Programs > Cyberlink Youcam .
(5) Internal microphone	Records sound.

*The antennas are not visible from the outside of the computer. For optimal transmission, keep the areas immediately around the antennas free from obstructions. To see wireless regulatory notices, refer to the section of the *Regulatory, Safety and Environmental Notices* that applies to your country or region. These notices are located in Help and Support.



Rear

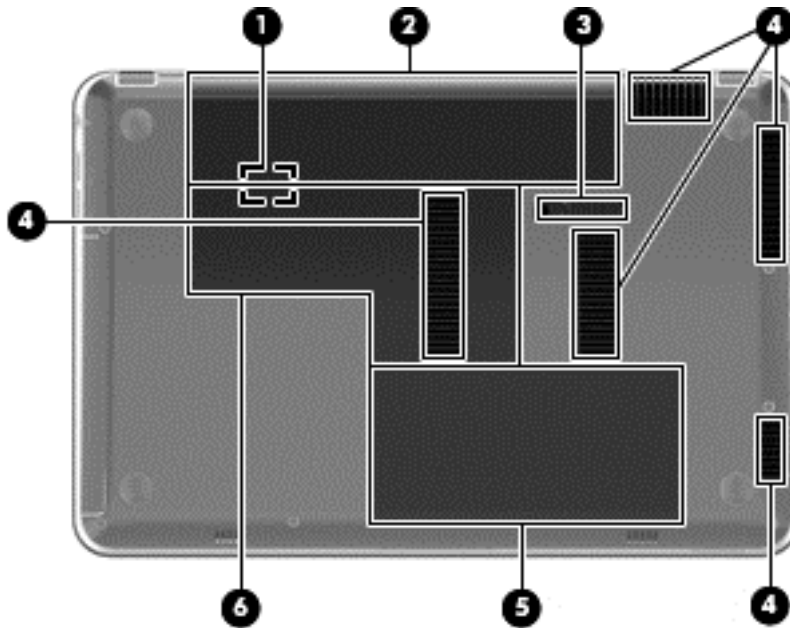

Component	Description
Vent	Enables airflow to cool internal components.
	NOTE: The computer fan starts up automatically to cool internal components and prevent overheating. It is normal for the internal fan to cycle on and off during routine operation.

Bottom



Component	Description
(1) SIM slot (select models only)	Supports a wireless subscriber identity module (SIM). The SIM slot is located inside the battery bay.
(2) Battery bay	Holds the battery.
(3)  Battery release latch	Releases the battery from the battery bay.
(4) Vents (5)	Enable airflow to cool internal components. NOTE: The computer fan starts up automatically to cool internal components and prevent overheating. It is normal for the internal fan to cycle on and off during routine operation.
(5)  Hard drive bay	Holds the hard drive.
(6)  Memory module compartment	Contains the memory module slots.

3 Networking

- [Using an Internet service provider \(ISP\)](#)
- [Connecting to a wireless network](#)



NOTE: Internet hardware and software features vary depending on computer model and your location.

Your computer may support one or both of the following types of Internet access:

- **Wireless**—For mobile Internet access, you can use a wireless connection. Refer to [Connecting to an existing WLAN on page 17](#) or [Setting up a new WLAN network on page 18](#).
- **Wired**—You can access the Internet by connecting to a wired network. For information on connecting to a wired network, refer to the *HP Notebook Reference Guide*.

Using an Internet service provider (ISP)

Before you can connect to the Internet, you must establish an ISP account. Contact a local ISP to purchase Internet service and a modem. The ISP will help set up the modem, install a network cable to connect your wireless computer to the modem, and test the Internet service.

 **NOTE:** Your ISP will give you a user ID and password to access the Internet. Record this information and store it in a safe place.

The following features will help you set up a new Internet account or configure the computer to use an existing account:

- **Internet Services & Offers (available in some locations)**—This utility assists with signing up for a new Internet account and configuring the computer to use an existing account. To access this utility, select **Start > All Programs > Online Services > Get Online**.
- **ISP-provided icons (available in some locations)**—These icons may be displayed either individually on the Windows desktop or grouped in a desktop folder named Online Services. To set up a new Internet account or configure the computer to use an existing account, double-click an icon, and then follow the on-screen instructions.
- **Windows Connect to the Internet Wizard**—You can use the Windows Connect to the Internet Wizard to connect to the Internet in any of these situations:
 - You already have an account with an ISP.
 - You do not have an Internet account and want to select an ISP from the list provided within the wizard. (The list of ISP providers is not available in all regions.)
 - You have selected an unlisted ISP, and the ISP has provided you with information such as a specific IP address and POP3 and SMTP settings.

To access the Windows Connect to the Internet Wizard and instructions for using it, select **Start > Control Panel > Network and Internet > Network and Sharing Center**.

 **NOTE:** If you are prompted within the wizard to choose between enabling or disabling Windows Firewall, choose to enable the firewall.

Connecting to a wireless network

Wireless technology transfers data across radio waves instead of wires. Your computer may be equipped with one or more of the following wireless devices:

- Wireless local area network (WLAN) device
- HP Mobile Broadband Module, a wireless wide area network (WWAN) device
- Bluetooth device

For more information on wireless technology and connecting to a wireless network, refer to the *HP Notebook Reference Guide* and information and Web site links provided in Help and Support.

Connecting to an existing WLAN

1. Turn on the computer.
2. Be sure that the WLAN device is on.

3. Click the network icon in the notification area, at the far right of the taskbar.
4. Select a network to connect to.
5. Click **Connect**.
6. If required, enter the security key.

Setting up a new WLAN network

Required equipment:

- A broadband modem (either DSL or cable) **(1)** and high-speed Internet service purchased from an Internet service provider (ISP)
- A wireless router (purchased separately) **(2)**
- Your new wireless computer **(3)**

 **NOTE:** Some modems have a built-in wireless router. Check with your ISP to determine what type of modem you have.

The illustration shows an example of a completed WLAN network installation that is connected to the Internet. As your network grows, additional wireless and wired computers can be connected to the network to access the Internet.

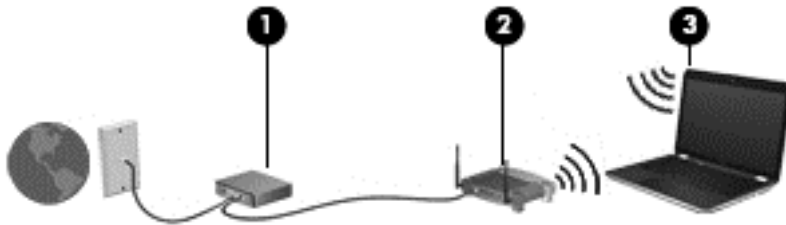

Configuring a wireless router

For help in setting up a WLAN, refer to the information provided by your router manufacturer or your ISP.

The Windows operating system also provides tools to help you set up a new wireless network. To use the Windows tools to set up your network, select **Start > Control Panel > Network and Internet > Network and Sharing Center > Set up a new connection or network > Set up a new network**. Then follow the on-screen instructions.



NOTE: It is recommended that you initially connect your new wireless computer to the router by using the network cable provided with the router. When the computer successfully connects to the Internet, you can disconnect the cable, and then access the Internet through your wireless network.

Protecting your WLAN

When you set up a WLAN or access an existing WLAN, always turn on security features to protect your network from unauthorized access.

For information on protecting your WLAN, refer to the *HP Notebook Reference Guide*.

4 Keyboard and pointing devices

- [Using the keyboard](#)
- [Using pointing devices](#)

Using the keyboard

Using the action keys

Action keys are customized actions that are assigned to specific keys at the top of the keyboard. The icons on the **f1** through **f12** keys represent the action key functions.







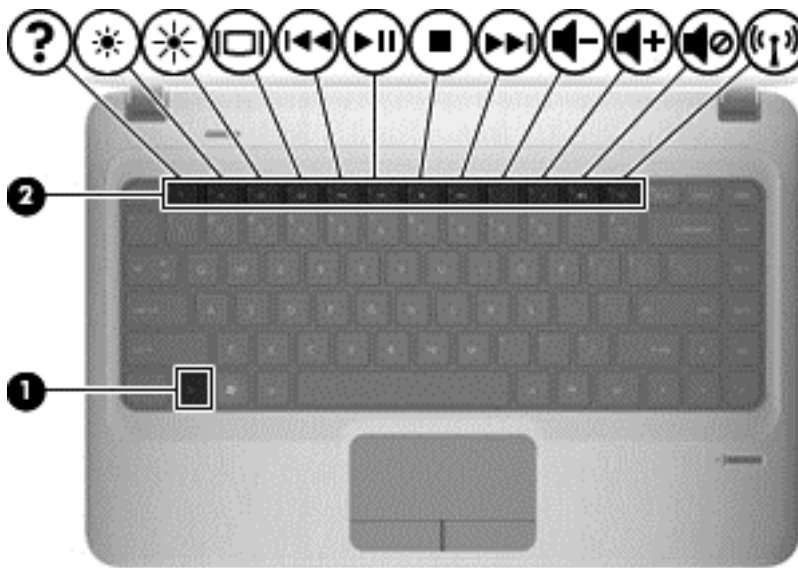

To use an action key, press and hold this key to activate the assigned function.

NOTE: The action key feature is enabled at the factory. You can disable this feature in Setup Utility (BIOS) and revert back to standard settings by pressing the **fn** key and one of the function keys to activate the assigned function. Refer to the “Setup Utility (BIOS) and System Diagnostics” chapter in the *HP Notebook Reference Guide* for instructions.

CAUTION: Use extreme care when making changes in Setup Utility. Errors can prevent the computer from operating properly.



Icon	Key	Description
?	f1	Opens Help and Support, which provides information about your Windows operating system and computer, answers to questions and tutorials, and updates to your computer. Help and Support also provides automated troubleshooting and links to support specialists.
☀️	f2	Decreases the screen brightness level incrementally when you hold down this key.
☀️	f3	Increases the screen brightness level incrementally when you hold down this key.
🖥️	f4	Switches the screen image among display devices connected to the system. For example, if a monitor is connected to the computer, pressing this key alternates the screen image from computer display to monitor display to simultaneous display on both the computer and the monitor. Most external monitors receive video information from the computer using the external VGA video standard. The switch screen image key can also alternate images among other devices that are receiving video information from the computer.

Icon	Key	Description
	f5	Plays the previous track of an audio CD or the previous section of a DVD or a BD.
	f6	Plays, pauses, or resumes a track of an audio CD or a section of a DVD or a BD.
	f7	Stops playback.
	f8	Plays the next track of an audio CD or the next section of a DVD or a BD.
	f9	Decreases speaker volume incrementally when you hold down this key.
	f10	Increases speaker volume incrementally when you hold down this key.
	f11	Mutes or restores speaker sound.
	f12	Turns the wireless feature on or off.
		NOTE: This key does not establish a wireless connection. To establish a wireless connection, a wireless network must also be set up.

Using pointing devices

 **NOTE:** In addition to the pointing devices included with your computer, you can use an external USB mouse (purchased separately) by connecting it to one of the USB ports on the computer.

Setting pointing device preferences

Use Mouse Properties in Windows® to customize settings for pointing devices, such as button configuration, click speed, and pointer options.

To access Mouse Properties, select **Start > Devices and Printers**. Then right-click the device representing your computer, and select **Mouse settings**.

Using the TouchPad

To move the pointer, slide one finger across the TouchPad in the direction you want the pointer to go. Use the left and right TouchPad buttons like the buttons on an external mouse. To scroll up and down using the TouchPad vertical scroll zone, slide your finger up or down over the lines.

 **NOTE:** If you are using the TouchPad to move the pointer, you must lift your finger off the TouchPad before moving it to the scroll zone. Simply sliding your finger from the TouchPad to the scroll zone does not activate the scrolling function.

Turning the TouchPad off and on

To turn the TouchPad off and on, quickly double-tap the TouchPad light.

 **NOTE:** The TouchPad light is off when the TouchPad is on.

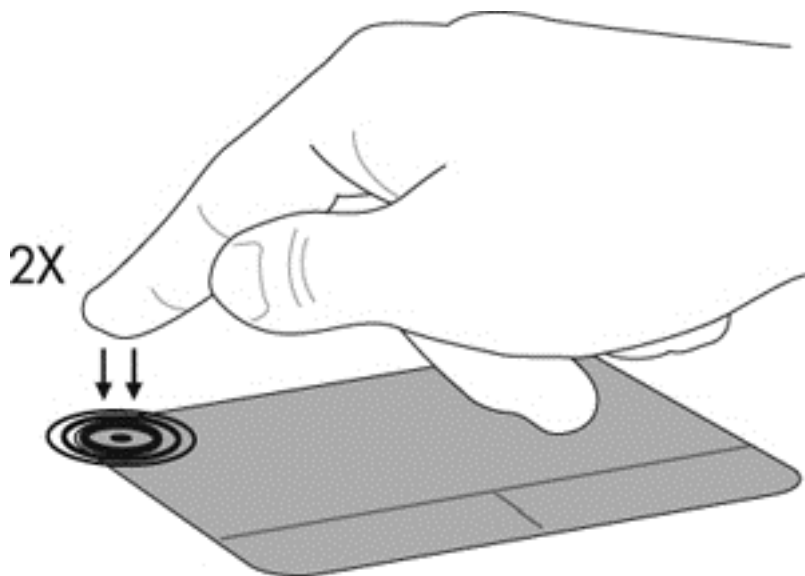

Navigating

To move the pointer, slide one finger across the TouchPad in the direction you want the pointer to go.

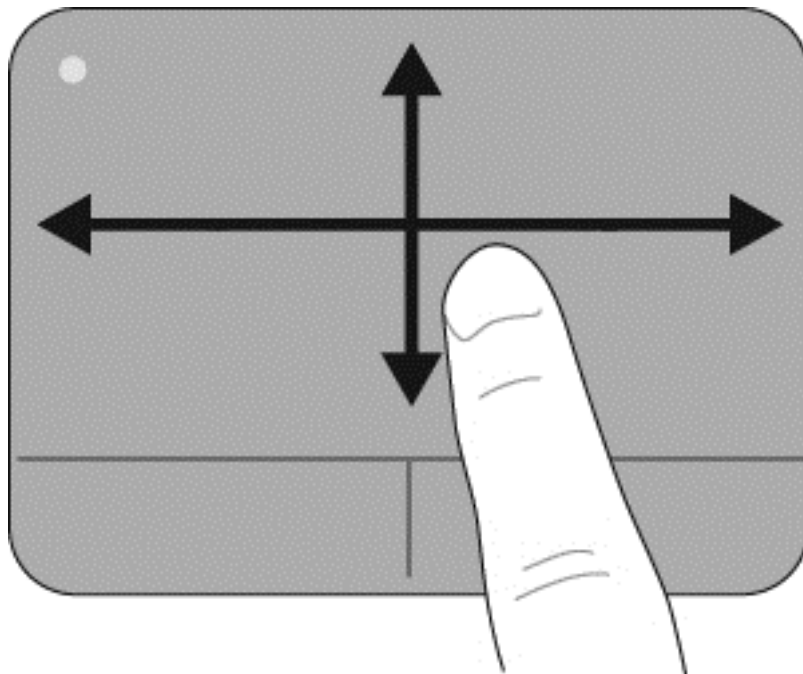

Selecting

Use the left and right TouchPad buttons like the corresponding buttons on an external mouse.

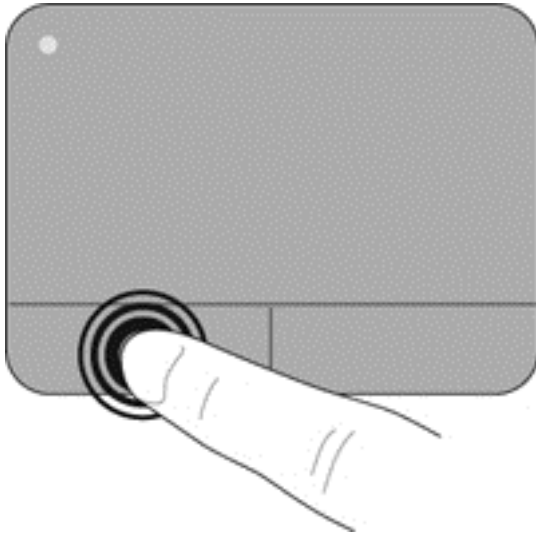

Using TouchPad gestures

The TouchPad supports a variety of gestures. To use TouchPad gestures, place two fingers on the TouchPad at the same time.



NOTE: TouchPad gestures are not supported in all programs.

To turn the gestures on and off:

1. Select **Start > Control Panel > Hardware and Sound**.
2. Under Devices and Printers, click **Mouse**.
3. Click the **Multitouch Gestures** tab, and then select the gesture that you want to turn on or off.
4. Click **Apply**, and then click **OK**.

Scrolling

Scrolling is useful for moving up, down, or sideways on a page or image. To scroll, place two fingers slightly apart on the TouchPad, and then drag them across the TouchPad in an up, down, left, or right motion.

 **NOTE:** Scrolling speed is controlled by finger speed.

 **NOTE:** Two-finger scrolling is enabled at the factory.

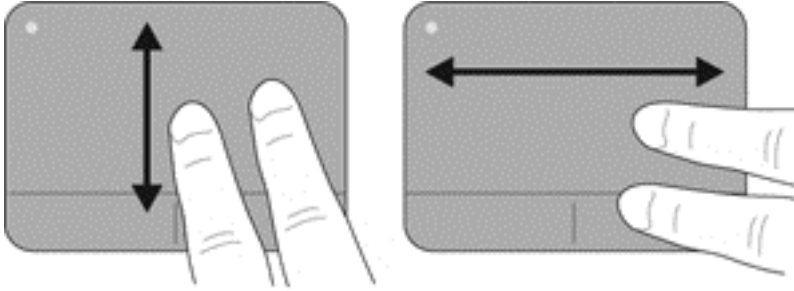

Pinching/Zooming

Pinching allows you to zoom in or out on images or text.

- Zoom in by placing two fingers together on the TouchPad, and then moving them apart.
- Zoom out by placing two fingers apart on the TouchPad, and then moving them together.

 **NOTE:** Pinching/zooming is enabled at the factory.

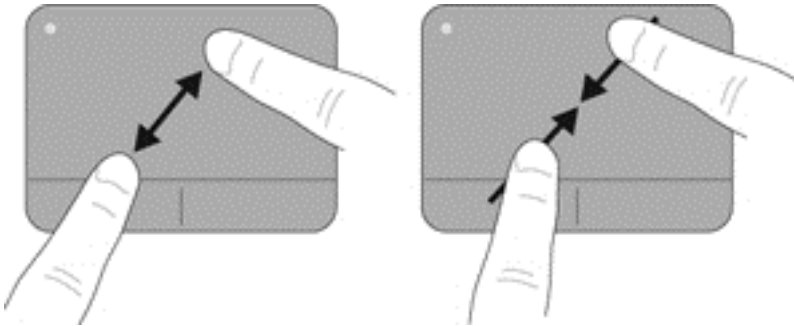

Rotating

Rotating allows you to rotate items such as photos. To rotate, anchor your left forefinger in the TouchPad zone. Move the right forefinger around the anchored finger in a sweeping motion, moving from 12 o'clock to 3 o'clock. To reverse the rotation, move your right forefinger from 3 o'clock to 12 o'clock.

 **NOTE:** Rotating must be done within the TouchPad zone.

 **NOTE:** Rotating is disabled at the factory.

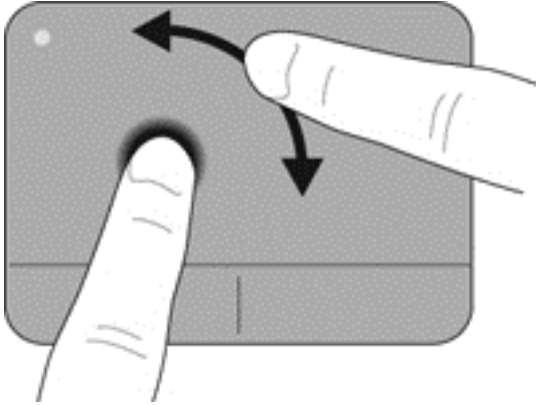

5 Maintenance

- [Inserting or removing the battery](#)
- [Replacing or upgrading the hard drive](#)
- [Adding or replacing memory modules](#)
- [Updating programs and drivers](#)
- [Routine care](#)

Inserting or removing the battery



NOTE: For additional information on using the battery, refer to the *HP Notebook Reference Guide*.

To insert the battery:

1. Turn the computer upside down on a flat surface, with the battery bay toward you.
2. Insert the battery (1) into the battery bay until it is seated.

The battery release latch automatically locks the battery into place (2).

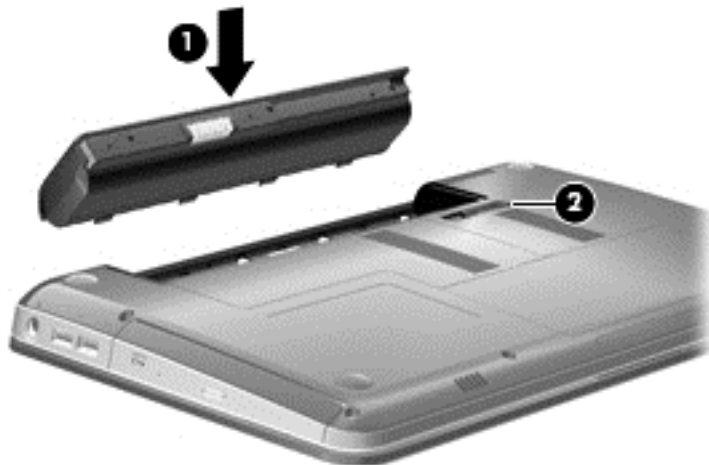

To remove the battery:

⚠ CAUTION: Removing a battery that is the sole power source for the computer can cause loss of information. To prevent loss of information, save your work and initiate Hibernation or shut down the computer through Windows before removing the battery.

1. Turn the computer upside down on a flat surface.
2. Slide the battery release latch (1) to release the battery.
3. Remove the battery from the computer (2).

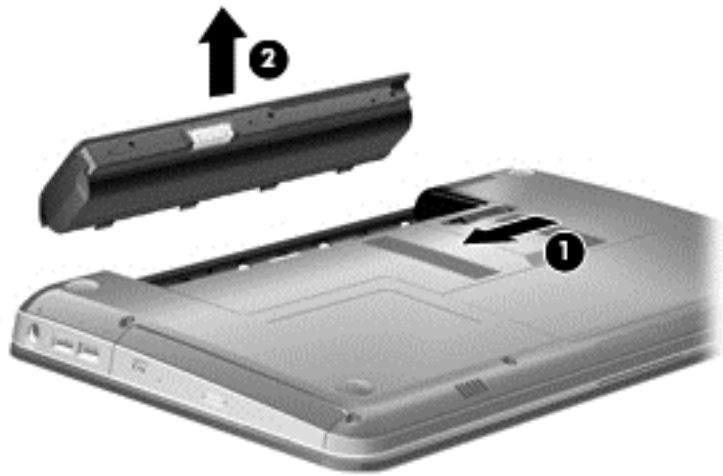

Replacing or upgrading the hard drive

⚠ CAUTION: To prevent information loss or an unresponsive system:

Shut down the computer before removing the hard drive from the hard drive bay. Do not remove the hard drive while the computer is on, in the Sleep state, or in Hibernation.

If you are not sure whether the computer is off or in Hibernation, turn the computer on by pressing the power button. Then shut down the computer through the operating system.

Removing the hard drive

1. Save your work and shut down the computer.
2. Disconnect all external devices connected to the computer.
3. Unplug the power cord from the AC outlet.
4. Turn the computer upside down on a flat surface and remove the battery.
5. Loosen the 2 memory module compartment cover screws (1).
6. Remove the memory module compartment cover (2).

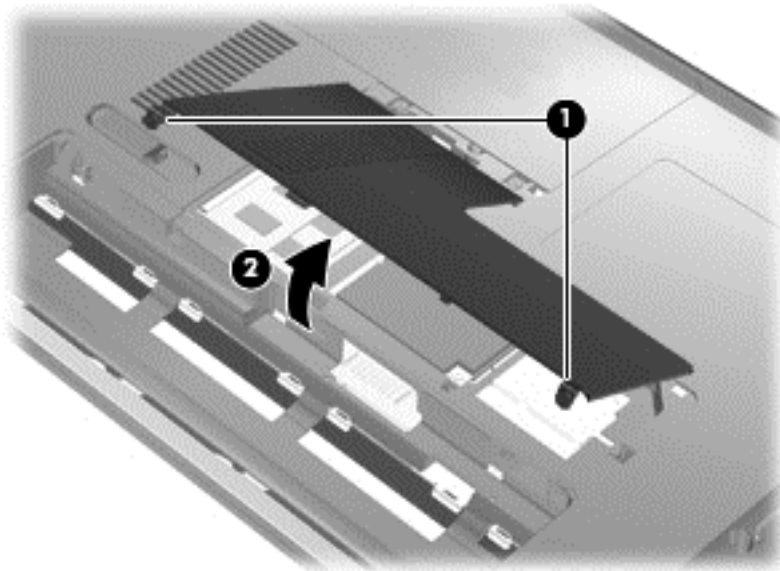

7. Loosen the 2 hard drive cover screws (1).

8. Remove the hard drive cover (2).

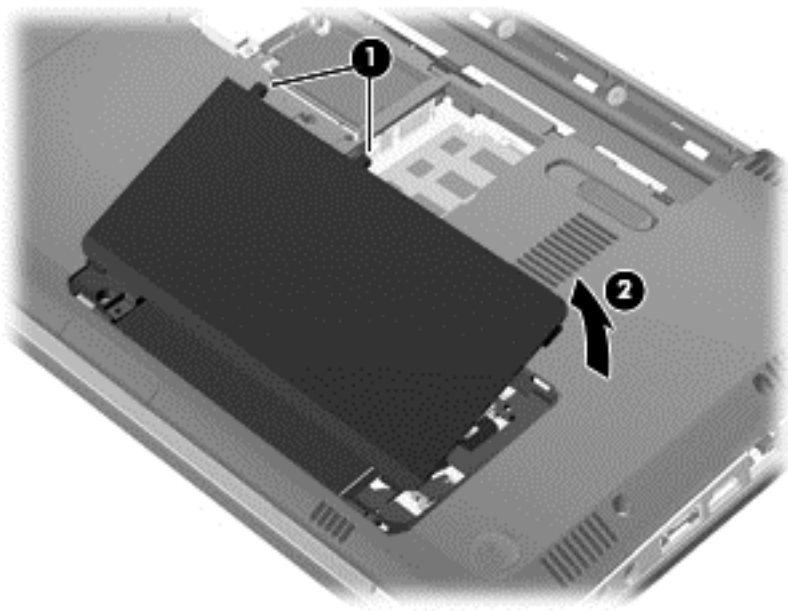

9. Pull the small black plastic tab firmly to disconnect the hard drive cable from the system board (1).
10. Grasp the tab and lift the hard drive (2) out of the hard drive bay.

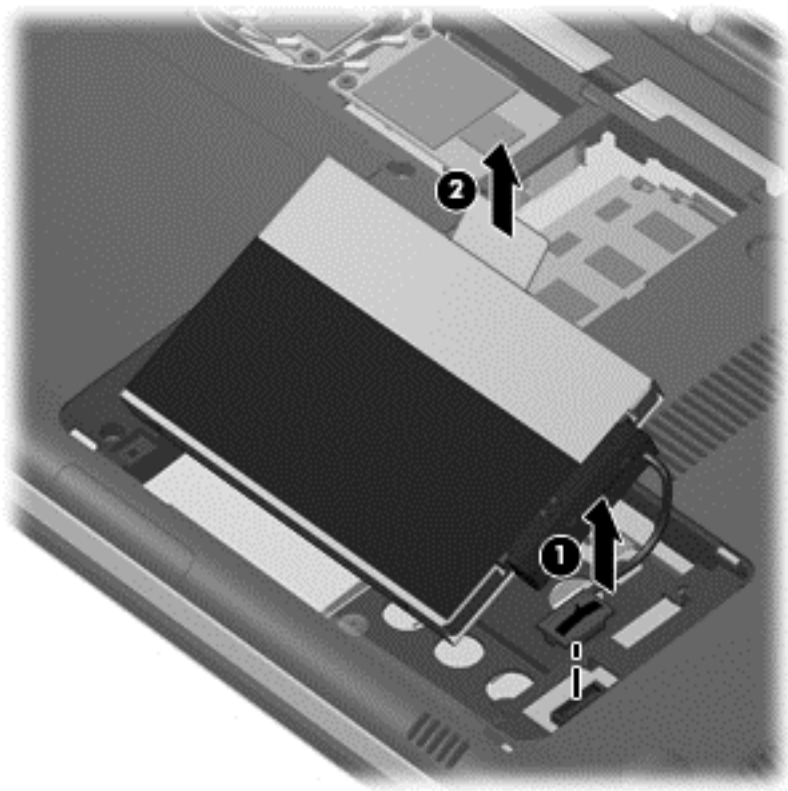

11. Disconnect the hard drive cable from the hard drive (1).

12. Remove the 4 hard drive screws from the hard drive bracket (2) and remove the hard drive (3).

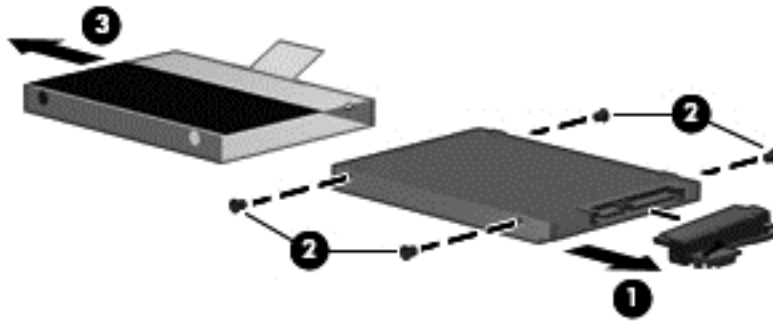

Installing a hard drive

1. Insert the hard drive into the hard drive bracket covering (1).
2. Replace the hard drive screws (2) and connect the hard drive cable to the hard drive (3).

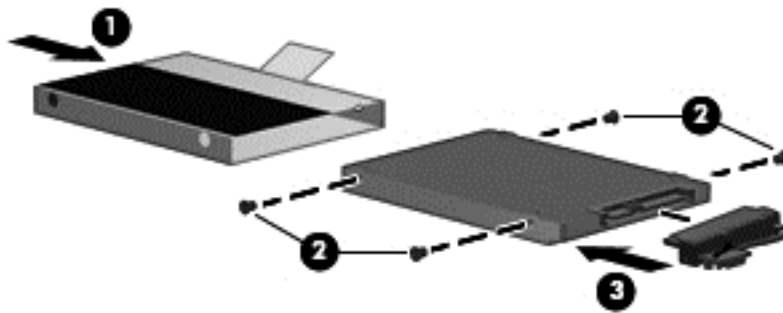

3. Insert the hard drive into the hard drive bay (1).

4. Connect the hard drive cable to the hard drive connector on the system board (2).

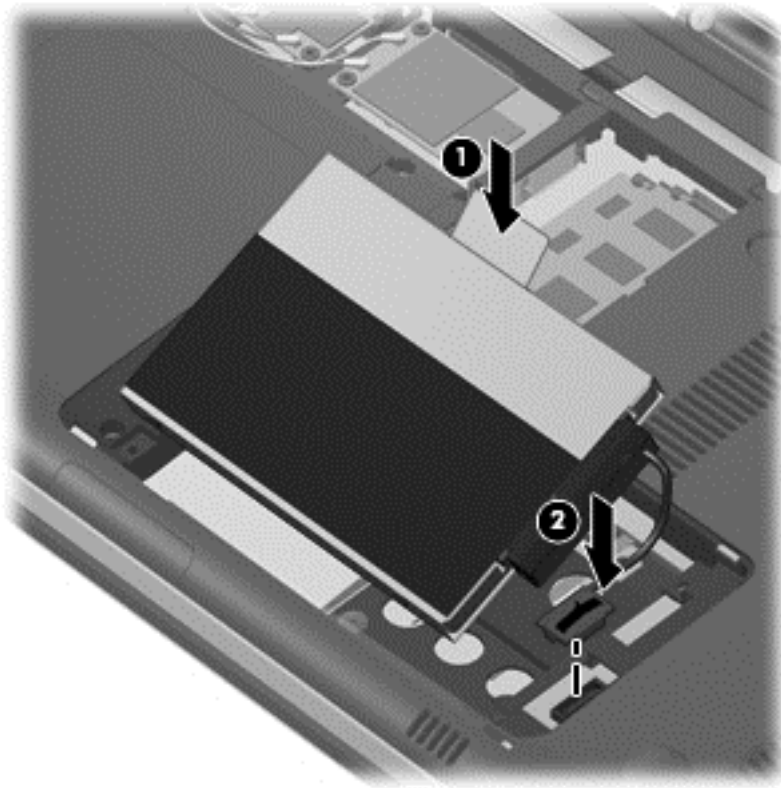

5. Align the tabs on the hard drive cover with the notches on the computer and close the cover (1).
6. Tighten the hard drive cover screws (2).

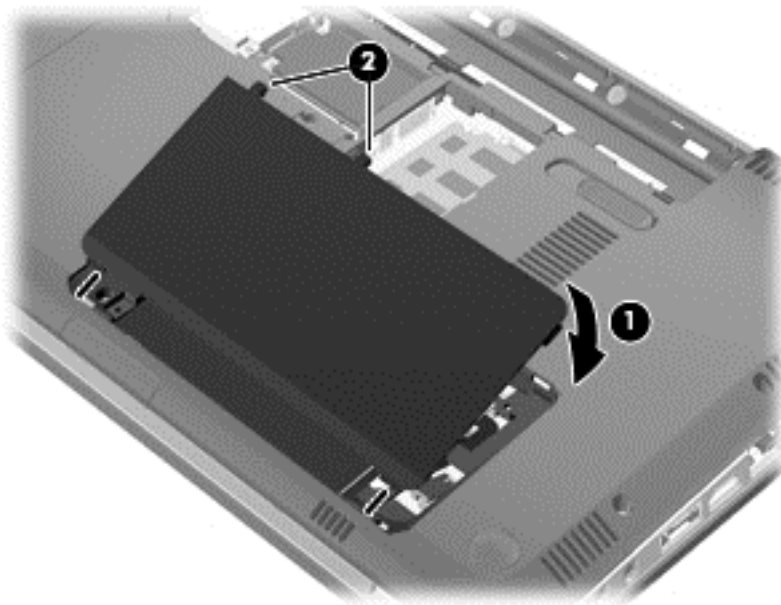

7. Align the tabs (1) on the memory module compartment cover with the notches on the computer.
8. Close the cover (2).

9. Tighten the 2 memory module compartment cover screws (3).

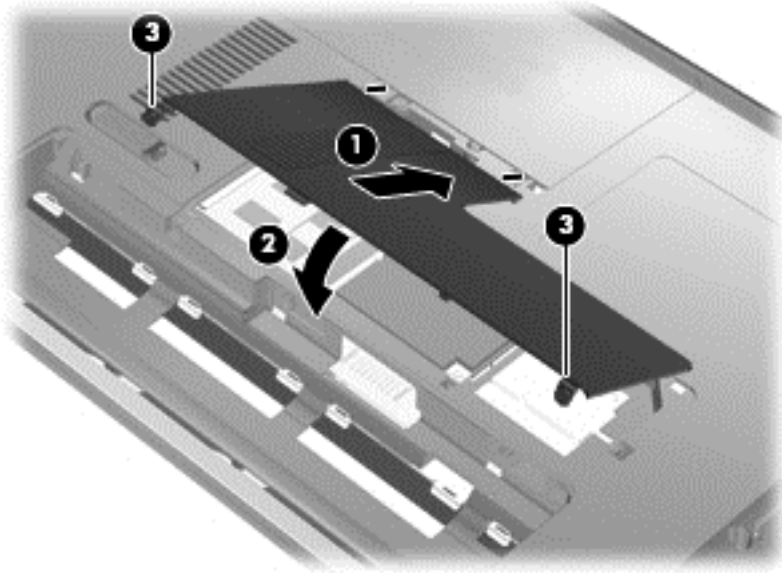

10. Replace the battery.
11. Turn the computer right-side up, and then reconnect external power and external devices.
12. Turn on the computer.

Adding or replacing memory modules

The computer has two memory module slots. The capacity of the computer can be upgraded by adding a memory module to the vacant expansion memory module slot or by upgrading the existing memory module in the primary memory module slot.

⚠ WARNING! To reduce the risk of electric shock and damage to the equipment, unplug the power cord and remove all batteries before installing a memory module.

⚠ CAUTION: Electrostatic discharge (ESD) can damage electronic components. Before beginning any procedure, ensure that you are discharged of static electricity by touching a grounded metal object.

📝 NOTE: To use a dual-channel configuration when adding a second memory module, be sure that both memory modules are identical.

To add or replace a memory module:

⚠ CAUTION: To prevent information loss or an unresponsive system:

Shut down the computer before adding or replacing memory modules. Do not remove a memory module while the computer is on, in the Sleep state, or in Hibernation.

If you are not sure whether the computer is off or in Hibernation, turn the computer on by pressing the power button. Then shut down the computer through the operating system.

1. Save your work and shut down the computer.
2. Disconnect all external devices connected to the computer.

3. Unplug the power cord from the AC outlet.
4. Turn the computer upside down on a flat surface and remove the battery.
5. Loosen the 2 memory module compartment cover screws (1).
6. Remove the memory module compartment cover (2).

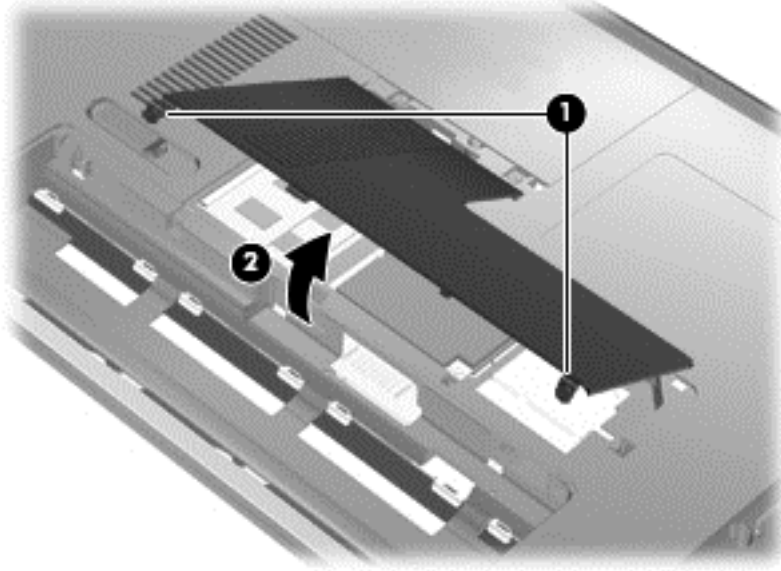

7. If you are replacing a memory module, remove the existing memory module:
 - a. Pull away the retention clips (1) on each side of the memory module.
The memory module tilts up.

- c. Gently press the memory module **(3)** down, applying pressure to both the left and right edges of the memory module, until the retention clips snap into place.

⚠ CAUTION: To prevent damage to the memory module, be sure that you do not bend the memory module.

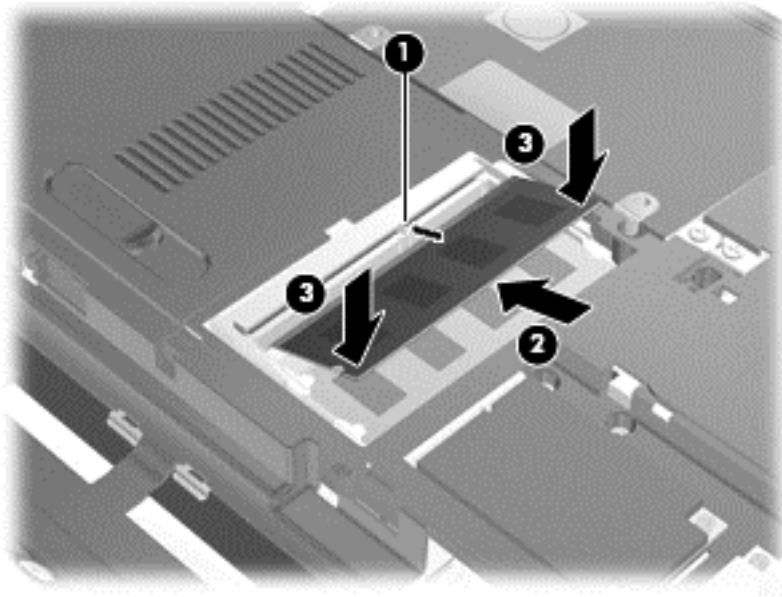

9. Align the tabs **(1)** on the memory module compartment cover with the notches on the computer.
10. Close the cover **(2)**.
11. Tighten the 2 memory module compartment cover screws **(3)**.

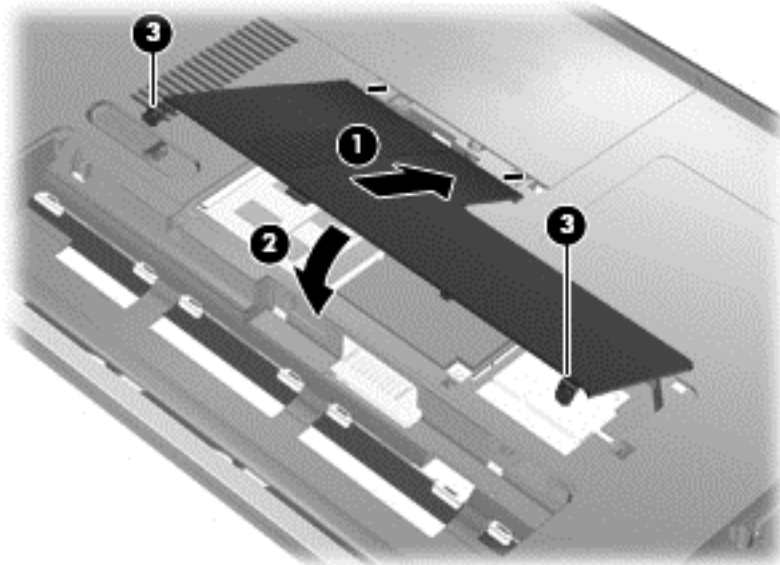

12. Replace the battery.
13. Turn the computer right-side up, and then reconnect external power and external devices.
14. Turn on the computer.

Updating programs and drivers

HP recommends that you update your programs and drivers on a regular basis with the latest versions. Go to <http://www.hp.com/support> to download the latest versions. You can also register to receive automatic update notifications when they become available.

Routine care

Cleaning the display

 **CAUTION:** To prevent permanent damage to the computer, never spray water, cleaning fluids, or chemicals on the display.

To remove smudges and lint, frequently clean the display with a soft damp, lint-free cloth. If the screen requires additional cleaning, use premoistened antistatic wipes or an antistatic screen cleaner.

Cleaning the TouchPad and keyboard

Dirt and grease on the TouchPad can cause the pointer to jump around on the screen. To avoid this, clean the TouchPad with a damp cloth, and wash your hands frequently when using the computer.

 **WARNING!** To reduce the risk of electric shock or damage to internal components, do not use a vacuum cleaner attachment to clean the keyboard. A vacuum cleaner can deposit household debris on the keyboard surface.

Clean the keyboard regularly to prevent keys from sticking, and to remove dust, lint, and particles that can become trapped beneath the keys. A can of compressed air with a straw extension can be used to blow air around and under the keys to loosen and remove debris.

6 Backup and recovery

- [Restore](#)
- [Creating restore media](#)
- [Performing a system restore](#)
- [Backing up and recovering your information](#)

Your computer includes tools provided by the operating system and HP to help you safeguard your information and restore it if ever needed.

This chapter provides information on the following topics:

- Creating a set of recovery discs or a recovery flash drive (HP Recovery Manager software feature)
- Performing a system restore (from the partition, recovery discs, or a recovery flash drive)
- Backing up your information
- Recovering a program or driver

Restore

In the event of hard drive failure, to restore your system to its factory image you will need a set of recovery discs or a recovery flash drive that you can create using HP Recovery Manager. HP recommends that you use this software to create either a set of recovery discs or a recovery flash drive immediately after software setup.

If for some other reason you need to restore your system, this can be achieved using the HP Recovery partition (select models only), without the need for recovery discs or a recovery flash drive. To check for the presence of a recovery partition, click **Start**, right-click **Computer**, click **Manage**, and then click **Disk Management**. If the recovery partition is present, a Recovery drive is listed in the window.

 **CAUTION:** HP Recovery Manager (partition or discs/flash drive) restores only software that was preinstalled at the factory. Software not provided with this computer must be reinstalled manually.

 **NOTE:** Recovery discs have been included if your computer does not have a recovery partition.

Creating restore media

HP recommends that you create either a set of recovery discs or a recovery flash drive to be sure that you can restore your computer to its original factory state if the hard drive fails, or if for any reason you cannot restore using the recovery partition tools. Create these discs or the flash drive after setting up the computer for the first time.

 **NOTE:** HP Recovery Manager allows the creation of only one set of recovery discs or one recovery flash drive. Handle these discs or flash drive carefully and keep them in a safe place.

 **NOTE:** If your computer does not include an integrated optical drive, you can use an optional external optical drive (purchased separately) to create recovery discs, or you can purchase recovery discs for your computer from the HP Web site. If you use an external optical drive, it must be connected directly to a USB port on the computer, not to a USB port on an external device, such as a USB hub.

Guidelines:

- Purchase high-quality DVD-R, DVD+R, DVD-R DL, or DVD+R DL discs.

 **NOTE:** Read-write discs, such as CD-RW, DVD±RW, double-layer DVD±RW, and BD-RE (rewritable Blu-ray) discs, are not compatible with the HP Recovery Manager software.

- The computer must be connected to AC power during this process.
- Only one set of recovery discs or one recovery flash drive can be created per computer.

 **NOTE:** If you are creating recovery discs, number each disc before inserting it into the optical drive.

- If necessary, you can exit the program before you have finished creating the recovery discs or recovery flash drive. The next time you open HP Recovery Manager, you will be prompted to continue the backup creation process.

To create a set of recovery discs or a recovery flash drive:

1. Select **Start > All Programs > HP > HP Recovery Manager > HP Recovery Media Creation**.
2. Follow the on-screen instructions.

Performing a system restore

HP Recovery Manager software allows you to repair or restore the computer to its original factory state. HP Recovery Manager works from recovery discs, a recovery flash drive, or from a dedicated recovery partition (select models only) on the hard drive.

 **NOTE:** A system restore needs to be performed if the computer hard drive has failed or if all attempts to correct any functional computer issues fail. A system restore should be used as a final attempt to correct computer issues.

Note the following when performing a system restore:

- You can restore only the system that you have previously backed up. HP recommends that you use Recovery Manager to create either a set of recovery discs or a recovery flash drive as soon as you set up the computer.
- Windows has its own built-in repair features, such as System Restore. If you have not already tried these features, try them before using HP Recovery Manager.
- HP Recovery Manager restores only software that was preinstalled at the factory. Software not provided with this computer must be downloaded from the manufacturer's Web site or reinstalled from the disc provided by the manufacturer.

Restoring using the dedicated recovery partition (select models only)

When using the dedicated recovery partition, there is an option to back up pictures, music and other audio, videos and movies, recorded TV shows, documents, spreadsheets and presentations, e-mails, Internet favorites and settings during this process.

To restore the computer from the recovery partition, follow these steps:

1. Access HP Recovery Manager in either of the following ways:
 - Select **Start > All Programs > HP > HP Recovery Manager > HP Recovery Manager**.
 - or –
 - Turn on or restart the computer, and then press **esc** while the “Press the ESC key for Startup Menu” message is displayed at the bottom of the screen. Then, press **f11** while the “F11 (System Recovery)” message is displayed on the screen.
2. Click **System Recovery** in the **HP Recovery Manager** window.
3. Follow the on-screen instructions.

Restoring using the restore media

1. If possible, back up all personal files.
2. Insert the first recovery disc into the optical drive on your computer or an optional external optical drive, and then restart the computer.

– or –

Insert the recovery flash drive into a USB port on your computer, and then restart the computer.



NOTE: If the computer does not automatically restart in the HP Recovery Manager, the computer boot order needs to be changed.

3. Press **f9** at system bootup.
4. Select the optical drive or the flash drive.
5. Follow the on-screen instructions.

Changing the computer boot order

To change the boot order for recovery discs:

1. Restart the computer.
2. Press **esc** while the computer is restarting, and then press **f9** for boot options.
3. Select **Internal CD/DVD ROM Drive** from the boot options window.

To change the boot order for recovery flash drive:

1. Insert the flash drive into a USB port.
2. Restart the computer.
3. Press **esc** while the computer is restarting, and then press **f9** for boot options.
4. Select the flash drive from the boot options window.

Backing up and recovering your information

It is very important to back up your files and keep any new software in a safe place. As you add new software and data files, continue to create backups on a regular basis.

How completely you are able to recover your system depends on how recent your backup is.

 **NOTE:** A recovery from your most recent backup needs to be performed if the computer has a virus attack or if any major system components fail. In order to correct computer issues, a recovery should first be attempted before a system restore is attempted.

You can back up your information to an optional external hard drive, a network drive, or discs. Back up your system at the following times:

- At regularly scheduled times

 **TIP:** Set reminders to back up your information periodically.

- Before the computer is repaired or restored
- Before you add or modify hardware or software

Guidelines:

- Create system restore points using the Windows® System Restore feature, and periodically copy them to an optical disc or an external hard drive. For more information on using system restore points, refer to [Using Windows system restore points on page 45](#).
- Store personal files in the Documents library and back up this folder periodically.
- Save customized settings in a window, toolbar, or menu bar by taking a screen shot of your settings. The screen shot can be a time-saver if you have to re-enter your preferences.

To create a screen shot:

1. Display the screen you want to save.
2. Copy the screen image:

To copy only the active window, press **alt+fn+prt sc**.

To copy the entire screen, press **fn+prt sc**.

3. Open a word-processing document, and then select **Edit > Paste**. The screen image is added to the document.
4. Save and print the document.

Using Windows Backup and Restore

Guidelines:

- Be sure that the computer is connected to AC power before you start the backup process.
- Allow enough time to complete the backup process. Depending on file sizes, it may take over an hour.

To create a backup:

1. Select **Start > Control Panel > System and Security > Backup and Restore**.
2. Follow the on-screen instructions to schedule and create a backup.



NOTE: Windows® includes the User Account Control feature to improve the security of the computer. You may be prompted for your permission or password for tasks such as installing software, running utilities, or changing Windows settings. Refer to Help and Support for more information.

Using Windows system restore points

A system restore point allows you to save and name a snapshot of your hard drive at a specific point in time. You can then recover back to that point if you want to reverse subsequent changes.

 **NOTE:** Recovering to an earlier restore point does not affect data files saved or e-mails created since the last restore point.

You also can create additional restore points to provide increased protection for your files and settings.

When to create restore points

- Before you add or modify software or hardware
- Periodically, whenever the computer is functioning optimally

 **NOTE:** If you revert to a restore point and then change your mind, you can reverse the restoration.

Create a system restore point

1. Select **Start > Control Panel > System and Security > System**.
2. In the left pane, click **System Protection**.
3. Click the **System Protection** tab.
4. Follow the on-screen instructions.

Restore to a previous date and time

To revert to a restore point (created at a previous date and time), when the computer was functioning optimally, follow these steps:

1. Select **Start > Control Panel > System and Security > System**.
2. In the left pane, click **System Protection**.
3. Click the **System Protection** tab.
4. Click **System Restore**.
5. Follow the on-screen instructions.

7 Customer support

- [Contacting customer support](#)
- [Labels](#)

Contacting customer support

If the information provided in this user guide, in the *HP Notebook Reference Guide*, or in Help and Support does not address your questions, you can contact HP Customer Support at:

<http://www.hp.com/go/contactHP>



NOTE: For worldwide support, click **Contact HP worldwide** on the left side of the page, or go to http://welcome.hp.com/country/us/en/wwcontact_us.html.

Here you can:

- Chat online with an HP technician.



NOTE: When technical support chat is not available in a particular language, it is available in English.

- E-mail HP Customer Support.
- Find HP Customer Support worldwide telephone numbers.
- Locate an HP service center.

Labels

The labels affixed to the computer provide information you may need when you troubleshoot system problems or travel internationally with the computer:

- Serial number label—Provides important information, including the following:

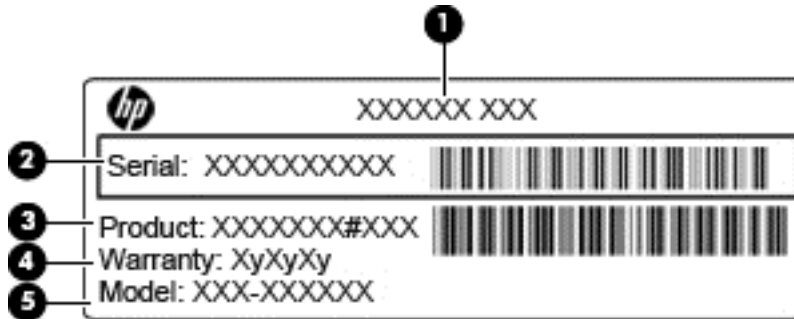

Component	
(1)	Product name
(2)	Serial number (s/n)
(3)	Part number/Product number (p/n)
(4)	Warranty period
(5)	Model description

Have this information available when you contact technical support. The serial number label is affixed to the bottom of the computer.

- Microsoft® Certificate of Authenticity—Contains the Windows Product Key. You may need the Product Key to update or troubleshoot the operating system. The Microsoft Certificate of Authenticity is located on the bottom of the computer.
- Regulatory label—Provides regulatory information about the computer. The regulatory label is affixed inside the battery bay.
- Wireless certification label or labels (select models only)—Provide information about optional wireless devices and the approval markings of some of the countries or regions in which the devices have been approved for use. If your computer model includes one or more wireless devices, one or more certification labels are included with your computer. You may need this information when traveling internationally. Wireless certification labels are affixed inside the battery bay.
- SIM (subscriber identity module) label (select models only)—Provides the ICCID (Integrated Circuit Card Identifier) of the SIM. This label is located inside the battery bay.
- HP Mobile Broadband Module serial number label (select models only)—Provides the serial number of the HP Mobile Broadband Module. This label is located inside the battery bay.

8 Specifications

- [Input power](#)
- [Operating environment](#)

Input power

The power information in this section may be helpful if you plan to travel internationally with the computer.

The computer operates on DC power, which can be supplied by an AC or a DC power source. The AC power source must be rated at 100–240 V, 50–60 Hz. Although the computer can be powered from a standalone DC power source, it should be powered only with an AC adapter or a DC power source supplied and approved by HP for use with this computer.

The computer can operate on DC power within the following specifications.

Input power	Rating
Operating voltage and current	18.5 V dc @ 3.5 A - 65W
DC plug of external HP power supply	

 **NOTE:** This product is designed for IT power systems in Norway with phase-to-phase voltage not exceeding 240 V rms.

 **NOTE:** The computer operating voltage and current can be found on the system regulatory label.

Operating environment

Factor	Metric	U.S.
Temperature		
Operating (writing to optical disc)	5°C to 35°C	41°F to 95°F
Nonoperating	-20°C to 60°C	-4°F to 140°F
Relative humidity (noncondensing)		
Operating	10% to 90%	10% to 90%
Nonoperating	5% to 95%	5% to 95%
Maximum altitude (unpressurized)		
Operating	-15 m to 3,048 m	-50 ft to 10,000 ft
Nonoperating	-15 m to 12,192 m	-50 ft to 40,000 ft

Index

- A**
 - action keys
 - decrease screen brightness 21
 - Help and Support 21
 - identifying 8
 - increase screen brightness 21
 - next track 22
 - play, pause, resume 22
 - previous track 22
 - stop 22
 - switch screen image 21
 - volume down 22
 - volume mute 22
 - volume up 22
 - wireless 22
 - audio-in (microphone) jack, identifying 11
 - audio-out (headphone) jack, identifying 11
- B**
 - backing up
 - customized window, toolbar, and menu bar settings 43
 - personal files 43
 - battery bay 15, 48
 - battery light 10
 - battery release latch 15
 - battery, replacing 27
 - Bluetooth label 48
 - buttons
 - left TouchPad 5
 - power 7
 - right TouchPad 5
- C**
 - caps lock light, identifying 5
 - Certificate of Authenticity label 48
- components
 - bottom 15
 - display 13
 - front 9
 - left side 11
 - rear 14
 - right side 10
 - top 4
- connector, power 10
- D**
 - Digital Media Slot, identifying 9
 - drive light 11
- E**
 - esc key, identifying 8
 - external monitor port 11
- F**
 - f11 41
 - fingerprint reader light, identifying 6
 - fingerprint reader, identifying 7
 - fn key, identifying 8
- H**
 - hard drive
 - installing 31
 - removing 29
 - hard drive bay, identifying 15
 - HDMI port, identifying 12
 - headphone (audio-out) jack 11
 - HP Recovery Manager 41
- I**
 - input power 50
 - integrated webcam light, identifying 13
 - internal microphones, identifying 13
- Internet connection setup 18
- ISP, using 17
- J**
 - jacks
 - audio-in (microphone) 11
 - audio-out (headphone) 11
 - network 12
 - RJ-45 (network) 12
- K**
 - keys
 - action 8
 - esc 8
 - fn 8
 - Windows applications 8
 - Windows logo 8
- L**
 - labels
 - Bluetooth 48
 - HP Mobile Broadband Module 48
 - Microsoft Certificate of Authenticity 48
 - regulatory 48
 - serial number 48
 - SIM 48
 - wireless certification 48
 - WLAN 48
 - latch, battery release 15
 - lights
 - battery 10
 - caps lock 5
 - drive 11
 - fingerprint reader 6
 - mute 5
 - optical drive 10
 - power 11

- RJ-45 12
- webcam 13
- wireless 5

M

- memory module
 - inserting 35
 - removing 34
 - replacing 33
- memory module compartment
 - cover
 - removing 29, 34
 - replacing 32, 36
- memory module compartment, identifying 15
- microphone (audio-in) jack, identifying 11
- Microsoft Certificate of Authenticity label 48
- mouse, external
 - setting preferences 22
- mute light, identifying 5

N

- network jack, identifying 12

O

- operating environment 51
- operating system
 - Microsoft Certificate of Authenticity label 48
 - Product Key 48
- optical drive light, identifying 10
- optical drive, identifying 10

P

- pinching TouchPad gesture 25
- pointing devices, setting preferences 22
- ports
 - external monitor 11
 - HDMI 12
 - USB 10, 12
- power button, identifying 7
- power connector, identifying 10
- power light 11
- Product Key 48
- product name and number, computer 48

R

- recovering from the dedicated recovery partition 41
- recovering from the recovery discs 42
- recovery discs 40
- recovery, system 41
- regulatory information
 - regulatory label 48
 - wireless certification labels 48
- restore points 45
- RJ-45 (network) jack, identifying 12
- RJ-45 network light, identifying 12
- rotating TouchPad gesture 26

S

- scrolling TouchPad gesture 25
- security cable slot, identifying 11
- serial number, computer 48
- setup of WLAN 18
- SIM slot
 - identifying 15
- SIM slot, identifying 15
- slots
 - Digital Media 9
 - Memory module 15
 - security cable 11
 - SIM 15
- speakers, identifying 9
- supported discs 40
- system recovery 41
- system restore points 45

T

- TouchPad
 - buttons 5
 - using 22
- TouchPad gestures
 - pinching 25
 - rotating 26
 - scrolling 25
 - zooming 25
- TouchPad light 4
- TouchPad zone, identifying 4
- traveling with the computer 48

U

- USB ports, identifying 10, 12
- using system restore 45

V

- vents, identifying 11, 14, 15

W

- webcam light, identifying 13
- webcam, identifying 13
- Windows applications key, identifying 8
- Windows logo key, identifying 8
- wireless antennas, identifying 13
- wireless certification label 48
- wireless light 5
- wireless network (WLAN), equipment needed 18
- wireless network, connecting 17
- wireless router, configuring 19
- wireless set up 18
- WLAN
 - connecting 17
 - protecting 19
- WLAN antennas, identifying 13
- WLAN device 48
- WLAN label 48
- WWAN antennas, identifying 13

Z

- zooming TouchPad gesture 25

