

KENWOOD

POWERED SUBWOOFER

SW-26HT

INSTRUCTION MANUAL

KENWOOD CORPORATION

Before applying power





 **Caution: Read this page carefully to ensure safe operation.**

Units are designed for operation as follows.

Europe and U.K. AC 230V only

Safety precautions

WARNING : TO PREVENT FIRE OR ELECTRIC SHOCK, DO NOT EXPOSE THIS APPLIANCE TO RAIN OR MOISTURE.

	CAUTION RISK OF ELECTRIC SHOCK DO NOT OPEN		CAUTION: TO REDUCE THE RISK OF ELECTRIC SHOCK, DO NOT REMOVE COVER (OR BACK). NO USER-SERVICEABLE PARTS INSIDE. REFER SERVICING TO QUALIFIED SERVICE PERSONNEL.
	THE LIGHTNING FLASH WITH ARROWHEAD SYMBOL, WITHIN AN EQUILATERAL TRIANGLE, IS INTENDED TO ALERT THE USER TO THE PRESENCE OF UNINSULATED "DANGEROUS VOLTAGE" WITHIN THE PRODUCT'S ENCLOSURE THAT MAY BE OF SUFFICIENT MAGNITUDE TO CONSTITUTE A RISK OF ELECTRIC SHOCK TO PERSONS.		
	THE EXCLAMATION POINT WITHIN AN EQUILATERAL TRIANGLE IS INTENDED TO ALERT THE USER TO THE PRESENCE OF IMPORTANT OPERATING AND MAINTENANCE (SERVICING) INSTRUCTIONS IN THE LITERATURE ACCOMPANYING THE APPLIANCE.		

Introduction

Thank you for selecting our speakers as part of your high-fidelity system. We at KENWOOD are confident that your choice will bring you years of rich listening pleasure. Please take the time to read through this booklet carefully. It will help you to obtain the peak performance for which the speakers were designed.

For your records

Record the serial number, found on the back of the unit, in the spaces designated on the warranty card, and in the space provided below. Refer to these model and serial numbers whenever you call upon your KENWOOD dealer for information or service on this product. Model SW-26HT is composed of the front speakers, center speaker and rear (surround) speakers.

SW-26HT Serial number _____

Unpacking

Unpack the unit carefully and make sure that all accessories are put aside so they will not be lost. Examine the unit for any possibility of shipping damage. If your unit is damaged or fails to operate, notify your dealer immediately. If your unit was shipped to you directly, notify the shipping company without delay. Only the consignee (the person or company receiving the unit) can file a claim against the carrier for shipping damage. We recommend that you retain the original carton and packing materials for use should you transport or ship the unit in the future. **Keep this manual handy for future reference.**

Accessories

Pin-plug cord (1)

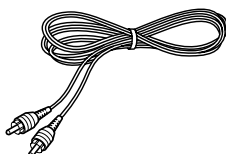



Cushion (4)



Contents

Caution: Read the pages marked  carefully to ensure safe operation.

 Before applying power	2
 Safety precautions	2
Introduction	3
 IMPORTANT SAFEGUARDS	4
Installation	6
Connections	6
Controls and indicators	7
Specifications	8

IMPORTANT SAFEGUARDS



Caution: Read this page carefully to ensure safe operation.

Please read all of the safety and operating instructions before operating this appliance. Adhere to all warnings on the appliance and in the instruction manual. Follow all the safety and operating instructions. These safety and operating instructions should be retained for future reference.

1. Power sources – The appliance should be connected to a power supply only of the type described in the instruction manual or as marked on the appliance. If you are not sure of the type of power supply to your home, consult your appliance dealer or local power company. For appliances intended to operate from battery power, or other sources, refer to the instruction manual.

2. Power-cord protection – Power-supply cords should be routed so that they are not likely to be walked on or pinched by items placed upon or against them, pay particular attention to cords at plugs, convenience receptacles, and the point where they exit from the appliance.

Never pull or stretch the cord.

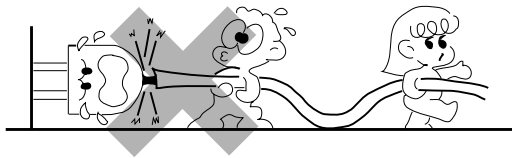

3. CAUTION – Polarization – This appliance may be equipped with a polarized alternating-current line plug (a plug having one blade wider than the other). This plug will fit into the power outlet only one way. This is a safety feature. If you are unable to insert the plug fully into the outlet, try reversing the plug. If the plug should still fail to fit, contact your electrician to replace your obsolete outlet. Do not defeat the safety purpose of the polarized plug.

4. Ventilation – Slots and openings in the cabinet are provided for ventilation and to ensure reliable operation of the appliance and to protect it from overheating, and these openings must not be blocked or covered. The appliance should be situated so that its location or position does not interfere with its proper ventilation. To maintain good ventilation, do not put records or a table-cloth on the appliance. Place the appliance at least 10 cm away from the walls.

Do not use the appliance on a bed, sofa, rug or similar surface that may block the ventilation openings. This appliance should not be placed in a built-in installation such as a bookcase or rack unless proper ventilation is provided or the manufacturer's instructions have been adhered to.

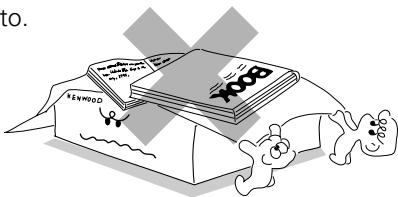

5. Water and moisture – The appliance shall not be exposed to dripping and splashing - for example, near a bathtub, washbowl, kitchen sink, laundry tub, in a wet basement, or near a swimming pool, etc. Do not place an object containing liquid, such as a flower vase, on the appliance.

6. Temperature – The appliance may not function properly if used at extremely low, or freezing temperatures. The ideal ambient temperature is above +5°C (41°F).

7. Heat – The appliance should be situated away from heat sources such as radiators, heat registers, stoves, or other appliances (including amplifiers) that produce heat. Do not place a flaming object, such as a candle or lantern, on or near the appliance.

8. Electric shock – Care should be taken so that objects do not fall and liquid is not spilled into the enclosure through openings. If a metal objects, such as a hair pin or a needle, comes into contact with the inside of this appliance, a dangerous electric shock may result. For families with children, never permit children to put anything, especially metal, inside this appliance.

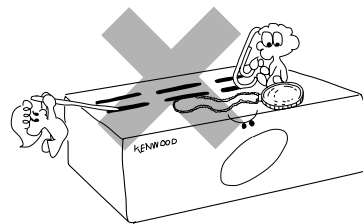

9. Enclosure removal – Never remove the enclosure. If the internal parts are touched accidentally, a serious electric shock might occur.

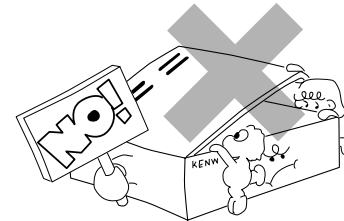

10. Magnetic fields – Keep the appliance away from sources of magnetic fields such as TV sets, speaker systems, radios, motorized toys or magnetized objects.

11. Cleaning – Unplug this appliance from the wall outlet before cleaning. Do not use volatile solvents such as alcohol, paint thinner, gasoline, or benzene, etc. to clean the cabinet. Use a clean dry cloth.

12. Accessories – Do not place this appliance on an unstable cart, stand, tripod, bracket, or table. The appliance may fall, causing serious injury to a child or adult, and serious damage to the appliance. Use only with a cart, stand, tripod, bracket, or table recommended by the manufacturer, or sold with the appliance. Any mounting of the appliance should follow the manufacturer's instructions, and should use a mounting accessory recommended by the manufacturer. An appliance and cart combination should be moved with care. Quick stops, excessive force, and uneven surfaces may cause the appliance and cart combination to overturn.



13. Lightning – For added protection for this appliance during a lightning storm, or when it is left unattended and unused for long periods of time, unplug it from the wall outlet and disconnect the antenna or cable system. This will prevent damage to the appliance due to lightning and power-line surges.

14. Abnormal smell – If an abnormal smell or smoke is detected, immediately turn the power OFF and unplug the appliance from the wall outlet. Contact your dealer or nearest service center.

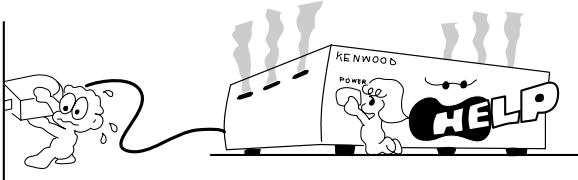

15. Damage requiring service – The appliance should be serviced by qualified service personnel when:

- A.** The power-supply cord or the plug has been damaged.
- B.** Objects have fallen, or liquid has been spilled into the appliance.
- C.** The appliance has been exposed to rain or water.
- D.** The appliance does not appear to operate normally by following the instruction manual. Adjust only those controls that are covered by the instruction manual as an improper adjustment of other controls may result in damage and will often require extensive work by a qualified technician to restore the appliance to its normal operation.
- E.** The appliance has been dropped, or the enclosure damaged.
- F.** The appliance exhibits a marked change in performance.

16. Servicing – The user should not attempt to service the appliance beyond that described in the instruction manual. All other servicing should be referred to qualified service personnel.

17. Outdoor antenna grounding – If an outside antenna is connected to the appliance, be sure the antenna system is grounded so as to provide some protection against voltage surges and built up static charges. Article 810 of the National Electrical Code ANSI/NFPA 70, provides information with respect to proper grounding of the mast and supporting structure, grounding of the lead-in wire to an antenna discharge unit, size of grounding conductors, location of antenna discharge unit, connection to grounding electrodes, and requirements for the grounding electrode. See Figure.

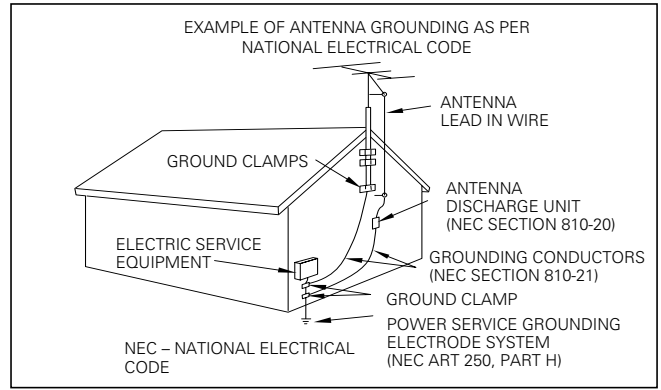

18. Power lines – An outside antenna system should not be located in the vicinity of overhead power lines or other electric light or power circuits, or where it can fall into such power lines or circuits. When installing an outside antenna system, extreme care should be taken to keep from touching such power lines or circuits as contact with them might be fatal.

19. AC outlets – Do not connect other audio equipment with a power consumption larger than that specified to the AC outlet on the rear panel. Never connect other electrical appliances, such as an iron or toaster, to it to prevent fire or electric shock.

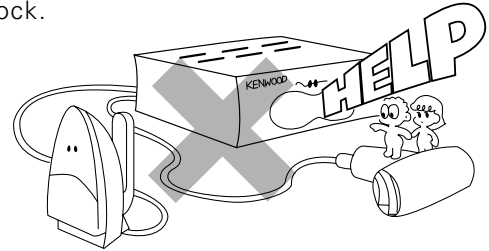

20. Overloading – Do not overload wall outlets, extension cords, or integral convenience receptacles as this can result in a risk of fire or electric shock.

21. Attachment – Do not use attachments not recommended by the appliance manufacturer as they may cause hazards.

22. Replacement parts – When replacement parts are required, be sure the service technician has used replacement parts specified by the manufacturer or have the same characteristics as the original parts. Unauthorized substitutions may result in fire, electric shock, or other hazards.

23. Safety check – Upon completion of any service or repairs to this appliance, ask the service technician to perform safety checks to determine that the appliance is in proper operating condition.

24. Do not mount this appliance to a wall or ceiling. Refer to the installation section for proper placement.

Notes:

1. Item 3 is not required except for grounded or polarized equipment.
2. Item 17 and 18 are not required except for units provided with antenna terminals.
3. Item 17 complies with UL in the U.S.A.

Installation

The Subwoofer is a virtually omnidirectional speaker, so it can be installed in almost any location. For example, the Subwoofer can be installed next to the component system (consisting of an amplifier, tuner, cassette deck, etc.), or in a corner of the room, etc.. The subwoofer's deep-bass reproduction characteristics are richest when the subwoofer is installed in a corner or near a wall. Since the low-bass component in music is usually monaural, only one subwoofer is necessary to obtain a sufficient stereo effect when used in combination with a stereo music system.

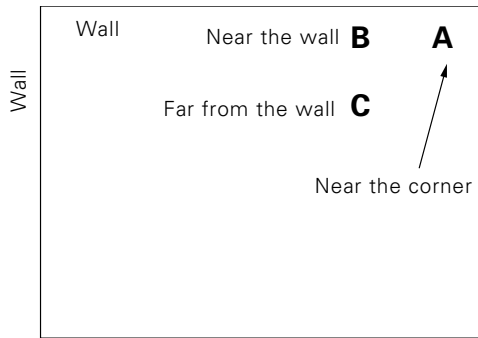

Speaker installation position, viewed from above

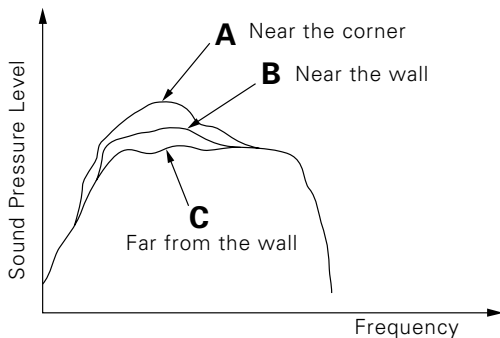

Howling

If the Subwoofer is installed near an analog record turntable, a howling sound may be generated. If this occurs, place the Subwoofer farther away from the turntable or reduce the Subwoofer volume (By rotating the VOLUME control counterclockwise). The howling phenomenon may also occur due to cross interference with a cassette deck, compact disc player, or Laserdisc player, although this is very rare. If sound or picture seems to be distorted due to this reason, place the Subwoofer farther away from other components or reduce its volume.

Operation near a TV

If the Subwoofer is installed too close to a TV, color irregularities may be observed on the TV screen. If such irregularities occur, switch the power of the TV to OFF and then switch it ON again after waiting for a period of 15 to 30 minutes. The influence of the Subwoofer on the TV picture may be improved by self-demagnetization of the TV set. If the color irregularities still persist, move the Subwoofer farther away from the TV.

Caution

To assure ventilation, observe the following points when installing the unit.

- Leave a distance of more than 10 cm between the heat sink of the Subwoofer and the surrounding wall(s). Use special care not to cover the heat sink with a curtain, etc. when installing.

Vertical installation

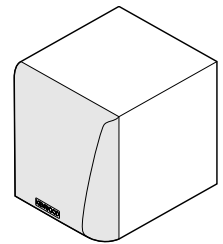

- Be sure to install the Subwoofer vertically.

Connections

Before connection:

Set the POWER switches of the amplifier and Subwoofer to OFF. If they are connected with the POWER switch(es) left ON, one or both components may be damaged.

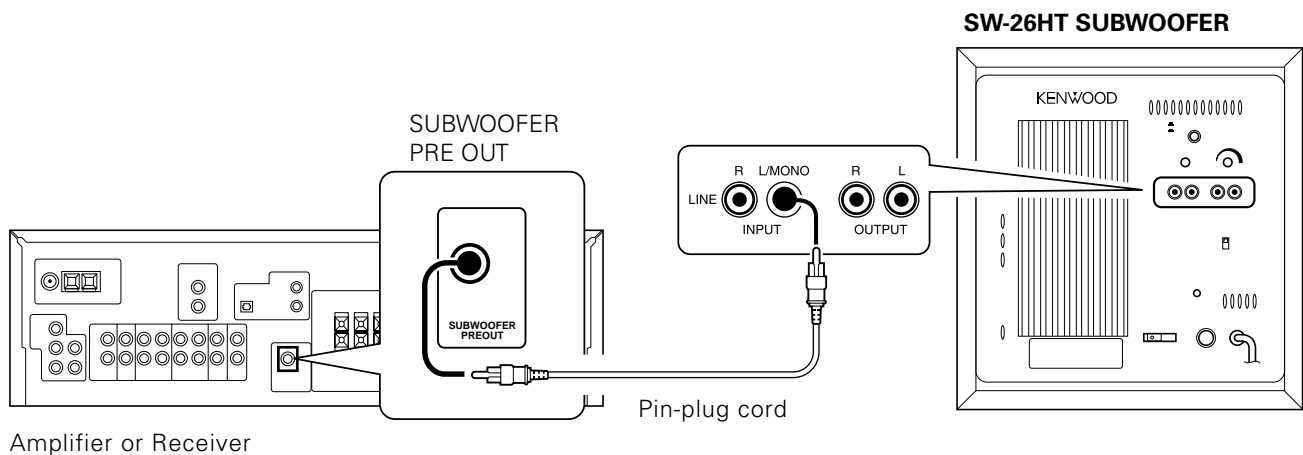

Amplifier or Receiver

Controls and indicators

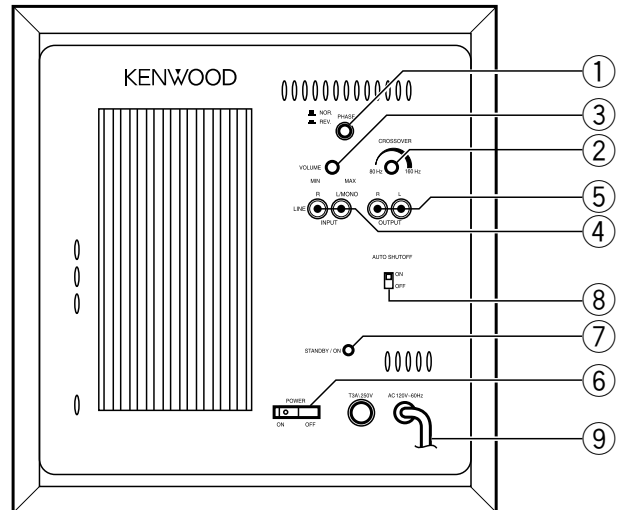
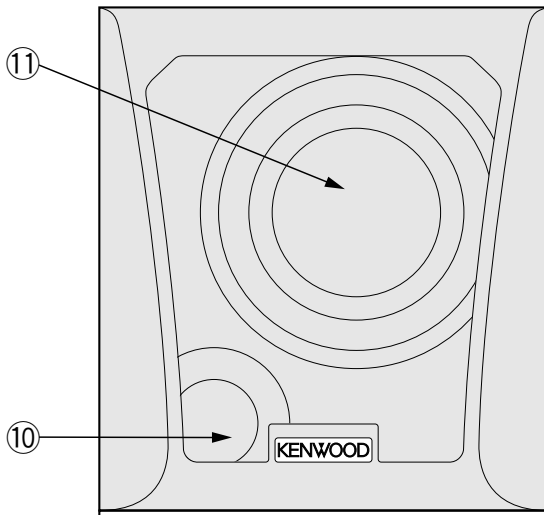

① PHASE switch

The phase relation between the subwoofer and front speakers varies according to the distances, and the subwoofers setup location. Set the phase switch to NOR. (normal phase) or REV (reversed phase) so as to get the best bass sound at the location at which you normally listen.

② CROSSOVER knob

Adjust as necessary for optimal volume of the subwoofer and frequency balance of speakers.

③ VOLUME knob

Adjusts the volume level of the output of the Subwoofer. Rotating the knob clockwise increases the volume level, and rotating the knob counterclockwise decreases the volume level.

④ LINE INPUT (R, L/MONO) terminal

Use to connect to the corresponding SUBWOOFER PRE OUT jacks on your receiver. If your receiver has only one SUBWOOFER PRE OUT jack, make the connection using the L/MONO jack.

⑤ LINE OUTPUT (R, L) terminal

These jacks relay the signals received at the corresponding LINE INPUT jacks.

⑥ POWER switch

Switches the power ON and OFF.

⑦ STANDBY/ON indicator

Comes on to indicate that power is being supplied. Lights up GREEN during normal operation; lights up RED if the subwoofer has been switched into standby mode by the AUTO SHUTOFF feature.

Standby mode

While the standby indicator is lit, a small amount of power is supplied to the system to back up the memory. This is called standby mode.

The power in this equipment will not be completely cut off from the AC wall outlet when the main switch is turned OFF.

⑧ AUTO SHUTOFF switch

Use this switch to set the automatic shutoff feature ON or OFF. If you set this ON, the subwoofer will automatically enter standby mode if it does not receive a signal from the receiver for a period of 30 minutes. The subwoofer will automatically resume normal power when output from the receiver resumes.

⑨ Power cord

Connect to AC outlet.

⑩ Duct

Extend low-frequency output.

⑪ Loudspeaker

Caution concerning operation

An excessive input level to the Subwoofer may impair the sound quality or damage the unit. Careful attention should therefore be paid to the following precautions.

Notes:

1. Do not increase the output of the amplifier to a high level while the low-frequency level is enhanced by the amplifier's tone control or loudness control.
2. When operating the amplifier switches or when placing the stylus on an analog record, set the amplifier volume to its minimum level.

Specifications



Caution: Read this page carefully to ensure safe operation.

Type Subwoofer system with built-in amplifier

[Amplifier]

Rated Output Power 50 W RMS (100 Hz, 0.1%, 4Ω)

Input Sensitivity & Input Impedance 100 mV / 43 kΩ
200 mV / 43 kΩ (MONO)

Rated Power Consumption 50 W

[Speaker]

Enclosure Bass-Reflex, Floor Standing Type

Speaker Units 160 mm (6-1/2 ") Cone type

Nominal Impedance 4 Ω

Dimensions

Width : 290 mm (11-7/16 ")

Height : 300 mm (11-13/16 ")

Depth : 420 mm (16-9/16 ")

Net Weight 10 kg (22.0 lb)

Supplied accessories

Pin-plug cord 1

Cushion 4

NOTE: DO NOT REMOVE THE GRILLE.

Notes:

1. Kenwood follows a policy of continuous advancements in development. For this reason, specifications may be changed without notice.
 2. Full performance may not be exhibited in extremely cold locations (below 0 deg. C).
-