

Cell Type CR17335 Specifications

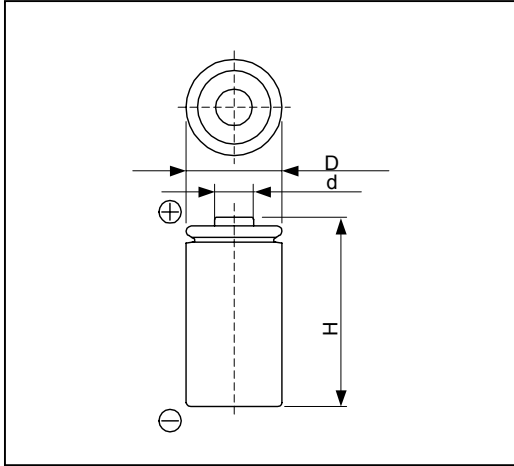

Nominal Capacity* ¹		1400mAh
Nominal Voltage		3V
Standard Discharge Current		10mA
Max. Discharge Current	Continuous* ²	1500mA
	Pulse* ³	3500mA
Temperature Range		-40°C ~ 60°C
Weight		16g
Dimensions	D	17.0mm
	H	33.8mm
	d	6.3mm

*1 Nominal capacity is determined to an end voltage of 2.0V when the battery is allowed to discharge at a standard current level at 23°C.

*2 Current value is determined to be the level at which 50% of the nominal capacity is obtained with an end voltage of 2.0V at 23 °C.

*3 Current value for obtaining 1.0V cell voltage when pulse is applied for 15seconds at 50% discharge depth at 23 °C.

Typical Characteristics

Pulse Discharge Characteristics of CR17335

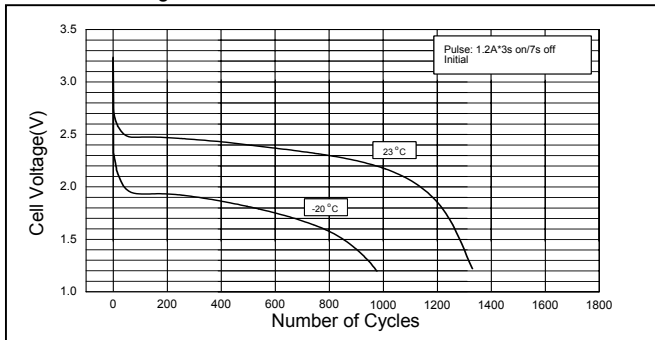

Pulse Discharge Characteristics of CR17335

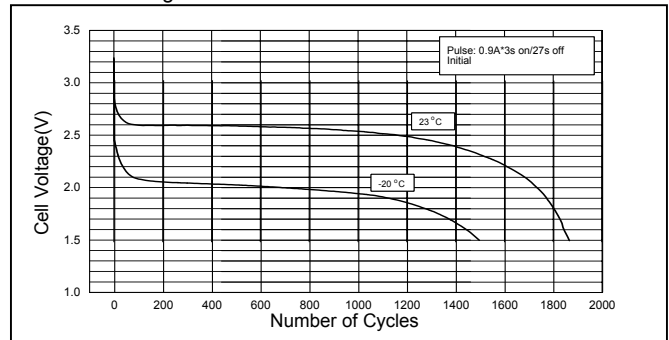

Discharge Characteristics of CR17335

