

# Dell™ Latitude™ D530 Service Manual

[Before You Begin](#)

[Internal Card With Bluetooth® Wireless Technology](#)

[Hard Drive](#)

[Memory Module](#)

[Modem](#)

[Coin-Cell Battery](#)

[Hinge Cover](#)

[Keyboard](#)

[Mini-Card](#)

[Display Assembly](#)

[Palm Rest](#)

[System Fan](#)

[Processor Thermal-Cooling Assembly](#)

[Processor Module](#)

[Speaker Assembly](#)

[Base Latch](#)

[System Board Assembly](#)

[Flashing the BIOS](#)

[Pin Assignments for I/O Connectors](#)

[Glossary](#)

---



Model PP17L

November 2007 Rev. A00

Model PP17L

---

## Notes, Notices, and Cautions

-  **NOTE:** A NOTE indicates important information that helps you make better use of your computer.
-  **NOTICE:** A NOTICE indicates either potential damage to hardware or loss of data and tells you how to avoid the problem.
-  **CAUTION:** A CAUTION indicates a potential for property damage, personal injury, or death.

---

Information in this document is subject to change without notice.  
© 2007 Dell Inc. All rights reserved.

Reproduction in any manner whatsoever without the written permission of Dell Inc. is strictly forbidden.

Trademarks used in this text: *Dell*, the *DELL* logo, *Latitude*, and *Dell OpenManage* are trademarks of Dell Inc.; *Intel*, *Pentium*, and *Celeron* are registered trademarks of Intel Corporation; *Microsoft*, *Windows*, *Windows Server*, *Windows XP*, *MS-DOS* and *Windows Vista* are either trademarks or registered trademarks of Microsoft Corporation in the United States and/or other countries.

Other trademarks and trade names may be used in this document to refer to either the entities claiming the marks and names or their products. Dell Inc. disclaims any proprietary interest in trademarks and trade names other than its own.

## Before You Begin

### Dell™ Latitude™ D530 Service Manual

- [Recommended Tools](#)
- [Turning Off Your Computer](#)
- [Before Working Inside Your Computer](#)

This chapter provides procedures for removing and installing the components in your computer. Unless otherwise noted, each procedure assumes that the following conditions exist:

- 1 You have performed the steps in [Turning Off Your Computer](#) and [Before Working Inside Your Computer](#).
- 1 You have read the safety information in the Dell™ *Product Information Guide*.
- 1 A component can be replaced or—if purchased separately—installed by performing the removal procedure in reverse order.

---

## Recommended Tools

The procedures in this document may require the following tools:

- 1 Small flat-blade screwdriver
- 1 Small Phillips screwdriver
- 1 Small plastic scribe
- 1 Flash BIOS update program CD

---

## Turning Off Your Computer

➡ **NOTICE:** To avoid losing data, save and close all open files and exit all open programs before you turn off your computer.

1. Shut down the operating system:

For the *Microsoft® Windows® XP operating system*:

- a. Save and close all open files and exit all open programs.
- b. Click **Start** → **Shut Down** → **Shut down**.  
The computer turns off after the operating system shutdown process is complete.
- c. Continue to Step 2.

For the *Microsoft Windows Vista® operating system*:

- a. Save and close all open files and exit all open programs.
- b. Click the Windows Vista Start button .
- c. Click the arrow in the lower-right corner of the Start menu as shown below, and then click **Shut Down**.



The computer turns off after the operating system shutdown process is complete.

2. Ensure that the computer and all attached devices are turned off. If your computer and attached devices did not automatically turn off when you shut down your operating system, press and hold the power button for about four seconds until the computer is completely turned off.

---

## Before Working Inside Your Computer

Use the following safety guidelines to help protect your computer from potential damage and to help to ensure your own personal safety.

 **CAUTION:** Before you begin any of the procedures in this section, follow the safety instructions in the *Product Information Guide*.

➡ **NOTICE:** Handle components and cards with care. Do not touch the components or contacts on a card. Hold a card by its edges or by its metal mounting bracket. Hold a component such as a processor by its edges, not by its pins.

- ➡ **NOTICE:** Only a certified service technician should perform repairs on your computer. Damage due to servicing that is not authorized by Dell is not covered by your warranty.
- ➡ **NOTICE:** When you disconnect a cable, pull on its connector or on its pull-tab, not on the cable itself. Some cables have connectors with locking tabs: if you are disconnecting this type of cable, press in on the locking tabs before you disconnect the cable. As you pull connectors apart, keep them evenly aligned to avoid bending any connector pins. Also, before you connect a cable, ensure that both connectors are correctly oriented and aligned.
- ➡ **NOTICE:** To avoid damaging the computer, perform the following steps before you begin working inside the computer.

1. Ensure that the work surface is flat and clean to prevent the computer cover from being scratched.
2. Turn off your computer (see [Turning Off Your Computer](#)).
3. If the computer is connected to a docking device (docked), undock it. See the documentation that came with your docking device for instructions.

- ➡ **NOTICE:** To disconnect a network cable, first unplug the cable from your computer and then unplug the cable from the network device.

4. Disconnect all telephone or network cables from the computer.

- ➡ **NOTICE:** To avoid damaging the system board, you must remove the main battery before you service the computer.

5. Disconnect your computer and all attached devices from their electrical outlets.
6. Close the display and turn the computer upside-down on a flat work surface.

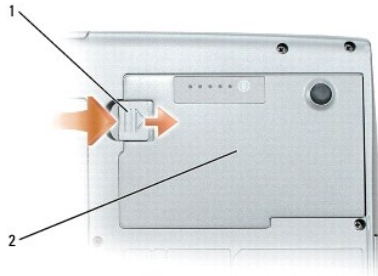

1	battery-bay latch release	2	main battery
---	---------------------------	---	--------------

7. Remove the main battery:
  - a. Slide the battery-bay latch release on the bottom of the computer.
  - b. Remove the battery from the battery bay.
8. Open the display.
9. Press the power button to ground the system board.

- ⚠ **CAUTION:** To guard against electrical shock, always unplug your computer from the electrical outlet before opening the display.

- ➡ **NOTICE:** Before touching anything inside your computer, ground yourself by touching an unpainted metal surface, such as the metal at the back of the computer. While you work, periodically touch an unpainted metal surface to dissipate static electricity, which could harm internal components.

10. Remove any installed PC Cards from the PC Card slot.
11. Remove any installed modules, including a second battery, if installed.
12. Remove the hard drive ([Removing the Hard Drive](#)).

[Back to Contents Page](#)

## Flashing the BIOS

**Dell™ Latitude™ D530 Service Manual**

1. Download the BIOS utility from the Dell Support website at [support.dell.com](http://support.dell.com) and save it to your desktop.
  2. After the download completes, double-click the BIOS utility file.
  3. In the **Dell BIOS Flash** window, click **Continue**.
  4. When the reboot message appears, click **OK** and wait for the computer to restart.
- 

[Back to Contents Page](#)

## Internal Card With Bluetooth® Wireless Technology

### Dell™ Latitude™ D530 Service Manual

- [Adding the Card](#)
- [Removing the Card](#)

---

## Adding the Card

**⚠ CAUTION:** Before performing the following procedures, read the safety instructions in your *Product Information Guide*.

**🔌 NOTICE:** To avoid electrostatic discharge, ground yourself by using a wrist grounding strap or by touching a connector on the back panel of the computer.

1. Follow the procedures in [Before You Begin](#).
2. Remove the hard drive (see [Hard Drive](#)).
3. Attach the card cable to the wireless card.
4. Slide the card into the computer.

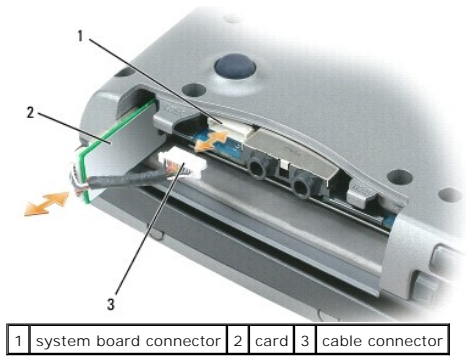

5. Attach the card cable connector to the system board as shown in the figure above.

---

## Removing the Card

**⚠ CAUTION:** Before performing the following procedures, read the safety instructions in your *Product Information Guide*.

**🔌 NOTICE:** To avoid electrostatic discharge, ground yourself by using a wrist grounding strap or by periodically touching a connector on the back panel of the computer.

If you ordered an internal card with Bluetooth wireless technology with your computer, it is already installed.

1. Follow the procedures in [Before You Begin](#).
2. Remove the hard drive (see [Hard Drive](#)).
3. Pull the card cable connector out of the system board connector.
4. Pull the cable to remove the card from the computer.

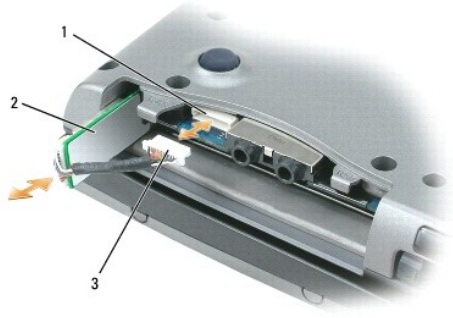

1	system board connector	2	card	3	cable connector
---	------------------------	---	------	---	-----------------

➡ **NOTICE:** Be careful when removing the card to avoid damaging the card, card cable, or surrounding components.

---

[Back to Contents Page](#)

## Coin-Cell Battery

### Dell™ Latitude™ D530 Service Manual

**⚠ CAUTION:** Before performing the following procedures, follow the safety instructions in your *Product Information Guide*.

**➡ NOTICE:** To avoid electrostatic discharge, ground yourself by using a wrist grounding strap or by periodically touching a connector on the back panel of the computer.

**➡ NOTICE:** To prevent damage to the system board, remove the main battery before you service the computer.

1. Follow the procedures in [Before Working Inside Your Computer](#).
2. Turn the computer upside-down, loosen the captive screw on the component cover, and then remove the component cover.



3. Use a plastic scribe to slide into the guide on the side of the coin-cell battery bay and lift the battery out.

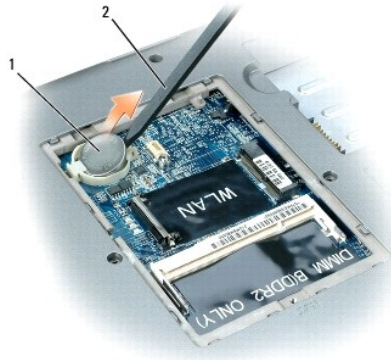

1	coin-cell battery	2	plastic scribe
---	-------------------	---	----------------

When you replace the battery:

1. Insert the battery at a 30-degree angle under the clip with the positive (identified by a plus [+] symbol) side up.
2. Push the battery into place.

Captive Screw

## Processor Module

### Dell™ Latitude™ D530 Service Manual

- [Removing the Processor Module](#)
- [Replacing the Processor Module](#)

---

## Removing the Processor Module

**⚠ CAUTION:** Before you begin the following procedure, follow the safety instructions in the *Product Information Guide*.

- ➡ **NOTICE:** To avoid electrostatic discharge, ground yourself by using a wrist grounding strap or by periodically touching an unpainted metal surface (such as the back panel) on the computer.
- ➡ **NOTICE:** Do not touch the processor die. Press and hold the processor down on the substrate on which the die is mounted while turning the cam screw to prevent intermittent contact between the cam screw and processor.
- ➡ **NOTICE:** To avoid damage to the processor, hold the screwdriver so that it is perpendicular to the processor when turning the cam screw.
- ➡ **NOTICE:** To help prevent damage to the system board, remove the main battery (see [Before Working Inside Your Computer](#)) before working inside the computer.

1. Follow the instructions in [Before You Begin](#).
2. Remove the hinge cover (see [Hinge Cover](#)).
3. Remove the keyboard (see [Keyboard](#)).

➡ **NOTICE:** To ensure maximum cooling for the processor, do not touch the heat transfer areas on the processor thermal-cooling assembly. The oils in your skin reduce the heat transfer capability of the thermal pads.

4. Remove the processor thermal-cooling assembly (see [Removing the Processor Thermal-Cooling Assembly](#)).

➡ **NOTICE:** When removing the processor module, pull the module straight up. Be careful not to bend the pins on the processor module.

5. To loosen the ZIF socket, use a small, flat-blade screwdriver and rotate the ZIF-socket cam screw counterclockwise until it comes to the cam stop.



1	pin-1 corner of microprocessor	2	processor module	3	ZIF-socket cam screw
---	--------------------------------	---	------------------	---	----------------------

**🔍 NOTE:** The ZIF-socket cam screw secures the processor to the system board. Take note of the arrow on the ZIF-socket cam screw, which indicates the direction to turn the cam screw.

6. Lift the processor module from the ZIF socket.

---

## Replacing the Processor Module



➡ **NOTICE:** Ensure that the cam lock is in the fully open position before seating the processor module. Seating the processor module properly in the ZIF socket does not require force.

➡ **NOTICE:** A processor module that is not properly seated can result in an intermittent connection or permanent damage to the processor and ZIF socket.

🔍 **NOTE:** If a new microprocessor is installed, you will receive one of the following:

- a new thermal-cooling assembly which will include an affixed thermal pad or
- you will receive a new thermal pad along with a tech sheet to illustrate proper installation.

1. Align the pin-1 corner of the processor module with the pin-1 corner of the ZIF socket, and insert the processor module.

🔍 **NOTE:** The pin-1 corner of the processor module has a triangle that aligns with the triangle on the pin-1 corner of the ZIF socket.

➡ **NOTICE:** You must position the processor module correctly in the ZIF socket to avoid permanent damage to the module and the socket.

When the processor module is correctly seated, all four corners are aligned at the same height. If one or more corners of the module are higher than the others, the module is not seated correctly.

2. Tighten the ZIF socket by turning the cam screw clockwise to secure the processor module to the system board.

3. Perform the steps in [Removing the Processor Module](#) in reverse order, beginning with [step 4](#).

---

[Back to Contents Page](#)

## Processor Thermal-Cooling Assembly

Dell™ Latitude™ D530 Service Manual

- [Removing the Processor Thermal-Cooling Assembly](#)
- [Replacing the Processor Thermal-Cooling Assembly](#)

---

### Removing the Processor Thermal-Cooling Assembly

- ⚠ **CAUTION:** Before you begin the following procedure, follow the safety instructions in the *Product Information Guide*.
- ➡ **NOTICE:** To avoid electrostatic discharge, ground yourself by using a wrist grounding strap or by periodically touching an unpainted metal surface (such as the back panel) on the computer.
- ➡ **NOTICE:** To help prevent damage to the system board, remove the main battery (see [Before Working Inside Your Computer](#)) before working inside the computer.

1. Follow the instructions in [Before You Begin](#).
2. Remove the hinge cover (see [Hinge Cover](#)).
3. Remove the keyboard (see [Keyboard](#)).
4. Remove the captive screw that attaches the display cable to the system board.
5. Disconnect the display cable from the display cable connector on the system board.
6. Release the three antenna cables from the three antenna-securing clips.
7. Disconnect the three Mini-Card antenna cables (see [Mini-Card](#)).

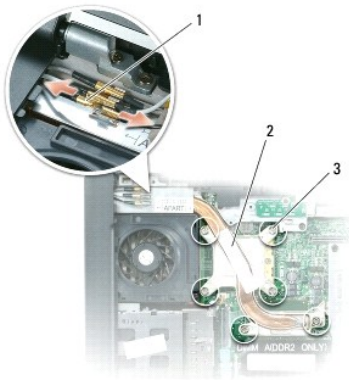

1	antenna cable connectors (3)	2	processor thermal-cooling assembly	3	captive screws (6)
---	------------------------------	---	------------------------------------	---	--------------------

8. In consecutive order, loosen the six captive screws labeled "1" through "6," that secure the processor thermal-cooling assembly to the system board and remove the processor thermal-cooling assembly away from the computer.

---

### Replacing the Processor Thermal-Cooling Assembly

- ⚠ **CAUTION:** Before you begin the following procedure, follow the safety instructions in the *Product Information Guide*.
- ➡ **NOTICE:** To avoid electrostatic discharge, ground yourself by using a wrist grounding strap or by periodically touching an unpainted metal surface (such as the back panel) on the computer.
- ➡ **NOTICE:** To help prevent damage to the system board, remove the main battery (see [Before Working Inside Your Computer](#)) before working inside the computer.

1. Place the processor thermal-cooling assembly over the processor.

2. Tighten the six captive screws, labeled "1" through "6," in consecutive order.

---

[Back to Contents Page](#)

## Display Assembly

### Dell™ Latitude™ D530 Service Manual

- [Removing the Display Assembly](#)
- [Removing the Display Bezel](#)
- [Replacing the Display Bezel](#)
- [Display Panel](#)
- [Display Latch](#)

---

## Removing the Display Assembly

**⚠ CAUTION:** Before you begin the following procedure, follow the safety instructions in the *Product Information Guide*.

- **NOTICE:** To avoid electrostatic discharge, ground yourself by using a wrist grounding strap or by periodically touching an unpainted metal surface (such as the back panel) on the computer.
- **NOTICE:** To help prevent damage to the system board, remove the main battery (see [Before Working Inside Your Computer](#)) before working inside the computer.

1. Follow the instructions in [Before Working Inside Your Computer](#).
2. Remove the hinge cover (see [Hinge Cover](#)).
3. Remove the keyboard (see [Keyboard](#)).
4. Remove the captive screw that grounds the display cable.
5. Disconnect the display cable from the display cable connector on the system board.
6. Disconnect the three Mini-Card antenna cables (see [Mini-Card](#)).
7. Disconnect the antenna cables from the display by holding the two gold antenna connectors on each connector and gently pulling them apart.

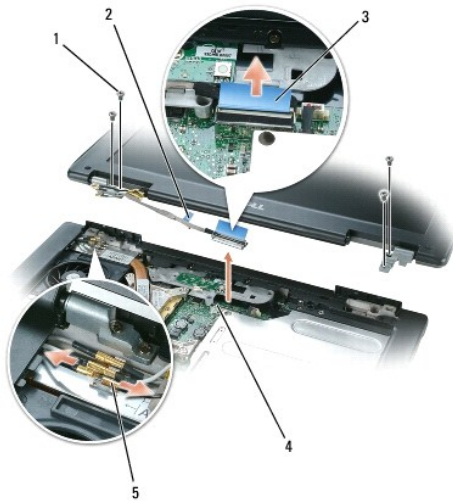

1	M2.5 x 5-mm screws (4)	2	display cable grounding-wire screw	3	display cable pull-tab
4	display connector on system board	5	antenna cable connectors (3)		

8. Remove the four M2.5 x 5-mm screws from the display and remove the display from the computer.

## Replacing the Display Assembly

👉 **NOTICE:** Ensure the antenna cables are not twisted and that they are lying flat in the antenna cable clip.

1. Replace the four M2.5 x 5-mm screws that secure the display to the computer base.
  2. Connect the display cable to the system board.
  3. Connect the three antenna cables.
  4. Replace the keyboard.
  5. Replace the hinge cover.
- 

## Removing the Display Bezel

⚠️ **CAUTION:** Before you begin the following procedure, follow the safety instructions in the *Product Information Guide*.

👉 **NOTICE:** To avoid electrostatic discharge, ground yourself by using a wrist grounding strap or by periodically touching an unpainted metal surface (such as the back panel) on the computer.

👉 **NOTICE:** To help prevent damage to the system board, you must remove the main battery (see [Before Working Inside Your Computer](#)) before you begin working inside the computer.

1. Follow the instructions in [Before Working Inside Your Computer](#).
2. Remove the display assembly (see [Removing the Display Assembly](#)).
3. Remove the five rubber display bumpers.
4. Remove the six M2 x 5-mm screws around the display bezel.

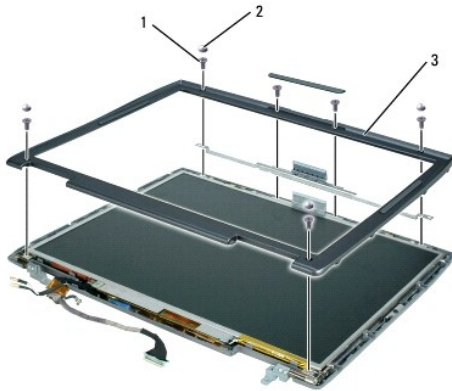

1	M2 x 5-mm screws(6)	2	rubber display bumpers (5)	3	display bezel
---	---------------------	---	----------------------------	---	---------------

👉 **NOTICE:** Removal of the bezel from the display back cover requires extreme care to avoid damage to the bezel.

5. Starting at the edges of the bottom of the display panel, use your fingers to separate the bezel from the top cover by lifting the inside edge of the bezel away from the top cover.
- 

## Replacing the Display Bezel

1. Starting at any corner, use your fingers to gently snap the bezel into place to secure it to the display panel.
  2. Replace the six M2 x 5-mm screws around the display bezel.
  3. Replace the five rubber display bumpers around the display bezel.
-

## Display Panel

### Removing the Display Panel

**⚠ CAUTION:** Before you begin the following procedure, follow the safety instructions in the *Product Information Guide*.

**👉 NOTICE:** To avoid electrostatic discharge, ground yourself by using a wrist grounding strap or by touching an unpainted metal surface on the computer.

**👉 NOTICE:** To help prevent damage to the system board, you must remove the main battery (see [Before Working Inside Your Computer](#)) before you begin working inside the computer.

1. Follow the instructions in [Before Working Inside Your Computer](#).
2. Remove the display assembly (see [Removing the Display Assembly](#)).
3. Remove the display bezel (see [Removing the Display Bezel](#)).
4. Remove the eight M2 x 5-mm screws in sequential order (four on each side of the display panel).
5. Lift the display panel out of the display back cover.

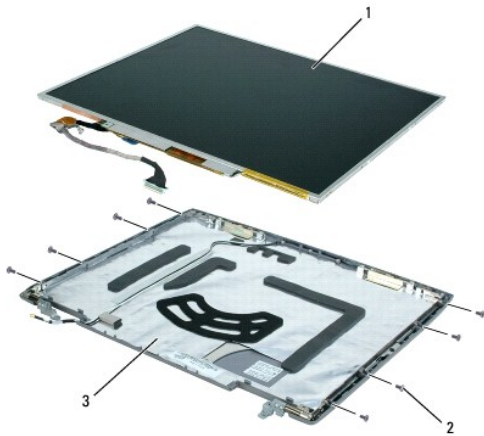

1	display panel	2	M2 x 5-mm screws (8)	3	display back cover
---	---------------	---	----------------------	---	--------------------

6. Use the pull-tab to disconnect the bottom flex-cable connector from the inverter connector.

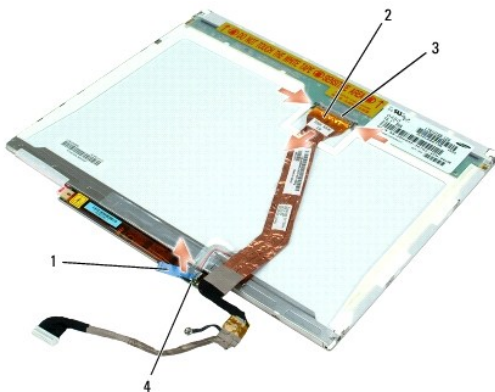

1	pull-tab on bottom flex-cable connector	2	top flex-cable connector	3	display cable connector
4	inverter connector				

## Replacing the Display Panel

1. Reconnect the top display-cable connector to the top flex-cable connector.
2. Reconnect the bottom flex-cable connector to the inverter connector.
3. Replace the display panel inside the display back cover.

 **NOTE:** The eight screw locations are numbered. Replace the screws in sequential order.

4. Replace the eight M2 x 5-mm screws (four on each side) in sequential order around the display panel.
  5. Replace the display bezel.
- 

## Display Latch

### Removing the Display Latch

 **CAUTION:** Before you begin the following procedure, follow the safety instructions in the *Product Information Guide*.

 **NOTICE:** To avoid electrostatic discharge, ground yourself by using a wrist grounding strap or by touching an unpainted metal surface on the computer.

 **NOTICE:** To help prevent damage to the system board, you must remove the main battery (see [Before Working Inside Your Computer](#)) before you begin working inside the computer.

1. Follow the instructions in [Before Working Inside Your Computer](#).
2. Remove the display assembly (see [Removing the Display Assembly](#)).
3. Remove the display bezel (see [Removing the Display Bezel](#)).
4. Remove the display panel (see [Display Panel](#)).

 **NOTICE:** A strip of copper foil may be present beneath the support bracket on some systems; ensure that you *do not* tear this foil while removing the bracket.

5. Remove the M2 x 4-mm screw that secures the display support bracket to the top cover.
6. Lift the display support bracket out of the top cover, and then remove the display latch.

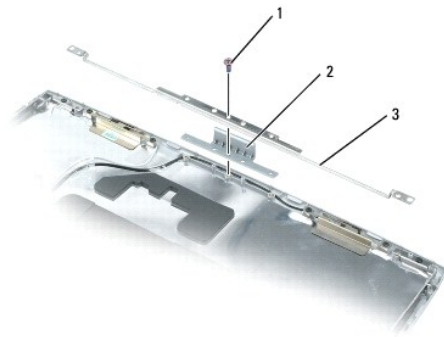

1	M2 x 4-mm screw	2	display latch	3	display support bracket
---	-----------------	---	---------------	---	-------------------------

### Replacing the Display Latch

1. Align the latch with the posts on the display back and set into place.

2. Replace the support bracket and replace the M2 x 4-mm screw.

---

[Back to Contents Page](#)



## System Fan

### Dell™ Latitude™ D530 Service Manual

**⚠ CAUTION:** Before you begin the following procedure, follow the safety instructions in the *Product Information Guide*.

**➡ NOTICE:** To avoid electrostatic discharge, ground yourself by using a wrist grounding strap or by periodically touching an unpainted metal surface (such as the back panel) on the computer.

**➡ NOTICE:** To help prevent damage to the system board, remove the main battery (see [Before Working Inside Your Computer](#)) before working inside the computer.

1. Follow the instructions in [Before Working Inside Your Computer](#).
2. Remove the palm rest (see [Removing the Palm Rest](#)).
3. Remove the two M2.5 x 5-mm screws from the fan, and then remove the connector that connects the fan to the system board

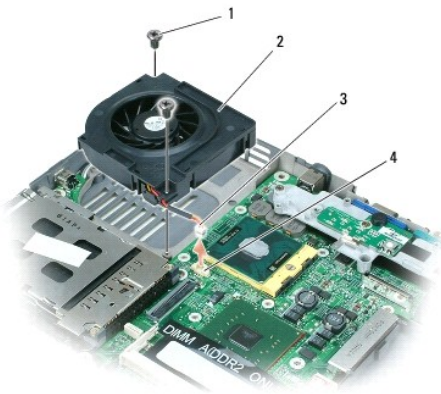

1	M2.5 x 5-mm screws (2)	2	fan	3	fan connector
4	system board connector				

# Glossary

## Dell™ Latitude™ D530 Service Manual

- [IEEE 1394 Connector](#)
- [USB Connector](#)
- [S-Video TV-Out Connector](#)

Terms in this Glossary are provided for informational purposes only and may or may not describe features included with your particular computer.

---

## A

**AC** — alternating current — The form of electricity that powers your computer when you plug the AC adapter power cable in to an electrical outlet.

**ACPI** — advanced configuration and power interface — A power management specification that enables Microsoft® Windows® operating systems to put a computer in standby or hibernate mode to conserve the amount of electrical power allocated to each device attached to the computer.

**AGP** — accelerated graphics port — A dedicated graphics port that allows system memory to be used for video-related tasks. AGP delivers a smooth, true-color video image because of the faster interface between the video circuitry and the computer memory.

**AHCI** — Advanced Host Controller Interface — An interface for a SATA hard drive Host Controller which allows the storage driver to enable technologies such as Native Command Queuing (NCQ) and hot plug.

**ALS** — ambient light sensor — A feature that helps to control display brightness.

**antivirus software** — A program designed to identify, quarantine, and/or delete viruses from your computer.

**ASF** — alert standards format — A standard to define a mechanism for reporting hardware and software alerts to a management console. ASF is designed to be platform- and operating system-independent.

---

## B

**battery life span** — The length of time (years) during which a portable computer battery is able to be depleted and recharged.

**battery operating time** — The length of time (minutes or hours) that a portable computer battery powers the computer.

**BIOS** — basic input/output system — A program (or utility) that serves as an interface between the computer hardware and the operating system. Unless you understand what effect these settings have on the computer, do not change them. Also referred to as *system setup*.

**bit** — The smallest unit of data interpreted by your computer.

**Bluetooth® wireless technology** — A wireless technology standard for short-range (9 m [29 feet]) networking devices that allows for enabled devices to automatically recognize each other.

**boot sequence** — Specifies the order of the devices from which the computer attempts to boot.

**bootable CD** — A CD that you can use to start your computer. In case your hard drive is damaged or your computer has a virus, ensure that you always have a bootable CD or floppy disk available. Your *Drivers and Utilities (or ResourceCD)* is a bootable CD.

**bootable disk** — A disk that you can use to start your computer. In case your hard drive is damaged or your computer has a virus, ensure that you always have a bootable CD or floppy disk available.

**bps** — bits per second — The standard unit for measuring data transmission speed.

**BTU** — British thermal unit — A measurement of heat output.

**bus** — A communication pathway between the components in your computer.

**bus speed** — The speed, given in MHz, that indicates how fast a bus can transfer information.

**byte** — The basic data unit used by your computer. A byte is usually equal to 8 bits.

---

## C

**C** — Celsius — A temperature measurement scale where 0° is the freezing point and 100° is the boiling point of water.

**cache** — A special high-speed storage mechanism which can be either a reserved section of main memory or an independent high-speed storage device. The cache enhances the efficiency of many processor operations.

**L1 cache** — Primary cache stored inside the processor.

**L2 cache** — Secondary cache which can either be external to the processor or incorporated into the processor architecture.

**cartnet** — An international customs document that facilitates temporary imports into foreign countries. Also known as a *merchandise passport*.

**CD-R** — CD recordable — A recordable version of a CD. Data can be recorded only once onto a CD-R. Once recorded, the data cannot be erased or written

over.

**CD-RW** — CD rewritable — A rewritable version of a CD. Data can be written to a CD-RW disc, and then erased and written over (rewritten).

**CD-RW drive** — A drive that can read CDs and write to CD-RW (rewritable CDs) and CD-R (recordable CDs) discs. You can write to CD-RW discs multiple times, but you can write to CD-R discs only once.

**CD-RW/DVD drive** — A drive, sometimes referred to as a combo drive, that can read CDs and DVDs and write to CD-RW (rewritable CDs) and CD-R (recordable CDs) discs. You can write to CD-RW discs multiple times, but you can write to CD-R discs only once.

**clock speed** — The speed, given in MHz, that indicates how fast computer components that are connected to the system bus operate.

**COA** — Certificate of Authenticity — The Windows alpha-numeric code located on a sticker on your computer. Also referred to as the *Product Key* or *Product ID*.

**Control Panel** — A Windows utility that allows you to modify operating system and hardware settings, such as display settings.

**controller** — A chip that controls the transfer of data between the processor and memory or between the processor and devices.

**CRIMM** — continuity rambus in-line memory module — A special module that has no memory chips and is used to fill unused RIMM slots.

**cursor** — The marker on a display or screen that shows where the next keyboard, touch pad, or mouse action will occur. It often is a blinking solid line, an underline character, or a small arrow.

---

## D

**DDR SDRAM** — double-data-rate SDRAM — A type of SDRAM that doubles the data burst cycle, improving system performance.

**DDR2 SDRAM** — double-data-rate 2 SDRAM — A type of DDR SDRAM that uses a 4-bit prefetch and other architectural changes to boost memory speed to over 400 MHz.

**device** — Hardware such as a disk drive, printer, or keyboard that is installed in or connected to your computer.

**device driver** — See *driver*.

**DIMM** — dual in-line memory module — A circuit board with memory chips that connects to a memory module on the system board.

**DIN connector** — A round, six-pin connector that conforms to DIN (Deutsche Industrie-Norm) standards; it is typically used to connect PS/2 keyboard or mouse cable connectors.

**disk striping** — A technique for spreading data over multiple disk drives. Disk striping can speed up operations that retrieve data from disk storage. Computers that use disk striping generally allow the user to select the data unit size or stripe width.

**DMA** — direct memory access — A channel that allows certain types of data transfer between RAM and a device to bypass the processor.

**DMTF** — Distributed Management Task Force — A consortium of hardware and software companies who develop management standards for distributed desktop, network, enterprise, and Internet environments.

**domain** — A group of computers, programs, and devices on a network that are administered as a unit with common rules and procedures for use by a specific group of users. A user logs on to the domain to gain access to the resources.

**DRAM** — dynamic random-access memory — Memory that stores information in integrated circuits containing capacitors.

**driver** — Software that allows the operating system to control a device such as a printer. Many devices do not work properly if the correct driver is not installed in the computer.

**DSL** — Digital Subscriber Line — A technology that provides a constant, high-speed Internet connection through an analog telephone line.

**dual-core** — A technology in which two physical computational units exist inside a single processor package, thereby increasing computing efficiency and multi-tasking ability.

**dual display mode** — A display setting that allows you to use a second monitor as an extension of your display. Also referred to as *extended display mode*.

**DVD-R** — DVD recordable — A recordable version of a DVD. Data can be recorded only once onto a DVD-R. Once recorded, the data cannot be erased or written over.

**DVD+RW** — DVD rewritable — A rewritable version of a DVD. Data can be written to a DVD+RW disc, and then erased and written over (rewritten). (DVD+RW technology is different from DVD-RW technology.)

**DVD+RW drive** — drive that can read DVDs and most CD media and write to DVD+RW (rewritable DVDs) discs.

**DVI** — digital video interface — A standard for digital transmission between a computer and a digital video display.

---

## E

**ECC** — error checking and correction — A type of memory that includes special circuitry for testing the accuracy of data as it passes in and out of memory.

**ECP** — extended capabilities port — A parallel connector design that provides improved bidirectional data transmission. Similar to EPP, ECP uses direct memory access to transfer data and often improves performance.

**EIDE** — enhanced integrated device electronics — An improved version of the IDE interface for hard drives and CD drives.

**EMI** — electromagnetic interference — Electrical interference caused by electromagnetic radiation.

**EPP** — enhanced parallel port — A parallel connector design that provides bidirectional data transmission.

**ESD** — electrostatic discharge — A rapid discharge of static electricity. ESD can damage integrated circuits found in computer and communications equipment.

**expansion card** — A circuit board that installs in an expansion slot on the system board in some computers, expanding the capabilities of the computer. Examples include video, modem, and sound cards.

**expansion slot** — A connector on the system board (in some computers) where you insert an expansion card, connecting it to the system bus.

**ExpressCard** — A removable I/O card adhering to the PCMCIA standard. Modems and network adapters are common types of ExpressCards. ExpressCards support both the PCI Express and USB 2.0 standard.

**Express Service Code** — A numeric code located on a sticker on your Dell™ computer. Use the Express Service Code when contacting Dell for assistance. Express Service Code service may not be available in some countries.

**extended display mode** — A display setting that allows you to use a second monitor as an extension of your display. Also referred to as *dual display mode*.

**extended PC Card** — A PC Card that extends beyond the edge of the PC Card slot when installed.

---

## F

**Fahrenheit** — A temperature measurement scale where 32° is the freezing point and 212° is the boiling point of water.

**FBD** — fully-buffered DIMM — A DIMM with DDR2 DRAM chips and an Advanced Memory Buffer (AMB) that speeds communication between the DDR2 SDRAM chips and the system.

**FCC** — Federal Communications Commission — A U.S. agency responsible for enforcing communications-related regulations that state how much radiation computers and other electronic equipment can emit.

**fingerprint reader** — A strip sensor that uses your unique fingerprint to authenticate your user identity to help secure your computer.

**folder** — A term used to describe space on a disk or drive where files are organized and grouped. Files in a folder can be viewed and ordered in various ways, such as alphabetically, by date, and by size.

**format** — The process that prepares a drive or disk for file storage. When a drive or disk is formatted, the existing information on it is lost.

**FSB** — front side bus — The data path and physical interface between the processor and RAM.

**FTP** — file transfer protocol — A standard Internet protocol used to exchange files between computers connected to the Internet.

---

## G

**G** — gravity — A measurement of weight and force.

**GB** — gigabyte — A measurement of data storage that equals 1024 MB (1,073,741,824 bytes). When used to refer to hard drive storage, the term is often rounded to 1,000,000,000 bytes.

**GHz** — gigahertz — A measurement of frequency that equals one thousand million Hz, or one thousand MHz. The speeds for computer processors, buses, and interfaces are often measured in GHz.

**graphics mode** — A video mode that can be defined as x horizontal pixels by y vertical pixels by z colors. Graphics modes can display an unlimited variety of shapes and fonts.

**GUI** — graphical user interface — Software that interacts with the user by means of menus, windows, and icons. Most programs that operate on the Windows operating systems are GUIs.

---

## H

**hard drive** — A drive that reads and writes data on a hard disk. The terms hard drive and hard disk are often used interchangeably.

**heat sink** — A metal plate on some processors that helps dissipate heat.

**hibernate mode** — A power management mode that saves everything in memory to a reserved space on the hard drive and then turns off the computer. When you restart the computer, the memory information that was saved to the hard drive is automatically restored.

**HTTP** — hypertext transfer protocol — A protocol for exchanging files between computers connected to the Internet.

**Hz** — hertz — A unit of frequency measurement that equals 1 cycle per second. Computers and electronic devices are often measured in kilohertz (kHz), megahertz (MHz), gigahertz (GHz), or terahertz (THz).

---

## I

**IC** — integrated circuit — A semiconductor wafer, or chip, on which thousands or millions of tiny electronic components are fabricated for use in computer, audio, and video equipment.

**IDE** — integrated device electronics — An interface for mass storage devices in which the controller is integrated into the hard drive or CD drive.

**IEEE 1394** — Institute of Electrical and Electronics Engineers, Inc. — A high-performance serial bus used to connect IEEE 1394-compatible devices, such as digital cameras and DVD players, to the computer.

**infrared sensor** — A port that allows you to transfer data between the computer and infrared-compatible devices without using a cable connection.

**integrated** — Usually refers to components that are physically located on the computer's system board. Also referred to as *built-in*.

**I/O** — input/output — An operation or device that enters and extracts data from your computer. Keyboards and printers are I/O devices.

**I/O address** — An address in RAM that is associated with a specific device (such as a serial connector, parallel connector, or expansion slot) and allows the processor to communicate with that device.

**IrDA** — Infrared Data Association — The organization that creates international standards for infrared communications.

**IRQ** — interrupt request — An electronic pathway assigned to a specific device so that the device can communicate with the processor. Each device connection must be assigned an IRQ. Although two devices can share the same IRQ assignment, you cannot operate both devices simultaneously.

**ISP** — Internet service provider — A company that allows you to access its host server to connect directly to the Internet, send and receive e-mail, and access websites. The ISP typically provides you with a software package, user name, and access phone numbers for a fee.

---

## K

**Kb** — kilobit — A unit of data that equals 1024 bits. A measurement of the capacity of memory integrated circuits.

**KB** — kilobyte — A unit of data that equals 1024 bytes but is often referred to as 1000 bytes.

**key combination** — A command requiring you to press multiple keys at the same time.

**KHz** — kilohertz — A measurement of frequency that equals 1000 Hz.

---

## L

**LAN** — local area network — A computer network covering a small area. A LAN usually is confined to a building or a few nearby buildings. A LAN can be connected to another LAN over any distance through telephone lines and radio waves to form a wide area network (WAN).

**LCD** — liquid crystal display — The technology used by portable computer and flat-panel displays.

**LED** — light-emitting diode — An electronic component that emits light to indicate the status of the computer.

**local bus** — A data bus that provides a fast throughput for devices to the processor.

**LPT** — line print terminal — The designation for a parallel connection to a printer or other parallel device.

---

## M

**Mb** — megabit — A measurement of memory chip capacity that equals 1024 Kb.

**Mbps** — megabits per second — One million bits per second. This measurement is typically used for transmission speeds for networks and modems.

**MB** — megabyte — A measurement of data storage that equals 1,048,576 bytes. 1 MB equals 1024 KB. When used to refer to hard drive storage, the term is often rounded to 1,000,000 bytes.

**MB/sec** — megabytes per second — One million bytes per second. This measurement is typically used for data transfer ratings.

**media bay** — A bay that supports devices such as optical drives, a second battery, or a Dell TravelLite™ module.

**memory** — A temporary data storage area inside your computer. Because the data in memory is not permanent, it is recommended that you frequently save your files while you are working on them, and always save your files before you shut down the computer. Your computer can contain several different forms of memory, such as RAM, ROM, and video memory. Frequently, the word memory is used as a synonym for RAM.

**memory address** — A specific location where data is temporarily stored in RAM.

**memory mapping** — The process by which the computer assigns memory addresses to physical locations at start-up. Devices and software can then identify information that the processor can access.

**memory module** — A small circuit board containing memory chips, which connects to the system board.

**MHz** — megahertz — A measure of frequency that equals 1 million cycles per second. The speeds for computer processors, buses, and interfaces are often measured in MHz.

**Mini PCI** — A standard for integrated peripheral devices with an emphasis on communications such as modems and NICs. A Mini PCI card is a small external card that is functionally equivalent to a standard PCI expansion card.

**Mini-Card** — A small card designed for integrated peripherals, such as communication NICs. The Mini-Card is functionally equivalent to a standard PCI expansion card.

**modem** — A device that allows your computer to communicate with other computers over analog telephone lines. Three types of modems include: external, PC Card, and internal. You typically use your modem to connect to the Internet and exchange E-mail.

**module bay** — See *media bay*.

**MP** — megapixel — A measure of image resolution used for digital cameras.

**ms** — millisecond — A measure of time that equals one thousandth of a second. Access times of storage devices are often measured in ms.

---

## N

**network adapter** — A chip that provides network capabilities. A computer may include a network adapter on its system board, or it may contain a PC Card with an adapter on it. A network adapter is also referred to as a *NIC* (network interface controller).

**NIC** — See *network adapter*.

**notification area** — The section of the Windows taskbar that contains icons for providing quick access to programs and computer functions, such as the clock, volume control, and print status. Also referred to as *system tray*.

**ns** — nanosecond — A measure of time that equals one billionth of a second.

**NVRAM** — nonvolatile random access memory — A type of memory that stores data when the computer is turned off or loses its external power source. NVRAM is used for maintaining computer configuration information such as date, time, and other system setup options that you can set.

---

## O

**optical drive** — A drive that uses optical technology to read or write data from CDs, DVDs, or DVD+RWs. Example of optical drives include CD drives, DVD drives, CD-RW drives, and CD-RW/DVD combo drives.

---

## P

**partition** — A physical storage area on a hard drive that is assigned to one or more logical storage areas known as logical drives. Each partition can contain multiple logical drives.

**PC Card** — A removable I/O card adhering to the PCMCIA standard. Modems and network adapters are common types of PC Cards.

**PCI** — peripheral component interconnect — PCI is a local bus that supports 32-and 64-bit data paths, providing a high-speed data path between the processor and devices such as video, drives, and networks.

**PCI Express** — A modification to the PCI interface that boosts the data transfer rate between the processor and the devices attached to it. PCI Express can transfer data at speeds from 250 MB/sec to 4 GB/sec. If the PCI Express chip set and the device are capable of different speeds, they will operate at the slower speed.

**PCMCIA** — Personal Computer Memory Card International Association — The organization that establishes standards for PC Cards.

**PIO** — programmed input/output — A method of transferring data between two devices through the processor as part of the data path.

**pixel** — A single point on a display screen. Pixels are arranged in rows and columns to create an image. A video resolution, such as 800 x 600, is expressed as the number of pixels across by the number of pixels up and down.

**Plug-and-Play** — The ability of the computer to automatically configure devices. Plug and Play provides automatic installation, configuration, and compatibility with existing hardware if the BIOS, operating system, and all devices are Plug and Play compliant.

**POST** — power-on self-test — Diagnostics programs, loaded automatically by the BIOS, that perform basic tests on the major computer components, such as memory, hard drives, and video. If no problems are detected during POST, the computer continues the start-up.

**processor** — A computer chip that interprets and executes program instructions. Sometimes the processor is referred to as the CPU (central processing unit).

**PS/2** — personal system/2 — A type of connector for attaching a PS/2-compatible keyboard, mouse, or keypad.

**PXE** — pre-boot execution environment — A WfM (Wired for Management) standard that allows networked computers that do not have an operating system to be configured and started remotely.

---

## R

**RAID** — redundant array of independent disks — A method of providing data redundancy. Some common implementations of RAID include RAID 0, RAID 1, RAID 5, RAID 10, and RAID 50.

**RAM** — random-access memory — The primary temporary storage area for program instructions and data. Any information stored in RAM is lost when you shut down your computer.

**readme file** — A text file included with a software package or hardware product. Typically, readme files provide installation information and describe new

product enhancements or corrections that have not yet been documented.

**read-only** — Data and/or files you can view but cannot edit or delete. A file can have read-only status if:

- o It resides on a physically write-protected floppy disk, CD, or DVD.
- o It is located on a network in a directory and the system administrator has assigned rights only to specific individuals.

**refresh rate** — The frequency, measured in Hz, at which your screen's horizontal lines are recharged (sometimes also referred to as its *vertical frequency*). The higher the refresh rate, the less video flicker can be seen by the human eye.

**resolution** — The sharpness and clarity of an image produced by a printer or displayed on a monitor. The higher the resolution, the sharper the image.

**RFI** — radio frequency interference — **Interference that is generated at typical radio frequencies, in the range of 10 kHz to 100,000 MHz. Radio frequencies are at the lower end of the electromagnetic frequency spectrum and are more likely to have interference than the higher frequency radiations, such as infrared and light.**

**ROM** — read-only memory — Memory that stores data and programs that cannot be deleted or written to by the computer. ROM, unlike RAM, retains its contents after you shut down your computer. Some programs essential to the operation of your computer reside in ROM.

**RPM** — revolutions per minute — The number of rotations that occur per minute. Hard drive speed is often measured in rpm.

**RTC** — real time clock — Battery-powered clock on the system board that keeps the date and time after you shut down the computer.

**RTCST** — real-time clock reset — A jumper on the system board of some computers that can often be used for troubleshooting problems.

---

## S

**SAS** — serial attached SCSI — A faster, serial version of the SCSI interface (as opposed to the original SCSI parallel architecture).

**SATA** — serial ATA — A faster, serial version of the ATA (IDE) interface.

**ScanDisk** — A Microsoft utility that checks files, folders, and the hard disk's surface for errors. ScanDisk often runs when you restart the computer after it has stopped responding.

**SCSI** — small computer system interface — A high-speed interface used to connect devices to a computer, such as hard drives, CD drives, printers, and scanners. The SCSI can connect many devices using a single controller. Each device is accessed by an individual identification number on the SCSI controller bus.

**SDRAM** — synchronous dynamic random-access memory — A type of DRAM that is synchronized with the optimal clock speed of the processor.

**serial connector** — An I/O port often used to connect devices such as a handheld digital device or digital camera to your computer.

**Service Tag** — A bar code label on your computer that identifies your computer when you access Dell Support at [support.dell.com](http://support.dell.com) or when you call Dell for customer service or technical support.

**setup program** — A program that is used to install and configure hardware and software. The **setup.exe** or **install.exe** program comes with most Windows software packages. *Setup program* differs from *system setup*.

**shortcut** — An icon that provides quick access to frequently used programs, files, folders, and drives. When you place a shortcut on your Windows desktop and double-click the icon, you can open its corresponding folder or file without having to find it first. Shortcut icons do not change the location of files. If you delete a shortcut, the original file is not affected. Also, you can rename a shortcut icon.

**SIM** — Subscriber Identity Module — A SIM card contains a microchip that encrypts voice and data transmissions. SIM cards can be used in phones or portable computers.

**smart card** — A card that is embedded with a processor and a memory chip. Smart cards can be used to authenticate a user on computers equipped for smart cards.

**S/PDIF** — Sony/Philips Digital Interface — An audio transfer file format that allows the transfer of audio from one file to another without converting it to and from an analog format, which could degrade the quality of the file.

**standby mode** — A power management mode that shuts down all unnecessary computer operations to save energy.

**Strike Zone™** — Reinforced area of the platform base that protects the hard drive by acting as a dampening device when a computer experiences resonating shock or is dropped (whether the computer is on or off).

**surge protectors** — Prevent voltage spikes, such as those that may occur during an electrical storm, from entering the computer through the electrical outlet. Surge protectors do not protect against lightning strikes or against brownouts, which occur when the voltage drops more than 20 percent below the normal AC-line voltage level.

Network connections cannot be protected by surge protectors. Always disconnect the network cable from the network connector during electrical storms.

**SVGA** — super-video graphics array — A video standard for video cards and controllers. Typical SVGA resolutions are 800 x 600 and 1024 x 768.

The number of colors and resolution that a program displays depends on the capabilities of the monitor, the video controller and its drivers, and the amount of video memory installed in the computer.

**S-video TV-out** — A connector used to attach a TV or digital audio device to the computer.

**SXGA** — super-extended graphics array — A video standard for video cards and controllers that supports resolutions up to 1280 x 1024.

**SXGA+** — super-extended graphics array plus — A video standard for video cards and controllers that supports resolutions up to 1400 x 1050.

**system board** — The main circuit board in your computer. Also known as the *motherboard*.

**system setup** — A utility that serves as an interface between the computer hardware and the operating system. System setup allows you to configure user-selectable options in the BIOS, such as date and time or system password. Unless you understand what effect the settings have on the computer, do not change the settings for this program.

---

## T

**TAPI** — telephony application programming interface — Enables Windows programs to operate with a wide variety of telephony devices, including voice, data, fax, and video.

**text editor** — A program used to create and edit files that contain only text; for example, Windows Notepad uses a text editor. Text editors do not usually provide word wrap or formatting functionality (the option to underline, change fonts, and so on).

**TPM** — trusted platform module — A hardware-based security feature that when combined with security software enhances network and computer security by enabling features such as file and e-mail protection.

**travel module** — A plastic device designed to fit inside the module bay of a portable computer to reduce the weight of the computer.

---

## U

**UMA** — unified memory allocation — System memory dynamically allocated to video.

**UPS** — uninterruptible power supply — A backup power source used when the electrical power fails or drops to an unacceptable voltage level. A UPS keeps a computer running for a limited amount of time when there is no electrical power. UPS systems typically provide surge suppression and may also provide voltage regulation. Small UPS systems provide battery power for a few minutes to enable you to shut down your computer.

**USB** — universal serial bus — A hardware interface for a low-speed device such as a USB-compatible keyboard, mouse, joystick, scanner, set of speakers, printer, broadband devices (DSL and cable modems), imaging devices, or storage devices. Devices are plugged directly in to a 4-pin socket on your computer or in to a multi-port hub that plugs in to your computer. USB devices can be connected and disconnected while the computer is turned on, and they can also be daisy-chained together.

**UTP** — unshielded twisted pair — Describes a type of cable used in most telephone networks and some computer networks. Pairs of unshielded wires are twisted to protect against electromagnetic interference, rather than relying on a metal sheath around each pair of wires to protect against interference.

**UXGA** — ultra extended graphics array — A video standard for video cards and controllers that supports resolutions up to 1600 x 1200.

---

## V

**video controller** — The circuitry on a video card or on the system board (in computers with an integrated video controller) that provides the video capabilities—in combination with the monitor—for your computer.

**video memory** — Memory that consists of memory chips dedicated to video functions. Video memory is usually faster than system memory. The amount of video memory installed primarily influences the number of colors that a program can display.

**video mode** — A mode that describes how text and graphics are displayed on a monitor. Graphics-based software, such as Windows operating systems, displays in video modes that can be defined as *x* horizontal pixels by *y* vertical pixels by *z* colors. Character-based software, such as text editors, displays in video modes that can be defined as *x* columns by *y* rows of characters.

**video resolution** — See *resolution*.

**virus** — A program that is designed to inconvenience you or to destroy data stored on your computer. A virus program moves from one computer to another through an infected disk, software downloaded from the Internet, or e-mail attachments. When an infected program starts, its embedded virus also starts.

A common type of virus is a boot virus, which is stored in the boot sectors of a floppy disk. If the floppy disk is left in the drive when the computer is shut down and then turned on, the computer is infected when it reads the boot sectors of the floppy disk expecting to find the operating system. If the computer is infected, the boot virus may replicate itself onto all the floppy disks that are read or written in that computer until the virus is eradicated.

**V** — volt — The measurement of electric potential or electromotive force. One V appears across a resistance of 1 ohm when a current of 1 ampere flows through that resistance.

---

## W

**W** — watt — The measurement of electrical power. One W is 1 ampere of current flowing at 1 volt.

**Whr** — watt-hour — A unit of measure commonly used to indicate the approximate capacity of a battery. For example, a 66-Whr battery can supply 66 W of power for 1 hour or 33 W for 2 hours.

**wallpaper** — The background pattern or picture on the Windows desktop. Change your wallpaper through the Windows Control Panel. You can also scan in your favorite picture and make it wallpaper.

**WLAN** — wireless local area network. A series of interconnected computers that communicate with each other over the air waves using access points or wireless routers to provide Internet access.

**write-protected** — Files or media that cannot be changed. Use write-protection when you want to protect data from being changed or destroyed. To write-protect a 3.5-inch floppy disk, slide its write-protect tab to the open position.

**WWAN** — wireless wide area network. A wireless high-speed data network using cellular technology and covering a much larger geographic area than WLAN.



**WXGA** — wide-aspect extended graphics array — A video standard for video cards and controllers that supports resolutions up to 1280 x 800.

---

## X

**XGA** — extended graphics array — A video standard for video cards and controllers that supports resolutions up to 1024 x 768.

---

## Z

**ZIF** — zero insertion force — A type of socket or connector that allows a computer chip to be installed or removed with no stress applied to either the chip or its socket.

**Zip** — A popular data compression format. Files that have been compressed with the Zip format are called Zip files and usually have a filename extension of **.zip**. A special kind of zipped file is a self-extracting file, which has a filename extension of **.exe**. You can unzip a self-extracting file by double-clicking it.

**Zip drive** — A high-capacity floppy drive developed by Iomega Corporation that uses 3.5-inch removable disks called Zip disks. Zip disks are slightly larger than regular floppy disks, about twice as thick, and hold up to 100 MB of data.

## Hard Drive

### Dell™ Latitude™ D530 Service Manual

- [Removing the Hard Drive](#)
- [Replacing the Hard Drive](#)
- [Returning a Hard Drive to Dell](#)

---

## Removing the Hard Drive

- ⚠ **CAUTION:** If you remove the hard drive from the computer when the drive is hot, *do not touch* the metal housing of the hard drive.
- ⚠ **CAUTION:** Before you begin the following procedure, follow the safety instructions in the *Product Information Guide*.
- ➡ **NOTICE:** To prevent data loss, turn off your computer before removing the hard drive. Do not remove the hard drive while the computer is on, in standby mode, or in hibernate mode.
- ➡ **NOTICE:** Hard drives are extremely fragile; even a slight bump can damage the drive.
- 📌 **NOTE:** Dell does not guarantee compatibility or provide support for hard drives from sources other than Dell.

1. Follow the instructions in [Before Working Inside Your Computer](#).
2. Turn the computer upside-down and remove the two M3 x 5-mm screws.

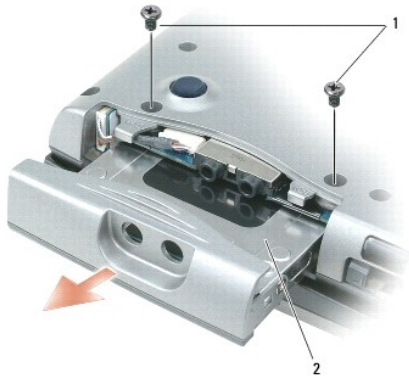

1	M3 x 5-mm screws (2)	2	hard drive
---	----------------------	---	------------

- ➡ **NOTICE:** When the hard drive is not in the computer, store it in protective antistatic packaging. See "Protecting Against Electrostatic Discharge" in your *Product Information Guide*.

3. Slide the hard drive out of the computer.

---

## Replacing the Hard Drive

- ➡ **NOTICE:** Use firm and even pressure to slide the drive into place. If you use excessive force, you may damage the connector.

1. Slide the drive into the bay until it is fully seated.
  2. Replace and tighten the screws.
  3. If you have installed a replacement hard drive, reinstall the Microsoft® Windows® operating system. For instructions, see "Restoring Your Operating System" in the *User's Guide*.
  4. Reinstall drivers on the new hard drive. For instructions, see "Reinstalling Drivers and Utilities" in the *User's Guide*.
-

## Returning a Hard Drive to Dell

Return your old hard drive to Dell in its original or comparable foam packaging. Otherwise, the hard drive may be damaged in transit.

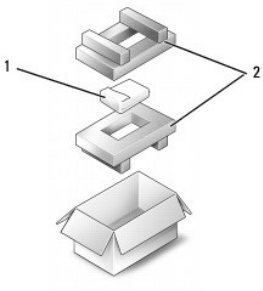

1	hard drive	2	foam packaging
---	------------	---	----------------

---

[Back to Contents Page](#)

## Hinge Cover

### Dell™ Latitude™ D530 Service Manual

**⚠ CAUTION:** Before you begin the following procedure, follow the safety instructions in the *Product Information Guide*.

**👉 NOTICE:** To avoid electrostatic discharge, ground yourself by using a wrist grounding strap or by periodically touching an unpainted metal surface (such as the back panel) on the computer.

**👉 NOTICE:** The hinge cover is fragile and can be damaged if extreme force is used. Be careful when removing the hinge cover.

1. Follow the instructions in [Before Working Inside Your Computer](#).
2. Open the display all the way (180 degrees) so that it lies flat against your work surface.
3. Using a small flat-blade screwdriver, insert the screwdriver on the right side to gently pry the hinge cover loose.
4. Pulling up from right to left, remove the hinge cover.



1 hinge cover

5. With the display open all the way (180 degrees) so that it lies flat against the work surface, snap the cover back into place, starting from left to right.

## Keyboard

### Dell™ Latitude™ D530 Service Manual

- [Removing the Keyboard](#)
- [Replacing the Keyboard](#)

**⚠ CAUTION:** Before you begin any of the procedures in this section, follow the safety instructions in the *Product Information Guide*.

**🔧 NOTICE:** To avoid electrostatic discharge, ground yourself by using a wrist grounding strap or by periodically touching an unpainted metal surface (such as a connector on the back of the computer).

## Removing the Keyboard

1. Follow the procedures in [Before Working Inside Your Computer](#).
2. Remove the hinge cover (see [Hinge Cover](#)).
3. Remove the two M2.5 x 5-mm screws at the top of the keyboard.

**🔧 NOTICE:** The keycaps on the keyboard are fragile, easily dislodged, and time-consuming to replace. Be careful when removing and handling the keyboard.

4. Lift the keyboard only enough to hold it up and slide the keyboard forward to allow access to the keyboard connector on the system board.
5. To release the keyboard cable from the connector on the system board, rotate the plastic bar on the keyboard connector to the left side of the computer.



1	M2.5 x 5-mm screws (2)	2	Keyboard	3	tabs (5)
4	keyboard cable	5	plastic bar on keyboard connector		

## Replacing the Keyboard

**🔧 NOTICE:** To avoid scratching the palm rest when replacing the keyboard, hook the tabs along the front edge of the keyboard into the palm rest, and then secure the keyboard in place.

1. To replace the keyboard, connect the keyboard cable to the connector on the system board.
2. Place the tabs along the front edge of the keyboard into the palm rest, and lay the keyboard down on the palm rest.
3. Replace the two M2.5 x 5-mm screws at the top of the keyboard.
4. Replace the hinge cover.

---

[Back to Contents Page](#)

## Base Latch

### Dell™ Latitude™ D530 Service Manual

**⚠ CAUTION:** Before you begin the following procedure, follow the safety instructions in the *Product Information Guide*.

**➡ NOTICE:** To avoid electrostatic discharge, ground yourself by using a wrist grounding strap or by periodically touching an unpainted metal surface (such as the back panel) on the computer.

**➡ NOTICE:** To help prevent damage to the system board, remove the main battery (see [Before Working Inside Your Computer](#)) before working inside the computer.

1. Follow the instructions in [Before You Begin](#).
2. Remove the palm rest (see [Removing the Palm Rest](#)).
3. Press in the release button, press together the two securing clips, then pull the base latch up and away from the computer base.

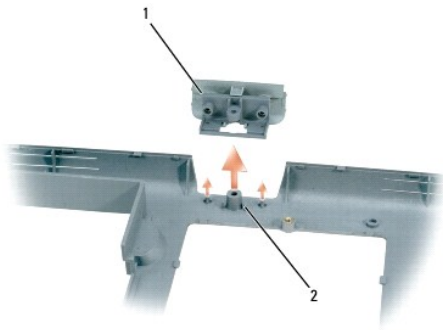

1	base latch	2	securing clips (2)
---	------------	---	--------------------

[Back to Contents Page](#)

## Memory Module

Dell™ Latitude™ D530 Service Manual

- [DIMM B Memory Module](#)
- [DIMM A Memory Module](#)
- [Verify Memory Size](#)

You can increase your computer memory by installing memory modules on the system board. See the *Product Information Guide* for information on the memory supported by your computer. Install only memory modules that are intended for your computer.

This computer has two memory module bays. DIMM A bay is located under the keyboard and DIMM B bay is located under the component cover.

 **NOTE:** Memory modules purchased from Dell are covered under your computer warranty.

 **CAUTION:** Before you begin any of the procedures in this section, follow the safety instructions located in the *Product Information Guide*.

1. Follow the procedures in [Before You Begin](#)
  2. Follow the procedures [Removing the Keyboard](#) to access the DIMM A Memory Module bay.
- 

### DIMM B Memory Module

DIMM B is located under the component cover.

1. Turn the computer upside-down, loosen the captive screw on the component cover.
2. Remove the component cover from the back of the computer.



 **NOTICE:** To prevent damage to the memory module connector, do not use tools to remove or replace the memory module.

3. If you are replacing a memory module, remove the existing module:
  - a. Use your fingertips to carefully spread apart the securing clips on each end of the memory module connector until the module pops up.



- b. Remove the module from the connector.
4. Ground yourself and install the new memory module:



 **NOTE:** If the memory module is not installed properly, the computer may not boot properly. No error message indicates this failure.

- a. Align the notch in the module edge connector with the tab in the connector slot.
- b. Slide the module firmly into the slot at a 45-degree angle.
- c. Rotate the module down until it clicks into place. If you do not feel the click, remove the module repeat from Step 3a.

e. Replace the cover.

 **NOTICE:** If the cover is difficult to close, remove the module and reinstall it. Forcing the cover to close may damage your computer.

---

## DIMM A Memory Module

DIMM A bay is located under the keyboard. Detaching the keyboard from the computer is not required to access the DIMM A memory module bay.

1. Remove the hinge cover (see [Hinge Cover](#)).

2. Remove the two M2.5 x 5-mm screws at the top of the keyboard.

 **NOTICE:** The keycaps on the keyboard are fragile, easily dislodged, and time-consuming to replace. Be careful when removing and handling the keyboard.

3. Lift the keyboard only enough to lay it face down on the glidepad.

 **NOTICE:** To prevent damage to the memory module connector, do not use tools to remove or replace the memory module.

4. If you are replacing a memory module, remove the existing module:

5. Use your fingertips to carefully spread apart the securing clips on each end of the memory module connector until the module pops up.



6. Ground yourself and install the new memory module:

 **NOTE:** If the memory module is not installed properly, the computer may not boot properly. No error message indicates this failure.

- a. Align the notch in the module edge connector with the tab in the connector slot.
- b. Slide the module firmly into the slot at a 45-degree angle.
- c. Rotate the module down until it clicks into place. If you do not feel the click, remove the module repeat from Step 3a.

g. Return the keyboard to the normal position. Replace the two M2.5 x 5-mm screws located at the top of the keyboard.

 **NOTICE:** If the keyboard does not lay flat, lift the keyboard, remove the module and reinstall it. Forcing the keyboard to lay flat may damage your computer.

8. Replace the hinge cover (see [Hinge Cover](#)).

---

## Verify Memory Size

1. Insert the battery into the battery bay, or connect the AC adapter to your computer and an electrical outlet.

2. Turn on the computer.

As the computer boots, it detects the additional memory and automatically updates the system configuration information.

To confirm the amount of memory installed in the computer:

- 1 In the *Microsoft® Windows® XP* operating system, right-click the *My Computer* icon on your desktop. Click **Properties**→**General**.
- 1 In the *Microsoft Windows Vista®* operating system, click the Windows Vista Start button , and right-click **Computer**→**Properties**.

Captive Screw



---

[Back to Contents Page](#)

## Mini-Card

### Dell™ Latitude™ D530 Service Manual

#### [Wireless Local Area Network \(WLAN\) Cards](#)

-  **CAUTION:** Before you begin the following procedure, follow the safety instructions in the *Product Information Guide*.
  -  **NOTICE:** To prevent damage to the system board, remove the main battery before you service the computer.
- 

## Wireless Local Area Network (WLAN) Cards

 **NOTE:** If you ordered a WLAN card with your computer, the card is already installed.

1. Follow the procedures in [Before Working Inside Your Computer](#).
2. Turn the computer upside-down, loosen the captive screw on the cover, and remove the cover from the computer.



3. Ground yourself by touching one of the metal connectors on the back of the computer.

 **NOTE:** If you leave the area, ground yourself again when you return to the computer.

4. If a card is not already installed, go to [step 5](#). If you are replacing a card, remove the existing card:
  - a. Disconnect the antenna cables from the card.

 **NOTE:** Depending on the type of Mini-Card you have, either two or three of the three antenna cables may be in use. The white cable goes to the main antenna connector, the black goes to the auxiliary connector, and the gray goes to the third connector (if applicable).



1 antenna cables (2)

- b. Release the card by pushing the metal securing tab away from the card until the card pops up slightly.

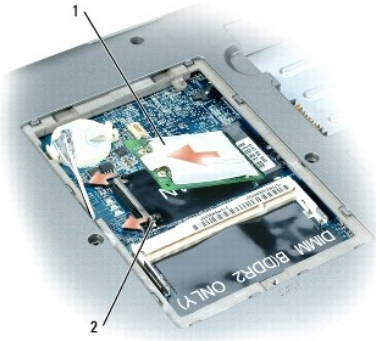

1 WLAN card 2 metal securing tabs (2)

c. Slide the card at a 45-degree angle out of its connector.

➔ **NOTICE:** The connectors are keyed to ensure correct insertion. If you feel resistance, check the connectors and realign the card.

🔧 **NOTE:** Do not insert a Mobile Broadband (WWAN) network card into the WLAN card connector.

🔧 **NOTE:** The WLAN card may have two or three antenna connectors, depending on the type of card you ordered.

5. Install the card:

➔ **NOTICE:** To avoid damaging the WLAN card, never place cables on top of or under the card.

a. Move any antenna cables out of the way to make space for the WLAN card.

b. Align the card with the connector at a 45-degree angle, and press the card into the connector until it clicks.

🔧 **NOTE:** For more specific information about which cable to connect to which connector, see the documentation that came with your WLAN card.

c. Connect the antenna cables to the WLAN card, ensuring that you route the cables correctly.

Captive Screw

---

[Back to Contents Page](#)

## Modem

### Dell™ Latitude™ D530 Service Manual

- [Removing the Modem](#)
- [Replacing the Modem](#)

---

## Removing the Modem

**⚠ CAUTION:** Before you begin the following procedure, follow the safety instructions in the *Product Information Guide*.

- ➡ **NOTICE:** To avoid electrostatic discharge, ground yourself by using a wrist grounding strap or by periodically touching an unpainted metal surface (such as the back panel) on the computer.
- ➡ **NOTICE:** To help prevent damage to the system board, you must remove the main battery (see [Before Working Inside Your Computer](#)) before you begin working inside the computer.

1. Follow the instructions in [Before Working Inside Your Computer](#).
2. Place the computer on a flat working surface.
3. Turn the computer upside-down, loosen the captive screw on the component cover.
4. Remove the component cover from the computer.



5. Remove the M2 x 3-mm screw that attaches the modem to the system board.
6. Pull up on the pull-tab to disconnect the modem from the modem connector on the system board.

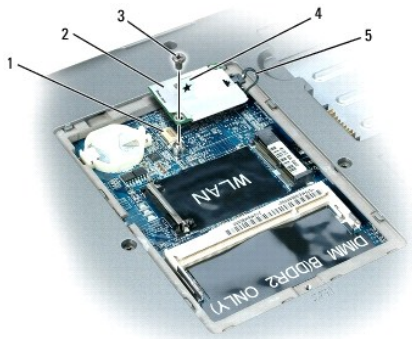

1	modem connector on system board	2	modem	3	M2 x 3-mm screw
4	pull-tab	5	modem cable		

- ➡ **NOTICE:** Do not disconnect the modem cable from the system board.

7. Disconnect the modem cable from the modem.
-

## Replacing the Modem

1. Connect the modem cable to the modem.

 **NOTICE:** Ensure that the modem cable is routed correctly when you replace the modem.

2. Connect the modem to the system board.

Align the connector on the bottom of the modem with the modem connector on the system board, and press down on the right side of the modem.

3. Replace the M2 x 3-mm screw.

Captive Screw

---

[Back to Contents Page](#)

## Palm Rest

### Dell™ Latitude™ D530 Service Manual

- [Removing the Palm Rest](#)
- [Replacing the Palm Rest](#)

## Removing the Palm Rest

**⚠ CAUTION:** Before you begin the following procedure, follow the safety instructions in the *Product Information Guide*.

- **⚡ NOTICE:** To avoid electrostatic discharge, ground yourself by using a wrist grounding strap or by periodically touching an unpainted metal surface (such as the back panel) on the computer.
- **🔋 NOTICE:** To help prevent damage to the system board, remove the main battery (see [Before Working Inside Your Computer](#)) before working inside the computer.

1. Follow the instructions in [Before Working Inside Your Computer](#).
2. Remove the hard drive (see [Removing the Hard Drive](#)).
3. Remove the hinge cover (see [Hinge Cover](#)).
4. Remove the keyboard (see [Removing the Keyboard](#)).
5. Remove the display assembly (see [Removing the Display Assembly](#)).
6. Turn the computer upside down and remove the 14 M2.5 x 8-mm screws from the bottom of the computer.

**🔍 NOTE:** The screw locations may vary slightly from the image shown below.

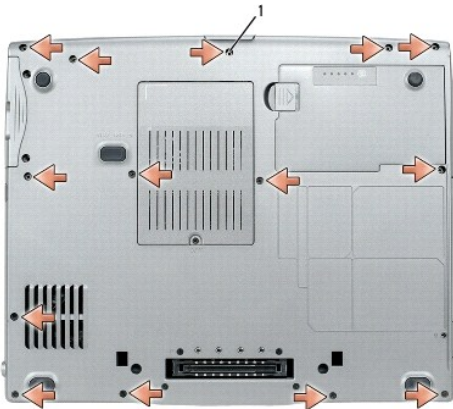

1 M2.5 x 8-mm screws (14)

7. Turn the computer top-side up and remove the four M2.5 x 5-mm screws labeled "P" from the top of the palm rest.

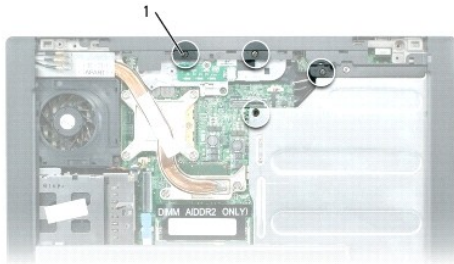

1 M2.5 x 5-mm screws (4)

8. Use the touch pad connector tab to disconnect the touch pad connector from the system board.

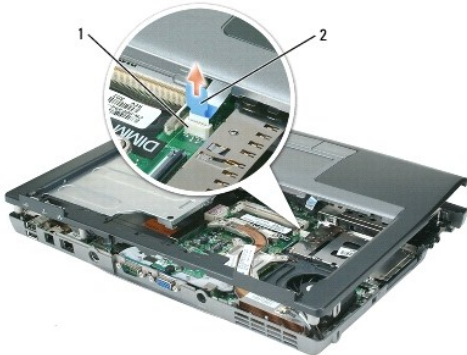

1 touch pad connector 2 tab

9. Starting at the back center of the palm rest, use your fingers to separate the palm rest from the computer base by gently lifting up the palm rest while pressing down on the back of the computer base.

---

## Replacing the Palm Rest

**⚠ CAUTION:** Before you begin the following procedure, follow the safety instructions in the *Product Information Guide*.

**➡ NOTICE:** To avoid electrostatic discharge, ground yourself by using a wrist grounding strap or by periodically touching an unpainted metal surface (such as the back panel) on the computer.

**➡ NOTICE:** To help prevent damage to the system board, remove the main battery (see [Before Working Inside Your Computer](#)) before working inside the computer.

1. Align the palm rest with the bottom plastics and gently snap it into place.
2. Reconnect the touch pad connector to the system board.
3. Replace the four M2.5 x 5-mm screws on the top of the palm rest.
4. Turn the computer upside-down, and replace the 14 M2.5 x 8-mm screws on the bottom of the computer.

---

[Back to Contents Page](#)



## Pin Assignments for I/O Connectors

### Dell™ Latitude™ D530 Service Manual

- [IEEE 1394 Connector](#)
  - [USB Connector](#)
  - [Video Connector](#)
  - [S-Video TV-Out Connector](#)
- 

### IEEE 1394 Connector



Pin	Signal
1	TPB-
2	TPB+
3	TPA-
4	TPA+

---

### USB Connector

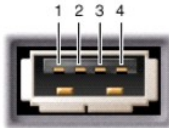

Pin	Signal
1	USB5V+
2	USBP-
3	USBP+
4	GND

---

### Video Connector



Pin	Signal	Pin	Signal
1	CRT_R	9	5V+
2	CRT_G	10	GND
3	CRT_B	11	MONITOR_DETECT-
4	NC	12	DDC_DATA

5	GND	13	CRT_HS
6	GND	14	CRT_VS
7	GND	15	DDC_CLK
8	GND		

---

## S-Video TV-Out Connector

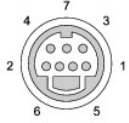

S-Video	
Pin	Signal
1	GND
2	GND
3	DLUMA-L
4	DCRMA-L
Composite Video	
Pin	Signal
5	NC
6	DCMPS-L
7	GND

---

[Back to Contents Page](#)

## Speaker Assembly

Dell™ Latitude™ D530 Service Manual

- [Removing the Speaker Assembly](#)
- [Replacing the Speaker Assembly](#)

---

### Removing the Speaker Assembly

**⚠ CAUTION:** Before you begin the following procedure, follow the safety instructions in the *Product Information Guide*.

🔍 **NOTICE:** To avoid electrostatic discharge, ground yourself by using a wrist grounding strap or by periodically touching an unpainted metal surface (such as the back panel) on the computer.

🔍 **NOTICE:** To help prevent damage to the system board, remove the main battery (see [Before Working Inside Your Computer](#)) before working inside the computer.

1. Follow the instructions in [Before You Begin](#).
2. Remove the hard drive (see [Removing the Hard Drive](#)).
3. Remove the hinge cover (see [Hinge Cover](#)).
4. Remove the keyboard (see [Removing the Keyboard](#)).
5. Remove the display assembly (see [Removing the Display Assembly](#)).
6. Remove the palm rest (see [Removing the Palm Rest](#)).

🔍 **NOTICE:** Handle the speakers with care to help prevent damage to them.

7. Disconnect the speaker cable connector from the system board and remove the M2.5 x 5-mm screw from the speaker assembly.

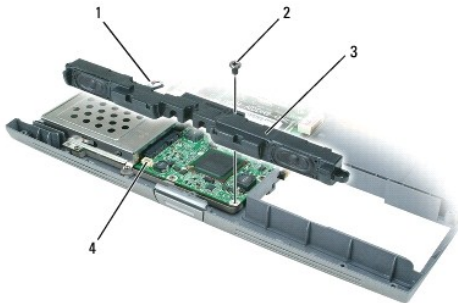

1	speaker cable connector	2	M2.5 x 5-mm screw
3	speaker assembly	4	speaker cable connector on system board

8. Remove the speaker assembly.

---

### Replacing the Speaker Assembly

**⚠ CAUTION:** Before you begin the following procedure, follow the safety instructions in the *Product Information Guide*.

🔍 **NOTICE:** To avoid electrostatic discharge, ground yourself by using a wrist grounding strap or by periodically touching an unpainted metal surface (such as the back panel) on the computer.

🔍 **NOTICE:** To help prevent damage to the system board, remove the main battery (see [Before Working Inside Your Computer](#)) before working inside the computer.

1. Align the speaker assembly on the screw holes for securing the assembly to the computer base.

2. Replace the M2.5 x 5-mm screw that secures the speaker assembly in place.

---

[Back to Contents Page](#)

## System Board Assembly

### Dell™ Latitude™ D530 Service Manual

- [Removing the System Board Assembly](#)
- [Replacing the System Board Assembly](#)

---

## Removing the System Board Assembly

**⚠ CAUTION:** Before you begin the following procedure, follow the safety instructions in the *Product Information Guide*.

- ⚡ **NOTICE:** To avoid electrostatic discharge, ground yourself by using a wrist grounding strap or by periodically touching an unpainted metal surface (such as the back panel) on the computer.
- 🔋 **NOTICE:** To help prevent damage to the system board, remove the main battery (see [Before Working Inside Your Computer](#)) before working inside the computer.

The system board's BIOS chip contains the Service Tag, which is also visible on a barcode label on the bottom of the computer. The replacement kit for the system board includes a CD that provides a utility for transferring the Service Tag to the replacement system board.

1. Follow the instructions in [Before You Begin](#).
2. Remove the hard drive (see [Removing the Hard Drive](#)).
3. Remove the memory module(s) (see [Memory Module](#)).
4. Remove the modem (see [Removing the Modem](#)).
5. Remove the Mini-Card (see [Mini-Card](#)).
6. Remove the hinge cover (see [Hinge Cover](#)).
7. Remove the keyboard (see [Removing the Keyboard](#)).
8. Remove the display assembly (see [Removing the Display Assembly](#)).
9. Remove the processor thermal-cooling assembly (see [Removing the Processor Thermal-Cooling Assembly](#)).
10. Remove the processor (see [Removing the Processor Module](#)).
11. Remove the palm rest (see [Removing the Palm Rest](#)).

**🔧 NOTE:** It is not required but is highly recommended that you remove the system fan (see [System Fan](#)) to allow easier access to the system board.

12. Remove the speaker assembly (see [Removing the Speaker Assembly](#)).
13. Remove the two M2.5 x 5-mm screws labeled "B."

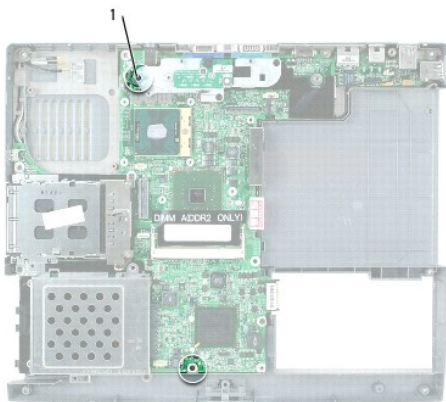

1 M2.5 x 5-mm screws (2)

14. Turn the computer upside down and remove the four M2 x 3-mm screws labeled "B" that secure the system board to the computer base.

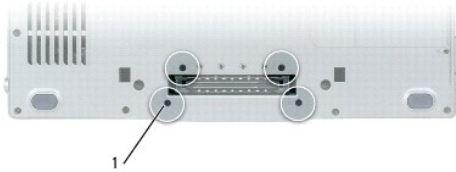

1 M2 x 3-mm screws labeled "B" (4)

15. Remove the system board assembly:
  - a. With the back of the computer facing you, grasp the upper-right corner of the system board assembly and lift it slightly; slowly easing the connectors out of their access holes on the back and side of the computer base.



- b. Pull the system board assembly away from you toward the front of the computer to remove the system board assembly.

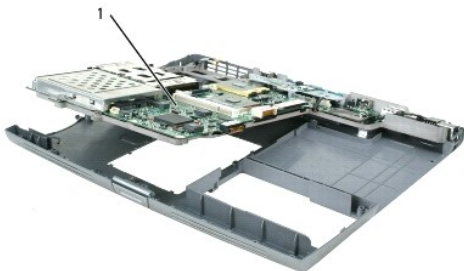

1 system board assembly

---

## Replacing the System Board Assembly

1. Perform all of the steps in [Removing the System Board Assembly](#) in reverse order.

**NOTE:** Before turning on the computer, replace all screws and ensure that no stray screws remain inside the computer. Failure to do so may result in damage to the computer.

2. Turn on the computer.

**NOTE:** If you use a BIOS update program CD to flash the BIOS, press <F12> before inserting the CD so that you can set up the computer to boot from a CD this one time only. Otherwise, you must enter the system setup program to change the default boot order.

3. Insert the flash BIOS update program CD that accompanied the replacement system board into the CD/DVD drive. Follow the instructions that appear on the screen. See [Flashing the BIOS](#) for further information.

4. Enter the system setup program to update the BIOS on the new system board with the computer Service Tag.

---

[Back to Contents Page](#)

[Back to Contents Page](#)

## Dell™ Latitude™ D530 Service Manual



**NOTE:** A NOTE indicates important information that helps you make better use of your computer.



**NOTICE:** A NOTICE indicates either potential damage to hardware or loss of data and tells you how to avoid the problem.



**CAUTION:** A CAUTION indicates a potential for property damage, personal injury, or death.

Information in this document is subject to change without notice.

© 2007 Dell Inc. All rights reserved.

Reproduction in any manner whatsoever without the written permission of Dell Inc. is strictly forbidden.

Trademarks used in this text: *Dell*, the *DELL* logo, *Latitude*, and *Dell OpenManage* are trademarks of Dell Inc.; *Intel*, *Pentium*, and *Celeron* are registered trademarks of Intel Corporation; *Microsoft*, *Windows*, *Windows Server*, *Windows XP*, *MS-DOS* and *Windows Vista* are either trademarks or registered trademarks of Microsoft Corporation in the United States and/or other countries.

Other trademarks and trade names may be used in this document to refer to either the entities claiming the marks and names or their products. Dell Inc. disclaims any proprietary interest in trademarks and trade names other than its own.

---

[Back to Contents Page](#)