

# INSPIRON™

## SETUP GUIDE



YOURS IS HERE



# INSPIRON™

## SETUP GUIDE

Model P03T

Type P03T001

# Notes, Cautions, and Warnings



**NOTE:** A NOTE indicates important information that helps you make better use of your computer.



**CAUTION:** A CAUTION indicates either potential damage to hardware or loss of data and tells you how to avoid the problem.



**WARNING:** A WARNING indicates a potential for property damage, personal injury, or death.

If you purchased a Dell™ n Series computer, any references in this document to Microsoft® Windows® operating systems are not applicable.

---

**Information in this document is subject to change without notice.**

**© 2009 Dell Inc. All rights reserved.**

Reproduction of these materials in any manner whatsoever without the written permission of Dell Inc. is strictly forbidden.

Trademarks used in this text: *Dell*, the *DELL* logo, *YOURS IS HERE*, *Dell On Call*, and *DellConnect* are trademarks of Dell Inc.; *Intel*, *Celeron*, and *Pentium* are registered trademarks of Intel Corporation in the U.S. and other countries; *Microsoft*, *Windows*, *Windows Vista*, and the *Windows Vista* start button logo are either trademarks or registered trademarks of Microsoft Corporation in the United States and/or other countries; *Bluetooth* is a registered trademark owned by Bluetooth SIG, Inc. and is used by Dell under license.

Other trademarks and trade names may be used in this document to refer to either the entities claiming the marks and names or their products. Dell Inc. disclaims any proprietary interest in trademarks and trade names other than its own.

**August 2009**

**P/N V0K33**

**Rev. A00**

# Contents

<b>Setting Up Your Inspiron Laptop</b> . . . . .	<b>5</b>	Display Features . . . . .	28
Before Setting Up Your Computer . . . . .	5	Removing and Replacing the Battery . . . . .	30
Connect the AC Adapter . . . . .	6	Software Features . . . . .	32
Connect the Network Cable (Optional) . . . . .	7	Dell Dock . . . . .	35
Press the Power Button . . . . .	8	<b>Solving Problems</b> . . . . .	<b>36</b>
Set Up Microsoft Windows . . . . .	9	Beep Codes . . . . .	36
Install the SIM (Optional) . . . . .	10	Network Problems . . . . .	37
Enable or Disable Wireless (Optional) . . . . .	12	Power Problems . . . . .	38
Connect to the Internet (Optional) . . . . .	14	Memory Problems . . . . .	40
<b>Using Your Inspiron Laptop</b> . . . . .	<b>18</b>	Lockups and Software Problems . . . . .	40
Right Side Features . . . . .	18	<b>Using Support Tools</b> . . . . .	<b>43</b>
Left Side Features . . . . .	20	Dell Support Center . . . . .	43
Computer Base Features . . . . .	22	System Messages . . . . .	44
Touch Pad Gestures . . . . .	24	Hardware Troubleshooter . . . . .	45
Media Controls . . . . .	26	Dell Diagnostics . . . . .	45

## Contents

<b>Restoring Your Operating System</b> .....	<b>49</b>	<b>Finding More Information and Resources</b> .....	<b>62</b>
System Restore .....	50	<b>Basic Specifications</b> .....	<b>64</b>
Dell Factory Image Restore .....	51	<b>Appendix</b> .....	<b>70</b>
Operating System Reinstallation .....	53	Macrovision Product Notice .....	70
<b>Getting Help</b> .....	<b>55</b>	Information for NOM, or Official Mexican Standard (only for Mexico) .....	71
Technical Support and Customer Service .....	56	<b>Index</b> .....	<b>72</b>
DellConnect .....	56		
Online Services .....	57		
Automated Order-Status Service .....	58		
Product Information .....	58		
Returning Items for Repair Under Warranty or for Credit .....	59		
Before You Call .....	60		
Contacting Dell .....	61		

# Setting Up Your Inspiron Laptop

This section provides information about setting up your Inspiron™ 11 laptop.

## Before Setting Up Your Computer

When positioning your computer, ensure that you allow easy access to a power source, adequate ventilation, and a level surface to place your computer.

Restricting airflow around your Inspiron laptop may cause it to overheat. To prevent overheating ensure that you leave at least 10.2 cm (4 inches) at the back of the computer and a minimum of 5.1 cm (2 inches) on all other sides. You should never place your computer in an enclosed space, such as a cabinet or drawer when it is powered on.

 **WARNING:** Do not block, push objects into, or allow dust to accumulate in the air vents. Do not store your Dell™ computer in a low-airflow environment, such as a closed briefcase, while it is powered on. Restricting the airflow can damage the computer or cause a fire. The computer turns on the fan when the computer gets hot. Fan noise is normal and does not indicate a problem with the fan or the computer.

 **CAUTION:** Placing or stacking heavy or sharp objects on the computer may result in permanent damage to the computer.

## Connect the AC Adapter

Connect the AC adapter to the computer and then plug it into an electrical outlet or surge protector.



**WARNING:** The AC adapter works with electrical outlets worldwide. However, power connectors and power strips vary among countries. Using an incompatible cable or improperly connecting the cable to a power strip or electrical outlet may cause fire or permanent damage to your computer.

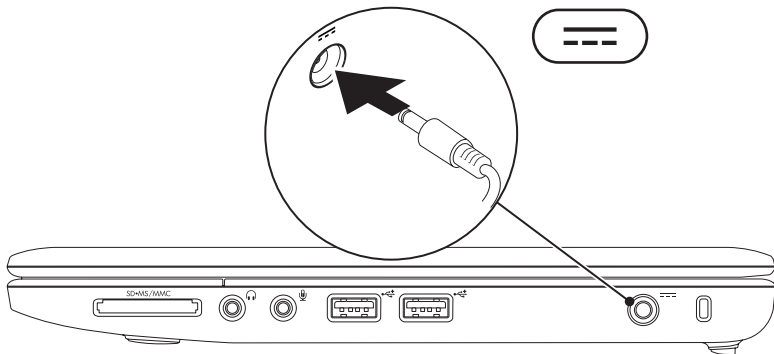



## Connect the Network Cable (Optional)

To use a wired network connection, connect the network cable.

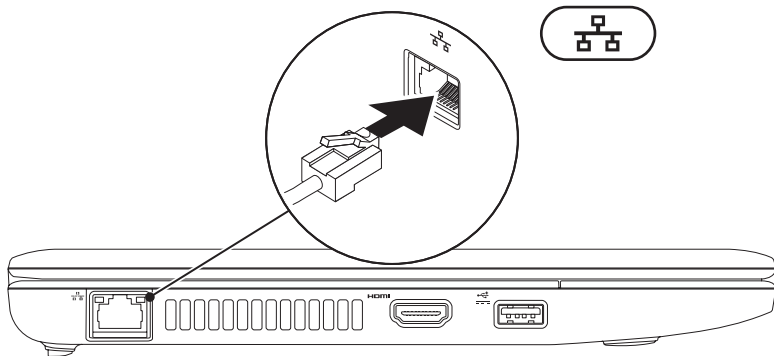

## Press the Power Button

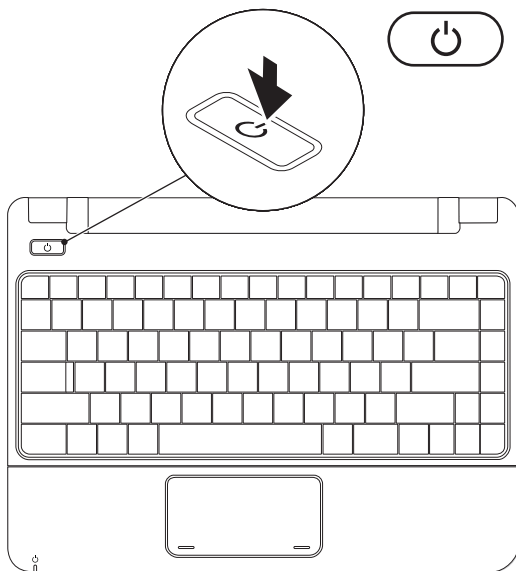

## Set Up Microsoft Windows

Your Dell computer is preconfigured with Microsoft Windows operating system. To set up Windows for the first time, follow the instructions on the screen. These steps are mandatory and may take some time to complete. The Windows setup screens will take you through several procedures including accepting license agreements, setting preferences, and setting up an Internet connection.

 **CAUTION:** Do not interrupt the operating system's setup process. Doing so may render your computer unusable and you will need to reinstall the operating system.

 **NOTE:** For optimal performance of your computer, it is recommended that you download and install the latest BIOS and drivers for your computer available on the Dell Support website at [support.dell.com](http://support.dell.com).

## Install the SIM (Optional)

Installing a Subscriber Identity Module (SIM) card allows you to browse the Internet, check e-mail, and connect to a Virtual Private Network. To access these features, you must be within the network of your cellular service provider.

 **NOTE:** Installing a SIM is not required if you are using an EVDO card to access the Internet.

- 1 battery bay
- 2 SIM card
- 3 SIM card slot

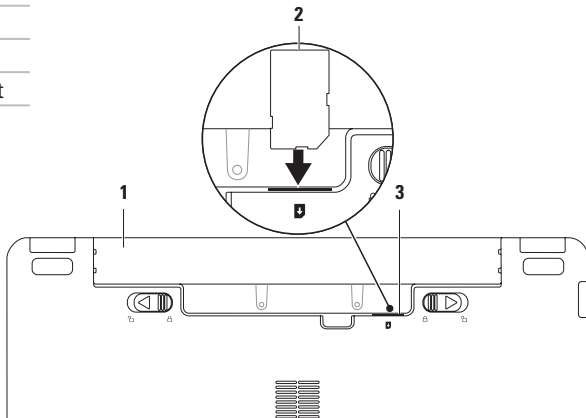

To install the SIM:

1. Turn off your computer.
2. Remove the battery (see “Removing and Replacing the Battery” on 30).
3. In the battery bay, slide the SIM into the SIM card slot.
4. Replace the battery (see “Removing and Replacing the Battery” on 30).
5. Turn on your computer.

To remove the SIM, press and eject the SIM.

## Enable or Disable Wireless (Optional)

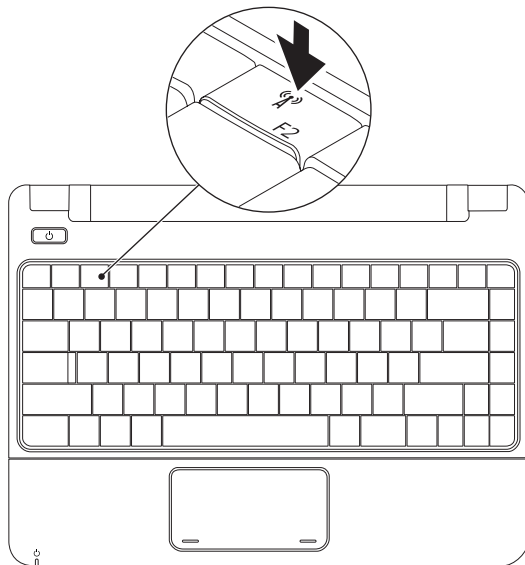

To enable wireless:

1. Ensure that your computer is turned on.
2. Press the wireless key  on the keyboard.  
The **Wireless Radio Control** dialog box appears.
3. Select the options you want to enable.
4. Click **OK**.

To disable wireless:

1. Press the wireless key  on the keyboard.  
The **Wireless Radio Control** dialog box appears.
2. Clear the options you want to disable.
3. Click **OK**.

 **NOTE:** The **Enable Flight Mode** button allows you to quickly turn all of your wireless radios (Bluetooth, Mobile Broadband, and GPS) off, such as when you are asked to disable all wireless radios on an airplane flight.

## Connect to the Internet (Optional)

To connect to the Internet, you need an external modem or network connection and an Internet service provider (ISP).

If an external USB modem or WLAN adapter is not a part of your original order, you can purchase one from the Dell website at [www.dell.com](http://www.dell.com).

## Setting Up a Wired Connection

- If you are using a dial-up connection, connect the telephone line to the optional external USB modem and to the telephone wall connector before you set up your Internet connection.
- If you are using a DSL or cable/satellite modem connection, contact your ISP or cellular telephone service for setup instructions.

To complete setting up your wired Internet connection, follow the instructions in “Setting Up Your Internet Connection” on page 16.



## Setting Up a Wireless Connection

Before you can use your wireless Internet connection, you need to connect to your wireless router.

To set up your connection to a wireless router:

*Windows Vista*<sup>®</sup>

1. Ensure that wireless is enabled on your computer (see “Enable or Disable Wireless” on page 12).
2. Save and close any open files, and exit any open programs.
3. Click **Start**  → **Connect To**.
4. Follow the instructions on the screen to complete the setup.

*Windows*<sup>®</sup> 7

1. Ensure that wireless is enabled on your computer (see “Enable or Disable Wireless” on page 12).
2. Save and close any open files, and exit any open programs.
3. Click **Start**  → **Control Panel** → **Network and Sharing Center** → **Connect to a network**.
4. Follow the instructions on the screen to complete the setup.

### Setting Up Your Internet Connection

ISPs and ISP offerings vary by country. Contact your ISP for offerings available in your country.

If you cannot connect to the Internet but have successfully connected in the past, the ISP might have a service outage. Contact your ISP to check the service status, or try connecting again later.

Have your ISP information ready. If you do not have an ISP, the **Connect to the Internet** wizard can help you get one.

### *Windows Vista®*

 **NOTE:** The following instructions are applicable for the Windows default view, and may not apply if you set your computer to the Windows Classic view.

1. Save and close any open files, and exit any open programs.
2. Click **Start**  → **Control Panel**.
3. Click **Network and Internet** → **Network and Sharing Center** → **Set up a connection or Network** → **Connect to the Internet**.

The **Connect to the Internet** window appears.

 **NOTE:** If you do not know which type of connection to select, click **Help me choose** or contact your ISP.

4. Follow the instructions on the screen and use the setup information provided by your ISP to complete the setup.

### Windows® 7

1. Save and close any open files, and exit any open programs.
2. Click **Start**  → **Control Panel** → **Network and Sharing Center** → **Set up a new connection or network** → **Connect to the Internet**.

The **Connect to the Internet** window appears.





-  **NOTE:** If you do not know which type of connection to select, click **Help me choose** or contact your ISP.
3. Follow the instructions on the screen and use the setup information provided by your ISP to complete the setup.

# Using Your Inspiron Laptop

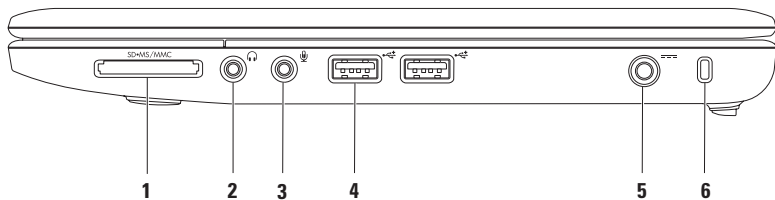
This section provides information about the features available on your Inspiron 11 laptop.

## Right Side Features



- 
- 1  **3-in-1 Media Card Reader** — Provides a fast and convenient way to view and share digital photos, music, videos, and documents stored on the following digital memory cards:
- Secure Digital (SD) memory card
  - Secure Digital High Capacity (SDHC) card
  - Multi Media Card (MMC/MMC+)
  - Memory Stick
  - Memory Stick PRO
- 
- 2  **Audio out/Headphone connector** — Connects to a pair of headphones, or sends audio to a powered speaker or sound system.
- 
- 3  **Audio in/Microphone connector** — Connects to a microphone or input signal for use with audio programs.
- 
- 4  **USB 2.0 connectors (2)** — Connects to USB devices, such as a mouse, keyboard, printer, external drive, or MP3 player.
- 
- 5  **AC adapter connector** — Connects to an AC adapter to power the computer and charge the battery.
- 
- 6 **Security cable slot** — Attaches a commercially available antitheft device to the computer.
- NOTE:** Before you buy an antitheft device, ensure that it works with the security cable slot on your computer.
-

## Left Side Features

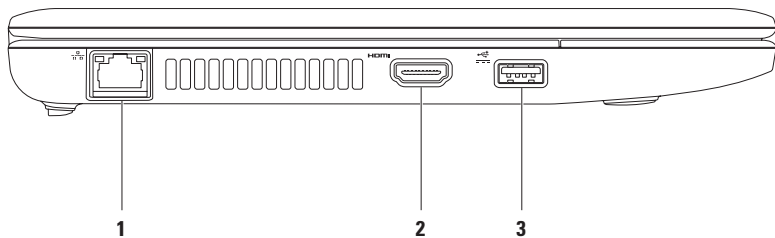

---

**1**  **Network connector** — Connects your computer to a network or a broadband device if you are using a wired network. The two lights next to the connector indicate status and activity for a wired network connection.

---

**2**  **HDMI connector** — Connects to a TV for both 5.1 audio and video signals.  
**NOTE:** When used with a monitor, only the video signal is read.

---

**3**  **Power USB connector** — Connects to USB devices that require more power, such as certain printers and bar code scanners. This connector supports a current load of up to 2 A.

---

## Computer Base Features

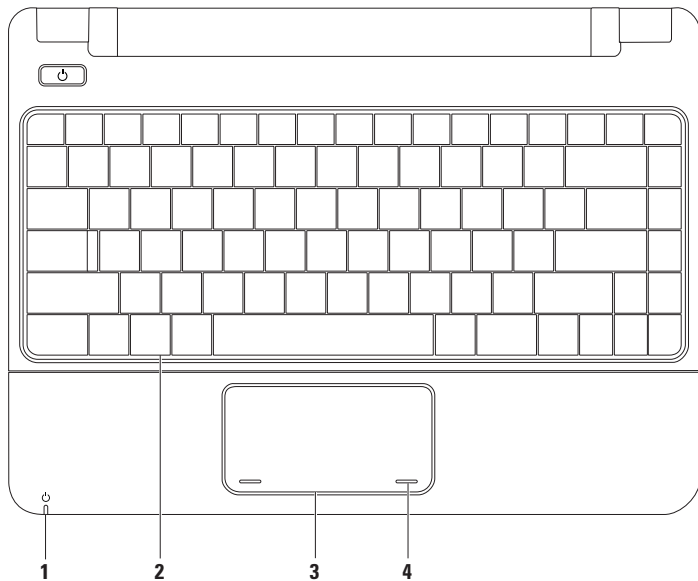



- 1**  **Power/Battery indicator light** — The light indicates the following states when powered using an AC adapter or a battery.

	Indicator light status	Computer state(s)	Battery charge level
<b>AC Adapter</b>	Solid white	on off/hibernate	charging <90%
	Breathing white	standby	charging
	off	off/hibernate	>90%
<b>Battery</b>	Solid white	on	>10%
	Breathing white	standby	>=10%
	Solid amber	on/standby	<10%
	off	off/hibernate	n/a

**NOTE:** The battery is charging when the computer is powered using an AC adapter.

- 2 Keyboard** — For more information on keyboard, see the *Dell Technology Guide* on your hard drive or on the Dell Support website at [support.dell.com/manuals](http://support.dell.com/manuals).
- 3 Touch pad** — Provides the functionality of a mouse to move the cursor, drag or move selected items, and left-click by tapping the surface. For more information, see “Touch Pad Gestures” on page 24.
- 4 Touch pad buttons (2)** — Provide left- and right-click functions like those on a mouse.

## Touch Pad Gestures

### Scroll

Allows you to scroll through content. The scroll feature includes:

**Traditional Scroll** – Allows you to scroll up and down, or right and left.

To scroll up and down:

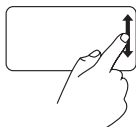

Move a finger up or down in the vertical scroll zone (extreme right of the touch pad) to scroll up or down on the active window.

To scroll right and left:

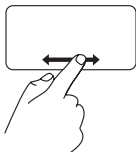

Move a finger right or left in the horizontal scroll zone (extreme bottom of the touch pad) to scroll right or left on the active window.

### Zoom

Allows you to increase or decrease the magnification of the screen content. The zoom feature includes:

**Pinch** – Allows you to zoom in or zoom out by moving two fingers apart or bringing them closer together on the touch pad.

To zoom in:

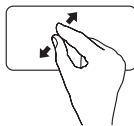

Move two fingers apart to enlarge the view of the active window.

To zoom out:

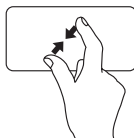

Move two fingers close together to reduce the view of the active window.

## Rotate

Allows you to rotate the active content on the screen. The rotate feature includes:

**Twist** – Allows you to rotate active content in 90° increments using two fingers where one finger is anchored and the other rotates.

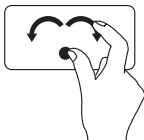

Keeping the thumb in place, move the index finger in an arced direction right or left to rotate the selected item 90° clockwise or counterclockwise.

## Desktop

Allows you to minimize all open windows so that the desktop is visible.

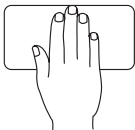

Place your hand on the touch pad in any orientation, briefly hold in place and then remove your hand.

## Customizing the Touch Pad Settings

You can customize the touch pad settings to enable or disable features, or to change the default behavior.

1. Click **Start**  → **Control Panel** → **Multi-finger**.
2. In the **Elan Smart-Pad** window that appears, select the desired feature you want to customize.

### Setting the Touch Pad Sensitivity

The palm tracking feature allows you to set the touch pad sensitivity, and is useful in preventing unwanted pointer movement while typing.

To set the touch pad sensitivity:

1. Click **Start**  → **Control Panel** → **Multi-finger**.
2. In the **Elan Smart-Pad** window, scroll down and select **PalmTracking**.
3. Drag the **PalmTracking Sensitivity** slider to increase or decrease the touch pad sensitivity.

# Media Controls

The media control keys are located on the keyboard.

To use the media controls, press the required key. You can use the **Function Key Behavior** setting in the **System Setup (BIOS) Utility** to configure the media control keys.

### System Setup (BIOS) Utility –

1. Press <F2> during POST (Power On Self Test) to enter the System Setup (BIOS) utility.
2. In the **Function Key Behavior**, select **Multimedia** or **Function**.

**Multimedia** – This is the default option. Press any multimedia key to perform the associated action. For function key, press <Fn> + the required function key.

**Function** – Press any function key to perform the associated action. For multimedia key, press <Fn> + the required multimedia key.

 **NOTE:** Multimedia option is active only in the operating system.



---

 Mute the sound

---

 Decrease the volume level

---

 Increase the volume level

---

 Play the previous track or chapter

---

 Play or pause

---

 Play the next track or chapter

---

 Eject the disc from the optional external optical drive

---

## Display Features

The display panel holds a camera and an accompanying microphone.

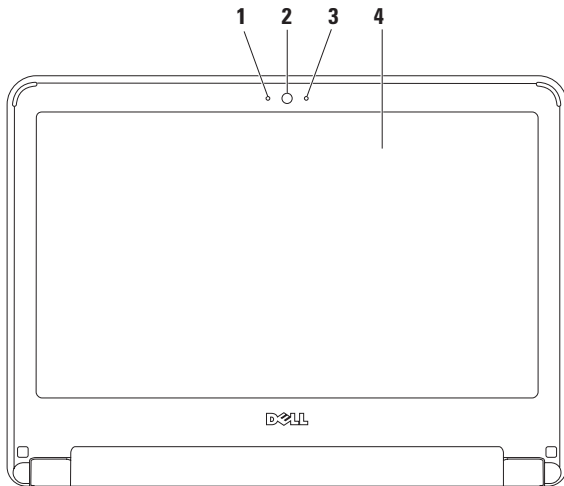

---

**1 Microphone** — Provides high quality sound for video conferencing and voice recording.

---

**2 Camera** — Built-in camera for video capture, conferencing, and chat.

---



**3 Camera activity indicator** — Indicates if the camera is on or off.

---

**4 Display** — For more information about displays, see the *Dell Technology Guide*.

---

## Removing and Replacing the Battery

-  **WARNING:** Before you begin any of the procedures in this section, follow the safety instructions that shipped with your computer.
-  **WARNING:** Using an incompatible battery may increase the risk of fire or explosion. This computer should only use a battery purchased from Dell. Do not use batteries from other computers.
-  **WARNING:** Before removing the battery, shut down the computer, and remove external cables (including the AC adapter).

To remove the battery:

1. Turn off the computer and turn it over.
2. Slide the two battery release latches to the unlock position until they click into place.
3. Pull the battery up and out of the battery bay.

To replace the battery:

1. Slide the battery into the battery bay until it clicks into place.
2. Slide the two battery release latches to the lock position.



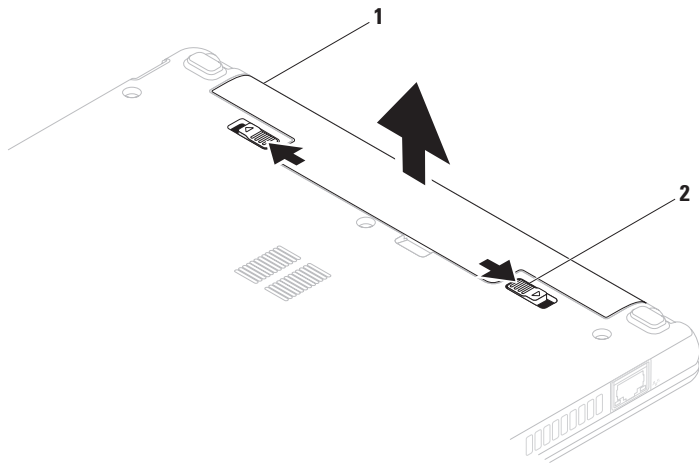

---

**1** battery

---

**2** battery release latches (2)

---

## Software Features

 **NOTE:** For more information about the features described in this section, see the *Dell Technology Guide* on your hard drive or on the Dell Support website at [support.dell.com/manuals](http://support.dell.com/manuals).

### Productivity and Communication

You can use your computer to create presentations, brochures, greeting cards, fliers, and spreadsheets. You can also edit and view digital photographs and images. Check your purchase order for software installed on your computer.

After connecting to the Internet, you can access websites, setup an e-mail account, and upload or download files.

### Entertainment and Multimedia

 **NOTE:** Your computer does not have an internal optical drive. Use an external optical drive or any external storage device for the procedures that involve discs.

You can use your computer to watch videos, play games, listen to music and Internet radio stations.

You can download or copy pictures and video files from portable devices, such as digital cameras and cell phones. Optional software applications enable you to organize and create music and video files that can be saved on portable products such as MP3 players and handheld entertainment devices, or played and viewed directly on connected TVs, projectors, and home theater equipment.

## Customizing the Desktop

You can customize your desktop to change the appearance, resolution, wallpaper, screensaver, or other features of your desktop.

*Windows Vista®*

1. Right-click an open area of the desktop.
2. Click **Personalize**, to open the **Personalize appearance and sounds** window and learn more about your customization options.

*Windows® 7*

1. Right-click an open area of the desktop.
2. Click **Personalize**, to open the **Change the visuals and sounds on your computer** window and learn more about your customization options.

## Customizing Your Energy Settings

You can use the power options in your operating system to configure the power settings on your computer. The Microsoft Windows operating system installed on your Dell computer provides three default options:

- **Balanced/Dell Recommended** — Offers full performance when you need it and saves power during periods of inactivity.
- **Power saver** — Saves power on your computer by reducing system performance to maximize the life of the computer and by reducing the amount of energy consumed by your computer over its lifetime.
- **High performance** — Provides the highest level of system performance on your computer by adapting processor speed to your activity and by maximizing system performance.

### Transferring Information to a New Computer

#### *Windows Vista*

 **NOTE:** The following instructions are applicable for the Windows default view, and may not apply if you set your computer to the Windows Classic view.

1. Click **Start**  → **Control Panel** → **System and Maintenance** → **Welcome Center** → **Transfer files and settings**.

If the **User Account Control** window appears, click **Continue**.

2. Follow the instructions in the **Windows Easy Transfer** wizard.

#### *Windows 7*

1. Click **Start**  → **Control Panel**.
2. In the search box, type `Transfer` and then click **Transfer files from another computer**.
3. Follow the instructions in the **Windows Easy Transfer** wizard.

### Backing Up Your Data

It is recommended that you periodically back up files and folders on your computer. To back up files:

#### *Windows Vista*

1. Click **Start**  → **Control Panel** → **System and Maintenance** → **Backup and Restore Center** → **Backup files**.

If the **User Account Control** window appears, click **Continue**.

 **NOTE:** Certain editions of Windows Vista provide an option to back up your computer.

2. Follow the instructions in the **Back up Files** wizard.

#### *Windows 7*

1. Click **Start**  → **Control Panel** → **System and Security** → **Backup and Restore**.
2. Click **Set up backup....**
3. Follow the instructions on the **Configure Backup** wizard.

## Dell Dock

The Dell Dock is a group of icons that provides easy access to frequently-used applications, files, and folders. You can personalize the Dock by:

- Adding or removing icons
- Changing the color and location of the Dock
- Grouping related icons into categories
- Changing the behavior of the icons



### Add a Category

1. Right-click the Dock, click **Add**→ **Category**.  
The **Add/Edit Category** window is displayed.
2. Enter a title for the category in the **Title** field.
3. Select an icon for the category from the **Select an image:** box.
4. Click **Save**.

### Add an Icon

Drag and drop the icon to the Dock or a category.

### Remove a Category or Icon

1. Right-click the category or icon on the Dock and click **Delete shortcut** or **Delete category**.
2. Follow the instructions on the screen.

### Personalize the Dock

1. Right-click the Dock and click **Advanced Setting...**
2. Choose the desired option to personalize the Dock.

# Solving Problems

This section provides troubleshooting information for your computer. If you cannot solve your problem using the following guidelines, see “Using Support Tools” on page 43 or “Contacting Dell” on page 61.

 **WARNING:** Only trained service personnel should remove the computer cover. See the *Service Manual on the Dell Support website at [support.dell.com/manuals](http://support.dell.com/manuals) for advanced service instructions.*

## Beep Codes

Your computer might emit a series of beeps during start-up if there are errors or problems. This series of beeps, called a beep code, identifies a problem. Write down the beep code and contact Dell (see “Contacting Dell” on page 61).

 **NOTE:** To replace parts, see the *Service Manual* on the Dell Support website at [support.dell.com/manuals](http://support.dell.com/manuals).

Beep Code	Possible Problem
Two	No RAM detected
Three	Possible motherboard failure - Chipset error
Four	RAM read/write failure
Five	Real Time Clock failure
Six	Video card or chip failure
Seven	Processor failure
Eight	Display failure

## Network Problems

### Wireless Connections

**If the wireless network connection is lost** —

The wireless router is offline or wireless has been disabled on the computer.

- Check your wireless router to ensure it is powered on and connected to your data source (cable modem or network hub).
- Interference may be blocking or interrupting your wireless connection. Try moving the computer closer to your wireless router.
- Re-establish your connection to the wireless router (see “Setting Up a Wireless Connection” on page 15).

### Wired Connections

**If the network connection is lost** — The cable is loose or damaged.

- Check the cable to ensure it is plugged in and not damaged.

- Check the status of the link integrity light. The link integrity light on the integrated network connector lets you verify that your connection is working and provides information on the status:

- Green — A good connection exists between a 10-Mbps network and the computer.
- Orange — A good connection exists between a 100-Mbps network and the computer.
- Off — The computer is not detecting a physical connection to the network. For assistance, contact your network administrator or ISP.



**NOTE:** The link integrity light on the network connector is only for the wired cable connection. The link integrity light does not provide status for wireless connections.

### Power Problems

**If the power light is off** — The computer is either turned off, is not receiving power, or in hibernate state.

- Press the power button. The computer resumes normal operation if it is off or in hibernate mode.
- Reseat the power cable into both the power connector on the computer and the electrical outlet.
- If the AC adapter is plugged into a power strip, ensure that the power strip is plugged into an electrical outlet and that the power strip is turned on. Also temporarily bypass power protection devices, power strips, and power extension cables to verify that the computer turns on properly.

- Ensure that the electrical outlet is working by testing it with another device, such as a lamp.
- Check the AC adapter cable connections. If the AC adapter has a light, ensure that the light on the AC adapter is on.

**If the power light is solid white and the computer is not responding** — The computer is either turned off, in hibernate state or the display may not be responding.

- Press the power button. The computer resumes normal operation if it is off or in hibernate mode.
- If the display is not responding, press the power button until the computer turns off and then turn it back on. If the problem persists, contact Dell (see “Contacting Dell” on page 61.)



**If the power light is breathing white and the computer is not responding** — The computer is in standby mode or the display may not be responding.

- Press a key on the keyboard, move the connected mouse or a finger on the touch pad, or press the power button to resume normal operation.
- If the display is not responding, press the power button until the computer turns off and then turn it back on. If the problem persists, contact Dell (see “Contacting Dell” on page 61).

**If the power light is solid amber and the computer is not responding** — The computer is on in standby mode with low battery or the display may not be responding.

- Connect the AC adapter to power the computer and charge the battery.

- Move the connected mouse or a finger on the touch pad to resume normal operation.
- If the display is not responding, press the power button until the computer turns off and then turn it back on. If the problem persists, contact Dell (see “Contacting Dell” on page 61).

**If you encounter interference that hinders reception on your computer** — An unwanted signal is creating interference by interrupting or blocking other signals. Some possible causes of interference are:

- Power, keyboard, and mouse extension cables.
- Too many devices connected to a power strip.
- Multiple power strips connected to the same electrical outlet.

# Memory Problems

**If you receive an insufficient memory message** —

- Save and close any open files and exit any open programs you are not using to see if that resolves the problem.
- See the software documentation for minimum memory requirements.
- If the problem persists, contact Dell (see “Contacting Dell” on page 61).

**If you experience other memory problems** —

- Run the Dell Diagnostics (see “Dell Diagnostics” on page 45).
- If the problem persists, contact Dell (see “Contacting Dell” on page 61).

# Lockups and Software Problems

**If the computer does not start up** — Ensure that the power cable is firmly connected to the computer and to the electrical outlet.

**If a program stops responding** —

End the program:

1. Press <Ctrl><Shift><Esc> simultaneously.
2. Click **Applications**.
3. Select the program that is no longer responding.
4. Click **End Task**.

**If a program crashes repeatedly** — Check the software documentation. If necessary, uninstall and then reinstall the program.

 **NOTE:** Software usually includes installation instructions in its documentation or on the CD.

**If the computer stops responding or a solid blue screen appears** —

 **WARNING:** You might lose data if you are unable to perform an operating system shutdown.

If you are unable to get a response by pressing a key on your keyboard or moving your mouse, press the power button for at least 8 to 10 seconds until the computer turns off and then restart your computer.

**If a program is designed for an earlier Microsoft® Windows® operating system** —

Run the **Program Compatibility Wizard**. The **Program Compatibility Wizard** configures a program so that it runs in an environment similar to an earlier version of Microsoft Windows operating system environments.

*Windows Vista®*

1. Click **Start**  → **Control Panel** → **Programs** → **Use an older program with this version of Windows**.
2. In the welcome screen, click **Next**.
3. Follow the instructions on the screen.

## Solving Problems

### Windows® 7

1. Click **Start** 
2. In the search box, type `Use an older program with this version of Windows` and press <Enter>
3. Follow the instructions on the **Program Compatibility** wizard.

#### If you have other software problems —

- Back up your files immediately.
  - Use a virus-scanning program to check the hard drive or CDs.
  - Save and close any open files or programs and shut down your computer through the **Start**  menu.
- Check the software documentation or contact the software manufacturer for troubleshooting information:
    - Ensure that the program is compatible with the operating system installed on your computer.
    - Ensure that your computer meets the minimum hardware requirements needed to run the software. See the software documentation for information.
    - Ensure that the program is installed and configured properly.
    - Verify that the device drivers do not conflict with the program.
    - If necessary, uninstall and then reinstall the program.

# Using Support Tools

## Dell Support Center

The **Dell Support Center** helps you find the service, support, and system-specific information you need.

To launch the application, click the  icon in the taskbar.

The **Dell Support Center** home page displays your computer's model number, service tag, express service code, and service contact information.

The home page also provides links to access:

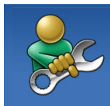

**Self Help** (Troubleshooting, Security, System Performance, Network/Internet, Backup/Recovery, and Windows operating system)



**Alerts** (technical support alerts relevant to your computer)



**Assistance from Dell** (Technical Support with DellConnect™, Customer Service, Training and Tutorials, How-To Help with Dell on Call™, and Online Scan with PC CheckUp)



**About Your System** (System Documentation, Warranty Information, System Information, Upgrades & Accessories)

For more information about **Dell Support Center** and available support tools, click the **Services** tab at [support.dell.com](http://support.dell.com).

# System Messages

If your computer has an issue or an error, it may display a System Message that will help you identify the cause and action needed to resolve the issue.

 **NOTE:** If the message you received is not listed in the following examples, see the documentation for either the operating system or the program that was running when the message appeared. Alternatively you could see the *Dell Technology Guide* on your hard drive or on the Dell Support website at [support.dell.com/manuals](http://support.dell.com/manuals) or contact Dell (see “Contacting Dell” on page 61 for assistance).

**No boot device available** — No bootable partition on hard disk drive, the hard disk drive cable is loose, or no bootable device exists.

- If the hard drive is your boot device, ensure that the cables are connected and that the drive is installed properly and partitioned as a boot device.
- Enter system setup and ensure that the boot sequence information is correct (see the *Dell Technology Guide* on your hard drive or on the Dell Support website at [support.dell.com/manuals](http://support.dell.com/manuals)).

**No timer tick interrupt** — A chip on the system board might be malfunctioning or motherboard failure (see “Contacting Dell” on page 61 for assistance).

## Hardware Troubleshooter

If a device is either not detected during the operating system setup or is detected but incorrectly configured, you can use the **Hardware Troubleshooter** to resolve the incompatibility.

To start the Hardware Troubleshooter:

1. Click **Start**  → **Help and Support**.
2. Type `hardware troubleshooter` in the search field and press <Enter> to start the search.
3. In the search results, select the option that best describes the problem and follow the remaining troubleshooting steps.

## Dell Diagnostics

If you experience a problem with your computer, perform the checks in “Lockups and Software Problems” on page 40 and run the Dell Diagnostics before you contact Dell for technical assistance.

 **NOTE:** Dell Diagnostics works only on Dell computers.

 **NOTE:** The *Drivers and Utilities* disc is optional and may not ship with your computer.

See the *Dell Technology Guide* on your hard drive or on the Dell Support website at **support.dell.com/manuals**, to review your computer’s configuration information, and ensure that the device that you want to test displays in the system setup program and is active.

Start the Dell Diagnostics from your hard drive or from the *Drivers and Utilities* disc.

### Starting Dell Diagnostics From Your Hard Drive

The Dell Diagnostics is located on a hidden diagnostic utility partition on your hard drive.

 **NOTE:** If your computer cannot display a screen image, contact Dell (see “Contacting Dell” on page 61).

1. Ensure that the computer is connected to an electrical outlet that is known to be working properly.
2. Turn on (or restart) your computer.
3. When the DELL™ logo appears, press <F12> immediately. Select **Diagnostics** from the boot menu and press <Enter>. This will invoke the Pre-Boot System Assessment (PSA) in some computers.

 **NOTE:** If you wait too long and the operating system logo appears, continue to wait until you see the Microsoft® Windows® desktop; then, shut down your computer and try again.

 **NOTE:** If you see a message stating that no diagnostics utility partition has been found, run the Dell Diagnostics from the *Drivers and Utilities* disc.

*If PSA is invoked:*

- a. The PSA will start running the tests.
- b. If the PSA completes successfully, the following message is displayed: `"No problems have been found with this system so far. Do you want to run the remaining memory tests? This will take about 30 minutes or more. Do you want to continue? (Recommended)."`



- c. If you are experiencing memory issues, press <y> otherwise press <n>.

The following message is displayed:

“Booting Dell Diagnostic Utility Partition. Press any key to continue.”

- d. Press any key to continue. The **Choose An Option** window appears.

*If PSA is not invoked:*

Press any key to start the Dell Diagnostics from the diagnostics utility partition on your hard drive and to go to the **Choose An Option** window.

4. Select the test you want to run.
5. If you encounter a problem during a test, a message with the error code and a description of the problem will appear on your screen. Write down the error code and problem description and contact Dell (see “Contacting Dell” on page 61).

 **NOTE:** The Service Tag for your computer is located at the top of each test screen. The Service Tag helps you identify your computer when you contact Dell.

6. When the tests complete, close the test screen to return to the **Choose An Option** window.
7. To exit the Dell Diagnostics and to restart the computer, click **Exit**.

## Starting Dell Diagnostics From the Drivers and Utilities Disc

 **NOTE:** Your computer does not have an internal optical drive. Use an external optical drive or any external storage device for the procedures that involve discs.

1. Insert the *Drivers and Utilities* disc.
2. Shut down and restart the computer. When the DELL logo appears, press <F12> immediately.

## Using Support Tools

 **NOTE:** If you wait too long and the operating system logo appears, continue to wait until you see the Microsoft® Windows® desktop; then, shut down your computer and try again.

 **NOTE:** The next steps change the boot sequence for one time only. On the next start-up, the computer boots according to the devices specified in the system setup program.

3. When the boot device list appears, highlight **CD/DVD/CD-RW** and press <Enter>.
4. Select the **Boot from CD-ROM** option from the menu that appears and press <Enter>.
5. Type 1 to start the CD menu and press <Enter> to proceed.
6. Select **Run the 32 Bit Dell Diagnostics** from the numbered list. If multiple versions are listed, select the version appropriate for your computer.

7. Select the test you want to run.

8. If you encounter a problem during a test, a message with the error code and a description of the problem will appear on your screen. Write down the error code and problem description and see “Contacting Dell” on page 61.

 **NOTE:** The Service Tag for your computer is located at the top of each test screen. The Service Tag helps you identify your computer when you contact Dell.

9. When the tests complete, close the test screen to return to the **Choose An Option** window.
10. To exit the Dell Diagnostics and to restart the computer, click **Exit**.
11. Remove the *Drivers and Utilities* disc.

# Restoring Your Operating System

 **NOTE:** Your computer does not have an internal optical drive. Use an external optical drive or any external storage device for the procedures that involve discs.

You can restore your operating system in the following ways:

- System Restore returns your computer to an earlier operating state without affecting data files. Use System Restore as the first solution for restoring your operating system and preserving data files.
- Dell Factory Image Restore returns your hard drive to the operating state it was in when you purchased the computer. This procedure permanently deletes all data on the hard drive and removes any programs installed after you received the computer. Use Dell Factory Image Restore only if System Restore did not resolve your operating system problem.
- If you received an Operating System disc with your computer, you can use it to restore your operating system. However, using the Operating System disc also deletes all data on the hard drive. Use the Operating System disc only if System Restore did not resolve your operating system problem.

# System Restore

The Windows operating systems provide a System Restore option which allows you to return your computer to an earlier operating state (without affecting data files) if changes to the hardware, software, or other system settings have left the computer in an undesirable operating state. Any changes that System Restore makes to your computer are completely reversible.

 **CAUTION: Make regular backups of your data files. System Restore does not monitor your data files or recover them.**

 **NOTE:** The procedures in this document were written for the Windows default view, so they may not apply if you set your Dell™ computer to the Windows Classic view.

## Starting System Restore

1. Click **Start** .
2. In the **Start Search** box, type `System Restore` and press <Enter>.

 **NOTE:** The **User Account Control** window may appear. If you are an administrator on the computer, click **Continue**; otherwise, contact your administrator to continue the desired action.

3. Click **Next** and follow the instructions on the screen.

In the event that System Restore did not resolve the issue, you may undo the last system restore.

## Undoing the Last System Restore

 **NOTE:** Before you undo the last system restore, save and close all open files and exit any open programs. Do not alter, open, or delete any files or programs until the system restoration is complete.

1. Click **Start** .
2. In the **Start Search** box, type `System Restore` and press <Enter>.
3. Click **Undo my last restoration** and click **Next**.

## Dell Factory Image Restore

 **CAUTION:** Using Dell Factory Image Restore permanently deletes all data on the hard drive and removes any programs or drivers installed after you received your computer. If possible, back up the data before using this option. Use Dell Factory Image Restore only if System Restore did not resolve your operating system problem.

 **NOTE:** Dell Factory Image Restore may not be available in certain countries or on certain computers.

## Restoring Your Operating System

Use Dell Factory Image Restore only as the last method to restore your operating system. This option restores your hard drive to the operating state it was in when you purchased the computer. Any programs or files added since you received your computer—including data files—are permanently deleted from the hard drive. Data files include documents, spreadsheets, e-mail messages, digital photos, music files, and so on. If possible, back up all data before using Dell Factory Image Restore.

1. Turn on the computer. When the Dell logo appears, press <F8> several times to access the **Advanced Boot Options** window.

 **NOTE:** If you wait too long and the operating system logo appears, continue to wait until you see the Microsoft® Windows® desktop; then, shut down your computer and try again.

2. Select **Repair Your Computer**.
  3. The **System Recovery Options** window appears.
  4. Select a keyboard layout and click **Next**.
  5. To access the recovery options, log on as a local user. To access the command prompt, type `administrator` in the **User name** field, then click **OK**.
  6. Click **Dell Factory Image Restore**. The **Dell Factory Image Restore** welcome screen appears.
-  **NOTE:** Depending upon your configuration, you may need to select **Dell Factory Tools**, then **Dell Factory Image Restore**.

7. Click **Next**. The **Confirm Data Deletion** screen appears.

 **NOTE:** If you do not want to proceed with Factory Image Restore, click **Cancel**.

8. Select the checkbox to confirm that you want to continue reformatting the hard drive and restoring the system software to the factory condition, then click **Next**.

The restore process begins and may take five or more minutes to complete. A message appears when the operating system and factory-installed applications have been restored to factory condition.

9. Click **Finish** to restart the computer.

## Operating System Reinstallation

### Before You Begin

If you are considering reinstalling the Windows operating system to correct a problem with a newly installed driver, first try using Windows Device Driver Rollback. If Device Driver Rollback does not resolve the problem, then use System Restore to return your operating system to the operating state it was in before you installed the new device driver.

 **CAUTION:** Before performing the installation, back up all data files on your primary hard drive. For conventional hard drive configurations, the primary hard drive is the first drive detected by the computer.

## Restoring Your Operating System

To reinstall Windows, you need the following:

- Dell *Operating System* disc
- Dell *Drivers and Utilities* disc

 **NOTE:** The *Drivers and Utilities* disc contains drivers that were installed during the assembly of the computer. Use the Dell *Drivers and Utilities* disc to load any required drivers. Depending on the region from which you ordered your computer, or whether you requested the disc, the Dell *Drivers and Utilities* disc and *Operating System* disc may not ship with your computer.

### Reinstalling Microsoft Windows

The reinstallation process can take 1 to 2 hours to complete. After you reinstall the operating system, you must also reinstall the device drivers, virus protection program, and other software.

1. Save and close any open files and exit any open programs.

2. Insert the *Operating System* disc.
3. Click **Exit** if the **Install Windows** message appears.
4. Restart the computer.
5. When the DELL logo appears, press <F12> immediately.

 **NOTE:** If you wait too long and the operating system logo appears, continue to wait until you see the Microsoft® Windows® desktop; then, shut down your computer and try again.

 **NOTE:** The next steps change the boot sequence for one time only. On the next start-up, the computer boots according to the devices specified in the system setup program.

6. When the boot device list appears, highlight **CD/DVD/CD-RW Drive** and press <Enter>.
7. Press any key to **Boot from CD-ROM**. Follow the instructions on the screen to complete the installation.





# Getting Help

If you experience a problem with your computer, you can complete the following steps to diagnose and troubleshoot the problem:

1. See “Solving Problems” on page 36 for information and procedures that pertain to the problem your computer is experiencing.
2. See the *Dell Technology Guide* on your hard drive or on the Dell Support website at [support.dell.com/manuals](http://support.dell.com/manuals) for more troubleshooting information.
3. See “Dell Diagnostics” on page 45 for procedures on how to run Dell Diagnostics.
4. Fill out the “Diagnostic Checklist” on page 60.
5. Use Dell’s extensive suite of online services available at Dell Support ([support.dell.com](http://support.dell.com)) for help with installation and troubleshooting procedures. See “Online Services” on page 57 for a more extensive list of Dell Support online.

6. If the preceding steps have not resolved the problem, see “Before You Call” on page 60.

 **NOTE:** Call Dell Support from a telephone near or at the computer so that the support staff can assist you with any necessary procedures.

 **NOTE:** Dell’s Express Service Code system may not be available in all countries.

When prompted by Dell’s automated telephone system, enter your Express Service Code to route the call directly to the proper support personnel. If you do not have an Express Service Code, open the **Dell Accessories** folder, double-click the **Express Service Code** icon, and follow the directions.

 **NOTE:** Some of the services are not always available in all locations outside the continental U.S. Call your local Dell representative for information on availability.

## Technical Support and Customer Service

Dell's support service is available to answer your questions about Dell hardware. Our support staff use computer-based diagnostics to provide fast, accurate answers.

To contact Dell's support service, see "Before You Call" on page 60 and then see the contact information for your region or go to **[support.dell.com](http://support.dell.com)**.

## DellConnect

DellConnect™ is a simple online access tool that allows a Dell service and support associate to access your computer through a broadband connection, diagnose your problem and repair it all under your supervision. For more information, go to **[www.dell.com/DellConnect](http://www.dell.com/DellConnect)**.

## Online Services

You can learn about Dell products and services on the following websites:

- **www.dell.com**
- **www.dell.com/ap** (Asian/Pacific countries only)
- **www.dell.com/jp** (Japan only)
- **www.euro.dell.com** (Europe only)
- **www.dell.com/la** (Latin American and Caribbean countries)
- **www.dell.ca** (Canada only)

You can access Dell Support through the following websites and e-mail addresses:

### Dell Support websites

- **support.dell.com**
- **support.jp.dell.com** (Japan only)
- **support.euro.dell.com** (Europe only)

### Dell Support e-mail addresses

- **mobile\_support@us.dell.com**
- **support@us.dell.com**
- **la-techsupport@dell.com** (Latin America and Caribbean countries only)
- **apsupport@dell.com** (Asian/Pacific countries only)

### Dell Marketing and Sales e-mail addresses

- **apmarketing@dell.com** (Asian/Pacific countries only)
- **sales\_canada@dell.com** (Canada only)

### Anonymous file transfer protocol (FTP)

- **ftp.dell.com**

Log in as user: `anonymous`, and use your e-mail address as your password.

## Automated Order-Status Service

To check on the status of any Dell products that you have ordered, you can go to **support.dell.com**, or you can call the automated order-status service. A recording prompts you for the information needed to locate and report on your order. For the telephone number to call your region, see “Contacting Dell” on page 61.





If you have a problem with your order, such as missing parts, wrong parts, or incorrect billing, contact Dell for customer assistance. Have your invoice or packing slip handy when you call. For the telephone number to call your region, see “Contacting Dell” on page 61.

## Product Information

If you need information about additional products available from Dell, or if you would like to place an order, visit the Dell website at **www.dell.com**. For the telephone number to call your region or to speak to a sales specialist, see “Contacting Dell” on page 61.

## Returning Items for Repair Under Warranty or for Credit

Prepare all items being returned, whether for repair or credit, as follows:

-  **NOTE:** Before you return the product to Dell, make sure to back up any data on the hard drive(s) and on any other storage device in the product. Remove any and all confidential, proprietary and personal information, as well as removable media, such as CDs and PC Cards. Dell is not responsible for any of your confidential, proprietary or personal information; lost or corrupted data; or damaged or lost removable media that may be included with your return.
- 1. Call Dell to obtain a Return Material Authorization Number, and write it clearly and prominently on the outside of the box.
  -  **NOTE:** For the telephone number to call your region, see “Contacting Dell” on page 61.
- 2. Include a copy of the invoice and a letter describing the reason for the return.
- 3. Include a copy of the Diagnostics Checklist (see “Diagnostic Checklist” on page 60), indicating the tests that you have run and any error messages reported by the Dell Diagnostics (see “Dell Diagnostics” on page 45).
- 4. Include any accessories that belong with the item(s) being returned (power cables, software, guides, and so on) if the return is for credit.
- 5. Pack the equipment to be returned in the original (or equivalent) packing materials.
  -  **NOTE:** You are responsible for paying shipping expenses. You are also responsible for insuring any product returned, and you assume the risk of loss during shipment to Dell. Collect On Delivery (C.O.D.) packages are not accepted.
  -  **NOTE:** Returns that are missing any of the preceding requirements will be refused at Dell’s receiving dock and returned to you.

# Before You Call

 **NOTE:** Have your Express Service Code ready when you call. The code helps Dell's automated-support telephone system direct your call more efficiently. You may also be asked for your Service Tag (located on the back or bottom of your computer).

Remember to fill out the following Diagnostic Checklist. If possible, turn on your computer before you call Dell for assistance and call from a telephone at or near the computer. You may be asked to type some commands at the keyboard, relay detailed information during operations, or try other troubleshooting steps possible only at the computer itself. Ensure that the computer documentation is available.

## Diagnostic Checklist

- Name:
- Date:
- Address:
- Phone number:
- Service Tag (bar code on the back or bottom of the computer):
- Express Service Code:
- Return Material Authorization Number (if provided by Dell support technician):
- Operating system and version:
- Devices:
- Expansion cards:
- Are you connected to a network? Yes/No
- Network, version, and network adapter:
- Programs and versions:

See your operating system documentation to determine the contents of the computer's start-up files. If the computer is connected to a printer, print each file. Otherwise, record the contents of each file before calling Dell.

- Error message, beep code, or diagnostic code:
- Description of problem and troubleshooting procedures you performed:

## Contacting Dell

For customers in the United States, call 800-WWW-DELL (800-999-3355).

 **NOTE:** If you do not have an active Internet connection, you can find contact information on your purchase invoice, packing slip, bill, or Dell product catalog.

Dell provides several online and telephone-based support and service options. Availability varies by country and product, and some services may not be available in your area.

To contact Dell for sales, technical support, or customer service issues:

1. Visit **support.dell.com**.
2. Verify your country or region in the **Choose A Country/Region** drop-down menu at the bottom of the page.
3. Click **Contact Us** on the left side of the page.
4. Select the appropriate service or support link based on your need.
5. Choose the method of contacting Dell that is convenient for you.

# Finding More Information and Resources

## If you need to:

---

reinstall your operating system

---

run a diagnostic program for your computer, reinstall notebook system software, or update drivers for your computer, and readme files

---

learn more about your operating system, maintaining peripherals, Internet, Bluetooth<sup>®</sup>, networking, and e-mail

---

upgrade your computer with new or additional components, like a new hard drive

reinstall or replace a worn or defective part

---

## See:

---

the Operating System disc

---

the *Drivers and Utilities* disc



**NOTE:** Drivers and documentation updates can be found on the Dell™ Support website at [support.dell.com/manuals](http://support.dell.com/manuals).

---

the *Dell Technology Guide* installed on your hard drive or on the Dell Support website at [support.dell.com/manuals](http://support.dell.com/manuals)

---

the *Service Manual* on the Dell Support website at [support.dell.com/manuals](http://support.dell.com/manuals)



**NOTE:** In some countries, opening and replacing parts of your computer may void your warranty. Check your warranty and return policies before working inside your computer.

---



### If you need to:

---

find safety best practices information for your computer review Warranty information, Terms and Conditions (U.S. only), Safety instructions, Regulatory information, Ergonomics information, and End User License Agreement

---

find your Service tag/Express Service Code— You must use the service tag to identify your computer on **support.dell.com** or to contact technical support

---

find drivers and downloads  
access technical support and product help  
check on your order status for new purchases  
find solutions and answers to common questions  
locate information for last-minute updates about technical changes to your computer or advanced technical-reference material for technicians or experienced users

---

### See:

---

the safety and regulatory documents that shipped with your computer and also see the Regulatory Compliance Homepage at **www.dell.com/regulatory\_compliance**

---

the back or bottom of your computer

---

the Dell Support website at **support.dell.com**

# Basic Specifications

## System Model

---

Inspiron 11

This section provides information that you may need when setting up, updating drivers for, and upgrading your computer. For more detailed specifications, see the *Comprehensive Specifications* on the Dell Support website at [support.dell.com/manuals](http://support.dell.com/manuals).

 **NOTE:** Offerings may vary by region. For more information regarding the configuration of your computer, click **Start** → **Help and Support** and select the option to view information about your computer.

## Processor

---

Types	Intel® Celeron® Intel Pentium®
L2 cache	1 MB or 2 MB
External bus frequency	800 MHz

## Computer Information

---

System chipset	Intel GS45
----------------	------------

## Memory

---

Memory type	800 MHz DDR2
Memory configurations possible	1 GB, 2 GB, or 4 GB

## Communications

---

Network adapter	10/100 Ethernet LAN on system board
Wireless	internal WLAN Mini-Card with WiFi Optional WWAN, WiMax, GPS, and Bluetooth® Mini-Cards

## Camera

---

Pixel	1.3 megapixel
Video resolution	640 x 480 at 30 fps (maximum)

## Connectors

---

Audio	one microphone connector, one mono headphone/stereo speaker connector
Mini-Card	one full size Mini-Card slot and one half size Mini-Card slot, supports dual interface
Network adapter	one RJ45 connector
USB	two 4-pin USB 2.0-compliant connectors one 4-pin power USB 2.0-compliant connector
Video	one HDMI connector

## Basic Specifications

### Display

---

Type 11.6-inch HD+ WLED with TrueLife

*Dimensions:*

Height 144 mm (5.7 inches)

Width 256.12 mm (10.1 inches)

Diagonal 293.83 mm (11.6 inches)

Maximum resolution 1366 x 768 at 262 K colors

### Battery

---

Type 3-cell/6-cell lithium ion

*Charge time at room temperature (approximate):*

Computer off 3.0 hours (3-cell)  
4.0 hours (6-cell)

Operating time Battery operating time varies depending on operating conditions and can be significantly reduced under certain power-intensive conditions.

For more information, see the *Dell Technology Guide* on your hard drive or on the Dell Support website at [support.dell.com/manuals](http://support.dell.com/manuals).

Coin-cell battery CR-2032

**AC Adapter**

---

Input voltage	100–240 VAC
Input current (maximum)	1.5 A
Input frequency	50–60 Hz
Output power	65 W
Output current	3.34 A (continuous)
Rated output voltage	19.5 ± 1 VDC

*Dimensions:*

Height	16 mm (0.63 inches)
Width	66 mm (2.6 inches)
Length	127 mm (5 inches)
Weight (with cables)	0.25 kg (0.55 lbs)

**AC Adapter**

---

<i>Temperature range</i>	
Operating	0° to 35°C (32° to 95°F)
Storage	–30° to 65°C (–22° to 149°F)

**Physical**

---

Height	16.4 mm to 25.8 mm (0.64 inches to 1.01 inches)
Width	292 mm (11.49 inches)
Depth	214 mm (8.42 inches)

*Weight (with 3-cell battery):*

Configurable to less than	1.35 kg (2.98 lbs)
---------------------------	--------------------

## Basic Specifications

### Computer Environment

---

#### *Temperature range:*

Operating	0° to 35°C (32° to 95°F)
Storage	–40° to 65°C (–40° to 149°F)

#### *Relative humidity (maximum):*

Operating	10% to 90% (noncondensing)
Storage	5% to 90% (noncondensing)

#### *Maximum vibration (using a random-vibration spectrum that simulates user environment):*

Operating	0.66 GRMS
Non-Operating	1.3 GRMS

### Computer Environment

---

*Maximum shock (for operating: measured with Dell Diagnostics running on the hard drive and a 2-ms half-sine pulse; for non-operating: measured with hard drive in head-parked position and a 2-ms half-sine pulse):*

Operating	110 GRMS
Non-Operating	160 GRMS

#### *Altitude (maximum):*

Operating	–15.2 to 3048 m (–50 to 10,000 ft)
Storage	–15.2 to 10,668 m (–50 to 35,000 ft)
Airborne contaminant level	G2 or lower as defined by ISA-S71.04-1985



# Appendix

## Macrovision Product Notice

This product incorporates copyright protection technology that is protected by method claims of certain U.S. patents and other intellectual property rights owned by Macrovision Corporation and other rights owners. Use of this copyright protection technology must be authorized by Macrovision Corporation, and is intended for home and other limited viewing uses only unless otherwise authorized by Macrovision Corporation. Reverse engineering or disassembly is prohibited.



## Information for NOM, or Official Mexican Standard (only for Mexico)

The following information is provided in the device(s) described in this document in accordance with the requirements of the Official Mexican Standard (NOM):

### Importer:

Dell México S.A. de C.V.

Paseo de la Reforma 2620 – Flat 11°

Col. Lomas Altas

11950 México, D.F.

### Laptops

Regulatory model number	Voltage	Frequency	Electricity consumption	Output voltage	Output intensity
P03T	100-240 V CA	50-60 Hz	1,5 A	19,5 V de CC	3,34 A

For details, read the safety information that shipped with your computer.

For additional safety best practices information, see the Regulatory Compliance Homepage at [www.dell.com/regulatory\\_compliance](http://www.dell.com/regulatory_compliance).

# Index

## A

- AC adapter
  - size and weight **67**
- airflow, allowing **5**

## B

- backups
  - creating **34**

## C

- calling Dell **60**
- CDs, playing and creating **32**
- chipset **64**
- computer capabilities **32**
- computer, setting up **5**
- conserving energy **33**

- Contacting Dell online **61**
- customer service **56**
- customizing
  - your desktop **33**
  - your energy settings **33**

## D

- damage, avoiding **5**
- data, backing up **34**
- DellConnect **56**
- Dell Diagnostics **45**
- Dell Factory Image Restore **49**
- Dell Support Center **43**
- Dell support website **63**
- Dell Technology Guide
  - for further information **62**

Diagnostic Checklist **60**  
drivers and downloads **63**  
DVDs, playing and creating **32**

## **E**

email addresses  
    for technical support **57**  
energy  
    conserving **33**

## **F**

finding more information **62**  
FTP login, anonymous **57**

## **H**

hardware problems  
    diagnosing **45**  
Hardware Troubleshooter **45**

help  
    getting assistance and support **55**

## **I**

Internet connection **14**  
ISP  
    Internet Service Provider **14**

## **M**

memory problems  
    solving **40**  
memory support **64**

## **N**

network connection  
    fixing **37**

### P

power strips, using **6**

processor **64**

products

information and purchasing **58**

### R

reinstalling Windows **54**

resources, finding more **62**

restoring factory image **51**

### S

setup, before you begin **5**

shipping products

for return or repair **59**

software features **32**

software problems **40**

specifications **64**

support email addresses **57**

support sites

worldwide **57**

System Messages **44**

System Restore **49**

### V

ventilation, ensuring **5**

### W

warranty returns **59**

Windows

reinstalling **53**

Windows Vista

Program Compatibility Wizard **41**

reinstalling **54**

wired network connection **7**

wireless network connection **37**



Printed in China  
Printed on recycled paper.

[www.dell.com](http://www.dell.com) | [support.dell.com](http://support.dell.com)



0V0K33A00