



Dell™ Precision™ M4300 Service Manual

[Before You Begin](#)
[Internal Card with Bluetooth® Wireless Technology](#)
[Hard Drive](#)
[Memory](#)
[FCM \(Flash Cache Module\)](#)
[Coin-Cell Battery](#)
[Hinge Cover](#)
[Keyboard](#)
[Communications Cards](#)
[Using Cards](#)
[PC Card Reader](#)

[Display Assembly](#)
[Palm Rest](#)
[Fan](#)
[Processor Thermal-Cooling Assembly](#)
[Processor Module](#)
[System Board](#)
[Base](#)
[Modem](#)
[Battery Latch](#)
[Flashing the BIOS](#)
[Pin Assignments for I/O Connectors](#)

Notes, Notices, and Cautions

-  **NOTE:** A NOTE indicates important information that helps you make better use of your computer.
 -  **NOTICE:** A NOTICE indicates either potential damage to hardware or loss of data and tells you how to avoid the problem.
 -  **CAUTION:** A CAUTION indicates a potential for property damage, personal injury, or death.
-

Information in this document is subject to change without notice.
© 2007 Dell Inc. All rights reserved.

Reproduction in any manner whatsoever without the written permission of Dell Inc. is strictly forbidden.

Trademarks used in this text: *Dell*, the *DELL* logo, and *Precision* are trademarks of Dell Inc.; *Bluetooth* is a registered trademark owned by Bluetooth SIG, Inc. and is used by Dell under license.

Other trademarks and trade names may be used in this document to refer to either the entities claiming the marks and names or their products. Dell Inc. disclaims any proprietary interest in trademarks and trade names other than its own.

Model PP04X

June 2007 Rev. A00

[Back to Contents Page](#)

Base

Dell™ Precision™ M4300 Service Manual

 **CAUTION:** Before performing the following procedures, follow the safety instructions in the Product Information Guide.

 **NOTICE:** To avoid electrostatic discharge, ground yourself by using a wrist grounding strap or by periodically touching a connector on the back panel of the computer.

1. Follow the procedures in [Before You Begin](#).
 2. Remove the hard drive (see [Hard Drive](#)).
 3. Remove the hinge cover (see [Hinge Cover](#)).
 4. Remove the internal card with Bluetooth® wireless technology.
 5. Remove the keyboard (see [Keyboard](#)).
 6. Remove the display assembly (see [Removing the Display Assembly](#)).
 7. Remove the palm rest (see [Palm Rest](#)).
 8. Remove the processor thermal-cooling assembly (see [Processor Thermal-Cooling Assembly](#)).
 9. Remove the processor (see [Removing the Processor Module](#)).
 10. Remove the modem (see [Modem](#)).
 11. Remove the fan (see [Fan](#)).
 12. Remove the system board (see [Removing the System Board](#)).
-

[Back to Contents Page](#)

Battery Latch

Dell™ Precision™ M4300 Service Manual

⚠ CAUTION: Before performing the following procedures, follow the safety instructions in the Product Information Guide.

🔌 NOTICE: To avoid electrostatic discharge, ground yourself by using a wrist grounding strap or by periodically touching a connector on the back panel of the computer.

1. Follow the procedures in [Before You Begin](#).
2. Remove the hard drive (see [Hard Drive](#)).
3. Remove the hinge cover (see [Hinge Cover](#)).
4. Remove the keyboard (see [Keyboard](#)).
5. Remove the display assembly (see [Removing the Display Assembly](#)).
6. Remove the palm rest (see [Palm Rest](#)).
7. Remove the processor thermal-cooling assembly (see [Processor Thermal-Cooling Assembly](#)).
8. Remove the system board (see [Removing the System Board](#)).
9. To remove the battery latch, use a plastic scribe or screwdriver to carefully dislodge the battery latch from the base, and lift the latch away.



Before You Begin

Dell™ Precision™ M4300 Service Manual

- [Recommended Tools](#)
- [Turning Off Your Computer](#)
- [Before Working Inside Your Computer](#)

This chapter provides procedures for removing and installing the components in your computer. Unless otherwise noted, each procedure assumes that the following conditions exist:

- 1 You have performed the steps in [Turning Off Your Computer](#) and [Before Working Inside Your Computer](#).
- 1 You have followed the safety information in the *Product Information Guide*.
- 1 A component can be replaced by performing the removal procedure in reverse order.

Recommended Tools

The procedures in this document may require the following tools:

- 1 Small flat-blade screwdriver
- 1 Phillips screwdriver
- 1 Small plastic scribe
- 1 Hex nut driver
- 1 Flash BIOS-update program CD

Turning Off Your Computer

🔔 **NOTICE:** To avoid losing data, save and close any open files and exit any open programs before you turn off your computer.

1. Shut down the operating system:
 - a. Save and close all open files and exit all open programs.
 - b. *In the Microsoft® Windows® XP operating system, click **Start→ Shut Down→ Shut down**.*

*In Microsoft® Windows Vista™, click the Windows Vista Start button  , click the arrow in the lower-right corner of the Start menu as shown below, and then click **Shut Down**.*



The computer turns off after the operating system shutdown process is complete.

Ensure that the computer and all attached devices are turned off. If your computer and attached devices did not automatically turn off when you shut down your operating system, press and hold the power button for about 4 seconds to turn them off.

Before Working Inside Your Computer

Use the following safety guidelines to help protect your computer from potential damage and to help ensure your own personal safety.

- ⚠ **CAUTION:** Before you begin any of the procedures in this section, follow the safety instructions in the *Product Information Guide*.
- ⚠ **CAUTION:** Handle components and cards with care. Do not touch the components or contacts on a card. Hold a card by its edges or by its metal mounting bracket. Hold a component such as a processor by its edges, not by its pins.
- 🔔 **NOTICE:** Only a certified service technician should perform repairs on your computer. Damage due to servicing that is not authorized by Dell is not covered by your warranty.
- 🔔 **NOTICE:** When you disconnect a cable, pull on its connector or on its pull-tab, not on the cable itself. Some cables have a connector with locking tabs; if you are disconnecting this type of cable, press in on the locking tabs before you disconnect the cable. As you pull connectors apart, keep them evenly aligned to avoid bending any connector pins. Also, before you connect a cable, ensure that both connectors are correctly oriented and aligned.
- 🔔 **NOTICE:** To avoid damaging the computer, perform the following steps before you begin working inside the computer.

1. Ensure that the work surface is flat and clean to prevent the computer cover from being scratched.

2. Turn off your computer (see [Turning Off Your Computer](#)).

🔗 **NOTICE:** To disconnect a network cable, first unplug the cable from your computer and then unplug it from the network wall jack.

3. Disconnect any telephone, network, and USB cables from the computer.

4. Disconnect your computer and all attached devices from their electrical outlets.

5. Turn over the computer.

🔗 **NOTICE:** To avoid damaging the system board, you must remove the main battery before you service the computer.

6. Remove the battery.

a. Slide the battery-bay release latch on the bottom of the computer toward the back of the computer until the latch is engaged.

b. Grasp the battery by the battery tab and slide the battery horizontally toward the side of the computer.

c. Lift to remove the battery from the bay.

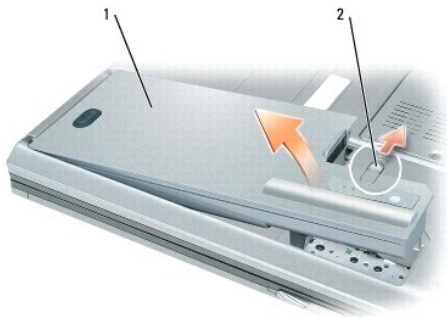

1	battery	2	battery-bay release latch		
---	---------	---	---------------------------	--	--

7. Press the power button to ground the system board.

8. Remove any installed ExpressCards, PC Cards, or smart cards from the computer [Using Cards](#).

[Back to Contents Page](#)

Internal Card with Bluetooth® Wireless Technology

Dell™ Precision™ M4300 Service Manual

⚠ CAUTION: Before performing the following procedures, follow the safety instructions in the Product Information Guide.

👉 NOTICE: To avoid electrostatic discharge, ground yourself by using a wrist grounding strap or by periodically touching a connector on the back panel of the computer.

If you ordered an internal card with Bluetooth wireless technology with your computer, it is already installed.

1. Follow the procedures in [Before You Begin](#).
2. Remove the hinge cover (see [Hinge Cover](#)).

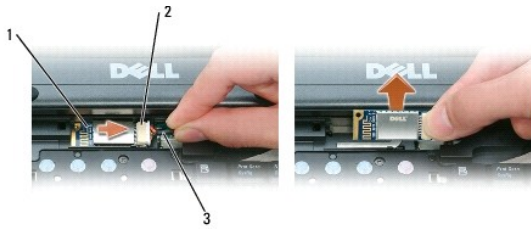

1	metal tab	2	card	3	card cable connector
---	-----------	---	------	---	----------------------

👉 NOTICE: Be careful when removing the card to avoid damaging the card, card cable, or surrounding components.

3. Remove the card from its compartment in the computer.
 - a. Slide the card to the right.
 - b. Lift the card out of the computer.
4. Disconnect the card from the card cable connector.

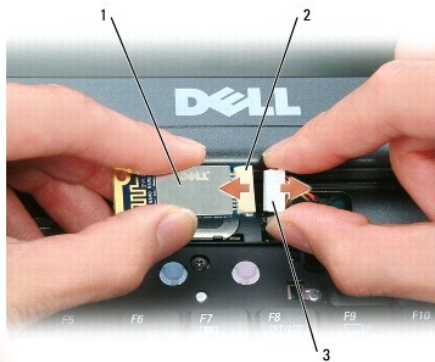

1	card	2	card connector	3	card cable connector
---	------	---	----------------	---	----------------------

[Back to Contents Page](#)

Using Cards

Dell™ Precision™ M4300 Service Manual

- [Card Types](#)
 - [Card Blanks](#)
 - [Extended Cards](#)
 - [Installing a PC Card or ExpressCard](#)
 - [Removing a Card or Blank](#)
-

Card Types

 **CAUTION:** Before you begin any of the procedures in this section, follow the safety instructions in the Product Information Guide.

 **NOTE:** A PC Card is not a bootable device.

The PC Card slot has one connector that supports a single Type I or Type II card. The PC Card slot supports CardBus technology and extended PC Cards. "Type" of card refers to its thickness, not its functionality.

The ExpressCard slot has one connector that supports 54-mm cards. The slot also supports adapters for 34-mm cards.

Card Blanks

Your computer shipped with a plastic blank installed in the card slots. Blanks protect unused slots from dust and other particles. Save the blank for use when no PC Card is installed in the slot; blanks from other computers may not fit your computer.

To remove the blank, see [Removing a Card or Blank](#).

Extended Cards

An extended card (for example, a wireless network adapter) is longer than a standard card and extends outside the computer. Follow these precautions when using extended PC or ExpressCards:

1. Protect the exposed end of an installed card. Striking the end of the card can damage the system board.
 1. Always remove an extended card before you pack the computer in its carrying case.
-

Installing a PC Card or ExpressCard

You can install a PC Card or ExpressCard in the computer while the computer is running. The computer automatically detects the card.

Cards are generally marked with a symbol (such as a triangle or an arrow) to indicate which end to insert into the slot. The cards are keyed to prevent incorrect insertion. If card orientation is not clear, see the documentation that came with the card.

 **CAUTION:** Before you begin any of the procedures in this section, follow the safety instructions in the Product Information Guide.

PC Card

1. Hold the card with its orientation symbol pointing into the slot and the top side of the card facing up. The latch may need to be in the "in" position before you insert the card.
2. Slide the card into the slot until the card is completely seated in its connector.

If you encounter too much resistance, do not force the card. Check the card orientation and try again.



The computer recognizes most cards and automatically loads the appropriate device driver. If the configuration program tells you to load the manufacturer's drivers, use the floppy disk or CD that came with the PC Card.

ExpressCard

1. Hold the card with its orientation symbol pointing into the slot and the top side of the card facing up. The latch may need to be in the "in" position before you insert the card.
2. Slide the card into the slot until the card is completely seated in its connector.

If you encounter too much resistance, do not force the card. Check the card orientation and try again.





The computer recognizes most cards and automatically loads the appropriate device driver. If the configuration program tells you to load the manufacturer's drivers, use the floppy disk or CD that came with the card.

If you have an adapter, such as the one shown below, you can use 34-mm ExpressCards in the PC Card slot. For information about using the PC Card slot, see [PC Card](#).



Removing a Card or Blank

 **CAUTION:** Before you begin any of the procedures in this section, follow the safety instructions in your Product Information Guide.

 **NOTICE:** Click the  icon (in the taskbar) to select a card and stop it from functioning before you remove it from the computer. If you do not stop the card in the configuration utility, you could lose data. Do not attempt to eject a card by pulling its cable, if one is attached.

Press the latch and remove the card or blank. For some latches, you must press the latch twice: once to pop the latch out, and then a second time to pop the card out.

[Back to Contents Page](#)

Coin-Cell Battery

Dell™ Precision™ M4300 Service Manual

⚠ CAUTION: Before performing the following procedures, follow the safety instructions in the Product Information Guide.

🕒 NOTICE: To avoid electrostatic discharge, ground yourself by using a wrist grounding strap or by periodically touching a connector on the back panel of the computer.

1. Follow the procedures in [Before You Begin](#).
2. Remove the memory module cover (see [Memory](#)).

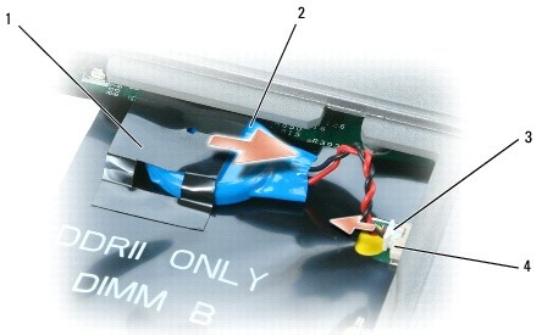

1	plastic sleeve	2	coin-cell battery	3	coin-cell battery connector
4	connector on system board				

3. Remove the coin-cell battery connector from the connector on the system board.
4. Slide the battery out of the plastic sleeve.

Processor Module

Dell™ Precision™ M4300 Service Manual

- [Removing the Processor Module](#)
- [Installing the Processor Module](#)

Removing the Processor Module

- ⚠ **CAUTION:** Before performing the following procedures, follow the safety instructions in the Product Information Guide.
- ➡ **NOTICE:** To avoid electrostatic discharge, ground yourself by using a wrist grounding strap or by periodically touching a connector on the back panel of the computer.
- ➡ **NOTICE:** Press and hold the processor down by applying slight pressure to the center of the processor while turning the cam screw to prevent intermittent contact between the cam screw and processor.
- ➡ **NOTICE:** To avoid damage to the processor, hold the screwdriver so that it is perpendicular to the processor when turning the cam screw.

1. Follow the procedures in [Before You Begin](#).
2. Remove the hinge cover (see [Hinge Cover](#)).
3. Remove the keyboard (see [Keyboard](#)).
4. Remove the display assembly (see [Display Assembly](#)).
5. Remove the palm rest (see [Palm Rest](#)).
6. Remove the processor thermal-cooling assembly (see [Processor Thermal-Cooling Assembly](#)).

- ➡ **NOTICE:** When removing the processor module, pull the module straight up. Be careful not to bend the pins on the processor module.
7. To loosen the ZIF socket, use a small, flat-blade screwdriver and rotate the ZIF-socket cam screw counterclockwise until it comes to the cam stop.
The ZIF-socket cam screw secures the processor to the system board. Take note of the arrow on the ZIF-socket cam screw.

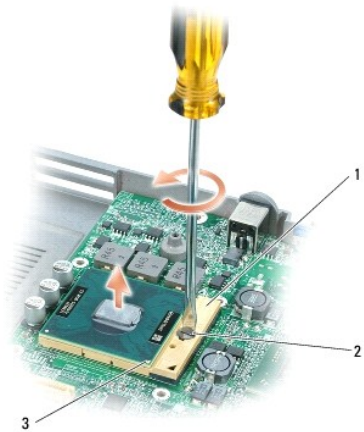

1	ZIF-socket	2	ZIF-socket cam screw	3	pin-1 corner of processor
---	------------	---	----------------------	---	---------------------------

8. Use a processor extraction tool to remove the processor module.

Installing the Processor Module

- ➡ **NOTICE:** Ensure that the cam lock is in the fully open position before seating the processor module. Seating the processor module properly in the ZIF socket does not require force.

 **NOTICE:** A processor module that is not properly seated can result in an intermittent connection or permanent damage to the processor and ZIF socket.

1. Align the pin-1 corner of the processor module so that it points to the triangle on the ZIF socket, and insert the processor module into the ZIF socket.

When the processor module is correctly seated, all four corners are aligned at the same height. If one or more corners of the module are higher than the others, the module is not seated correctly.

 **NOTICE:** Hold the processor down while turning the cam screw to prevent intermittent contact between the cam screw and processor.

2. Tighten the ZIF socket by turning the cam screw clockwise to secure the processor module to the system board.

 **NOTE:** If a new microprocessor is installed, you will receive one of the following: a new thermal-cooling assembly which will include an affixed thermal pad, or a new thermal pad along with a tech sheet to illustrate proper installation.

3. Replace the processor thermal-cooling assembly (see [Processor Thermal-Cooling Assembly](#)).
4. Update the BIOS using a flash BIOS-update program CD (see [Flashing the BIOS From a CD](#)).

[Back to Contents Page](#)

Processor Thermal-Cooling Assembly

Dell™ Precision™ M4300 Service Manual

⚠ CAUTION: Before performing the following procedures, follow the safety instructions in the Product Information Guide.

🔌 NOTICE: To avoid electrostatic discharge, ground yourself by using a wrist grounding strap or by periodically touching a connector on the back panel of the computer.

1. Follow the procedures in [Before You Begin](#).
2. Remove the hinge cover (see [Hinge Cover](#)).
3. Remove the keyboard (see [Keyboard](#)).
4. Remove the display assembly (see [Display Assembly](#)).
5. Remove the palm rest (see [Palm Rest](#)).
6. Loosen in consecutive order the six captive screws, labeled "1" through "6" that secure the processor thermal-cooling assembly.

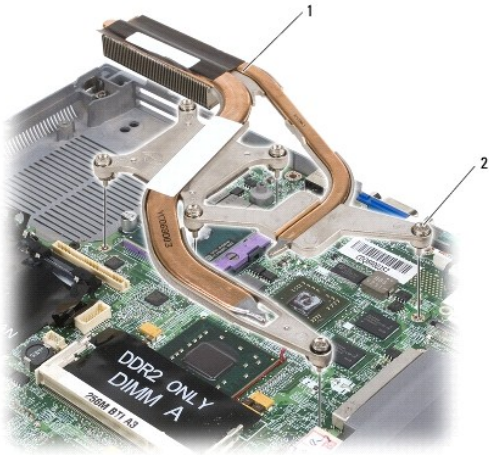

1	processor thermal-cooling assembly	2	captive screws (6)		
---	------------------------------------	---	--------------------	--	--

7. Lift the assembly out of the computer.

Display Assembly

Dell™ Precision™ M4300 Service Manual

- [Removing the Display Assembly](#)
- [Removing the Display Bezel](#)
- [Removing the Display Panel](#)
- [Installing the Display Panel](#)
- [Removing the Display Panel Brackets](#)
- [Removing the Display Latch](#)

Removing the Display Assembly

⚠ CAUTION: Before performing the following procedures, follow the safety instructions in the Product Information Guide.

🔧 NOTICE: To avoid electrostatic discharge, ground yourself by using a wrist grounding strap or by periodically touching a connector on the back panel of the computer.

1. Follow the procedures in [Before You Begin](#).
2. Remove the hinge cover (see [Hinge Cover](#)).
3. Remove the keyboard (see [Keyboard](#)).
4. Pull straight up on the pull-tab that is attached to the display-feed flex cable to disconnect the cable from the system board.

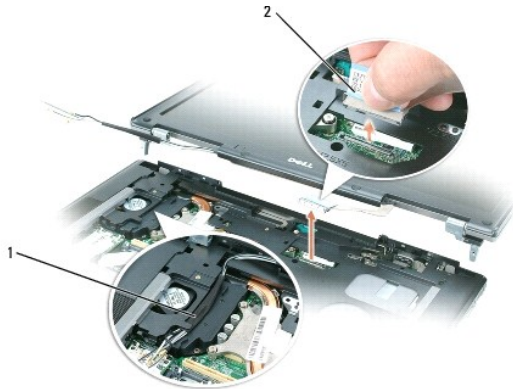

1	antenna cable	2	display cable pull-tab		
---	---------------	---	------------------------	--	--

5. Disconnect the antenna cable(s).
6. Carefully remove the antenna cable and the display cables from their routing guides.
7. Close the display.
8. Turn the computer upside-down with the back of the computer facing you.
9. From the bottom of the computer, remove the two M2.5 x 5-mm screws labeled "D."

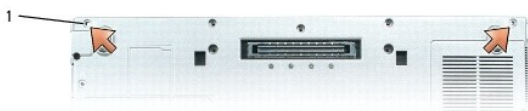

1	M2.5 x 5-mm screws labeled "D" (2)
---	------------------------------------

10. From the back of the computer, remove the two M2.5 x 5-mm screws.



1	M2.5 x 5-mm screws (2)
---	------------------------

11. Turn the computer top-side up and open the display.

12. Lift the display assembly out of the computer base.

Removing the Display Bezel

CAUTION: Before performing the following procedures, follow the safety instructions in the Product Information Guide.

NOTICE: To avoid electrostatic discharge, ground yourself by using a wrist grounding strap or by periodically touching a connector on the back panel of the computer.

1. Follow the procedures in [Before You Begin](#).
2. Remove the display assembly (see [Removing the Display Assembly](#)).
3. Remove the six rubber display bumpers and two mylar screw covers from around the display bezel.

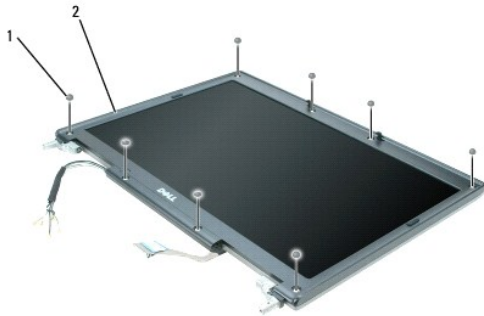

1	screw covers/display bumpers (8)	2	display bezel		
---	----------------------------------	---	---------------	--	--

4. Remove the eight M2.5 x 4.2 x 5-mm shoulder screws from around the display bezel.

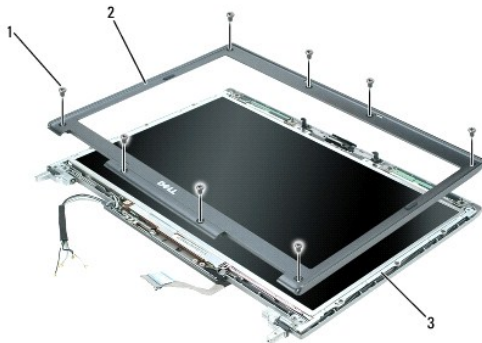

1	screws (8)	2	display bezel	3	top cover
---	------------	---	---------------	---	-----------

NOTICE: Carefully separate the bezel from the top cover to avoid damage to the bezel.

5. Starting from the sides of the display panel, use your fingers to separate the bezel from the top cover and lift the bezel away from the top cover.

Removing the Display Panel

⚠ CAUTION: Before performing the following procedures, follow the safety instructions in the Product Information Guide.

🔌 NOTICE: To avoid electrostatic discharge, ground yourself by using a wrist grounding strap or by periodically touching a connector on the back panel of the computer.

1. Follow the procedures in [Before You Begin](#).
2. Remove the display assembly (see [Removing the Display Assembly](#)).
3. Remove the display bezel (see [Removing the Display Bezel](#)).
4. Remove the eight M2.5 x 5-mm screws from the display panel.
5. Lift the display panel out of the top cover.

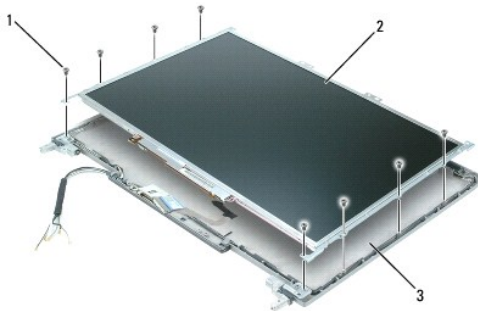

1	M2 x 3-mm screws (8)	2	display panel	3	top cover
---	----------------------	---	---------------	---	-----------

Installing the Display Panel

1. Replace the eight M2.5 x 5-mm screws that secure the display panel to the top cover.
2. Route the display feed-flex cable and antenna cables so that they rest in the notch located in the bottom edge of the top cover.
3. Replace the display bezel .

Removing the Display Panel Brackets

⚠ CAUTION: Before performing the following procedures, follow the safety instructions in the Product Information Guide.

🔌 NOTICE: To avoid electrostatic discharge, ground yourself by using a wrist grounding strap or by periodically touching a connector on the back panel of the computer.

1. Follow the procedures in [Before You Begin](#).
2. Remove the display assembly (see [Removing the Display Assembly](#)).
3. Remove the display bezel (see [Removing the Display Bezel](#)).
4. Remove the display panel (see [Removing the Display Panel](#)).
5. Remove the four M2 x 3-mm screws from the right display panel side bracket and lift away the bracket.

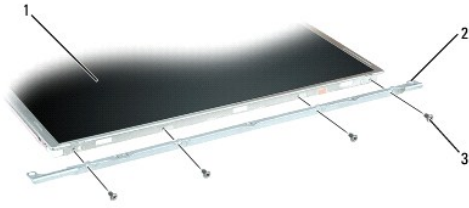

1	display panel	2	display panel side bracket	3	screws (4)
---	---------------	---	----------------------------	---	------------

- Remove the four M2 x 3-mm screws from the left display-panel side bracket and lift away the bracket.

Removing the Display Latch

⚠ CAUTION: Before performing the following procedures, follow the safety instructions in the Product Information Guide.

⚡ NOTICE: To avoid electrostatic discharge, ground yourself by using a wrist grounding strap or by periodically touching a connector on the back panel of the computer.

- Follow the procedures in [Before You Begin](#).
- Remove the display assembly (see [Removing the Display Assembly](#)).
- Remove the display bezel (see [Removing the Display Bezel](#)).
- Remove the display panel (see [Removing the Display Panel](#)).
- Remove the four M2 x 3-mm screws from the top display panel bracket and lift away the bracket.

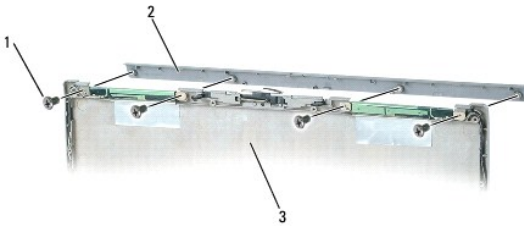

1	screws (4)	2	top display panel bracket	3	top cover
---	------------	---	---------------------------	---	-----------

- Slide the display latch toward the right side of the top cover and straight out.

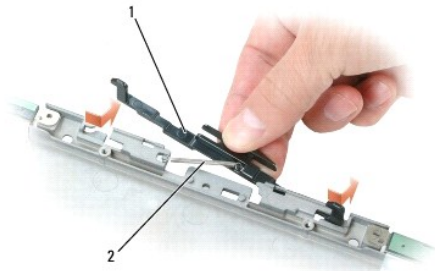

1	display latch	2	latch spring		
---	---------------	---	--------------	--	--

- Unhook the latch spring from the display latch, and then lift away the latch.

[Back to Contents Page](#)

Fan

Dell™ Precision™ M4300 Service Manual

⚠ CAUTION: Before performing the following procedures, follow the safety instructions in the Product Information Guide.

🔌 NOTICE: To avoid electrostatic discharge, ground yourself by using a wrist grounding strap or by periodically touching a connector on the back panel of the computer.

1. Follow the procedures in [Before You Begin](#).
2. Remove the hinge cover (see [Hinge Cover](#)).
3. Remove the keyboard (see [Keyboard](#)).
4. Remove the palm rest (see [Palm Rest](#)).
5. Disconnect the fan power cable from the system board.
6. Remove the two M2.5 x 5-mm fan screws and lift the fan out of the base.



1	fan assembly	2	M2.5 x 5-mm fan screws (2)
---	--------------	---	----------------------------

FCM (Flash Cache Module)

Dell™ Precision™ M4300 Service Manual

CAUTION: Before performing the following procedures, follow the safety instructions in the Product Information Guide.

NOTICE: To avoid electrostatic discharge, ground yourself by using a wrist grounding strap or by periodically touching a connector on the back panel of the computer.

NOTE: The FCM card is also known as Intel Turbo Memory and the Intel Flash Cache Logic Chip Mini-card.

The FCM, or Flash Cache Module, is an internal memory card that helps improve the performance of your computer.

NOTE: This card is only compatible with the Microsoft Windows Vista™ operating system.

NOTE: If you ordered an FCM card with your computer, the card is already installed.

1. Follow the procedures in [Before You Begin](#).
2. Remove the hinge cover (see [Hinge Cover](#)).
3. Remove the keyboard (see [Keyboard](#)).
4. Ground yourself by touching one of the metal connectors on the back of the computer.

NOTE: If you leave the area, ground yourself again when you return to the computer.

5. Slide the antenna cables out of the protective sleeve and away from the top of the FCM card.
6. Release the card by pushing the metal securing brackets away from the card until the card pops up slightly.



1	FCM card	2	antennae cables (2)	3	metal securing brackets (2)
---	----------	---	---------------------	---	-----------------------------

7. Lift the card out of its connector.



1	FCM card
---	----------

NOTICE: When installing this card, ensure that the two antenna cables are not under the card. The antenna cables are designed to lie across the top of the FCM card and into the protective sleeve. Installing the card on top of these antenna cables may cause damage to your computer. Also, do not install the FCM card in the WLAN card connector. The FCM card is designed to work in the WWAN card connector. Installing the card in the wrong connector may cause damage to your computer.

[Back to Contents Page](#)

Flashing the BIOS

Dell™ Precision™ M4300 Service Manual

- [Flashing the BIOS From a CD](#)
- [Flashing the BIOS From the Hard Drive](#)

If a BIOS-update program CD is provided with the new system board, flash the BIOS from the CD. If you do not have a BIOS-update program CD, flash the BIOS from the hard drive.

Flashing the BIOS From a CD

1. Ensure that the AC adapter is plugged in and that the main battery is installed properly.

 **NOTE:** If you use a BIOS-update program CD to flash the BIOS, set up the computer to boot from a CD before inserting the CD.

2. Insert the BIOS-update program CD, and restart the computer.

Follow the instructions that appear on the screen. The computer continues to boot and updates the new BIOS. When the flash update is complete, the computer will automatically reboot.







3. Press <F2> during POST to enter the system setup program.
 4. Press <Alt> and <F> to reset the computer defaults.
 5. Press <Esc>, select **Save changes and reboot**, and press <Enter> to save configuration changes.
 6. Remove the flash BIOS-update program CD from the drive and restart the computer.
-

Flashing the BIOS From the Hard Drive

1. Ensure that the AC adapter is plugged in, the main battery is properly installed, and a network cable is attached.
 2. Turn on the computer.
 3. Locate the latest BIOS update file for your computer at support.dell.com.
 4. Click **Download Now** to download the file.
 5. If the **Export Compliance Disclaimer** window appears, click **Yes, I Accept this Agreement**.
The **File Download** window appears.
 6. Click **Save this program to disk** and then click **OK**.
The **Save In** window appears.
 7. Click the down arrow to view the **Save In** menu, select **Desktop**, and then click **Save**.
The file downloads to your desktop.
 8. Click **Close** if the **Download Complete** window appears.
The file icon appears on your desktop and is titled the same as the downloaded BIOS update file.
 9. Double-click the file icon on the desktop and follow the instructions on the screen.
-

Hard Drive

Dell™ Precision™ M4300 Service Manual



-  **CAUTION:** Before you begin any of the procedures in this section, follow the safety instructions in the Product Information Guide.
-  **CAUTION:** If you remove the hard drive from the computer when the drive is hot, do not touch the metal housing of the hard drive.
-  **NOTICE:** To prevent data loss, turn off your computer before removing the hard drive. Do not remove the hard drive while the computer is turned on, in standby mode, or in hibernate mode.
-  **NOTICE:** Hard drives are extremely fragile; even a slight bump can damage the drive.
-  **NOTE:** Dell does not guarantee compatibility or provide support for hard drives from sources other than Dell.
-  **NOTE:** If you are installing a hard drive from a source other than Dell, you need to install an operating system, drivers, and utilities on the new hard drive.

To replace the hard drive in the hard drive bay:

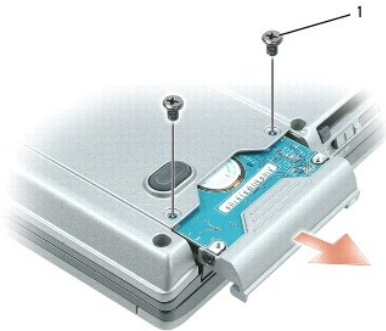
1. Follow the procedures in [Before You Begin](#).
2. Turn the computer upside-down, and remove the two M3 x 3-mm screws that secure the hard drive.



1	hard drive screws (2)
---	-----------------------

-  **NOTICE:** When the hard drive is not in the computer, store it in protective antistatic packaging.
-  **NOTE:** If the new hard drive already contains the bezel, skip steps 3 - 5.

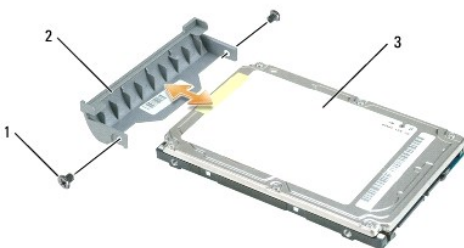

1	screws (2) on sides of hard drive bezel	2	hard drive bezel	3	hard drive
---	---	---	------------------	---	------------

3. Remove the two M3 x 5-mm screws from the sides of the hard drive bezel and pull the bezel off the hard drive.
 4. Remove the new drive from its packaging.
Save the original packaging for storing or shipping the hard drive.
 5. Slide the hard drive bezel that you took off the old hard drive onto the new hard drive and fasten the two M3 x 5-mm screws on the sides of the bezel.
-  **NOTICE:** Use firm and even pressure to slide the drive into place. If you use excessive force, you may damage the connector.

6. Slide the new hard drive into the bay and into the connector until it is fully seated.

7. Replace the two M3 x 3-mm hard drive screws.

[Back to Contents Page](#)

Hinge Cover

Dell™ Precision™ M4300 Service Manual

⚠ CAUTION: Before you begin any of the procedures in this section, follow the safety instructions in the Product Information Guide.

➡ NOTICE: To avoid electrostatic discharge, ground yourself by using a wrist grounding strap or by periodically touching a connector on the back panel of the computer.

➡ NOTICE: The hinge cover is fragile and can be damaged if extreme force is used. Be careful when removing the hinge cover.

1. Follow the procedures in [Before You Begin](#).

2. Turn the computer top-side up, and then open the display all the way (180 degrees) so that it rests on your work surface.

➡ NOTICE: To avoid damaging the hinge cover, do not lift the cover on both sides simultaneously.

3. Insert a plastic scribe in the indent to carefully pry up the hinge cover on the right side.



1	hinge cover	2	indent
---	-------------	---	--------

4. Ease the hinge cover up, moving from right to left, and remove it.

➡ NOTICE: When replacing the hinge cover, ensure the cable for the internal card with Bluetooth wireless technology is properly placed on top of the palmrest to avoid damaging the cable.

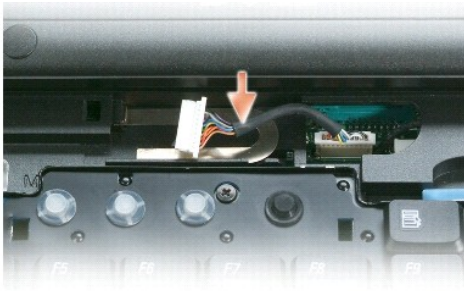

To replace the hinge cover, insert the left edge of the cover into the hinge cover slot, and press from left to right until the cover snaps into place.

Keyboard

Dell™ Precision™ M4300 Service Manual

⚠ CAUTION: Before working inside your Dell™ computer, follow the safety instructions in the Product Information Guide.

🔧 NOTICE: To avoid electrostatic discharge, ground yourself by using a wrist grounding strap or by periodically touching a connector on the back panel of the computer.

1. Follow the procedures in [Before You Begin](#).
2. Remove the hinge cover (see [Hinge Cover](#)).
3. Remove the three M2 x 3-mm screws at the top of the keyboard.

🔧 NOTICE: The keycaps on the keyboard are fragile, easily dislodged, and time-consuming to replace. Be careful when removing and handling the keyboard.

4. Rotate the keyboard forward and lay it on the palm rest to allow access to the keyboard connector on the system board.
5. Pull up on the pull-tab to disconnect the keyboard cable connector from the keyboard connector on the system board.

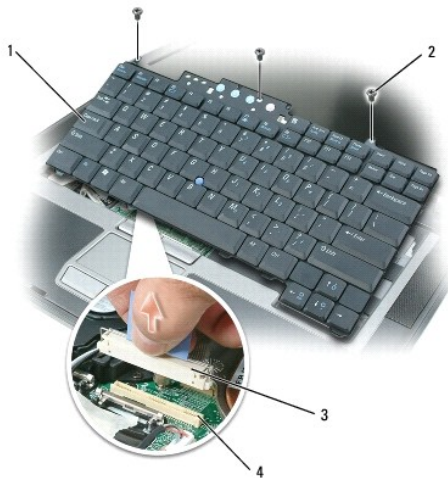

1	keyboard	2	M2 x 3-mm screws (3)	3	keyboard cable connector
4	keyboard connector				

🔧 NOTICE: To avoid scratching the palm rest when replacing the keyboard, hook the tabs along the front edge of the keyboard into the palm rest, and then secure the keyboard in place.

6. To replace the keyboard, connect the keyboard cable connector to the keyboard connector on the system board.
7. Place the tabs along the front edge of the keyboard into the palm rest and lay the keyboard down on the palm rest.
8. Replace the three M2 x 3-mm screws at the top of the keyboard.
9. Replace the hinge cover (see [Hinge Cover](#)).

Memory

Dell™ Precision™ M4300 Service Manual

⚠ CAUTION: Before you begin any of the procedures in this section, follow the safety instructions in the Product Information Guide.

➡ NOTICE: If your computer has only one memory module, install the memory module in the connector labeled "DIMM A."

➡ NOTICE: If you remove your original memory modules from the computer during a memory upgrade, keep them separate from any new modules that you may have, even if you purchased the new modules from Dell. If possible, do not pair an original memory module with a new memory module. Otherwise, your computer may not function at optimal performance.

🔧 NOTE: Memory modules purchased from Dell are covered under your computer warranty.

The computer has two memory slots, DIMM A and DIMM B. DIMM A is located on top of the computer under the keyboard, and DIMM B is located on the bottom of the computer under the memory module cover. DIMM A holds the basic memory module as configured from the factory. If you did not order additional memory, DIMM B is empty. Generally, if you add memory, use DIMM B. If you are upgrading memory, you may need to install memory in DIMM A and DIMM B, depending on the extent of the upgrade.

To install a memory module in DIMM A:

1. Follow the procedures in [Before You Begin](#).

2. Remove the hinge cover (see [Hinge Cover](#)).

3. Remove the keyboard (see [Keyboard](#)).

4. Ground yourself by touching one of the metal connectors on the back of the computer.

➡ NOTICE: If you leave the area, ground yourself again when you return to the computer.

5. If you are replacing a memory module, remove the existing module:

➡ NOTICE: To prevent damage to the memory module connector, do not use tools to spread the memory-module securing clips.

- a. Use your fingertips to carefully spread apart the securing clips on each end of the memory module connector until the module pops up.
- b. Remove the module from the connector.

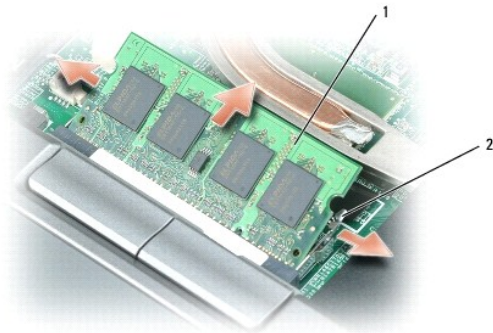

1	memory module	2	securing clips (2)		
---	---------------	---	--------------------	--	--

➡ NOTICE: Insert memory modules at a 45-degree angle to avoid damaging the connector.

🔧 NOTE: If the memory module is not installed properly, the computer may not boot properly. No error message indicates this failure.

6. Ground yourself and install the new memory module:

- a. Align the notch in the module edge connector with the tab in the connector slot.
- b. Slide the module firmly into the slot at a 45-degree angle, and rotate the module down until it clicks into place. If you do not feel the click, remove the module and reinstall it.

7. Replace the keyboard (see [Keyboard](#)).

8. Replace the hinge cover ([Hinge Cover](#)).
9. Insert the battery into the battery bay, or connect the AC adapter to your computer and an electrical outlet.
10. Turn on the computer.

As the computer boots, it detects the additional memory and automatically updates the system configuration information.

1. In the *Microsoft® Windows® XP* operating system, right-click the My Computer icon on your desktop. Click Properties/E General.
1. In the *Microsoft Windows Vista™* operating system, click the Windows Vista Start button , and right-click Computer→ Properties.

To confirm the amount of memory installed in the computer, click **Start→ Control Panel→ System**.

To install a memory module in DIMM B:

1. Follow the procedures in [Before You Begin](#).
2. Turn the computer upside-down, loosen the captive screw on the memory module cover, and then remove the cover.

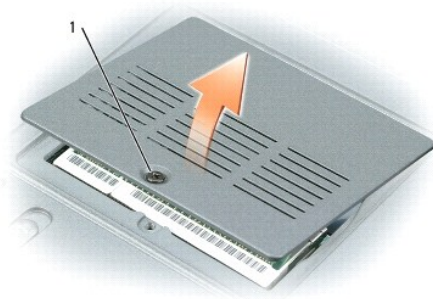

1	captive screw on memory module cover
---	--------------------------------------

3. Ground yourself by touching one of the metal connectors on the back of the computer.

 **NOTICE:** If you leave the area, ground yourself again when you return to the computer.

4. If you are replacing a memory module, remove the existing module:

 **NOTICE:** To prevent damage to the memory module connector, do not use tools to spread the memory-module securing clips.

- a. Use your fingertips to carefully spread apart the securing clips on each end of the memory module connector until the module pops up.
- b. Remove the module from the connector.

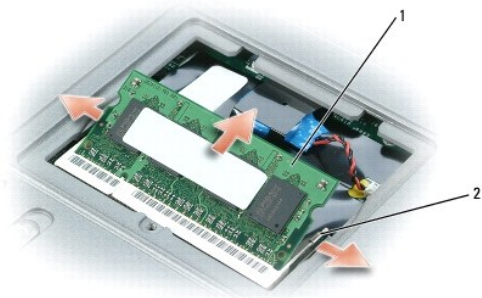

1	memory module	2	securing clips (2)
---	---------------	---	--------------------

 **NOTICE:** If you need to install memory modules in two connectors, install a memory module in the connector labeled "DIMM A" before you install a module in the connector labeled "DIMM B." Insert memory modules at a 45-degree angle to avoid damaging the connector.

 **NOTE:** If the memory module is not installed properly, the computer may not boot properly. No error message indicates this failure.

5. Ground yourself and install the new memory module:
 - a. Align the notch in the module edge connector with the tab in the connector slot.
 - b. Slide the module firmly into the slot at a 45-degree angle, and rotate the module down until it clicks into place. If you do not feel the click, remove the module and reinstall it.
6. Replace the memory module cover and tighten the screw.

 **NOTICE:** If the cover is difficult to close, remove the module and reinstall it. Forcing the cover to close may damage your computer.

7. Insert the battery into the battery bay, or connect the AC adapter to your computer and an electrical outlet.
8. Turn on the computer.

As the computer boots, it detects the additional memory and automatically updates the system configuration information.

To confirm the amount of memory installed in the computer:

1. In the Microsoft® Windows® XP operating system, right-click the **My Computer** icon on your desktop. Click **Properties**→ **General**.
1. In the Microsoft Windows Vista™ operating system, click the Windows Vista Start button  , and right-click **Computer**→ **Properties**.

[Back to Contents Page](#)

Communications Cards

Dell™ Precision™ M4300 Service Manual

- [Wireless Cards](#)
- [Subscriber Identity Module \(SIM\) Card \(optional\)](#)

Wireless Cards

If you ordered a wireless LAN or WAN card with your computer, the card is already installed.

⚠ CAUTION: Before you begin any of the procedures in this section, follow the safety instructions in the Product Information Guide.

Wireless Local Area Network (WLAN) Cards

1. Follow the procedures in [Before You Begin](#).
2. Remove the hinge cover (see [Hinge Cover](#)).
3. Remove the keyboard (see [Keyboard](#)).
4. Ground yourself by touching one of the metal connectors on the back of the computer.

🔧 NOTE: If you leave the area, ground yourself again when you return to the computer.

5. If a card is not already installed, go to [step 6](#). If you are replacing a card, remove the existing card:
 - a. Disconnect the antenna cables from the card.



1	antenna cables
---	----------------

- b. Release the card by pushing the metal securing brackets away from the card until the card pops up slightly.



1	WLAN card	2	metal securing brackets (2)
---	-----------	---	-----------------------------

c. Lift the card out of its connector.

➡ **NOTICE:** The connectors are keyed to ensure correct insertion. If you feel resistance, check the connectors and realign the card.

➡ **NOTICE:** Do not insert a WWAN (Mobile Broadband) network card into the WLAN card slot.

🔧 **NOTE:** The WLAN card may have two or three connectors, depending on the type of card you ordered.

6. Install the card:

➡ **NOTICE:** To avoid damaging the WLAN card, never place cables on top of or under the card.

a. Move any antenna cables out of the way to make space for the WLAN card.

b. Align the card with the connector at a 45-degree angle, and press the card into the connector until it clicks.

🔧 **NOTE:** Your WLAN card may have two or three connectors, depending on the type of card you ordered. Most connectors have color-coded markings that correspond to the type of cable required.

🔧 **NOTE:** For more specific information about which cable to connect to which connector, see the documentation that came with your WLAN card.

7. Connect the antenna cables to the WLAN card, ensuring that you route the cables correctly.

Mobile Broadband or Wireless Wide Area Network (WWAN) Cards

1. Follow the procedures in [Before You Begin](#).

2. Remove the hinge cover (see [Hinge Cover](#)).

3. Remove the keyboard (see [Keyboard](#)).

4. Ground yourself by touching one of the metal connectors on the back of the computer.

🔧 **NOTE:** If you leave the area, ground yourself again when you return to the computer.

5. If a card is not already installed, go to [step 6](#). If you are replacing a card, remove the existing card:

a. Disconnect the antenna cables from the card.



1	antenna cables
---	----------------

b. Release the card by pushing the metal securing brackets away from the card until the card pops up slightly.



1	WWAN card	2	metal securing brackets (2)
---	-----------	---	-----------------------------

c. Lift the card out of its connector.

➡ **NOTICE:** The connectors are keyed to ensure correct insertion. If you feel resistance, check the connectors and realign the card.

6. Install the card:

➡ **NOTICE:** To avoid damaging the Mobile Broadband card, never place cables on top of or under the card.

a. Align the card with the connector at a 45-degree angle, and press the card into the connector until it clicks.

🔍 **NOTE:** Most antenna connectors have color-coded markings that correspond to the color of the cable. For more specific information about which cable to connect to which connector, see the documentation that came with your WWAN card.

b. Connect the antenna cables to the WWAN card, ensuring that you route the cables correctly.

Subscriber Identity Module (SIM) Card (optional)

⚠ **CAUTION:** Before you begin any of the procedures in this section, follow the safety instructions in the Product Information Guide.

🔍 **NOTE:** The SIM card is optional depending on the type of WWAN (Mobile Broadband) card that is purchased.

🔍 **NOTE:** The SIM card is located inside the battery bay.

1. Follow the procedures in [Before You Begin](#).

2. Slide the SIM card into the slot with the cut-off corner of the card facing away from the slot.

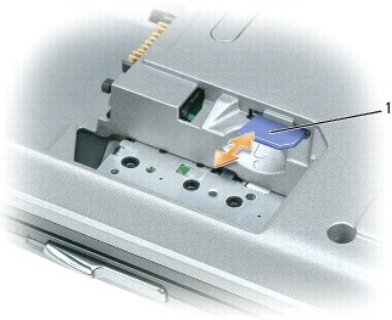

1	SIM card
---	----------

Modem

Dell™ Precision™ M4300 Service Manual

⚠ CAUTION: Before you begin the following procedure, see the safety instructions in the Product Information Guide.

➡ NOTICE: To avoid electrostatic discharge, ground yourself by using a wrist grounding strap or by periodically touching a connector on the back panel of the computer.

1. Follow the procedures in [Before You Begin](#).
2. Remove the hinge cover (see [Hinge Cover](#)).
3. Remove the keyboard (see [Keyboard](#)).
4. Remove the display assembly (see [Display Assembly](#)).
5. Remove the palm rest (see [Palm Rest](#)).
6. Remove the M2 x 3-mm screw that attaches the modem to the system board.
7. Pull up on the pull-tab to disconnect the modem from the connector on the system board.

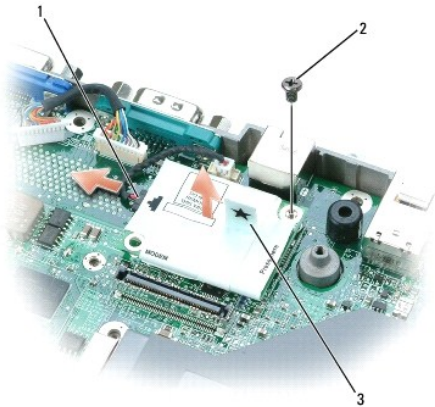

1	modem cable connector	2	M2 x 3-mm screw	3	modem pull-tab
---	-----------------------	---	-----------------	---	----------------

➡ NOTICE: Do not disconnect the modem cable from the system board.

8. Disconnect the modem cable connector from the modem.

Palm Rest

Dell™ Precision™ M4300 Service Manual

⚠ CAUTION: Before performing the following procedures, follow the safety instructions in the Product Information Guide.

🔧 NOTICE: To avoid electrostatic discharge, ground yourself by using a wrist grounding strap or by periodically touching a connector on the back panel of the computer.

1. Follow the procedures in [Before You Begin](#).
2. Remove any devices installed in the media bay.
3. Remove the hard drive (see [Hard Drive](#)).
4. Remove the hinge cover (see [Hinge Cover](#)).
5. Remove the keyboard (see [Keyboard](#)).
6. Remove the display assembly (see [Removing the Display Assembly](#)).
7. Remove the internal card with Bluetooth wireless technology (see [Internal Card with Bluetooth® Wireless Technology](#)).
8. Remove the three M2.5 x 5-mm screws from the top of the palm rest.



9. Turn the computer bottom-side up.
10. Remove the eleven M2.5 x 5-mm screws from the bottom of the computer.

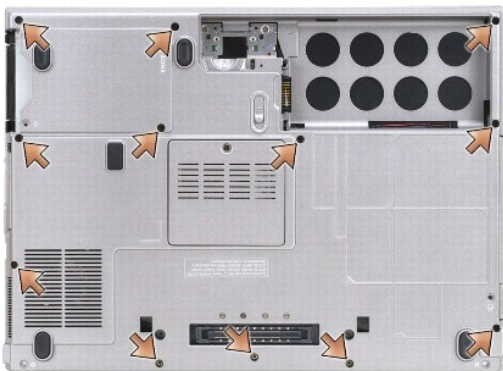

🔧 NOTICE: Carefully separate the palm rest from the base to avoid damage to the palm rest.

11. Starting at the back center of the palm rest, use your fingers to separate the palm rest from the base by lifting the inside edge of the palm rest.
12. Disconnect the touch pad connector and the speaker connector from the system board.



➡ **NOTICE:** When replacing the palm rest, ensure the cable for the internal card with Bluetooth wireless technology is properly placed on top of the palm rest to avoid damaging the cable.



[Back to Contents Page](#)

PC Card Reader

Dell™ Precision™ M4300 Service Manual

⚠ CAUTION: Before performing the following procedures, follow the safety instructions in the Product Information Guide.

🔌 NOTICE: To avoid electrostatic discharge, ground yourself by using a wrist grounding strap or by periodically touching a connector on the back panel of the computer.

1. Follow the procedures in [Before You Begin](#).
2. Remove the hinge cover (see [Hinge Cover](#)).
3. Remove the keyboard (see [Keyboard](#)).
4. Remove the display assembly (see [Display Assembly](#)).
5. Remove the palm rest (see [Palm Rest](#)).
6. Remove the four M2 x 3-mm screws that secure the PC Card reader to the computer base.

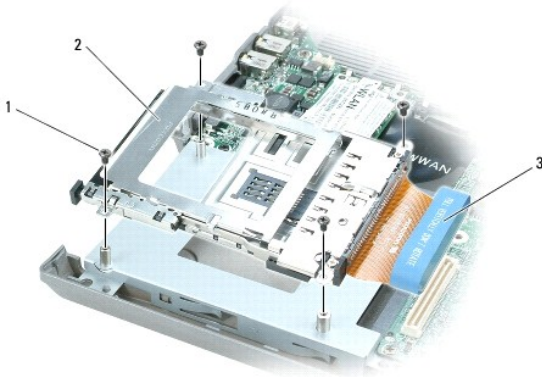

1	screws (4)	2	PC Card reader	3	pull-tab
---	------------	---	----------------	---	----------

7. Use the pull-tab to disconnect the PC Card reader cable connector from the system board.

Pin Assignments for I/O Connectors

Dell™ Precision™ M4300 Service Manual

- [USB Connector](#)
 - [Video Connector](#)
 - [S-Video TV-Out Connector](#)
 - [Serial Connector](#)
-

USB Connector

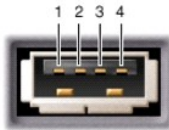

Pin	Signal
1	USB5V+
2	USBP-
3	USBP+
4	GND

Video Connector



Pin	Signal	Pin	Signal
1	CRT_R	9	5V+
2	CRT_G	10	GND
3	CRT_B	11	MONITOR_DETECT-
4	NC	12	DDC_DATA
5	GND	13	CRT_HS
6	GND	14	CRT_VS
7	GND	15	DDC_CLK
8	GND		

S-Video TV-Out Connector

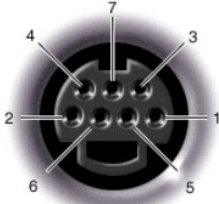

S-Video	
Pin	Signal
1	GND
2	GND
3	DLUMA-L
4	DCRMA-L

Serial Connector



Pin	Signal	Pin	Signal
1	DCD	6	DSR
2	RXDA	7	RTS
3	TXDA	8	CTS
4	DTR	9	RI
5	GND		

Del

[Back to Contents Page](#)

System Board

Dell™ Precision™ M4300 Service Manual

- [Removing the System Board](#)
- [Installing the System Board](#)

Removing the System Board

⚠ CAUTION: Before performing the following procedures, follow the safety instructions in the Product Information Guide.

🔌 NOTICE: To avoid electrostatic discharge, ground yourself by using a wrist grounding strap or by periodically touching a connector on the back panel of the computer.

The system board's BIOS chip contains the Service Tag, which is also visible on a barcode label on the bottom of the computer. The replacement kit for the system board includes a CD that provides a utility for transferring the Service Tag to the replacement system board.

1. Follow the procedures in [Before You Begin](#).
2. Remove the hard drive (see [Hard Drive](#)).
3. Remove the hinge cover (see [Hinge Cover](#)).
4. Remove the keyboard (see [Keyboard](#)).
5. Remove the display assembly (see [Display Assembly](#)).
6. Remove the DIMM A and DIMM B memory modules (see [Memory](#)).
7. Remove any installed wireless communications cards (see [Communications Cards](#)).
8. Remove the palm rest (see [Palm Rest](#)).
9. Remove the modem (see [Modem](#)).
10. Remove the card reader (see [PC Card Reader](#)).
11. Remove the fan (see [Fan](#)).
12. Remove the processor thermal-cooling assembly (see [Processor Thermal-Cooling Assembly](#)).
13. Remove the processor (see [Removing the Processor Module](#)).
14. Remove the four M2.5 x 5-mm system board screws.

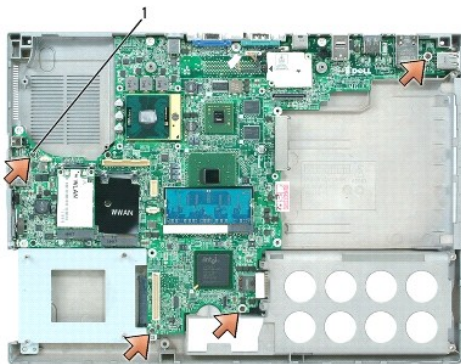

1	M2.5 x 5-mm screws (4)
---	------------------------

15. Remove the four hex screws on the back of the computer.

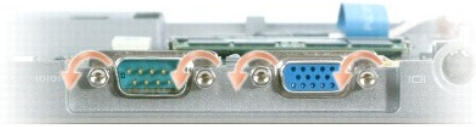

16. Lift the system board out and away from the base.

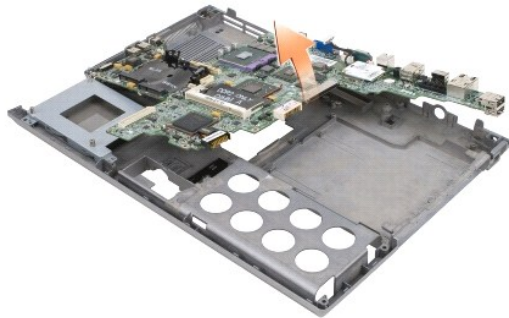

Installing the System Board

1. Perform all the steps in [Removing the System Board](#) in reverse order.

 **NOTE:** When installing the system board, ensure that you align the wireless switch on the base with the switch on the system board.



1	wireless switch
---	-----------------

2. Insert the battery into the battery bay.
3. Connect the AC adapter to the computer and to an electrical outlet.

 **NOTE:** Before turning on the computer, replace all screws and ensure that no stray screws remain inside the computer. Failure to do so may result in damage to the computer.

4. Turn on the computer.



 **NOTE:** After replacing the system board, you must enter the computer Service Tag into the BIOS of the replacement system board.

5. Insert the CD that accompanied the replacement system board into the appropriate drive. Follow the instructions on the screen.

[Back to Contents Page](#)

Dell™ Precision™ M4300 Service Manual

Notes, Notices, and Cautions

-  **NOTE:** A NOTE indicates important information that helps you make better use of your computer.
 -  **NOTICE:** A NOTICE indicates either potential damage to hardware or loss of data and tells you how to avoid the problem.
 -  **CAUTION:** A CAUTION indicates a potential for property damage, personal injury, or death.
-
-
-

Information in this document is subject to change without notice.
© 2007 Dell Inc. All rights reserved.

Reproduction in any manner whatsoever without the written permission of Dell Inc. is strictly forbidden.

Trademarks used in this text: *Dell*, the *DELL* logo, and *Precision* are trademarks of Dell Inc.; *Bluetooth* is a registered trademark owned by Bluetooth SIG, Inc. and is used by Dell under license.

Other trademarks and trade names may be used in this document to refer to either the entities claiming the marks and names or their products. Dell Inc. disclaims any proprietary interest in trademarks and trade names other than its own.

Model PP04X

June 2007 Rev. A00

[Back to Contents Page](#)