

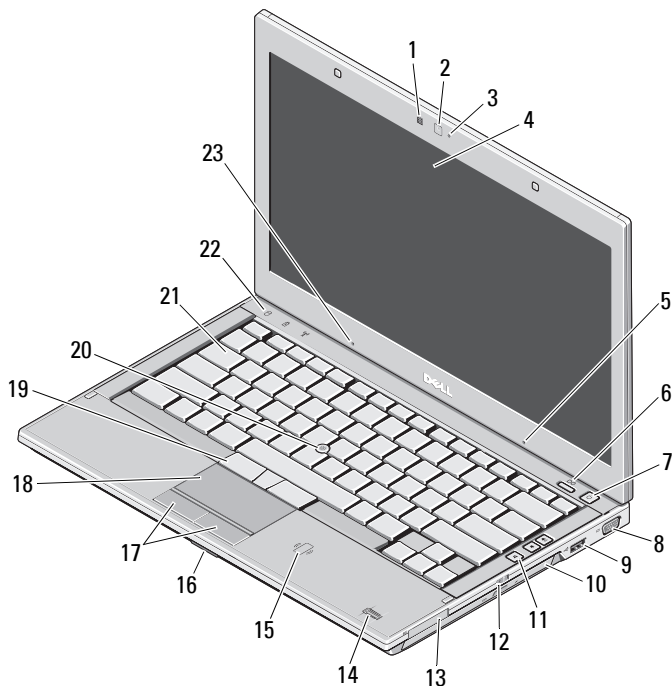

# Dell™ Latitude™ E4310

## Setup and Features Information

### Front View



 **NOTE:** Your computer ships with the optional microphone only if you order the camera.

## About Warnings



**WARNING:** A WARNING indicates a potential for property damage, personal injury, or death.

- 1 ambient-light sensor
- 2 camera (optional)
- 3 camera-status light (optional)
- 4 display
- 5 microphone (optional)
- 6 Dell Latitude ON™ button (optional)
- 7 power button
- 8 video connector (VGA)
- 9 USB 2.0 connector
- 10 optical drive
- 11 volume-control buttons (3)
- 12 wireless switch
- 13 ExpressCard slot
- 14 fingerprint reader (optional)
- 15 contactless smart-card reader (optional)
- 16 memory-card slot
- 17 touchpad buttons (2)
- 18 touchpad
- 19 track-stick buttons (3)
- 20 track stick
- 21 keyboard
- 22 device-status lights
- 23 microphone



Regulatory Model: P05G

Regulatory Type: P05G001

June 2010

## Back View

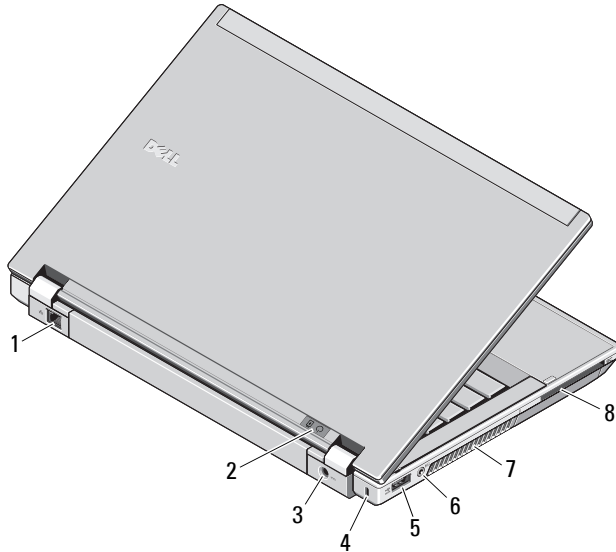

- 1 network connector
- 2 power and battery lights
- 3 AC-adaptor connector
- 4 security-cable slot
- 5 eSATA/USB 2.0 connector
- 6 headphone (line-out) / microphone (line-in) connector
- 7 cooling vents
- 8 smart-card slot



**WARNING:** Do not block, push objects into, or allow dust to accumulate in the air vents. Do not store your Dell computer in a low-airflow environment, such as a closed briefcase, while it is running. Restricting the airflow can damage the computer or cause a fire. The computer turns on the fan when the computer gets hot. Fan noise is normal and does not indicate a problem with the fan or the computer.

## Quick Setup



**WARNING:** Before you begin any of the procedures in this section, read the safety information that shipped with your computer. For additional best practices information, see [www.dell.com/regulatory\\_compliance](http://www.dell.com/regulatory_compliance).



**WARNING:** The AC adapter works with electrical outlets worldwide. However, power connectors and power strips vary among countries. Using an incompatible cable or improperly connecting the cable to the power strip or electrical outlet may cause fire or equipment damage.



**CAUTION:** When you disconnect the AC adapter cable from the computer, grasp the connector, not the cable itself, and pull firmly but gently to avoid damaging the cable. When you wrap the AC adapter cable, ensure that you follow the angle of the connector on the AC adapter to avoid damaging the cable.



**NOTE:** Some devices may not be included if you did not order them.

- 1 Connect the AC adapter to the AC-adapter connector on the portable computer and to the electrical outlet.

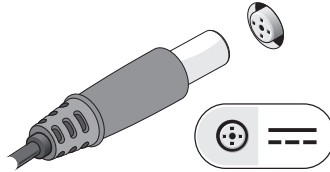

- 2 Connect the network cable (optional).

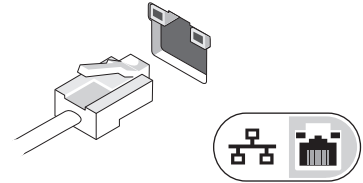

- 3 Connect USB devices, such as a mouse or keyboard (optional).

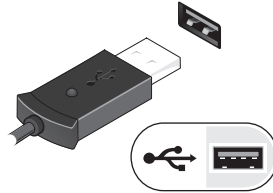

- 4 Open the computer display and press the power button to turn on the computer.

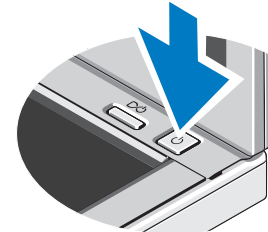

**NOTE:** It is recommended that you turn on and shut down your computer at least once before you install any cards or connect the computer to a docking device or other external device, such as a printer.

## Specifications

 **NOTE:** Offerings may vary by region. For more information regarding the configuration of your computer, click **Start** → **Help and Support** and select the option to view information about your computer.

---

### System Information

---

Processor type	Intel® Core™ i3 series Intel Core i5 series Intel Core i7 series
Chipset	Intel 5-series chipset

---

### Memory

---

Memory module connector	two SODIMM sockets
Memory module capacity	1 GB, 2 GB, or 4 GB
Memory type	DDR3, 1066 MHz
Minimum memory	1 GB
Maximum memory	8 GB

**NOTE:** Only 64-bit operating systems support more than 4 GB memory.

---

### Video

---

Video type	integrated on system board
Video controller	Intel HD graphics

---

### Contactless Smart Card

---

Supported Smart Cards/Technologies	ISO14443A — 106 kbps, 212 kbps, 424 kbps, and 848 kbps ISO14443B — 106 kbps, 212 kbps, 424 kbps, and 848 kbps ISO15693 HID iClass FIPS201 NXP Desfire
------------------------------------	--

---

### Battery

---

Type	3-cell, 2.8 AHr, 30 WHr 6-cell, 2.8 AHr, 60 WHr 6-cell, 2.5 AHr long life, 54 WHr battery slice, 48 WHr
Dimensions	
Depth	3-cell — 28.80 mm (1.13 inches) 6-cell — 51.10 mm (2.01 inches)
Height	21.90 mm (0.86 inches)
Width	189.80 mm (7.47 inches)
Weight	3-cell — 0.19 kg (0.42 lb) 6-cell — 0.34 kg (0.75 lb) battery slice — 0.63 kg (1.39 lb)
Voltage	11.1 VDC
Temperature range	
Operating	0 °C to 35 °C (32 °F to 95 °F)
Storage	-40 °C to 70 °C (-40 °F to 158 °F)
Coin-cell battery	3 V CR2032 lithium

---

**AC Adapter**

---

Input voltage	100–240 VAC
Input current (maximum)	1.5 A
Input frequency	50–60 Hz
Output power	65 W or 90 W
Output current	
65 W	4.34 A (maximum at 4-second pulse) 3.34 A (continuous)
90 W	5.62 A (maximum at 4-second pulse) 4.62 A (continuous)
Output voltage	19.5 +/- 1.0 VDC
Dimensions	
Width	
65 W	66.00 mm (2.60 inches)
90 W	70.00 mm (2.75 inches)
Height	
65 W	16.00 mm (0.63 inches)
90 W	16.00 mm (0.63 inches)
Depth	
65 W	127.00 mm (5.00 inches)
90 W	147.00 mm (5.78 inches)
Temperature range	
Operating	0 °C to 40 °C (32 °F to 104°F)
Storage	-40 °C to 70 °C (-40 °F to 158 °F)

---

**Physical**

---

Front height	26.50 mm (1.04 inches)
Back height	30.50 mm (1.20 inches)
Width	323 mm (12.72 inches)
Depth	215 mm (8.47 inches)
Weight	1.63 kg–1.95 kg (3.60 lb–4.30 lb)

---

**Environmental**

---

Temperature range	
Operating	0 °C to 35 °C (32 °F to 95 °F)
Storage	-40 °C to 70 °C (-40 °F to 158 °F)
Relative humidity (maximum)	
Operating	10 % – 90 % (noncondensing)
Storage	5 % – 95 % (noncondensing)
Altitude (maximum)	
Operating	-15.2 m to 3048 m (-50 ft to 10,000 ft)
Storage	-15.2 m to 10,668 m (-50 ft to 35,000 ft)

## Finding More Information and Resources

See the safety and regulatory documents that shipped with your computer and the regulatory compliance website at [www.dell.com/regulatory\\_compliance](http://www.dell.com/regulatory_compliance) for more information on:

- Safety best practices
- Warranty
- Terms and Conditions
- Regulatory certification
- Ergonomics
- End User License Agreement

---

**Information in this document is subject to change without notice.  
© 2010 Dell Inc. All rights reserved.**

Reproduction of these materials in any manner whatsoever without the written permission of Dell Inc. is strictly forbidden.

Trademarks used in this text: *Dell*, the *DELL* logo, *Latitude*, and *Latitude ON* are trademarks of Dell Inc.; *Intel* is a registered trademark and *Core* is a trademark of Intel Corporation in the United States and other countries.

Other trademarks and trade names may be used in this document to refer to either the entities claiming the marks and names or their products. Dell Inc. disclaims any proprietary interest in trademarks and trade names other than its own.