



Dell™ XPS™ L502X Service Manual

[Before You Begin](#)
[Battery](#)
[Module Cover](#)
[Memory Module\(s\)](#)
[Wireless Mini-Card\(s\)](#)
[Optical Drive](#)
[Palm-Rest Assembly](#)
[Power-Button Board](#)
[Coin-Cell Battery](#)
[Hard Drive](#)
[Keyboard](#)
[Display](#)

[Camera Module](#)
[Top Cover](#)
[Fan](#)
[Subwoofer](#)
[AC-Adapter Connector](#)
[USB Board](#)
[TV Tuner Connector](#)
[Heat Sink](#)
[Processor Module](#)
[System Board](#)
[Speakers](#)
[Flashing the BIOS](#)

Notes, Cautions, and Warnings

-  **NOTE:** A NOTE indicates important information that helps you make better use of your computer.
-  **CAUTION:** A CAUTION indicates potential damage to hardware or loss of data if instructions are not followed.
-  **WARNING:** A WARNING indicates a potential for property damage, personal injury, or death.

Information in this document is subject to change without notice.
© 2011 Dell Inc. All rights reserved.

Trademarks used in this text: Dell™, the DELL logo, and XPS™ are trademarks of Dell Inc.; Microsoft®, Windows®, and the Windows start button logo  are either trademarks or registered trademarks of Microsoft Corporation in the United States and/or other countries; Bluetooth® is a registered trademark owned by Bluetooth SIG, Inc. and is used by Dell Inc. under license.

Reproduction of these materials in any manner whatsoever without the written permission of Dell Inc. is strictly forbidden.

Regulatory model: P11F series Regulatory type: P11F003

2011 - 02 Rev. A00

Battery

Dell™ XPS™ L502X Service Manual

- [Removing the Battery](#)
- [Replacing the Battery](#)

- ⚠ WARNING:** Before working inside your computer, read the safety information that shipped with your computer. For additional safety best practices information, see the Regulatory Compliance Homepage at www.dell.com/regulatory_compliance.
- ⚠ CAUTION:** Only a certified service technician should perform repairs on your computer. Damage due to servicing that is not authorized by Dell™ is not covered by your warranty.
- ⚠ CAUTION:** To avoid electrostatic discharge, ground yourself by using a wrist grounding strap or by periodically touching an unpainted metal surface (such as a connector on your computer).
- ⚠ CAUTION:** To avoid damage to the computer, use only the battery designed for this particular Dell computer. Do not use batteries designed for other Dell computers.
-

Removing the Battery

1. Follow the instructions in [Before You Begin](#).
2. Turn the computer over.
3. Slide the battery release latch to the side.
4. Lift the battery up at an angle and remove it from the battery bay.

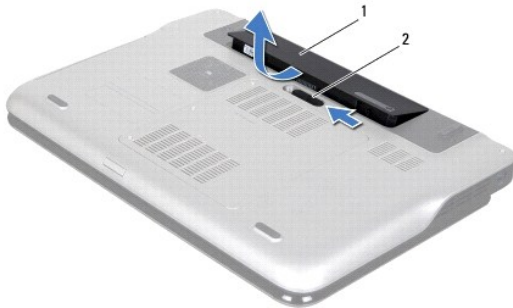

1	battery	2	battery release latch
---	---------	---	-----------------------

Replacing the Battery

- ⚠ CAUTION:** To avoid damage to the computer, use only the battery designed for this particular Dell computer.
1. Follow the instructions in [Before You Begin](#).
 2. Align the tabs on the battery with the slots in the battery bay and press the battery down until it clicks into place.
-

[Back to Contents Page](#)

Before You Begin

Dell™ XPS™ L502X Service Manual

- [Recommended Tools](#)
- [Turning Off Your Computer](#)
- [Before Working Inside Your Computer](#)

This manual provides procedures for removing and installing the components in your computer. Unless otherwise noted, each procedure assumes that the following conditions exist:

- 1 You have performed the steps in [Turning Off Your Computer](#) and [Before Working Inside Your Computer](#).
- 1 You have read the safety information that shipped with your computer.
- 1 A component can be replaced or—if purchased separately—installed by performing the removal procedure in reverse order.

Recommended Tools

The procedures in this document may require the following tools:

- 1 Small flat-blade screwdriver
- 1 Phillips screwdriver
- 1 Plastic scribe
- 1 BIOS executable update program available at support.dell.com

Turning Off Your Computer

 **CAUTION:** To avoid losing data, save and close all open files and exit all open programs before you turn off your computer.

1. Save and close all open files and exit all open programs.
2. To shut down the operating system, click **Start**  and then click **Shut Down**.
3. Ensure that the computer is turned off. If your computer did not automatically turn off when you shut down the operating system, press and hold the power button until the computer turns off.

Before Working Inside Your Computer

Use the following safety guidelines to help protect your computer from potential damage and to help to ensure your own personal safety.

 **WARNING:** Before working inside your computer, read the safety information that shipped with your computer. For additional safety best practices information, see the Regulatory Compliance Homepage at www.dell.com/regulatory_compliance.

 **CAUTION:** To avoid electrostatic discharge, ground yourself by using a wrist grounding strap or by periodically touching an unpainted metal surface (such as a connector on your computer).

 **CAUTION:** Handle components and cards with care. Do not touch the components or contacts on a card. Hold a card by its edges or by its metal mounting bracket. Hold a component such as a processor by its edges, not by its pins.

 **CAUTION:** Only a certified service technician should perform repairs on your computer. Damage due to servicing that is not authorized by Dell™ is not covered by your warranty.

 **CAUTION:** When you disconnect a cable, pull on its connector or on its pull-tab, not on the cable itself. Some cables have connectors with locking tabs; if you are disconnecting this type of cable, press in on the locking tabs before you disconnect the cable. As you pull connectors apart, keep them evenly aligned to avoid bending any connector pins. Also, before you connect a cable, ensure that both connectors are correctly oriented and aligned.

 **CAUTION:** To avoid damaging the computer, perform the following steps before you begin working inside the computer.

1. Ensure that the work surface is flat and clean to prevent the computer cover from being scratched.
2. Turn off your computer (see [Turning Off Your Computer](#)) and all attached devices.

 **CAUTION:** To disconnect a network cable, first unplug the cable from your computer and then unplug the cable from the network device.

3. Disconnect all telephone or network cables from the computer.

4. Press and eject any installed cards from the Media Card Reader.
5. Disconnect your computer and all attached devices from their electrical outlets.
6. Disconnect all attached devices from your computer.

 **CAUTION:** To help prevent damage to the system board, remove the main battery (see [Removing the Battery](#)) before working inside the computer.

7. Remove the battery (see [Removing the Battery](#)).
8. Turn the computer top-side up, open the display, and press the power button to ground the system board.

 **CAUTION:** Before touching anything inside your computer, ground yourself by touching an unpainted metal surface, such as the metal at the back of the computer. While you work, periodically touch an unpainted metal surface to dissipate static electricity, which could harm internal components.

[Back to Contents Page](#)

Flashing the BIOS

Dell™ XPS™ L502X Service Manual

The BIOS may require flashing when an update is available or when replacing the system board. To flash the BIOS:

1. Turn on the computer.
2. Go to support.dell.com/support/downloads.
3. Locate the BIOS update file for your computer:

 **NOTE:** The Service Tag for your computer is located on a label at the bottom of your computer.

If you have your computer's Service Tag:

- a. Click **Enter a Tag**.
- b. Enter your computer's Service Tag in the **Enter a service tag:** field, click **Go**, and proceed to [step 4](#).

If you do not have your computer's Service Tag:

- a. Click **Select Model**.
- b. Select the type of product in the **Select Your Product Family** list.
- c. Select the product brand in the **Select Your Product Line** list.
- d. Select the product model number in the **Select Your Product Model** list.

 **NOTE:** If you have selected a different model and want to start over again, click **Start Over** on the top right of the menu.

- e. Click **Confirm**.
4. A list of results appear on the screen. Click **BIOS**.
5. Click **Download Now** to download the latest BIOS file.
The **File Download** window appears.
6. Click **Save** to save the file on your desktop. The file downloads to your desktop.
7. Click **Close** if the **Download Complete** window appears.
The file icon appears on your desktop and is titled the same as the downloaded BIOS update file.
8. Double-click the file icon on the desktop and follow the instructions on the screen.

Camera Module

Dell™ XPS™ L502X Service Manual

- [Removing the Camera Module](#)
- [Replacing the Camera Module](#)

- ⚠ **WARNING:** Before working inside your computer, read the safety information that shipped with your computer. For additional safety best practices information, see the Regulatory Compliance Homepage at www.dell.com/regulatory_compliance.
 - ⚠ **CAUTION:** Only a certified service technician should perform repairs on your computer. Damage due to servicing that is not authorized by Dell™ is not covered by your warranty.
 - ⚠ **CAUTION:** To avoid electrostatic discharge, ground yourself by using a wrist grounding strap or by periodically touching an unpainted metal surface (such as a connector on your computer).
 - ⚠ **CAUTION:** To help prevent damage to the system board, remove the main battery (see [Removing the Battery](#)) before working inside the computer.
-

Removing the Camera Module

1. Follow the instructions in [Before You Begin](#).
2. Remove the battery (see [Removing the Battery](#)).
3. Remove the module cover (see [Removing the Module Cover](#)).
4. Remove the memory module(s) (see [Removing the Memory Module\(s\)](#)).
5. Remove the palm-rest assembly (see [Removing the Palm-Rest Assembly](#)).
6. Remove the keyboard (see [Removing the Keyboard](#)).
7. Remove the display assembly (see [Removing the Display Assembly](#)).
8. Remove the display bezel (see [Removing the Display Bezel](#)).
9. Disconnect the camera cable from the connector on the camera module.

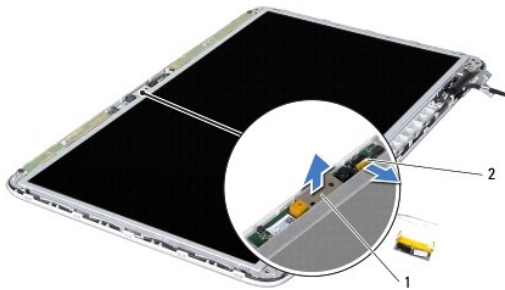

1	camera module	2	camera cable connector
---	---------------	---	------------------------

10. Gently pry the camera module off the aluminium foil.
-

Replacing the Camera Module

1. Follow the instructions in [Before You Begin](#).
2. Adhere the camera module to the aluminium foil.

3. Use the alignment posts on the display back cover to place the camera module in position.
4. Connect the camera cable to the connector on the camera module.
5. Replace the display bezel (see [Replacing the Display Bezel](#)).
6. Replace the display assembly (see [Replacing the Display Assembly](#)).
7. Replace the keyboard (see [Replacing the Keyboard](#)).
8. Replace the palm-rest assembly (see [Replacing the Palm-Rest Assembly](#)).
9. Replace the memory module(s) (see [Replacing the Memory Module\(s\)](#)).
10. Replace the module cover (see [Replacing the Module Cover](#)).
11. Replace the battery (see [Replacing the Battery](#)).

 **CAUTION:** Before turning on the computer, replace all screws and ensure that no stray screws remain inside the computer. Failure to do so may result in damage to the computer.

[Back to Contents Page](#)

Coin-Cell Battery

Dell™ XPS™ L502X Service Manual

- [Removing the Coin-Cell Battery](#)
- [Replacing the Coin-Cell Battery](#)

- ⚠ WARNING:** Before working inside your computer, read the safety information that shipped with your computer. For additional safety best practices information, see the Regulatory Compliance Homepage at www.dell.com/regulatory_compliance.
- ⚠ CAUTION:** Only a certified service technician should perform repairs on your computer. Damage due to servicing that is not authorized by Dell™ is not covered by your warranty.
- ⚠ CAUTION:** To avoid electrostatic discharge, ground yourself by using a wrist grounding strap or by periodically touching an unpainted metal surface (such as a connector on your computer).
- ⚠ CAUTION:** To help prevent damage to the system board, remove the main battery (see [Removing the Battery](#)) before working inside the computer.
-

Removing the Coin-Cell Battery

1. Follow the instructions in [Before You Begin](#).
2. Remove the battery (see [Removing the Battery](#)).
3. Remove the palm-rest assembly (see [Removing the Palm-Rest Assembly](#)).
4. Using a plastic scribe, gently pry the coin-cell battery out of the battery socket on the system board.



1	coin-cell battery	2	plastic scribe
---	-------------------	---	----------------

Replacing the Coin-Cell Battery

1. Follow the instructions in [Before You Begin](#).
2. With the positive side facing up, snap the coin-cell battery into the battery socket on the system board.
3. Replace the palm-rest assembly (see [Replacing the Palm-Rest Assembly](#)).
4. Replace the battery (see [Replacing the Battery](#)).

- ⚠ CAUTION:** Before turning on the computer, replace all screws and ensure that no stray screws remain inside the computer. Failure to do so may result in damage to the computer.
-

USB Board

Dell™ XPS™ L502X Service Manual

- [Removing the USB Board](#)
- [Replacing the USB Board](#)

- ⚠ WARNING:** Before working inside your computer, read the safety information that shipped with your computer. For additional safety best practices information, see the Regulatory Compliance Homepage at www.dell.com/regulatory_compliance.
- ⚠ CAUTION:** Only a certified service technician should perform repairs on your computer. Damage due to servicing that is not authorized by Dell™ is not covered by your warranty.
- ⚠ CAUTION:** To avoid electrostatic discharge, ground yourself by using a wrist grounding strap or by periodically touching an unpainted metal surface (such as a connector on your computer).
- ⚠ CAUTION:** To help prevent damage to the system board, remove the main battery (see [Removing the Battery](#)) before working inside the computer.
-

Removing the USB Board

1. Follow the instructions in [Before You Begin](#).
2. Remove the battery (see [Removing the Battery](#)).
3. Remove the module cover (see [Removing the Module Cover](#)).
4. Remove the memory module(s) (see [Removing the Memory Module\(s\)](#)).
5. Remove the palm-rest assembly (see [Removing the Palm-Rest Assembly](#)).
6. Remove the keyboard (see [Removing the Keyboard](#)).
7. Remove the display assembly (see [Removing the Display Assembly](#)).
8. Follow the instructions from [step 9](#) to [step 14](#) in [Removing the Top Cover](#).
9. Remove the AC adapter connector (see [Removing the AC-Adapter Connector](#)).
10. Lift the connector latch and disconnect the USB-board cable from the connector on the USB board.
11. Remove the three screws that secure the USB board to the top cover.
12. Carefully ease the connectors on the USB board out of the slots on the top cover and lift the USB board off the top cover.

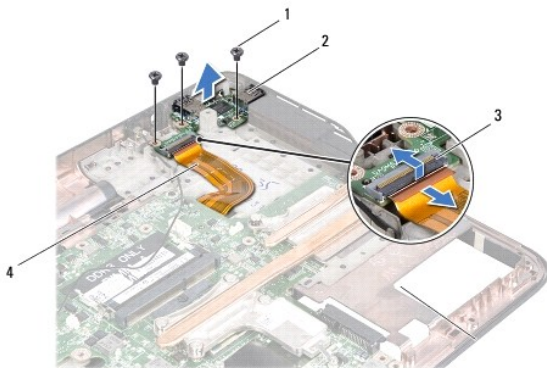

1	screws (3)	2	USB board
3	USB-board cable connector	4	USB-board cable

Replacing the USB Board

1. Follow the instructions in [Before You Begin](#).
2. Align the connectors on the USB board with the slots on the top cover and place it on the top cover.
3. Replace the three screws that secure the USB board to the top cover.
4. Slide the USB-board cable into the connector on the USB board and press the connector latch down to secure the cable.
5. Replace the AC adapter connector (see [Replacing the AC-Adapter Connector](#)).
6. Follow the instructions from [step 8](#) to [step 11](#) in [Replacing the Top Cover](#).
7. Replace the display assembly (see [Replacing the Display Assembly](#)).
8. Replace the keyboard (see [Replacing the Keyboard](#)).
9. Replace the palm-rest assembly (see [Replacing the Palm-Rest Assembly](#)).
10. Replace the memory module(s) (see [Replacing the Memory Module\(s\)](#)).
11. Replace the module cover (see [Replacing the Module Cover](#)).
12. Replace the battery (see [Replacing the Battery](#)).

 **CAUTION:** Before turning on the computer, replace all screws and ensure that no stray screws remain inside the computer. Failure to do so may result in damage to the computer.

[Back to Contents Page](#)

AC-Adapter Connector

Dell™ XPS™ L502X Service Manual

- [Removing the AC-Adapter Connector](#)
- [Replacing the AC-Adapter Connector](#)

- ⚠ WARNING:** Before working inside your computer, read the safety information that shipped with your computer. For additional safety best practices information, see the Regulatory Compliance Homepage at www.dell.com/regulatory_compliance.
- ⚠ CAUTION:** Only a certified service technician should perform repairs on your computer. Damage due to servicing that is not authorized by Dell™ is not covered by your warranty.
- ⚠ CAUTION:** To avoid electrostatic discharge, ground yourself by using a wrist grounding strap or by periodically touching an unpainted metal surface (such as a connector on your computer).
- ⚠ CAUTION:** To help prevent damage to the system board, remove the main battery (see [Removing the Battery](#)) before working inside the computer.
-

Removing the AC-Adapter Connector

1. Follow the instructions in [Before You Begin](#).
2. Remove the battery (see [Removing the Battery](#)).
3. Remove the module cover (see [Removing the Module Cover](#)).
4. Remove the memory module(s) (see [Removing the Memory Module\(s\)](#)).
5. Remove the palm-rest assembly (see [Removing the Palm-Rest Assembly](#)).
6. Remove the keyboard (see [Removing the Keyboard](#)).
7. Remove the display assembly (see [Removing the Display Assembly](#)).
8. Follow the instructions from [step 9](#) to [step 14](#) in [Removing the Top Cover](#).
9. Turn the top-cover assembly over.
10. Disconnect the AC-adapter connector cable from the connector on the system-board.
11. Make note of the AC-adapter connector cable routing and remove the cable from the routing guides.
12. Remove the screw that secures the AC-adapter connector to the top cover.

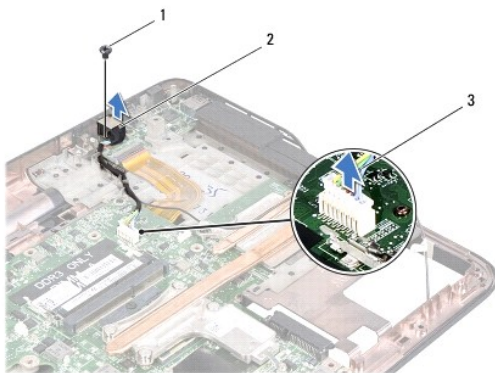

1	screw	2	AC adapter connector
3	AC-adapter connector cable		

13. Lift the AC-adapter connector off the base cover.
-

Replacing the AC-Adapter Connector

1. Follow the instructions in [Before You Begin](#).
2. Align the screw hole on the AC-adapter connector with the screw hole on the top cover.
3. Replace the screw that secures the AC-adapter connector to the top cover.
4. Route the AC-adapter connector cable through the routing guides.
5. Connect the AC-adapter connector cable to the system-board connector.
6. Follow the instructions from [step 8](#) to [step 11](#) in [Replacing the Top Cover](#).
7. Replace the display assembly (see [Replacing the Display Assembly](#)).
8. Replace the keyboard (see [Replacing the Keyboard](#)).
9. Replace the palm-rest assembly (see [Replacing the Palm-Rest Assembly](#)).
10. Replace the memory module(s) (see [Replacing the Memory Module\(s\)](#)).
11. Replace the module cover (see [Replacing the Module Cover](#)).
12. Replace the battery (see [Replacing the Battery](#)).

 **CAUTION:** Before turning on the computer, replace all screws and ensure that no stray screws remain inside the computer. Failure to do so may result in damage to the computer.

[Back to Contents Page](#)

Display

Dell™ XPS™ L502X Service Manual

- [Display Assembly](#)
- [Display Bezel](#)
- [Display Panel](#)
- [Display Cable](#)
- [Display-Panel Brackets](#)

- ⚠ WARNING:** Before working inside your computer, read the safety information that shipped with your computer. For additional safety best practices information, see the Regulatory Compliance Homepage at www.dell.com/regulatory_compliance.
- ⚠ CAUTION:** Only a certified service technician should perform repairs on your computer. Damage due to servicing that is not authorized by Dell™ is not covered by your warranty.
- ⚠ CAUTION:** To avoid electrostatic discharge, ground yourself by using a wrist grounding strap or by periodically touching an unpainted metal surface (such as a connector on your computer).
- ⚠ CAUTION:** To help prevent damage to the system board, remove the main battery (see [Removing the Battery](#)) before working inside the computer.
-

Display Assembly

Removing the Display Assembly

1. Follow the instructions in [Before You Begin](#).
2. Remove the battery (see [Removing the Battery](#)).
3. Remove the module cover (see [Removing the Module Cover](#)).
4. Remove the memory module(s) (see [Removing the Memory Module\(s\)](#)).
5. Disconnect the antenna cables from the Mini-Cards.
6. Note the routing of the Mini-Card antenna cables and remove them from the routing guides on base cover.
7. Remove the two screws that secure the display assembly to the base cover.

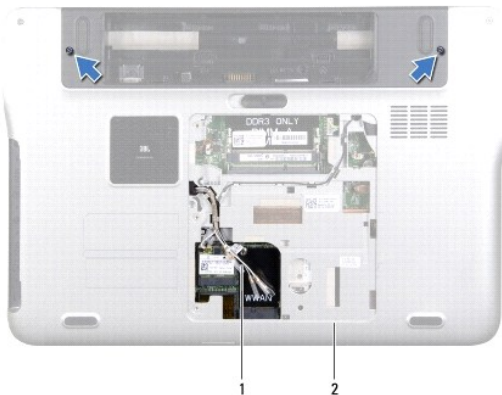

1	antenna cables	2	base cover
---	----------------	---	------------

- ⚠ CAUTION:** Be extremely careful when opening the display to prevent damaging the display assembly.

8. Remove the palm-rest assembly (see [Removing the Palm-Rest Assembly](#)).

9. Turn the computer over and open the display as far as possible.
10. Remove the keyboard (see [Removing the Keyboard](#)).
11. Pull the pull-tab to disconnect the display cable from the system-board connector.
12. Disconnect the digitizer board cable from the system-board connector.

NOTE: The digitizer board is optional and may not be present in your computer.

13. Loosen the captive screw that secures the display grounding cable.

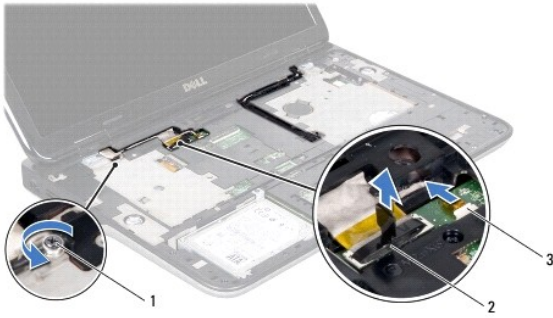

1	captive screw	2	display cable connector
3	digitizer board cable		

14. Note the routing of the display cable and remove the cable from the routing guides.
15. Note the routing of the Mini-Card antenna cables and remove them from the routing guides on the top cover.
16. Gently pull the antenna cables up from the bottom of the computer through the slot on the top cover.
17. Remove the four screws that secure the display assembly to the computer base.



1	display assembly	2	screws (4)
3	display cable	4	top cover
5	antenna cables		

18. Lift the display assembly off the computer base.

Replacing the Display Assembly

1. Follow the instructions in [Before You Begin](#).
2. Place the display assembly in position and replace the four screws that secure the display assembly to the computer base.
3. Route the display cable through the routing guides and connect the display cable to the system-board connector.
4. Connect the digitizer board cable to the system-board connector.
5. Tighten the captive screw that secures the display grounding cable.
6. Route the antenna cables through the routing guides on the top cover.
7. Slide the antenna cables to the bottom of the computer through the slot on the top cover.
8. Replace the keyboard (see [Replacing the Keyboard](#)).
9. Replace the palm-rest assembly (see [Replacing the Palm-Rest Assembly](#)).
10. Close the display and turn the computer over.
11. Route the antenna cables through the routing guides on the base cover.
12. Connect the antenna cables to the connectors on the Mini-Card.
13. Replace the memory module(s) (see [Replacing the Memory Module\(s\)](#)).
14. Replace the module cover (see [Replacing the Module Cover](#)).
15. Replace the battery (see [Replacing the Battery](#)).

 **CAUTION:** Before turning on the computer, replace all screws and ensure that no stray screws remain inside the computer. Failure to do so may result in damage to the computer.

Display Bezel

Removing the Display Bezel

 **CAUTION:** The display bezel is extremely fragile. Be careful when removing it to prevent damaging the bezel.

1. Follow the instructions in [Before You Begin](#).
2. Remove the display assembly (see [Removing the Display Assembly](#)).
3. Push the display bezel outwards to release it from the tabs that secure the display bezel to the back cover.
4. Using your fingertips, gently pry the outside edge of the display bezel off the back cover.
5. Lift the display bezel off the display assembly.



1	display bezel
---	---------------

Replacing the Display Bezel

1. Follow the instructions in [Before You Begin](#).
2. Align the display bezel with the display back cover, and gently snap it into place.
3. Replace the display assembly (see [Replacing the Display Assembly](#)).

CAUTION: Before turning on the computer, replace all screws and ensure that no stray screws remain inside the computer. Failure to do so may result in damage to the computer.

Display Panel

Removing the Display Panel

1. Follow the instructions in [Before You Begin](#).
2. Remove the display assembly (see [Removing the Display Assembly](#)).
3. Remove the display bezel (see [Removing the Display Bezel](#)).
4. Disconnect the camera cable from the connector on the camera module.
5. Pull the pull-tab to disconnect the digitizer board cable from the connector on the digitizer board.

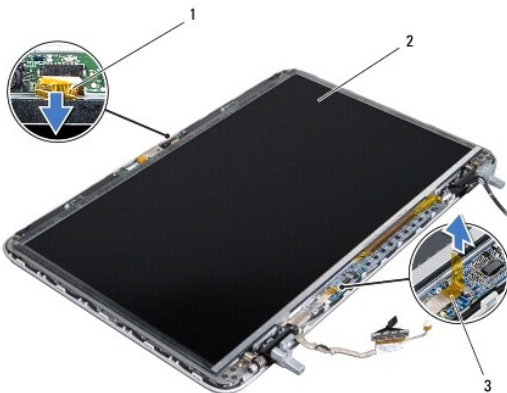

1	camera cable	2	display panel
3	digitizer board cable		

6. Remove the ten screws that secure the display panel to the display back cover.
7. Remove the two screws that secure the digitizer board to the display back cover.
8. Note the routing of the antenna cables and remove them from the routing guide on the right display hinge.
9. Note the routing of the display cable and remove it from the routing guide on the left display hinge.

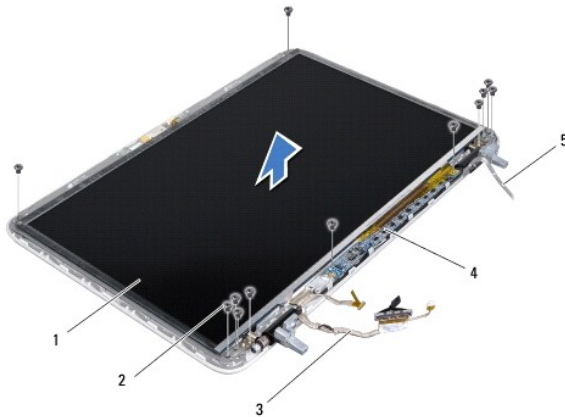

1	display panel	2	screws (12)
3	display cable	4	digitizer board
5	antenna cables		

10. Lift the display panel off the display back cover.

Replacing the Display Panel

1. Follow the instructions in [Before You Begin](#).
2. Place the display panel over the display back cover.
3. Route the display cable through the routing guide on the left display hinge.
4. Route the antenna cables through the routing guide on the right display hinge.
5. Replace the ten screws that secure the display panel to the display back cover.
6. Replace the two screws that secure the digitizer board to the display back cover.
7. Connect the camera cable to the connector on the camera module.
8. Connect the digitizer board cable to the connector on the digitizer board.
9. Replace the display bezel (see [Replacing the Display Bezel](#)).
10. Replace the display assembly (see [Replacing the Display Assembly](#)).

CAUTION: Before turning on the computer, replace all screws and ensure that no stray screws remain inside the computer. Failure to do so may result in damage to the computer.

Display Cable

Removing the Display Cable

1. Follow the instructions in [Before You Begin](#).
2. Remove the display assembly (see [Removing the Display Assembly](#)).
3. Remove the display bezel (see [Removing the Display Bezel](#)).
4. Remove the display panel (see [Removing the Display Panel](#)).
5. Turn the display panel over and place it on a clean surface.
6. Pull the pull-tab to disconnect the display cable from the connector on the display panel.

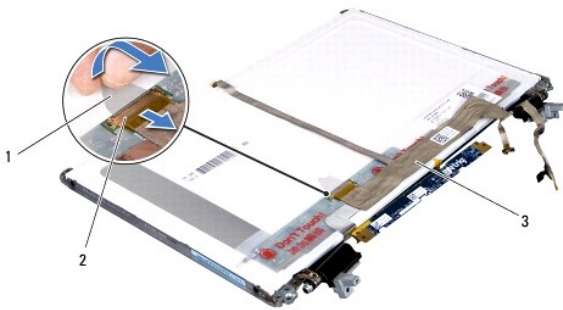

1	pull tab	2	display-cable connector
3	display cable		

7. Gently peel off the display cable from the display panel.

Replacing the Display Cable

1. Follow the instructions in [Before You Begin](#).
2. Adhere the display cable to the display panel.
3. Connect the display cable to the connector on the display panel.
4. Replace the display panel (see [Replacing the Display Panel](#)).
5. Replace the display bezel (see [Replacing the Display Bezel](#)).
6. Replace the display assembly ([Replacing the Display Assembly](#)).

CAUTION: Before turning on the computer, replace all screws and ensure that no stray screws remain inside the computer. Failure to do so may result in damage to the computer.

Display-Panel Brackets

Removing the Display-Panel Brackets

1. Follow the instructions in [Before You Begin](#).
2. Remove the display assembly (see [Removing the Display Assembly](#)).
3. Remove the display bezel (see [Removing the Display Bezel](#)).
4. Remove the display panel (see [Removing the Display Panel](#)).
5. Remove the four screws (two on each side) that secure the display-panel brackets to the display panel.
6. Remove the display-panel brackets off the display panel.



1	screws (4)	2	display panel brackets (2)
---	------------	---	----------------------------

Replacing the Display-Panel Brackets

1. Follow the instructions in [Before You Begin](#).
2. Place the display-panel brackets in position.
3. Replace the four screws (two on each side) that secure the display-panel brackets to the display panel.
4. Replace the display panel (see [Replacing the Display Panel](#)).
5. Replace the display bezel (see [Replacing the Display Bezel](#)).
6. Replace the display assembly ([Replacing the Display Assembly](#)).

CAUTION: Before turning on the computer, replace all screws and ensure that no stray screws remain inside the computer. Failure to do so may result in damage to the computer.

Fan

Dell™ XPS™ L502X Service Manual

- [Removing the Fan](#)
- [Replacing the Fan](#)

- ⚠ **WARNING:** Before working inside your computer, read the safety information that shipped with your computer. For additional safety best practices information, see the Regulatory Compliance Homepage at www.dell.com/regulatory_compliance.
 - ⚠ **CAUTION:** Only a certified service technician should perform repairs on your computer. Damage due to servicing that is not authorized by Dell™ is not covered by your warranty.
 - ⚠ **CAUTION:** To avoid electrostatic discharge, ground yourself by using a wrist grounding strap or by periodically touching an unpainted metal surface (such as a connector on your computer).
 - ⚠ **CAUTION:** To help prevent damage to the system board, remove the main battery (see [Removing the Battery](#)) before working inside the computer.
-

Removing the Fan

1. Follow the instructions in [Before You Begin](#).
2. Press and eject any installed cards from the Media Card Reader.
3. Remove the battery (see [Removing the Battery](#)).
4. Remove the module cover (see [Removing the Module Cover](#)).
5. Remove the memory module(s) (see [Removing the Memory Module\(s\)](#)).
6. Remove the palm-rest assembly (see [Removing the Palm-Rest Assembly](#)).
7. Remove the keyboard (see [Removing the Keyboard](#)).
8. Remove the display assembly (see [Removing the Display Assembly](#)).
9. Follow the instructions from [step 9](#) to [step 14](#) in [Removing the Top Cover](#).
10. Remove the two screws that secure the fan to the base cover.

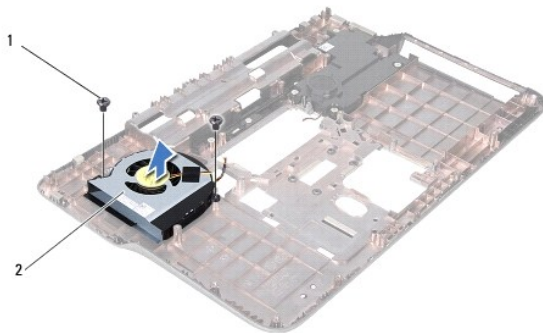

1	screws (2)	2	fan
---	------------	---	-----

11. Lift the fan off the base cover.
-

Replacing the Fan

1. Follow the instructions in [Before You Begin](#).

2. Place the fan on the base cover.
3. Replace the two screws that secure the fan to the base cover.
4. Follow the instructions from [step 8](#) to [step 11](#) in [Replacing the Top Cover](#).
5. Replace the display assembly (see [Replacing the Display Assembly](#)).
6. Replace the keyboard (see [Replacing the Keyboard](#)).
7. Replace the palm-rest assembly (see [Replacing the Palm-Rest Assembly](#)).
8. Replace the memory module(s) (see [Replacing the Memory Module\(s\)](#)).
9. Replace the module cover (see [Replacing the Module Cover](#)).
10. Replace the battery (see [Replacing the Battery](#)).

 **CAUTION:** Before turning on the computer, replace all screws and ensure that no stray screws remain inside the computer. Failure to do so may result in damage to the computer.

[Back to Contents Page](#)

Hard Drive

Dell™ XPS™ L502X Service Manual

- [Removing the Hard Drive](#)
- [Replacing the Hard Drive](#)

- ⚠ **WARNING:** Before working inside your computer, read the safety information that shipped with your computer. For additional safety best practices information, see the Regulatory Compliance Homepage at www.dell.com/regulatory_compliance.
- ⚠ **WARNING:** If you remove the hard drive from the computer when the drive is hot, do not touch the metal housing of the hard drive.
- ⚠ **CAUTION:** Only a certified service technician should perform repairs on your computer. Damage due to servicing that is not authorized by Dell™ is not covered by your warranty.
- ⚠ **CAUTION:** To avoid electrostatic discharge, ground yourself by using a wrist grounding strap or by periodically touching an unpainted metal surface (such as a connector on your computer).
- ⚠ **CAUTION:** To help prevent damage to the system board, remove the main battery (see [Removing the Battery](#)) before working inside the computer.
- ⚠ **CAUTION:** To prevent data loss, turn off your computer (see [Turning Off Your Computer](#)) before removing the hard drive assembly. Do not remove the hard drive while the computer is On or in Sleep state.
- ⚠ **CAUTION:** Hard drives are extremely fragile. Exercise care when handling the hard drive.
- 📌 **NOTE:** Dell does not guarantee compatibility or provide support for hard drives from sources other than Dell.
- 📌 **NOTE:** If you are installing a hard drive from a source other than Dell, you need to install an operating system, drivers, and utilities on the new hard drive.

Removing the Hard Drive

1. Follow the instructions in [Before You Begin](#).
2. Remove the battery (see [Removing the Battery](#)).
3. Remove the palm-rest assembly (see [Removing the Palm-Rest Assembly](#)).
4. Remove the four screws that secure the hard-drive assembly to the computer base.
5. Slide the hard-drive assembly to the side to disconnect it from the system board connector.
6. Lift the hard-drive assembly out of the hard-drive bay.

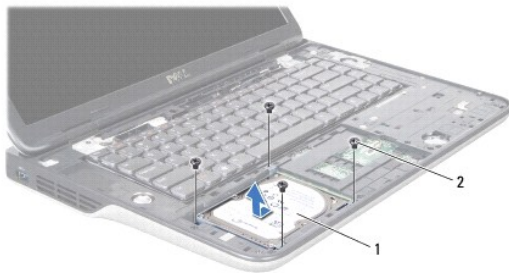

1	hard-drive assembly	2	screws (4)
---	---------------------	---	------------

7. Remove the four screws that secure the hard-drive bracket to the hard drive.
8. Lift the hard-drive bracket off the hard drive.

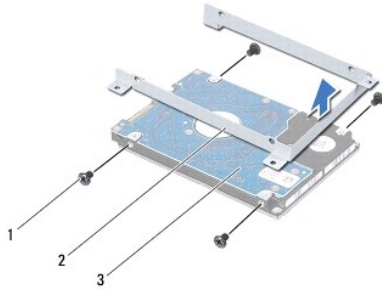

1	screws (4)	2	hard-drive bracket
3	hard drive		

CAUTION: When the hard drive is not in the computer, store it in protective antistatic packaging (see "Protecting Against Electrostatic Discharge" in the safety instructions that shipped with your computer).

Replacing the Hard Drive

1. Follow the instructions in [Before You Begin](#).
2. Remove the new hard drive from its packaging.
Save the original packaging for storing or shipping the hard drive.
3. Slide the hard drive into the hard-drive bracket.
4. Replace the four screws that secure the hard-drive bracket to the hard drive.
5. Place the hard-drive assembly in the hard-drive bay.
6. Slide the hard-drive assembly to connect it to the system board connector.
7. Replace the four screws that secure the hard-drive assembly to the computer base.
8. Replace the palm-rest assembly (see [Replacing the Palm-Rest Assembly](#)).
9. Replace the battery (see [Replacing the Battery](#)).

CAUTION: Before turning on the computer, replace all screws and ensure that no stray screws remain inside the computer. Failure to do so may result in damage to the computer.

[Back to Contents Page](#)

Heat Sink

Dell™ XPS™ L502X Service Manual

- [Removing the Heat Sink](#)
- [Replacing the Heat Sink](#)

- ⚠ **WARNING:** Before working inside your computer, read the safety information that shipped with your computer. For additional safety best practices information, see the Regulatory Compliance Homepage at www.dell.com/regulatory_compliance.
- ⚠ **WARNING:** If you remove the heat sink from the computer when the heat sink is hot, do not touch the metal housing of the heat sink.
- ⚠ **CAUTION:** Only a certified service technician should perform repairs on your computer. Damage due to servicing that is not authorized by Dell™ is not covered by your warranty.
- ⚠ **CAUTION:** To avoid electrostatic discharge, ground yourself by using a wrist grounding strap or by periodically touching an unpainted metal surface (such as a connector on your computer).
- ⚠ **CAUTION:** To help prevent damage to the system board, remove the main battery (see [Removing the Battery](#)) before working inside the computer.

Removing the Heat Sink

1. Follow the instructions in [Before You Begin](#).
2. Remove the battery (see [Removing the Battery](#)).
3. Remove the module cover (see [Removing the Module Cover](#)).
4. Remove the memory module(s) (see [Removing the Memory Module\(s\)](#)).
5. Remove the palm-rest assembly (see [Removing the Palm-Rest Assembly](#)).
6. Remove the keyboard (see [Removing the Keyboard](#)).
7. Remove the display assembly (see [Removing the Display Assembly](#)).
8. Follow the instructions from [step 9](#) to [step 14](#) in [Removing the Top Cover](#).
9. In sequential order (indicated on the heat sink), loosen the seven captive screws that secure the heat sink to the system board.

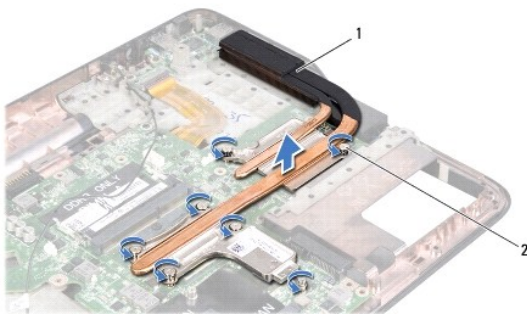

1	heat sink	2	captive screws (7)
---	-----------	---	--------------------

10. Carefully lift heat sink away from the top cover.

Replacing the Heat Sink

- 🔧 **NOTE:** The original thermal grease can be reused if the original processor and heat sink are reinstalled together. If either the processor or the heat sink is replaced, use the thermal pad provided in the kit to ensure that thermal conductivity is achieved.

1. Follow the instructions in [Before You Begin](#).

2. Clean the thermal grease from the bottom of the heat sink and reapply it.
3. Align the seven captive screws on the heat sink with the screw holes on the system board and tighten the screws in sequential order (indicated on the heat sink).
4. Follow the instructions from [step 8](#) to [step 11](#) in [Replacing the Top Cover](#).
5. Replace the display assembly (see [Replacing the Display Assembly](#)).
6. Replace the keyboard (see [Replacing the Keyboard](#)).
7. Replace the palm-rest assembly (see [Replacing the Palm-Rest Assembly](#)).
8. Replace the memory module(s) (see [Replacing the Memory Module\(s\)](#)).
9. Replace the module cover (see [Replacing the Module Cover](#)).
10. Replace the battery (see [Replacing the Battery](#)).

 **CAUTION:** Before turning on the computer, replace all screws and ensure that no stray screws remain inside the computer. Failure to do so may result in damage to the computer.

[Back to Contents Page](#)

[Back to Contents Page](#)

Keyboard

Dell™ XPS™ L502X Service Manual

- [Removing the Keyboard](#)
- [Replacing the Keyboard](#)

- ⚠ **WARNING:** Before working inside your computer, read the safety information that shipped with your computer. For additional safety best practices information, see the Regulatory Compliance Homepage at www.dell.com/regulatory_compliance.
- ⚠ **CAUTION:** Only a certified service technician should perform repairs on your computer. Damage due to servicing that is not authorized by Dell™ is not covered by your warranty.
- ⚠ **CAUTION:** To avoid electrostatic discharge, ground yourself by using a wrist grounding strap or by periodically touching an unpainted metal surface (such as a connector on your computer).
- ⚠ **CAUTION:** To help prevent damage to the system board, remove the main battery (see [Removing the Battery](#)) before working inside the computer.

Removing the Keyboard

1. Follow the instructions in [Before You Begin](#).
2. Remove the battery (see [Removing the Battery](#)).
3. Remove the palm-rest assembly (see [Removing the Palm-Rest Assembly](#)).
4. Push the tabs on the top cover to release the keyboard.



1	tabs (2)
---	----------

5. Carefully lift the keyboard and slide the keyboard tabs out of the slots on the top cover.
6. Lift the connector latch up and pull the pull-tab to disconnect the keyboard backlight cable from the system-board connector.



1	keyboard tabs (5)	2	keyboard backlight cable connector
---	-------------------	---	------------------------------------

- ⚠ **CAUTION:** The keycaps on the keyboard are fragile, easily dislodged, and time-consuming to replace. Be careful when removing and handling the keyboard.
- ⚠ **CAUTION:** Be extremely careful when removing and handling the keyboard. Failure to do so could result in scratching the display panel.

7. Turn the keyboard over and place it over the top cover as shown in the following illustration.
8. Lift the connector latch and disconnect the keyboard cable from the system-board connector.

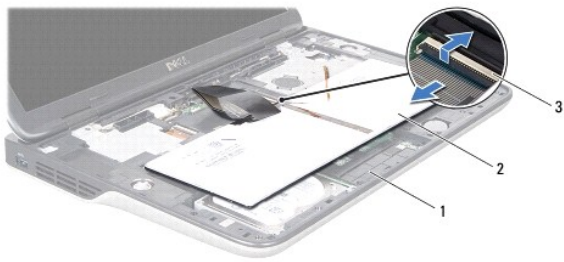

1	top cover	2	keyboard
3	keyboard cable connector		

9. Lift the keyboard off the top cover.

Replacing the Keyboard

1. Follow the instructions in [Before You Begin](#).
2. Slide the keyboard cable into the system-board connector and press down on the connector latch to secure the cable.
3. Slide the keyboard backlight cable into the system-board connector and press down on the connector latch to secure the cable.
4. Slide the tabs on the keyboard into the slots on the top cover and lower the keyboard into place.
5. Gently press the top of the keyboard to secure it to the tabs on the top cover.
6. Replace the palm-rest assembly (see [Replacing the Palm-Rest Assembly](#)).
7. Replace the battery (see [Replacing the Battery](#)).

CAUTION: Before turning on the computer, replace all screws and ensure that no stray screws remain inside the computer. Failure to do so may result in damage to the computer.

[Back to Contents Page](#)

[Back to Contents Page](#)

Memory Module(s)

Dell™ XPS™ L502X Service Manual

- [Removing the Memory Module\(s\)](#)
- [Replacing the Memory Module\(s\)](#)

- ⚠ **WARNING:** Before working inside your computer, read the safety information that shipped with your computer. For additional safety best practices information, see the Regulatory Compliance Homepage at www.dell.com/regulatory_compliance.
- ⚠ **CAUTION:** Only a certified service technician should perform repairs on your computer. Damage due to servicing that is not authorized by Dell™ is not covered by your warranty.
- ⚠ **CAUTION:** To avoid electrostatic discharge, ground yourself by using a wrist grounding strap or by periodically touching an unpainted metal surface (such as a connector on your computer).
- ⚠ **CAUTION:** To help prevent damage to the system board, remove the main battery (see [Removing the Battery](#)) before working inside the computer.

You can increase your computer memory by installing memory modules on the system board. See "Specifications" in the *Setup Guide* that shipped with your computer or at support.dell.com/manuals for information on the type of memory supported by your computer.

📌 **NOTE:** Memory modules purchased from Dell are covered under your computer warranty.

Your computer has two user-accessible SODIMM connectors.

Removing the Memory Module(s)

1. Follow the instructions in [Before You Begin](#).
2. Remove the battery (see [Removing the Battery](#)).
3. Remove the module cover (see [Removing the Module Cover](#)).

- ⚠ **CAUTION:** To help prevent damage to the memory-module connector, do not use tools to spread the memory module securing clips.
4. Use your fingertips to carefully spread apart the securing clips on each end of the memory-module connector until the memory module pops up.

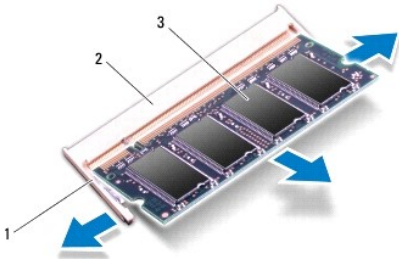

1	securing clip	2	memory-module connector
3	memory-module		

5. Remove the memory module from the memory-module connector.

Replacing the Memory Module(s)

- ⚠ **CAUTION:** If you need to install memory modules in two connectors, install a memory module in the lower connector before you install a memory module in the upper connector.

1. Follow the instructions in [Before You Begin](#).
2. Align the notch in the memory module with the tab in the memory-module connector.
3. Slide the memory module firmly into the memory-module connector at a 45-degree angle, and press the memory module down until it clicks into place. If you do not hear the click, remove the memory module and reinstall it.

 **NOTE:** If the memory module is not installed properly, the computer may not boot.

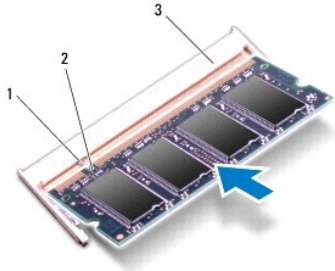



1	tab	2	notch
3	memory-module connector		

4. Replace the module cover (see [Replacing the Module Cover](#)).
5. Replace the battery (see [Replacing the Battery](#)).
6. Connect the AC adapter to your computer and an electrical outlet.
7. Turn on the computer.

As the computer boots, it detects the additional memory and automatically updates the system configuration information.

To confirm the amount of memory installed in the computer:

Click **Start**  → **Control Panel** → **System and Security** → **System**.

 **CAUTION:** Before turning on the computer, replace all screws and ensure that no stray screws remain inside the computer. Failure to do so may result in damage to the computer.

[Back to Contents Page](#)

Wireless Mini-Card(s)

Dell™ XPS™ L502X Service Manual

- [Removing the Mini-Card\(s\)](#)
- [Replacing the Mini-Card\(s\)](#)

- WARNING:** Before working inside your computer, read the safety information that shipped with your computer. For additional safety best practices information, see the Regulatory Compliance Homepage at www.dell.com/regulatory_compliance.
- CAUTION:** Only a certified service technician should perform repairs on your computer. Damage due to servicing that is not authorized by Dell™ is not covered by your warranty.
- CAUTION:** To avoid electrostatic discharge, ground yourself by using a wrist grounding strap or by periodically touching an unpainted metal surface (such as a connector on your computer).
- CAUTION:** To help prevent damage to the system board, remove the main battery (see [Removing the Battery](#)) before working inside the computer.
- NOTE:** Dell does not guarantee compatibility or provide support for Mini-Cards from sources other than Dell.

If you ordered a wireless Mini-Card with your computer, the card is already installed.

Your computer has one full Mini-Card slot and one half Mini-Card slot:

- 1 One full Mini-Card slot — supports a Wireless Wide Area Network (WWAN) or TV tuner module.
- 1 One half Mini-Card slot — supports a Wireless Local Area Network (WLAN) and bluetooth combo card or Worldwide Interoperability for Microwave Access (WiMax) card.

- NOTE:** Depending on the configuration of the computer when it was sold, the Mini-Card slot may or may not have a Mini-Card installed.

Removing the Mini-Card(s)

1. Follow the instructions in [Before You Begin](#).
2. Remove the battery (see [Removing the Battery](#)).
3. Remove the module cover (see [Removing the Module Cover](#)).
4. Disconnect the antenna cables from the Mini-Card(s).
5. Remove the screw that secures the Mini-Card to the system board.

- NOTE:** Your computer can only support either a WWAN Mini-Card or a TV tuner module in the full Mini-Card slot at a time.

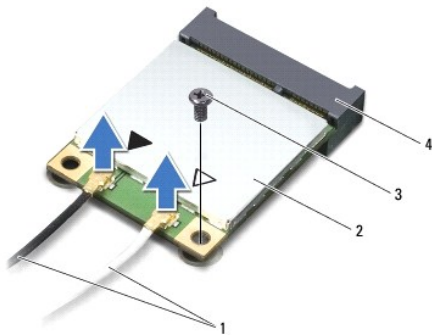

1	antenna cables (2)	2	Mini-Card
3	screw	4	system-board connector

6. Lift the Mini-Card(s) out of the system-board connector.

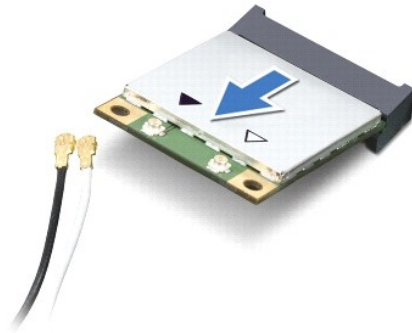

CAUTION: When the Mini-Card is not in the computer, store it in protective antistatic packaging. For more information, see "Protecting Against Electrostatic Discharge" in the safety information that shipped with your computer.

Replacing the Mini-Card(s)

1. Follow the instructions in [Before You Begin](#).
2. Remove the new Mini-Card from its packaging.

CAUTION: Use firm and even pressure to slide the card into place. If you use excessive force, you may damage the connector.

CAUTION: The connectors are keyed to ensure correct insertion. If you feel resistance, check the connectors on the card and on the system board, and realign the card.

CAUTION: To avoid damage to the Mini-Card, never place cables under the card.

3. Insert the Mini-Card connector at a 45-degree angle into the system-board connector.
4. Press the other end of the Mini-Card down into the slot on the system board and replace the screw that secures the Mini-Card to the system board.
5. Connect the appropriate antenna cables to the Mini-Card you are installing. The following table provides the antenna cable color scheme for the Mini-Cards supported by your computer.

Connectors on the Mini-Card	Antenna Cable Color Scheme
WLAN + Bluetooth (2 antenna cables)	
Main WLAN + Bluetooth (white triangle)	white
Auxiliary WLAN + Bluetooth (black triangle)	black
WWAN (2 antenna cables)	
Main WWAN (white triangle)	white
Auxiliary WWAN (black triangle)	black
TV tuner (1 antenna cable)	black

6. Replace the module cover (see [Replacing the Module Cover](#)).
7. Replace the battery (see [Replacing the Battery](#)).

CAUTION: Before turning on the computer, replace all screws and ensure that no stray screws remain inside the computer. Failure to do so may result in damage to the computer.

8. Install the drivers and utilities for your computer, as required.

NOTE: If you are installing a communication card from a source other than Dell, you must install the appropriate drivers and utilities.

Module Cover

Dell™ XPS™ L502X Service Manual

- [Removing the Module Cover](#)
- [Replacing the Module Cover](#)

- ⚠ WARNING:** Before working inside your computer, read the safety information that shipped with your computer. For additional safety best practices information, see the Regulatory Compliance Homepage at www.dell.com/regulatory_compliance.
- ⚠ CAUTION:** Only a certified service technician should perform repairs on your computer. Damage due to servicing that is not authorized by Dell™ is not covered by your warranty.
- ⚠ CAUTION:** To avoid electrostatic discharge, ground yourself by using a wrist grounding strap or by periodically touching an unpainted metal surface (such as a connector on your computer).
- ⚠ CAUTION:** To avoid damage to the computer, use only the battery designed for this particular Dell computer. Do not use batteries designed for other Dell computers.
-

Removing the Module Cover

1. Follow the instructions in [Before You Begin](#).
2. Remove the battery (see [Removing the Battery](#)).
3. Loosen the three captive screws that secure the module cover to the base cover.
4. Using your fingertips, release the tabs on the module cover from the slots on the base cover.
5. Lift the module cover off the base cover.

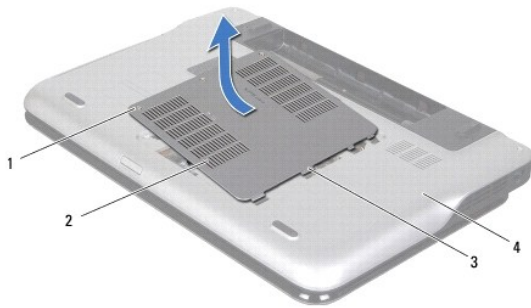

1	screws (3)	2	module cover
3	tabs (4)	4	base cover

Replacing the Module Cover

- ⚠ CAUTION:** To avoid damage to the computer, use only the battery designed for this particular Dell computer.

1. Follow the instructions in [Before You Begin](#).
 2. Align the tabs on the module cover with the slots on the base cover and snap the module cover into place.
 3. Tighten the three captive screws that secure the module cover to the base cover.
 4. Replace the battery (see [Replacing the Battery](#)).
-

Optical Drive

Dell™ XPS™ L502X Service Manual

- [Removing the Optical Drive](#)
- [Replacing the Optical Drive](#)

- ⚠ WARNING:** Before working inside your computer, read the safety information that shipped with your computer. For additional safety best practices information, see the Regulatory Compliance Homepage at www.dell.com/regulatory_compliance.
- ⚠ CAUTION:** Only a certified service technician should perform repairs on your computer. Damage due to servicing that is not authorized by Dell™ is not covered by your warranty.
- ⚠ CAUTION:** To avoid electrostatic discharge, ground yourself by using a wrist grounding strap or by periodically touching an unpainted metal surface (such as a connector on your computer).
- ⚠ CAUTION:** To help prevent damage to the system board, remove the main battery (see [Removing the Battery](#)) before working inside the computer.
-

Removing the Optical Drive

1. Follow the instructions in [Before You Begin](#).
2. Remove the battery (see [Removing the Battery](#)).
3. Remove the module cover (see [Removing the Module Cover](#)).
4. Remove the memory module(s) (see [Removing the Memory Module\(s\)](#)).
5. Remove the screw that secures the optical drive to the base cover.
6. Using a plastic scribe, push the optical drive bracket to slide the optical drive out.
7. Slide the optical drive out of the optical-drive bay.

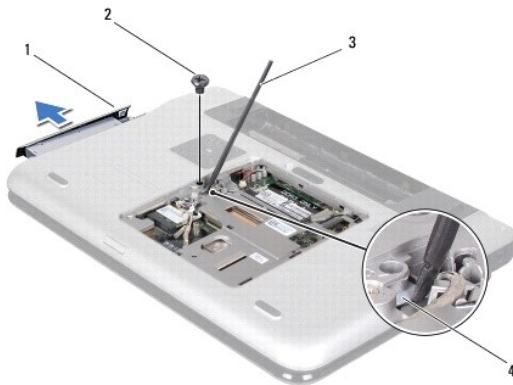

1	optical drive	2	screw
3	plastic scribe	4	optical-drive bracket

Replacing the Optical Drive

1. Follow the instructions in [Before You Begin](#).
2. Remove the new optical drive from its packaging.
3. Slide the optical drive into the optical-drive bay until it is fully seated.

4. Replace the screw that secures the optical drive to the base cover.
5. Replace the memory module(s) (see [Replacing the Memory Module\(s\)](#)).
6. Replace the module cover (see [Replacing the Module Cover](#)).
7. Replace the battery (see [Replacing the Battery](#)).

 **CAUTION:** Before turning on the computer, replace all screws and ensure that no stray screws remain inside the computer. Failure to do so may result in damage to the computer.

[Back to Contents Page](#)

Palm-Rest Assembly

Dell™ XPS™ L502X Service Manual

- [Removing the Palm-Rest Assembly](#)
- [Replacing the Palm-Rest Assembly](#)

- ⚠ WARNING:** Before working inside your computer, read the safety information that shipped with your computer. For additional safety best practices information, see the Regulatory Compliance Homepage at www.dell.com/regulatory_compliance.
- ⚠ CAUTION:** Only a certified service technician should perform repairs on your computer. Damage due to servicing that is not authorized by Dell™ is not covered by your warranty.
- ⚠ CAUTION:** To avoid electrostatic discharge, ground yourself by using a wrist grounding strap or by periodically touching an unpainted metal surface (such as a connector on your computer).
- ⚠ CAUTION:** To help prevent damage to the system board, remove the main battery (see [Removing the Battery](#)) before working inside the computer.
-

Removing the Palm-Rest Assembly

1. Follow the instructions in [Before You Begin](#).
2. Remove the battery (see [Removing the Battery](#)).
3. Remove the screw that secures the palm-rest assembly to the base cover.
4. Release and push the palm-rest assembly tabs off the base cover.

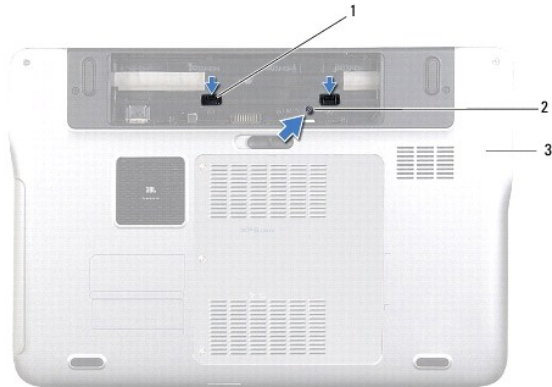

1	palm-rest assembly tabs (2)	2	screw
3	base cover		

5. Turn the computer over and open the display as far as possible.
6. Using a plastic scribe, gently ease the palm-rest assembly from the top cover.



1	plastic scribe	2	top cover
3	palm-rest assembly		

CAUTION: Carefully separate the palm-rest assembly from the top cover to avoid damage to the palm-rest assembly.

- Without pulling hard on the palm-rest assembly, place it away from the display as shown in the following illustration.
- Lift the connector latches and pull the pull-tabs to disconnect the touch-pad cable and the power button cable from their system-board connectors.
- Lift the palm-rest assembly off the top cover.

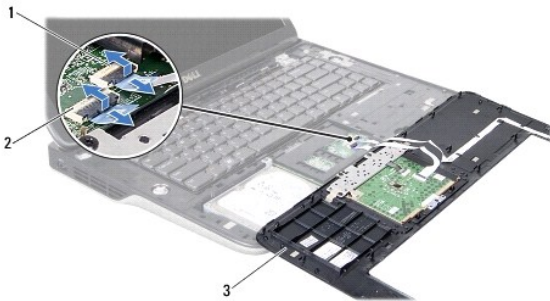

1	power-button cable connector	2	touch-pad cable connector
3	palm-rest assembly		

Replacing the Palm-Rest Assembly

- Follow the instructions in [Before You Begin](#).
- Slide the touch-pad cable and the power button cable into their system-board connectors and press down on the connector latches to secure the cables.
- Align the tabs on the palm-rest assembly with the slots on the top cover and gently snap the palm-rest assembly into place.
- Close the display and turn the computer over.
- Replace the screw that secures the palm-rest assembly to the base cover.
- Replace the battery (see [Replacing the Battery](#)).

CAUTION: Before turning on the computer, replace all screws and ensure that no stray screws remain inside the computer. Failure to do so may result in damage to the computer.

Processor Module

Dell™ XPS™ L502X Service Manual

- [Removing the Processor Module](#)
- [Replacing the Processor Module](#)

- ⚠ **WARNING:** Before working inside your computer, read the safety information that shipped with your computer. For additional safety best practices information, see the Regulatory Compliance Homepage at www.dell.com/regulatory_compliance.
 - ⚠ **CAUTION:** Only a certified service technician should perform repairs on your computer. Damage due to servicing that is not authorized by Dell™ is not covered by your warranty.
 - ⚠ **CAUTION:** To avoid electrostatic discharge, ground yourself by using a wrist grounding strap or by periodically touching an unpainted metal surface (such as a connector on your computer).
 - ⚠ **CAUTION:** To help prevent damage to the system board, remove the main battery (see [Removing the Battery](#)) before working inside the computer.
-

Removing the Processor Module

1. Follow the instructions in [Before You Begin](#).
2. Remove the battery (see [Removing the Battery](#)).
3. Remove the module cover (see [Removing the Module Cover](#)).
4. Remove the memory module(s) (see [Removing the Memory Module\(s\)](#)).
5. Remove the palm-rest assembly (see [Removing the Palm-Rest Assembly](#)).
6. Remove the keyboard (see [Removing the Keyboard](#)).
7. Remove the display assembly (see [Removing the Display Assembly](#)).
8. Follow the instructions from [step 9](#) to [step 14](#) in [Removing the Top Cover](#).
9. Remove the heat sink (see [Removing the Heat Sink](#)).



⚠ **CAUTION:** To prevent intermittent contact between the ZIF-socket cam screw and the processor when removing or replacing the processor, press to apply slight pressure to the centre of the processor while turning the cam screw.

⚠ **CAUTION:** To avoid damage to the processor, hold the screwdriver so that it is perpendicular to the processor when turning the cam screw.

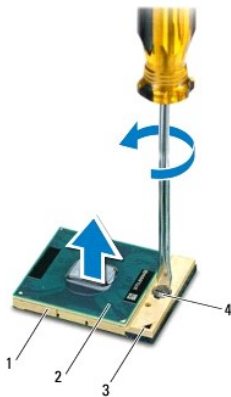
10. To loosen the ZIF socket, use a small, flat-blade screwdriver and rotate the ZIF-socket cam screw counterclockwise until it comes to the cam stop.



1	ZIF socket	2	processor module
3	pin-1 corner	4	ZIF-socket cam screw

-  **CAUTION:** To ensure maximum cooling for the processor module, do not touch the heat transfer areas on the processor thermal-cooling assembly. The oils in your skin can reduce the heat transfer capability of the thermal pads.
-  **CAUTION:** When removing the processor module, pull the module straight up. Be careful not to bend the pins on the processor module.

11. Lift the processor module off the ZIF socket.
-

Replacing the Processor Module

 **NOTE:** If a new processor module is installed, you will receive a new thermal cooling assembly, which will include an affixed thermal pad, or you will receive a new thermal pad along with documentation to illustrate proper installation.

1. Follow the instructions in [Before You Begin](#).
2. Align the pin-1 corner of the processor module with the pin-1 corner of the ZIF socket.

 **NOTE:** The pin-1 corner of the processor module has a triangle that aligns with the triangle on the pin-1 corner of the ZIF socket.

3. Place the processor module lightly in the ZIF socket and ensure that the processor module is positioned correctly.

 **CAUTION:** To avoid damage to the processor module, hold the screwdriver perpendicular to the processor module when turning the cam screw.

4. Tighten the ZIF socket by turning the cam screw clockwise to secure the processor module to the system board.
5. Replace the heat sink (see [Replacing the Heat Sink](#)).
6. Follow the instructions from [step 8](#) to [step 11](#) in [Replacing the Top Cover](#).
7. Replace the display assembly (see [Replacing the Display Assembly](#)).
8. Replace the keyboard (see [Replacing the Keyboard](#)).
9. Replace the palm-rest assembly (see [Replacing the Palm-Rest Assembly](#)).
10. Replace the memory module(s) (see [Replacing the Memory Module\(s\)](#)).
11. Replace the module cover (see [Replacing the Module Cover](#)).
12. Replace the battery (see [Replacing the Battery](#)).

 **CAUTION:** Before turning on the computer, replace all screws and ensure that no stray screws remain inside the computer. Failure to do so may result in damage to the computer.

[Back to Contents Page](#)

Power-Button Board

Dell™ XPS™ L502X Service Manual

- [Removing the Power-Button Board](#)
- [Replacing the Power-Button Board](#)

- ⚠ WARNING:** Before working inside your computer, read the safety information that shipped with your computer. For additional safety best practices information, see the Regulatory Compliance Homepage at www.dell.com/regulatory_compliance.
- ⚠ CAUTION:** Only a certified service technician should perform repairs on your computer. Damage due to servicing that is not authorized by Dell™ is not covered by your warranty.
- ⚠ CAUTION:** To avoid electrostatic discharge, ground yourself by using a wrist grounding strap or by periodically touching an unpainted metal surface (such as a connector on your computer).
- ⚠ CAUTION:** To help prevent damage to the system board, remove the main battery (see [Removing the Battery](#)) before working inside the computer.
-

Removing the Power-Button Board

1. Follow the instructions in [Before You Begin](#).
2. Remove the battery (see [Removing the Battery](#)).
3. Remove the palm-rest assembly (see [Removing the Palm-Rest Assembly](#)).
4. Turn the palm-rest assembly over.
5. Lift the connector latch and pull the pull-tab to disconnect the power-button cable from the connector on the power-button board.
6. Remove the two screws that secure the power-button board to the palm-rest assembly.
7. Lift the power-button board off the palm-rest assembly.

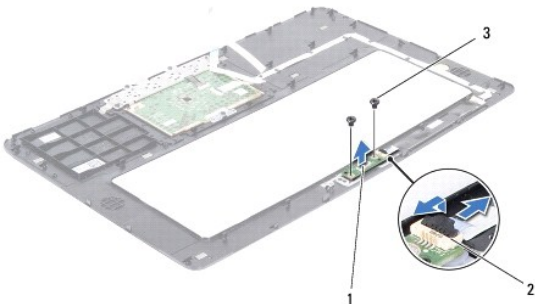

1	power-button board	2	power-button cable connector
3	screws (2)		

Replacing the Power-Button Board

1. Follow the instructions in [Before You Begin](#).
2. Place the power-button board on the palm-rest assembly and replace the two screws that secure the power-button board to the palm-rest assembly.
3. Slide the power-button cable into the connector on the power-button board and press down on the connector latch to secure the power-button cable.
4. Replace the palm-rest assembly (see [Replacing the Palm-Rest Assembly](#)).
5. Replace the battery (see [Replacing the Battery](#)).

 **CAUTION:** Before turning on the computer, replace all screws and ensure that no stray screws remain inside the computer. Failure to do so may result in damage to the computer.

[Back to Contents Page](#)

Speakers

Dell™ XPS™ L502X Service Manual

- [Removing the Speakers](#)
- [Replacing the Speakers](#)

- ⚠ WARNING:** Before working inside your computer, read the safety information that shipped with your computer. For additional safety best practices information, see the Regulatory Compliance Homepage at www.dell.com/regulatory_compliance.
- ⚠ CAUTION:** Only a certified service technician should perform repairs on your computer. Damage due to servicing that is not authorized by Dell™ is not covered by your warranty.
- ⚠ CAUTION:** To avoid electrostatic discharge, ground yourself by using a wrist grounding strap or by periodically touching an unpainted metal surface (such as a connector on your computer).
- ⚠ CAUTION:** To help prevent damage to the system board, remove the main battery (see [Removing the Battery](#)) before working inside the computer.
-

Removing the Speakers

1. Follow the instructions in [Before You Begin](#).
2. Remove the system board (see [Removing the System Board](#)).
3. Make note of the speakers cable routing and remove the cable from the routing guides.
4. Remove the four screws (two on each speaker) that secure the speakers to the top cover.

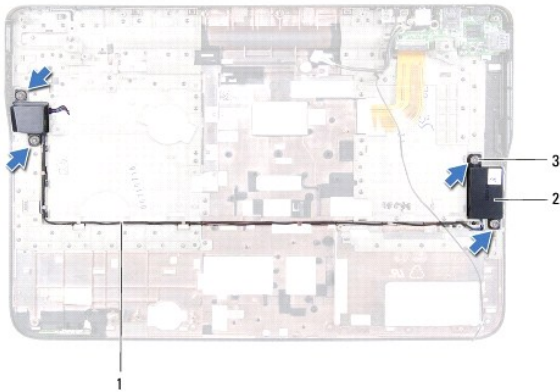

1	speaker cable routing	2	speakers (2)
3	screws (4)		

5. Lift the speakers along with its cable off the top cover.
-

Replacing the Speakers

1. Follow the instructions in [Before You Begin](#).
2. Route the speakers cable through the routing guides.
3. Align the screw holes on the speakers with the screw holes on the top cover.
4. Replace the four screws (two on each speaker) that secure the speakers to the top cover.
5. Replace the system board (see [Replacing the System Board](#)).

△ **CAUTION:** Before turning on the computer, replace all screws and ensure that no stray screws remain inside the computer. Failure to do so may result in damage to the computer.

[Back to Contents Page](#)

[Back to Contents Page](#)

System Board

Dell™ XPS™ L502X Service Manual

- [Removing the System Board](#)
- [Replacing the System Board](#)
- [Entering the Service Tag in the BIOS](#)

- WARNING:** Before working inside your computer, read the safety information that shipped with your computer. For additional safety best practices information, see the Regulatory Compliance Homepage at www.dell.com/regulatory_compliance.
- CAUTION:** Only a certified service technician should perform repairs on your computer. Damage due to servicing that is not authorized by Dell™ is not covered by your warranty.
- CAUTION:** To avoid electrostatic discharge, ground yourself by using a wrist grounding strap or by periodically touching an unpainted metal surface (such as a connector on your computer).
- CAUTION:** To help prevent damage to the system board, remove the main battery (see [Removing the Battery](#)) before working inside the computer.
- CAUTION:** Handle components and cards by their edges, and avoid touching pins and contacts.

Removing the System Board

1. Follow the instructions in [Before You Begin](#).
2. Remove the battery (see [Removing the Battery](#)).
3. Remove the module cover (see [Removing the Module Cover](#)).
4. Remove the memory module(s) (see [Removing the Memory Module\(s\)](#)).
5. Remove the palm-rest assembly (see [Removing the Palm-Rest Assembly](#)).
6. Remove the keyboard (see [Removing the Keyboard](#)).
7. Remove the display assembly (see [Removing the Display Assembly](#)).
8. Follow the instructions from [step 9](#) to [step 14](#) in [Removing the Top Cover](#).
9. Disconnect the USB board cable and speaker cable from the connectors on the system board.

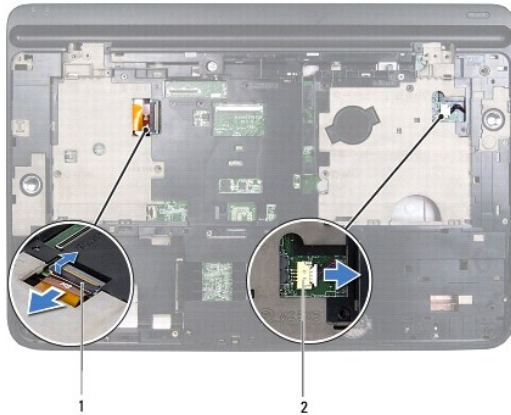

1	USB board cable connector	2	speaker cable connector
---	---------------------------	---	-------------------------

10. Turn the top cover over.
11. Remove the heat sink (see [Removing the Heat Sink](#)).
12. Remove the processor module (see [Removing the Processor Module](#)).

13. Disconnect the AC-adaptor cable from the connector on the system board.
14. Remove the six screws that secure the system board to the top cover.

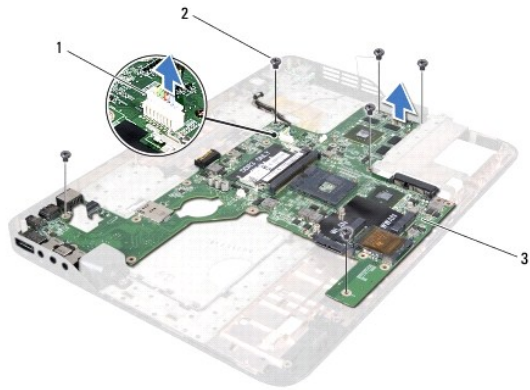

1	AC-adaptor connector	2	screws (6)
3	system board		

15. Carefully ease the connectors on the system board out of the slots on the top cover, and lift the system board off the top cover.

Replacing the System Board

1. Follow the instructions in [Before You Begin](#).
 2. Align the connectors on the system board with the slots on the top cover and place the system board on the top cover.
 3. Replace the six screws that secure the system board to the top cover.
 4. Connect the AC-adaptor cable to the connector on the system board.
 5. Replace the processor module (see [Replacing the Processor Module](#)).
 6. Replace the heat sink (see [Replacing the Heat Sink](#)).
 7. Turn the top cover over and connect the USB board cable and speaker cable to the connectors on the system board.
 8. Follow the instructions from [step 8](#) to [step 11](#) in [Replacing the Top Cover](#).
 9. Replace the display assembly (see [Replacing the Display Assembly](#)).
 10. Replace the keyboard (see [Replacing the Keyboard](#)).
 11. Replace the palm-rest assembly (see [Replacing the Palm-Rest Assembly](#)).
 12. Replace the memory module(s) (see [Replacing the Memory Module\(s\)](#)).
 13. Replace the module cover (see [Replacing the Module Cover](#)).
 14. Replace the battery (see [Replacing the Battery](#)).
- ⚠ CAUTION:** Before turning on the computer, replace all screws and ensure that no stray screws remain inside the computer. Failure to do so may result in damage to the computer.
15. Turn on the computer.

 **NOTE:** After you have replaced the system board, enter the computer Service Tag in the BIOS of the replacement system board.

16. Enter the service tag (see [Entering the Service Tag in the BIOS](#)).

Entering the Service Tag in the BIOS

1. Ensure that the AC adapter is plugged in and that the main battery is installed properly.
 2. Turn on the computer.
 3. Press <F2> during POST to enter the system setup program.
 4. Navigate to the security tab and enter the service tag in the **Set Service Tag** field.
-

[Back to Contents Page](#)

[Back to Contents Page](#)

Dell™ XPS™ L502X Service Manual



NOTE: A NOTE indicates important information that helps you make better use of your computer.



CAUTION: A CAUTION indicates potential damage to hardware or loss of data if instructions are not followed.



WARNING: A WARNING indicates a potential for property damage, personal injury, or death.

Information in this document is subject to change without notice.
© 2010 Dell Inc. All rights reserved.

Reproduction of these materials in any manner whatsoever without the written permission of Dell Inc. is strictly forbidden.

Trademarks used in this text: Dell™, the DELL logo, and XPS™ are trademarks of Dell Inc.; Microsoft®, Windows®, and the Windows start button logo  are either trademarks or registered trademarks of Microsoft Corporation in the United States and/or other countries; Bluetooth® is a registered trademark owned by Bluetooth SIG, Inc. and is used by Dell under license.

Other trademarks and trade names may be used in this document to refer to either the entities claiming the marks and names or their products. Dell Inc. disclaims any proprietary interest in trademarks and trade names other than its own.

[Back to Contents Page](#)

[Back to Contents Page](#)

Top Cover

Dell™ XPS™ L502X Service Manual

- [Removing the Top Cover](#)
- [Replacing the Top Cover](#)

- ⚠ **WARNING:** Before working inside your computer, read the safety information that shipped with your computer. For additional safety best practices information, see the Regulatory Compliance Homepage at www.dell.com/regulatory_compliance.
 - ⚠ **CAUTION:** Only a certified service technician should perform repairs on your computer. Damage due to servicing that is not authorized by Dell™ is not covered by your warranty.
 - ⚠ **CAUTION:** To avoid electrostatic discharge, ground yourself by using a wrist grounding strap or by periodically touching an unpainted metal surface (such as a connector on your computer).
 - ⚠ **CAUTION:** To help prevent damage to the system board, remove the main battery (see [Removing the Battery](#)) before working inside the computer.
-

Removing the Top Cover

1. Follow the instructions in [Before You Begin](#).
2. Press and eject any installed cards from the Media Card Reader.
3. Remove the battery (see [Removing the Battery](#)).
4. Remove the module cover (see [Removing the Module Cover](#)).
5. Remove the memory module(s) (see [Removing the Memory Module\(s\)](#)).
6. Remove the palm-rest assembly (see [Removing the Palm-Rest Assembly](#)).
7. Remove the keyboard (see [Removing the Keyboard](#)).
8. Remove the display assembly (see [Removing the Display Assembly](#)).
9. Remove the 17 screws that secure the top-cover assembly to the base cover.

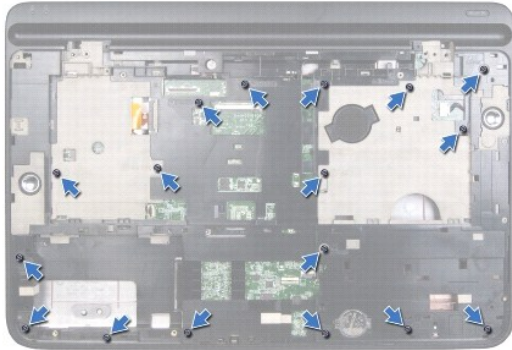

10. Turn the computer over.
11. Disconnect the fan cable and subwoofer cable from the connectors on the system board.
12. Remove the nine screws that secure the top-cover assembly to the base cover.

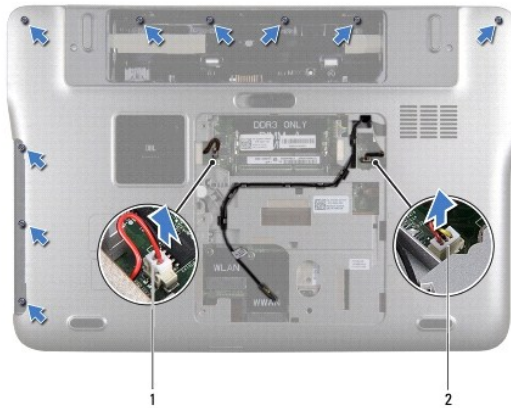

1	subwoofer cable connector	2	fan cable connector
---	---------------------------	---	---------------------

13. Turn the computer over and use your fingertips to gently ease the top-cover assembly off the base cover.
14. Lift the top-cover assembly off the base cover.



1	top-cover assembly
---	--------------------

15. Remove heat sink (see [Removing the Heat Sink](#)).
16. Remove the system board (see [Removing the System Board](#)).
17. Remove the AC-adapter connector (see [Removing the AC-Adapter Connector](#)).
18. Remove the USB board (see [Removing the USB Board](#)).
19. Remove the TV tuner connector (see [Removing the TV Tuner Connector](#)).
20. Remove the speakers (see [Removing the Speakers](#)).

Replacing the Top Cover

1. Follow the instructions in [Before You Begin](#).
2. Replace the speakers (see [Replacing the Speakers](#)).

3. Replace the TV tuner connector (see [Replacing the TV Tuner Connector](#)).
4. Replace the USB board (see [Replacing the USB Board](#)).
5. Replace the AC-adaptor connector (see [Replacing the AC-Adapter Connector](#)).
6. Replace the system board (see [Replacing the System Board](#)).
7. Replace the heat sink (see [Replacing the Heat Sink](#)).
8. Align the tabs on the top cover with the slots on the base cover and snap the top-cover assembly onto the base cover.
9. Replace the 17 screws that secure the top-cover assembly to the base cover.
10. Turn the computer over and replace the nine screws that secure the top-cover assembly to the base cover.
11. Connect the fan cable and subwoofer cable to the connectors on the system board.
12. Replace the display assembly (see [Replacing the Display Assembly](#)).
13. Replace the keyboard (see [Replacing the Keyboard](#)).
14. Replace the palm-rest assembly (see [Replacing the Palm-Rest Assembly](#)).
15. Replace the memory module(s) (see [Replacing the Memory Module\(s\)](#)).
16. Replace the module cover (see [Replacing the Module Cover](#)).
17. Replace any blank or card you removed from the Media Card Reader.
18. Replace the battery (see [Replacing the Battery](#)).

 **CAUTION:** Before turning on the computer, replace all screws and ensure that no stray screws remain inside the computer. Failure to do so may result in damage to the computer.

[Back to Contents Page](#)

[Back to Contents Page](#)

TV Tuner Connector

Dell™ XPS™ L502X Service Manual

- [Removing the TV Tuner Connector](#)
- [Replacing the TV Tuner Connector](#)

- ⚠ WARNING:** Before working inside your computer, read the safety information that shipped with your computer. For additional safety best practices information, see the Regulatory Compliance Homepage at www.dell.com/regulatory_compliance.
- ⚠ CAUTION:** Only a certified service technician should perform repairs on your computer. Damage due to servicing that is not authorized by Dell™ is not covered by your warranty.
- ⚠ CAUTION:** To avoid electrostatic discharge, ground yourself by using a wrist grounding strap or by periodically touching an unpainted metal surface (such as a connector on your computer).
- ⚠ CAUTION:** To help prevent damage to the system board, remove the main battery (see [Removing the Battery](#)) before working inside the computer.
-

Removing the TV Tuner Connector

1. Follow the instructions in [Before You Begin](#).
2. Remove the battery (see [Removing the Battery](#)).
3. Remove the module cover (see [Removing the Module Cover](#)).
4. Remove the memory module(s) (see [Removing the Memory Module\(s\)](#)).
5. Remove the palm-rest assembly (see [Removing the Palm-Rest Assembly](#)).
6. Remove the keyboard (see [Removing the Keyboard](#)).
7. Remove the display assembly (see [Removing the Display Assembly](#)).
8. Follow the instructions from [step 9](#) to [step 14](#) in [Removing the Top Cover](#).
9. Remove the AC adapter connector (see [Removing the AC-Adapter Connector](#)).
10. Make note of the TV tuner connector cable routing and remove the cable from the routing guides.
11. Remove the two screws that secure the TV tuner connector to the top cover.

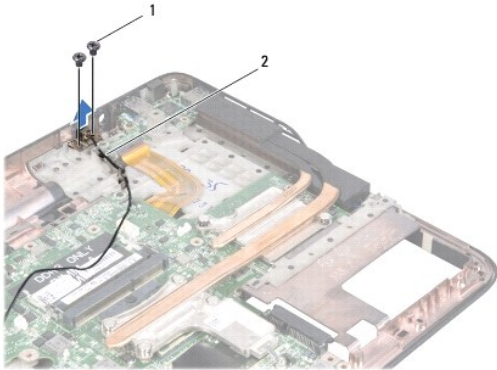

1	screws (2)	2	TV tuner connector cable
---	------------	---	--------------------------

12. Lift the TV tuner connector off the top cover.
-

Replacing the TV Tuner Connector

1. Follow the instructions in [Before You Begin](#).
2. Align the screw holes on the TV tuner connector with the screw holes on the top cover.
3. Replace the two screws that secure the TV tuner connector to the top cover.
4. Route the TV tuner connector cable through the routing guides.
5. Replace the AC-adaptor connector (see [Replacing the AC-Adapter Connector](#)).
6. Follow the instructions from [step 8](#) to [step 11](#) in [Replacing the Top Cover](#).
7. Replace the display assembly (see [Replacing the Display Assembly](#)).
8. Replace the keyboard (see [Replacing the Keyboard](#)).
9. Replace the palm-rest assembly (see [Replacing the Palm-Rest Assembly](#)).
10. Replace the memory module(s) (see [Replacing the Memory Module\(s\)](#)).
11. Replace the module cover (see [Replacing the Module Cover](#)).
12. Replace the battery (see [Replacing the Battery](#)).

 **CAUTION:** Before turning on the computer, replace all screws and ensure that no stray screws remain inside the computer. Failure to do so may result in damage to the computer.

[Back to Contents Page](#)

[Back to Contents Page](#)

Subwoofer

Dell™ XPS™ L502X Service Manual

- [Removing the Subwoofer](#)
- [Replacing the Subwoofer](#)

- ⚠ WARNING:** Before working inside your computer, read the safety information that shipped with your computer. For additional safety best practices information, see the Regulatory Compliance Homepage at www.dell.com/regulatory_compliance.
- ⚠ CAUTION:** Only a certified service technician should perform repairs on your computer. Damage due to servicing that is not authorized by Dell™ is not covered by your warranty.
- ⚠ CAUTION:** To avoid electrostatic discharge, ground yourself by using a wrist grounding strap or by periodically touching an unpainted metal surface (such as a connector on your computer).
- ⚠ CAUTION:** To help prevent damage to the system board, remove the main battery (see [Removing the Battery](#)) before working inside the computer.
-

Removing the Subwoofer

1. Follow the instructions in [Before You Begin](#).
2. Remove the battery (see [Removing the Battery](#)).
3. Remove the module cover (see [Removing the Module Cover](#)).
4. Remove the memory module(s) (see [Removing the Memory Module\(s\)](#)).
5. Remove the palm-rest assembly (see [Removing the Palm-Rest Assembly](#)).
6. Remove the keyboard (see [Removing the Keyboard](#)).
7. Remove the display assembly (see [Removing the Display Assembly](#)).
8. Follow the instructions from [step 9](#) to [step 14](#) in [Removing the Top Cover](#).
9. Remove the four screws that secure the subwoofer into the base cover.

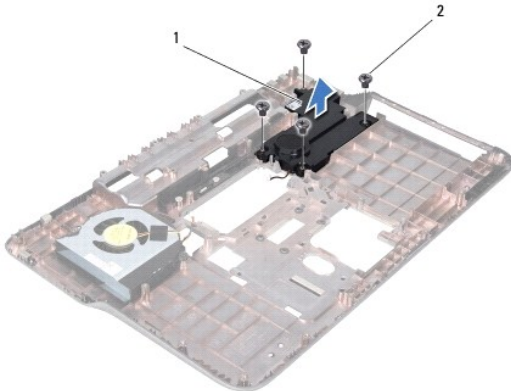

1	subwoofer	2	screws (4)
---	-----------	---	------------

10. Lift the subwoofer off the top cover.
-

Replacing the Subwoofer

1. Follow the instructions in [Before You Begin](#).

2. Place the subwoofer on the base cover.
3. Replace the four screws that secure the subwoofer to the base cover.
4. Follow the instructions from [step 8](#) to [step 11](#) in [Replacing the Top Cover](#).
5. Replace the display assembly (see [Replacing the Display Assembly](#)).
6. Replace the keyboard (see [Replacing the Keyboard](#)).
7. Replace the palm-rest assembly (see [Replacing the Palm-Rest Assembly](#)).
8. Replace the memory module(s) (see [Replacing the Memory Module\(s\)](#)).
9. Replace the module cover (see [Replacing the Module Cover](#)).
10. Replace the battery (see [Replacing the Battery](#)).

 **CAUTION:** Before turning on the computer, replace all screws and ensure that no stray screws remain inside the computer. Failure to do so may result in damage to the computer.

[Back to Contents Page](#)