

INSPIRON™

SETUP GUIDE



YOURS IS HERE

INSPIRON™

SETUP GUIDE

Regulatory model: P07G series

Regulatory type: P07G002

Notes, Cautions, and Warnings



NOTE: A NOTE indicates important information that helps you make better use of your computer.



CAUTION: A CAUTION indicates either potential damage to hardware or loss of data and tells you how to avoid the problem.



WARNING: A WARNING indicates a potential for property damage, personal injury, or death.

If you purchased a Dell™ n Series computer, any references in this document to Microsoft® Windows® operating systems are not applicable.

Information in this document is subject to change without notice.

© 2010 Dell Inc. All rights reserved.

Reproduction of these materials in any manner whatsoever without the written permission of Dell Inc. is strictly forbidden.

Trademarks used in this text: *Dell*, the *DELL* logo, *YOURS IS HERE*, *Solution Station*, *Inspiron*, and *DellConnect* are trademarks of Dell Inc.; *AMD*, *AMD Phenom*, *AMD Athlon*, *AMD Turion*, and *ATI Mobility Radeon* are trademarks of Advanced Micro Devices, Inc.; *Microsoft*, *Windows*, *Windows Vista*, and the *Windows Vista* start button logo are either trademarks or registered trademarks of Microsoft Corporation in the United States and/or other countries; *Blu-ray Disc* is a trademark of the Blu-ray Disc Association; *Bluetooth* is a registered trademark owned by Bluetooth SIG, Inc. and is used by Dell under license.

Other trademarks and trade names may be used in this document to refer to either the entities claiming the marks and names or their products. Dell Inc. disclaims any proprietary interest in trademarks and trade names other than its own.

Contents

Setting Up Your Inspiron Laptop	5	Touch Pad Gestures	28
Before Setting Up Your Computer	5	Multimedia Control Keys	30
Connect the AC Adapter	6	Using the Optical Drive	32
Connect the Network Cable (Optional)	7	Display Features	34
Press the Power Button	8	Removing and Replacing the Battery	36
Set Up the Operating System	9	Software Features	38
Create System Recovery Media (Recommended)	10	Dell Dock	39
Enable or Disable Wireless (Optional)	12	Dell DataSafe Online Backup	40
Connect to the Internet (Optional)	14	Solving Problems	41
Using Your Inspiron Laptop	18	Beep Codes	41
Right View Features	18	Network Problems	42
Left View Features	20	Power Problems	43
Front View Features	22	Memory Problems	44
Status Lights and Indicators	24	Lockups and Software Problems	45
Computer Base and Keyboard Features	26		

Contents

Using Support Tools	48	Returning Items for Repair Under Warranty or for Credit.....	68
Dell Support Center.....	48	Before You Call.....	70
My Dell Downloads.....	49	Contacting Dell.....	72
System Messages.....	49		
Hardware Troubleshooter.....	51	Finding More Information and Resources	74
Dell Diagnostics.....	51		
Restoring Your Operating System	56	Specifications	76
System Restore.....	57	Appendix	83
Dell DataSafe Local Backup.....	58	Macrovision Product Notice.....	83
System Recovery Media.....	61	Information for NOM, or Official Mexican Standard (Only for Mexico).....	84
Dell Factory Image Restore.....	62		
Getting Help	64	Index	85
Technical Support and Customer Service.....	65		
DellConnect.....	65		
Online Services.....	66		
Automated Order-Status Service.....	67		
Product Information.....	67		

Setting Up Your Inspiron Laptop

This section provides information about setting up your Dell™ Inspiron™ laptop.

Before Setting Up Your Computer

When positioning your computer, ensure that you allow easy access to a power source, adequate ventilation, and a level surface to place your computer.

Restricting airflow around your laptop may cause it to overheat. To prevent overheating ensure that you leave at least 10.2 cm (4 inches) at the back of the computer and a minimum of 5.1 cm (2 inches) on all other sides. You should never place your computer in an enclosed space, such as a cabinet or drawer when it is powered on.

 **WARNING:** Do not block, push objects into, or allow dust to accumulate in the air vents. Do not place your Dell™ computer in a low-airflow environment, such as a closed briefcase, or on fabric surfaces, such as carpets or rugs, while it is powered on. Restricting the airflow can damage the computer, deteriorate the computer performance, or cause a fire. The computer turns on the fan when the computer gets hot. Fan noise is normal and does not indicate a problem with the fan or the computer.

 **CAUTION:** Placing or stacking heavy or sharp objects on the computer may result in permanent damage to the computer.

Connect the AC Adapter

Connect the AC adapter to the computer and then plug it into an electrical outlet or surge protector.



WARNING: The AC adapter works with electrical outlets worldwide. However, power connectors and power strips vary among countries. Using an incompatible cable or improperly connecting the cable to a power strip or electrical outlet may cause fire or permanent damage to your computer.

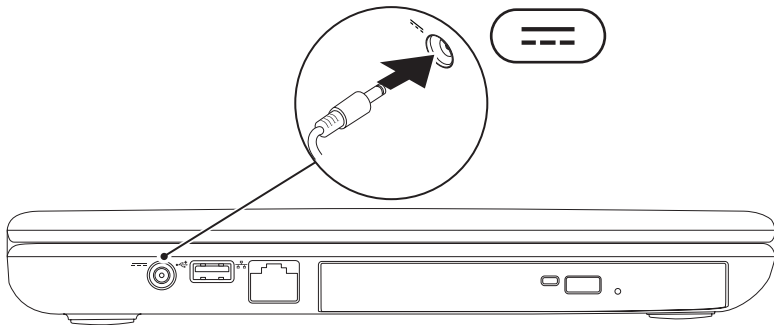

Connect the Network Cable (Optional)

To use a wired network connection, connect the network cable.

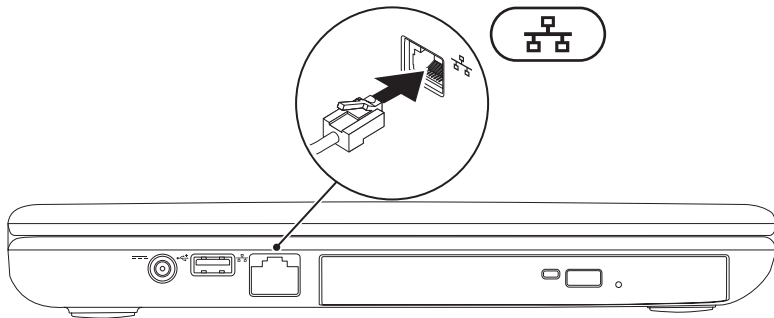

Press the Power Button

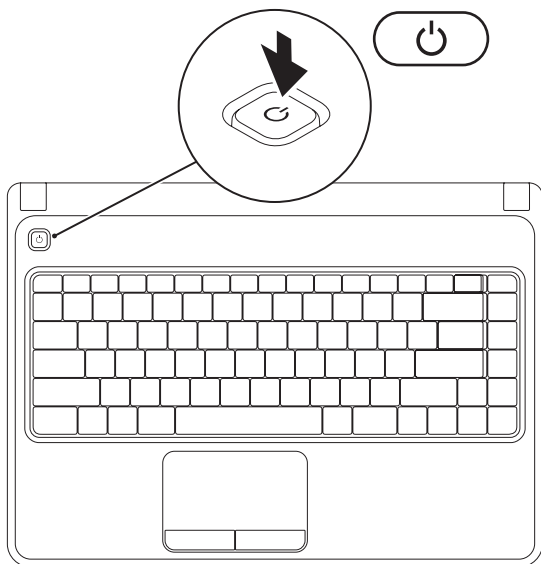



Set Up the Operating System

Your Dell computer is preconfigured with the operating system you selected at the time of purchase.

Set Up Microsoft Windows

To set up Microsoft® Windows® for the first time, follow the instructions on the screen. These steps are mandatory and may take some time to complete. The Windows setup screens will take you through several procedures including accepting license agreements, setting preferences, and setting up an Internet connection.

 **CAUTION:** Do not interrupt the operating system's setup process. Doing so may render your computer unusable and you will need to reinstall the operating system.

 **NOTE:** For optimal performance of your computer, it is recommended that you download and install the latest BIOS and drivers for your computer available at support.dell.com.

 **NOTE:** For more information on the operating system and features, see support.dell.com/MyNewDell.

Set Up Ubuntu

To set up Ubuntu® for the first time, follow the instructions on the screen. See the Ubuntu documentation for more operating system specific information.

Create System Recovery Media (Recommended)

 **NOTE:** It is recommended that you create a system recovery media as soon as you set up Microsoft Windows.

The system recovery media can be used to restore your computer to the operating state it was in when you purchased the computer, while preserving data files (without the need of the *Operating System* disc). You can use the system recovery media if changes to the hardware, software, drivers, or other system settings have left the computer in an undesirable operating state.

You will require the following to create the system recovery media:

- Dell DataSafe Local Backup
- USB key with a minimum capacity of 8 GB or DVD-R/DVD+R/Blu-ray Disc™

 **NOTE:** Dell DataSafe Local Backup does not support rewritable discs.

To create a system recovery media:

1. Ensure that the AC adapter is connected (see “Connect the AC Adapter” on page 6).
2. Insert the disc or USB key in the computer.
3. Click **Start**  → **Programs** → **Dell DataSafe Local Backup**.
4. Click **Create Recovery Media**.
5. Follow the instructions on the screen.

 **NOTE:** For information on using the system recovery media, see “System Recovery Media” on page 61.

Enable or Disable Wireless (Optional)

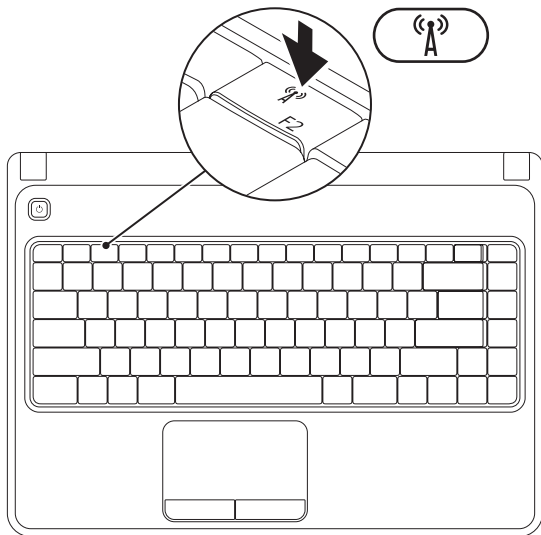

NOTE: The wireless feature is available on your computer only if you ordered a WLAN card at the time of purchase. For more information on the cards supported by your computer, see “Specifications” on page 76.

To enable wireless:

1. Ensure that your computer is turned on.
2. Press the wireless key  on the function key row on the keyboard.
A confirmation of your selection appears on the screen.

Wireless enabled



Wireless disabled



To disable wireless:

Press the wireless key  on the function key row on the keyboard again to turn off all radios.

NOTE: The wireless key allows you to quickly turn off wireless radios (Wi-Fi and Bluetooth®), such as when you are asked to disable all wireless radios on an airplane flight.

Connect to the Internet (Optional)

To connect to the Internet, you need an external modem or network connection and an Internet Service Provider (ISP).

If an external USB modem or WLAN adapter is not a part of your original order, you can purchase one at www.dell.com.

Setting Up a Wired Connection

- If you are using a dial-up connection, connect the telephone line to the optional external USB modem and to the telephone wall connector before you set up your Internet connection.
- If you are using a DSL or cable/satellite modem connection, contact your ISP or cellular telephone service for setup instructions.

To complete setting up your wired Internet connection, follow the instructions in “Setting Up Your Internet Connection” on page 16.

Setting Up a Wireless Connection

 **NOTE:** To set up your wireless router, see the documentation that shipped with your router.

Before you can use your wireless Internet connection, you need to connect to your wireless router.

To set up your connection to a wireless router:

Windows Vista®

1. Ensure that wireless is enabled on your computer (see “Enable or Disable Wireless” on page 12).
2. Save and close any open files, and exit any open programs.
3. Click **Start**  → **Connect To**.
4. Follow the instructions on the screen to complete the setup.

Windows® 7

1. Ensure that wireless is enabled on your computer (see “Enable or Disable Wireless” on page 12).
2. Save and close any open files, and exit any open programs.
3. Click **Start**  → **Control Panel**.
4. In the search box, type `network`, and then click **Network and Sharing Center** → **Connect to a network**.
5. Follow the instructions on the screen to complete the setup.

Setting Up Your Internet Connection

ISPs and ISP offerings vary by country. Contact your ISP for offerings available in your country.

If you cannot connect to the Internet but have successfully connected in the past, the ISP might have a service outage. Contact your ISP to check the service status, or try connecting again later.

Have your ISP information ready. If you do not have an ISP, the **Connect to the Internet** wizard can help you get one.

To set up your Internet connection:

Windows Vista

1. Save and close any open files, and exit any open programs.
2. Click **Start**  → **Control Panel**.
3. In the search box, type `network`, and then click **Network and Sharing Center** → **Set up a connection or network** → **Connect to the Internet**.

The **Connect to the Internet** window appears.

-  **NOTE:** If you do not know which type of connection to select, click **Help me choose** or contact your ISP.
4. Follow the instructions on the screen and use the setup information provided by your ISP to complete the setup.

Windows 7

1. Save and close any open files, and exit any open programs.
2. Click **Start**  → **Control Panel**.
3. In the search box, type `network`, and then click **Network and Sharing Center** → **Set up a new connection or network** → **Connect to the Internet**.

The **Connect to the Internet** window appears.

 **NOTE:** If you do not know which type of connection to select, click **Help me choose** or contact your ISP.

4. Follow the instructions on the screen and use the setup information provided by your ISP to complete the setup.

Using Your Inspiron Laptop

This section provides information about the features available on your Inspiron™ laptop.

Right View Features

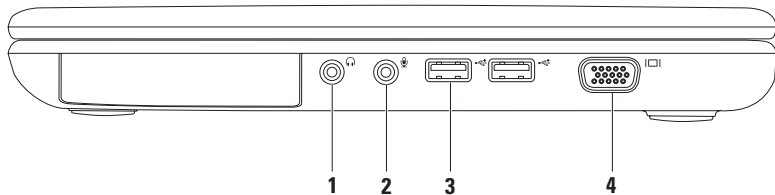

-
-  **Audio out/Headphone connector** — Connects to a pair of headphones or to a powered speaker or sound system.

 -  **Audio in/Microphone connector** — Connects to a microphone or inputs signal for use with audio programs.

 -  **USB 2.0 connectors (2)** — Connect to USB devices, such as a mouse, keyboard, printer, external drive, or MP3 player.

 -  **VGA connector** — Connects to a monitor or projector.
-

Left View Features

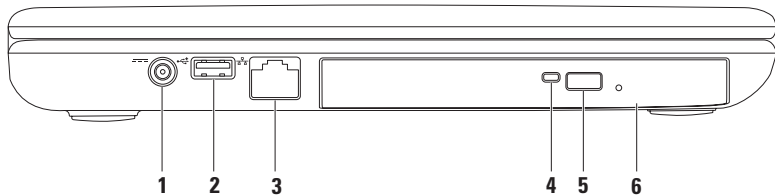

-
-  **AC adapter connector** — Connects to the AC adapter to power the computer and charge the battery.

 -  **USB 2.0 connector** — Connects to USB devices, such as a mouse, keyboard, printer, external drive, or MP3 player.

 -  **Network connector** — Connects your computer to a network or a broadband device if you are using a wired network.

 - Optical drive light** — Blinks when you press the optical drive eject button or when you insert a disc and it is being read.

 - Optical drive eject button** — Opens the optical drive tray when pressed.

 - Optical drive** — Plays or records CDs and DVDs.
For more information, see “Using the Optical Drive” on page 32.
-

Front View Features

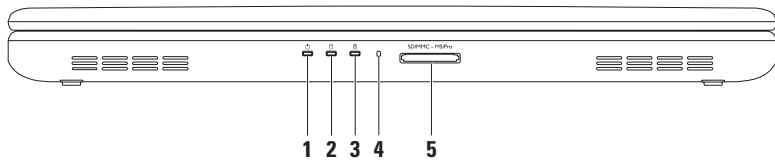

-
- 1  **Power indicator light** — Indicates the power states. For more information on the power indicator light, see “Status Lights and Indicators” on page 24.
-

- 2  **Hard drive activity light** — Turns on when the computer reads or writes data. A white light indicates hard drive activity.

 **CAUTION: To avoid loss of data, never turn off the computer while the hard drive activity light is active.**

- 3  **Battery status light** — Turns on steadily or blinks to indicate the battery charge status. For more information on the battery status light, see “Status Lights and Indicators” on page 24.

NOTE: The battery is charging when the computer is powered using the AC adapter.

- 4 **Analog microphone** — Provides quality sound for video conferencing and voice recording.
-

- 5  **5-in-1 Media Card Reader** — Provides a fast and convenient way to view and share digital photos, music, videos, and documents stored on the memory cards.

NOTE: Your computer ships with a plastic blank installed in the media card slot. Blanks protect unused slots from dust and other particles. Save the blank for use when no media card is installed in the slot; blanks from other computers may not fit in your computer.

Status Lights and Indicators

Battery Status Light

	Indicator light status	Computer state(s)	Battery charge level
AC adapter	solid white	on/standby/off/ hibernate	<=98%
	off	on/standby/off/ hibernate	>98%
Battery	solid amber	on/standby	<=10%
	off	on/standby/off/ hibernate	>10%
		off/hibernate	<=10%

 **NOTE:** The battery is charging when the computer is powered using the AC adapter.

Power Indicator Light 

Indicator light status	Computer state(s)
solid white	on
breathing white	standby
off	off/hibernate

 **NOTE:** For information on power problems, see “Power Problems” on page 43.

Computer Base and Keyboard Features

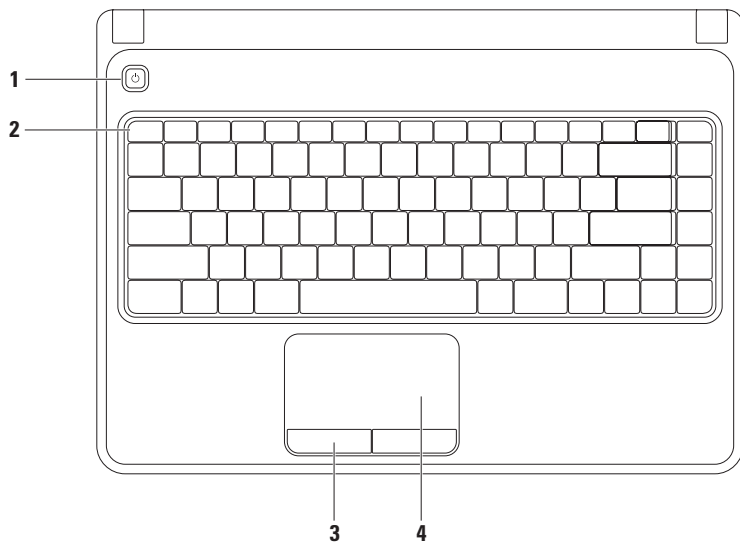

-
- 1**  **Power button** — Turns the computer on or off when pressed.
 - 2** **Function key row** — The wireless enable or disable key, brightness increase and decrease keys, multimedia keys, and the touch pad enable or disable key are located in this row. For more information on the multimedia keys, see “Multimedia Control Keys” on page 30.
 - 3** **Touch pad buttons (2)** — Provide left-click and right-click functions like those on a mouse.
 - 4** **Touch pad** — Provides the functionality of a mouse to move the cursor, drag or move selected items, and right-click or left-click by tapping the surface.
-

The touch pad supports the Zoom and Scroll gestures. To change the touch pad settings, double-click the **Dell Touch pad** icon in the notification area of the desktop. For more information, see “Touch Pad Gestures” on page 28.

NOTE: To enable or disable the touch pad, press the  key on the function key row on the keyboard.

Touch Pad Gestures

Zoom

Allows you to increase or decrease the magnification of the screen content. The zoom feature includes:

One finger zoom — Allows you to zoom in or out.

To zoom in:

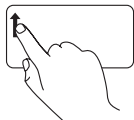

Move a finger up in the zoom zone (extreme left of the touch pad).

To zoom out:

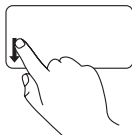

Move a finger down in the zoom zone (extreme left of the touch pad).

Scroll

Circular scroll — Allows you to scroll up or down, and right or left.

To scroll up or down:

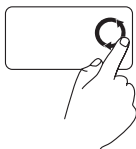

Move a finger in the vertical scroll zone (extreme right of the touch pad), in a clockwise circular motion to scroll up or counterclockwise circular motion to scroll down.

To scroll right or left:



Move a finger in the horizontal scroll zone (extreme bottom of the touch pad), in a clockwise circular motion to scroll right or counterclockwise circular motion to scroll left.

Multimedia Control Keys

The multimedia control keys are located on the function key row on the keyboard. To use the multimedia controls, press the required key. You can configure the multimedia control keys on the keyboard using the **System Setup (BIOS) Utility** or the **Windows Mobility Center**.

System Setup (BIOS) Utility

1. Press <F2> during POST (Power On Self Test) to enter the **System Setup (BIOS)** utility.
2. In the **Function Key Behavior**, select **Multimedia Key First** or **Function Key First**.

Multimedia Key First — This is the default option. Press any multimedia key to perform the associated action. For function key, press <Fn> + the required function key.

Function Key First — Press any function key to perform the associated action. For multimedia key, press <Fn> + the required multimedia key.

 **NOTE:** The **Multimedia Key First** option is active only in the operating system.

Windows Mobility Center

1. Press the <⊞><X> keys to launch the Windows Mobility Center.
2. In the **Function Key Row**, select **Function Key** or **Multimedia Key**.



 Mute the sound

 Decrease the volume level

 Increase the volume level

 Play the previous track or chapter

 Play or pause

 Play the next track or chapter

Using the Optical Drive

 **CAUTION:** Do not press down on the optical drive tray when you open or close it. Keep the optical drive tray closed when you are not using the drive.

 **CAUTION:** Do not move the computer while playing or recording a disc.

This optical drive plays or records CDs and DVDs. Ensure that the side with print or writing is facing up when placing discs on the optical drive tray.

To place a disc in the optical drive:

1. Press the eject button on the optical drive.
2. Pull out the optical drive tray.
3. Place the disc, label side up, in the center of the optical drive tray and snap the disc onto the spindle.
4. Push the optical drive tray back into the drive.

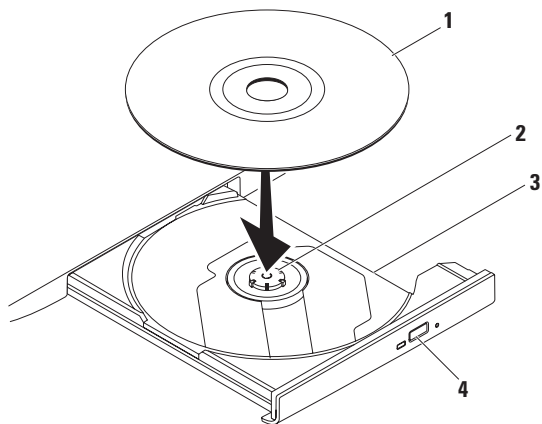

1 disc

2 spindle

3 optical drive tray

4 eject button

Display Features

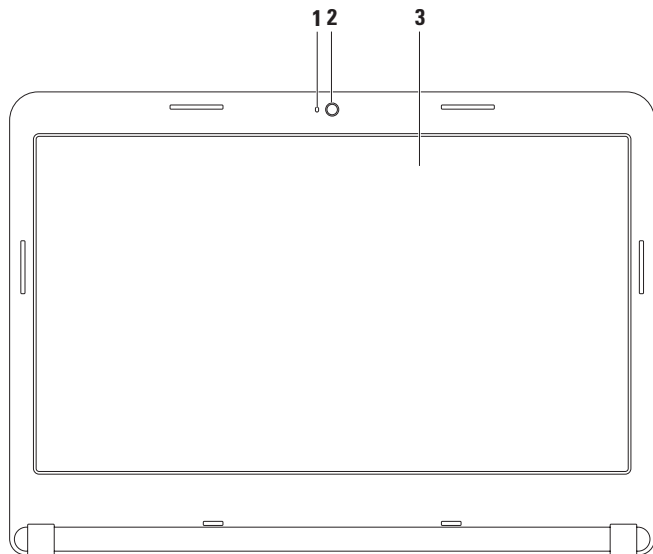

-
- 1 Camera activity indicator** — Indicates if the camera is on or off. A solid white light indicates camera activity.
 - 2 Camera** — Built-in camera for video capture, conferencing, and chat.
 - 3 Display** — Your display can vary based on selections you made when purchasing your computer. For more information about displays, see the *Dell Technology Guide* on your hard drive or at support.dell.com/manuals.
-

Removing and Replacing the Battery



WARNING: Before you begin any of the procedures in this section, follow the safety instructions that shipped with your computer.



WARNING: Using an incompatible battery may increase the risk of fire or explosion. This computer should only use a battery purchased from Dell. Do not use batteries from other computers.



WARNING: Before removing the battery, shut down the computer, and remove external cables (including the AC adapter).

To remove the battery:

1. Turn off the computer and turn it over.
2. Slide the battery release latch to the unlock position.
3. Slide the battery out of the battery bay.

To replace the battery:

Slide the battery into the battery bay, until it clicks into place.

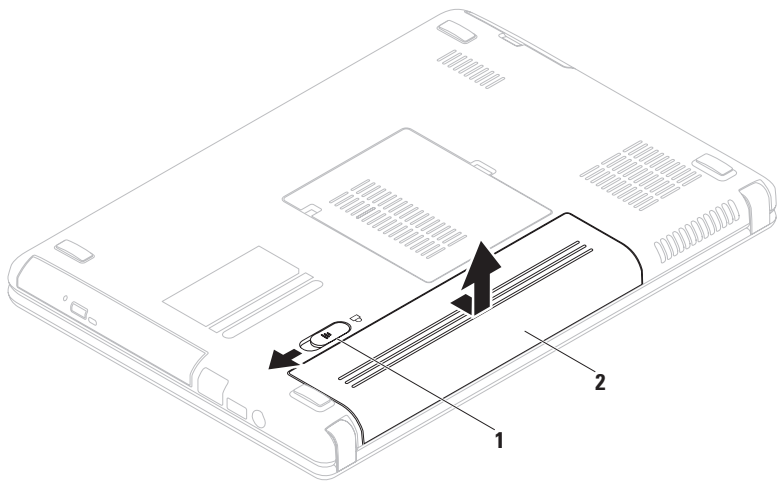

1 battery release latch

2 battery

Software Features

 **NOTE:** For more information about the features described in this section, see the *Dell Technology Guide* on your hard drive or at support.dell.com/manuals.

Productivity and Communication

You can use your computer to create presentations, brochures, greeting cards, fliers, and spreadsheets. You can also edit and view digital photographs and images. Check your purchase order for software installed on your computer.

After connecting to the Internet, you can access websites, setup an e-mail account, upload or download files, and so on.

Entertainment and Multimedia

You can use your computer to watch videos, play games, create your own CDs/DVDs, and listen to music and Internet radio stations.

You can download or copy pictures and video files from portable devices, such as digital cameras and cell phones. Optional software applications enable you to organize and create music and video files that can be recorded to disc, saved on portable products such as MP3 players and handheld entertainment devices, or played and viewed directly on connected TVs, projectors, and home theater equipment.

Dell Dock

The Dell Dock is a group of icons that provides easy access to frequently-used applications, files, and folders. You can personalize the Dock by:

- Adding or removing icons
- Changing the color and location of the Dock
- Grouping related icons into categories
- Changing the behavior of the icons



Add a Category

1. Right-click the Dock, click **Add**→ **Category**. The **Add/Edit Category** window is displayed.
2. Enter a title for the category in the **Title** field.
3. Select an icon for the category from the **Select an image:** box.
4. Click **Save**.

Add an Icon

Drag and drop the icon to the Dock or a category.

Remove a Category or Icon

1. Right-click the category or icon on the Dock and click **Delete shortcut** or **Delete category**.
2. Follow the instructions on the screen.

Personalize the Dock

1. Right-click the Dock and click **Advanced Setting....**
2. Choose the desired option to personalize the Dock.

Dell DataSafe Online Backup

 **NOTE:** Dell DataSafe Online may not be available in all regions.

 **NOTE:** A broadband connection is recommended for fast upload/download speeds.

Dell DataSafe Online is an automated backup and recovery service that helps protect your data and other important files from catastrophic incidents like theft, fire, or natural disasters. You can access the service on your computer using a password-protected account.

For more information, go to **delldatasafe.com**.

To schedule backups:

1. Double-click the Dell DataSafe Online icon  on the taskbar.
2. Follow the instructions that appear on the screen.

Solving Problems

This section provides troubleshooting information for your computer. If you cannot solve your problem using the following guidelines, see “Using Support Tools” on page 48 or “Contacting Dell” on page 72.

 **WARNING:** Only trained service personnel should remove the computer cover. See the *Service Manual* at support.dell.com/manuals for advanced service instructions.

Beep Codes

Your computer might emit a series of beeps during start-up if there are errors or problems. This series of beeps, called a beep code, identifies a problem. Write down the beep code and contact Dell (see “Contacting Dell” on page 72).

 **NOTE:** To replace parts, see the *Service Manual* at support.dell.com/manuals.

Beep Code	Possible Problem
One	Possible system board failure — BIOS ROM checksum failure
Two	No RAM detected NOTE: If you installed or replaced the memory module, ensure that the memory module is seated properly.
Three	Possible system board failure — Chipset error
Four	RAM read/write failure
Five	Real Time Clock failure
Six	Video card or chip failure
Seven	Processor failure
Eight	Display failure

Network Problems

Wireless Connections

If the wireless network connection is lost —

The wireless router is offline or wireless has been disabled on the computer.

- Ensure that wireless is enabled on your computer (see “Enable or Disable Wireless” on page 12).
- Check your wireless router to ensure it is powered on and connected to your data source (cable modem or network hub).
- Re-establish your connection to the wireless router (see “Setting Up a Wireless Connection” on page 15).
- Interference may be blocking or interrupting your wireless connection. Try moving the computer closer to your wireless router.

Wired Connections

If the wired network connection is lost — The cable is loose or damaged.

Check the cable to ensure it is plugged in and not damaged.

Power Problems

If the power indicator light is off — The computer is turned off, in hibernate mode, or not receiving power.

- Press the power button. The computer resumes normal operation if it is off or in hibernate mode.
- Reseat the AC adapter into both the power connector on the computer and the electrical outlet.
- If the AC adapter is plugged into a power strip, ensure that the power strip is plugged into an electrical outlet and that the power strip is turned on.
- Temporarily bypass power protection devices, power strips, and power extension cables to verify that the computer turns on properly.
- Ensure that the electrical outlet is working by testing it with another device, such as a lamp.

- Check the AC adapter connections. If the AC adapter has a light, ensure that the light on the AC adapter is on.
- If the problem persists, contact Dell (see “Contacting Dell” on page 72).

If the power indicator light is solid white and the computer is not responding — The display may not be responding.

- Press the power button until the computer turns off and then turn it back on.
- If the problem persists, contact Dell (see “Contacting Dell” on page 72).

If the power indicator light is breathing white — The computer is in standby mode or the display may not be responding.

- Press a key on the keyboard, move the connected mouse or a finger on the touch pad, or press the power button to resume normal operation.

Solving Problems

- If the display is not responding, press the power button until the computer turns off and then turn it back on.
- If the problem persists, contact Dell (see “Contacting Dell” on page 72).

If you encounter interference that hinders reception on your computer — An unwanted signal is creating interference by interrupting or blocking other signals. Some possible causes of interference are:

- Power, keyboard, and mouse extension cables.
- Too many devices connected to a power strip.
- Multiple power strips connected to the same electrical outlet.

Memory Problems

If you receive an insufficient memory message —

- Save and close any open files and exit any open programs you are not using to see if that resolves the problem.
- See the software documentation for minimum memory requirements. If necessary, install additional memory (see the *Service Manual* at support.dell.com/manuals).
- Reseat the memory module(s) into the connector(s) (see the *Service Manual* at support.dell.com/manuals).
- If the problem persists, contact Dell (see “Contacting Dell” on page 72).

If you experience other memory problems —

- Run the Dell Diagnostics (see “Dell Diagnostics” on page 51).
- If the problem persists, contact Dell (see “Contacting Dell” on page 72).

Lockups and Software Problems

If the computer does not start up — Ensure that the AC adapter is firmly connected to the computer and to the electrical outlet.

If a program stops responding —

End the program:

1. Press <Ctrl><Shift><Esc> simultaneously.
2. Click **Applications**.
3. Select the program that is no longer responding.
4. Click **End Task**.

If a program crashes repeatedly — Check the software documentation. If necessary, uninstall and then reinstall the program.

 **NOTE:** Software usually includes installation instructions in its documentation or on the CD.

If the computer stops responding or a solid blue screen appears —

 **CAUTION: You might lose data if you are unable to perform an operating system shutdown.**

If you are unable to get a response by pressing a key on your keyboard or moving your mouse, press the power button for at least 8 to 10 seconds until the computer turns off and then restart your computer.

If a program is designed for an earlier Microsoft® Windows® operating system —

Run the Program Compatibility Wizard. The Program Compatibility Wizard configures a program so that it runs in an environment similar to an earlier version of Microsoft Windows operating system environments.

To run the Program Compatibility Wizard:

Windows Vista®

1. Click **Start**  → **Control Panel** → **Programs** → **Use an older program with this version of Windows.**
2. In the welcome screen, click **Next**.
3. Follow the instructions on the screen.

Windows 7

1. Click **Start**  → **Control Panel** → **Programs** → **Run programs made for previous versions of Windows**.
2. In the welcome screen, click **Next**.
3. Follow the instructions on the screen.

If you have other software problems —

- Back up your files immediately.
 - Use a virus-scanning program to check the hard drive or CDs.
 - Save and close any open files or programs and shut down your computer through the **Start**  menu.
- Check the software documentation or contact the software manufacturer for troubleshooting information:
 - Ensure that the program is compatible with the operating system installed on your computer.
 - Ensure that your computer meets the minimum hardware requirements needed to run the software. See the software documentation for information.
 - Ensure that the program is installed and configured properly.
 - Verify that the device drivers do not conflict with the program.
 - If necessary, uninstall and then reinstall the program.

Using Support Tools

Dell Support Center

The **Dell Support Center** helps you find the service, support, and system-specific information you need.

To launch the application, click the  icon in the taskbar.

The **Dell Support Center** home page displays your computer's model number, service tag, express service code, and service contact information.

The home page also provides links to access:

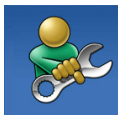

Self Help (Troubleshooting, Security, System Performance, Network/Internet, Backup/Recovery, and Windows operating system)



Alerts (technical support alerts relevant to your computer)



Assistance from Dell (Technical Support with DellConnect™, Customer Service, Training and Tutorials, How-To Help with Solution Station™, and Online Scan with PC CheckUp)



About Your System (System Documentation, Warranty Information, System Information, Upgrades & Accessories)

For more information about **Dell Support Center** and available support tools, click the **Services** tab at support.dell.com.

My Dell Downloads

 **NOTE:** My Dell Downloads may not be available in all regions.

Some of the software pre-installed on your new computer do not include a backup CD or DVD. This software is available at My Dell Downloads. From this website you can download available software for reinstallation or create your own backup media.

To register and use My Dell Downloads:

1. Go to **downloadstore.dell.com/media**.
2. Follow the instructions on the screen to register and download the software.
3. Reinstall or create backup media of the software for future use.

System Messages

If your computer has an issue or error, it may display a System Message that will help you identify the cause and action needed to resolve the issue.

 **NOTE:** If the message that is displayed is not listed in the following examples, see the documentation for either the operating system or the program that was running when the message appeared. Alternatively you could see the *Dell Technology Guide* on your hard drive or at **support.dell.com/manuals** or see “Contacting Dell” on page 72 for assistance.

Using Support Tools

CMOS checksum error — Possible system board failure or RTC battery low. Replace the battery (see the *Service Manual* at support.dell.com/manuals) or contact Dell (see “Contacting Dell” on page 72).

CPU fan failure — CPU fan has failed. Replace the CPU fan (see the *Service Manual* at support.dell.com/manuals).

Hard-disk drive failure — Possible hard drive failure during POST. Contact Dell (see “Contacting Dell” on page 72).

Hard-disk drive read failure — Possible hard drive failure during HDD boot test. Contact Dell (see “Contacting Dell” on page 72).

No boot device available — No bootable partition on hard drive, the hard drive cable is loose, or no bootable device exists.

- If the hard drive is your boot device, ensure that the cables are connected and that the drive is installed properly and partitioned as a boot device.

- Enter system setup and ensure that the boot sequence information is correct (see the *Dell Technology Guide* on your hard drive or at support.dell.com/manuals).

CAUTION - Hard Drive SELF MONITORING SYSTEM has reported that a parameter has exceeded its normal operating range. Dell recommends that you back up your data regularly. A parameter out of range may or may not indicate a potential hard drive problem — S.M.A.R.T error, possible hard drive failure. Contact Dell (see “Contacting Dell” on page 72).

Hardware Troubleshooter

If a device is either not detected during the operating system setup or is detected but incorrectly configured, you can use the **Hardware Troubleshooter** to resolve the incompatibility.

To start the Hardware Troubleshooter:

1. Click **Start**  → **Help and Support**.
2. Type `hardware troubleshooter` in the search field and press <Enter> to start the search.
3. In the search results, select the option that best describes the problem and follow the remaining troubleshooting steps.

Dell Diagnostics

If you experience a problem with your computer, perform the checks in “Lockups and Software Problems” on page 45 and run the Dell Diagnostics before you contact Dell for technical assistance. It is recommended that you print these procedures before you begin.

 **NOTE:** Dell Diagnostics works only on Dell computers.

 **NOTE:** The *Drivers and Utilities* disc is optional and may not ship with your computer.

Ensure that the device that you want to test displays in the system setup program and is active. Press <F2> during POST (Power On Self Test) to enter the System Setup (BIOS) utility.

Start the Dell Diagnostics from your hard drive or from the *Drivers and Utilities* disc.

Starting Dell Diagnostics From Your Hard Drive

The Dell Diagnostics is located on a hidden diagnostic utility partition on your hard drive.

 **NOTE:** If your computer cannot display a screen image, contact Dell (see “Contacting Dell” on page 72).

1. Ensure that the computer is connected to an electrical outlet that is known to be working properly.
2. Turn on (or restart) your computer.
3. When the DELL™ logo appears, press <F12> immediately. Select **Diagnostics** from the boot menu and press <Enter>. This may invoke the Pre-Boot System Assessment (PSA) on your computer.

 **NOTE:** If you wait too long and the operating system logo appears, continue to wait until you see the Microsoft® Windows® desktop; then, shut down your computer and try again.

 **NOTE:** If you see a message stating that no diagnostics utility partition has been found, run the Dell Diagnostics from the *Drivers and Utilities* disc.

If PSA is invoked:

- a. The PSA will start running tests.
- b. If the PSA completes successfully, the following message is displayed: “No problems have been found with this system so far. Do you want to run the remaining memory tests? This will take about 30 minutes or more. Do you want to continue? (Recommended).”

- c. If you are experiencing memory issues, press <y>, otherwise press <n>.

The following message is displayed:

```
"Booting Dell Diagnostic  
Utility Partition. Press any  
key to continue."
```

- d. Press any key to go to the **Choose An Option** window.

If PSA is not invoked:

Press any key to start the Dell Diagnostics from the diagnostic utility partition on your hard drive and to go to the **Choose An Option** window.

4. Select the test you want to run.

5. If you encounter a problem during a test, a message with the error code and a description of the problem will appear on your screen. Write down the error code and problem description and contact Dell (see "Contacting Dell" on page 72).

 **NOTE:** The Service Tag for your computer is displayed at the top of each test screen. The Service Tag helps you identify your computer when you contact Dell.

6. When the tests complete, close the test screen to return to the **Choose An Option** window.
7. To exit the Dell Diagnostics and to restart the computer, click **Exit**.

Starting Dell Diagnostics From the Drivers and Utilities Disc

 **NOTE:** The *Drivers and Utilities* disc may not ship with your computer.

1. Insert the *Drivers and Utilities* disc.
2. Shut down and restart the computer.
When the DELL™ logo appears, press <F12> immediately.

 **NOTE:** If you wait too long and the operating system logo appears, continue to wait until you see the Microsoft® Windows® desktop; then, shut down your computer and try again.

 **NOTE:** The next steps change the boot sequence for one time only. On the next start-up, the computer boots according to the devices specified in the system setup program.

3. When the boot device list appears, highlight **CD/DVD/CD-RW** and press <Enter>.
4. Select the **Boot from CD-ROM** option from the menu that appears and press <Enter>.
5. Type 1 to start the CD menu and press <Enter> to proceed.
6. Select **Run the 32 Bit Dell Diagnostics** from the numbered list. If multiple versions are listed, select the version appropriate for your computer.
7. Select the test you want to run.
8. If you encounter a problem during a test, a message with the error code and a description of the problem will appear on your screen. Write down the error code and problem description and contact Dell (see “Contacting Dell” on page 72).

-  **NOTE:** The Service Tag for your computer is displayed at the top of each test screen. The Service Tag helps you identify your computer when you contact Dell.
9. When the tests complete, close the test screen to return to the **Choose An Option** window.
 10. To exit the Dell Diagnostics and to restart the computer, click **Exit**.
 11. Remove the *Drivers and Utilities* disc.

Restoring Your Operating System

You can restore the operating system on your computer using any of the following options:

 **CAUTION:** Using Dell Factory Image Restore or the *Operating System* disc permanently deletes all data files on your computer. If possible, backup your data files before using these options.

Option	Use
System Restore	as the first solution
Dell DataSafe Local Backup	when System Restore does not resolve your problem
System recovery media	when operating system failure prevents the use of System Restore and DataSafe Local Backup when installing the factory image on a newly installed hard drive
Dell Factory Image Restore	to restore your computer to the operating state it was in when you received your computer
<i>Operating System</i> disc	to reinstall only the operating system on your computer

 **NOTE:** The *Operating System* disc may not ship with your computer.

System Restore

The Windows operating systems provide a System Restore option which allows you to return your computer to an earlier operating state (without affecting data files) if changes to the hardware, software, or other system settings have left the computer in an undesirable operating state. Any changes that System Restore makes to your computer are completely reversible.

 **CAUTION: Make regular backups of your data files. System Restore does not monitor your data files or recover them.**

Starting System Restore

1. Click **Start** .
2. In the **Start Search** box, type `System Restore` and press <Enter>.

 **NOTE:** The **User Account Control** window may appear. If you are an administrator on the computer, click **Continue**; otherwise, contact your administrator to continue the desired action.

3. Click **Next** and follow the instructions on the screen.

In the event that System Restore did not resolve the issue, you may undo the last system restore.

Undoing the Last System Restore

 **NOTE:** Before you undo the last system restore, save and close all open files and exit any open programs. Do not alter, open, or delete any files or programs until the system restoration is complete.

1. Click **Start** .
2. In the search box, type `System Restore` and press <Enter>.
3. Click **Undo my last restoration**, click **Next** and follow the instructions on the screen.

Dell DataSafe Local Backup

 **CAUTION:** Using Dell DataSafe Local Backup permanently removes any programs or drivers installed after you received your computer. Prepare backup media of applications you need to install on your computer before using Dell DataSafe Local Backup. Use Dell DataSafe Local Backup only if System Restore did not resolve your operating system problem.

 **CAUTION:** Although Dell Datasafe Local Backup is designed to preserve the data files on your computer, it is recommended that you backup your data files before using the Dell DataSafe Local Backup.

 **NOTE:** Dell DataSafe Local Backup may not be available in all regions.

 **NOTE:** If Dell DataSafe Local Backup is not available on your computer, use Dell Factory Image Restore (see “Dell Factory Image Restore” on page 62) to restore your operating system.

You can use Dell DataSafe Local Backup to restore your hard drive to the operating state it was in when you purchased your computer, while preserving the data files.

Dell DataSafe Local Backup allows you to:

- Backup and restore your computer to an earlier operating state
- Create system recovery media

Dell DataSafe Local Backup Basic

To restore the factory image while preserving the data files:

1. Turn off your computer.
2. Disconnect all the devices (USB drive, printer, etc.) connected to the computer and remove any newly added internal hardware.
 **NOTE:** Do not disconnect the keyboard, mouse, or the power cable.
3. Turn on your computer.

4. When the DELL™ logo appears, press <F8> several times to access the **Advanced Boot Options** window.

 **NOTE:** If you wait too long and the operating system logo appears, continue to wait until you see the Microsoft® Windows® desktop; then, shut down your computer and try again.

5. Select **Repair Your Computer**.

6. Select **Dell DataSafe Restore and Emergency Backup** from the **System Recovery Options** menu and follow the instructions on the screen.

 **NOTE:** The restoration process might take an hour or more depending on the size of the data to be restored.

 **NOTE:** For more information, see the knowledge base article 353560 at support.dell.com.

Upgrading to Dell DataSafe Local Backup Professional

 **NOTE:** Dell DataSafe Local Backup Professional may be installed on your computer, if you ordered it at the time of purchase.

Dell DataSafe Local Backup Professional provides additional features that allow you to:

- Backup and restore your computer based on file types
- Backup files to a local storage device
- Schedule automated backups

To upgrade to Dell DataSafe Local Backup Professional:

1. Double-click the Dell DataSafe Local Backup icon  on the taskbar.
2. Click **UPGRADE NOW!**
3. Follow the instructions on the screen to complete the upgrade.

System Recovery Media

 **CAUTION:** Although the system recovery media is designed to preserve the data files on your computer, it is recommended that you backup your data files before using the system recovery media.

You can use the system recovery media, created using Dell DataSafe Local Backup, to return your hard drive to the operating state it was in when you purchased the computer while preserving the data files on your computer.

Use the system recovery media in case of:

- Operating system failure that prevents the use of recovery options that are installed on your computer.
- Hard drive failure that prevents data from being recovered.

To restore the factory image of your computer using the system recovery media:

1. Insert the system recovery disc or USB key and restart the computer.
2. When the DELL™ logo appears, press <F12> immediately.

 **NOTE:** If you wait too long and the operating system logo appears, continue to wait until you see the Microsoft® Windows® desktop; then, shut down your computer and try again.

3. Select the appropriate boot device from the list and press <Enter>.
4. Follow the instructions on the screen to complete the recovery process.

Dell Factory Image Restore



 **CAUTION:** Using Dell Factory Image Restore permanently deletes all data on the hard drive and removes any programs or drivers installed after you received your computer. If possible, back up the data before using this option. Use Dell Factory Image Restore only if System Restore did not resolve your operating system problem.

 **NOTE:** Dell Factory Image Restore may not be available in certain countries or on certain computers.

You can use Dell Factory Image Restore only as the last method to restore your operating system. This option restores your hard drive to the operating state it was in when you purchased the computer. Any programs or files added since you received your computer—including data files—are permanently deleted from the hard drive. Data files include documents, spreadsheets, e-mail messages, digital photos, music files, and so on. If possible, back up all data before using Dell Factory Image Restore.

Starting Dell Factory Image Restore

1. Turn on the computer.
2. When the DELL™ logo appears, press <F8> several times to access the **Advanced Boot Options** window.
 **NOTE:** If you wait too long and the operating system logo appears, continue to wait until you see the Microsoft® Windows® desktop; then, shut down your computer and try again.
3. Select **Repair Your Computer**.
The **System Recovery Options** window appears.
4. Select a keyboard layout and click **Next**.
5. To access the recovery options, log on as a local user. To access the command prompt, type `administrator` in the **User name** field, then click **OK**.
6. Click **Dell Factory Image Restore**. The **Dell Factory Image Restore** welcome screen appears.

-  **NOTE:** Depending upon your configuration, you may need to select **Dell Factory Tools**, then **Dell Factory Image Restore**.
7. Click **Next**.
The **Confirm Data Deletion** screen appears.
 **NOTE:** If you do not want to proceed with Dell Factory Image Restore, click **Cancel**.
8. Select the check box to confirm that you want to continue reformatting the hard drive and restoring the system software to the factory condition, then click **Next**.
The restore process begins and may take five or more minutes to complete. A message appears when the operating system and factory-installed applications have been restored to factory condition.
9. Click **Finish** to restart the computer.

Getting Help

If you experience a problem with your computer, you can complete the following steps to diagnose and troubleshoot the problem:

1. See “Solving Problems” on page 41 for information and procedures that pertain to the problem your computer is experiencing.
2. See the *Dell Technology Guide* on your hard drive or at support.dell.com/manuals for more troubleshooting information.
3. See “Dell Diagnostics” on page 51 for procedures on how to run Dell Diagnostics.
4. Fill out the “Diagnostic Checklist” on page 71.
5. Use Dell’s extensive suite of online services available at support.dell.com for help with installation and troubleshooting procedures. See “Online Services” on page 66 for a more extensive list of Dell Support online.

6. If the preceding steps have not resolved the problem, see “Before You Call” on page 70.

 **NOTE:** Call Dell Support from a telephone near or at the computer so that the support staff can assist you with any necessary procedures.

 **NOTE:** Dell’s Express Service Code system may not be available in all countries.

When prompted by Dell’s automated telephone system, enter your Express Service Code to route the call directly to the proper support personnel. If you do not have an Express Service Code, open the **Dell Accessories** folder, double-click the **Express Service Code** icon, and follow the directions.

 **NOTE:** Some of the services are not always available in all locations outside the continental U.S. Call your local Dell representative for information on availability.

Technical Support and Customer Service

Dell's support service is available to answer your questions about Dell hardware. Our support staff use computer-based diagnostics to provide fast, accurate answers.

To contact Dell's support service, see "Before You Call" on page 70 and then see the contact information for your region or go to **support.dell.com**.

DellConnect

DellConnect™ is a simple online access tool that allows a Dell service and support associate to access your computer through a broadband connection, diagnose your problem and repair it all under your supervision. For more information, go to **www.dell.com/dellconnect**.

Online Services

You can learn about Dell products and services on the following websites:

- www.dell.com
- www.dell.com/ap (Asian/Pacific countries only)
- www.dell.com/jp (Japan only)
- www.euro.dell.com (Europe only)
- www.dell.com/la (Latin American and Caribbean countries)
- www.dell.ca (Canada only)

You can access Dell Support through the following websites and e-mail addresses:

Dell Support websites

- support.dell.com
- support.jp.dell.com (Japan only)
- support.euro.dell.com (Europe only)
- supportapj.dell.com (Asia Pacific only)

Dell Support e-mail addresses

- mobile_support@us.dell.com
- support@us.dell.com
- la-techsupport@dell.com (Latin America and Caribbean countries only)
- apsupport@dell.com (Asian/Pacific countries only)

Dell Marketing and Sales e-mail addresses

- apmarketing@dell.com (Asian/Pacific countries only)
- sales_canada@dell.com (Canada only)

Anonymous file transfer protocol (FTP)

- ftp.dell.com
Log in as user: `anonymous`, and use your e-mail address as your password.

Automated Order-Status Service

To check on the status of any Dell products that you have ordered, you can go to **support.dell.com**, or you can call the automated order-status service. A recording prompts you for the information needed to locate and report on your order.

If you have a problem with your order, such as missing parts, wrong parts, or incorrect billing, contact Dell for customer assistance. Have your invoice or packing slip handy when you call.

For the telephone number to call for your region, see “Contacting Dell” on page 72.

Product Information

If you need information about additional products available from Dell, or if you would like to place an order, visit **www.dell.com**. For the telephone number to call for your region or to speak to a sales specialist, see “Contacting Dell” on page 72.

Returning Items for Repair Under Warranty or for Credit

Prepare all items being returned, whether for repair or credit, as follows:

 **NOTE:** Before you return the product to Dell, make sure to back up any data on the hard drive and on any other storage device in the product. Remove any and all confidential, proprietary and personal information, as well as removable media, such as CDs and media cards. Dell is not responsible for any of your confidential, proprietary or personal information; lost or corrupted data; or damaged or lost removable media that may be included with your return.

1. Call Dell to obtain a Return Material Authorization Number, and write it clearly and prominently on the outside of the box. For the telephone number to call your region, see “Contacting Dell” on page 72.
2. Include a copy of the invoice and a letter describing the reason for the return.
3. Include a copy of the Diagnostics Checklist (see “Diagnostic Checklist” on page 71), indicating the tests that you have run and any error messages reported by the Dell Diagnostics (see “Dell Diagnostics” on page 51).
4. Include any accessories that belong with the item(s) being returned (AC adapter cable, software, guides, and so on) if the return is for credit.

5. Pack the equipment to be returned in the original (or equivalent) packing materials.

 **NOTE:** You are responsible for paying shipping expenses. You are also responsible for insuring any product returned, and you assume the risk of loss during shipment to Dell. Collect On Delivery (C.O.D.) packages are not accepted.

 **NOTE:** Returns that are missing any of the preceding requirements will be refused at Dell's receiving dock and returned to you.

Before You Call

-  **NOTE:** Have your Express Service Code ready when you call. The code helps Dell's automated-support telephone system direct your call more efficiently. You may also be asked for your Service Tag.

Locating Your Service Tag

The Service Tag for your computer can be found on a label at the bottom of your computer.

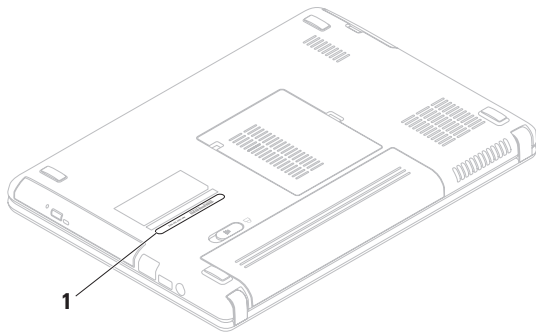

1 Service Tag

Remember to fill out the following Diagnostic Checklist. If possible, turn on your computer before you call Dell for assistance and call from a telephone at or near the computer. You may be asked to type some commands at the keyboard, relay detailed information during operations, or try other troubleshooting steps possible only at the computer itself. Ensure that the computer documentation is available.

Diagnostic Checklist

- Name:
- Date:
- Address:
- Phone number:
- Service Tag (bar code on the back or bottom of the computer):
- Express Service Code:
- Return Material Authorization Number (if provided by Dell support technician):
- Operating system and version:
- Devices:
- Expansion cards:
- Are you connected to a network? Yes/No
- Network, version, and network adapter:
- Programs and versions:

Getting Help

See your operating system documentation to determine the contents of the computer's start-up files. If the computer is connected to a printer, print each file. Otherwise, record the contents of each file before calling Dell.

- Error message, beep code, or diagnostic code:
- Description of problem and troubleshooting procedures you performed:

Contacting Dell

For customers in the United States, call 800-WWW-DELL (800-999-3355).



NOTE: If you do not have an active Internet connection, you can find contact information on your purchase invoice, packing slip, bill, or Dell product catalog.

Dell provides several online and telephone-based support and service options. Availability varies by country and product, and some services may not be available in your area.

To contact Dell for sales, technical support, or customer service issues:

1. Visit **www.dell.com/contactdell**.
2. Select your country or region.
3. Select the appropriate service or support link based on your requirement.
4. Choose the method of contacting Dell that is convenient for you.

Finding More Information and Resources

If you need to:**See:**

reinstall your operating system

“System Recovery Media” on page 61

run a diagnostic program for your computer

“Dell Diagnostics” on page 51

reinstall laptop system software

“My Dell Downloads” on page 49

find more information about the Microsoft®
Windows® operating system and features

support.dell.com

upgrade your computer with new or additional
components like a new hard drive

the *Service Manual* at
support.dell.com/manuals

reinstall or replace a worn or defective part



NOTE: In some countries, opening and replacing parts of your computer may void your warranty. Check your warranty and return policies before working inside your computer.

If you need to:

find safety best practices information for your computer

review Warranty information, Terms and Conditions (U.S. only), Safety instructions, Regulatory information, Ergonomics information, and End User License Agreement

find your Service tag/Express Service Code — You must use the service tag to identify your computer on **support.dell.com** or to contact technical support

find drivers and downloads; readme files
access technical support and product help
check on your order status for new purchases
find solutions and answers to common questions

locate information for last-minute updates about technical changes to your computer or advanced technical-reference material for technicians or experienced users

See:



the safety and regulatory documents that shipped with your computer and also see the Regulatory Compliance Homepage at **www.dell.com/regulatory_compliance**

the bottom of your computer the **Dell Support Center**. To launch the **Dell Support Center**, click the  icon in the taskbar.

support.dell.com

Specifications

This section provides information that you may need when setting up, updating drivers for, and upgrading your computer.

 **NOTE:** Offerings may vary by region. For more information regarding the configuration of your computer, click **Start**  → **Help and Support** and select the option to view information about your computer.

Computer Model

Dell™ Inspiron™ M4010

Memory

Memory module connector	two user-accessible SODIMM connectors
Memory module capacities	1 GB and 2 GB
Memory type	1333 MHz SODIMM DDR3

Memory

Minimum memory	1 GB (Ubuntu only) 2 GB
Maximum memory	4 GB
Possible memory configurations	1 GB (Ubuntu only), 2 GB, 3 GB, and 4 GB

 **NOTE:** For instructions on upgrading the memory, see the *Service Manual* at support.dell.com/manuals.

Processor

Type	AMD Phenom™ II AMD Athlon™ II AMD Turion™ II
------	--

System Chipset

Type	AMD™ M880G + SB820M
------	------------------------

Video

UMA

Video controller	AMD ATI Mobility Radeon™ HD 4250
Video memory	up to 3067 MB of shared memory

Video

Discrete	
Video controller	AMD ATI Mobility Radeon HD 5430 AMD ATI Mobility Radeon HD 530v
Video memory	512 MB

Connectors

Audio	one microphone-in connector, one stereo headphones/speakers connector, and one analog microphone
Mini-Card	one half-size Mini-Card slot
Network adapter	one RJ45 connector
USB	three four-pin USB 2.0-compliant connectors

Specifications

Connectors

Media Card Reader	one 5-in-1 slot
Video	one 15-hole connector

Media Card Reader

Cards supported	Secure Digital (SD) memory card Secure Digital High Capacity (SDHC) Memory Stick Memory Stick PRO MultiMedia Card (MMC) MultiMedia Card plus (MMC+)
-----------------	--

Communications

Modem (optional)	External V.92 56K USB modem
Network adapter	10/100 Ethernet LAN on system board
Wireless	WLAN a/b/g/n and Bluetooth® wireless technology

Audio

Audio controller	IDT 92HD79B1
Speaker	2 x 1 watt speakers
Volume controls	software program menus and media controls

Camera

Pixel	0.3 megapixel
Video resolution	640 x 480 at 30 fps (maximum)

Keyboard

Number of keys	86 (U.S. and Canada); 87 (Europe); 90 (Japan); 87 (Brazil)
----------------	--

Display

Type	14.0" HD WLED TrueLife
Dimensions	
Height	173.95 mm (6.85 inches)
Width	309.40 mm (12.18 inches)
Diagonal	355.60 mm (14.00 inches)
Maximum resolution	1366 x 768

Display

Refresh rate	60 Hz
Operating angle	0° (closed) to 140°
Horizontal viewing angle	40/40
Vertical viewing angle	15/–30 (H/L)
Pixel pitch	0.23 x 0.23 mm
Controls	brightness can be controlled through keyboard shortcuts (see the <i>Dell Technology Guide</i> for more information)

Specifications

Touch Pad

X/Y position resolution (graphics table mode)	240 cpi
Size	
Width	90.00 mm (3.54 inches) sensor-active area
Height	46.00 mm (1.81 inches) rectangle

Battery

6-cell lithium ion	
Height	20.20 mm (0.80 inches)
Width	208.36 mm (8.20 inches)
Depth	56.52 mm (2.22 inches)
Weight	0.33 kg (0.73 lb)
Voltage	11.1 VDC
Charge time (approximate):	4 hours (when the computer is turned off)
Operating time	Battery operating time varies depending on operating conditions.
Coin-cell battery	CR-2032

AC Adapter

 **NOTE:** Use only AC adapters specified for use with your computer. See the safety information that shipped with your computer.

Input voltage	100–240 VAC
Input current	1.5 A/1.6 A/1.7 A
Input frequency	50–60 Hz
Output power	65 W or 90 W
Output current	
65 W	4.43 A (maximum at 4-second pulse) 3.34 A (continuous)
90 W	5.62 A (maximum at 4-second pulse) 4.62 A (continuous)

AC Adapter

Rated output voltage	19.5 +/- 1 VDC
Temperature range	
Operating	0° to 40°C (32° to 104°F)
Storage	–40° to 70°C (–40° to 158°F)

Physical

Height	32.10 to 32.80 mm (1.26 to 1.29 inches)
Width	340.00 mm (13.38 inches)
Depth	244.00 mm (9.61 inches)
Weight (with 6-cell battery)	configurable to less than 2.22 kg (4.90 lb)

Specifications

Computer Environment

Temperature range

Operating 0° to 35°C
 (32° to 95°F)

Storage -40° to 65°C
 (-40° to 149°F)

Relative humidity (maximum)

Operating 10% to 90%
 (noncondensing)

Storage 5% to 95%
 (noncondensing)

Maximum vibration (using a random vibration spectrum that simulates user environment)

Operating 0.66 GRMS

Non-Operating 1.30 GRMS

Computer Environment

Maximum shock (for operating — measured with Dell Diagnostics running on the hard drive and a 2-ms half-sine pulse; for non-operating — measured with hard drive in head-parked position and a 2-ms half-sine pulse)

Operating 110 G

Non-Operating 160 G

Altitude (maximum)

Operating -15.2 to 3048 m
 (-50 to 10,000 ft)

Storage -15.2 to 10,668 m
 (-50 to 35,000 ft)

Airborne
contaminant level G2 or lower as defined
 by ISA-S71.04-1985

Appendix

Macrovision Product Notice

This product incorporates copyright protection technology that is protected by method claims of certain U.S. patents and other intellectual property rights owned by Macrovision Corporation and other rights owners. Use of this copyright protection technology must be authorized by Macrovision Corporation, and is intended for home and other limited viewing uses only unless otherwise authorized by Macrovision Corporation. Reverse engineering or disassembly is prohibited.

Information for NOM, or Official Mexican Standard (Only for Mexico)

The following information is provided in the device(s) described in this document in accordance with the requirements of the Official Mexican Standard (NOM):

Importer:

Dell México S.A. de C.V.

Paseo de la Reforma 2620 – Flat 11°

Col. Lomas Altas

11950 México, D.F.

Laptops

Regulatory model number	Voltage	Frequency	Electricity consumption	Output voltage	Output intensity
P07G	100-240 VAC	50-60 Hz	1.5 A/1.6 A/1.7 A	19.5 VDC	3.34 A/4.62 A

For details, read the safety information that shipped with your computer.

For additional safety best practices information, see the Regulatory Compliance Homepage at www.dell.com/regulatory_compliance.

Index

A

airflow, allowing **5**

C

calling Dell **70**

CDs, playing and creating **38**

computer capabilities **38**

computer, setting up **5**

Contacting Dell online **72**

customer service **65**

D

damage, avoiding **5**

DellConnect **65**

Dell DataSafe Online Backup **40**

Dell Diagnostics **51**

Dell Support Center **48**

Diagnostic Checklist **71**

drivers and downloads **75**

DVDs, playing and creating **38**

E

e-mail addresses

for technical support **66**

F

finding more information **74**

FTP login, anonymous **66**

H

hardware problems

diagnosing **51**

Hardware Troubleshooter **51**

Index

help

getting assistance and support **64**

I

Internet connection **14**

ISP

Internet Service Provider **14**

M

memory problems

solving **44**

N

network connection

fixing **42**

P

power problems, solving **43**

power strips, using **6**

problems, solving **41**

products

information and purchasing **67**

R

resources, finding more **74**

restoring factory image **62**

S

setup, before you begin **5**

shipping products

for return or repair **68**

software features **38**

software problems **45**

solving problems **41**

specifications **76**

support e-mail addresses **66**

support sites

worldwide **66**

System Messages **49**

system restoring options **56**

T

Touch Pad

Gestures 28

V

ventilation, ensuring **5**

W

warranty returns **68**

Windows

 Program Compatibility Wizard **46**

setup 9

wired network

 network cable, connecting **7**

wireless network connection **15**



Printed in the U.S.A.

www.dell.com | support.dell.com



OC3W6DA00