

# Dell Latitude E6430/E6530/E6430 ATG

## Setup and Features Information

### About Warnings

 **WARNING:** A WARNING indicates a potential for property damage, personal injury, or death.

### Latitude E6430 Front and Back View

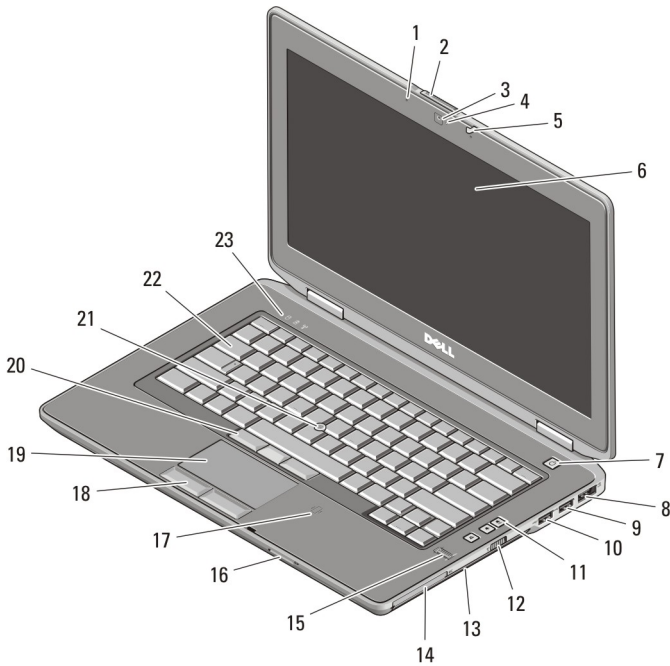

**Figure 1. Front View**

- |                          |                        |
|--------------------------|------------------------|
| 1. microphone            | 5. camera              |
| 2. display release latch | 4. camera status light |



OHTKCTA00

Regulatory Model : P25G, P19F, P25G  
Regulatory Type : P25G001, P19F001,  
P25G002  
2011 - 9

- |                               |   |
|-------------------------------|---|
| 5. display latch              | 16. Secure Digital (SD) memory-card reader                  |
| 6. display                    | 17. contactless smart card reader                           |
| 7. power button               | 18. touchpad buttons (2)                                    |
| 8. eSATA/USB 2.0 connector    | 19. touchpad  |
| 9. USB 3.0 connector          | 20. trackstick buttons (3)                                  |
| 10. powered USB 3.0 connector | 21. trackstick  |
| 11. volume control buttons    | 22. keyboard  |
| 12. wireless switch           | 23. device status lights (hard disk, battery, and wireless) |
| 13. optical drive             |   |
| 14. ExpressCard slot          |   |
| 15. fingerprint reader        |   |

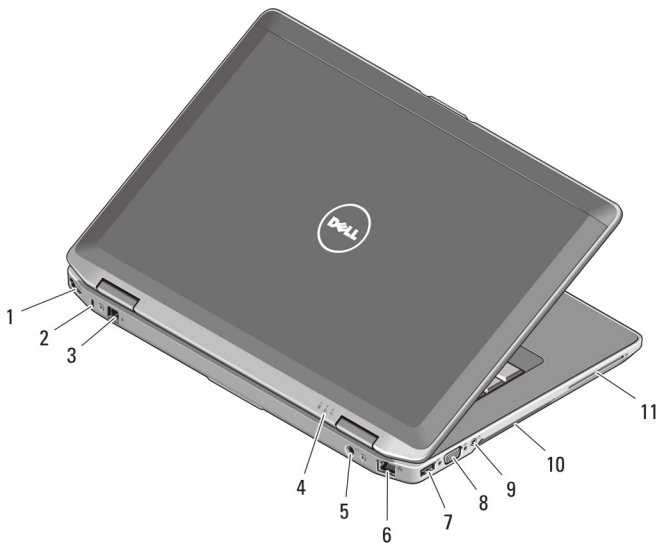

**Figure 2. Back View**

- |   |                      |
|---|----------------------|
| 1. HDMI connector                                       | 7. USB 2.0 connector |
| 2. security cable slot                                  | 8. VGA connector     |
| 3. modem connector                                      | 9. audio connector   |
| 4. device status lights (power, hard disk, and battery) | 10. cooling vents    |
| 5. power connector                                      | 11. smart card slot  |
| 6. network connector                                    |                      |



**WARNING:** Do not block, push objects into, or allow dust to accumulate in the air vents. Do not store your Dell computer in a low-airflow environment, such as a closed briefcase, while it is running. Restricting the airflow can damage the computer or cause a fire. The computer turns on the fan when the computer gets hot. Fan noise is normal and does not indicate a problem with the fan or the computer.

## Latitude E6530 Front and Back View

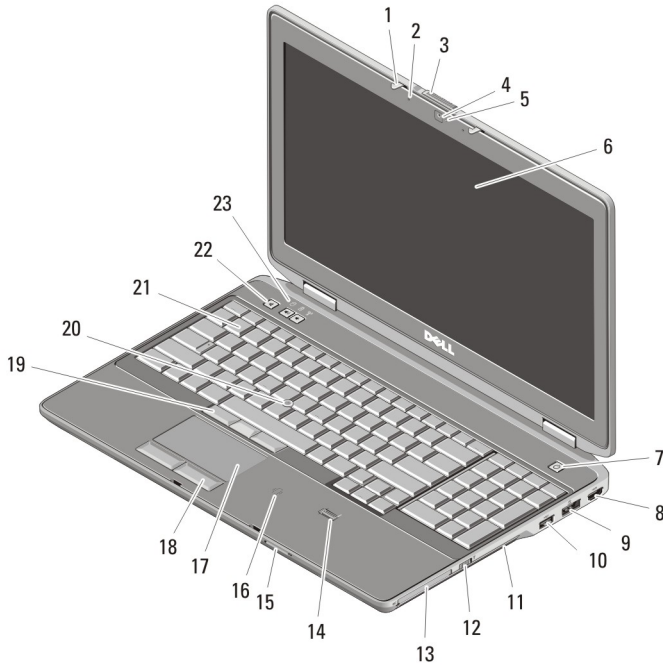

**Figure 3. Front View**

- |                          |                               |
|--------------------------|-------------------------------|
| 1. display latch         | 8. HDMI connector             |
| 2. microphone            | 9. eSATA/USB 2.0 connector    |
| 3. display release latch | 10. powered USB 3.0 connector |
| 4. camera                | 11. optical drive             |
| 5. camera status light   | 12. wireless switch           |
| 6. display               | 13. ExpressCard slot          |
| 7. power button          | 14. fingerprint reader        |

- 15. Secure Digital (SD) memory-card reader
- 16. contactless smart card reader
- 17. touchpad
- 18. touchpad buttons (2)
- 19. trackstick buttons (3)
- 20. trackstick
- 21. keyboard
- 22. volume control buttons
- 23. device status lights (hard disk, battery, and wireless)

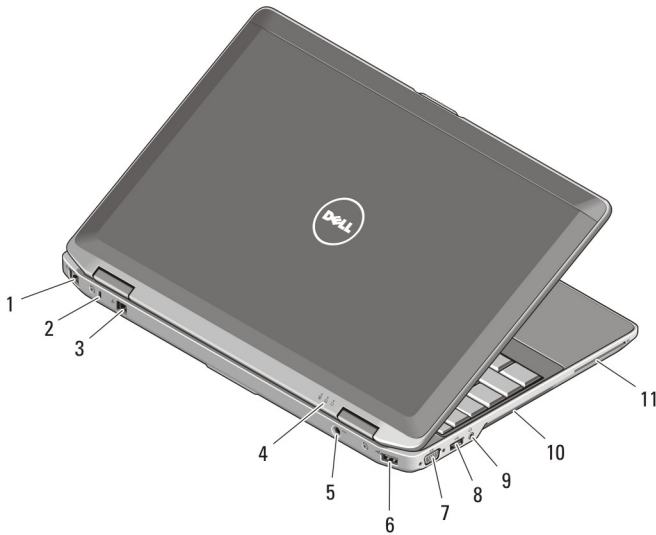

**Figure 4. Back View**

- 1. network connector
- 2. security cable slot
- 3. modem connector
- 4. device status lights (power, hard disk, and battery)
- 5. power connector
- 6. USB 2.0 connector
- 7. VGA connector
- 8. USB 3.0 connector
- 9. audio connector
- 10. cooling vents
- 11. smart card slot



**WARNING:** Do not block, push objects into, or allow dust to accumulate in the air vents. Do not store your Dell computer in a low-airflow environment, such as a closed briefcase, while it is running. Restricting the airflow can damage the computer or cause a fire. The computer turns on the fan when the computer gets hot. Fan noise is normal and does not indicate a problem with the fan or the computer.

# Latitude E6430 ATG Front and Back View

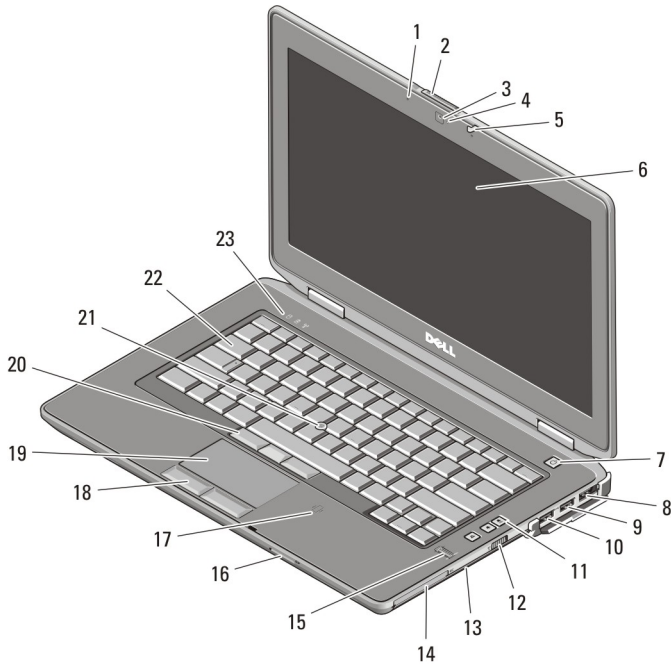

**Figure 5. Front view**

- |                               |   |
|-------------------------------|---|
| 1. microphone                 | 14. ExpressCard slot  |
| 2. display release latch      | 15. fingerprint reader                                      |
| 3. camera                     | 16. Secure Digital (SD) memory-card reader                  |
| 4. camera status light        | 17. contactless smart card reader                           |
| 5. display latch              | 18. touchpad buttons (2)                                    |
| 6. display                    | 19. touchpad  |
| 7. power button               | 20. trackstick buttons (3)                                  |
| 8. eSATA/USB 2.0 connector    | 21. trackstick  |
| 9. USB 3.0 connector          | 22. keyboard  |
| 10. powered USB 3.0 connector | 23. device status lights (hard disk, battery, and wireless) |
| 11. volume control buttons    |   |
| 12. wireless switch           |   |
| 13. optical drive             |   |

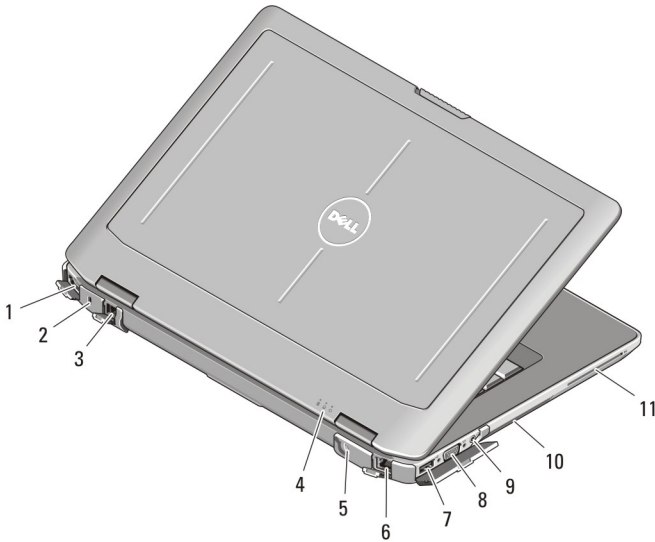

**Figure 6. Back view**

- |   |                      |
|---|----------------------|
| 1. HDMI connector                                       | 7. USB 2.0 connector |
| 2. security cable slot                                  | 8. VGA connector     |
| 3. modem connector /WWAN pass-through (optional)        | 9. audio connector   |
| 4. device status lights (power, hard disk, and battery) | 10. cooling vents    |
| 5. power connector                                      | 11. smart card slot  |
| 6. network connector                                    |                      |



**WARNING:** Do not block, push objects into, or allow dust to accumulate in the air vents. Do not store your Dell computer in a low-airflow environment, such as a closed briefcase, while it is running. Restricting the airflow can damage the computer or cause a fire. The computer turns on the fan when the computer gets hot. Fan noise is normal and does not indicate a problem with the fan or the computer.

## Installing Handle Assembly (Latitude E6430 ATG)

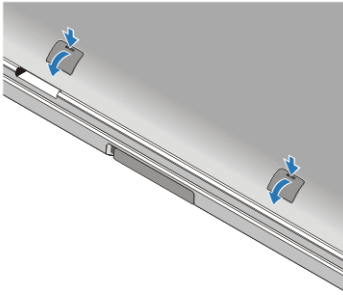

1. Insert a paper clip into the release holes to unlock and remove the covering plugs from their slots.

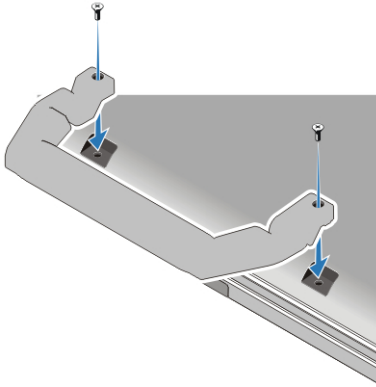

2. Place the handle assembly into the slots. Use the screws to tighten and secure the handle assembly to the computer.



## Quick Setup

-  **WARNING:** Before you begin any of the procedures in this section, read the safety information that shipped with your computer. For additional best practices information, see [www.dell.com/regulatory\\_compliance](http://www.dell.com/regulatory_compliance)
-  **WARNING:** The AC adapter works with electrical outlets worldwide. However, power connectors and power strips vary among countries. Using an incompatible cable or improperly connecting the cable to the power strip or electrical outlet may cause fire or equipment damage.
-  **CAUTION:** When you disconnect the AC adapter cable from the computer, grasp the connector, not the cable itself, and pull firmly but gently to avoid damaging the cable. When you wrap the AC adapter cable, ensure that you follow the angle of the connector on the AC adapter to avoid damaging the cable.

 **NOTE:** Some devices may not be included if you did not order them.

1. Connect the AC adapter to the AC adapter connector on the computer and to the electrical outlet.

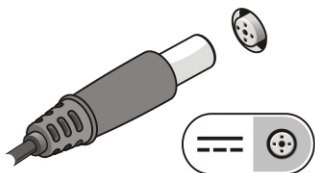

**Figure 7. AC Adapter**

2. Connect the network cable (optional).

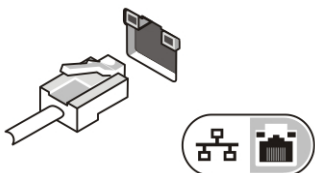

**Figure 8. Network Connector**

3. Connect USB devices, such as a mouse or keyboard (optional).

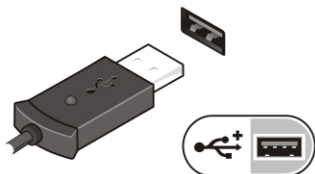

**Figure 9. USB Connector**

4. Open the computer display and press the power button to turn on the computer.



**Figure 10. Power Button**

5. Connect the external antennae (purchased by customer) to the RF cable (provided by Dell) present on the RF board. (Applicable only for E6430 ATG)



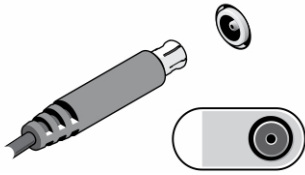

**Figure 11. RF Pass Connector**

 **NOTE:** It is recommended that you turn on and shut down your computer at least once before you install any cards or connect the computer to a docking device or other external device, such as a printer.

## Specifications

 **NOTE:** Offerings may vary by region. The following specifications are only those required by law to ship with your computer. For more information regarding the configuration of your computer, click **Start** → **Help and Support** and select the option to view information about your computer.

---

### Power

---

#### AC Adapter

Latitude E6430, Latitude E6530, and Latitude E6430 ATG      65 W and 90 W

 **NOTE:** 65 W AC adapter is available only for computers with integrated video card.

Input voltage      100 VAC to 240 VAC

Coin-cell battery      3 V CR2032 lithium coin cell

---

### Physical

---

#### Latitude E6430

Height      26.90 mm to 32.40 mm (1.06 inches to 1.27 inches)

Width      352.00 mm (13.86 inches)

Depth      241.00 mm (9.49 inches)

Weight (Discrete unit with 6 cell)      2.62 kg (5.78 lb)

---

## Physical

---

### Latitude E6530

|                                    |   |
|------------------------------------|---|
| Height                             | 28.30 mm to 34.20 mm (1.11 inches to 1.35 inches) |
| Width                              | 384.00 mm (15.12 inches)                          |
| Depth                              | 258.00 mm (10.16 inches)                          |
| Weight (Discrete unit with 6 cell) | 2.75 kg (6.06 lb)                                 |

### Latitude E6430 ATG

|                               |   |
|-------------------------------|---|
| Height                        | 33.80 mm to 37.80 mm (1.33 inches to 1.49 inches) |
| Width                         | 359.20 mm (14.14 inches) with port cover          |
| Depth                         | 247.40 mm (9.74 inches) with port cover           |
| Weight (UMA unit with 6 cell) | 2.88 kg (6.34 lb)                                 |

---

## Environmental

---

Operating Temperature: 0 °C to 35 °C (32 °F to 95 °F)

## Finding More Information and Resources

See the safety and regulatory documents that shipped with your computer and the regulatory compliance website at [www.dell.com/regulatory\\_compliance](http://www.dell.com/regulatory_compliance) for more information on:

- Safety best practices
- Regulatory certification
- Ergonomics

See [www.dell.com](http://www.dell.com) for additional information on:

- Warranty
- Terms and Conditions (U.S. only)
- End User License Agreement

Additional information on your product is available at [support.dell.com/manuals](http://support.dell.com/manuals).

**© 2012 Dell Inc.**

Trademarks used in this text: Dell™, the DELL logo, Dell Precision™, Precision ON™, ExpressCharge™, Latitude™, Latitude ON™, OptiPlex™, Vostro™, and Wi-Fi Catcher™ are trademarks of Dell Inc. Intel®, Pentium®, Xeon®, Core™, Atom™, Centrino®, and Celeron® are registered trademarks or trademarks of Intel Corporation in the U.S. and other countries. AMD® is a registered trademark and AMD Opteron™, AMD Phenom™, AMD Sempron™, AMD Athlon™, ATI Radeon™, and ATI FirePro™ are trademarks of Advanced Micro Devices, Inc. Microsoft®, Windows®, MS-DOS®, Windows Vista®, the Windows Vista start button, and Office Outlook® are either trademarks or registered trademarks of Microsoft Corporation in the United States and/or other countries. Blu-ray Disc™ is a trademark owned by the Blu-ray Disc Association (BDA) and licensed for use on discs and players. The Bluetooth® word mark is a registered trademark and owned by the Bluetooth® SIG, Inc. and any use of such mark by Dell Inc. is under license. Wi-Fi® is a registered trademark of Wireless Ethernet Compatibility Alliance, Inc.