

# Dell™ Latitude™ C600/C500 User's Guide

## About Your Computer

[What You Need to Know  
Features and Options](#)

## Setup and Operation

[Using Your Computer](#)  
[Connecting Devices](#)  
[Microsoft® Windows® XP Features](#)  
[Using Intel® SpeedStep™ to Set  
Performance Levels](#)  
[Passwords and Security](#)  
[Traveling With Your Computer](#)  
[Removing and Replacing Parts](#)

## Powering Your Computer

[AC Adapter and Battery](#)  
[Power Management and Conservation](#)

## [Using the System Setup Program](#)

Model PP01L

---

## Notes, Notices, and Cautions

Notes, notices, and cautions are used as follows:



**NOTE:** A NOTE indicates important information that helps you make better use of your computer.

**NOTICE:** A NOTICE indicates either potential damage to hardware or loss of data and tells you how to avoid the problem.



**CAUTION:** A CAUTION indicates a potential for property damage, personal injury, or death.

---

Information in this document is subject to change without notice.

© 2000–2001 Dell Computer Corporation. All rights reserved.

Reproduction in any manner whatsoever without the written permission of Dell Computer Corporation is strictly forbidden.

Trademarks used in this text: *Dell*, the *DELL* logo, *Latitude*, *Inspiron*, *OptiPlex*, *Dell Precision*, *ExpressCharge*, *HyperCool*, *DellWare*, and *AccessDirect* are trademarks of Dell Computer Corporation; *Microsoft*, *Windows*, *Windows NT*, and *MS-DOS* are registered trademarks of Microsoft Corporation; *3Com* is a registered trademark of 3Com Corporation; *Intel* and *Pentium* are registered trademarks, and *SpeedStep* and *Celeron* are trademarks of Intel Corporation. As an ENERGY STAR partner, Dell has determined that this product meets the ENERGY STAR guidelines for energy efficiency.

## [Reinstalling Software](#)

## Solving Problems

[Finding Solutions](#)  
[Dell Diagnostics](#)  
[Understanding Error Messages](#)  
[Getting Help](#)

## [Technical Specifications](#)

## Additional Information

[Regulatory Notices](#)  
[Limited Warranty and Return Policy](#)

Other trademarks and trade names may be used in this document to refer to either the entities claiming the marks and names or their products. Dell disclaims any proprietary interest in trademarks and trade names other than its own.

---

September 2001 368FN A02

# What You Need to Know: Dell™ Latitude™ C600/C500 User's Guide

[Finding Information](#)

[Safety and EMC Symbols](#)

[Safety Instructions](#)

[EMC Instructions](#)

[When Using Your Computer](#)

[Ergonomic Computing Habits](#)

[When Removing or Installing Memory Modules](#)

[Protecting Against Electrostatic Discharge](#)

---

## Finding Information

Besides this *User's Guide*, the following documentation is included with your computer.



*NOTE: Documentation updates are sometimes included with your computer to describe changes to your computer or software. Always read these updates **before** consulting any other documentation because the updates contain the latest information.*

- An operating system *Setup Guide*, which describes how to set up the operating system installed on your Dell computer.
- Operating system documentation is included if you ordered your operating system from Dell. This documentation describes how to configure and use your operating system software.
- Online documentation for your computer's devices (such as a modem) and for options you purchase separately from your computer.
  - *In Microsoft® Windows® XP*, click the Start button, and then click Help and Support. From the Help and Support window, click the link to access the user and system guides.
  - *In Windows 2000*, double-click the Dell User's Guide icon on the desktop, click System Information, and then click System Documentation.
- Readme files may be installed on your hard-disk drive to provide last-minute updates about technical changes to your computer or advanced technical reference material intended for experienced users or technicians.

For detailed information on the computer's parts and assemblies and how to remove and replace them, see the computer *Service Manual* at the Dell support Web site at <http://support.dell.com>.

---

## Safety and EMC Symbols

The following information defines the meaning of *additional* symbols used *only* in the Safety and Electromagnetic Compatibility (EMC) Instructions.

 Risk of explosion

 Aircraft

 Risk of fire







 Use of this feature may be prohibited on aircraft

 Risk of electric shock

---

## Safety Instructions

### General

- Do not attempt to service the computer yourself unless you are a trained service technician. Always follow installation instructions closely.
- If you use an extension power cable with your AC adapter, ensure that the total ampere rating of the products plugged in to the extension power cable does not exceed the ampere rating of the extension cable.
-   Do not push objects into air vents or openings of your computer. Doing so can cause fire or electric shock by shorting out interior components.
-  Place the AC adapter in a ventilated area, such as a desk top or on the floor, when you use it to run the computer or to charge the battery. Do not cover the AC adapter with papers or other items that will reduce cooling; also, do not use the AC adapter inside a carrying case.
- Do not allow your portable computer to operate with the base resting directly on exposed skin for extended periods of time. The surface temperature of the base will rise during normal operation (particularly when AC power is present). Allowing sustained contact with the skin can cause discomfort or, eventually, a burn.
-  Do not use your computer in a wet environment, for example, near a bath tub, sink, or swimming pool or in a wet basement.
-  If your computer includes an integrated or optional (PC Card) modem, disconnect the modem cable if an electrical storm is approaching to avoid the remote risk of electric shock from lightning via the telephone line.
-  To help avoid the potential hazard of electric shock, do not connect or disconnect any cables or perform maintenance or reconfiguration of this product during an electrical storm. Do not use your computer during an electrical storm unless all cables have been disconnected and the computer is operating on battery power.
- If your computer includes a modem, the cable used with the modem should be manufactured with a minimum wire size of 26 American wire gauge (AWG) and an FCC-

compliant RJ-11 modular plug.

- PC Cards may become very warm during normal operation. Use care when removing PC Cards after their continuous operation.
- Before you clean your computer, remove power. Clean your computer with a soft cloth dampened with water. Do not use liquid or aerosol cleaners, which may contain flammable substances.



#### Power (Safety Instructions, continued)



- Use only the Dell-provided AC adapter approved for use with this computer. Use of another AC adapter may cause a fire or explosion.
- Before you connect the computer to an electrical outlet, check the AC adapter voltage rating to ensure that the required voltage and frequency match the available power source.
- To remove power from the computer, turn it off, remove the battery pack, and disconnect the AC adapter from the electrical outlet.
- To help prevent electric shock, plug the AC adapter and peripheral power cables into properly grounded power sources. These power cables may be equipped with three-prong plugs to provide an earth grounding connection. Do not use adapter plugs or remove the grounding prong from the power cable plug. If you use a power extension cable, use the appropriate type, two-prong or three-prong, to mate with the AC adapter power cable.
- Be sure that nothing rests on your AC adapter's power cable and that the cable is not located where it can be tripped over or stepped on.
- If you are using a multiple-outlet power strip, use caution when plugging the AC adapter's power cable into the power strip. Some power strips may allow you to insert the plug incorrectly. Incorrect insertion of the power plug could result in permanent damage to your computer, as well as risk of electric shock and/or fire. Ensure that the ground prong of the power plug is inserted into the mating ground contact of the power strip.



#### Battery (Safety Instructions, continued)

- Use only Dell battery modules that are approved for use with this computer. Use of other



types may increase the risk of fire or explosion.



- Do not carry a battery pack in your pocket, purse, or other container where metal objects (such as car keys or paper clips) could short-circuit the battery terminals. The resulting excessive current flow can cause extremely high temperatures and may result in damage to the battery pack or cause fire or burns.
- The battery poses a burn hazard if you handle it improperly. Do not disassemble it. Handle a damaged or leaking battery pack with extreme care. If the battery is damaged, electrolyte may leak from the cells and may cause personal injury.
- Keep the battery away from children.



- Do not store or leave your computer or battery pack near a heat source such as a radiator, fireplace, stove, electric heater, or other heat-generating appliance. When heated to excessive temperatures, battery cells could explode or vent, posing a risk of fire.



- Do not dispose of your computer's battery in a fire or with normal household waste. Battery cells may explode. Discard a used battery according to the manufacturer's instructions or contact your local waste disposal agency for disposal instructions. Dispose of a spent or damaged battery promptly.



#### Air Travel (Safety Instructions, continued)



- Certain Federal Aviation Administration regulations and/or airline-specific restrictions may apply to the operation of your Dell™ computer while you are onboard an aircraft. For example, such regulations/restrictions may prohibit the use of any personal electronic device (PED) that has the capacity for intentional transmission of radio frequency or other electromagnetic signals while on an aircraft.



- In order to best comply with all such restrictions, if your Dell portable computer is equipped with Dell TrueMobile™ or some other wireless communication device, please disable this device before you board the aircraft and follow all instructions provided by airline personnel with regard to such device.



- Additionally, the use of any PED, such as a portable computer, may be prohibited in aircraft during certain critical phases of flight, for example, takeoff and landing. Some airlines may further define the critical flight phase as any time the aircraft is below 3050 m (10,000 ft). Please follow the airline's specific instructions as to when the use of a PED is allowed.
-

## EMC Instructions

- Use shielded signal cables to ensure that you maintain the appropriate EMC classification for the intended environment. For parallel printers, a cable is available from Dell. If you prefer, you can order a cable from Dell at its world-wide website at <http://www.dell.com>.
  - Static electricity can harm electronic components inside your computer. To prevent static damage, discharge static electricity from your body before you touch any of your computer's electronic components, such as a memory module. You can do so by touching an unpainted metal surface on the computer's input/output panel.
- 

## When Using Your Computer

Observe the following guidelines to prevent damage to your computer.

- When setting up the computer for work, place it on a level surface.
- When traveling, do not check the computer as baggage. You can put your computer through an X-ray security machine, but *never* put your computer through a metal detector. If you have the computer checked by hand, be sure to have a charged battery available in case you are asked to turn on the computer.
- When traveling with the hard-disk drive removed from the computer, wrap the drive in a nonconducting material, such as cloth or paper. If you have the drive checked by hand, be ready to install the drive in the computer. You can put the hard-disk drive through an X-ray security machine, but *never* put the drive through a metal detector.
- When traveling, do not place the computer in overhead storage compartments where it could slide around. Do not drop your computer or subject it to other mechanical shocks.
- Protect your computer, battery, and hard-disk drive from environmental hazards such as dirt, dust, food, liquids, temperature extremes, and overexposure to sunlight.
- When you move your computer between environments with very different temperature and/or humidity ranges, condensation may form on or within the computer. To avoid damaging the computer, allow sufficient time for the moisture to evaporate before using the computer.

NOTICE: When taking the computer from low-temperature conditions into a warmer environment or from high-temperature conditions into a cooler environment, allow the computer to acclimate to room temperature before turning on power.

- When you disconnect a cable, pull on its connector or on its strain-relief loop, not on the cable itself. As you pull out the connector, keep it evenly aligned to avoid bending any connector pins. Also, before you connect a cable make sure both connectors are correctly oriented and aligned.
- Handle components with care. Hold a component such as a memory module by its edges, not its pins.
- When removing a memory module from the system board or disconnecting a peripheral device from the computer, wait 5 seconds after turning off the computer before removing the memory module or

disconnecting the device to help avoid possible damage to the system board.

- Clean the display with a soft, clean cloth and commercial window cleaner that does not contain wax or abrasives. Apply the cleaner to the cloth; then stroke the cloth across the display in one direction, moving from the top of the display to the bottom. If the display contains grease or some other contaminant, use isopropyl alcohol instead of commercial window cleaner.
  - If your computer gets wet or is damaged, follow the procedures described in "[Finding Solutions](#)." If, after following these procedures, you confirm that your computer is not operating properly, [contact Dell](#).
- 

## Ergonomic Computing Habits

 CAUTION: Improper or prolonged keyboard use may result in injury.

 CAUTION: Viewing the display or external monitor screen for extended periods of time may result in eye strain.

For comfort and efficiency, observe the following ergonomic guidelines when setting up and using your computer:

- Position your computer directly in front of you as you work.
- Adjust the tilt of the computer's display, its contrast and/or brightness settings, and the lighting around you (such as overhead lights, desk lamps, and the curtains or blinds on nearby windows) to minimize reflections and glare on the display.
- When using an external monitor with your computer, set the monitor at a comfortable viewing distance (usually 510 to 610 millimeters [20 to 24 inches] from your eyes). Make sure the monitor screen is at eye level or slightly lower when you are sitting in front of the monitor.
- Use a chair that provides good lower-back support.
- Keep your forearms horizontal with your wrists in a neutral, comfortable position while using the keyboard, touch pad, track stick, or external mouse.
- Always use the palmrest with the keyboard, touch pad, or track stick. Leave space to rest your hands when using an external mouse.
- Let your upper arms hang naturally at your sides.
- Sit erect with your feet resting on the floor and your thighs level.
- When sitting, make sure the weight of your legs is on your feet and not on the front of your chair seat. Adjust your chair's height or use a footrest, if necessary, to maintain proper posture.
- Vary your work activities. Try to organize your work so that you do not have to type for extended periods of time. When you stop typing, try to do things that use both hands.



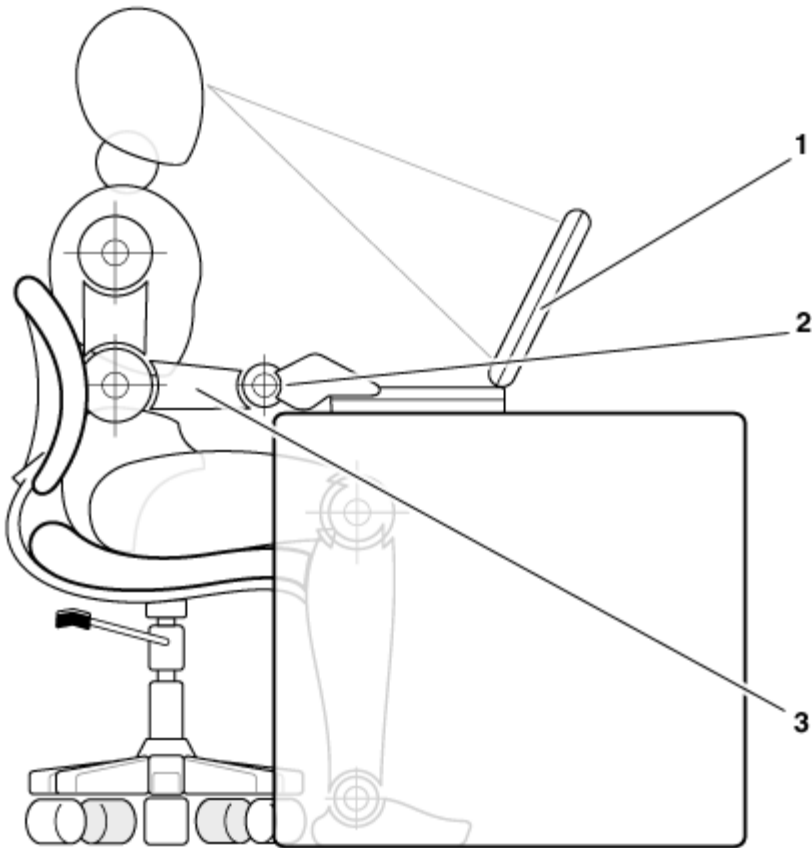

- 1 Computer positioned directly in front of user
- 2 Wrists relaxed and flat
- 3 Arms at desk level

---

## When Removing or Installing Memory Modules

Before removing or installing memory modules, perform the following steps in the sequence indicated.

**NOTICE:** The only time you should ever access the inside of your computer is when you are installing memory modules.

**NOTICE:** Wait 5 seconds after turning off the computer before disconnecting a peripheral device or removing a memory module to help prevent possible damage to the system board.

1. Turn off your computer and any attached peripherals.
2. Disconnect your computer and peripherals from AC power to reduce the potential for personal injury or shock. Also, disconnect any telephone or telecommunication lines from the computer.
3. Remove the main battery from the battery compartment and, if necessary, the secondary battery from the options bay.
4. Ground yourself by touching the unpainted metal surface of the I/O panel on the back of the computer.

While you work, periodically touch the I/O panel to dissipate any static electricity that might harm internal components.

---

## Protecting Against Electrostatic Discharge

Static electricity can harm electronic components inside your computer. To prevent static damage, discharge static electricity from your body before you touch any of your computer's electronic components, such as a memory module. You can do so by touching an unpainted metal surface on the computer's I/O panel.

As you continue to work inside the computer, periodically touch an I/O connector to remove any static charge your body may have accumulated.

You can also take the following steps to prevent damage from electrostatic discharge (ESD):

- When unpacking a static-sensitive component from its shipping carton, do not remove the component from the antistatic packing material until you are ready to install the component. Just before unwrapping the antistatic packaging, be sure to discharge static electricity from your body.
- When transporting a sensitive component, first place it in an antistatic container or packaging.
- Handle all sensitive components in a static-safe area. If possible, use antistatic floor pads and workbench pads.

The following notice may appear throughout this document to remind you of these precautions:

NOTICE: See "Protecting Against Electrostatic Discharge" in the safety instructions at the front of this guide.

---

[Back to Contents Page](#)

# Features and Options: Dell™ Latitude™ C600/C500 User's Guide

[Figure 1](#), [Figure 2](#), and [Figure 3](#) show the front, back, and bottom views of the computer.

Figure 1. Front View of the Computer

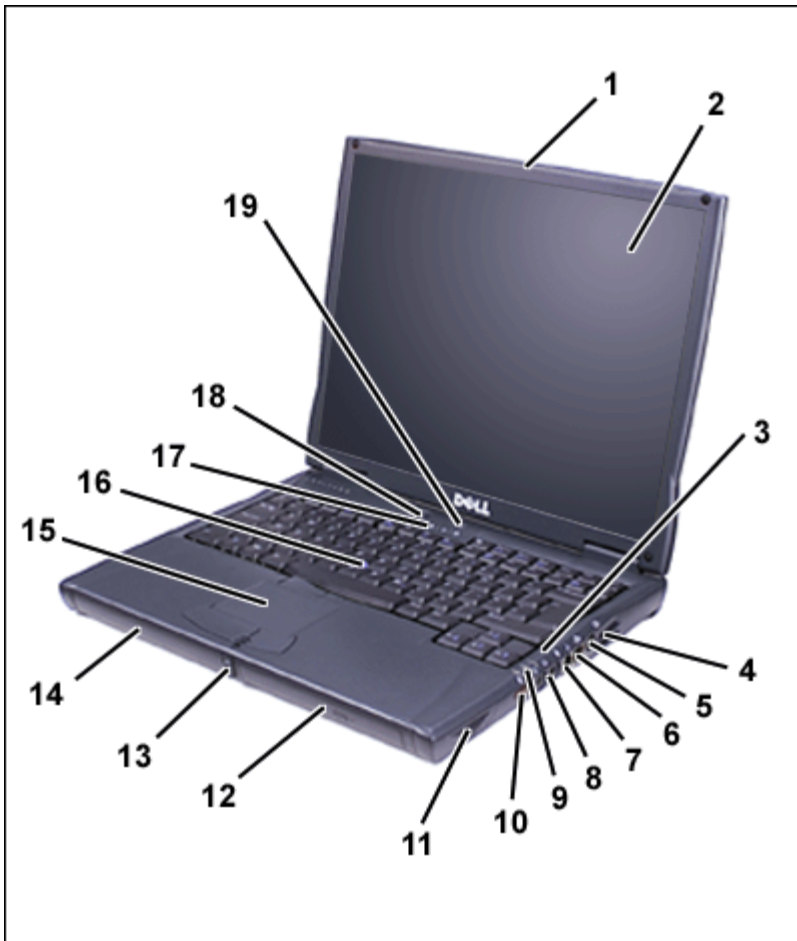

- 1 Display latch
- 2 Display
- 3 Microphone
- 4 Air outlet
- 5 S-Video connector
- 6 Optional network connector
- 7 Optional modem connector
- 8 Audio jack (1)
- 9 System status lights
- 10 Infrared port
- 11 Speaker
- 12 Modular bay
- 13 Display latch button
- 14 Battery bay
- 15 Touch pad
- 16 Track stick
- 17 Keyboard status lights
- 18 Power button
- 19 Dell AccessDirect™ key

**NOTICE:** To avoid overheating the computer, do not place any objects close to the air outlet or air vent, or allow any objects to cover up the outlet or air vent (see Figures 1 and 2).

Figure 2. Back View of the Computer

- 1 Speaker
- 2 Security cable slot
- 3 Hard-disk drive

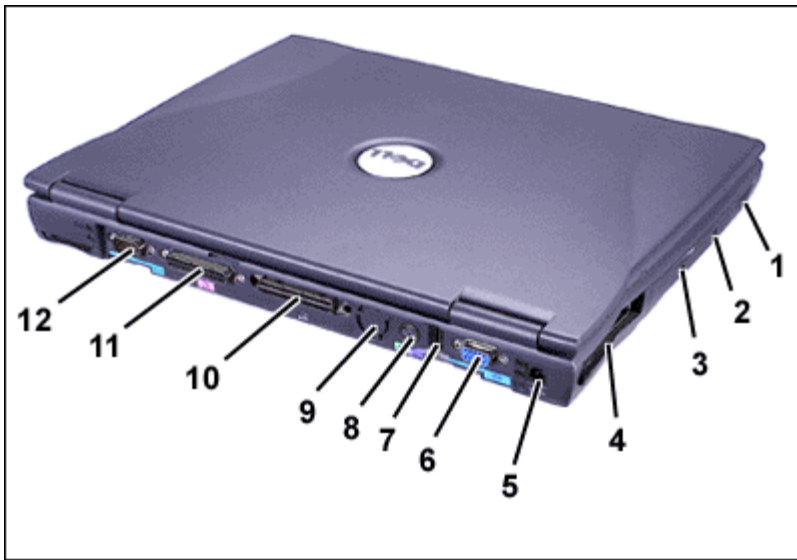

- 4 PC Card slots (2)
- 5 AC adapter connector
- 6 Video connector
- 7 USB connector
- 8 PS/2 connector
- 9 Air vent
- 10 Docking connector
- 11 Parallel connector
- 12 Serial connector

Figure 3. Bottom View

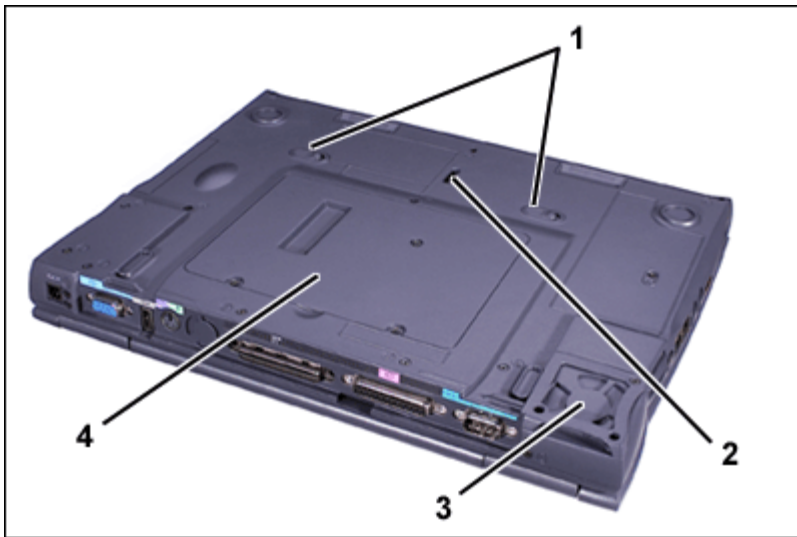

- 1 Module release latches (2)
- 2 Docking security latch
- 3 Fan
- 4 Memory module and mini-PCI cover

Your Dell computer has the following features:

- A 14.1-inch extended graphics array (XGA), thin film transistor (TFT) 1024 x 768 active-matrix color display (for C600 and C500 computers).
- A 14.1-inch super extended graphics array plus (SXGA+), TFT 1400 x 1050 active-matrix color display (for C600 computers only).
- A 12.1-inch super video graphics array (SVGA), TFT 800 x 600 active-matrix color display (for C500 computers only).
- A Dell AccessDirect key located above your keyboard that allows you to quickly access a frequently used program, such as Microsoft® Internet Explorer.

- A CD-ROM drive that can be used in the modular bay. When you unpack your computer, look for the CD-ROM drive in the accessories box of the shipping carton.
- 128-bit hardware-accelerated video support, with 8 megabytes (MB) of video memory.
  - Support for a zoomed video (ZV) PC Card in the lower PC Card connector.
  - ESS Maestro 3i audio controller with software wavetable support and 3D surround sound.
  - Two audio jacks for connecting external speakers, headphones, or a microphone.
  - Integrated microphone and two stereo speakers.
  - Accelerated graphics port (AGP) architecture that increases the computer's video performance.
- Energy efficiency. An ENERGY STAR® partner, Dell has determined that this product meets the ENERGY STAR guidelines for energy efficiency.
- A modular bay that supports modules such as a DVD-ROM drive, CD-ROM drive, CD-RW drive, diskette drive, second battery, second hard-disk drive, Zip drive, or SuperDisk drive. To make the computer as light as possible when you travel, use the travel module in the modular bay.



*NOTE: Your computer was shipped with a diskette drive in the modular bay. For information on removing the diskette drive and installing a different device in the bay, see "[Modular Bay](#)."*

- Optional V.90 Mini PCI Modem data/fax modem, PC99-compliant, and ACPI power management support (including remote wake-up for Windows® 2000).

For additional information on the Mini PCI Card modem, see "[Connecting Devices](#)" and the V.90 Mini PCI Modem *User's Guide*.

- Optional 10/100 LAN + V.90 Modem Mini PCI Card data/fax modem, PC99-compliant, and ACPI power management support (including remote wake-up for Windows 2000).

For additional information on the Mini PCI Card modem, see "[Connecting Devices](#)" and the 10/100 LAN + V.90 Modem Mini PCI Card *User's Guide*.

- A minimum of 64-MB synchronous dynamic random-access memory (SDRAM) module is standard. You can increase memory up to 512 MB by installing combinations of 64-, 128-, or 256-MB 100-megahertz (MHz) SDRAM modules in the two memory module sockets on the system board.
- Two power conservation modes—*suspend mode* and *suspend-to-disk mode*—that help you conserve battery power. If the batteries run out of power, suspend-to-disk mode prevents data loss by copying all system data to the hard-disk drive and turning off the computer.
- Connectors for two 3.3-volt (V) or 5-V PC Cards. The lower PC Card connector supports ZV PC Cards.





*NOTE: The PC Card controller supports the CardBus standard for 32-bit data transfer on the PC Card.*

- Hardware and software support for the Dell Latitude C/Port Family Advanced Port Replicator (APR)

and the Dell Latitude C/Dock Family Expansion Station.

- A Dell DualPoint integrated pointing device which includes both a touch pad and a track stick. These pointing devices are positioned for both left- and right-handed users. The track stick is positioned in the keyboard to allow you to move the cursor while keeping your fingers in a typing position. Two sets of left and right buttons, located above and below the touch pad, mimic mouse buttons. You can also perform many pointing functions by tapping the touch pad or the track stick. Click-and-drag buttonless functions are also supported.
- An 8-cell, 59 watt-hour (WH) lithium ion battery (standard) in the battery bay, with support for a second battery in the modular bay. For lithium ion batteries, the Dell ExpressCharge™ technology charges a single battery in approximately 1 hour when the computer is off or in suspend mode.
- Optional 4-cell, 26.5-WH lightweight lithium ion battery.

 CAUTION: Do not puncture, disassemble, or incinerate the computer's battery. The battery may present a fire or chemical burn hazard if mistreated. Do not expose the battery to temperatures above 60° Celsius (C) (140° Fahrenheit [F]). Keep the battery away from children. Handle damaged or leaking batteries with extreme care; electrolyte may leak from the cells and cause personal injury.

 CAUTION: If your battery is damaged, or if it no longer holds a charge, dispose of it promptly and properly. Do not dispose of it along with household waste. Call your local waste disposal agency or environmental agency for advice on disposing of the battery.

 CAUTION: Using the wrong battery type may present a risk of fire or explosion. Replace the battery only with the same or equivalent type purchased from Dell. You can use your computer's battery in any Latitude C-Family computer **except** for the Latitude CS or CSx computers. Do not attempt to use the battery in CS or CSx computers, and do not use a battery from those computers in your computer.

- High-performance parallel and serial ports and a multipurpose Personal System/2 (PS/2) connector for attaching external devices, a monitor connector for attaching an external monitor to your computer, and a Universal Serial Bus (USB) connector that supports stand-alone and hub devices.
- An infrared port that permits file transfer without the use of cable connections. The port is compatible with the Infrared Data Association (IrDA) Standard 1.1 (Fast IR) and Standard 1.0 (Slow IR) for use with external devices.
- Dell HyperCool™, an automatic thermal management™ system that uses a variable-speed fan, microprocessor speed changes, and Intel® Remote Heat Exchanger technology to keep the computer running at the optimum temperature.

The following software is included with your Dell computer:

- The Intel® SpeedStep™ technology is installed on your hard-disk drive.
- The Windows operating system that you ordered with your computer.
- The system setup program lets you view and change the system configuration. For more information,

see "[Using the System Setup Program.](#)"

- [Dell Diagnostics](#) for evaluating the computer's components and devices.



*NOTE: If Dell did not install an operating system on your hard-disk drive, the drivers, system utilities, and diagnostics are available separately from Dell. To order them, see "[Getting Help](#)" for the appropriate telephone number in your location.*

## Available Options

For information on the available options for your computer, visit the Dell Web site at <http://www.dell.com>.

---

[Back to Contents Page](#)

# Using Your Computer: Dell™ Latitude™ C600/C500 User's Guide

[Turning the Computer On and Off](#)

[Modular Bay](#)

[Diskette Drive](#)

[Removable Mass-Storage Drives](#)

[Display](#)

[Keyboard and Keypad Controls](#)

[Dell AccessDirect™ Key](#)

[Speaker Controls](#)

[Controlling the Cursor](#)

[PC Cards](#)

---

## Turning the Computer On and Off

To turn on the computer, press the power button. (See [Figure 1](#) in "Features and Options.")

To turn off the computer, follow the standard shutdown procedure described in your operating system documentation.



**CAUTION:** Do not allow your Latitude portable computer to operate for an extended period of time with the base resting directly on your body. With extended operation, heat can potentially build up in the base. Allowing sustained contact with the skin could cause discomfort or, eventually, a burn.

---

## Modular Bay

Your computer comes with a [diskette drive](#) installed in the modular bay. To use another device in the modular bay, first [remove](#) the diskette drive.

**NOTICE:** When drives are not inside the computer, they are fragile and must be handled carefully to avoid damage. Do not press down on the drives or place heavy objects on top of them. Place the drives in a travel case to keep them free of dust and liquids. Store the drives in a safe place.

**NOTICE:** If the computer is docked, turn off the computer and undock it before installing or removing a drive.

You can install the following modules in the modular bay:

- [Second battery](#)
- CD-ROM drive
- DVD-ROM drive
- CD-RW drive



- SuperDisk drive
- Zip drive
- Second hard-disk drive

To make the computer as light as possible, use the travel module in the modular bay in place of any of the available drives.

### Swapping Devices While the Computer Is Off

1. Save and close any open files, exit any open programs, and shut down the computer.
2. If the computer is connected (docked) to an Advanced Port Replicator (APR) or docking station, undock it.
3. Close the display and turn the computer over.
4. Slide and hold the latch release, and pull the device out of the bay.

NOTICE: To prevent damage to devices, place them in a travel case when they are not inserted in the computer. Store devices in a dry, safe place, and avoid pressing down on them or placing heavy objects on top of them.

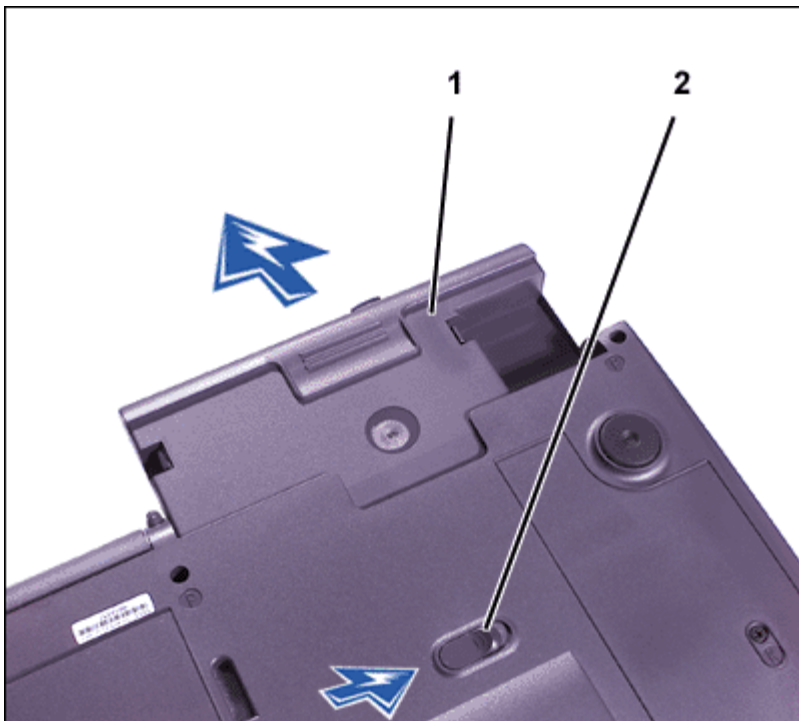

- 1 Device
- 2 Modular bay latch

NOTICE: Insert devices before you dock and turn on the computer.

5. Insert the new device into the bay, and push it until you hear a click.
6. Turn the computer over and open the display.
7. Turn on the computer.

## Swapping Devices While the Microsoft® Windows® Operating System Is Running

NOTICE: To prevent damage to the docking connector, do not remove or replace devices while the computer is connected to an APR or docking station.

In Windows XP

1. Double-click the  icon on the Windows taskbar.
2. Click the device you want to eject.
3. Keep the display open, and tilt the computer back so that you can access the bottom of the computer.
4. Slide and hold the latch release, and pull the device out of the bay.

NOTICE: To prevent damage to devices, place them in a travel case when they are not inserted in the computer. Store devices in a dry, safe place, and avoid pressing down on them or placing heavy objects on top of them.

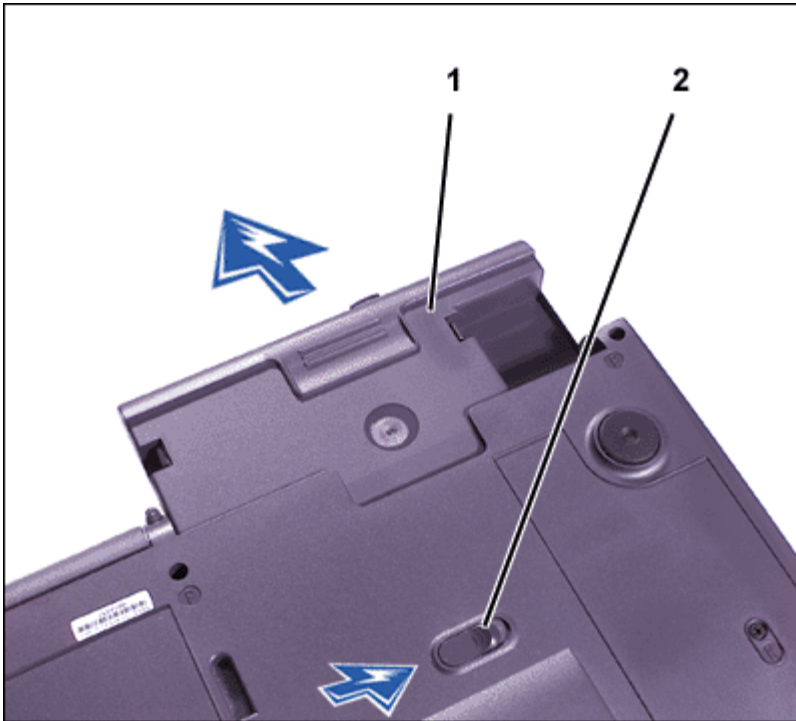

- 1 Device
- 2 Modular bay latch

5. Insert the new device into the bay, and push the device in until you hear a click.
6. If necessary, enter your password to unlock your computer.

In Windows 2000

1. Double-click the  icon on the Windows taskbar.

2. Click the device you want to eject and then click Stop.
3. Click OK, and wait until the device you want to eject is cleared from the list of devices in the Unplug or Eject Hardware window.
4. Keep the display open, and tilt the computer back so that you can access the bottom of the computer.
5. Slide and hold the latch release, and pull the device out of the bay.

NOTICE: To prevent damage to devices, place them in a travel case when they are not inserted in the computer. Store devices in a dry, safe place, and avoid pressing down on them or placing heavy objects on top of them.

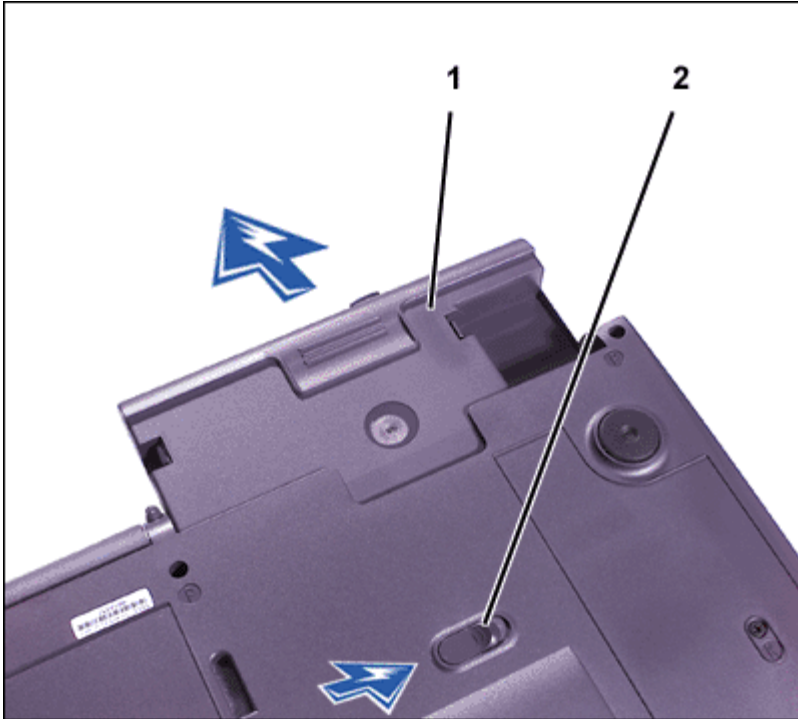

- 1 Device
- 2 Modular bay latch

6. Insert the new device into the bay, and push the device in until you hear a click.
7. Turn the computer over and open the display.
8. Press the power button to resume from standby mode.
9. If necessary, enter your password to unlock your computer.
10. When Windows resumes and recognizes the new device, click Close.

In Windows 98 and Windows NT

1. *In Windows 98*, right-click the Softex BayManager icon on the Windows taskbar.  
*In Windows NT*, right-click the Docking Services icon on the Windows taskbar.
2. Click Remove/Swap.

3. Keep the display open, and tilt the computer back so that you can access the bottom of the computer.
  4. Slide and hold the latch release, and pull the device out of the bay.
  5. Insert the new device into the bay, and push it until you hear a click.
  6. Click OK. Then click OK again to close the Softex BayManager window or the Softex Docking Services window.
- 

## Diskette Drive

Your computer was shipped with a 3.5-inch diskette drive (see [Figure 2](#)) in the modular bay.

To use the diskette drive:

1. Insert a 3.5-inch diskette into the drive (label side up and metal end first).
2. Push the diskette into the drive until the eject button extends outside the drive casing.

When data is being accessed from the diskette drive in the modular bay, the drive access light blinks.

**NOTICE:** Do not travel with a diskette in the diskette drive. Doing so could break the eject button and damage the drive.



*NOTE: You can use the diskette drive externally by connecting it to the [parallel connector](#) on the back of the computer.*

To remove a diskette from the drive:

1. Press the eject button to release the diskette.
2. Pull the diskette out of the drive.

To remove the drive or to use another device in the modular bay, see "[Modular Bay](#)."

**NOTICE:** When drives are not inside the computer, they are fragile and must be handled carefully to avoid damage. Do not press down on the drives or place heavy objects on top of them. Place the drives in a travel case to keep them free of dust and liquids. Store the drives in a safe place.



*NOTE: If the computer is docked, turn off the computer and undock it before installing or removing a drive.*

Figure 2. Diskette Drive Installed in Computer



## Caring for Diskettes

When handling and using diskettes, follow these precautions:

- Never use damaged diskettes in the computer
  - Do not store diskettes near magnetic sources
- 

## Removable Mass-Storage Drives

You can install removable-mass storage drive modules such as a CD-ROM drive or SuperDisk drive in the modular bay.

NOTICE: Follow these precautions when using your drive:

- Protect the drives when they are not in the modular bay. Do not squeeze the drive or place objects on top of it; doing so could damage the drive motor. Keep the drive as clean as possible.
- Do not use the drive while the computer is in motion. Doing so could interrupt the flow of data between the disc and the hard-disk drive or diskette drive.

For instructions on installing a removable mass-storage drive module in the modular bay, see "[Modular Bay](#)."



*NOTE: If the computer is docked, turn off the computer and undock it before installing or removing a drive.*

## CD-ROM, CD-RW, and DVD-ROM Drives

NOTICE: Always use compressed air to clean the lens in the drive. Never touch the lens.

To play a disc:

1. Make sure the appropriate drive is [installed in the modular bay](#).

2. Press the eject button on the front of the drive or press <Fn><F10>.
3. When the tray slides out, place the disc into the tray label side up.

Make sure that the CD is seated correctly on the spindle by pressing down on the disc until it clicks in place.

NOTICE: If the disc is not seated correctly, the drive or media can be damaged.

4. Gently push in the tray.

When the drive is in use, the drive access light blinks on the computer's front panel.

Figure 3. DVD-ROM, CD-ROM, or CD-RW Drive Installed in Computer



To eject the drive tray, perform one of the following tasks:

- press the eject button on the front of the drive
- press <Fn><F10> (on an external keyboard, press <Scroll Lock> instead of <Fn> if the External Hot Key option is enabled in the [system setup program](#))

You can only use CD-ROM, DVD-ROM, and CD-RW drives externally with a C/Port Family Advanced Port Replicator (APR) or a C/Dock Family Expansion Station.

If you are using the Microsoft Windows 98 operating system, disable the autoplay (auto insert notification) feature while you use the drive. (The autoplay feature can interfere with the computer's power management functions.) If Dell installed the operating system, the autoplay feature has been disabled. If you reinstall the operating system or if you installed it yourself, be sure to disable the autoplay feature if you want to use the drive.

For instructions on changing the Auto Insert Notification option, see the operating system user's guide.

DVD-ROM and CD-ROM drives are read-only devices that let you play most sound and video CDs. DVD-ROM drives can also play DVDs. CD-rewritable (CD-RW) drives can write to and play CD-recordables (CD-R) or CD-RWs and can play CDs. Dell has installed the appropriate device drivers on your hard-disk drive. See "[Technical Specifications](#)" for information on supported CD and DVD formats.

Caring for Discs

When handling and using the discs, follow these precautions:

- Never use a damaged or warped disc.
- Always hold the disc by its edges. Do not touch the surface of the disc.
- Use a clean, dry cloth to remove dust, smudges, or fingerprints from the surface of the disc. When cleaning, wipe from the center of the disc to the edge.
- Never use solvents, such as benzene, record cleaners, or antistatic sprays, to clean the disc.
- Do not write on the surface of the disc.
- Store discs in their containers, placing them in a cool, dry place. Extreme temperatures may damage discs.
- Do not bend or drop a disc.
- Do not place objects on top of a disc.

## Display

When you run the computer on battery power, set your computer's brightness control to the lowest setting that affords comfortable viewing. You can conserve battery power by using the minimum brightness setting (see Table 1)<sup>1</sup>.

Table 1. Adjusting Brightness

 **NOTE:** On an external keyboard, use <Scroll Lock> with the appropriate keys if the **External Hot Key** option is enabled in the ddd.

Keys	Function	Key Combinations
	Increase brightness	<Fn> + up arrow
	Decrease brightness	<Fn> + down arrow

Table 2. Controlling Display Modes

Function	Key Combinations
----------	------------------

Switch the computer's display between expanded mode and regular video mode.	<Fn><F7>
Switch the video image to the next display in the following sequence: the computer's display, an external monitor, or both displays simultaneously.	<Fn><F8>
Turn off the display. This key combination applies only to Windows 98, and Windows NT and may not be supported under certain conditions. <sup>2</sup>	<Fn><d>

<sup>1</sup> You cannot adjust contrast on your display.

<sup>2</sup> Certain key combinations may not function with the Advanced Configuration and Power Interface (ACPI) or may require configuration with the **Power Management Properties** window in the **Control Panel**. See "[Power Management and Conservation](#)."

## Expanded Video Mode

When working in text mode, you can select the font used to display text. Press <Fn><F7> to toggle between a regular serif font and a serif font with extra leading. Expanded video mode is useful if you are working in 800 x 600 resolution on a 14.1-inch XGA display.

## Customizing Display Resolution

In Windows XP

1. Click the Start button, and then click Control Panel.
2. Under Pick a category, click Appearance and Themes.
3. Under Pick a task..., click the area you want to change, or under or pick a Control Panel icon, click Display.
4. Try different settings for Color Quality and Screen resolution.

In Windows 2000, Windows 98, and Windows NT

1. Click the Start button, point to Settings, and then click Control Panel.
2. Double-click the Display icon, and then click the Settings tab.
3. Try different settings for Colors and Screen area.

For more information, see your operating system documentation.

If you choose a resolution or color palette that is higher than the display supports, the settings adjust automatically to the closest possible setting.

## Video Drivers and Video Resolution



The Dell-installed video drivers work with the operating system to let you customize the video resolution and number of screen colors on your display. For detailed information on video resolution, see "[Technical Specifications](#)."



*NOTE: The Dell-installed video drivers are designed to offer the best performance on your computer. Dell recommends that you use only these drivers with your factory-installed operating system.*

If the video resolution setting is higher than what the display supports, the computer display enters *pan mode*. The computer enters pan mode at the following resolutions (depending on display type):

- XGA: 1280 x 1024
- SXGA+: 1400 x 1050
- UGA: 1600 x 1200

In pan mode the screen resolution is too high to be completely displayed on the computer display. For example, the taskbar that usually appears at the bottom of the desktop may no longer be visible. To view the rest of the screen, use the touch pad or track stick to pan up and down and left and right.

NOTICE: Before adjusting the refresh rate on an external monitor, refer to the monitor's user's guide. You can damage the monitor by using an unsupported refresh rate.

To display more colors, select a lower resolution. If you select a resolution and color combination that the system does not support, the system automatically selects the next supported combination.



*NOTE: Color depth is based on 256 colors for 8-bit, 65,536 colors for 16-bit, and 4,294,967,296 colors for 32-bit displays.*

## Dual-Display Mode

With the Microsoft Windows 98 operating system, you can use an external monitor as an extension of your display. For more information, see "[Using an External Monitor in Dual-Display Mode](#)."

---

## Keyboard and Keypad Controls

Key combinations allow you to:

- Control [display](#) settings
- Eject [removable mass-storage drives](#)
- Control the [Dell AccessDirect™](#) key
- Adjust [speaker](#) volume
- Use the [embedded numeric keypad](#)
- Enter [power management](#) modes

- Enter the [system setup](#) program

 **NOTE:** On an external keyboard, use <Scroll Lock> with the appropriate keys if the **External Hot Key** option is enabled in the [system setup program](#).

## Embedded Numeric Keypad

To activate the keypad, press <Num Lk>. The Num Lock light turns on.

Figure 4. Embedded Numeric Keypad



As you work, you may want to use the embedded numeric keypad (see [Figure 4](#)) to enter numbers in spreadsheet or financial programs. The keypad shares some of the keys on your computer's keyboard. The number and symbol characters are marked to the right on these keys.

Table 3. Embedded Numeric Keypad Key Combinations

Function	When Keypad Is On
Turn off the keypad	<Num Lk>
Temporarily enable the lowercase characters/functions of the keyboard	<Fn><key>
Temporarily enables the uppercase characters/functions of the keyboard	<Fn><Shift><key>
Temporarily enable a cursor-control key in the keypad	<Shift><cursor key>
Function	When Keypad Is Off
Turn on the keypad	<Num Lk>
Temporarily enable a cursor-control key in the keypad	<Fn><cursor key>
Temporarily enable a number or symbol key in the keypad	<Fn><Shift><number key>

Table 4. Power Conservation Key Combinations

--	--

Function	Key Combinations
Turn off the display*	<Fn><d>
Turn off the hard-disk drive*	<Fn><h>
Activate suspend, sleep, or standby mode*	<Fn><Esc>
Activate suspend-to-disk mode*	<Fn><a> or <Fn><q> on French keyboards

\* *This key combination does not function with ACPI if the settings have not been configured with the **Power Management Properties** window in the **Control Panel**. See "[Power Management and Conservation](#)."*

Table 5. System Setup Program Key Combinations

Function	Key Combinations
Open the system setup program	<Fn><F1>*
Open the Battery Status screen of the system setup program	<Fn><F3>*

\* *This key combination does not function with ACPI.*

## Dell AccessDirect Key

The Dell AccessDirect key located above your keyboard allows you to quickly access a frequently used program, such as Microsoft Internet Explorer (see [Figure 1](#) in "Features and Options").

 **NOTE:** Using an external keyboard with your computer disables the AccessDirect key.

For information on using an AccessDirect key and viewing or changing key assignments, see the AccessDirect Help:

- Open the Dell AccessDirect program in one of the following ways:
  - Double-click the AccessDirect icon in the system tray on the Windows taskbar (normally in the bottom-right corner of the screen).
  - For Windows XP*, click the Start button and click Control Panel. In the Control Panel window, click Printers and Other Hardware. Click the Keyboard icon, and then click the AccessDirect tab.
  - For Windows 98 and Windows 2000*, click the Start button, point to Settings, and then click Control Panel. In the Control Panel window, double-click the Keyboard icon, and then click the AccessDirect tab.

- Click Help.

## Speaker Controls



**NOTE:** On an external keyboard, use <Scroll Lock> with the appropriate keys if the **External Hot Key** option is enabled in the [system setup program](#).

Table 6. Speaker Key Combinations

Function	Key Combinations
Turn the volume up	<Fn><Page Up>
Turn the volume down	<Fn><Page Dn>
Turn the speakers on or off	<Fn><End>

## Controlling the Cursor

Your Dell portable computer is equipped with the Dell DualPoint integrated pointing device, which includes two cursor pointing devices (see [Figure 5](#) and [Figure 6](#)) that perform traditional mouse functions: the touch pad and the track stick. You can choose to use the touch pad only, the track stick only, or both at the same time.

DualPoint device software allows you to set the default for the type of cursor pointing device you want to use, as well as sensitivity, motion, and drag and drop features of both the touch pad and track stick.



**NOTES:** When enabled, the DualPoint device (whether touch pad only, track stick only, or both) uses interrupt request (IRQ) 12. No other device can use IRQ12 while the DualPoint integrated pointing device is enabled.

If the **Pointing Device** option in the [system setup program](#) is set to **Touch Pad-PS/2 Mouse** (the default), you can use both the DualPoint device and an [external mouse](#) if one is attached.

### Using the Touch Pad

You can use the touch pad to move the cursor, just like a standard mouse (see [Figure 5](#)). The touch pad's two buttons, located directly below the touch pad, correspond to the left and right buttons on a mouse.

Figure 5. Touch Pad



To best use the touch pad, follow these techniques:

- To move the cursor, lightly slide your finger over the smooth sensor area.
- To select an object, gently tap once on the surface of the touch pad or use your thumb to press the left touch pad button.
- To select and move (or drag) an object, position the cursor on the object and tap down-up-down on the touch pad. On the second down motion, leave your finger on the touch pad and move the selected object by sliding your finger across the surface.
- To double-click an object, position the cursor on the object and then tap the touch pad or the left touch pad button twice.

### Using the Track Stick

You can use the track stick to move the cursor, just like a standard mouse (see [Figure 6](#)). The two buttons located between the touch pad and the space bar on the keyboard correspond to the left and right buttons on a mouse. The track stick functions much like the touch pad in that it allows you to use buttons for mouse functions or the pointing device itself.

Figure 6. Track Stick



To best use the track stick, use the following techniques:

- To move the cursor, apply pressure to the track stick with your right or left index finger. Press up or down to move the cursor to the top or bottom of the display screen. Press left or right to move the cursor to the left or right of the display screen.
- To select an object, tap once on the track stick or use your thumb to press the left track stick button. The track stick buttons perform standard mouse functions.
- To select and move (or drag) an object, position the cursor on the object. Then press and hold the left track stick button. Leave your thumb on the button and move the selected object by pressing the track stick in the desired direction.
- To double-click an object, position the cursor on the object and then tap the left track stick button twice or tap the track stick itself twice. The track stick functions much like the touch pad in that it allows you to use buttons for mouse functions or the pointing device itself.

## Customizing the DualPoint Integrated Pointing Device

In Windows XP

1. Click the Start button, and then click Control Panel.
2. Under Pick a category, click Printers and Other Hardware.
3. Click the Mouse icon, and then click the Touch tab in the Mouse Properties window.
4. In the drop-down menu, click to select either the touch pad or the pointing stick (track stick) and click Apply.
5. Click OK to save the settings and close the window.

The DualPoint device software allows you to set the default for the type of cursor pointing device you want to use, as well as sensitivity, motion, and drag and drop features of both the touch pad the track stick.

Click in the Disable this Device box to disable the selected touch pad or track stick settings. If you

docked your computer with a mouse, the touch pad and track stick settings are automatically disabled.

In Windows 2000, Windows 98, and Windows NT

1. Click the Start button, point to Settings, and then click Control Panel.
2. Double-click the Mouse icon and click the Touch tab in the Mouse Properties window.
3. In the drop-down menu, click to select either the touch pad or the pointing stick (track stick) and click Apply.
4. Click OK to save the settings and close the window.

To open the Mouse Properties window, you can also right-click the Touch Pad icon on the taskbar, and click Touch Pad Properties.

To disable the selected touch pad or track stick settings, click in the Disable this Device box. If you docked your computer with a mouse, the touch pad and track stick settings are automatically disabled.

The DualPoint device software allows you to set the default for the type of cursor pointing device you want to use, as well as sensitivity, motion, and drag and drop features of both the touch pad and track stick.

Click in the Disable this Device box to disable the selected touch pad or track stick settings. If your computer is docked with a mouse, the touch pad and track stick settings are automatically disabled.

### Changing the Track Stick Cap

1. Pull the cap off the track stick (see Figure 7).

Figure 7. Removing the Track Stick Cap

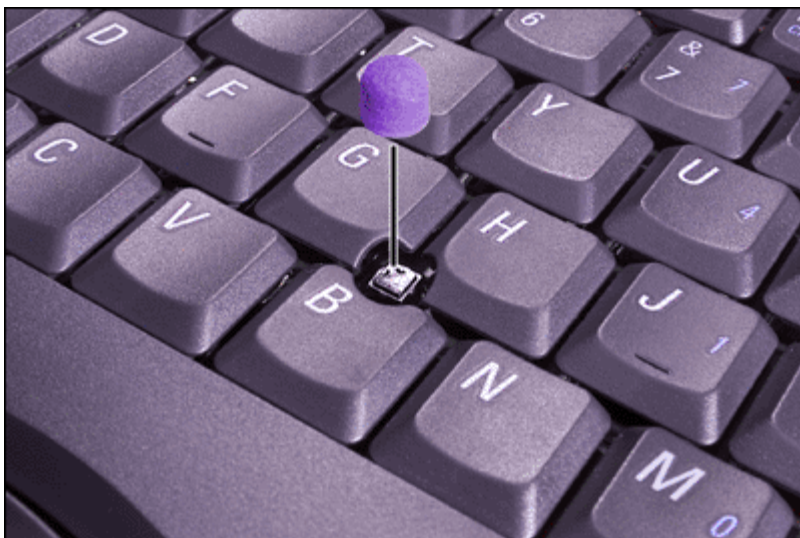

2. Align a new cap over the square track stick post and gently press the cap down onto the post.
3. Test the track stick to ensure that the cap is seated properly.

Your computer came with four additional track stick caps in assorted colors. You may need to change the track stick cap if it wears down from prolonged use.

---

## PC Cards

The computer has a slot into which you can [install](#) up to two PC Cards if the PC Cards comply with Release 2.01 of the Personal Computer Memory Card International Association (PCMCIA) standard and Release 4.2 of the Japanese Electronic Industry Development Association (JEIDA) standard. See "[Technical Specifications](#)" for information on supported PC Cards.



*NOTES: A PC Card is not a boot device. The "type" of a card refers to its thickness, not its functionality.*

*Your computer recognizes most I/O cards and automatically loads the device driver associated with that card.*

NOTICE: Extended cards are longer versions of standard PC Cards. They fit into and operate correctly with your computer. Follow these precautions when using extended PC Cards:

- Make sure that nothing strikes the exposed end of an installed extended card. Otherwise, damage to the system board can occur.
- Always remove an extended PC Card before you pack the computer in its carrying case.
- Try installing an extended card in the upper PC Card connector to allow room for a second PC Card.

### Installing PC Cards

1. Stop the card process with the PC Card configuration utility on the task bar.

You do not need to turn off your computer or exit suspend or standby mode before you install a PC Card.

2. If necessary, remove the blank from the PC Card connector you intend to use (see "[Removing PC Cards or Blanks](#)").
3. Hold the card with its orientation symbol pointing into the slot and the top side of the card facing up.
4. Insert the card into the slot, press in firmly until the card is completely seated in the internal PC Card connector (see [Figure 8](#)), and rotate the PC Card eject button to its original position.

PC Cards are generally marked with a symbol, such as a triangle or an arrow, to indicate which end should be inserted into the slot. The cards are keyed to prevent incorrect insertion. If card orientation is not clear, see the documentation that came with the card.

Figure 8. Installing a PC Card





5. If you encounter resistance when inserting it, do not force the card. Check the card's orientation and try again.



*NOTE: Use a ZV PC Card in the lower connector only.*

## PC Card Blanks

Save the blank to use whenever you do not have a PC Card installed. The blank protects the PC Card connector from dust and other particles.

## Removing PC Cards and Blanks

**NOTICE:** If you are using Windows 98 or Windows 2000, use the PC Card configuration utility on the taskbar to select and stop a card before you remove it. If you do not stop the card using the configuration utility, you could lose data from open application programs.

1. Stop the PC Card by using the PC Card configuration utility on the taskbar.
2. Rotate the PC Card eject button outward (see step 1 in Figure 9) for the card or blank you want to eject.

Figure 9. Removing a PC Card



3. Press the PC Card eject button (see step 2 in Figure 9).

The PC Card or blank protrudes from the slot slightly. It does not come out all the way.

4. Gently remove the card or blank (see step 3 in Figure 9), and rotate the PC Card eject button to its original position.

## Configuring PC Cards

The PC Card configuration utility performs the following functions:

- Notifies you whenever a PC Card is inserted and tells you how the card is configured
- Automatically loads the proper device driver if it is available on the hard-disk drive
- If drivers are not available on the hard-disk drive, prompts you to install them using the device driver CD that came with the card

The operating system automatically detects a PC Card and opens the Add New Hardware menu from the Control Panel. For information, see the PC Card operating system documentation.

---

[Back to Contents Page](#)

# Connecting Devices: Dell™ Latitude™ C600/C500 User's Guide

- [About the I/O Connectors](#)
- [External Monitor](#)
- [Parallel Devices](#)
- [Docking Devices](#)
- [USB Devices](#)
- [Mouse, External Keyboard, and External Numeric Keypad](#)
- [Serial Devices](#)
- [AC Adapter](#)
- [Infrared Port](#)
- [Modem](#)
- [Network](#)
- [S-Video \(Television\)](#)
- [Audio Devices](#)

---

## About the I/O Connectors

You can connect external devices to the input/output (I/O) connectors. The computer's basic input/output system (BIOS) detects the presence of external devices when you boot (start) or reboot your computer. [Figure 1](#) shows the I/O connectors on the back of your computer; [Figure 2](#) shows the modem, TV, and audio connectors on the side of the computer.



*NOTES: Some external devices require you to load software called device drivers into system memory before the devices will work. These device drivers help your computer recognize the external device and direct its operation. Instructions for installing this software are usually included in the upgrade kits.*

*For instructions on using the I/O connectors on the C/Port Family Advanced Port Replicator (APR) or C/Dock Family Expansion Station, see the documentation that came with that device.*

**NOTICE:** When disconnecting external devices from the back of the computer, wait 5 seconds after turning off the computer before you disconnect a device to avoid possible damage to the system board.

Figure 1. I/O Connectors on Back of Computer

- 1 [Serial](#)
- 2 [Parallel](#)
- 3 [Docking](#)
- 4 [PS/2 connector \(for mouse, keyboard, or](#)

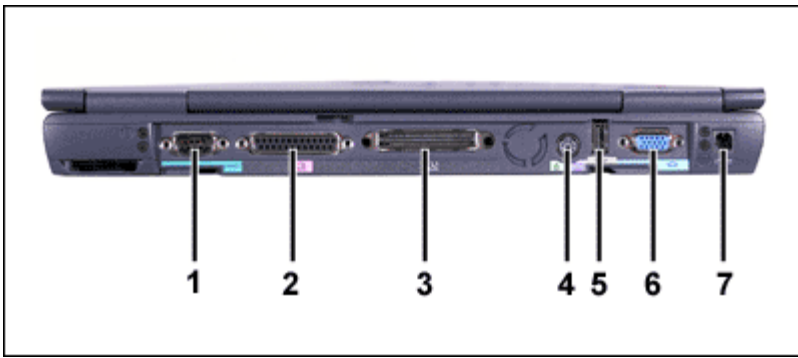

- keypad)
- 5 [USB](#)
- 6 [Video](#)
- 7 [AC power](#)

Figure 2. I/O Connectors on Right Side of Computer



- 1 [S-Video connector](#)
- 2 [Optional network connector](#)
- 3 [Optional modem connector](#)
- 4 [Audio jacks \(2\)](#)

## External Monitor

You can use the 15-hole video connector to attach an external monitor to the computer. With the Microsoft® Windows® 98 operating system, you can use an external monitor as an extension of your display in [dual-display](#) mode.

### Connecting an External Monitor

NOTICE: Do not place the monitor directly on top of your portable computer, even if it is closed. Doing so can crack the computer case and the display.

1. Make sure that the external monitor is turned off. Set the monitor on a monitor stand, desk top, or other

level surface near your computer.

2. Connect the external monitor's video cable to the computer.

Plug the video cable connector into the matching video connector on the back of the computer, as shown in Figure 3. If the video cable is not permanently attached to the monitor, connect it to the monitor.

Figure 3. Connecting an External Monitor



Be sure to tighten all the screws on the video cable connector(s) to eliminate radio frequency interference (RFI).

3. Connect your external monitor to a grounded electrical outlet.

Plug the three-prong connector on one end of the monitor's power cable into a grounded power strip or some other grounded power source. If the cable is not permanently attached to the monitor, connect it to the monitor.

You can also connect an external monitor to the C/Port Family APR or the C/Dock Family Expansion Station.



*NOTE: If you are using the Microsoft Windows 98 operating system, you can use an external monitor as an extension of your display. For more information, see your operating system documentation or "[Using an External Monitor in Dual-Display Mode.](#)"*

## Using an External Monitor

When an external monitor is connected to the computer, the video image automatically appears on the external monitor's screen when you boot your computer.

To toggle the video image between the display, an external monitor, or both simultaneously, press <Fn><F8> on the keyboard. Press <Scroll Lock><F8> on an external keyboard if the External Hot Key option is enabled in the [system setup program](#).

If the external monitor is turned off when you boot your computer, the computer still sends the video image to the external monitor, but you will not see an image on either the computer's display or the external monitor.

To see an image, turn on the external monitor or switch the video image to the computer's display by pressing <Fn><F8> on the keyboard or <Scroll Lock><F8> on an external keyboard if the External Hot Key option is enabled in the system setup program.



*NOTE: If you are using your external monitor at a resolution greater than the display supports, the simultaneous display feature is disabled. To use the display, switch to a resolution that the computer supports, or disconnect the external monitor and restart your computer.*

## Using an External Monitor in Dual-Display Mode

With the Windows 98 operating system, you can use an external monitor as an extension of your display.

1. Connect the [external monitor](#), TV, or projector.
2. Click the Start button, point to Settings, and then click Control Panel.
3. Double-click the Display icon.
4. In the Display Properties window, click the Settings tab.
5. Change the Colors option to 256 Color or High Color (16 bit).
6. Change the Screen Area to the appropriate size for your display.
7. Click the Advanced... button.
8. When the RAGE MOBILITY video driver properties window appears, select the Displays tab.
9. Click the Monitor button.

The dual-display option is activated.

10. Click Yes when prompted to restart your system.
11. When the system has restarted, open the Display icon in the Control Panel.
12. Click the Settings tab.

Two displays now appear in this window.

13. Click the display that is grayed out. When asked if you want to enable this display, click Yes, and then click Apply.

---

## Parallel Devices

You can attach a parallel device (usually a printer) to the 25-hole parallel connector. You can also connect the diskette drive to the parallel connector.

### Connecting a Diskette Drive to the Parallel Connector

You can use the the diskette drive as a second external device if you already have a device in the modular bay. The diskette drive letter is A, unless a diskette drive is already installed in the modular bay, in which case the drive connected to the parallel connector is drive B. For more information on using the diskette drive, see "[Diskette Drive](#)."

Use the parallel diskette drive cable that came with the computer to connect the drive to the parallel connector on the I/O panel, as shown in Figure 4.

 **NOTE:** If you are running the Microsoft Windows 98 or Windows 2000 operating system on your computer and the **Diskette Reconfig** option is set to **Any Time** in the [system setup program](#), you do not have to reboot the computer when you connect the diskette drive to the parallel connector. If you are running the Microsoft Windows NT® operating system on your computer, you do need to reboot the computer after you connect the diskette drive.

Figure 4. Using the Diskette Drive As an External Device



**NOTICE:** When the diskette drive is not being used externally, remove the parallel diskette-drive cable from the parallel connector.

**NOTICE:** Use the parallel diskette-drive cable only with the diskette drive. Do not try to connect any other device to the computer with this cable.

The drive access light does not blink when data is being accessed from the diskette drive connected to the parallel connector.

**NOTICE:** Protect the diskette drive when it is not in the modular bay. Do not squeeze the drive or place objects on top of it; doing so could damage the drive motor.

---

## Docking Devices

You can attach your computer to Dell's C/Port Family APR and C/Dock Family Expansion Station docking devices through the docking connector. For information on docking your computer, see the documentation that came with your docking device.

---

## USB Devices

You can attach a USB hub device to the USB connector. The USB hub device can support multiple USB devices (typically low-speed peripherals such as mice, keyboards, printers, and computer speakers). The C/Port APR Family and the C/Dock Expansion Station Family docking solutions have two USB connectors.

 **NOTE:** *If you are using a USB external keyboard, do not enter the system setup program by using a keyboard command on an external keyboard. Instead, press <Fn><F1> on the computer's keyboard.*

---

## Mouse, External Keyboard, and External Numeric Keypad

You can attach a PS/2-compatible device such as a mouse, 101- or 102-key keyboard, or numeric keypad to the mini-DIN PS/2 connector (see Figure 5).

You can also connect these devices to the C/Port Family APR or the C/Dock Family Expansion Station.

Figure 5. External Mouse, Keyboard, or Keypad Connector



### Mouse

If the Pointing Device option in the [system setup program](#) is set to Touch Pad-PS/2 Mouse (the default), you can use both the DualPoint device and an external PS/2-compatible mouse if one is attached. If you disconnect the mouse, to use the advanced features of the DualPoint integrated pointing device, you must shut down the computer or enter suspend or standby mode and then resume. If you do not do this, the DualPoint integrated pointing device resumes operation in standard PS/2 mode, which means that many of the configuration features are disabled.

If you are using a PS/2-compatible mouse that is not made by Microsoft and the mouse does not work properly, reboot the computer. If the mouse still does not work, install the drivers from the diskette or CD that came with the mouse and reboot the computer.

### External Keyboard

You can use the computer's keyboard and an external keyboard at the same time. When you attach a keyboard to the computer, the embedded numeric keypad is automatically disabled.



On an external keyboard, the <Scroll Lock> key acts the same way as the <Fn> key on the computer's keyboard (if the External Hot Key option is enabled in the [system setup program](#)).

## External Numeric Keypad

When you attach an external numeric keypad to the computer, the numeric keypad on the computer keyboard is automatically disabled. The lights on the integrated keyboard track the operation of an external numeric keypad.

---

## Serial Devices

To attach a serial device to the computer, use the 9-pin serial connector.

The serial port passes data in serial format (one bit at a time over one line). This port supports a variety of devices that require serial data transmission, including a serial mouse, serial printer, plotter, or external modem.

---

## AC Adapter

You can attach the [AC adapter](#) to the computer by using the AC adapter connector. The AC adapter converts AC power to the DC power required by the computer.

You can connect the AC adapter with your computer turned either on or off.

The AC adapter works with electrical outlets worldwide. However, power connectors vary among countries. Before using AC power in a foreign country, you may need to obtain a new power cable designed for use in that country.

---

## Infrared Port

The computer's infrared (IR) port lets you transfer files from your computer to another IR-compatible device without using cable connections. When you receive your computer, the IR port is disabled. You can [enable the IR port](#) by selecting the appropriate setting for the Infrared Data Port option in the system setup program.

After you enable the IR port, to transfer files:

1. Point the computer's IR port directly at the compatible device's IR port. IR devices transmit data in a 30-degree cone of IR light.
2. Start the data communications software on both devices, and then begin to transfer files. Read the documentation that came with your compatible device to make sure that you operate it correctly.



*NOTES: Make sure that no books, papers, or other objects come between the two IR devices and that the two devices are within the 30-degree cone.*

*If the IR device does not work, the computer and device may be misaligned. Move the device and*

*computer to bring them into the 30-degree cone.*

The Microsoft Windows NT 4.0 operating system does not support the use of IR devices.

The IR port is compatible with Infrared Data Association (IrDA) 1.1 (Fast IR) and 1.0 (Slow IR) standards. An IR data stream is transmitted through a lens in the computer up to a distance of 1 meter (m) (3.3 feet [ft]). This light is received by a compatible computer, printer, mouse, or remote control.

The default address of the IR port is COM3. To avoid resource conflicts with other devices, remap the address of the IR port.

When the computer is docked with the C/Port APR Family or C/Dock Expansion Station Family docking solution, the IR port on the computer is automatically disabled.

For more information about using an IR device, see the documentation that came with your operating system.

---

## Modem

You can connect a telephone line to the optional modem through the [modem connector](#) on the right side of the computer (see Figure 6).

NOTICE: Do not confuse the modem and network connectors on your computer. Do **not** plug a telephone line into the network connector.

Figure 6. Modem and Network Connectors

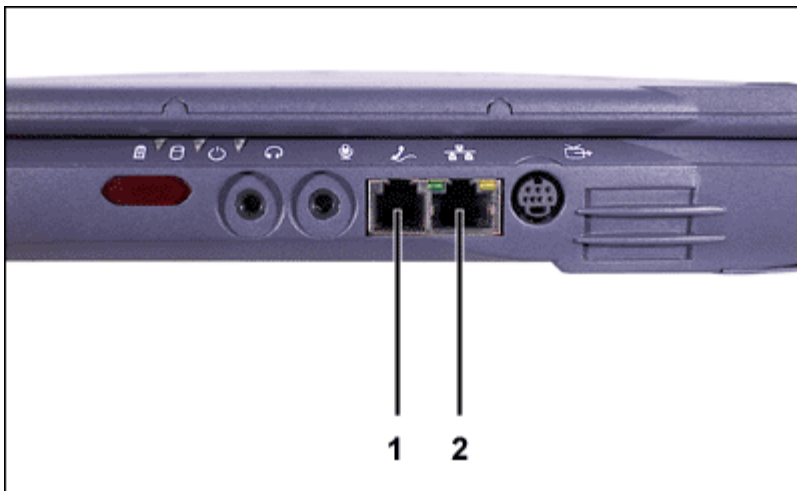

- 1 Optional modem connector
- 2 Optional network connector

For information on using the modem, see the online modem documentation supplied with your computer. To access this documentation, double-click the Dell Documents icon on the Windows desktop, click System Information, and then click Communications.

---

## Network

You can connect to the integrated network interface controller (NIC) through the optional [network connector](#) on the right side of the computer (see Figure 6).

NOTICE: Do not confuse the modem and network connectors on your computer. Do **not** plug a telephone line into the network connector.

For information on using the integrated NIC, see the online NIC documentation supplied with your computer. To access this documentation, double-click the Dell Documents icon on the Windows desktop, click System Information, and then click Communications.

---

## S-Video (TV)

You can connect a TV with an S-Video connector to your computer. Figure 7 shows the location of the S-Video connector.

Figure 7. Connecting a TV



To connect your computer to a TV, follow these guidelines:

- If your TV uses an S-Video cable for video input:
  1. Connect the S-Video cable to your computer's S-Video TV-out connector (see Figure 7).
  2. Connect the other end to your TV's S-Video connector.

Connecting the S-Video cable that came with your TV to the TV's S-Video connector and to the computer's S-Video TV-out connector allows your computer to play video on the TV.
- If your TV uses a composite video cable for video input:
  1. Connect the composite TV-out adapter cable that came with your computer to your computer's S-Video TV-out connector (see Figure 7).
  2. Connect the other end of the composite TV-out adapter cable to your TV's composite video cable.
  3. Connect the composite video cable to your TV's composite video connector.

You need both the composite TV-out adapter cable that came with your computer and the composite video cable that came with your TV. Connecting these cables together, then

connecting them to your TV composite video-in connector and your computer's S-Video TV-out connector, allows your computer to play video on the TV.

---

## Audio Devices

You can connect audio devices such as speakers, microphones, and headphones to your computer. [Figure 8](#) shows the locations of the audio jacks and the S-Video connector.

- Connect the audio cable from a microphone to the microphone jack, also called the MIC IN jack.
- Connect speakers or headphones to the headphones/speakers jack, also called the LINE OUT jack.
- Connect the S-Video cable from a record/playback device to the S-Video connector. See "[S-Video \(TV\)](#)." VCRs and video cameras are record/playback devices.

Figure 8. Connecting Audio and S-Video Devices

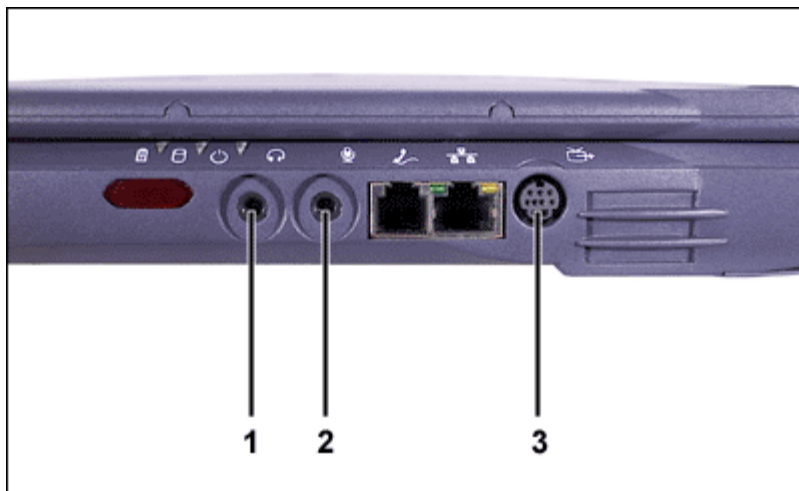

- 1 Headphones/speakers (LINE OUT) jack
- 2 Microphone (MIC IN) jack
- 3 S-Video connector

---

[Back to Contents Page](#)

# Microsoft® Windows® XP Features: Dell™ Latitude™ C500/C600 User's Guide

- [Overview](#)
  - [New User Interface](#)
  - [Files and Settings Transfer Wizard](#)
  - [Application and Device Compatibility](#)
  - [System Restore](#)
  - [User Accounts and Fast User Switching](#)
  - [Home and Small Office Networking](#)
  - [Internet Connection Firewall](#)
- 

## Overview

Based on an enhanced version of the Windows 2000 operating system, Windows XP is available in consumer and business editions: Windows XP Home Edition and Windows XP Professional. The features discussed are available in both editions, but the Professional version, designed for business environments, includes additional productivity, security, networking, and management features important in business environments.

For home users, Windows XP brings the significantly increased stability and security inherent in the Windows 2000/Windows NT® operating systems. It also provides better support for portable computers. Key new Windows XP features include:

- An improved desktop and user interface
- Files and Settings Transfer Wizard
- Application program compatibility enhancements
- System Restore
- Fast User Switching\*
- Expanded home and small office networking functions\*
- A personal firewall for always-on Internet connections\*

\*Home and small office features

## Help and Support Center

The Help and Support Center, introduced with Microsoft Windows Millennium Edition (Me), replaces Windows Help from earlier operating systems. The Help and Support Center provides an integrated resource center for information and assistance in using, configuring, and troubleshooting your computer and installed hardware devices and software. For Windows XP, the Help and Support Center features expanded search capabilities, including full-text search and the capability to search across multiple remote sites in addition to files resident on the hard-disk drive. You can use a single print command to print an entire chapter of help content.

To open Help and Support Center, click the Start button, and then click Help and Support. From the home page, you can conduct a search or select categories of information, leading to task and information topics covering the use of your computer. Click User and System Guides for information on using your Dell™ computer, including installed hardware devices and software.

---

## New User Interface

Windows XP features a redesigned user interface with a new visual style, a less cluttered desktop, and built-in desktop cleanup features. Window layout has also been changed for Windows XP and, as in the Control Panel, emphasizes task presentation. The Start menu has been redesigned. The left half of the new Start menu includes the most frequently used icons. As you use your computer, the icons in this area are changed and rearranged depending on your computer usage patterns. If you wish to keep one of the icons permanently in its location, right-click the icon and click Pin to Start menu.

To access all the programs installed on the computer, click All Programs at the bottom of the Start menu. The right half of the new Start menu contains useful icons for accessing your files, configuring the computer, and finding information and assistance. The Dell Solution Center icon opens a portal to services and application programs installed on your Dell computer.

## Switching to Classic View

If you wish, you may change the appearance of the Start menu, desktop and windows, or Control Panel layout to that of earlier Windows operating systems. These classic view options are independent of each other.

You can easily switch back and forth between the new Control Panel category view and the classic icon view by clicking Switch to Classic View or Switch to Category View in the upper left area of the Control Panel window. This can be handy if you would like to take advantage of the new, task-oriented features of the Windows XP Control Panel, but you are accustomed to performing a particular task with the icon-oriented classic Control Panel.

To change the appearance of the Start menu to the classic view:

1. Right-click the empty area on the task bar.
2. Click Properties.
3. Click the Start Menu tab.
4. Select Classic Start Menu and click OK.

If you prefer the classic window and button appearance, perform the following steps:

1. Right-click anywhere on the main desktop screen and click Properties.
2. Click the Appearance tab.
3. From the Windows and buttons dropdown box, select Windows Classic style.
4. To customize color, font, and other classic desktop options, click Advanced.
5. When you have completed your appearance selections, click OK.

## Clean Desktop Wizard

Another feature of Windows XP is the Desktop Cleanup Wizard. The wizard runs 7 days after you first start your computer and every 60 days after that. The Desktop Cleanup Wizard first opens a dialog box informing you that there are unused icons on the desktop and asking whether you want to run the wizard. If you elect to run the wizard, it places unused desktop icons in a folder.

The default for the Desktop Cleanup Wizard is on. To turn the wizard off:

1. Right-click anywhere on the main desktop screen and click Properties.
2. Select the Desktop tab and click Customize Desktop.
3. In the Desktop cleanup options make sure that the Run Desktop Cleanup Wizard every 60 days box is not checked.

You can run the Desktop Cleanup Wizard anytime by following these steps:

1. Right-click anywhere on the main desktop screen and select Properties.
2. Click the Desktop tab and click Customize Desktop.
3. Click Clean Desktop Now.
4. When the Desktop Cleanup Wizard appears, click Next>.
5. In the Shortcuts list, deselect any shortcuts you want to leave on the desktop, and then click Next>.
6. Click Finish to remove the shortcuts and close the wizard.

## Taskbar Grouping

The Windows taskbar is a row of buttons that typically displays across the bottom of the screen. The taskbar includes the Start button and a button for each open application. (The taskbar also includes the Quick

Launch icons and the notification area.) Windows XP groups multiple instances of the same application on the taskbar. For example, if six instances of Internet Explorer are open, each displaying a button on the taskbar, Windows XP groups the buttons next to one another on the taskbar. If space becomes an issue on the taskbar, Windows XP consolidates all the Internet Explorer buttons into a single button. When clicked, that button expands to a menu of the six Internet Explorer active sessions.

## Notification Area Cleanup

Over time, software icons tend to proliferate in the notification area, the area in the bottom right corner of the Windows desktop. Windows XP detects when icons in the notification area are not being accessed and hides them. A caret, or chevron, button indicates that there are hidden icons that can be viewed by selecting the button. You can also configure the notification area manually by right-clicking the taskbar, selecting Properties, and then clicking Customize... in the Taskbar and Start Menu Properties window. For example, you may choose to hide the antivirus program icon because it is rarely accessed, but display the audio volume icon because it is used frequently. The notification area cleanup feature is automatically enabled when the operating system is installed, but you may disable it by unchecking Hide inactive icons in the Taskbar and Start Menu Properties window.

---

## Files and Settings Transfer Wizard

The Files and Settings Transfer Wizard is used to migrate personal files and settings from one computer to another (for instance, when upgrading to a new computer). Personal files include the documents, images, spreadsheets, presentations, and e-mail messages on your computer. User settings include display properties, window sizes, toolbar settings, dial-up connections, Internet bookmarks, and so forth on your computer. The Files and Settings Transfer Wizard is run on a source (old) computer to collect the data and is run again on the destination (new) computer to import the data. If the old computer is using an earlier operating system, the wizard can be launched either from the Windows XP CD or from a diskette created on the new Windows XP computer. You transfer the data to the new computer over a network or direct serial connection, or store it on a removable medium such as a diskette, Zip disk, or writable CD.

To use the Files and Settings Transfer Wizard:

1. On the new Windows XP computer, click the Start button, point to All Programs—> Accessories —> System Tools, and click Files and Settings Transfer Wizard.
2. On the Files and Settings Transfer Wizard welcome screen, click Next>.
3. On the Which computer is this? screen, select New Computer, and then click Next>.

The Do you have a Windows XP CD? screen appears.

The Files and Settings Transfer Wizard guides you through the steps necessary to transfer user settings, personal files, or both to the new computer. If a CD drive is not available, the wizard allows you to create a wizard diskette to run on your old computer.



**NOTE:** The time required to collect and transfer data depends on the amount of data collected. Times can vary from just a few minutes to several hours.

---



# Application and Device Compatibility

Although Windows XP is designed to be compatible with a wide range of application programs and hardware devices, some older programs and devices may not be usable. Check the Microsoft Web site at [www.microsoft.com](http://www.microsoft.com) for application programs and hardware devices known to be compatible. When buying new software and devices, look for those that are labeled as ready for Windows XP. If you encounter problems using an application program designed for an earlier Windows operating system, Windows XP provides a compatibility mode feature (see "[Program Compatibility Wizard](#)"). If you are unsuccessful at installing application programs or hardware devices designed to operate on earlier Windows operating systems, contact the manufacturer of the product for information or updates for Windows XP.

Windows XP also includes a new technology that addresses the problems sometimes encountered on previous operating systems with Windows application programs that, when installed, replace current versions of certain Windows files with older versions. This situation can cause problems with the newer application programs, which rely on the replaced files. To eliminate this problem and improve operating system stability, Windows XP manages multiple versions of files and invokes the correct version required by a program.



**NOTE:** If you experience problems with your operating system or other applications after performing an installation, you can use [System Restore](#) to return your computer to a previous stable condition.

## Program Compatibility Wizard

A program compatibility feature is provided in Windows XP that solves some issues that may be encountered when attempting to run older application programs. Using the Program Compatibility Wizard, you can configure a program to run in an environment closer to Windows 95, Windows 98/Me, Windows NT 4.0 with Service Pack 5, or Windows 2000.

To use the Program Compatibility Wizard:

1. Click the Start button, point to All Programs—> Accessories, and click Program Compatibility Wizard.
2. When the Program Compatibility Wizard appears, click Next>.
3. Select how you want to locate the program to run with compatibility settings: from a list, available on a CD, or manually located. Then click Next>.
4. Select the type of operating system for which the program was designed or on which it ran successfully, and then click Next>.
5. If necessary, as for some games, select display settings for the program.
6. Click Next>.
7. To test the compatibility settings for the program, click Next>.

After you have determined whether the program is running correctly, return to the Program Compatibility Wizard window.

8. Select Yes if the program ran correctly, No, try different compatibility settings, or No, I am

finished trying compatibility settings and click Next>.

9. Select either Yes to send information about the settings you used and whether they fixed the problem, or select No, and then click Next>.

10. Click Finish to close the wizard.

---

## System Restore

The System Restore feature of Windows XP provides the capability to restore the operating system, in the event of a problem, to a previous state without losing personal data files (such as Word documents, drawings, or e-mail).

System Restore actively monitors system file changes and some application file changes to record or store previous versions before the changes occurred. System Restore maintains a rolling record of restore points; to limit the amount of space used, older restore points are purged to make room for newer ones.

In the event of a serious operating system problem, System Restore can be used from Safe Mode or Normal Mode to go back to a previous system state, restoring optimal system functionality.



**NOTE:** System Restore does not revert user data or document files, so restoring does not cause loss of work, mail, or browsing history and favorites.



**NOTE:** Dell recommends that you make regular backups of your data files. System Restore does not monitor changes to or recover your data files. In the event the original data on the hard-disk drive is accidentally erased or overwritten or becomes inaccessible because of a hard-drive malfunction, backup files are required to recover lost or damaged data.

## Using System Restore

System Restore monitors a core set of system and application program files, recording and sometimes copying states of these files before changes are made. System Restore automatically creates restore points; no user intervention is required. In addition, you can create restore points manually, if desired.

Restore points are created to allow you to choose previous system states. Each restore point gathers the necessary information needed to restore to a precisely chosen system state. There are three types of restore points:

- System (automatically created) restore points (scheduled by your computer)
- Installation (event-triggered) restore points (when a program is installed)
- Manual restore points (created by you as needed)

### Scheduled Automatic Restore Points

By default, System Restore creates a restore point every day that the computer is running. If your computer is off for more than a day, a new restore point is created the next time you turn the computer on.

## Event-Triggered Restore Points

Event-triggered restore points are created before key changes are made to the system. System Restore automatically creates a restore point before the following events:

- *Application installations* — System Restore creates a restore point before you install an application program designed for Windows XP. You may wish to create a manual restore point before attempting to install an older program.
- *AutoUpdate installation* — When you choose to install the update, System Restore creates a restore point before the actual installation of the update begins.
- *Restore operation* — The restore operation itself also creates a restore point for undo purposes.
- *Microsoft Backup Utility recovery* — Before Microsoft Backup Utility (only available in Windows XP Professional) performs a backup recovery, System Restore creates a restore point.
- *Unsigned driver installation* — The INF installer of Windows detects unsigned device-driver installations. Drivers that are signed (electronically certified by the device manufacturer) do not generate a restore point.

## Manual Restore Points

If you are logged on to the computer as computer administrator or as a user with administrator rights, you may create and name an on-demand restore point. (For information on types of user accounts, see "[How to Add Users](#).") This is useful to create a checkpoint to return to before making a particularly risky change, before leaving a shared system to other users, or at a particular state you believe is optimal.

To create a restore point, perform the following steps:

1. Click the Start button, point to All Programs—> Accessories—> System Tools, and then click System Restore.
2. Select Create a restore point and click Next>.
3. Type a description of the restore point and click Create.

The date and time are automatically added to the description of the new restore point.

## Restore Process

As the computer is used over time, restore points are collected in the archive without any management or intervention. If you encounter operating system problems, you can use the System Restore feature to select any of the restore points presented through the System Restore Wizard.

If problems occur after installing a device driver, you should first attempt to use [Driver Rollback](#). If that is unsuccessful, then use System Restore.

To return your computer to a previous, stable condition, perform the following steps:

1. Click the Start button, point to All Programs—> Accessories—> System Tools, and then click System Restore.
2. Select Restore my computer to an earlier time and click Next>.

The Select a Restore Point screen appears. The calendar on the left indicates in bold the dates on which restore points were created.

3. Click a date, click a restore point for that date, and click Next>.
4. Click Next> to confirm the restore point selection and complete the restore process.

After System Restore finishes collecting data, the computer automatically restarts and the Restoration Complete screen appears.

5. Click OK.

If you are not satisfied with the results of the restoration, you can repeat the preceding steps, using a different restore point, or you can undo the restoration.

To undo a restoration, perform the following steps:

1. Click the Start button, point to All Programs—> Accessories—> System Tools, and then click System Restore.
2. Select Undo my last restoration and click Next>.
3. Click Next> to confirm the restoration undo.

After System Restore finishes collecting data, the computer automatically restarts and the Undo Complete screen appears.

4. Click OK.

## Driver Rollback

Windows XP device Driver Rollback can replace a device driver with the previously installed version. When you install a new device driver that causes system instability, use Driver Rollback to reinstall the previous drivers. In the event that Driver Rollback cannot reinstall your previous driver, you can use System Restore to return your operating system to its state before the new device driver installation.

To use Driver Rollback, perform the following steps:

1. Click the Start button, and then right-click My Computer.
2. Click Properties.

3. Click the Hardware tab, and then click Device Manager.
  4. In the Device Manager window, right-click the device for which the new driver was installed, and then click Properties.
  5. Click the Drivers tab, and then click Roll Back Driver.
- 

## User Accounts and Fast User Switching



**NOTE:** Fast User Switching is the default user screen for both Home and Professional editions, but is disabled in Windows XP Professional when the computer is a member of a computer domain.

Microsoft Windows XP includes a new feature that provides multiuser access to a single computer. Fast User Switching, which is available in both the Home and Professional editions, allows users to access the computer with their specific settings, including the desktop and various applications, without requiring the previous user to log off. New users log on and switch from the original user's session to their own. New users can run their desktop and applications without interfering with the original user. When the original user returns, that user can switch back to the desktop and applications with the original settings. All of this is accomplished without the delay of each individual user logging off the computer.

During setup, the computer administrator creates all the accounts that will be used on the computer. (For information on types of accounts and adding new accounts, see "[How to Add Users](#).") When the computer starts, the main user screen appears with all of the user names. From this screen you select an account and log in to that session.

### How to Use Fast User Switching

To access Fast User Switching, perform the following steps:

1. Click the Start button and click Log Off.
2. When the Log Off Windows screen appears, click either Switch User or Log Off.

When you select Switch User, the main user screen appears. You can then select your account name and log in. Your personal desktop appears.

### What Happens When a Fast User Switch Occurs?

When a fast user switch occurs, the original user is not logged off the computer as previously happened on other Microsoft operating systems. On Windows XP, the user's logon remains active, but is replaced by the new user. Users can switch between login IDs as often as they want.

However, user applications active during a user switch remain active and running in the background while the new user is working; this can result in a slower computer until the process finishes. For example, if one user is downloading a large file from the Internet and another user logs on to the computer, the file download continues in the background until it is complete.

While most applications continue to run in the background during a fast user switch, multimedia applications

do not. Because multimedia applications use resources that cannot easily be shared between different users on a single computer, those applications terminate during the user switch, allowing the new user to take full advantage of the multimedia capabilities.

## Special Considerations With Fast User Switching

Considerations when using Fast User Switching include:

- Some older Windows games may not operate with a fast user switch.
- Multimedia games may shut down on a fast user switch.
- DVD software shuts down and requires a restart when the user comes back.
- Computers with low memory configurations can experience problems. The computer uses memory to keep the first user's programs running in the background while the second user is logged on. On computers with limited memory, this can cause the entire computer to run slowly. Fast User Switching is off by default on computers with less than 128 megabytes (MB) of random-access memory (RAM).

Fast User Switching is unavailable if the computer has Windows XP Professional installed and is a member of a computer domain.

## How to Turn Off Fast User Switching

You must have a computer administrator account on the computer to turn off Fast User Switching. (For information on types of accounts, see "[How to Add Users.](#)")

To disable Fast User Switching, perform the following steps:

1. Click the Start button, and click Control Panel.
2. In the Control Panel window, click User Accounts.
3. Under Pick a task, click Change the way users log on or off and do one of the following:
  - Select the Use Fast User Switching to log off check box to enable Fast User Switching.
  - Deselect the Use Fast User Switching to log off check box to disable Fast User Switching.
4. Click Apply Options.

## How to Add Users

Only a computer administrator or a user with administrator rights can create multiple user accounts. The individual who performs the initial operating system setup creates a computer administrator account and can add any number of users during the initial setup. All user accounts created during setup have administrator rights.

After initial operating system setup, the computer administrator or a user with administrator rights can create additional user accounts.



NOTE: Different account options are available when a Windows XP Professional computer is connected to a domain.

To add users, perform the following steps:

1. Click the Start button, and click Control Panel.
2. In the Control Panel window, click User Accounts.
3. In the User Accounts window under Pick a Task, click Create a new account.
4. In the box under Name the new account, type the name of the new user. Click Next>.
5. Under Pick an account type, click the bullet next to the type of account you are going to create — Computer administrator or Limited.
  - Computer administrators can change all computer settings.
  - Limited account users can change only a few settings such as their own passwords.
6. Click Create Account.

After the accounts are created, each shows up on the main user screen.

---

## Home and Small Office Networking

The Network Setup Wizard includes a checklist and steps to guide you through the process of sharing resources, such as files, printers, or an Internet connection, between computers in a home or small office. In Windows XP, Microsoft has improved the online documentation and usability of operating-system tools for setting up a home or small office network. New features in the operating system include support for the Point-to-Point Protocol over Ethernet (PPPoE) and a built-in firewall.

### Network Setup Wizard

The Home Network Wizard first appeared in Windows Me. To make setting up a home or small office network easier, Microsoft developed an enhanced Network Setup Wizard for Windows XP. This version provides more complete online documentation and support for setting up a home or small office network. The new wizard automatically enables the personal firewall discussed later in this section (see "[Internet Connection Firewall](#)").

To use the wizard, perform the following steps:

1. Click the Start button, point to All Programs—> Accessories—> Communications, and click Network Setup Wizard.
2. When the Network Setup Wizard appears, click Next>.

3. Click checklist for creating a network.

The checklist leads you through the steps necessary to set up a home or small office network and provides extensive references for each step. When you have completed the necessary connections and preparations, return to the Network Setup Wizard.

4. Select the Internet connection method and click Next>.
5. Select the desired Internet connection if required, and click Next>.
6. Type a description of the computer and a computer name, and then click Next>.
7. Review the network settings and click Next> to finish the setup.
8. When the setup process is complete, click Finish to close the wizard.

---

## Internet Connection Firewall

Today's always-on cable modem and DSL Internet access connections offer unprecedented bandwidth to the home, but also leave the connected computer or home network vulnerable to hacker attacks. The nature of these attacks varies, but the goal is to gain access to individual computers attached to the Internet. With this access, a hacker can browse the hard-disk drive and add or delete files, discover passwords and credit card numbers, and set the system up to launch attacks on other systems or websites. As a result, firewall protection from these attacks is increasingly required on computers. Recognizing this need, Microsoft provides an integrated firewall in Windows XP to provide immediate protection from outside access attempts. When enabled, the Internet Connection Firewall provides basic protection suitable for most home and small office users. The Internet Connection Firewall is disabled when the computer is connected to a domain.



**NOTE:** Enabling the Internet Connection Firewall does not reduce the need for virus-checking software.

The firewall is automatically enabled when you run the Network Setup Wizard. When the firewall is enabled for a network connection, its icon appears with a red background in the Network Connections portion of the Control Panel. The Internet Connection Firewall can be applied to each Internet connection on the computer. The firewall also provides basic logging capabilities. Not all events that appear in the log are hacker attacks. Many different types of harmless events can appear in the log, such as routine checks by an Internet Service Provider to verify the presence of your computer (pings).

The firewall is configured using the Properties dialog box associated with each Internet connection in the Control Panel. The firewall can be enabled or disabled. Additional configuration options are available for more advanced users. These advanced options include the ability to open or close specific Transmission Control Protocol (TCP) or User Datagram Protocol (UDP) ports or to enable port redirection. Port redirection allows access requests to a specific port on the firewall (such as port 80, the Web server port) to be automatically redirected to another computer on the local network. This capability allows a Web server on a home network to be protected by an edge firewall.

---



[Back to Contents Page](#)

# Using Intel® SpeedStep™ to Set Performance Levels: Dell™ Latitude™ C600/C500 User's Guide

 [Using Intel SpeedStep](#)

 [Using the Adjust Properties Option](#)

 [Setting the Advanced Options](#)

---

## Using Intel SpeedStep

 *NOTES: Intel SpeedStep technology is only available for C600 computers.*

The Intel SpeedStep technology allows you to set the performance level of the microprocessor whether the computer is running on battery or AC power. You can only use the Intel SpeedStep technology applet when the Microsoft® Windows® 98, or Windows 2000 operating system is running. You can verify or change the processor's performance mode when running in MS-DOS® mode by entering the [system setup program](#). The first page lists the processor speed ranges.

To access the Intel SpeedStep properties window, perform the following steps:

1. Right-click the flag icon in the system tray on the Windows taskbar to access performance level options. The following three options appear:
  - Maximum Performance option — switches your computer to the highest possible performance level even if the computer is running on battery
  - Battery Optimized Performance option — lets your computer run on performance level optimized for battery power even if the computer is connected to an electrical outlet
  - Adjust Properties — lets you change more performance options
2. To change the performance level, click the desired option.

To access the Intel SpeedStep options when the flag icon is not visible on the taskbar and if your computer is running under ACPI, perform the following steps:

1. Click the Start button and point to settings.
  2. Click Control Panel.
  3. Click Power Management.
  4. Select the Intel SpeedStep tab and select the options desired.
  5. After you make any changes, click OK to accept the settings and close the Intel SpeedStep window.
-

## Using the Adjust Properties Option

1. To access the Intel SpeedStep option window, either right-click the flag icon and click the Adjust Properties option or double-click the flag icon.

The Intel SpeedStep technology options window opens.

2. You can adjust the following performance options:
    - Automatically change performance when the power source changes (the default) — changes the performance level of your computer automatically when it is running on battery or connected to an electrical outlet.
    - Ask me before automatically changing performance — when selected, the computer prompts you for confirmation before the computer changes performance level.
    - Running on batteries and Plugged in pull-down menus — change performance level options.
  3. Click Apply to accept the settings.
  4. Click OK to close the Intel SpeedStep technology options window.
- 

## Setting the Advanced Options

The Advanced options lets you disable various options. To set Advanced options, perform the following steps:

1. Click the flag icon in the Windows system tray on the taskbar.
2. Click the Adjust Properties option.

The Intel SpeedStep window opens.

3. Click the Advanced button.

The Advanced window opens.

4. Click any of the following options:
  - Disable Intel SpeedStep technology control  
If you disable Intel SpeedStep through the Advanced options, you can only change processor speed through the [system setup program](#).
  - Remove flag icon.
  - Disable audio notification when performance changes.
5. Click Apply to accept the settings.
6. Click OK to close the Intel SpeedStep technology window.

---

[Back to Contents Page](#)

# Passwords and Security: Dell™ Latitude™ C600/C500 User's Guide

 [About Passwords](#)

 [Using a Hard-Disk Drive Password](#)

 [Using a Primary Password](#)

 [Assigning an Asset Tag](#)

 [Using an Administrator Password](#)

 [Using the Security Cable Slot](#)

---

## About Passwords

A primary password prevents unauthorized access to the computer at start-up. An administrator password can be used in place of the primary password. A hard-disk drive password helps prevent the unauthorized access of data on the hard-disk drive, even when the device is placed into another computer.



*NOTES: All three passwords are disabled when you receive your computer. You need to assign those passwords if you require password security for your computer. Some companies may assign any or all of these passwords before distributing the computer.*

NOTICE: The password features provide a high level of security for the data in your computer or hard-disk drive. However, they are not foolproof. If your data requires more security, you should obtain and use additional forms of protection, such as data encryption programs or PC Cards with encryption features.

If you forget any of your passwords, [call Dell](#). For your protection, Dell's technical support staff will ask you for proof of your identity to make sure that an unauthorized person is not trying to use the computer.

---

## Using a Primary Password

The primary password allows you to protect the computer from unauthorized access.

After assigning a primary password, you must enter it each time you turn on your computer. The following message appears each time you turn on the computer:

Please type in the primary or administrator password and press <Enter>.

To continue, type your password and press <Enter>.



*NOTE: If no password is entered within 2 minutes, the computer returns to its previous state.*

If you have assigned an administrator password, you can use it instead of the primary password. The computer does not specifically prompt you for the administrator password.

NOTICE: If you disable the administrator password, the primary password is also disabled.

---

## Using an Administrator Password

The administrator password is designed to give system administrators or service technicians in large companies access to computers for repair or reconfiguration. The administrators or technicians can assign identical administrator passwords to groups of computers as they are unpacked and configured, leaving the primary password free to be assigned by the user.

When you set an administrator password, the Configure Setup option becomes available in the [system setup program](#). The Configure Setup option allows you to restrict access to the system setup program in the same way a system password restricts access to the system.

The administrator password can be used in place of the primary password. Whenever you are prompted to enter the primary password, you can enter the administrator password instead.



*NOTE: The administrator password provides access to the system, but it does not provide access to the hard-disk drive when it is protected by a password.*

If you forget the primary password and do not have an administrator password assigned, or if you have both a primary and an administrator password assigned but forget them both, [call Dell](#).

NOTICE: If you disable the administrator password, the primary password is also disabled.

---

## Using a Hard-Disk Drive Password

The hard-disk drive password helps protect the data on your hard-disk drive from unauthorized access. You can also assign a password for the modular hard-disk drive (if one is being used) that can be the same as or different from the password for the primary hard-disk drive.



*NOTE: Only hard-disk drives purchased from Dell for use with the Latitude C-Family portable computers support the hard-disk drive password option.*

After assigning a hard-disk drive password, you must enter it each time you turn on the computer and each time you resume normal operation from suspend mode or standby mode.

If the hard-disk drive password is enabled, the following message appears each time you turn on the computer:

Please type in the hard-disk drive password and press <Enter>.

To continue, enter the hard-disk drive password. Press <Esc> to return the computer to its previous state—suspend or standby mode.



*NOTE: If no password is entered within 2 minutes, the computer returns to its previous state.*

If you enter the wrong password, the following message appears:

```
Invalid password  
[Press Enter to retry]
```

If the correct password is not entered in three attempts, the computer tries to boot from another bootable device if the Boot First device option in the [system setup program](#) is set to allow it. If the Boot First device option is not set to allow booting from another device, the computer returns to the state it was in when you turned it on—suspend or standby mode.



*NOTES: If the hard-disk drive password, the modular hard-disk drive password, and the primary password are the same, you are prompted only for the primary password. If the hard-disk drive password is different from the primary password, you are prompted for both. Two different passwords provide greater security.*

*The administrator password provides access to the system, but it does not provide access to the hard-disk drive when it is protected by a password.*

---

## Assigning an Asset Tag

The Asset Tag utility allows you to enter an asset tag number that you or your company assigns to the computer. The default system setup screens do not show the asset tag number unless you enter one by using this utility.

You can also use the Asset Tag utility to enter an owner tag that appears in the system log-on screen and with the primary password prompt.

### Viewing Existing Asset Tag and Service Numbers

To view existing asset tag and service tag numbers, perform the following steps:

1. Boot the computer from a bootable diskette or CD-ROM.
2. Type `cd c:\Dell\Util` and press <Enter>.
3. Type `asset` and press <Enter>.

### Assigning an Asset Tag Number

An asset tag number can have up to ten characters; any combination of characters excluding spaces is valid. To assign or change an asset tag number, perform the following steps:

1. Boot the computer from a bootable diskette or CD-ROM.
2. Type `cd c:\Dell\Util` and press <Enter>.
3. Type `asset` and a space followed by the new number, and press <Enter>.

For example, type the following command line and press <Enter>:

```
asset 1234$ABCD&
```

4. When the system prompts you to verify the asset tag number, type `y` and press <Enter>.

The system displays the new or modified asset tag number and the service tag number.

## Deleting an Asset Tag Number

To delete the asset tag number without assigning a new one, perform the following steps:

1. Boot the computer from a bootable diskette or CD-ROM.
2. Type `cd c:\Dell\Util` and press <Enter>.
3. Type `asset /d` and press <Enter>.

## Assigning an Owner Tag

An owner tag can have up to 48 characters; any combination of letters, numbers, and spaces is valid. To assign an owner tag, perform the following steps:

1. Boot the computer from a bootable diskette or CD-ROM.
2. Type `cd c:\Dell\Util` and press <Enter>.
3. Type `asset /o` and a space followed by the new owner tag, and press <Enter>.

For example, type the following command line and press <Enter>:

```
asset /o ABC Company
```

4. When the system prompts you to verify the owner tag, type `y` and press <Enter>.

The system displays the new owner tag.

## Deleting an Owner Tag

To delete the owner tag without assigning a new one, perform the following steps:

1. Boot the computer from a bootable diskette or CD-ROM.
2. Type `cd c:\Dell\Util` and press <Enter>.
3. Type `asset /o /d` and press <Enter>.



*NOTE: For security, you cannot set, change, or delete the owner tag if the primary or administrator passwords are set.*

[Table 1](#) lists the command-line options you can use with the Asset Tag utility. To use one of these options, open an MS-DOS® prompt, type `asset` and a space followed by the option, and then press <Enter>.

Table 1. Asset Tag Utility Command-Line Options

Asset Tag Option	Description
/d	Deletes the asset tag number



/o tag	Specifies a new owner tag
/o /d	Deletes the owner tag
/?	Displays the Asset Tag utility help screen

## Using the Security Cable Slot

To prevent unauthorized removal of the computer, you can use a security cable to attach the computer to an immovable object. Your computer has one security cable slot, located on the left side of the computer—between the speaker and the hard-disk drive (see [Figure 1](#)).

The security cable slot allows you to attach a commercially available antitheft device to the computer. Antitheft devices for portable computers usually include a segment of metal-stranded cable with an attached locking device and associated key.

### Basic Instructions for Using the Security Cable Slot

To prevent unauthorized removal of your computer, loop the cable around an immovable object, insert the locking device into the security cable slots, and lock the device. See Figure 1 for an example of how to secure your computer. Complete instructions for installing this kind of antitheft device are usually included with the device.

Figure 1. Securing the Computer



 **NOTE:** Antitheft devices are of differing designs. Before purchasing such a device, make sure that it will work with the security cable slot in your computer.

### Security and Docking Device

If your computer is installed in a Dell Latitude docking device, use the security cable slot on the docking device to secure the computer. See your docking device *User's Guide* for the location of the security slot.

You can use the security cable slot to secure your computer when it is not docked to a Dell Latitude docking device. However, to lock your computer and prevent unauthorized removal of the hard-disk drive, insert the

locking device into the security cable slot located between the hard-disk drive and the speaker, and lock the device with its associated key.

---

[Back to Contents Page](#)

# Traveling With Your Computer: Dell™ Latitude™ C600/C500 User's Guide

[Identifying Your Computer](#)

[Preparing Your Computer for Travel](#)

[Travel Tips](#)

---

## Identifying Your Computer

As an antitheft measure, assign a primary password and a hard-disk drive password to prohibit unauthorized access to the computer.

Dell recommends that you follow these precautions before you travel with your computer:

- Write down your service tag number, and put it in a safe place separate from the computer or carrying case. If the computer is lost or stolen, use the service tag number when reporting to law enforcement officials and to Dell.
- Use a text editor (such as Microsoft® Windows® Notepad) to create a file called if\_found in your root directory. Place information such as your name, address, and telephone number in this file. (For instructions on using the appropriate text editor, see the documentation that came with your operating system.)
- Attach your business card or other name tag to the computer.
- Contact your credit-card company and ask if it offers coded identification tags that allow your property to be returned to you without the risk of revealing your name, address, or telephone number.
- Use a permanent marking or stenciling device to write your driver's license number or some other unique identifying mark on the computer. If a lost or stolen computer is recovered, such marking identifies the computer as your property.

## Service Tag Number

The service tag number is an alphanumeric code on a bar code label located on the bottom of the computer. The number is unique to your computer and allows Dell technical assistance personnel to identify the computer and its configuration quickly if you call for assistance.

## If Your Computer Is Lost or Stolen

If your computer is lost or stolen, Dell suggests that you perform the following steps:

1. Call a law enforcement agency to report the lost or stolen computer.

Include the service tag number in your description of the computer. Ask that a case number be

assigned, and write it down. Also write down the name, address, and telephone number of the law enforcement agency. If possible, obtain the name of the investigating officer.

If you know where the computer was lost or stolen, call a law enforcement agency in that area. If you do not know, call a law enforcement agency where you live.

2. If the computer belongs to a company, notify the security office of the firm.
3. Call Dell technical assistance to report the missing computer.

Provide the computer's service tag number, the case number, and the name, address, and telephone number of the law enforcement agency to which you reported the missing computer. If possible, give the name of the investigating officer.

The Dell support technician will log your report under the computer's service tag number and flag the computer as missing or stolen. If someone calls Dell for technical assistance and gives your service tag number, the computer is identified automatically as missing or stolen. The technician will attempt to get the phone number and address of the caller. Dell will then contact the law enforcement agency to which you made the report of the missing or stolen computer.

---

## Preparing Your Computer for Travel

To prepare your computer for travel, perform the following steps:

1. Remove any external devices attached to the computer, and store them in a safe place. If a diskette is in the diskette drive, remove it. Remove any cables attached to installed PC Cards (you do not have to remove the PC Cards themselves).
2. To make the computer as light as possible, remove the storage device (if installed) from the modular bay and install the travel module.
3. To maximize battery life, check the charge on your battery. Then fully charge the battery and any spares you plan to carry with you.
4. Turn off the computer.

**NOTICE:** When you disconnect the AC adapter from the computer, grasp the adapter cable's connector, not the cable itself, and pull gently but firmly to avoid damaging the cable.

- Disconnect the AC adapter.

**NOTICE:** When the display is closed, items left on the keyboard could damage the display.

6. Make sure that there is nothing on the keyboard and palmrest that can damage the display when you close it. Then close the display.
7. Pack all your computing accessories.

With the optional Dell carrying case, you can pack the computer and its accessories together.



*NOTE: Follow the travel tips and take special precautions if you are planning to travel by air.*

## Traveling by Air

You may want to take the following precautions when you are traveling by air with your computer:

- Notify airport security in advance that you are bringing a portable computer.
- Be sure to have a charged battery or the AC adapter and power cable available in case you are asked to turn on the computer.
- Do not check the computer as baggage.

NOTICE: Have airport security personnel check the computer by hand. If the computer passes through a metal detector, data loss may occur. If you must pass the computer through a metal detector, first remove the hard-disk drive.

- Do not put the computer through a metal detector.
- The computer can go through an airport X-ray security machine.
- Before you use the computer on an airplane, check the in-flight magazine or ask the flight crew to verify that such use is permitted. Some airlines forbid the use of electronic devices during the flight. All airlines forbid the use of electronic devices during takeoff and landing.
- Dell has several carrying cases that protect the computer and accessories during travel.
- If you pack the computer in a suitcase, do not pack so tightly that the computer display breaks or so loosely that the computer slides around.
- Avoid packing the computer with items such as shaving cream, colognes, perfumes, or food.
- Protect the computer, the battery, and the hard-disk drive from hazards such as extreme temperatures; overexposure to sunlight; and exposure to dirt, dust, or liquids.
- Pack the computer so that it does not slide around in the trunk of your car or in an overhead storage compartment.
- If you are carrying a second hard-disk drive separately, protect the drive from exposure to static electricity by placing the drive in an antistatic bag or wrapping it in a nonconductive fabric.

---

## Travel Tips

- Consider changing the settings of your power management options to maximize battery life if you will be using battery power for extended periods.
- If you are traveling internationally, carry proof of ownership to speed your passage through customs. If the computer is provided by your employer, carry documentation of your right to use the computer. Investigate the customs regulations of the countries you plan to visit, and consider acquiring an

international [carnet](#) from your government if you travel through many different countries.

- Power interruptions can occur frequently in some countries. Always have a charged battery available if traveling abroad.
- Credit card holders should check with their credit card companies for information about the kinds of emergency travel assistance they offer to users of portable computers. Many companies provide services that help you solve problems, such as quickly locating 3.5-inch diskettes or providing a direct-dial telephone line for your modem connection.

NOTICE: Do not use removable media devices while the computer is in motion. Vibrations could interrupt the flow of data to and from the device and the hard-disk drive.

Carnet

A carnet is an international customs document (also known as a *merchandise passport*) that facilitates temporary imports into foreign countries and is valid for up to 1 year.

---

[Back to Contents Page](#)

# Removing and Replacing Parts: Dell™ Latitude™ C600/C500 User's Guide

 [Preparing to Work Inside the Computer](#)

 [Replacing a Primary Hard-Disk Drive](#)

 [Removing or Installing Memory Modules](#)

---

## Preparing to Work Inside the Computer

 *NOTES: If necessary, print these instructions for reference before proceeding.*

Before you start to work on the computer, perform the following steps.

NOTICE: Failure to perform the following steps could result in damage to the computer.

1. Save any work in progress and close all open application programs.
2. Turn off the computer and any attached devices.

 *NOTE: Make sure that the computer is turned off and not in save-to-disk suspend (S2D) mode. If you cannot shut down the computer using the computer's operating system, press the power button for 4 seconds.*

3. If the computer is docked, undock the computer.
4. Disconnect the computer and any attached devices from their electrical outlets to reduce the potential for personal injury or shock. Also disconnect any telephone or telecommunications lines from the computer.
5. Remove the power cable.
6. Disconnect all other external cables from the computer.
7. Remove any installed [PC Cards](#).

NOTICE: Make sure that the work surface is clean to prevent scratching the computer cover.

NOTICE: To avoid damaging the system board, remove the power cable, the battery, and the second battery (if installed) before you service the computer.

8. [Remove the main battery](#) from the battery bay.
9. Ground yourself by touching the unpainted metal surface of the input/output (I/O) panel on the back of

the computer.

While you work, periodically touch the I/O panel to dissipate any static electricity that might harm components.

---

## Replacing a Primary Hard-Disk Drive

**NOTICE:** To prevent data loss, turn off your computer before you remove the hard-disk drive. Do not remove the hard-disk drive if the computer is in suspend mode or if the drive access light is on. Removing the drive under these conditions will lead to loss of data.

To replace a primary hard-disk drive, perform the following steps:

1. Complete the tasks as described in "[Preparing to Work Inside the Computer.](#)"
2. Remove the hard-disk drive from the drive bay.

Close the display and turn the computer over. Using a small Phillips-head screwdriver, remove the screw (see Figure 1) that holds the drive carrier in the drive bay. Save the screw for use later in this procedure.

Figure 1. Removing a Hard-Disk Drive

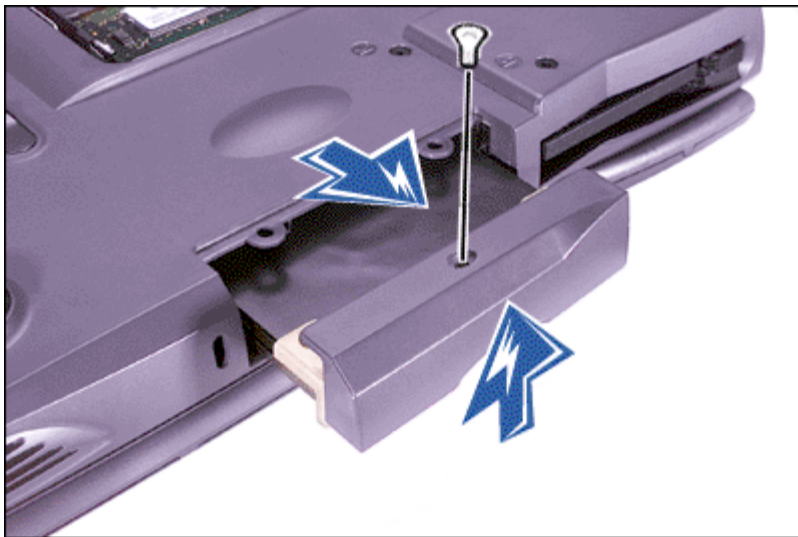

3. As shown in Figure 1, push up and pull out the drive carrier out of the drive bay.

When the hard-disk drive is not in the computer, protect the drive from exposure to static electricity. See "[Protecting Against Electrostatic Discharge](#)" for more information.

4. Remove the new hard-disk drive from its packaging.

Save the original packaging to use when you store or ship the hard-disk drive.

5. Install the new hard-disk drive into the computer (it comes in a drive carrier).

**NOTICE:** If the drive carrier does not slide in easily, pull it out and try again. To avoid damage, do not force the drive carrier into the bay.



6. Gently push the drive carrier into the drive bay until the carrier door is flush with the computer case.
7. Push down on the driver carrier until it snaps into place.
8. Replace the screw you removed in step 2. Be careful not to overtighten the screw.

If you have installed a new hard-disk drive, follow the directions that came with the drive to partition and logically format the drive and to create a suspend-to-disk (S2D) partition.

NOTICE: Hard-disk drives are extremely fragile and must be handled carefully to avoid damage. Follow these guidelines:

- The primary hard-disk drive is installed in a metal carrier to protect the drive and make installation easier. When you remove and install hard-disk drives, handle the drive carrier, not the drive itself.
- Never press down on the top of the drive.
- Do not drop the drive. Even a slight jar or bump can damage the drive heads and spinning plates, thus rendering the drive inoperable.

 CAUTION: The primary hard-disk drive may be hot to the touch under extreme environmental conditions. If the drive is hot, allow it to cool before you replace it.

## Preparing a New Primary Drive

Every primary hard-disk drive must be physically formatted, partitioned, and logically formatted before it can be used to store data. Every primary hard-disk drive from Dell is physically formatted before it is sent to you. Use the program(s) provided by your operating system to partition and logically format the hard-disk drive.

---

## Removing or Installing Memory Modules

NOTICE: Your computer only supports 100-megahertz (MHz) synchronous dynamic random-access memory (SDRAM) modules. It does not support extended-data out (EDO) memory modules.

NOTICE: Do not install memory modules while the computer is in suspend, standby, or suspend-to-disk mode.

NOTICE: Ground yourself by touching an unpainted metal surface of a connector on the back of the computer. While you work, periodically touch the connector to dissipate any static electricity that might harm internal components.

To remove or install memory modules, perform the following steps:

1. Complete the tasks as described in "[Preparing to Work Inside the Computer.](#)"
2. Close the display, and turn the computer upside down.
3. Remove the memory module cover:
  - a. Using a small Phillips-head screwdriver, remove the two screws located on the memory

module cover. The screws are part of the memory module cover and stay with the cover when you remove it.

- b. Locate the small semicircular indentation at one end of the memory module cover. Place your fingertip under the cover by the indentation and firmly lift the cover up.
  - c. When the cover pops up, lift it up to remove it and expose the memory modules underneath it.
4. If you are replacing a memory module, remove the old one.

Carefully spread apart the inner metal tabs of the memory module socket just far enough for the memory module to disengage from the socket (it should pop up slightly). Then lift the memory module away from the socket (see Figure 2).

Figure 2. Removing a Memory Module

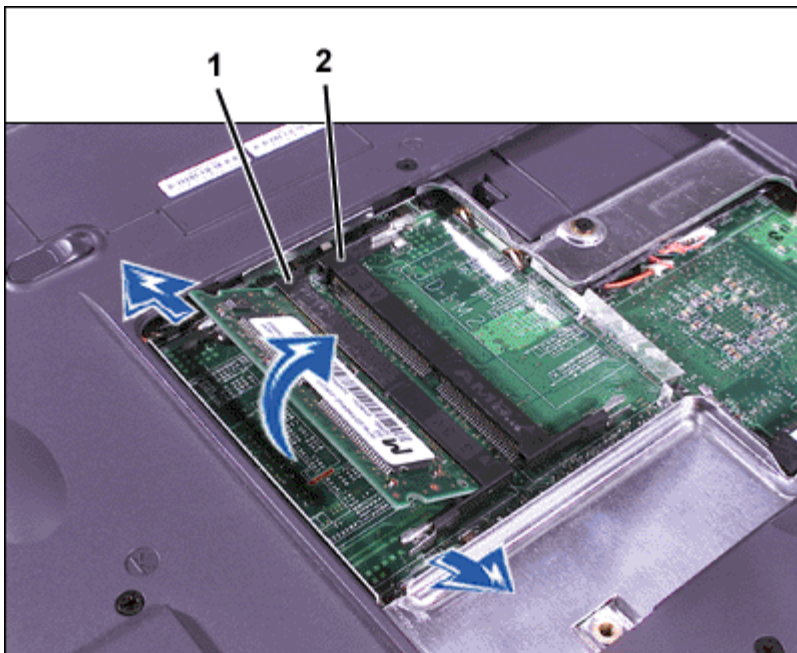

- 1 JDIM 1 socket
- 2 JDIM 2 socket

5. Ground yourself and unpack the new memory module from the upgrade kit.
6. If you need to install memory modules in two sockets, install a memory module in the socket labeled "JDIM 1" *before* you install a module in the socket labeled "JDIM 2." If you only have one memory module, install it in the "JDIM 1" socket. (See [Figure 2](#).)

Memory modules are *keyed*, or designed to fit into their sockets in only one direction. The slots on the system board are notched so that the memory module can be firmly seated only one way.

7. Align the memory module's edge connector with the slot in the center of the memory module socket.
8. With the module at a 45-degree angle, press the memory module's edge connector firmly into the memory module socket.
9. Pivot the memory module down until it clicks into place.

If you do not hear a click as each end of the memory module snaps into the metal tabs, remove the memory module and reinstall it.

NOTICE: After installation, if the memory module cover does not fit or is difficult to close, you may have installed the memory module improperly or into the wrong slots. Remove the memory modules and reinstall them. Do not force the memory module cover to close because you may damage your computer.

10. Replace the memory module cover as follows:

- a. Set the memory module cover loosely over the opening, aligning the three tabs on the memory module cover to the corresponding slots on the opening. These tabs are on the opposite side of the cover from the screw holes.
- b. Rotate the cover down and reinstall the screws.

11. Reconnect your computer and devices to their electrical outlets and turn them on.

As the computer boots, it detects the presence of additional memory and automatically updates the system configuration information. Verify that the correct memory total is displayed. If necessary, repeat steps 1 through 9 until the memory total is correct

---

[Back to Contents Page](#)

# AC Adapter and Battery: Dell™ Latitude™ C600/C500 User's Guide

- [About the AC Adapter](#)
  - [Connecting the AC Adapter](#)
  - [About the Batteries](#)
  - [Removing a Battery](#)
  - [Installing a Battery](#)
  - [Checking the Battery Charge](#)
  - [First Low-Battery Warning](#)
  - [Second Low-Battery Warning](#)
  - [Charging the Battery](#)
  - [Detecting Battery Problems](#)
  - [Battery Disposal](#)
- 

## About the AC Adapter

The AC adapter kit includes two cables: the AC adapter cable and an AC power cable.

You can connect the AC adapter with your computer either turned on or off.

The AC adapter works with electrical outlets worldwide. However, power connectors vary among countries. Before you use AC power in a foreign country, you may need to obtain a new power cable designed for use in that country.

If the computer is docked to a Dell C/Port Family Advanced Port Replicators (APR) or C/Dock Family Expansion Stations, you can run the computer on AC power by connecting the AC adapter to the C/Port APR or C/Dock Expansion Station.



*NOTE: If you are running your computer on AC power with a battery installed, the AC adapter charges the battery (if needed) and then maintains the battery's charge.*

**NOTICE:** To avoid overheating the AC adapter when powering the computer or charging the battery, use the AC adapter in a ventilated area, such as on a desktop or on the floor. Do not use the AC adapter in a poorly ventilated environment, such as inside a carrying case.

---

## Connecting the AC Adapter

- 1 AC adapter cable
- 2 AC adapter power cable
- 3 AC adapter

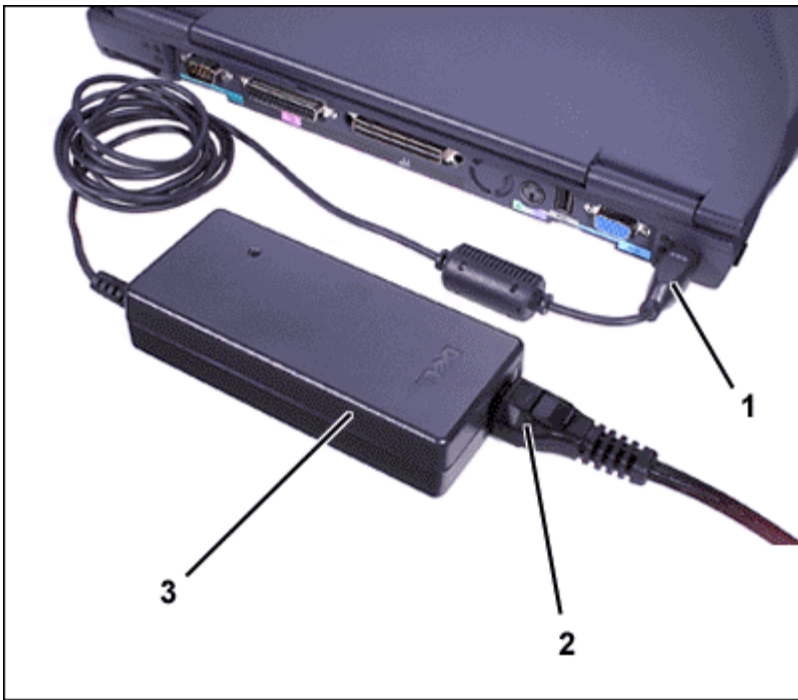

## About the Batteries

A lithium ion battery in the battery bay is standard with the computer, and provides power when an electrical outlet is not available. To double battery life, install a second battery in the modular bay.

**!** CAUTION: Do not puncture, disassemble, or incinerate the computer's battery. The battery may present a fire or chemical burn hazard if mistreated. Do not expose the battery to temperatures above 60° Celsius (C) (140° Fahrenheit [F]). Keep the battery away from children. Handle damaged or leaking batteries with extreme care. If the battery is damaged, electrolyte may leak from the cells and cause personal injury.

Lithium ion batteries are longer lived than conventional batteries and do not require replacement as often. There is no battery memory effect with a lithium ion battery—you can charge the battery whenever you like without fear of reducing its charge capacity, and you do not need to drain a lithium ion battery completely before recharging it.

Lithium ion batteries should not be disposed of with common household waste products. For [battery disposal](#) information, contact local authorities for the location of a chemical waste collection program nearest you.

Keep the following information in mind when you are running your computer from the battery:

- With a single fully charged, 8-cell lithium-ion battery, you can expect about 3 hours of battery life; with two fully charged lithium-ion batteries, 6 hours of battery life. Actual performance varies, depending on which power management features are enabled and which application programs are being used.
- When two batteries are installed, the computer draws power from the battery with the higher capacity until both batteries are at the same charge level. Then it draws power from both. The AC adapter first charges the battery in the battery bay.
- The [integrated charge gauge](#) lets you check a battery's charge before you insert it into the computer.

- The battery's self-test capability alerts you to battery conditions such as low charge.
- The battery has a life span of around 400 discharge/charge cycles, provided it is charged at normal room temperature.

## Battery Usage

The battery is partially charged when you receive it. Dell recommends that you charge your battery to full capacity before using it to power the computer. For information on conserving battery power, see "[Power Management Modes](#)."

When you activate suspend mode (known as [standby](#) in the Microsoft® Windows® 98 and Windows 2000 operating systems), the computer can run on a fully-charged battery for approximately one week.

If you are going to store the computer, disconnect all peripheral devices and turn off the computer. Remove the battery when you store your computer for an extended period of time. A battery will drain when not in use during prolonged storage. After a long storage period, recharge the battery fully before you attempt to run your computer from the battery.

---

## Removing a Battery

 **CAUTION:** Using the wrong battery type may present a risk of fire or explosion. Replace the battery only with the same or equivalent type purchased from Dell. You can use your computer's battery in any Latitude C-Family computer **except** for the Latitude CS or CSx computers. Do not attempt to use the battery in CS or CSx computers, and do not use a battery from those computers in your computer.

**NOTICE:** To avoid data loss, do not replace a battery while the computer is turned on unless the computer is connected to an electrical outlet or a second battery is installed.

**NOTICE:** Only use lithium ion batteries in your computer. The computer does not support nickel-metal hydride (NiMH) batteries. If you install a NiMH battery, the battery status lights blink alternately green and amber.

**NOTICE:** If you choose to replace the battery with the computer in standby mode, you have up to 4 minutes to complete the battery replacement. After 4 minutes, the computer shuts down and you will lose any unsaved data.

1. Ensure that the computer is turned off, suspended in a power management mode, or connected to an electrical outlet.
2. If the computer is docked, undock it.
3. Close the display and turn the computer over.
4. Slide and hold the battery bay (or module bay) latch release on the bottom of the computer, and then remove the battery from the bay.

Figure 1. Removing a Battery

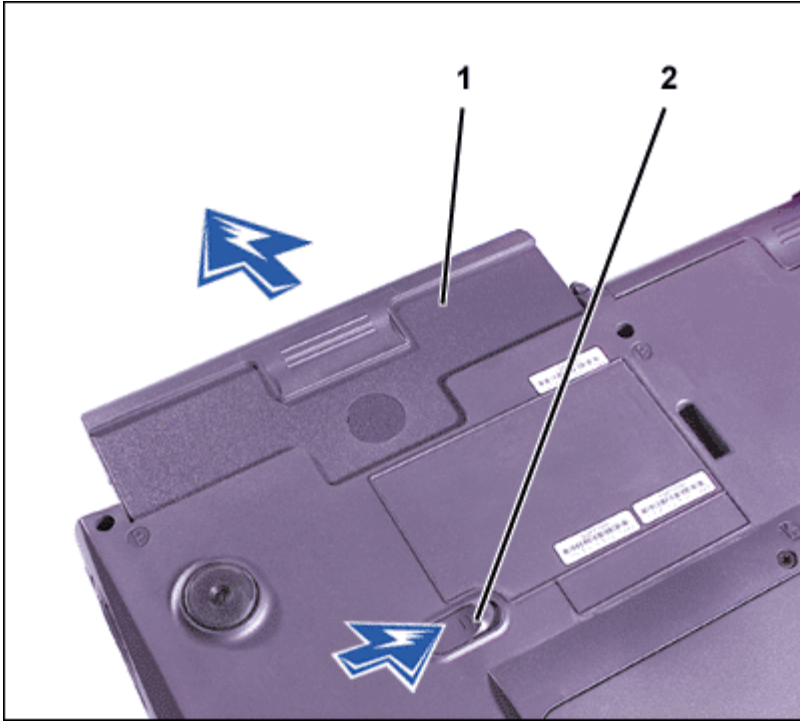

- 1 Battery
- 2 Battery bay latch

## Installing a Battery

Slide the battery into the bay until the latch release clicks.

## Checking the Battery Charge

To check the charge level, press the battery test button that is next to the lights (see [Figure 2](#)). The number of lights that appear shows an estimate of the remaining battery charge (see [Table 1](#)).

Figure 2. Battery Charge Gauge and Test Button



Table 1. Percentage of Charge

Percentage of Charge
----------------------

No. of Lights Lit	% Charge Remaining
5	81–100
4	61–80
3	41–60
2	21–40
1	1–20

The battery charge gauge consists of five lights. Each light represents 20 percent of full charge. If only one light appears, recharge the battery before using it.

 **NOTE:** If the battery has a 0 (zero) percent charge, you cannot use the battery test button to check the battery's capacity. The battery gauge indicator will not light if the battery is completely drained.

A light that blinks rapidly when you check the battery's charge level indicates a temporary failure or a potentially recoverable failure like overheating. Allow the battery to cool for several minutes before checking the charge level again.

If the battery is experiencing a permanent failure, the lights do not appear when you press the test button. If you install a failed battery into the computer, the amber battery light on the computer flashes rapidly (see [Figure 3](#)). To purchase a new battery, [call Dell](#) or access the Dell World Wide Web site at <http://www.dell.com>. Dispose of the old battery properly.

## First Low-Battery Warning

The first low-battery warning—a blinking amber battery light—occurs when you have about 15 minutes of battery life left under current conditions and the computer is not connected to an electrical outlet. Figure 3 shows the battery status light.

Figure 3. Status Lights

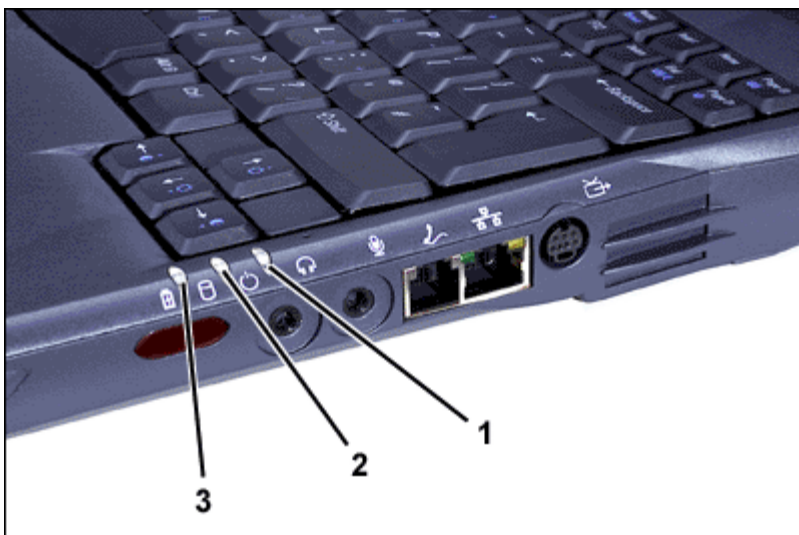

- 1 Power light
- 2 Drive access light
- 3 Battery light

**NOTICE:** When you see a low-battery warning, save your work immediately. Then



replace the battery or connect your computer to an electrical outlet.

After the first low-battery warning, if no input/output (I/O) activity occurs within 75 seconds, the computer activates suspend-to-disk mode. Once suspend-to-disk mode is activated, no further power is consumed. If the computer has no suspend-to-disk partition, the computer enters suspend mode. The computer can preserve data for several hours in suspend mode.

NOTICE: Never turn off the computer while the drive access light is on. Doing so could cause data loss. Instead, close all of your application programs before you turn off the computer.

---

## Second Low-Battery Warning

The second low-battery warning—a steady amber battery light—occurs when you have about 5 minutes of battery life left under current conditions and the computer is not connected to an electrical outlet.

After the second low-battery warning, if no further I/O activity occurs within 15 seconds, the computer activates suspend-to-disk mode. If there is no suspend-to-disk partition, the computer enters suspend mode. The computer can preserve data for several hours in suspend mode.

If the computer is already in suspend mode when a final low-battery warning occurs, the computer activates suspend-to-disk mode immediately. If suspend-to-disk mode has been disabled, the computer reenters suspend mode.

NOTICE: To avoid losing data (and possibly corrupting data areas on your hard-disk drive), save your work immediately after a second low-battery warning. Then connect your computer to an electrical outlet, or place the computer in suspend mode. If the battery runs completely out of power, the computer shuts off without properly closing any open files.

---

## Charging the Battery

Each time you connect the computer to an electrical outlet or install a battery in a computer that is connected to an electrical outlet, the computer checks the battery's charge. The AC adapter charges the battery (if needed) and then maintains the battery's charge.



**NOTE:** For maximum battery performance, charge the battery only at normal room temperature.

If two batteries are installed in the computer, the AC adapter first charges the battery in the battery bay, then the battery in the modular bay.

When installed in a computer connected to an electrical outlet, the battery immediately starts charging. The green power light remains steady while the AC adapter charges the battery. The power light starts blinking when the Dell ExpressCharge™ cycle is complete. While the power light is blinking, the AC adapter provides a trickle charge to bring the battery to full capacity. The power light continues to blink until you remove the battery or disconnect the computer from its electrical outlet.

NOTICE: If the battery is hot from being used in your computer or being in a hot environment, follow these precautions:

- A hot battery will not charge when you connect the AC adapter to the computer. This safety feature is important because charging a hot battery shortens the battery's life span and may damage the battery and the computer.
- The battery is too hot to start charging if the battery light flashes alternately green and amber. If this occurs while the computer is connected to an electrical outlet, disconnect the computer from the outlet and allow the computer and the battery to return to room temperature. Then reconnect the computer to its electrical outlet and continue charging the battery.
- If the computer is not allowed to return to room temperature, the battery stops charging before it reaches full capacity.

## Charge Times

For lithium ion batteries, if the computer is turned off and connected to an electrical outlet through the AC adapter, the computer uses ExpressCharge technology to charge the battery. ExpressCharge takes about an hour to completely charge a fully discharged battery. If the computer determines that the battery is near full capacity, the battery trickle charges instead of using ExpressCharge.

If the computer is on, it takes about the same time to charge, depending on which devices you are using and which programs you are running.



*NOTE: You can leave the battery in the computer as long as you like. The battery's integrated circuitry prevents the battery from overcharging.*

---

## Detecting Battery Problems

A battery problem may prevent the battery from being charged to its full potential and can lead to unpredictable operation. To obtain a new battery, [call Dell](http://www.dell.com) or access the Dell World Wide Web site at <http://www.dell.com>.

Dell suggests you follow these precautions when using the battery:

- To avoid installing a defective battery in your computer, check the battery's charge by pressing the battery test button ([see Figure 2](#)). The battery gauge light will not light if the battery is completely drained.
  - If, after you insert the battery in the computer, the computer's battery status light ([see Figure 3](#)) flashes alternately green and amber, the battery is too hot to charge. Turn off the computer, and let the battery and computer cool to room temperature.
  - If, after you insert the battery in the computer, the computer's battery status light ([see Figure 3](#)) flashes amber for 4 seconds when you connect or disconnect the AC adapter or when you press the power button, you need to replace the battery.
  - If, after you insert the battery in the computer, the computer's battery status light ([see Figure 3](#)) flashes rapidly amber, the battery is defective and needs to be replaced.
- 

## Battery Disposal

When your battery no longer holds a charge, call your local waste disposal agency or environmental agency for advice on disposing of it. To purchase a new battery, [call Dell](#) or access the Dell World Wide Web site at <http://www.dell.com>.

 CAUTION: If your battery is damaged, or if it no longer holds a charge, dispose of it promptly and properly. Do not dispose of it along with household waste. Call your local waste disposal agency or environmental agency for advice on disposing of the battery.

---

[Back to Contents Page](#)

# Power Management and Conservation: Dell™ Latitude™ C600/C500 User's Guide

- [Management Tips](#)
- [Power Management Modes](#)

- [Power Options Properties](#)
- [ENERGY STAR® Emblem](#)

---

## Management Tips

 **NOTE:** See "[About the Batteries](#)" for more information on conserving battery power.

- Connect the computer to an electrical outlet when possible, because the battery life expectancy is largely determined by the number of times it is charged.
- Place the computer in [standby mode](#) or [hibernate mode](#) when you leave the computer unattended for long periods of time.
- If you are going to connect your computer to a port replicator or a docking station, click None (or Do nothing) when you program the display-close option in the [Advanced](#) tab in the Microsoft® Windows® Power Options Properties window.
- To exit a power management mode, press the power button.

---

## Power Management Modes

### Standby Mode (Suspend Mode)

Standby mode (also called suspend mode) conserves power by turning off the display and the hard-disk drive after a predetermined period of inactivity (a time-out). When you exit standby mode, the computer returns to the same state it was in before entering standby mode.



**NOTICE:** If your computer loses AC and battery power while in standby mode, you may lose data.

To enter standby mode in Windows XP, Windows 2000, or Windows 98:

- *If you are using Windows XP*, click the Start button, click Turn Off Computer, and then click Stand By.

*If you are using Windows 2000 or Windows 98*, click the Start button, click Shutdown, click Standby, and then click OK.

or

- Depending on how you set the power management options in the [Advanced](#) tab, use one of the following methods:
  - Press the power button.
  - Close the display.
  - Press the power management keyboard shortcut (sometimes referred to as the "sleep button"),  .

If an external monitor is connected to the computer when you close the display, the computer does not enter standby mode. You can still use the external monitor.

To exit standby mode, press the power button or open the display depending on how you set the options in the

[Advanced](#) tab.

To enter standby mode in Windows NT:

To enter standby mode, press <FN><Esc>. For power management information, see [Power Options Properties](#).



Hibernate Mode (Suspend-to-Disk Mode)

Hibernate mode (also called suspend-to-disk or S2D mode) conserves power by copying system data to a reserved area on the hard-disk drive and then completely turning off the computer. When you exit hibernate mode, the computer returns to the same state it was in before entering hibernate mode.

NOTICE: You cannot remove devices or undock your computer while in hibernate mode.

Your computer enters hibernate mode if the battery charge level becomes critically low.

Depending on how you set the power management options in the Advanced tab, use one of the following methods to enter hibernate mode:

- Press the power button.
- Close the display.
- Press the power management keyboard shortcut (sometimes referred to as the "sleep button"),  .

If an external monitor is connected to the computer when you close the display, the computer does not enter hibernate mode. You can still use the external monitor.

 *NOTE: You cannot exit standby mode or hibernate mode by pressing a key or touching the touch pad.*

 *NOTE: Some PC Cards may not operate correctly after the computer exits hibernate mode. Remove and reinsert the card, or simply restart (reboot) your computer.*

To exit hibernate mode, press the power button. The computer may take a short time to exit hibernate mode.

For more information on hibernate mode, see the documentation that came with your operating system.

---

## Power Options Properties (Power Management Properties)

For Microsoft Windows XP

1. Click the Start button, and then click Control Panel.
2. Under Pick a category, click Performance and Management.
3. Under or pick a Control Panel icon, click Power Options.

For Microsoft Windows 2000 or Windows 98

To access the Windows Power Options Properties (or Power Management Properties) window:

1. Click the Start button, point to Settings, and then click Control Panel.
2. Double-click the Power Options Properties (or Power Management Properties) icon.

For Microsoft Windows NT

Dell provides Softex software compatible with the Power Management Controller, which allows you to suspend and resume your computer without affecting your ability to use the docking station or its media bay.

For information on using any Softex application program, see the online Help:

1. Double-click the Softex program's icon in the system tray of the Windows taskbar (normally on the bottom-right side of the screen).
2. Click Help.

## Power Schemes Tab

The Power schemes pull-down menu displays the selected preset power scheme. Depending on your operating system, typical power schemes are:

 **NOTE:** Dell recommends that you use the **Portable/Laptop** power scheme to maximize battery power.

- Portable/Laptop
- Home/Office
- Always On
- Presentation
- Minimal Power Management
- Max Battery

Each preset power scheme has different time-out settings for putting the computer into standby mode, turning off the display, and turning off the hard-disk drive. For more information on power management options, see Windows Help or Windows Help and Support Center.

Windows XP controls the performance level of the processor depending on the power scheme you select. You do not need to make any further adjustments to set the performance level. For more information on setting processor performance, see "[Using Intel Speedstep.](#)"

## Alarms Tab

 **NOTE:** To enable audible alarms, click each **Alarm Action** button and select **Sound alarm**.

The Low battery alarm and Critical battery alarm settings alert you with a message when the battery charge falls below a certain percentage. When you receive your computer, the Low battery alarm and Critical battery alarm check boxes are selected. Dell recommends that you continue to use these settings. See "[Battery Warnings](#)" for more information on low battery warnings.

## Power Meter Tab

The Power Meter tab displays the current power source and amount of battery charge remaining.

## Advanced Tab

The Advanced tab allows you to:

- Set power icon and standby mode password options.

 **NOTES:** If you are going to connect your computer to a port replicator or a docking station, click **None** when you program the display-close option. This setting ensures that your computer does not enter standby mode or hibernate mode when you close (lower) the display.

*If the computer is running Windows 98, set power management options in the system setup program.*

- Program the following functions:
  - Activate standby mode.
  - Activate hibernate mode.
  - Shut down Windows and turn off the computer.
  - Choose no action (None).

To program these functions, click an option from the corresponding pull-down menu, and then click OK.

## Hibernate Tab

The Hibernate tab lets you enable hibernate mode by clicking the Enable hibernate support check box.

---



## ENERGY STAR® Emblem

---

The EPA's ENERGY STAR® Computers program is a joint effort between the EPA and computer manufacturers to reduce air pollution by promoting energy-efficient computer products. The EPA estimates that use of ENERGY STAR® computer products can save computer users up to two billion dollars annually in electricity costs.

---

[Back to Contents Page](#)

# Using the System Setup Program: Dell™ Latitude™ C600/C500 User's Guide

 [Overview](#)

 [Entering and Exiting the System Setup Program](#)

 [The System Setup Screens](#)

 [Changing the Boot Sequence](#)

 [Changing Printer Modes](#)

 [Changing COM Ports](#)

 [Enabling the IR Port](#)



*NOTE: This section provides general information on using the system setup program. For detailed information on options and settings, see "Using the System Setup Program" in the computer User's Guide at the Dell support Web site at <http://support.dell.com>.*

---

## Overview

Each time you turn on your computer, it compares the installed hardware with the system configuration information stored in nonvolatile random-access memory (NVRAM). If the system detects a discrepancy, it generates an error message for each incorrect configuration setting.

- To adjust the configuration settings for APM operating systems, such as Microsoft® Windows® 98 or Windows NT®, you can use the system setup program.
- ACPI operating systems, such as Windows 2000 and Windows XP, automatically configure most of the setup options available in the system setup program. In such cases, the operating system overrides system setup options entered through the system setup program. One exception is the External Hot Key option, which you can disable or enable only through the system setup program. For more information on configuring features for these operating systems, see your Microsoft Windows Help.



*NOTE: For ACPI operating systems, the system setup program is accessible only during the system boot routine.*

You can use the system setup program as follows:

- To set or change user-selectable features — for example, your password or power management features
- To verify information about your computer's current configuration, such as the amount of system memory

For some setup options, you must reboot the computer before any changes take effect. Changes for other options take effect immediately.



*NOTE: If you change an option that is activated by rebooting, the system setup program displays the setting you selected rather than the setting currently in effect. You **must** reboot for the new setting to take effect.*



After you set up your computer, run the system setup program to familiarize yourself with your system configuration information and optional settings. Dell recommends that you write down the information for future reference.

## Entering and Exiting the System Setup Program

Action	Operating System	Key Combinations	External Keyboard Key Combinations
Enter the system setup program	Windows 98, Windows NT	<Fn><F1> any time  <F2> during the system boot routine	<Scroll Lock><F1> if the External Hot Key option is enabled
	Windows 2000, Windows XP	<F2> when the F2 message appears during the system boot routine	<F2> when the F2 message appears during the system boot routine
Enter the Battery Status screen of the system setup program	Windows 98, Windows NT	<Fn><F3> any time	<Scroll Lock><F3> if the External Hot Key option is enabled
Exit the system setup program	All	<Esc>  If you change the setting of an option that requires rebooting to take effect, exit the operating system <i>before</i> rebooting. (The Help text in the upper-right corner of system setup screens 1, 2, and 4 tells you if the computer must be rebooted.)	<Esc>



**NOTE:** If the system setup program is running when the computer enters suspend mode, the computer exits the system setup program and then activates suspend mode.

## The System Setup Screens

The system setup screens display the current setup and configuration information and optional settings for your computer. Information on the screens is organized in five boxed areas:

- Title

The box at the top of all screens lists the page number, system name, and version number of the basic input/output system (BIOS).

- Options

The box on the left half of screens 1, 2, 4, and 5 lists options that define the installed hardware in your computer and the power conservation and security features for your computer.

Fields next to the options contain settings or values. You can change those values that appear bright on the screen. Options or values that you cannot change (because they are determined or calculated by the computer) appear less bright.

- Help

The box on the upper-right half of screens 1, 2, 4, and 5 displays help information for the option with a currently highlighted field.

- Computer data

The box in the lower-right corner of screens 1, 2, 4, and 5 displays information about your computer.

- Key functions

The line of boxes across the bottom of all screens lists keys and their functions within the system setup program.

---

## Changing the Boot Sequence

To change the computer's boot sequence, change the device settings in the Boot First device, Boot Second device, or Boot Third device options.

Boot Sequence Option	Description	Default
Boot First device	Tells the computer where to look first for the software it needs to start the operating system	Diskette Drive
Boot Second device	Tells the computer where to look if it cannot find the software it needs to start the operating system on the drive identified in Boot First device	Internal HDD
Boot Third device	Tells the computer where to look if it cannot find the software it needs to start the operating system on the drive identified in Boot First Device or Boot Second device	None

For a change in the boot sequence options to take effect, you must reboot your computer.

The term *boot* refers to the computer's start-up procedure. When you turn on the computer, it "bootstraps" itself into an operational state by loading into memory a small program, which in turn loads the necessary operating system. The *boot sequence* tells the computer where to look to find the software needed to start the operating system.

---

## Changing Printer Modes

Set the Parallel Mode option according to the type of printer or device connected to the parallel port. The

default for Parallel Mode is ECP.

To determine the correct mode to use, see the documentation that came with the device.



*NOTE: The **ECP** setting also works for most software written for the AT and PS/2 modes. Devices that use **ECP** mode may come with special drivers that need to be installed in order to use these modes.*

Setting Parallel Mode to Disabled disables the parallel port and its assigned LPT address, freeing its interrupt for another device to use.

For a change in the Parallel Mode option to take effect, you must reboot your computer.

---

## Changing COM Ports

Serial Port allows you to map the address of the serial port to COM1 (the default), COM2, COM3, COM4, or to disable the serial port and its assigned COM address, freeing that interrupt for another device to use.

---

## Enabling the IR Port

To enable the infrared (IR) port on the computer or docking device:

1. Set the Infrared Data Port option to COM1, COM2, COM3 (recommended), or COM4. The default for Infrared Data Port is Disabled.
2. Set the Infrared Mode option to either Fast IR or Slow IR.

For a change in the Infrared Data Port option to take effect, you must reboot your computer.

---

[Back to Contents Page](#)

# Reinstalling Software: Dell™ Latitude™ C600/C500 User's Guide

 [Installing Drivers and Utilities](#)

 [Installing the Asset Tag Utility](#)

 [Installing the Internal Modem and Network Adapter Drivers \(Optional\)](#)

 *NOTES: Dell recommends that you print these procedures before you begin.*

*You may need administrator privileges to perform some of the procedures in this section. Dell recommends that you check with your network administrator before performing the procedures.*

---

## Installing Drivers and Utilities

The Dell *ResourceCD* for your computer contains most of the drivers that you will need for your computer, including drivers for operating systems that may not be on your computer. Verify that the driver you are loading is for your operating system.

To reinstall drivers for optional devices such as wireless communications, DVD drives, and Zip drives, see the software CD and documentation that came with those devices.

You can also access and download new drivers, system tools, and documentation from Dell's technical support page at [support.dell.com](http://support.dell.com). For more information on using the operating system installed on your computer by Dell, see the operating system user's guide that came with your computer.

NOTICE: Before you reinstall drivers, make sure that your computer is undocked.

To install a driver or utility from your *ResourceCD*:

1. Save your work in all open programs.
2. Insert your *ResourceCD* into the CD or DVD drive.

In most cases, the CD should start running automatically. If it does not, start Microsoft® Windows® Explorer, click your CD drive directory to display the CD contents, and then click the `autorcd` application file. If a welcome screen appears, click Next. The first time that you run the CD, it might prompt you to install some setup files. Click OK and follow the instructions on the screen to continue.

3. From the Language pull-down menu in the toolbar, select your preferred language for the driver or utility (if available).

A welcome screen appears.

4. Click Next.
5. Under Search Criteria, select the appropriate categories from the System Model, Operating

System, Device Type, and Topic pull-down menus.

A link or links appear(s) for the specific drivers or utilities used by your computer.

6. Click the link of a specific driver or utility to display information about the driver or utility you want to install.
7. At the driver information screen, do one of the following:
  - Click the Install button (if present) to start the automatic installation. At the welcome screen, follow the screen prompts to complete the installation.
  - If no Install button is present, automatic installation is not an option. For installation instructions, either go to the appropriate procedure below or click Extract, follow the extracting instructions, and read the readme file.



*NOTE: If instructed to navigate to the driver files, click the CD directory on the driver information screen to display the files associated with that driver.*

---

## Reinstalling the Asset Tag Utility

1. Insert the *ResourceCD*.

In most cases, the CD should start running automatically. If it does not, start Windows Explorer, click your CD drive directory to display the CD contents, and then double-click the autorcd application file. If a welcome screen appears, click Next. The first time that you run the CD, it might prompt you to install some setup files. Click OK and follow the instructions on the screen to continue.

2. Under Search Criteria, select the appropriate categories from the System Model, Operating System, and Device Type pull-down menus, and select Utilities from the Topic pull-down menu.

A link or links appear(s) for the specific utilities used by your computer.

3. Click Asset Tag.
4. Click Extract.
5. Unzip the Asset Tag utility on the *ResourceCD* to the c:\dell\util directory on your hard-disk drive.

To use the utility, see "[Assigning an Asset Tag](#)."

---

## Manually Reinstalling the Internal Modem and Network Adapter Drivers (Optional)

*If you ordered the internal modem, you need to reinstall the modem driver.*

*If you ordered the combination modem/network adapter, you need to reinstall both the modem and network adapter drivers.*

To install a modem or network adapter driver, use the appropriate procedure in this section, depending on your operating system.

### Installing the Modem or Network Adapter Driver for Windows XP

1. Save your work in all open programs and insert your *ResourceCD*.
2. Click the Start button, and click Control Panel.
3. Under Pick a category, click Performance and Maintenance.
4. Under or pick a Control Panel icon, click System.
5. On the System Properties screen, click the Hardware tab.
6. Click Device Manager.

*If you are installing a modem driver, click Modem and then click the appropriate modem.*

*If you are installing a network adapter, click Network adapters, and then click 3Com3C920 Integrated Fast Ethernet Controller.*

7. Click Action, and then click Update Driver.
8. Select Install from a list or specific location (Advanced), and then click Next.
9. Verify that Search removable media is selected, and then click Next.
10. When the name of the appropriate driver appears, click Next.
11. Click Finish to restart your computer.

### Installing the Modem or Network Adapter Driver for Windows 2000 and Windows 98

1. Save and close any open files, exit any open programs, and insert your *ResourceCD*.
2. Click the Start button, point to Settings, and then click Control Panel.
3. From the Control Panel, double-click the System icon.
4. In the System Properties window, click the Hardware tab.
5. Click Device Manager.

*If you are installing a modem driver, click Modem and then click the appropriate modem.*

*If you are installing a network adapter, click Network adapters, and then click 3Com 3C920 Integrated Fast Ethernet Controller.*

6. Click Action, and then click Properties.

7. Click the Driver tab, click Update driver, and then click Next.
8. Verify that Search for a suitable driver for my device (Recommended) is selected, and then click Next.
9. Verify that CD-ROM drives is selected, and then click Next.
10. When the name of the appropriate driver appears, click Next.
11. Click Finish and restart your computer.

## Installing the Modem Driver for Windows NT

1. Save your work in all open programs.
2. Insert your *ResourceCD* into the CD or DVD drive.  
In most cases, the CD should start running automatically. If it does not, start Windows Explorer, click your CD drive directory to display the CD contents, and then click the autorcd application file. If a welcome screen appears, click Next. The first time that you run the CD, it might prompt you to install some setup files. Click OK and follow the instructions on the screen to continue.
3. From the Language pull-down menu in the toolbar, select your preferred language for the driver or utility (if available).
4. On the welcome screen, click Next.
5. Under Search Criteria, select the appropriate categories from the System Model, Operating System, Device Type, and Topic pull-down menus.

A link or links appear(s) for the specific drivers or utilities used by your computer.

6. Click the link of a specific driver or utility to display information about the driver or utility you want to install.
7. At the driver information screen, click Extract.



*NOTE: If instructed to navigate to the driver files, click the CD directory on the driver information screen to display the files associated with that driver.*

8. Click the Start button and then click Run.
9. In the Run window in the Open box, type  
C:\Dell\Drivers\R25586\Drivers\Modem\NT\MdmSetup\Setup.
10. Click OK.
11. In the introductory dialog box, click Next.
12. Follow the directions on your display to complete the driver installation.

## Installing the Combination Modem and Network Adapter Drivers for Windows NT

To install the combination modem and network adapter drivers, you need to install the modem driver, the network adapter driver, and the Mini PCI AMP software as described in the following sections:

### Installing the Modem Driver

1. Save your work in all open programs.
2. Insert your *ResourceCD* into the CD or DVD drive.

In most cases, the CD should start running automatically. If it does not, start Windows Explorer, click your CD drive directory to display the CD contents, and then click the autorcd application file. If a welcome screen appears, click next. The first time that you run the CD, it might prompt you to install some setup files. Click OK and follow the instructions on the screen to continue.

3. From the Language pull-down menu in the toolbar, select your preferred language for the driver or utility (if available).
4. On the welcome screen, click Next.
5. Under Search Criteria, select the appropriate categories from the System Model and Operating System pull-down menus.
6. Under Device Type, select Communications.
7. Under Topic, select Drivers.
8. Click the combination modem/network adapter name to display information about the driver.
9. At the driver information screen, click Extract.
10. Follow the information on the screen to unzip the drivers onto your hard-disk drive.
11. Click the Start button and then click Run.
12. In the Open box, type `C:\Dell\Drivers\68GFM\Drivers\Modem\NT\MdmSetup\Setup`.
13. Click OK.
14. In the introductory dialog box, click Next.
15. Follow the directions on your display to complete the driver installation.

### Installing the Network Adapter Driver

1. Click the Start button, point to Settings, and then click Control Panel.
2. In the Control Panel window, double-click the Network icon.



3. In the Network window, click the Adapter tab and then click Add.
4. In the Select Network Adapter window, click Have Disk.
5. In the Insert Disk window, type `C:\Dell\Drivers\68GFM\Drivers\NIC\Win_NT`, and click OK.
6. Click the Ethernet adapter, and then click OK.
7. In the network configuration window, type the network specific configuration and click OK.
8. When the Network window appears, click Close.
9. After all the configuration information is complete and you are prompted to restart the computer, click Yes.

#### Install the Mini PCI AMP Software

1. Insert the *Dell Latitude C500/C600 Resource CD* into your CD or DVD drive.
2. Click the Start button and then click Run.
3. In the Open box, type `C:\Dell\Drivers\69GFM\Drivers\NIC\SoftexNT\Setup.exe`.
4. Click OK.
5. In the introductory dialog box, click Next.
6. Follow the prompts to finish installing the drivers.
7. When the installation is complete, restart your computer.

---

[Back to Contents Page](#)

# Finding Solutions: Dell™ Latitude™ C600/C500 User's Guide

- [Overview](#)
  - [Recover From a Program That Is Not Responding](#)
  - [Restart a Computer That Is Not Responding](#)
  - [Wet Computer](#)
  - [Dropped or Damaged Computer](#)
  - [No Power at All](#)
  - [No Power, Using AC Adapter](#)
  - [No Power, Using Battery](#)
  - [Only Partial Power](#)
  - [Diskette Drive Problems](#)
  - [Removable Storage Drive Problems](#)
  - [Hard-Disk Drive Problems](#)
  - [Hardware Conflicts](#)
  - [Incorrect Computer Memory Amount](#)
  - [Intel SpeedStep Problems](#)
  - [PC Card Problems](#)
  - [Modem, Fax, and Internet Connection Problems](#)
  - [No Image Appears on Display](#)
  - [No Image Appears on External Monitor](#)
  - [No Image Appears on TV](#)
  - [Sound and Speaker Problems](#)
  - [DualPoint Device, Touch Pad, or Mouse](#)
  - [<Num Lock>, <Caps Lock>, and <Scroll Lock> Lights Don't Light Up](#)
  - [External Keyboard Doesn't Work](#)
  - [Devices Attached to Serial or Parallel Ports Don't Work](#)
  - [Parallel Port Printer Doesn't Work](#)
  - [Software Solutions](#)
- 

## Overview

Before you call Dell for technical assistance, complete the following tasks to help you resolve some computer problems:

1. Read the safety instructions in your *System Information* guide and "[What You Need to Know](#)."
2. Run the [Dell Diagnostics](#) to help you detect a problem quickly.

If you are running Microsoft® Windows® XP, you can also use tools available in the Windows Help and Support Center.



3. Perform the appropriate procedure for the component or equipment that is malfunctioning. Click a [topic from the menu](#) at the top of this page for instructions.



**NOTE:** When you see the question "Is the problem resolved?" in a problem-solving procedure, perform the operation that caused the problem to see if the problem still occurs.

 **CAUTION:** To help prevent possible damage to the system board, wait 5 seconds after turning off the computer before you disconnect a device or remove a memory module.

**NOTICE:** Only access the inside of your computer when you are installing memory modules.

Problem	Procedure
Recover From a Program That Is Not Responding	<ol style="list-style-type: none"> <li>1. Press &lt;Ctrl&gt;&lt;Alt&gt;&lt;Del&gt;.</li> <li>2. If necessary, click Task Manager.</li> <li>3. Select the program that is no longer responding.</li> <li>4. Click End Task.</li> </ol>
Restart a Computer That Is Not Responding	<ol style="list-style-type: none"> <li>1. Press and hold the power button until the computer turns off.</li> <li>2. To turn on the computer, press the power button.</li> </ol> <p>ScanDisk, a program that checks for and repairs errors on the hard-disk drive, may run during the boot process. The Windows operating system loads and runs after the scan completes.</p>
<p><b>Wet Computer</b></p> <p> Spills, splashes, and excessive humidity can cause moisture damage to the computer.</p>	<p> <b>CAUTION:</b> Perform step 1 only after you are certain that it is safe to do so. If the computer is connected to an electrical outlet, Dell recommends turning off AC power at the circuit breaker before attempting to remove the power cables from the electrical outlet. Use the utmost caution when removing wet cables from live power.</p> <ol style="list-style-type: none"> <li>1. Turn off the computer and disconnect it from the AC adapter. Then disconnect the AC adapter from the electrical outlet. Turn off any attached peripherals and disconnect them from their power sources and then from the computer.</li> <li>2. Ground yourself by touching one of the metal connectors on the back of the computer.</li> <li>3. If the modular bay is wet, <a href="#">remove the device</a> from the bay. If the PC Card slot is wet, <a href="#">remove any PC Cards</a>. Put the device and cards in a safe place to dry.</li> <li>4. Remove any <a href="#">installed batteries</a>.</li> </ol> <p>Wipe off each battery and store it in a safe place to dry.</p> <ol style="list-style-type: none"> <li>5. Remove the <a href="#">hard-disk drive</a>.</li> <li>6. Remove the <a href="#">memory module(s)</a>.</li> <li>7. Open the display, and place the computer across two books or similar props to let air circulate all around it. Let the computer dry for at least 24 hours.</li> </ol> <p>Place the computer in a dry area at room temperature. Do not use artificial means to speed up the drying process.</p> <p> <b>CAUTION:</b> Before continuing with this procedure, verify that the computer is thoroughly dry.</p>

8. Ground yourself by touching one of the unpainted metal connectors on the I/O panel.
9. Replace the memory module(s).
10. Replace the memory module cover.
11. Reinstall the hard-disk drive.
12. Reinstall the modular bay and PC Cards that you removed.
13. Replace any batteries that you removed.
14. Reconnect the computer and peripherals to an electrical outlet and turn them on.
15. Does the computer work properly?

**Yes.** The problem is resolved.

**No.** If the computer is able to boot, run the [Dell Diagnostics](#) to identify computer damage. If the computer is unable to boot, see "[No Power at All](#)." If you cannot identify the damaged component(s), call Dell for technical assistance. (See "[Getting Help](#)".)

#### Dropped or Damaged Computer

1. Save and close any open files, exit any open application programs, and shut down the computer.
2. Disconnect the AC adapter from the electrical outlet and disconnect the AC adapter from the computer. Turn off any attached devices and disconnect them from the electrical outlet and then from the computer.
3. Ground yourself by touching one of the metal connectors on the back of the computer.
4. Remove any [installed batteries](#) or other devices from the [modular bay](#).
5. Remove the [hard-disk drive](#).
6. Remove the [memory module cover](#) and the memory module(s).
7. Reinstall the memory modules, making sure to seat them properly.
8. Replace the memory module cover.
9. Reinstall the hard-disk drive.
10. Verify that any installed PC Cards are properly seated in the PC Card connectors.
11. Reinstall the battery or other device(s) removed from the modular bay. Verify that the device(s) is seated properly.
12. Reconnect the computer and peripherals to the electrical outlet and turn them on.
13. Run the [Dell Diagnostics](#) to verify that the computer is operating properly.
14. If the computer does not operate properly, fill out the [Diagnostics Checklist](#). Then [call Dell](#) for technical assistance.

#### No Power at All



If you don't have any power, none of the lights on the keyboard or drives light up and you won't hear sounds from any drives. See also "[Only Partial Power](#)."

Fill out the [Diagnostics Checklist](#) as you perform the following steps:

1. Connect the [AC adapter](#) to the computer and to an electrical outlet.
2. Remove all devices, including internal devices such as the [diskette drive](#), [hard-disk drive](#), and [battery](#).
3. [Turn on](#) the computer.
4. Does the computer turn on properly?

**Yes.** The problem is resolved.

**No.** Go to Step 5.

5. Turn off the computer. Does the power status light appear?

**Yes.** Go to step 6.

**No.** Go to step 7.

6. Remove any [installed batteries](#) and disconnect the AC adapter. Then reinstall the batteries, reconnect the AC adapter, and turn on the computer. Does the power status light appear?

**Yes.** Go to step 8.

**No.** Go to step 7.

7. Turn off the computer, wait a few seconds, and then turn on the computer again. Does the power status light appear?

**Yes.** Your computer is receiving power. Go to step 8.

**No.** Your computer is not receiving power. Go to step 9.

8. Does the computer boot successfully?

**Yes.** The problem is resolved.

**No.** Go to step 9.

9. Remove and reinstall any batteries, and check the AC adapter connection. Does the power status light appear?

**Yes.** The problem is resolved.

**No.** If the computer is powered by the AC adapter, see "[No Power, Using AC Adapter](#)." If the computer is using battery power, see "[No Power, Using Battery](#)."

No Power, Using  
AC Adapter

Basic Checks:

- Test the electrical outlet: Ensure that the electrical outlet is working by testing it with another device such as a lamp.
- Connect the AC adapter directly to an electrical outlet: Bypass power protection devices, power strips, and extension cords to verify that the computer turns on.
- Check for interference: High-voltage electrical appliances on the same circuit or operating in close proximity to the computer can cause interference. Extension cords or too many devices on a power strip or multiple power strips connected to an electrical outlet can cause problems.

Fill out the [Diagnostics Checklist](#) as you perform the following steps:

1. Turn off the computer and devices and disconnect them from the electrical outlet. If you are using a surge protector, remove it.

2. Make sure the [AC adapter](#) is connected to the computer, and then verify that the power cable is firmly attached to the AC adapter and to the electrical outlet.
3. Does the light on top of the AC adapter light up?
  - Yes.** Go to step 4.
  - No.** The AC adapter may be defective. Go to step 5.
- Turn on the computer. Does the power status light appear?
  - Yes.** The problem is resolved.
  - No.** Go to step 5.
5. [Call Dell](#) for technical assistance.

### No Power, Using Battery



If an AC adapter is not connected to your computer, the computer runs on battery power. If the computer does not turn on when a battery is installed, the battery's [charge](#) may be depleted.

Fill out the [Diagnostics Checklist](#) as you perform the following steps:

1. Turn off the computer and devices. Disconnect the devices from the electrical outlet.
2. [Remove and then reinstall each battery](#) in its bay.
3. Press the power button. Does the computer turn on?

Allow 1 minute for the computer to initialize its components before checking for signs of power.

**Yes.** The battery was not seated properly. The problem is resolved.

**No.** Use the AC adapter to connect your computer to an electrical outlet. If the computer operates normally when using AC power, go to step 4. If the computer does not boot when using the AC adapter, see "[No Power, Using AC Adapter](#)."

4. Use the AC adapter to [charge the battery](#).
5. Does the battery status light remain constantly lit (not blinking), indicating that the battery is charging?

**Yes.** Go to step 6.

**No.** You may have a defective battery. [Call Dell](#) for technical assistance.

6. Press the power button. Does computer turn on?

**Yes.** You needed to charge the battery. The problem is resolved.

**No.** [Call Dell](#) for technical assistance.

### Only Partial Power



If the power status light shows that your computer is receiving power, but

1. Turn off the computer and devices and disconnect them from the electrical outlet. Disconnect any attached devices from the computer.
2. Make sure that the [AC adapter](#) is connected to the computer and to an electrical outlet, or confirm that a fully charged battery is properly seated in the modular bay.

the display remains blank, part of your computer is probably not receiving power. See also "[No Power at All.](#)"

3. Turn on the computer. Is the display on?

Allow 1 minute for the computer to initialize its components before checking for signs of power.

**Yes.** The entire computer is receiving power; the problem is resolved.

**No.** [Adjust the brightness](#) of the display. If the display still does not show an image, [call Dell](#) for technical assistance.

## Diskette Drive Problems



During the power-on self-test (POST), the computer checks the diskette drive, comparing its characteristics with the system configuration information. (The diskette-drive access light blinks as the computer performs this check on a diskette drive.)

### Basic Checks:

- If you hear an unfamiliar scraping or grinding sound when a drive is accessed, make sure the sound is not caused by the application program that is running. The sound could be caused by a hardware malfunction. See "[Getting Help](#)" for instructions on obtaining technical assistance from Dell.
- When you turn on the computer, you can hear diskette or hard-disk drive activity during the boot routine. If your computer does not boot, call Dell for technical assistance. (See "[Getting Help](#)" for instructions.) Otherwise, see the "[Dell Diagnostics.](#)"
- Test this indicator by inserting a diskette into the drive, typing `dir a:` at an MS-DOS prompt, and pressing <Enter>.
- Ensure that the diskette is not write-protected if you are trying to copy data to it.
- Run the Diskette tests as described in "[Dell Diagnostics.](#)"
- Try a different diskette in the drive. If the new diskette works, the original one may be defective.
- Check the settings on the Page One submenu of the [system setup program](#).
- Clean the drive using a commercially available cleaning kit.

NOTICE: Do not attempt to clean drive heads with a swab. You may accidentally misalign the heads, rendering the drive inoperable.

If the problem still exists after you complete the basic checks, fill out the [Diagnostics Checklist](#) as you perform the following steps:

1. Save and close any open files, exit any open application programs, and shut down the computer.
2. Remove the diskette drive from the [modular bay](#).
3. Reinstall the diskette drive.
4. Reboot the computer. Does the diskette-drive access light blink during the boot routine?

**Yes.** Go to step 6.

**No.** Go to step 5.

5. Remove and reinsert the diskette drive (or disconnect and reconnect the drive if used [externally](#)). Reboot the computer. Does the diskette-drive access light appear during the boot routine?

**Yes.** Go to step 6.

**No.** Go to step 9.

6. Does the computer display a drive error message?

**Yes.** See [Table 1](#) in "Understanding Error Messages" for an explanation of the message, and then go to step 7.

**No.** Go to step 9.

7. Insert a bootable 1.44-megabyte (MB) diskette into the diskette drive and reboot the computer.

8. Does the diskette-drive access light blink during the boot routine, and does the drive boot the operating system?

**Yes.** The diskette drive problem has probably been resolved. If you continue to experience trouble, [call Dell](#) for technical assistance.

**No.** Go to step 9.

9. Call Dell for technical assistance.

## Removable Storage Drive Problems

 During POST, the computer checks the removable storage drive (such as a CD-ROM drive), comparing its characteristics with the system configuration information. The access light on the drive and hard-disk drive blink as the computer performs this check.

Inconsistencies in the manufacturing of CD-ROM media may cause some higher-speed CD-ROM drives to vibrate more than others. Such vibration and associated noise do not indicate a defect in the drive or the CD.

## Basic Checks:

- If you hear an unfamiliar scraping or grinding sound when a drive is accessed, make sure the sound is not caused by the application program that is running. The sound could be caused by a hardware malfunction. See "[Getting Help](#)" for instructions on obtaining technical assistance from Dell.
- When you turn on the computer, you can hear diskette or hard-disk drive activity during the boot routine. If your computer does not boot, call Dell for technical assistance. (See "[Getting Help](#)" for instructions.) Otherwise, see the "[Dell Diagnostics](#)."
- Test the drive indicator by typing `dir x:` at an MS-DOS prompt, where `x` is the drive letter, and pressing <Enter>.
- Double-click the My Computer icon on your desktop and verify that the drive is recognized by the computer. Most of the common boot sector viruses cause the drive to "disappear." Use virus-scanning software (if Dell installed the operating system on your computer, you should already have virus-scanning software) to check for and remove any viruses.
- Clean the disc using a commercially available cleaning kit.
- Clean the drive using a commercially available cleaning kit.
- Try another CD or DVD.



*NOTE: Because of different conventions currently used in the industry, not all DVD titles work in all DVD-ROM drives.*

- Run the IDE Devices tests as described in "[Dell Diagnostics](#)."
- Turn off the computer and remove the drive from the modular bay. Replace the drive and turn on the computer.

If the problem still exists after you complete the basic checks, fill out the [Diagnostics Checklist](#) as you perform the following steps:



1. Save and close any open files, exit any open application programs, and shut down the computer.
2. Remove the drive from the [modular bay](#).
3. Reinstall the drive.
4. Reboot the computer. Does the drive access light blink during the boot routine?

**Yes.** Go to step 6.

**No.** Go to step 5.

- Remove and reinsert the drive. Reboot the computer. Does the drive access light blink during the boot routine?

**Yes.** Go to step 6.

**No.** Go to step 10.

6. Remove the [hard-disk drive](#) and boot the computer from a bootable CD. Does the drive access light blink?

**Yes.** Go to step 7.

**No.** Go to step 10.

7. Reinstall the hard-disk drive. Then check the `config.sys` file (in Windows 98, check the CD-ROM or DVD-ROM drive configuration in the Settings folder). Is the appropriate driver installed?

**Yes.** Go to step 8.

**No.** Load the driver, and return to step 1 to begin this procedure again. (To load the driver, use the *ResourceCD* you received with your Dell computer.)

8. Insert a bootable diskette into drive A and reboot the computer.
9. Type `x:` (where `x` is the drive) and press <Enter>. Then type `dir` and press <Enter>. Does MS-DOS display the root directory contents for the drive?

**Yes.** The problem is resolved.

**No.** Go to step 10.

10. Insert your *ResourceCD* into the drive and reboot the computer. Then run the IDE Devices device group. Does your drive pass all the tests?

**Yes.** Return to step 1 and perform this troubleshooting procedure again. If you continue to experience trouble, [call Dell](#) for technical assistance.

**No.** Go to step 11.

11. Call Dell for technical assistance.

## Problems



During POST, the computer checks the hard-disk drive, comparing its characteristics with the system configuration information. (The drive access light blinks as the computer performs this check.)

- If you hear an unfamiliar scraping or grinding sound when a drive is accessed, make sure the sound is not caused by the application program that is running. The sound could be caused by a hardware malfunction. See "[Getting Help](#)" for instructions on obtaining technical assistance from Dell.
- When you turn on the computer, you can hear diskette or hard-disk drive activity during the boot routine. If your computer does not boot, call Dell for technical assistance. (See "[Getting Help](#)" for instructions.) Otherwise, see the "[Dell Diagnostics](#)."
- Test the drive indicator by typing `dir x:` at an MS-DOS prompt, where `x` is the drive letter, and pressing <Enter>.
- Run the Check Disk (or ScanDisk) utility. To do this, double-click the My Computer icon (or click the Start button, and then click My Computer), right-click the hard-disk drive, click Properties, select the Tools tab, click Check Now, and click Start.
- For Windows NT®, run the error-checking utility by opening the property sheet of the affected volume(s) and clicking Check Now in the Error-checking section of the Tools tab.
- Run the IDE Devices device group as described in "[Dell Diagnostics](#)."

If the problem still exists after you complete the basic checks, fill out the [Diagnostics Checklist](#) as you perform the following steps:

1. Shut down the computer.
2. Reboot the computer. Does the drive access light blink during the boot routine, and does the drive boot the operating system?

**Yes.** If a message appears on the display, see "[Understanding Error Messages](#)," for an explanation of the message and possible corrective actions. Then go to step 7.

**No.** Go to step 3.

3. Insert a bootable diskette into drive A and reboot the computer.
4. Type `c:` and press <Enter>. Then type `dir` and press <Enter>. Does MS-DOS display the root directory contents for drive C?

**Yes.** Go to step 6.

**No.** Go to step 5.

5. If your hard-disk drive has more than one logical drive, type `x:` (where `x` is the CD-ROM or DVD-ROM drive) and press <Enter>. Then type `dir` and press <Enter>. Does MS-DOS display the root directory contents for the CD-ROM and DVD-ROM drive?

**Yes.** You may have a corrupted boot sector or file allocation table (FAT) on drive C. Go to step 9.

**No.** Go to step 8.

6. Rename your `autoexec.bat` and `config.sys` files, remove the operating

system diskette from drive A, and reboot the computer. Does the operating system load now?

**Yes.** You have an error in your `autoexec.bat` or `config.sys` file. Use a text editor to examine the contents of these files and locate the error. For information on the correct syntax for commands in these files, see the documentation that accompanied your operating system.

**No.** Go to step 7.

7. Insert your *ResourceCD* and reboot the computer. Then run the IDE Devices device group. Does your drive pass all the tests?

**Yes.** Go to step 8.

**No.** Go to step 9.

8. Replace your *ResourceCD* with the operating system CD, and reboot the computer. Does the operating system load now?

**Yes.** The hard-disk drive may contain a corrupted operating system or it may have bad sectors. Reinstall the operating system as described in the documentation that came with it. If reinstalling the operating system does not correct the problem, go to step 9.

**No.** Go to step 9.

9. [Call Dell](#) for technical assistance.

## Hardware Conflicts

 Hardware conflicts occur if the device is detected by the operating system but is configured incorrectly.

### Symptoms:

- System hangs or locks up, particularly while using a device.
- (Memory) parity errors on parity-enabled systems.
- Noise or other problems from sound cards.
- Junk being printed on your

Hardware conflicts occur if the device is detected by the operating system but is configured incorrectly. To check for conflicts, perform the following steps:

1. Open the Control Panel (*if you are running Windows 2000, Windows 98, or Windows NT*, click the Start button, point to Settings, and double-click Control Panel; *if you are running Windows XP*, click the Start button, and click Control Panel).
2. In the Control Panel, double-click System.
3. Click the Hardware tab, and click Device Manager.
4. Conflicts are indicated in the Device Manager list by a yellow exclamation point (!) beside the conflicting device. A red X beside a device indicates that the device is disabled in the current hardware profile.

View the status of a device by double-clicking the type of device, clicking Properties, and clicking the General tab.

5. If a hardware conflict exists, the Device status area in the Properties window shows the conflicting expansion cards or devices.

To resolve conflicts, see your operating system documentation.

printer.

- The mouse pointer hanging and refusing to move, or moving in a stuttering fashion.
- Error messages from Windows, messages about the computer not operating at maximum performance, or the system dropping to "Safe Mode" or "MS-DOS Compatibility Mode".
- Errors and crashes of applications for no apparent reason.

### Incorrect Computer Memory Amount



During POST, the computer checks the computer's memory, and then writes to and reads from the number of available bytes to ensure proper operation.

### Basic Checks:

- If an insufficient memory message appears, save and close any open files and exit any open application programs not in use.
- Consider installing additional system memory.
- Run the System Memory test as described in "[Dell Diagnostics](#)."
- Reseat the [memory modules](#).
- Restart the computer.



If the problem still exists after you complete the basic checks, fill out the [Diagnostics Checklist](#) as you perform the following steps:

1. Reboot the computer. Does the random-access memory (RAM) count displayed correctly match the actual amount of memory installed in the computer?

**Yes.** The computer needed to update the memory; the memory check phase is okay now.

**No.** Go to step 2.

2. Save and close any open files, exit any open application programs, and remove any installed batteries.
3. Turn off the computer and disconnect it from the AC adapter. Then disconnect the AC adapter from the electrical outlet. Turn off any attached devices, and disconnect them from their power sources and then from the computer.
4. Ground yourself by touching one of the metal connectors on the back of the

	<p>computer.</p> <ol style="list-style-type: none"> <li>5. Turn the computer over and remove the <a href="#">memory module cover</a> and the memory modules.</li> <li>6. Install the new memory module(s).</li> <li>7. Replace the memory module cover.</li> <li>8. Reboot the computer, and press &lt;F2&gt; when prompted to enter the system setup program.</li> <li>9. <a href="#">Call Dell</a> for technical assistance.</li> </ol>
<p>Intel® SpeedStep™ Problems</p> <p> If you want to adjust the microprocessor's performance level and the SpeedStep Setup option in the system setup program is Disabled, all settings in the <a href="#">Intel SpeedStep properties window</a> are grayed out.</p>	<p>Basic Checks:</p> <ul style="list-style-type: none"> <li>• Ensure that the SpeedStep Setup option in the <a href="#">system setup program</a> is set to Automatic.</li> </ul> <p>After you set the option to Automatic, you can use the <a href="#">Intel SpeedStep properties window</a> to control the microprocessor's performance.</p> <ul style="list-style-type: none"> <li>• If you set the SpeedStep Setup option to Automatic and the settings in the Intel SpeedStep properties window are still grayed out, <a href="#">call Dell</a> for technical assistance.</li> </ul>
<p>PC Card Problems</p>	<p>Basic Checks:</p> <ul style="list-style-type: none"> <li>• Ensure that the <a href="#">PC Card</a> is properly inserted into the connector.</li> <li>• Ensure that the card is recognized by the Windows operating system. <ul style="list-style-type: none"> <li>◦ <i>In Windows XP</i>, click the Start button, and then click Control Panel. Under Pick a category, click Network and Internet Connections. Under or pick a Control Panel icon, click Network Connections. Ensure that the card is listed in the LAN or High-Speed Internet window.</li> <li>◦ <i>In Windows 2000, Windows 98, or Windows NT</i>, click the Start button, point to Settings, and then double-click Control Panel. Double-click the PC Card (PCMCIA) icon. Ensure that the card is listed in the PC Card (PCMCIA) Properties window.</li> </ul> </li> </ul> <p>If you still have problems with a Dell-provided PC Card, <a href="#">call Dell</a> for technical assistance. If you have problems with a non-Dell-provided PC Card, call the card manufacturer.</p>
<p>Modem, Fax, and Internet Connection Problems</p> <p> If you can connect to your Internet service</p>	<p>NOTICE: Connect the modem to an analog line only. Using a nonanalog line, such as a digital or private branch exchange (PBX) line, will damage the modem.</p> <p>Basic Checks:</p> <ul style="list-style-type: none"> <li>• Ensure that you have touchtone telephone service.</li> <li>• If you have call-waiting service, disable call-waiting. Refer to your local</li> </ul>

provider (ISP) and send or receive a fax, your modem is functioning properly. If you are sure that your modem is working properly and you still experience problems connecting to your ISP, contact the ISP technical support department for assistance.

telephone directory or call your telephone service provider for information on temporarily disabling call-waiting.

- If you have voice mail service, you may hear an irregular dial tone when you have messages. Contact your telephone service provider for information on restoring a normal dial tone.
- If you have any other telephone devices plugged into this line, such as answering machines, dedicated fax machines, or line splitters, bypass them and plug the modem cable directly into the telephone connector on the wall.
- Reseat the cable connections.
- Try a different cable; if you are using a cable that is 10 feet or more in length, try a shorter one.
- Disconnect the cable from the modem and plug it directly into a telephone. Listen for a dial tone.
- Line noise can cause low connection speeds. If you have persistent problems, try connecting the modem to a different telephone connector. You may also wish to contact your telephone company to report the problem.

If you still have problems with a Dell-provided modem, [call Dell](#) for technical assistance. If you have problems with a non-Dell-provided modem, call the modem manufacturer.

## No Image Appears on Display



Extended graphics array (XGA) displays support 1024 x 768 pixels, and super extended graphics array plus (SXGA+) displays support 1400 x 1050 pixels. If your application program uses a higher resolution, you must attach an external video graphics array (VGA) monitor to your computer.

## Basic Checks:

- If the display is blank, the computer may be in suspend or standby mode. To resume normal operations, press the power button.
- If the display is blank and the power light is on, the display may have timed out. In this case, press any key on the keyboard or move the mouse to resume normal operation.
- If the [low-battery light](#) is blinking, connect the AC adapter to the computer or replace the battery.
- [Adjust the brightness](#).
- If your computer is attached to an external monitor, press <Fn><F8> to switch the video image to the display.

If the computer is receiving power, but nothing appears on your display (such as light, text, or graphics) or the display image does not appear as you would expect, fill out the [Diagnostics Checklist](#) as you perform the following steps.

1. If the computer is running, press any key on the integrated keyboard. Is the full display readable?

**Yes.** The computer was in standby or suspend mode. The problem is resolved.

**No.** Go to step 2.

2. Is an external monitor connected to the computer?

**Yes.** Go to step 3.

**No.** Go to step 4.

3. Press the <Fn><F8> key combination. Is the full display readable?

**Yes.** The problem is resolved.

**No.** Go to step 8.

4. Turn off the computer and any attached devices. Disconnect all devices from the computer.
5. Make sure the [AC adapter](#) is firmly connected to the computer and to an electrical outlet, or verify that a fully charged battery is properly seated in its bay.
6. Turn on the computer. Is the display on?

Allow one minute for the computer to initialize its components.

**Yes.** Go to step 7.

**No.** Go to step 9.

7. [Adjust the brightness](#). Is the full display readable?

**Yes.** Go to step 8.

**No.** Go to step 9.

8. Has an error message appeared?

**Yes.** See "[Understanding Error Messages](#)," to find the message, along with its explanation. If you can't find the message, [call Dell](#) for technical assistance.

**No.** If you still have a display problem but the display is not completely blank, run the Video device group in the [Dell Diagnostics](#). Then call Dell for technical assistance.

9. Turn off your computer and [connect an external monitor](#) to the computer.
10. Turn on the computer and the monitor and adjust the monitor's brightness and contrast controls. Is the monitor readable?

**Yes.** The computer's display may be defective. [Call Dell](#) for technical assistance.

**No.** The computer's video controller on the system board may be defective. Call Dell for technical assistance.

## No Image Appears on External Monitor

 During POST, the computer checks to see if an external monitor is attached to the computer

### Basic Checks:

- Press <Fn>< F8> to switch the video image from the display to the external monitor.

If the external monitor is blank, the computer may be in standby or hibernate (save-to-disk suspend) mode. To resume normal operations, press the power button.

- Ensure that the video cable is firmly attached to the video connector on the back of the computer and that the monitor power cable is plugged into a working

electrical outlet.

- Check for damaged or frayed cables and for bent pins on connectors. It is normal on some video cable connectors for pins to appear to be missing. See the monitor documentation.
- Check the Video Display Device setting in the system setup program. To use an external monitor, this option must be set to CRT Mode or Simul Mode.
- Adjust brightness and contrast settings.
- Run the VESA/VGA Interface tests as described in "[Dell Diagnostics](#)."
- Restart the computer.

If the problem still exists after you complete the basic checks, fill out the [Diagnostics Checklist](#) as you perform the following steps:

1. Turn off the computer, wait a minute, and then turn the computer back on. Adjust the monitor's brightness and contrast controls. Is the monitor readable?

Allow one minute for the computer to initialize its components.

**Yes.** The problem is resolved.

**No.** Go to step 2.

2. [Adjust the display's brightness](#). Is the full display readable?

**Yes.** The external monitor may be defective. Go to step 3.

**No.** The video controller on the system board may be defective. [Call Dell](#) for technical assistance.

3. Turn off the computer and any attached devices. Disconnect all devices from the computer. Attach another external monitor to the computer.

If you do not have another external monitor, [call Dell](#) for technical assistance.

4. Reboot the computer, and adjust the monitor's brightness and contrast. Allow one minute for the computer to initialize its components.

Is the monitor readable?

**Yes.** The original monitor is defective. [Call Dell](#) for technical assistance.

**No.** [Call Dell](#) for technical assistance.

No Image Appears on TV

Basic Checks:

- Eliminate possible interference. Turn off nearby fans, fluorescent lights, or halogen lamps to check for interference from those devices.
- If you connected a TV to the TV-out connector on your computer and there is no picture on your TV screen, verify the following connections and settings:
  - A composite video cable is connected to the S-video connector on your



TV and the TV-out connector on your computer.

- Check for damaged or frayed cables and for bent pins on connectors.



*NOTE: If your TV did not come with a composite video cable, you can purchase one from a local electronics store.*

- Television Type in the system setup program is set to the correct video standard for your country.
- Television Port is Enabled in the system setup program.

## Check the TV Type Setting

For Microsoft Windows XP

1. Save and close any open files, and exit any open application programs.
2. Shut down your computer.
3. Connect the proper video cable to the S-video TV-out connector on your computer. See "[TV and Digital Audio](#)."
4. Turn on your TV.
5. Verify that the correct video input is selected on the TV.
6. Restart your computer.
7. Click the Start button, and click Control Panel.
8. Under Pick a category, click Appearance and Themes.
9. Under Pick a task..., click Change the screen resolution.
10. In the Display Properties window, click the Settings tab, and then adjust the Screen resolution setting to 800 by 600 pixels.
11. Click the pull-down menu under Color quality, and then click Medium (16 bit).
12. Click OK.

For Microsoft Windows 2000, Windows 98, or Windows NT

1. Save and close any open files, and exit any open application programs.
2. Shut down your computer.
3. Connect the proper video cable to the S-video TV-out connector on your computer. See "[TV and Digital Audio](#)."
4. Turn on your TV.
5. Verify that the correct video input is selected on the TV.
6. Restart your computer.
7. Click the Start button, point to Settings, and double-click Control Panel.
8. Double-click the Display icon.
9. Click the Settings tab.
10. Click the Advanced button.
11. Click the TV button.
12. Set the television type to NTSC (US) or PAL (Europe).



*NOTE: For more information on connecting a TV to your computer, see "[TV and Digital Audio](#)."*

## Check the System Setup Program Settings

1. Click the Start button, and select Shut Down.
2. In the Shut Down window, select Restart the Computer.
3. Click Yes.

Your computer shuts down and restarts.

4. When you see the Dell logo, press <F2> to enter the system setup program.

The system setup program screen appears.

5. Press the right- or left-arrow key to select the Main menu.
6. Press the down-arrow key to scroll down to Television Type.

Either NTSC or PAL is highlighted.

7. To change your selection, press <F6>.



*NOTE: The function key tasks may be different for your particular system setup program. Be sure to check the function key menu at the bottom of your system setup screen.*

8. To save your selection, press <F10>.
9. The Setup Confirmation window appears.
10. Select Yes and press <Enter>.

The computer shuts down and restarts.



*NOTE: For more information on connecting a TV to your computer, see "[Connecting Devices](#)."*

## Sound and Speaker Problems

### Basic Checks:

- If using external speakers:
  - Verify the speaker cable connections.
  - Test the electrical outlet. Verify that the speakers are connected to a working electrical outlet. Ensure that the speakers are turned on.
  - Eliminate possible interference. Turn off nearby fans, fluorescent lights, or halogen lamps to check for interference from those devices.
- Adjust the volume.
- [Reinstall the audio driver](#) for your operating system.

If the problem still exists after you complete the basic checks, fill out the [Diagnostics Checklist](#) as you perform the following steps:

1. Insert your *ResourceCD* into the CD-ROM drive, reboot the computer, and run the Misc. PCI Devices device group in the Dell Diagnostics. The Misc. PCI Devices device group checks the functionality of the audio controller.
2. Do the tests complete successfully?

**Yes.** The controller is functioning properly. If the problem persists, call Dell for technical assistance.

**No.** [Call Dell](#) for technical assistance.

### DualPoint Device, Touch Pad, or Mouse Problems

#### Basic Checks

- If you are using a PS/2 or USB mouse, ensure that the connector is firmly attached. Mouse extension cables can cause problems.
  - If you are using the touch pad or a PS/2 mouse, run the Pointing Devices test as described in "[Dell Diagnostics](#)."
  - Verify that the correct device is listed for the Pointing Devices option in the [system setup program](#). For a USB mouse, you do not have to change the setting. The computer automatically recognizes the USB mouse.
  - [Reinstall](#) the touch pad driver for your operating system.
-  **NOTE:** Be sure to refer to the section specific to your operating system.
- Restart the computer.

If the problem still exists after you complete the basic checks, fill out the [Diagnostics Checklist](#) as you perform the following steps:

1. Insert your *ResourceCD* into the CD-ROM drive, reboot the computer, and run the Mouse test in the Pointing Devices device group in the Dell Diagnostics. The Mouse test checks the functionality of the mouse controller (which affects the ability to move the pointer around the screen) and the operation of the touch pad buttons.
2. Do the tests complete successfully?

**Yes.** The controller is functioning properly. If the problem persists, call Dell for technical assistance.

**No.** [Call Dell](#) for technical assistance.

### <Num Lock>, <Caps Lock>, and <Scroll Lock> Lights Don't Light Up

1. Press the <Num Lock>, <Caps Lock>, and the <Scroll Lock> keys.
2. If their lights do not light, run the PC-AT Compatible Keyboards tests in the [Dell Diagnostics](#).

### External Keyboard Doesn't Work

 When you attach an external keyboard, the integrated keyboard remains fully functional. During POST, the computer checks whether an external keyboard is connected; if it is, the computer recognizes both the integrated keyboard and the external keyboard.

#### Basic Checks:

- Disconnect the keyboard cable from the computer and check the cable connector for bent or broken pins. Check for damaged or frayed cables.
- Check for interference. Keyboard extension cables can cause problems
- Run the PC-AT Compatible Keyboards tests as described in "[Dell Diagnostics](#)."
- Restart the computer.

If the problem still exists after you complete the basic checks, fill out the [Diagnostics Checklist](#) as you perform the following steps:

1. Turn off the computer, and then remove the keyboard cable and check it for bent or broken pins.

**Yes.** If you see bent pins and they can be straightened, straighten them

Use the integrated keyboard:

- when working in MS-DOS mode
- when running the Dell Diagnostics
- when using the system setup program

Do not use external Universal Serial Bus (USB) keyboards with Windows NT

and go to step 2. If they cannot be straightened, or are broken, you need a new keyboard.

**No.** Go to step 2.

2. Reconnect the keyboard to the computer.
3. Make sure the cable from the external keyboard is firmly connected to the keyboard/mouse connector on the back of the computer.
4. Turn on the computer.
5. If you are using a keyboard that can be configured with various switch settings, make sure the switch is set to PS/2, Enhanced XT/AT, or PC/AT.

The switch settings are usually on the bottom of the keyboard, sometimes behind a panel tab. Refer to the documentation that came with the keyboard for more information.

6. Turn off the computer, wait one minute, and then turn it on again. During the boot routine, do the Num Lock, Caps Lock, and Scroll Lock lights on the external keyboard blink momentarily?

**Yes.** Go to step 7.

**No.** You may have a defective keyboard. Go to step 10.

7. Does the computer recognize the external keyboard?

Use the external keyboard to type some characters. Do they appear on the display?

**Yes.** The problem is resolved.

**No.** Go to step 8.

8. Turn off the computer and disconnect the external keyboard from the computer.
9. Turn on the computer. Does the computer recognize the integrated keyboard?

Allow one minute for the computer to initialize its components. Then use the computer's integrated keyboard to type some characters. Do the characters appear on the display?

**Yes.** The external keyboard may be defective. Run the PC-AT Compatible Keyboards device group in the [Dell Diagnostics](#). If you cannot isolate the problem after running the diagnostics, [call Dell](#) for technical assistance.

**No.** Go to step 10.

10. [Call Dell](#) for technical assistance.

Devices Attached to Serial or Parallel Ports Don't Work

Basic Checks for All Devices:

- Make sure that the device's cable is firmly connected to its connector on the computer.



If you are having a problem with a printer, see "[Printer Attached to Parallel Port Doesn't Work.](#)"

If a system error message indicates a port problem or if equipment connected to a port seems to perform incorrectly or not at all, the source of the problem may be any of the following:

- A faulty connection between the I/O port and the device
- Incorrect settings for system setup options
- Incorrect settings in the operating system's configuration files
- A faulty cable between the I/O port and the device
- A faulty device
- Faulty I/O port logic on the system board
- Conflicting COM port settings
- Lack of drivers

- Test the electrical outlet. Verify that the device is connected to a working electrical outlet. Verify that the device is on.

#### Basic Checks for Serial Port Device:

1. Exit any open application programs, and then turn off the computer and the serial device.
2. Swap the device's cable with a known working cable.
3. Turn on the computer and the serial device.

Is the problem resolved?

**Yes.** You probably need a new device cable. [Call Dell](#) for technical assistance.

**No.** Go to step 4.

4. Turn off the computer and the serial device and swap the device with a comparable working device.

For example, if your serial mouse has a problem, swap it with a serial mouse you know is working properly.

5. Turn on the computer and the serial device.

Is the problem resolved?

**Yes.** You probably need a new device. Call Dell for technical assistance.

**No.** Call Dell for technical assistance.

#### Checking the Serial or Parallel Port on the Computer:

Fill out the [Diagnostics Checklist](#) as you perform the following steps:

1. Check the settings for the Serial Port and Parallel Mode options in the [system setup program](#).

Are the communication port options set correctly for the devices connected to the computer?

**Yes.** Go to step 3.

**No.** Go to step 2.

2. Change the Serial Port and Parallel Mode options to the appropriate settings, and then reboot the system.

Is the problem resolved?

**Yes.** The problem is resolved.

**No.** Go to step 3.

3. Check the contents of your initialization and start-up files. (See "[Software Solutions](#)")

Are the port configuration commands correct?

**Yes.** Go to step 5.

**No.** Go to step 4.

4. Change the necessary statements in the start-up files.

If the port problem is confined to a particular application program, see the application program's documentation for specific port configuration requirements.

Is the problem resolved?

**Yes.** The problem is resolved.

**No.** Go to step 5.

5. Insert your *ResourceCD* into the CD-ROM drive, reboot the computer, and run the Serial Ports device group and/or the Parallel Ports device group in the [Dell Diagnostics](#).

The Serial Ports device group and the Parallel Ports device group check the basic functions of the system board's I/O port logic. Also, if a parallel printer is connected to the parallel port, the Parallel Ports device group tests the communication link between the system board's I/O port logic and the printer.

Do the tests complete successfully?

**Yes.** The problem is with the serial device. Run the basic checks for the serial device. If you have completed the basic checks and the problem persists, [call Dell](#).

**No.** [Call Dell](#) for technical assistance.

Parallel Port  
Printer Doesn't  
Work

Basic Checks:

- Verify the printer cable connections. Ensure that the printer cable is properly connected to the computer.
- Test the electrical outlet. Verify that the printer is connected to a working electrical outlet. Ensure that the printer is turned on.

Fill out the [Diagnostics Checklist](#) as you perform the following steps:

1. Turn off the printer and computer.
2. Swap the printer's cable with a known working cable.
3. Turn on the printer and computer.
4. Try to print.

Does the print operation complete successfully?

**Yes.** You probably need a new printer cable. Call Dell for technical assistance.

**No.** Go to step 5.

5. Run the printer's self-test.

Does the self-test complete successfully?

**Yes.** Go to step 6.

**No.** The printer is probably defective. If you bought the printer from Dell, call Dell for technical assistance. If you purchased the printer elsewhere, take it to one of the manufacturer's authorized service centers for repair.

6. Try to print again.

Does the print operation complete successfully?

**Yes.** The problem is resolved.

**No.** [Call Dell](#) for technical assistance.

## Software Solutions



Software usually includes installation instructions in its accompanying documentation and a software setup program (usually called setup.exe or install.exe) on a diskette or CD.

Error messages can be produced by an application program, the operating system, or the computer. "[Understanding Error Messages](#)," discusses the error messages generated by the computer. If you receive an error message not listed, check the operating system or application program documentation.

## Basic Checks

- Ensure that you properly installed and configured the application program. Reinstall the program if necessary.
- Verify that the program's drivers do not conflict with certain application programs. See "[Avoiding Interrupt Assignment Conflicts](#)."
- Confirm that a problem is software-related by running the System Board Devices tests as described in "[Dell Diagnostics](#)." If all tests in the device group run successfully, the error condition may be related to a software problem.
- For detailed troubleshooting information on a particular application program, see the software documentation or contact the software manufacturer.

### Before installing software:

- Ensure that the application program is compatible with the operating system installed in your computer and that your computer meets the minimum hardware requirements needed to run the software.
- Use a virus-scanning application program to check the diskettes or CDs for viruses.

[Back to Contents Page](#)



# Dell™ Diagnostics: Dell Latitude™ C600/C500 User's Guide

[When to Use the Dell Diagnostics](#)

[Advanced Testing](#)

[Features of the Dell Diagnostics](#)

[Confirming the System Configuration Information](#)

[Starting the Dell Diagnostics](#)

---

## When to Use the Dell Diagnostics

Whenever a major component or device in your computer does not function properly, you may have a component failure. If you are experiencing a problem with your computer, Dell recommends that you perform the checks in "[Finding Solutions](#)" and run the Dell Diagnostics *before* you call Dell for technical assistance.

As long as the microprocessor and the input and output components of your computer (the display, keyboard, and diskette drive) are working, you can use the Dell Diagnostics. Running the Dell Diagnostics may help you to resolve the problem yourself quickly without having to contact Dell for assistance.

If you are experienced with computers and know what component(s) you need to test, simply select the appropriate diagnostic test group(s) or subtest(s). If you are unsure about how to begin diagnosing a problem, see "[Starting the Dell Diagnostics](#)" and "[Advanced Testing](#)."

---

## Features of the Dell Diagnostics

The Dell Diagnostics helps you check your computer's hardware without any additional equipment and without destroying any data. By using the diagnostics, you can have confidence in your computer's operation. And if you find a problem you cannot solve by yourself, the diagnostic tests can provide you with important information you will need when talking to Dell's service and support personnel. If you are experiencing a problem with your computer, Dell recommends that you perform the checks in "[Finding Solutions](#)" and run the Dell Diagnostics *before* you call Dell for technical assistance.

NOTICE: Use the Dell Diagnostics to test only your Dell computer. Using this program with other computers may cause incorrect computer responses or result in error messages.

The diagnostic test groups or subtests also have these helpful features:

- Options that let you perform quick checks or extensive tests on one or all devices
  - An option that allows you to choose the number of times a test group or subtest is repeated
  - The ability to display test results or to save them in a file
  - Options to temporarily suspend testing if an error is detected, or to terminate testing when an adjustable error limit is reached
  - Extensive online Help screens that describe the tests and how to run them
  - Status messages that inform you whether test groups or subtests were completed successfully
  - Error messages that appear if any problems are detected
-

## Starting the Dell Diagnostics

 **NOTE:** Dell recommends that you print these procedures before you begin.

1. Turn off the computer.
2. Undock the computer if you have it docked.
3. Turn on the computer.
4. Press <F2> at the start of the boot routine to access the system setup menu.

 **NOTE:** Write down your current boot sequence in the event you want to restore it after running the Dell Diagnostics.

5. Select the following boot sequence:
  - Boot First Device: Diskette Drive
  - Boot Second Device: CD/DVD/CD-RW Drive
  - Boot Third Device: Internal HDD
6. Insert the Dell *ResourceCD* into the CD-ROM drive.
7. Turn the computer off.
8. Turn the computer on. The computer starts and automatically begins to run the Dell Diagnostics.
9. When you have completed running diagnostics, remove the *ResourceCD* from the CD-ROM drive.

To change the boot sequence, repeat steps 1 through 6, customizing the boot sequence to fit your needs. Then restart your computer.

When you start the diagnostics, the Dell logo screen appears, followed by a message telling you that the diagnostics is loading. After the diagnostics loads, the Diagnostics Menu appears.

To select an option from this menu, highlight the option and press <Enter>, or press the key that corresponds to the highlighted letter in the option you choose (see Table 1).

Table 1. Diagnostics Menu

	Option	Function
<b>Test All Devices</b> <b>Test One Device</b> <b>Advanced Testing</b> <b>Information and Results</b> <b>Program Options</b> <b>Exit to MS-DOS</b>	Test All Devices	Performs extensive diagnostic tests or quick diagnostic tests on all devices.
	Test One Device	Performs extensive diagnostic tests or quick diagnostic tests on one device after you select it from a list of device groups. After you select Test One Device, press <F1> for more information about a test.
	Advanced Testing	Allows you to modify the parameters of a test and select a group of tests to perform. You can access online Help for more information about <a href="#">Advanced Testing</a> .
	Information	Provides test results, test errors, version numbers of the subtests used

	and Results	by the Dell Diagnostics, and additional help on the Dell Diagnostics.
	Program Options	Allows you to change the settings of the Dell Diagnostics.
	Exit to MS-DOS	Exits to the MS-DOS® prompt.

For a quick check of your computer, select Quick Tests from the Test All Devices or Test One Device option. Quick Tests runs only the subtests that do not require user interaction and that do not take a long time to run. Dell recommends that you choose Quick Tests first to increase the odds of tracing the source of the problem quickly.

For a thorough check of your computer, select Extended Tests from the Test All Devices option.

To check a particular area of your computer, select Extended Tests from the Test One Device option, or select the Advanced Testing option to customize your test(s).

## Advanced Testing

When you select Advanced Testing from the Diagnostics Menu, the following screen appears listing the diagnostic test device groups and devices of the selected device group, and it allows you to select categories from a menu (see [Figure 1](#)). Press the arrow keys or <Page Up> and <Page Down> keys to navigate the screen.

Figure 1. Advanced Testing Main Screen

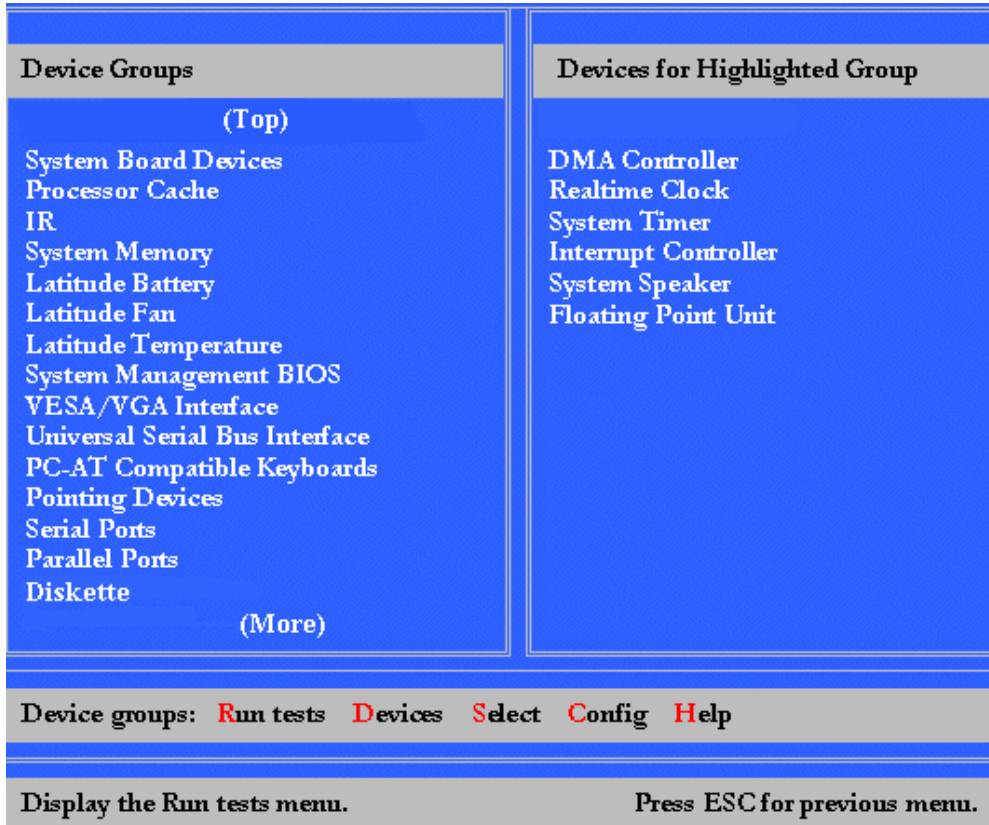

Information in the Advanced Testing screen is presented as follows:

- On the left side of the screen, the Device Groups area lists the diagnostic test groups in the order they will

run if you select All from the Run tests menu category. Press the up- or down-arrow key to highlight a test device group.

- On the right side of the screen, the Devices for Highlighted Group area lists the computer's currently detected hardware and some of the relevant settings.
- Two lines at the bottom of the screen make up the menu area (see "Advanced Testing Help Menu"). The first line lists the categories you can select; press the left- or right-arrow key to highlight a menu category. The second line gives information about the category currently highlighted.

 **NOTE:** The options displayed on your screen should reflect the hardware configuration of your computer.

## Advanced Testing Help Menu

For more information on using the Advanced Testing option:

1. Press <h>.
2. Highlight the Help category and press <Enter>, or press the key that corresponds to the highlighted letter in the category you choose (see Table 2).

Table 2. Advanced Testing Help Categories

Help Category	Description
Menu	Provides descriptions of the main menu screen area, the Device Groups, and the different diagnostic menus and commands and instructions on how to use them.
Keys	Explains the functions of the all of the keystrokes that can be used in Dell Diagnostics.
Device Group	Describes the test group that is presently highlighted in the Device Groups list on the main menu screen. It also provides reasoning for using some tests.
Device	Describes the function and purpose of the highlighted device in the Device Groups. For example, the following information appears when you select the Device Help category for Diskette in the Device Groups list:  <u>Diskette Drive A</u>  The diskette disk drive device reads and writes data to and from diskettes. Diskettes are flexible recording media, sometimes contained in hard shells. Diskette recording capacities are small and access times are slow relative to hard disk drives, but they provide a convenient means of storing and transferring data.
Test	Provides a thorough explanation of the test procedure of each highlighted test group subtest. An example of the Diskette subtest Diskette Drive Seek Test is as follows:  <u>Diskette Drive A - Diskette Drive Seek Test</u>  This test verifies the drive's ability to position its read/write heads. The test operates in two passes: first, seeking from the beginning to ending cylinders inclusively, and second, seeking alternately from the beginning to ending cylinders with convergence towards the middle.
Versions	Lists the version numbers of the subtests that are used by the Dell Diagnostics.

## Confirming the System Configuration Information

When you boot your computer from your *ResourceCD*, the diagnostics checks your system configuration information and displays it in the Device Groups area on the main screen.

The following sources supply this configuration information for the diagnostics:

- The system configuration information settings (stored in nonvolatile random-access memory [NVRAM]) that you selected while using the system setup program
- Identification tests of the microprocessor, the video controller, the keyboard controller, and other key components
- Basic input/output system (BIOS) configuration information temporarily saved in RAM

Do not be concerned if the Device Groups area does not list the names of all the components or devices you know are part of your computer. For example, you may not see a printer listed, although you know one is attached to your computer. Instead, the printer is listed as a parallel port. The computer recognizes the parallel port as LPT1, which is an address that tells the computer where to send outgoing information and where to look for incoming information. Because your printer is a parallel communications device, the computer recognizes the printer by its LPT1 address and identifies it as a parallel port. You can test your printer connection in the Parallel Ports tests.

---

[Back to Contents Page](#)

# Understanding Error Messages: Dell™ Latitude™ C600/C500 User's Guide

 [Error Messages](#)

 [Avoiding Interrupt Assignment Conflicts](#)

## Error Messages

Your application programs, operating system, and the computer itself can identify problems and alert you to them. When this occurs, a message may appear on the computer's display or on an external monitor (if one is attached), or a flash code may be emitted.

If an error message appears on the display or external monitor, make a note of the message. For an explanation of the message and suggestions for correcting any errors, see [Table 1](#). The messages are listed alphabetically.



*NOTE: If the message is not listed in Table 1, see the documentation for the application program that was running at the time the message appeared and/or the operating system documentation for an explanation of the message and a recommended action.*

Table 1. System Error Messages

Message	Cause	Action
Auxiliary device failure	The touch pad, track stick, or external PS/2 mouse may be faulty.	If you are using an external mouse only, check the connection for a loose or improperly connected cable. If the problem persists, enable the Pointing Device option. If the problem persists, <a href="#">call Dell</a> for technical assistance.
Bad command or file name	The command you entered does not exist or is not in the pathname you specified.	Make sure that you have typed the command correctly, placed spaces in the proper location, and used the correct pathname.
Cache disabled due to failure	The primary cache internal to the microprocessor has failed.	<a href="#">Call Dell</a> for technical assistance.
CD-ROM drive controller failure 1	The CD-ROM drive does not respond to commands from the computer.	Turn off the computer, remove the drive, and boot the computer from a bootable diskette. Then turn off the computer again, reinstall the drive, and reboot the computer. If the problem persists, try another drive. Then run the CD-ROM Drive tests in the <a href="#">Dell Diagnostics</a> .
Data error	The diskette or hard-disk drive	Run the appropriate utility to check the file

	cannot read the data.	structure of the diskette drive or hard-disk drive. See the documentation that came with your operating system.
Decreasing available memory	One or more memory modules may be faulty or improperly seated.	Reseat the <a href="#">memory modules</a> and, if necessary, replace them.
Disk C: failed initialization	The hard-disk drive failed initialization.	Run the Hard-Disk Drive tests in the <a href="#">Dell Diagnostics</a> .
Diskette drive 0 seek failure	A cable may be loose, or the system configuration information may not match the hardware configuration.	Run the Diskette Drive tests in the <a href="#">Dell Diagnostics</a> . If error is not corrected, have the cables checked by an authorized service technician.
Diskette read failure	A cable may be loose, or the diskette may be faulty.	If the diskette-drive access light lights up, try a different diskette.
Diskette subsystem reset failed	The diskette drive controller may be faulty.	Run the Diskette Drive tests in the <a href="#">Dell Diagnostics</a> .
Diskette write-protected	Because the diskette is write-protected, the operation cannot be completed.	Slide the write-protect notch up.
Drive not ready	No diskette is in the diskette drive, or no hard-disk drive is in the drive bay. The operation requires a diskette in the drive or a hard-disk drive in the bay before it can continue.	Put a diskette in the drive, or push the diskette all the way into the drive until the eject button pops out. Or, install a hard-disk drive in the drive bay.
Error reading PCMCIA card	The computer cannot identify the PC Card.	Reseat the card or try another PC Card that you know works.
Extended memory size has changed	The amount of memory recorded in NVRAM does not match the memory installed in the computer.	Reboot the computer. If the error appears on the display again, <a href="#">call Dell</a> for technical assistance.
Gate A20 failure	An installed memory module may be loose.	Reseat the <a href="#">memory modules</a> and, if necessary, replace them.
General failure	The operating system is unable to carry out the command.	This message is usually followed by specific information—for example, Printer out of paper. Respond by taking the appropriate action.
Hard-disk drive configuration error	The computer cannot identify the drive type.	Turn off the computer, remove the drive, and boot the computer from a bootable diskette. Then turn off the computer, reinstall the drive, and reboot the computer. Run the Hard-Disk Drive tests in

		the <a href="#">Dell Diagnostics</a> .
Hard-disk drive controller failure	The hard-disk drive does not respond to commands from the computer.	Turn off the computer, remove the drive, and boot the computer from a bootable diskette. Then turn off the computer again, reinstall the drive, and reboot the computer. If the problem persists, try another drive. Then run the Hard-Disk Drive tests in the <a href="#">Dell Diagnostics</a> .
Hard-disk drive failure	The hard-disk drive does not respond to commands from the computer.	Turn off the computer, remove the drive, and boot the computer from a bootable diskette. Then turn off the computer again, reinstall the drive, and reboot the computer. If the problem persists, try another drive. Then run the Hard-Disk Drive tests in the <a href="#">Dell Diagnostics</a>
Hard-disk drive read failure	The hard-disk drive may be faulty.	Turn off the computer, remove the drive, and boot the computer from a bootable diskette. Then turn off the computer again, reinstall the drive, and reboot the computer. If the problem persists, try another drive. Then run the Hard-Disk Drive tests in the <a href="#">Dell Diagnostics</a>
Invalid configuration information-please run System Setup Program	The system configuration information does not match the hardware configuration. This message is most likely to occur after a memory module is installed.	Correct the appropriate options in the <a href="#">system setup</a> program.
Keyboard clock line failure	A cable or connector may be loose, or the keyboard may be faulty.	Run the Keyboard Controller test in the <a href="#">Dell Diagnostics</a> .
Keyboard controller failure	A cable or connector may be loose, or the keyboard may be faulty.	Reboot the computer, and avoid touching the keyboard or the mouse during the boot routine. If the problem persists, run the Keyboard Controller test in the <a href="#">Dell Diagnostics</a> .
Keyboard data line failure	A cable or connector may be loose, or the keyboard may be faulty.	Run the Keyboard Controller test in the <a href="#">Dell Diagnostics</a> .
Keyboard stuck key failure	If an external keyboard or keypad is being used, a cable or connector may be loose or the keyboard may be faulty. If the integrated keyboard is being used, the keyboard may be faulty. A key on the integrated keyboard or external keyboard may have been pressed while the computer	Run the Stuck Key test in the <a href="#">Dell Diagnostics</a> .



	was booting.	
Memory address line failure at address, read value expecting value	An installed memory module may be faulty or improperly seated.	Reseat the <a href="#">memory modules</a> and, if necessary, replace them.
Memory allocation error	The software you are attempting to run is conflicting with the operating system, another application program, or a utility.	Turn off the computer, wait 30 seconds, and then restart it. Try to run the program again. If the problem persists, contact the software company.
Memory data line failure at address, read value expecting value	An installed memory module may be faulty or improperly seated.	Reseat the <a href="#">memory modules</a> and, if necessary, replace them.
Memory double word logic failure at address, read value expecting value	An installed memory module may be faulty or improperly seated.	Reseat the <a href="#">memory modules</a> and, if necessary, replace them.
Memory odd/even logic failure at address, read value expecting value	An installed memory module may be faulty or improperly seated.	Reseat the <a href="#">memory modules</a> and, if necessary, replace them.
Memory write/read failure at address, read value expecting value	An installed memory module may be faulty or improperly seated.	Reseat the <a href="#">memory modules</a> and, if necessary, replace them.
No boot device available	The computer cannot find the diskette or hard-disk drive.	If the diskette drive is your boot device, make sure that there is a bootable diskette in the drive. If the hard-disk drive is your boot device, make sure that the drive is installed, properly seated, and partitioned as a boot device.
No boot sector on hard-disk	The operating system may be corrupted.	Reinstall your operating system. See the documentation that came with your operating system.

drive		
No timer tick interrupt	A chip on the system board may be malfunctioning.	Run the System Set tests in the <a href="#">Dell Diagnostics</a> .
Non-system disk or disk error	The diskette in drive A or your hard-disk drive does not have a bootable operating system installed on it.	If you are trying to boot from the diskette, replace it with one that has a bootable operating system.
Not a boot diskette	There is no operating system on the diskette.	Boot the computer with a diskette that contains an operating system.
Optional ROM bad checksum	The optional ROM apparently failed.	<a href="#">Call Dell</a> for technical assistance.
Sector not found	The operating system cannot locate a sector on the diskette or hard-disk drive. You probably have a bad sector or corrupted FAT on the diskette or hard-disk drive.	Run the appropriate utility to check the file structure on the diskette or hard-disk drive. If a large number of sectors are defective, back up the data (if possible), and then reformat the diskette or hard-disk drive.
Seek error	The operating system cannot find a specific track on the diskette or hard-disk drive.	If the error is on the diskette drive, try another diskette in the drive.
Shutdown failure	A chip on the system board may be malfunctioning.	Run the System Set tests in the <a href="#">Dell Diagnostics</a> .
Time-of-day clock lost power	Data stored in NVRAM has become corrupted.	Connect your computer to an electrical outlet to charge the battery. If the problem persists, try to restore the data. To restore the data, press <Fn><F1> to <a href="#">enter the system setup program</a> . Then immediately exit it. If the message reappears, <a href="#">call Dell</a> for technical assistance.
Time-of-day clock stopped	The reserve battery that supports the data stored in NVRAM may be read.	Connect your computer to an electrical outlet to charge the battery. If the problem persists, <a href="#">call Dell</a> for technical assistance.
Time-of-day not set-please run the System Setup program	The time or date stored in the system setup program does not watch the system clock.	Correct the settings for the Date and Time options. (For instructions, see " <a href="#">System Setup Program</a> .")
Timer chip counter 2 failed	A chip on the system board may be malfunctioning.	Run the System Set tests in the <a href="#">Dell Diagnostics</a> .
Unexpected interrupt in protected mode	The keyboard controller may be malfunctioning, or an installed memory module may be loose.	Run the System Memory tests and the Keyboard Controller test in the <a href="#">Dell Diagnostics</a> .

Warning:  
Battery is  
critically  
low.

The battery is running out of  
charge.

Replace the [battery](#), or connect the computer to  
an electrical outlet. Otherwise, activate [suspend-  
to-disk](#) mode or turn off the computer.

## Avoiding Interrupt Assignment Conflicts

Problems can arise if two devices attempt to use the same interrupt request (IRQ) line. To avoid this type of conflict, check the documentation for the default IRQ line setting for each installed device. Then consult [Table 2](#) to configure the device for one of the available IRQ lines.



*NOTES: Installed devices cannot share the same COM port address. The default address of your computer's serial port is COM1.*

*For information about IRQ assignments, refer to your Windows operating system documentation.*

Table 2. IRQ Line Assignments

IRQ Line	Reserved/ <b>Available</b>
IRQ0	Reserved; used by the system timer
IRQ1	Reserved; used by the keyboard controller to signal that the keyboard output buffer is full
IRQ2	Reserved; used internally by the interrupt controller to enable IRQ8 through IRQ15
IRQ3	For a <i>PC Card</i> unless the integrated serial port or infrared port is configured for COM2 or COM4
IRQ4	For a <i>PC Card</i> unless the integrated serial port or infrared port is configured for COM1 (the default) or COM3
IRQ5	For the <i>audio controller</i>
IRQ6	Reserved; used by the diskette drive controller
IRQ7	For a <i>PC Card</i> or <i>audio controller</i> if the parallel port is disabled
IRQ8	Reserved; used by the system I/O controller's real-time clock
IRQ9	Reserved; used by the video controller
IRQ10	For a <i>PC Card</i> or <i>audio controller</i> unless a docking station or port replicator is attached
IRQ11	For a <i>PC Card</i> ; used by USB, PC Card, and audio controllers
IRQ12	Reserved; used by the keyboard controller to indicate that the output buffer of the DualPoint integrated pointing device or the external PS/2 mouse is full
IRQ13	Reserved; used by the math coprocessor
IRQ14	Reserved; used by the hard-disk drive to indicate that the drive requires the attention of the

	microprocessor
IRQ15	Reserved; used by CD-ROM drive in the modular bay to indicate that the drive requires the attention of the microprocessor

[Back to Contents Page](#)

[Back to Contents Page](#)

# Getting Help: Dell™ Latitude™ C600/C500 User's Guide

 [Help Overview](#)

 [Contacting Dell](#)

---

[Back to Contents Page](#)

# Technical Specifications: Dell™ Latitude™ C600/C500 User's Guide

[Processor](#)

[PC Cards](#)

[Memory](#)

[Connectors](#)

[Audio](#)

[Video](#)

[Display](#)

[Keyboard](#)

[Battery](#)

[AC Adapter](#)

[Physical](#)

[Environmental \(Computer\)](#)

[Touch Pad](#)

[Track Stick](#)

[Modem](#)

[Supported CD/DVD Formats](#)

---

## Processor

C600 microprocessor	Intel® Mobile Pentium® III microprocessor with Intel SpeedStep™ technology
C500 microprocessor	Intel Celeron™ microprocessor
System chip set	Intel Mobile 440BX AGPset
L2 cache for C600	256 KB
L2 cache for C500	128 KB
External bus	100 MHz front side bus
Microprocessor data bus width	64 bits
DRAM bus width	64 bits
Address bus width	32 bits
Flash EPROM	4 Mb
AGP bus	66 MHz
PCI bus	33 MHz

---

## PC Cards

CardBus controller	Texas Instruments PCI 1420 CardBus controller
PC Card connectors	two Type II cards in any combination; one Type III card used only in the lower connector
	The lower connector supports zoomed video (ZV) cards on computers running the Microsoft® Windows® 95 or Windows 98 operating system. The Microsoft Windows NT 4.0 operating system does not support ZV.
Cards supported	3.3-V and 5-V <ul style="list-style-type: none"> <li>• Type II and Type III PC Cards (including memory cards)</li> <li>• ATA cards that emulate IDE hard-disk drives</li> <li>• I/O cards such as modems, LAN cards, wireless LAN cards, and SCSI cards</li> </ul>
PC Card connector size	68 pins
Data width (maximum):	
PCMCIA	16 bits
CardBus	32 bits

## Memory

Architecture	SDRAM
Memory module sockets	two user accessible SODIMM sockets
Memory module capacities and type	64-, 128-, and 256-MB 3.3-V SDRAM SODIMMS <a href="#">1</a>
Standard RAM	64-MB memory module
Maximum RAM	512 MB
Memory clock speed	100 MHz
Memory access time	CL2 or CL3 (Note: CL3 indicates a CAS latency of 3 clocks)
BIOS address	F000:0000-F000:FFFF

## Connectors

Serial (DTE)	16,550-compatible, 16-byte buffer connector
Parallel	unidirectional, bidirectional, or ECP connector

Video	VGA connector
PS/2	mini-DIN connector
Infrared	port compatible with both IrDA Standard 1.1 (Fast IR) and IrDA Standard 1.0 (Slow IR)
Audio	microphone jack; headphones/speakers jack
USB	USB-compliant connector
Docking	connector for the C/Port Family Advanced Port Replicator or C/Dock Family Expansion Station
S-Video	7-pin mini-DIN connector (an S-Video to composite video Adapter is also included with the computer)
Mini-PCI	Type IIIA mini-PCI card slot
Modem	Optional factory-configurable RJ11 port for mini-PCI modem
Modem/Ethernet LAN	Optional factory-configurable RJ11/RJ45 combination port for mini-PCI modem/NIC

---

## Audio

Audio type	Sound Blaster (software emulation-capable)
Audio controller	ESS Maestro 3I
Stereo conversion	16 bit (analog-to-digital and digital-to-analog)
Interfaces:	
Internal	PCI bus/AC97
External	microphone-in minijack; headphones/speakers minijack
Speakers	two 4-ohm speakers
Internal speaker amplifier	1-W (minimum) to 1.5-W (maximum) channel into 4-ohms stereo
Controls	volume can be controlled through key combinations, application program menus, or the Speaker window in the Dell Control Center (Windows 95 only)

---

## Video

Video type	128-bit hardware-accelerated video support
Data bus	2X AGP



Video controller

ATI Mobility M3

Video memory

8.0 MB

Table 1. Display Resolution, Colors, and Refresh Rates

Resolution	Color Depth	External Monitor Available Refresh	TV as Secondary Display Available Refresh
640 x 480 (VGA)	256 (8-bit)	60, 75, 85 Hz	60 Hz NTSC, 50 Hz PAL
640 x 480 (VGA)	65 K (16-bit)	60, 75, 85 Hz	60 Hz NTSC, 50 Hz PAL
640 x 480 (VGA)	4.2 B (32-bit)	60, 75, 85 Hz	60 Hz NTSC, 50 Hz PAL
800 x 600 (SVGA)	256 (8-bit)	60, 75, 85 Hz	60 Hz NTSC, 50 Hz PAL
800 x 600 (SVGA)	65 K (16-bit)	60, 75, 85 Hz	60 Hz NTSC, 50 Hz PAL
800 x 600 (SVGA)	4.2 B (32-bit)	60, 75, 85 Hz	60 Hz NTSC, 50 Hz PAL
1024 x 768 (XGA)	256 (8-bit)	60, 70, 75, 85 Hz	60 Hz NTSC, 50 Hz PAL
1024 x 768 (XGA)	65 K (16-bit)	60, 70, 75, 85 Hz	60 Hz NTSC, 50 Hz PAL
1024 x 768 (XGA)	4.2 B (32-bit)	60, 70, 75, 85 Hz	60 Hz NTSC, 50 Hz PAL
1280 x 1024 (SXGA)	256 (8-bit)	60, 70, 75, 85 Hz	60 Hz NTSC, 50 Hz PAL
1280 x 1024 (SXGA)	65 K (16-bit)	60, 70, 75, 85 Hz	60 Hz NTSC, 50 Hz PAL
1280 x 1024 (SXGA)	4.2 B (32-bit)	60, 70, 75, 85 Hz	60 Hz NTSC, 50 Hz PAL
1400 x 1050 (SXGA+)	256 (8-bit)	60, 70, 75, 85 Hz	60 Hz NTSC, 50 Hz PAL
1400 x 1050 (SXGA+)	65 K (16-bit)	60, 70, 75, 85 Hz	60 Hz NTSC, 50 Hz PAL
1400 x 1050 (SXGA+)	4.2 B (32-bit)	60, 70, 75, 85 Hz	60 Hz NTSC, 50 Hz PAL
1600 x 1200 (UGA)	256 (8-bit)	60 Hz, 85 Hz	60 Hz NTSC, 50 Hz PAL
1600 x 1200 (UGA)	65 K (16-bit)	60 Hz, 85 Hz	60 Hz NTSC, 50 Hz PAL
1600 x 1200 (UGA)	4.2 B (32-bit)	60 Hz, 85 Hz	60 Hz NTSC, 50 Hz PAL

**NOTE: Color depth is based on 256 colors for 8-bit, 65,536 colors for 16-bit, and 4,294,967,296 colors for 32-bit displays.**

Table 2. Display Resolution and Color Depth Without DVD and 3D Running

	Maximum Color Depth Possible (in bits)
--	--

Primary/Secondary	640 x 480	800 x 600	1024 x 768	1280 x 1024	1400 x 1050	1600 x 1200
640 x 480 (8 bit)	32	32	32	32	32	32
800 x 600 (8 bit)	32	32	32	32	32	32
1024 x 768 (8 bit)	32	32	32	32	32	32
1280 x 1024 (8 bit)	32	32	32	32	32	32
1400 x 1050 (8 bit)	32	32	32	32	32	32
1600 x 1200 (8 bit)	32	32	32	32	32	32
640 x 480 (16 bit)	32	32	32	32	32	32
800 x 600 (16 bit)	32	32	32	32	32	32
1024 x 768 (16 bit)	32	32	32	32	32	32
1280 x 1024 (16 bit)	32	32	32	32	16	16
1400 x 1050 (16 bit)	32	32	32	32	16	16
1600 x 1200 (16 bit)	32	32	16	16	16	16
640 x 480 (32 bit)	32	32	32	32	32	16
800 x 600 (32 bit)	32	32	32	32	32	16
1024 x 768 (32 bit)	32	32	32	24	16	16
1280 x 1024 (32 bit)	32	32	24	16	16	8
1400 x 1050 (32 bit)	32	32	16	8	8	8
1600 x 1200 (32 bit)	8	8	--	--	--	--

## Display

Type for C600 computers

14.1-inch XGA, active-matrix color (TFT);  
14.1-inch SXGA+ active-matrix color (TFT)

Type for C500 computers

14.1-inch XGA, active-matrix color (TFT);  
12.1-inch SVGA active-matrix color (TFT)

Dimensions (active area):

Height 214.3 mm (8.4 inches)

Width 285.7 mm (11.3 inches)

Diagonal 357.1 mm (14.1 inches)

Maximum resolution/colors	1024 x 768/16-bit color (XGA); 1400 x 1050/16-bit color (SXGA+); 800 x 600/16-bit color (SVGA)
Response time (typical)	50.0 ms (20 ms rise, 30 ms fall)
Operating angle	0° (closed) to 180°
Viewing angles:	
Horizontal	± 40°
Vertical	+15°/–30°
Dot pitch	0.28 mm (14.1-inch XGA); 0.20 mm (14.1-inch SXGA+); 0.31 mm (12.1-inch SVGA)
Power consumption:	
Panel (typical)	1.0 W (XGA); 1.3 W (SXGA+)
Backlight	3.4 W (XGA); 3.4 W using battery, 4.9 W using AC adapter (SXGA+)
Controls	brightness can be controlled through a key combination

---

## Keyboard

Number of keys	87 (U.S., Canada, Korea, Thailand, and locations that use traditional Chinese); 88 (Europe); 90 (Japan)
Key travel	2.7 mm + 0.3 mm/– 0.4 mm (0.11 inch ± 0.016 inch)
Key spacing	19.05 mm ± 0.3 mm (0.75 inch ± 0.012 inch)

---

## Battery

Type	4-cell or 8-cell lithium ion (dual battery support is available via the modular bay)
Dimensions:	
Height	21.5 mm (0.83 inch)
Depth	88.5 mm (3.48 inches)

Width	139.0 mm (5.47 inches)
Weight	8-cell: 0.39 kg (0.87 lb) 4-cell: 0.22 kg (0.49 lb)
Voltage	14.8 VDC
Capacity	8-cell: 59.0 WH 4-cell: 26.5 WH
Charge time (approximate) <sup>2</sup> :	
Computer on	2.5 hours
Computer off	1 hour
Battery life	3 hours minimum with 8-cell standard battery; 1-2 hours minimum with 4-cell optional battery
Life span (approximate) <sup>2</sup>	400 discharge/charge cycles
Temperature range:	
Operating	0° to 45°C (32° to 113°F)
Storage	-20° to 60°C (-4° to 140°F)

---

## AC Adapter

Input voltage	90 to 135 VAC and 164 to 264 VAC
Input current (maximum)	1.5 A
Input frequency	47 to 63 Hz
Output current	4.5 A (maximum at 4-second pulse); 3.51 A (continuous)
Rated output voltage	20.0 VDC
Height	27.94 mm (1.1 inches)
Width	58.42 mm (2.3 inches)
Depth	133.35 mm (5.25 inches)
Weight (with cables)	0.4 kg (0.9 lb)
Temperature range:	

Operating	0° to 40°C (32° to 104°F)
Storage	−40° to 65°C (−40° to 149°F)

---

## Physical

Height	38.7 mm (1.52 inches)
Width	319.5 mm (12.58 inches)
Depth	253.6 mm (9.98 inches)

### Weight <sup>3</sup>

14.1-inch XGA or SXGA+ with 4-cell battery	2.2 kg (4.9 lb) with travel module installed in modular bay 2.4 kg (5.4 lb) with standard diskette drive installed in modular bay 2.5 kg (5.7 lb) with CD-ROM drive installed in modular bay
14.1-inch XGA or SXGA+ with 8-cell battery	2.4 kg (5.3 lb) with travel module installed in modular bay 2.5 kg (5.7 lb) with standard diskette drive installed in modular bay 2.7 kg (6.0 lb) with CD-ROM drive installed in modular bay
12.1-inch SVGA with 4-cell battery	2.2 kg (4.8 lb) with travel module installed in modular bay 2.4 kg (5.3 lb) with standard diskette drive installed in modular bay 2.5 kg (5.5 lb) with CD-ROM drive installed in modular bay
12.1-inch SVGA with 8-cell battery	2.4 kg (5.3 lb) with travel module installed in modular bay 2.5 kg (5.5 lb) with standard diskette drive installed in modular bay 2.7 kg (5.9 lb) with CD-ROM drive installed in modular bay

---

## Environmental (Computer)

### Temperature:

Operating	0° to 35°C (32° to 95°F)
Storage	−40° to 65°C (−40° to 149°F)

### Relative humidity (maximum):

Operating	10% to 90% (noncondensing)
Storage	5% to 95% (noncondensing)

### Maximum vibration:

Operating	0.9 GRMS using a random-vibration spectrum that simulates user environment
Storage	1.3 GRMS using a random-vibration spectrum that simulates air/truck shipment
Maximum shock <sup>4</sup> :	
Operating	152.4 cm/sec (60.0 inches/sec) (equal to a half-sine pulse width of 2 ms)
Storage	203.2 cm/sec (80 inches/sec) (equal to a half-sine pulse width of 2 ms)
Altitude (maximum):	
Operating	-15.2 m to 3048 m (-50 to 10,000 ft)
Storage	-15.2 m to 10,668 m (-50 to 35,000 ft)

---

## Touch Pad

Interface	PS/2-compatible
X/Y position resolution (graphics table mode)	240 cpi
Size:	
Thickness	2.00 mm (0.08 inch) at highest component
Width (sensor-active area)	64.88 mm (2.55 inch)
Height	48.88 mm (1.92 inch) rectangle
Weight	6.5 g (0.23 oz)
Power:	
Supply voltage	5 V ± .5 VDC
Supply current	25 mA (maximum operating for track stick and touch pad combined)
ESD	In accordance with IEC-801-2

---

## Track Stick

Interface	PS/2-compatible
X/Y position resolution	250 counts/sec.@100gf
Size:	Protrudes .5 mm higher than surrounding keycaps
Power:	
Supply voltage	5 V ± .5 VDC
Supply current	25 mA (maximum operating for track stick and touch pad combined)
ESD	In accordance with IEC-801-2

---

## Modem

Data/Fax Modem	Optional 3Com® 56K, V.90 Mini PCI Modem 556B. For more information, see the <a href="#">online documentation</a> for the modem.
Data/Fax and NIC Combination Modem	Optional 3Com 10/100 LAN + 56K, V.90 Mini PCI Modem. For more information, see the <a href="#">online documentation</a> for the modem.

---

## Supported CD/DVD Formats

- CD-ROM red-book audio discs (CD-DA)
- CD-ROM yellow-book mode-1 and mode-2 data discs
- CD-ROM XA (mode-2 form 1 and form 2; without Adaptive Differential Pulse Code modulation [ADPCM])
- CD-I (mode-2 form 1 and form 2)
- CD-I Ready
- CD-Bridge
- Photo CD, CD-recordable (CD-R) (single and multisession)
- Video CD
- CD-rewritable (CD-RW) (only the CD-RW drives can write to this type of disc; the CD-ROM and DVD-ROM drives can read, but not write to, CD-RWs)
- DVD-5 (the DVD-ROM drive supports the DVD-5 format)

---

**NOTES:**

<sup>1</sup> *Your computer does not support some memory modules from older models of Dell portable computers, such as the Latitude CP, XP, XPi CD, or LM. It only supports SDRAM modules and does not support EDO memory modules.*

<sup>2</sup> *Battery performance features such as charge time and life span can vary according to the conditions under which the computer and battery are used.*

<sup>3</sup> *Weights are shown with a hard-disk drive, a battery in the battery bay, and a travel module, diskette drive, or a CD-ROM drive in the modular bay. Your computer might weigh more or less, depending on its configuration.*

<sup>4</sup> *Measured with the hard-disk drive in head-parked position.*

---

[Back to Contents Page](#)



# Regulatory Notices: Dell™ Latitude™ C600/C500 User's Guide

- [Overview](#)
  - [FCC Notices \(U.S. Only\)](#)
  - [IC Notice \(Canada Only\)](#)
  - [CE Notice \(European Union\)](#)
  - [Battery Disposal](#)
  - [EN 55022 Compliance \(Czech Republic Only\)](#)
  - [VCCI Notice \(Japan Only\)](#)
  - [MIC Notice \(Republic of Korea Only\)](#)
  - [Polish Center for Testing and Certification Notice](#)
  - [Wymagania Polskiego Centrum Badan i Certyfikacji](#)
  - [Pozostale instrukcje bezpieczenstwa](#)
  - [NOM Information \(Mexico Only\)](#)
  - [Información para NOM \(únicamente para México\)](#)
  - [BSMI Notice \(Taiwan Only\)](#)
  - [CE Mark Notice](#)
  - [New Zealand Telecom Warnings](#)
- 

## Overview

Electromagnetic Interference (EMI) is any signal or emission, radiated in free space or conducted along power or signal leads, that endangers the functioning of a radio navigation or other safety service or seriously degrades, obstructs, or repeatedly interrupts a licensed radio communications service. Radio communications services include but are not limited to AM/FM commercial broadcast, television, cellular services, radar, air-traffic control, pager, and Personal Communication Services (PCS). These licensed services, along with unintentional radiators such as digital devices, including computers, contribute to the electromagnetic environment.

Electromagnetic Compatibility (EMC) is the ability of items of electronic equipment to function properly together in the electronic environment. While this computer has been designed and determined to be compliant with regulatory agency limits for EMI, there is no guarantee that interference will not occur in a particular installation. If this equipment does cause interference with radio communications services, which can be determined by turning the equipment off and on, you are encouraged to try to correct the interference by one or more of the following measures:

- Reorient the receiving antenna.
- Relocate the computer with respect to the receiver.
- Move the computer away from the receiver.
- Plug the computer into a different outlet so that the computer and the receiver are on different branch circuits.

If necessary, consult a Dell Technical Support representative or an experienced radio/television technician for additional suggestions.

Dell computers are designed, tested, and classified for their intended electromagnetic environment. These electromagnetic environment classifications generally refer to the following harmonized definitions:

- Class A is typically for business or industrial environments.
- Class B is typically for residential environments.

Information Technology Equipment (ITE), including peripherals, expansion cards, printers, input/output (I/O) devices, monitors, and so on, that are integrated into or connected to the computer should match the electromagnetic environment classification of the computer.

**A Notice About Shielded Signal Cables:** Use only shielded cables for connecting peripherals to any Dell device to reduce the possibility of interference with radio communications services. Using shielded cables ensures that you maintain the appropriate EMC classification for the intended environment. For parallel printers, a cable is available from Dell. If you prefer, you can order a cable from Dell on the World Wide Web at <http://accessories.us.dell.com>.

Most Dell computers are classified for Class B environments. However, the inclusion of certain options can change the rating of some configurations to Class A. To determine the electromagnetic classification for your computer or device, refer to the following sections specific for each regulatory agency. Each section provides country-specific EMC/EMI or product safety information.

---

## FCC Notices (U.S. Only)

Most Dell computers are classified by the Federal Communications Commission (FCC) as Class B digital devices. To determine which classification applies to your computer, examine all FCC registration labels located on the bottom or back panel of your computer, on card-mounting brackets, and on the cards themselves. If any one of the labels carries a Class A rating, your entire computer is considered to be a Class A digital device. If *all* labels carry an FCC Class B rating as distinguished by either an FCC ID number or the FCC logo (FCC), your computer is considered to be a Class B digital device.

Once you have determined your computer's FCC classification, read the appropriate FCC notice. Note that FCC regulations provide that changes or modifications not expressly approved by Dell could void your authority to operate this equipment.

This device complies with Part 15 of the FCC Rules. Operation is subject to the following two conditions:

- This device may not cause harmful interference.
- This device must accept any interference received, including interference that may cause undesired operation.

### Class A

This equipment has been tested and found to comply with the limits for a Class A digital device pursuant to Part 15 of the FCC Rules. These limits are designed to provide reasonable protection against harmful interference when the equipment is operated in a commercial environment. This equipment generates, uses,

and can radiate radio frequency energy and, if not installed and used in accordance with the manufacturer's instruction manual, may cause harmful interference with radio communications. Operation of this equipment in a residential area is likely to cause harmful interference, in which case you will be required to correct the interference at your own expense.

## Class B

This equipment has been tested and found to comply with the limits for a Class B digital device pursuant to Part 15 of the FCC Rules. These limits are designed to provide reasonable protection against harmful interference in a residential installation. This equipment generates, uses, and can radiate radio frequency energy and, if not installed and used in accordance with the manufacturer's instruction manual, may cause interference with radio communications. However, there is no guarantee that interference will not occur in a particular installation. If this equipment does cause harmful interference to radio or television reception, which can be determined by turning the equipment off and on, you are encouraged to try to correct the interference by one or more of the following measures:

- Reorient or relocate the receiving antenna.
- Increase the separation between the equipment and the receiver.
- Connect the equipment into an outlet on a circuit different from that to which the receiver is connected.
- Consult the dealer or an experienced radio/television technician for help.

The following information is provided on the device or devices covered in this document in compliance with FCC regulations:

- Model number: PP01L
- Company name:

Dell Computer Corporation  
One Dell Way  
Round Rock, Texas 78682 USA

## Modem Regulatory Information

This equipment complies with Part 68 of the FCC rules. On the bottom of your computer is a label that contains, among other information, the FCC registration number and ringer equivalence number (REN) for your equipment. If requested, you must provide this information to the telephone company.

The REN is used to determine the quantity of devices that may be connected to the telephone line. Excessive RENs on the telephone line may result in the devices not ringing in response to an incoming call. In most areas, the sum of all the RENs on your telephone line should be less than five to ensure proper service from the telephone company. To be certain of the number of devices that you may connect to a line, as determined by the total RENs, contact your local telephone company.

The registration jack Universal Service Order Code (USOC) used by this equipment is RJ-11C. An FCC compliant telephone cord and modular plug is provided with this equipment. This equipment is designed to be connected to the telephone network or premises wiring using a compatible modular jack that is Part 68 compliant.

This equipment cannot be used on public coin-phone service provided by the telephone company. Connection to party line service is subject to state tariffs.

There are no user serviceable parts on the modem contained in your computer.

If your telephone equipment causes harm to the telephone network, the telephone company will notify you in advance that service may be temporarily discontinued. If advance notice is not practical, the telephone company will notify you as soon as possible. Also, you will be advised of your right to file a complaint with the FCC if you believe it is necessary.

The telephone company may make changes in its facilities, equipment, operations, or procedures that could affect the operation of this equipment. If this happens, the telephone company will provide advance notice in order for you to make necessary modifications to maintain uninterrupted service.

If you experience trouble with this telephone equipment, see "[Getting Help](#)" to find the appropriate telephone number for obtaining customer assistance. If the equipment is causing harm to the telephone network, the telephone company may request that you disconnect the equipment until the problem is resolved.

## Fax Branding

The Telephone Consumer Protection Act of 1991 makes it unlawful for any person to use a computer or other electronic device, including fax machines, to send any message unless such message clearly contains in a margin at the top or bottom of each transmitted page or on the first page of the transmission, the date and time it is sent, identification of the business, other entity, or individual sending the message, and the telephone number of the sending machine or such business, other entity, or individual. The telephone number provided may not be a 900 number or any other number for which charges exceed local or long-distance transmission charges.

---

## IC Notice (Canada Only)

Most Dell computers (and other Dell digital apparatus) are classified by the Industry Canada (IC) Interference-Causing Equipment Standard #3 (ICES-003) as Class B digital devices. To determine which classification (Class A or B) applies to your computer (or other Dell digital apparatus), examine all registration labels located on the bottom or the back panel of your computer (or other digital apparatus). A statement in the form of "IC Class A ICES-003" or "IC Class B ICES-003" will be located on one of these labels. Note that Industry Canada regulations provide that changes or modifications not expressly approved by Dell could void your authority to operate this equipment.

This Class B (or Class A, if so indicated on the registration label) digital apparatus meets the requirements of the Canadian Interference-Causing Equipment Regulations.

Cet appareil numérique de la Classe B (ou Classe A, si ainsi indiqué sur l'étiquette d'enregistrement) respecte toutes les exigences du Règlement sur le Matériel Brouilleur du Canada.

## Modem Regulatory Information

The IC label identifies certified equipment. This certification means that the equipment meets telecommunications network protective, operational, and safety requirements as prescribed in the appropriate Terminal Equipment Technical Requirements document(s). The IC label does not guarantee that the equipment will operate to the user's satisfaction.

Before installing this equipment, users should ensure that it is permissible to be connected to the facilities of the local telecommunications company. The equipment must also be installed using an acceptable method of connection. The customer should be aware that compliance with the above conditions may not prevent degradation of service in some situations.

Repairs to certified equipment should be coordinated by a representative designated by the supplier. Any repairs or alteration made by a user to this equipment, or equipment malfunctions, may give the telephone communications company cause to request the user to disconnect the equipment.

Users should ensure for their own protection, that the electrical ground connections of the power utility, telephone lines, and internal metallic water-pipe system, if present, are connected together. This precaution may be particularly important in rural areas.

NOTICE: Users should not attempt to make such connections themselves. Contact the appropriate electric inspection authority, or electrician, as appropriate.



*NOTE: The REN assigned to each terminal device provides an indication of the maximum number of terminals allowed to be connected to a telephone interface. The termination on an interface may consist of any combination of devices subject only to the requirement that the sum of the RENs of all the devices does not exceed the number five.*

The REN for the internal modem as stated on the IC regulatory label located on the bottom of the computer is 0.6B.

The following information is provided in compliance with IC regulations:

Dell Computer Corporation  
One Dell Way  
Round Rock, TX 78682 USA

---

## CE Notice (European Union)

Marking by the symbol **CE** indicates compliance of this Dell system to the EMC Directive and the Low Voltage Directive of the European Union. Such marking is indicative that this Dell system meets the following set of technical standards:

- EN 55022 — "Limits and Methods of Measurement of Radio Interference Characteristics of Information Technology Equipment."
- EN 55024 — "Information technology equipment - Immunity characteristics - Limits and methods of measurement."
- EN 61000-3-2 — "Electromagnetic compatibility (EMC) - Part 3: Limits - Section 2: Limits for harmonic current emissions (Equipment input current up to and including 16 A per phase)."
- EN 61000-3-3 — "Electromagnetic compatibility (EMC) - Part 3: Limits - Section 3: Limitation of voltage fluctuations and flicker in low-voltage supply systems for equipment with rated current up to and including 16 A."
- EN 60950 — "Safety of Information Technology Equipment."

 NOTE: EN 55022 emissions requirements provide for two classifications:

- Class A is for typical commercial areas.
- Class B is for typical domestic areas.

RF INTERFERENCE WARNING: This is a Class A product. In a domestic environment this product may cause radio frequency (RF) interference, in which case the user may be required to take adequate measures.

This Dell device is classified for use in a typical Class B domestic environment.

A "Declaration of Conformity" in accordance with the preceding directives and standards has been made and is on file at Dell Computer Corporation Products Europe BV, Limerick, Ireland.

---



## Battery Disposal

Your computer uses an lithium ion battery and a nickel-metal hydride (NiMH) coin-cell battery. For instructions about replacing the lithium ion battery in your computer, refer to the section about replacing the battery in your Dell computer documentation. The coin-cell battery is a long-life battery, and it is very possible that you will never need to replace it. However, should you need to replace it, the procedure must be performed by an authorized service technician.

Do not dispose of these batteries along with household waste. Contact your local waste disposal agency for the address of the nearest battery deposit site.

---

## EN 55022 Compliance (Czech Republic Only)

This device belongs to Class B devices as described in EN 55022, unless it is specifically stated that it is a Class A device on the specification label. The following applies to devices in Class A of EN 55022 (radius of protection up to 30 meters). The user of the device is obliged to take all steps necessary to remove sources of interference to telecommunication or other devices.

**Pokud není na typovém štítku počítače uvedeno, že spadá do třídy A podle EN 55022, spadá automaticky do třídy B podle EN 55022. Pro zařízení zařazená do třídy A (ochranné pásmo 30m) podle EN 55022 platí následující. Dojde-li k rušení telekomunikačních nebo jiných zařízení, je uživatel povinen provést taková opatření, aby rušení odstranil.**

---

## VCCI Notice (Japan Only)

Most Dell computers are classified by the Voluntary Control Council for Interference (VCCI) as Class B information technology equipment (ITE). However, the inclusion of certain options can change the rating of some configurations to Class A. ITE, including peripherals, expansion cards, printers, input/output (I/O) devices, monitors, and so on, integrated into or connected to the computer, should match the electromagnetic environment classification (Class A or B) of the computer.

To determine which classification applies to your computer, examine the regulatory labels/markings (see [Figure 1](#) and [Figure 2](#)) located on the bottom or back panel of your computer. Once you have determined your computer's VCCI classification, read the appropriate VCCI notice.

## Class A ITE

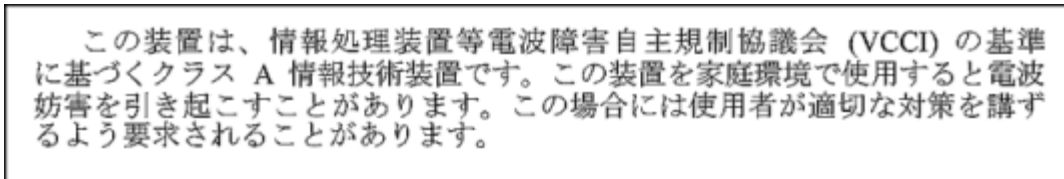

This is a Class A product based on the standard of the Voluntary Control Council for Interference (VCCI) for information technology equipment. If this equipment is used in a domestic environment, radio disturbance may arise. When such trouble occurs, the user may be required to take corrective actions.

Figure 1. VCCI Class A ITE Regulatory Mark

**VCCI-A**

## Class B ITE

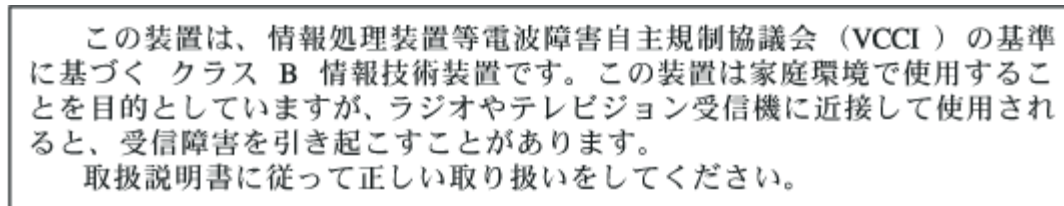

This is a Class B product based on the standard of the Voluntary Control Council for Interference (VCCI) for information technology equipment. If this equipment is used near a radio or television receiver in a domestic environment, it may cause radio interference. Install and use the equipment according to the instruction manual.

Figure 2. VCCI Class B ITE Regulatory Mark



---

## MIC Notice (Republic of Korea Only)

To determine which classification (Class A or B) applies to your computer system (or other Dell digital device), examine the Republic of Korean Ministry of Information and Communications (MIC) registration labels located on your computer (or other Dell digital device). The MIC label may be located separately from

the other regulatory marking applied to your product. Line three of the label identifies the emissions class for the product—"(A)" for Class A products or "(B)" for Class B products.

 **NOTE:** MIC emissions requirements provide for two classifications:

- Class A devices are for business purposes.
- Class B devices are for nonbusiness purposes.

### Class A Device

기종별	사용자 안내문
A급 기기 (업무용 정보통신기기)	이 기기는 업무용으로 전자파적합등록을 한 기기이오니 판매자 또는 사용자는 이 점을 주의하시기 바라며 만약 잘못 판매 또는 구입하였을 때에는 가정용으로 교환하시기 바랍니다.

Please note that this device has been approved for business purposes with regard to electromagnetic interference. If you find that this device is not suitable for your use, you may exchange it for a nonbusiness-purpose device.

### MIC Class A Regulatory Label



1. 기기의 명칭(모델명) :
2. 인증번호 :
3. 인증받은 자의 상호 : (A)
4. 제조년월일:
5. 제조자/제조국가 :

### Class B Device

기종별	사용자 안내문
B급 기기 (가정용 정보통신기기)	이 기기는 가정용으로 전자파적합등록을 한 기기로서 주거지역에서는 물론 모든 지역에서 사용할 수 있습니다.

Please note that this device has been approved for nonbusiness purposes and may be used in any environment, including residential areas.

### MIC Class B Regulatory Label





1. 기기의 명칭(모델명) :
2. 인증번호 :
3. 인증받은 자의 상호 : (B)
4. 제조년월일:
5. 제조자/제조국가 :

---

## Polish Center for Testing and Certification Notice

The equipment should draw power from a socket with an attached protection circuit (a three-prong socket). All equipment that works together (computer, monitor, printer, and so on) should have the same power supply source.

The phasing conductor of the room's electrical installation should have a reserve short-circuit protection device in the form of a fuse with a nominal value no larger than 16 amperes (A).

To completely switch off the equipment, the power supply cable must be removed from the power supply socket, which should be located near the equipment and easily accessible.

A protection mark "B" confirms that the equipment is in compliance with the protection usage requirements of standards PN-93/T-42107 and PN-EN 55022: 1996.

---

## **Wymagania Polskiego Centrum Badań i Certyfikacji**

Urządzenie powinno być zasilane z gniazda z przyłączonym obwodem ochronnym (gniazdo z kołkiem). Współpracujące ze sobą urządzenia (komputer, monitor, drukarka) powinny być zasilane z tego samego źródła.

Instalacja elektryczna pomieszczenia powinna zawierać w przewodzie fazowym rezerwową ochronę przed zwarciami, w postaci bezpiecznika o wartości znamionowej nie większej niż 16A (amperów).

W celu całkowitego wyłączenia urządzenia z sieci zasilania, należy wyjąć wtyczkę kabla zasilającego z gniazdka, które powinno znajdować się w pobliżu urządzenia i być łatwo dostępne.

Znak bezpieczeństwa "B" potwierdza zgodność urządzenia z wymaganiami bezpieczeństwa użytkowania zawartymi w PN-93/T-42107 i PN-EN 55022:1996.

Jeżeli na tabliczce znamionowej umieszczono informację, że urządzenie jest klasy A, to oznacza to, że urządzenie w środowisku mieszkalnym może powodować zakłócenia radioelektryczne. W takich przypadkach można żądać od jego użytkownika zastosowania odpowiednich środków zaradczych.

---

## **Pozostałe instrukcje bezpieczeństwa**

- Nie należy używać wtyczek adapterowych lub usuwać kołka obwodu ochronnego z wtyczki. Jeżeli konieczne jest użycie przedłużacza to należy użyć przedłużacza 3-żyłowego z prawidłowo połączonym przewodem ochronnym.
- System komputerowy należy zabezpieczyć przed nagłymi, chwilowymi wzrostami lub spadkami napięcia, używając eliminatora przepięć, urządzenia dopasowującego lub bezzakłócenowego źródła zasilania.
- Należy upewnić się, aby nic nie leżało na kablach systemu komputerowego, oraz aby kable nie były umieszczone w miejscu, gdzie można byłoby na nie nadeptywać lub potykać się o nie.
- Nie należy rozlewać napojów ani innych płynów na system komputerowy.
- Nie należy wpychać żadnych przedmiotów do otworów systemu komputerowego, gdyż może to spowodować pożar lub porażenie prądem, poprzez zwarcie elementów wewnętrznych.
- System komputerowy powinien znajdować się z dala od grzejników i źródeł ciepła. Ponadto, nie należy blokować otworów wentylacyjnych. Należy unikać kładzenia luźnych papierów pod komputer oraz umieszczania komputera w ciasnym miejscu bez możliwości cyrkulacji powietrza wokół niego.

---

## NOM Information (Mexico Only)

The following information is provided on the device(s) described in this document in compliance with the requirements of the official Mexican standards (NOM)

Exporter:	Dell Computer Corporation One Dell Way Round Rock, TX 78682
Importer:	Dell Computer de México, S.A. de C.V. Paseo de la Reforma 2620 - 11° Piso Col. Lomas Altas 11950 México, D.F.
Ship to:	Dell Computer de México, S.A. de C.V. al Cuidado de Kuehne & Nagel de México S. de R.I. Avenida Soles No. 55 Col. Peñon de los Baños 15520 México, D.F.
Supply input voltage:	100–240 VAC
Frequency:	50–60 Hz
Current consumption:	1.5 A
Output voltage:	20 VDC
Output current:	3.5 A

---

## Información para NOM (únicamente para México)

La información siguiente se proporciona en el dispositivo o en los dispositivos descritos en este documento, en cumplimiento con los requisitos de la Norma Oficial Mexicana (NOM):



此設備經測試證明符合 BSMI(經濟部標準檢驗局)之甲類數位裝置的限制規定。這些限制的目的是爲了在商業環境中使用此設備時，能提供合理的保護以防止有害的干擾。此設備會產生、使用並散發射頻能量；如果未遵照製造廠商的指導手冊來安裝和使用，可能會干擾無線電通訊。請勿在住宅區使用此設備。

**警告使用者：**

這是甲類的資訊產品，在居住的環境中使用時，可能會造成射頻干擾，在這種情況下，使用者會被要求採取某些適當的對策。

## 乙類

此設備經測試證明符合 BSMI(經濟部標準檢驗局)之乙類數位裝置的限制規定。這些限制的目的是爲了在住宅區安裝時，能防止有害的干擾，提供合理的保護。此設備會產生、使用並散發射頻能量；如果未遵照製造廠商的指導手冊來安裝和使用，可能會干擾無線電通訊。但是，這並不保證在個別的安裝中不會產生干擾。您可以透過關閉和開啓此設備來判斷它是否會對廣播和電視收訊造成干擾；如果確實如此，我們建議您嘗試以下列一種或多種方法來排除干擾：

- 重新調整天線的接收方向或重新放置接收天線。
- 增加設備與接收器的距離。
- 將設備連接至不同的插座，使設備與接收器連接在不同的電路上。
- 請向經銷商或有經驗的無線電／電視技術人員查詢，以獲得幫助。

---

## CE Mark Notice

This device complies with the requirements of the European Directive 1999/5/EC.

---

## New Zealand Telecom Warnings

### General

“The grant of a Telepermit for any item of terminal equipment indicates only that Telecom has accepted that the item complies with minimum conditions for connection to its network. It indicates no endorsement of the product by Telecom, nor does it provide any sort of warranty. Above all, it provides no assurance that any item will work correctly in all respects with another item of Telepermitted equipment of a different make or model, nor does it imply that any product is compatible with all of Telecom’s network services.”

“This equipment does not fully meet Telecom impedance requirements. Performance limitations may occur when used in conjunction with some parts of the network. Telecom will accept no responsibility should difficulties arise in such circumstances.”

“This equipment shall not be set up to make automatic calls to the Telecom ‘111’ Emergence Service.”

“If a charge for local calls is unacceptable, the ‘Dial’ button should NOT be used for local calls. Only the 7-digits of the local number should be dialed from your telephone. DO NOT dial the area code digit or the ‘0’ prefix.”

“This equipment may not provide for the effective hand-over of a call to another device connected to the same line.”

### Important Notice

“Under power failure conditions, this telephone may not operate. Please ensure that a separate telephone, not dependent on local power, is available for emergency use.”

“Some parameters required for compliance with Telecom’s Telepermit requirements are dependent on the equipment (PC) associated with this device. The associated equipment shall be set to operate within the following limits for compliance with Telecom’s Specification:

1. There shall be no more than 10 call attempts to the same number within any 30-minute period for any single manual call initiation, and the equipment shall go on-hook for a period of not less than 30 seconds between the end of one attempt and the beginning of the next attempt.
2. Where automatic calls are made to different numbers, the equipment shall go on-line for a period of not less than 5 seconds between the end of one attempt and the beginning of the next attempt.
3. The equipment shall be set to ensure that calls are answered between 3 and 30 seconds of receipt of ringing.”

“All persons using this device for recording telephone conversations shall comply with New Zealand law. This requires that at least one party to the conversation is to be aware that it is being recorded. In addition, the Principles enumerated in the Privacy Act of 1993 shall be complied with in respect to the nature of the personal information collected, the purpose for its collection, how it is used and what is disclosed to any other party.”

---

[Back to Contents Page](#)

# Limited Warranty and Return Policy: Dell™ Latitude™ C600/C500 User's Guide

- [Three-Year Limited Warranty for C600 Computers \(U.S. Only\)](#)
  - [Three-Year Limited Warranty for C600 Computers \(Canada Only\)](#)
  - [One-Year End-User Manufacturer Guarantee \(Latin America and the Caribbean Only\)](#)
  - ["Total Satisfaction" Return Policy \(U.S. and Canada Only\)](#)
  - [Macrovision Product Notice](#)
  - [One-Year Limited Warranty for C500 Computers \(U.S. Only\)](#)
  - [One-Year Limited Warranty for C500 Computers \(Canada Only\)](#)
- 

## Three-Year Limited Warranty for C600 Computers (U.S. Only)

Dell Computer Corporation ("Dell") manufactures its hardware products from parts and components that are new or equivalent to new in accordance with industry-standard practices. Dell warrants that the hardware products it manufactures will be free from defects in materials and workmanship. The limited warranty term is three years beginning on the date of invoice, as described in the following text.

Damage due to shipping the products to you is covered under this limited warranty. Otherwise, this limited warranty does not cover damage due to external causes, including accident, abuse, misuse, problems with electrical power, servicing not authorized by Dell, usage not in accordance with product instructions, failure to perform required preventive maintenance, and problems caused by use of parts and components not supplied by Dell.

This limited warranty does not cover any items that are in one or more of the following categories: software; external devices (except as specifically noted); accessories or parts added to a Dell system after the system is shipped from Dell; accessories or parts added to a Dell system through Dell's system integration department; accessories or parts that are not installed in the Dell factory; or DellWare™ products. Monitors, keyboards, and mice that are Dell-branded or that are included on Dell's standard price list are covered under this limited warranty; all other monitors, keyboards, and mice (including those sold through the DellWare program) are not covered. Batteries for portable computers are covered only during the initial one-year period of this limited warranty.

### Coverage During Year One

During the one-year period beginning on the invoice date, Dell will repair or replace products covered under this limited warranty that are returned to Dell's facility. To request warranty service, you must contact Dell's Customer Technical Support within the warranty period. See "[Contacting Dell](#)" to find the appropriate contact information for obtaining customer assistance. If warranty service is required, Dell will issue a Return Material Authorization Number. You must ship the products back to Dell in their original or equivalent packaging, prepay shipping charges, and insure the shipment or accept the risk of loss or damage during shipment. Dell will ship the repaired or replacement products to you freight prepaid if you use an address in the continental U.S., where applicable. Shipments to other locations will be made freight collect.

 **NOTE:** Before you ship the product(s) to Dell, back up the data on the hard-disk drive(s) and any other storage device(s) in the product(s). Remove any removable media, such as diskettes, CDs, or PC Cards. Dell does not accept liability for lost data or software.

Dell owns all parts removed from repaired products. Dell uses new and reconditioned parts made by various manufacturers in performing warranty repairs and building replacement products. If Dell repairs or replaces a product, its warranty term is not extended.

### Coverage During Years Two and Three

During the second and third years of this limited warranty, Dell will provide, on an exchange basis and subject to Dell's Exchange Policy in effect on the date of the exchange, replacement parts for the Dell hardware product(s) covered under this limited warranty when a part requires replacement. You must report each instance of hardware failure to Dell's Customer Technical Support in advance to obtain Dell's concurrence that a part should be replaced and to have Dell ship the replacement part. Dell will ship parts (freight prepaid) if you use an address in the continental U.S., where applicable. Shipments to other locations will be made freight collect. Dell will include a prepaid shipping container with each replacement part for your use in returning the replaced part to Dell. Replacement parts are new or reconditioned. Dell may provide replacement parts made by various manufacturers when supplying parts to you. The warranty term for a replacement part is the remainder of the limited warranty term.

You will pay Dell for replacement parts if the replaced part is not returned to Dell. The process for returning replaced parts, and your obligation to pay for replacement parts if you do not return the replaced parts to Dell, will be in accordance with Dell's Exchange Policy in effect on the date of the exchange.

You accept full responsibility for your software and data. Dell is not required to advise or remind you of appropriate backup and other procedures.

### General Provisions

THIS LIMITED WARRANTY GIVES YOU SPECIFIC LEGAL RIGHTS, AND YOU MAY ALSO HAVE OTHER RIGHTS, WHICH VARY FROM STATE TO STATE (OR JURISDICTION TO JURISDICTION). DELL'S RESPONSIBILITY FOR MALFUNCTIONS AND DEFECTS IN HARDWARE IS LIMITED TO REPAIR AND REPLACEMENT AS SET FORTH IN THIS LIMITED WARRANTY STATEMENT. ALL EXPRESS AND IMPLIED WARRANTIES FOR THE PRODUCT, INCLUDING BUT NOT LIMITED TO ANY IMPLIED WARRANTIES OF AND CONDITIONS OF MERCHANTABILITY AND FITNESS FOR A PARTICULAR PURPOSE, ARE LIMITED IN DURATION TO THE WARRANTY PERIOD SET FORTH ABOVE AND NO WARRANTIES, WHETHER EXPRESS OR IMPLIED, WILL APPLY AFTER SUCH PERIOD.

SOME STATES (OR JURISDICTIONS) DO NOT ALLOW LIMITATIONS ON HOW LONG AN IMPLIED WARRANTY LASTS, SO THE PRECEDING LIMITATION MAY NOT APPLY TO YOU.

DELL DOES NOT ACCEPT LIABILITY BEYOND THE REMEDIES SET FORTH IN THIS LIMITED WARRANTY STATEMENT OR LIABILITY FOR INCIDENTAL OR CONSEQUENTIAL DAMAGES, INCLUDING WITHOUT LIMITATION ANY LIABILITY FOR PRODUCTS NOT BEING AVAILABLE FOR USE OR FOR LOST DATA OR SOFTWARE.

SOME STATES (OR JURISDICTIONS) DO NOT ALLOW THE EXCLUSION OR LIMITATION OF INCIDENTAL OR CONSEQUENTIAL DAMAGES, SO THE PRECEDING EXCLUSION OR LIMITATION MAY NOT APPLY TO YOU.

These provisions apply to Dell's three-year limited warranty only. For provisions of any service contract covering your system, refer to your invoice or the separate service contract that you will receive.

If Dell elects to exchange a system or component, the exchange will be made in accordance with Dell's Exchange Policy in effect on the date of the exchange. In any instance in which Dell issues a Return Material Authorization Number, Dell must receive the product(s) for repair prior to the expiration of the warranty period in order for the repair(s) to be covered by the limited warranty.

 *NOTE: If you chose one of the available warranty and service options in place of the standard three-year limited warranty described in the preceding text, the option you chose will be listed on your invoice.*

---

## Three-Year Limited Warranty for C600 Computers (Canada Only)

Dell Computer Corporation ("Dell") manufactures its hardware products from parts and components that are new or equivalent to new in accordance with industry-standard practices. Dell warrants that the hardware products it manufactures will be free from defects in materials and workmanship. The limited warranty term is three years beginning on the date of invoice, as described in the following text.

Damage due to shipping the products to you is covered under this limited warranty. Otherwise, this limited warranty does not cover damage due to external causes, including accident, abuse, misuse, problems with electrical power, servicing not authorized by Dell, usage not in accordance with product instructions, failure to perform required preventive maintenance, and problems caused by use of parts and components not supplied by Dell.

This limited warranty does not cover any items that are in one or more of the following categories: software; external devices (except as specifically noted); accessories or parts added to a Dell system after the system is shipped from Dell; accessories or parts added to a Dell system through Dell's system integration department; accessories or parts that are not installed in the Dell factory; or DellWare products. Monitors, keyboards, and mice that are Dell-branded or that are included on Dell's standard price list are covered under this limited warranty; all other monitors, keyboards, and mice (including those sold through the DellWare program) are not covered. Batteries for portable computers are covered only during the initial one-year period of this limited warranty.

### Coverage During Year One

During the one-year period beginning on the invoice date, Dell will repair or replace products covered under this limited warranty that are returned to Dell's facility. To request warranty service, you must contact Dell's Customer Technical Support within the warranty period. See "[Contacting Dell](#)" to find the appropriate telephone number for obtaining customer assistance. If warranty service is required, Dell will issue a Return Material Authorization Number. You must ship the products back to Dell in their original or equivalent packaging, prepay shipping charges, and insure the shipment or accept the risk of loss or damage during shipment. Dell will ship the repaired or replacement products to you freight prepaid if you use an address in Canada, where applicable. Shipments to other locations will be made freight collect.

 *NOTE: Before you ship the product(s) to Dell, back up the data on the hard-disk drive(s) and any other storage device(s) in the product(s). Remove any removable media, such as diskettes, CDs, or PC Cards. Dell does not accept liability for lost data or software.*

Dell owns all parts removed from repaired products. Dell uses new and reconditioned parts made by various



manufacturers in performing warranty repairs and building replacement products. If Dell repairs or replaces a product, its warranty term is not extended.

## Coverage During Years Two and Three

During the second and third years of this limited warranty, Dell will provide, on an exchange basis and subject to Dell's Exchange Policy in effect on the date of the exchange, replacement parts for the Dell hardware product(s) covered under this limited warranty when a part requires replacement. You must report each instance of hardware failure to Dell's Customer Technical Support in advance to obtain Dell's concurrence that a part should be replaced and to have Dell ship the replacement part. Dell will ship parts (freight prepaid) if you use an address in Canada, where applicable. Shipments to other locations will be made freight collect. Dell will include a prepaid shipping container with each replacement part for your use in returning the replaced part to Dell. Replacement parts are new or reconditioned. Dell may provide replacement parts made by various manufacturers when supplying parts to you. The warranty term for a replacement part is the remainder of the limited warranty term.

You will pay Dell for replacement parts if the replaced part is not returned to Dell. The process for returning replaced parts, and your obligation to pay for replacement parts if you do not return the replaced parts to Dell, will be in accordance with Dell's Exchange Policy in effect on the date of the exchange.

You accept full responsibility for your software and data. Dell is not required to advise or remind you of appropriate backup and other procedures.

## General Provisions

DELL MAKES NO EXPRESS WARRANTIES OR CONDITIONS BEYOND THOSE STATED IN THIS LIMITED WARRANTY STATEMENT. DELL DISCLAIMS ALL OTHER WARRANTIES AND CONDITIONS, EXPRESS OR IMPLIED, INCLUDING WITHOUT LIMITATION IMPLIED WARRANTIES AND CONDITIONS OF MERCHANTABILITY AND FITNESS FOR A PARTICULAR PURPOSE. SOME STATES (OR JURISDICTIONS) DO NOT ALLOW LIMITATIONS ON IMPLIED WARRANTIES OR CONDITIONS, SO THIS LIMITATION MAY NOT APPLY TO YOU.

DELL'S RESPONSIBILITY FOR MALFUNCTIONS AND DEFECTS IN HARDWARE IS LIMITED TO REPAIR AND REPLACEMENT AS SET FORTH IN THIS LIMITED WARRANTY STATEMENT. THESE WARRANTIES GIVE YOU SPECIFIC LEGAL RIGHTS, AND YOU MAY ALSO HAVE OTHER RIGHTS, WHICH VARY FROM STATE TO STATE (OR JURISDICTION TO JURISDICTION).

DELL DOES NOT ACCEPT LIABILITY BEYOND THE REMEDIES SET FORTH IN THIS LIMITED WARRANTY STATEMENT OR LIABILITY FOR INCIDENTAL OR CONSEQUENTIAL DAMAGES, INCLUDING WITHOUT LIMITATION ANY LIABILITY FOR PRODUCTS NOT BEING AVAILABLE FOR USE OR FOR LOST DATA OR SOFTWARE.

SOME STATES (OR JURISDICTIONS) DO NOT ALLOW THE EXCLUSION OR LIMITATION OF INCIDENTAL OR CONSEQUENTIAL DAMAGES, SO THE PRECEDING EXCLUSION OR LIMITATION MAY NOT APPLY TO YOU.

These provisions apply to Dell's three-year limited warranty only. For provisions of any service contract covering your system, refer to your invoice or the separate service contract that you will receive.

If Dell elects to exchange a system or component, the exchange will be made in accordance with Dell's Exchange Policy in effect on the date of the exchange. In any instance in which Dell issues a Return Material Authorization Number, Dell must receive the product(s) for repair prior to the expiration of the warranty

period in order for the repair(s) to be covered by the limited warranty.

 *NOTE: If you chose one of the available warranty and service options in place of the standard three-year limited warranty described in the preceding text, the option you chose will be listed on your invoice.*

---

## One-Year End-User Manufacturer Guarantee (Latin America and the Caribbean Only)

### Guarantee

Dell Computer Corporation ("Dell") warrants to the end user in accordance with the following provisions that its branded hardware products, purchased by the end user from a Dell company or an authorized Dell distributor in Latin America or the Caribbean, will be free from defects in materials, workmanship, and design affecting normal use, for a period of one year from the original purchase date. Products for which proper claims are made will, at Dell's option, be repaired or replaced at Dell's expense. Dell owns all parts removed from repaired products. Dell uses new and reconditioned parts made by various manufacturers in performing repairs and building replacement products.

### Exclusions

This Guarantee does not apply to defects resulting from: improper or inadequate installation, use, or maintenance; actions or modifications by unauthorized third parties or the end user; accidental or willful damage; or normal wear and tear.

### Making a Claim

Claims must be made in Latin America or the Caribbean by contacting the Dell point of sale within the guarantee period. The end user must always supply proof of purchase, indicating name and address of the seller, date of purchase, model and serial number, name and address of the customer, and details of symptoms and configuration at the time of malfunction, including peripherals and software used. Otherwise, Dell may refuse the guarantee claim. Upon diagnosis of a warranted defect, Dell will make arrangements and pay for ground freight and insurance to and from Dell's repair/replacement center. The end user must ensure that the defective product is available for collection properly packed in original or equally protective packaging together with the details listed above and the return number provided to the end user by Dell.

### Limitation and Statutory Rights

Dell makes no other warranty, guarantee or like statement other than as explicitly stated above, and this Guarantee is given in place of all other guarantees whatsoever, to the fullest extent permitted by law. In the absence of applicable legislation, this Guarantee will be the end user's sole and exclusive remedy against Dell or any of its affiliates, and neither Dell nor any of its affiliates shall be liable for loss of profit or contracts, or any other indirect or consequential loss arising from negligence, breach of contract, or howsoever.

This Guarantee does not impair or affect mandatory statutory rights of the end-user against and/or any rights resulting from other contracts concluded by the end-user with Dell and/or any other seller.

Dell World Trade LP  
One Dell Way, Round Rock, TX 78682, USA

Dell Computadores do Brasil Ltda (CNPJ No. 72.381.189/0001-10)/  
Dell Commercial do Brasil Ltda (CNPJ No. 03 405 822/0001-40)  
Avenida Industrial Belgraf, 400  
92990-000 - Eldorado do Sul – RS - Brasil

Dell Computer de Chile Ltda  
Coyancura 2283, Piso 3- Of.302,  
Providencia, Santiago - Chile

Dell Computer de Colombia Corporation  
Carrera 7 #115-33 Oficina 603  
Bogota, Colombia

Dell Computer de Mexico SA de CV  
Paseo de la Reforma 2620 - 11° Piso  
Col. Lomas Altas  
11950 México, D.F.

---

## "Total Satisfaction" Return Policy (U.S. and Canada Only)

If you are an end-user customer who bought new products directly from a Dell company, you may return them to Dell within 30 days of the date of invoice for a refund or credit of the product purchase price. If you are an end-user customer who bought reconditioned or refurbished products from a Dell company, you may return them to Dell within 14 days of the date of invoice for a refund or credit of the product purchase price. In either case, the refund or credit will not include any shipping and handling charges shown on your invoice. If you are an organization that bought the products under a written agreement with Dell, the agreement may contain different terms for the return of products than specified by this policy.

To return products, you must contact Dell Customer Service to receive a Credit Return Authorization Number. See "[Contacting Dell](#)" to find the appropriate contact information for obtaining customer assistance. To expedite the processing of your refund or credit, Dell expects you to return the products to Dell in their original packaging within five days of the date that Dell issues the Credit Return Authorization Number. You must also prepay shipping charges and insure the shipment or accept the risk of loss or damage during shipment. You may return software for refund or credit only if the sealed package containing the diskette(s) or CD(s) is unopened. Returned products must be in as-new condition, and all of the manuals, diskette(s), CD(s), power cables, and other items included with a product must be returned with it. For customers who want to return, for refund or credit only, either applications software or an operating system that has been installed by Dell, the whole system must be returned, along with any media and documentation that may have been included in the original shipment.

This "Total Satisfaction" Return Policy does not apply to DellWare products, which may be returned under DellWare's then-current return policy. In addition, reconditioned parts purchased through Dell Spare Parts Sales in Canada are nonreturnable.

---

## Macrovision Product Notice

The following product notice applies to the Macrovision Corporation product that is included with the DVD-ROM drive:

This product incorporates copyright protection technology that is protected by method claims of certain U.S. patents and other intellectual property rights owned by Macrovision Corporation and other rights owners. Use of this copyright protection technology must be authorized by Macrovision Corporation, and is intended for home and other limited viewing uses only unless otherwise authorized by Macrovision Corporation. Reverse engineering or disassembly is prohibited.

---

## One-Year Limited Warranty for C500 Computers (U.S. Only)

Dell Computer Corporation ("Dell") manufactures its hardware products from parts and components that are new or equivalent to new in accordance with industry-standard practices. Dell warrants that the hardware products it manufactures will be free from defects in materials and workmanship. The warranty term is one year beginning on the date of invoice, as further described in the following text.

Damage due to shipping the products to you is covered under this limited warranty. Otherwise, this limited warranty does not cover damage due to external causes, including accident, abuse, misuse, problems with electrical power, servicing not authorized by Dell, usage not in accordance with product instructions, failure to perform required preventive maintenance, and problems caused by use of parts and components not supplied by Dell.

This limited warranty does not cover any items that are in one or more of the following categories: software; external devices (except as specifically noted); accessories or parts added to a Dell system after the system is shipped from Dell; accessories or parts added to a Dell system through Dell's system integration department; accessories or parts that are not installed in the Dell factory; or DellWare™ products. Monitors, keyboards, and mice that are Dell-branded or that are included on Dell's standard price list are covered under this limited warranty; all other monitors, keyboards, and mice (including those sold through the DellWare program) are not covered.

Dell will repair or replace products covered under this limited warranty that are returned to Dell's facility. To request warranty service, you must contact Dell's Customer Technical Support within the warranty period. See "[Contacting Dell](#)" to find the appropriate contact information for obtaining customer assistance. If warranty service is required, Dell will issue a Return Material Authorization Number. You must ship the products back to Dell in their original or equivalent packaging, prepay shipping charges, and insure the shipment or accept the risk of loss or damage during shipment. Dell will ship the repaired or replacement products to you (freight prepaid) if you use an address in the continental U.S., where applicable. Shipments to other locations will be made freight collect.

*NOTE: Before you ship the product(s) to Dell, back up the data on the hard-disk drive(s) and any other storage device(s) in the product(s). Remove any removable media, such as diskettes, CDs, or PC Cards.*

Dell owns all parts removed from repaired products. Dell uses new and reconditioned parts made by various manufacturers in performing warranty repairs and building replacement products. If Dell repairs or replaces a product, its warranty term is not extended.

**THIS LIMITED WARRANTY GIVES YOU SPECIFIC LEGAL RIGHTS, AND YOU MAY ALSO HAVE OTHER RIGHTS, WHICH VARY FROM STATE TO STATE (OR JURISDICTION TO JURISDICTION). DELL'S RESPONSIBILITY FOR MALFUNCTIONS AND DEFECTS IN HARDWARE IS LIMITED TO REPAIR AND REPLACEMENT AS SET FORTH IN THIS LIMITED WARRANTY STATEMENT. ALL EXPRESS AND IMPLIED WARRANTIES FOR THE PRODUCT, INCLUDING BUT NOT LIMITED TO ANY IMPLIED WARRANTIES OF AND CONDITIONS OF MERCHANTABILITY AND FITNESS FOR A PARTICULAR PURPOSE, ARE LIMITED IN DURATION TO THE WARRANTY PERIOD SET FORTH ABOVE AND NO WARRANTIES, WHETHER EXPRESS OR IMPLIED, WILL APPLY AFTER SUCH PERIOD.**

SOME STATES (OR JURISDICTIONS) DO NOT ALLOW LIMITATIONS ON HOW LONG AN IMPLIED WARRANTY LASTS, SO THE PRECEDING LIMITATION MAY NOT APPLY TO YOU.

DELL DOES NOT ACCEPT LIABILITY BEYOND THE REMEDIES SET FORTH IN THIS LIMITED WARRANTY STATEMENT OR LIABILITY FOR INCIDENTAL OR CONSEQUENTIAL DAMAGES, INCLUDING WITHOUT LIMITATION ANY LIABILITY FOR PRODUCTS NOT BEING AVAILABLE FOR USE OR FOR LOST DATA OR SOFTWARE.

SOME STATES (OR JURISDICTIONS) DO NOT ALLOW THE EXCLUSION OR LIMITATION OF INCIDENTAL OR CONSEQUENTIAL DAMAGES, SO THE PRECEDING EXCLUSION OR LIMITATION MAY NOT APPLY TO YOU.

These provisions apply to Dell's one-year limited warranty only. For provisions of any service contract covering your system, see your invoice or the separate service contract that you will receive.

If Dell elects to exchange a product or portion of a product, the exchange will be made in accordance with Dell's Exchange Policy in effect on the date of the exchange. In any instance in which Dell issues a Return Material Authorization Number, Dell must receive the product(s) for repair prior to the expiration of the warranty period in order for the repair(s) to be covered by the limited warranty.

---

## One-Year Limited Warranty for C500 Computers (Canada Only)

Dell Computer Corporation ("Dell") manufactures its hardware products from parts and components that are new or equivalent to new in accordance with industry-standard practices. Dell warrants that the hardware products it manufactures will be free from defects in materials and workmanship. The warranty term is one year beginning on the date of invoice, as further described in the following text.

Damage due to shipping the products to you is covered under this limited warranty. Otherwise, this limited warranty does not cover damage due to external causes, including accident, abuse, misuse, problems with electrical power, servicing not authorized by Dell, usage not in accordance with product instructions, failure to perform required preventive maintenance, and problems caused by use of parts and components not supplied by Dell.

This limited warranty does not cover any items that are in one or more of the following categories: software; external devices (except as specifically noted); accessories or parts added to a Dell system after the system is shipped from Dell; accessories or parts added to a Dell system through Dell's system integration department; accessories or parts that are not installed in the Dell factory; or DellWare™ products. Monitors, keyboards, and mice that are Dell-branded or that are included on Dell's standard price list are covered under this limited warranty; all other monitors, keyboards, and mice (including those sold through the DellWare program) are not covered.

Dell will repair or replace products covered under this limited warranty that are returned to Dell's facility. To request warranty service, you must contact Dell's Customer Technical Support within the warranty period. See "[Contacting Dell](#)" to find the appropriate contact information for obtaining customer assistance. If warranty service is required, Dell will issue a Return Material Authorization Number. You must ship the products back to Dell in their original or equivalent packaging, prepay shipping charges, and insure the shipment or accept the risk of loss or damage during shipment. Dell will ship the repaired or replacement products to you (freight prepaid) if you use an address in Canada, where applicable. Shipments to other locations will be made freight collect.

*NOTE: Before you ship the product(s) to Dell, back up the data on the hard-disk drive(s) and any other storage device(s) in the product(s). Remove any removable media, such as diskettes, CDs, or PC Cards.*

Dell owns all parts removed from repaired products. Dell uses new and reconditioned parts made by various manufacturers in performing warranty repairs and building replacement products. If Dell repairs or replaces a product, its warranty term is not extended.

DELL MAKES NO EXPRESS WARRANTIES OR CONDITIONS BEYOND THOSE STATED IN THIS LIMITED WARRANTY STATEMENT. DELL DISCLAIMS ALL OTHER WARRANTIES AND CONDITIONS, EXPRESS OR IMPLIED, INCLUDING WITHOUT LIMITATION IMPLIED WARRANTIES AND CONDITIONS OF MERCHANTABILITY AND FITNESS FOR A PARTICULAR PURPOSE. SOME STATES (OR JURISDICTIONS) DO NOT ALLOW LIMITATIONS ON IMPLIED WARRANTIES OR CONDITIONS, SO THIS LIMITATION MAY NOT APPLY TO YOU.

DELL'S RESPONSIBILITY FOR MALFUNCTIONS AND DEFECTS IN HARDWARE IS LIMITED TO REPAIR AND REPLACEMENT AS SET FORTH IN THIS LIMITED WARRANTY STATEMENT. THESE WARRANTIES GIVE YOU SPECIFIC LEGAL RIGHTS, AND YOU MAY ALSO HAVE OTHER RIGHTS, WHICH VARY FROM STATE TO STATE (OR JURISDICTION TO JURISDICTION).

DELL DOES NOT ACCEPT LIABILITY BEYOND THE REMEDIES SET FORTH IN THIS LIMITED WARRANTY STATEMENT OR LIABILITY FOR INCIDENTAL OR CONSEQUENTIAL DAMAGES, INCLUDING WITHOUT LIMITATION ANY LIABILITY FOR PRODUCTS NOT BEING AVAILABLE FOR USE OR FOR LOST DATA OR SOFTWARE.

SOME STATES (OR JURISDICTIONS) DO NOT ALLOW THE EXCLUSION OR LIMITATION OF INCIDENTAL OR CONSEQUENTIAL DAMAGES, SO THE PRECEDING EXCLUSION OR LIMITATION MAY NOT APPLY TO YOU.

These provisions apply to Dell's one-year limited warranty only. For provisions of any service contract covering your system, refer to your invoice or the separate service contract that you will receive.

If Dell elects to exchange a product or portion of a product, the exchange will be made in accordance with Dell's Exchange Policy in effect on the date of the exchange. In any instance in which Dell issues a Return Material Authorization Number, Dell must receive the product(s) for repair prior to the expiration of the warranty period in order for the repair(s) to be covered by the limited warranty.

---

[Back to Contents Page](#)

# Contacting Dell: Dell™ Latitude™ C600/C500 User's Guide

[Overview](#)

[Europe Contact Numbers](#)

[International Dialing Codes](#)

[Asia and Other Regions Contact Numbers](#)

[Americas Contact Numbers](#)

---

## Overview

When you need to contact Dell, use the telephone numbers, codes, and electronic addresses provided in the following sections. "[International Dialing Codes](#)" provides the various codes required to make long-distance and international calls. "[Americas Contact Numbers](#)," "[Europe Contact Numbers](#)," and "[Asia and Other Regions Contact Numbers](#)" provide local telephone numbers, area codes, toll-free numbers, and e-mail addresses, if applicable, for each department or service available in various countries around the world.

If you are making a direct-dialed call to a location outside of your local telephone service area, determine which codes to use (if any) in "[International Dialing Codes](#)," in addition to the local numbers provided in the other sections.

For example, to place an international call from Paris, France to Bracknell, England, dial the international access code for France followed by the country code for the U.K., the city code for Bracknell, and then the local number as shown in the following illustration:



To place a long-distance call within your own country, use area codes instead of international access codes, country codes, and city codes. For example, to call Paris, France from Montpellier, France, dial the area code plus the local number as shown in the following illustration:



The codes required depend on where you are calling from as well as the destination of your call; in addition, each country has a different dialing protocol. If you need assistance in determining which codes to use, contact a local or an international operator.

 **NOTES:** Toll-free numbers are for use only within the country for which they are listed. Area codes are most often used to call long distance within your own country (not internationally)—in other words, when your call originates in the same country you are calling.

*Have your Express Service Code ready when you call. The code helps Dell's automated-support telephone system direct your call more efficiently.*

## International Dialing Codes

Click a listed country to obtain the appropriate contact numbers.

Country (City)	International Access Code	Country Code	City Code
<a href="#">Australia</a> (Sydney)	0011	61	2
<a href="#">Austria</a> (Vienna)	900	43	1
<a href="#">Belgium</a> (Brussels)	00	32	2
<a href="#">Brazil</a>	0021	55	51
<a href="#">Brunei</a>	—	673	—
<a href="#">Canada</a> (North York, Ontario)	011	—	Not required
<a href="#">Chile</a> (Santiago)	—	56	2
<a href="#">China</a> (Xiamen)	—	86	592
<a href="#">Czech Republic</a> (Prague)	00	420	2
<a href="#">Denmark</a> (Horsholm)	00	45	Not required
<a href="#">Finland</a> (Helsinki)	990	358	9
<a href="#">France</a> (Paris) (Montpellier)	00	33	(1) (4)
<a href="#">Germany</a> (Langen)	00	49	6103
<a href="#">Hong Kong</a>	001	852	Not required
<a href="#">Ireland</a> (Cherrywood)	16	353	1
<a href="#">Italy</a> (Milan)	00	39	02
<a href="#">Japan</a> (Kawasaki)	001	81	44
<a href="#">Korea</a> (Seoul)	001	82	2
<a href="#">Luxembourg</a>	00	352	—
<a href="#">Macau</a>	—	853	Not required
<a href="#">Malaysia</a> (Penang)	00	60	4
<a href="#">Mexico</a> (Colonia Granada)	00	52	Not required
<a href="#">Netherlands</a> (Amsterdam)	00	31	20
<a href="#">New Zealand</a>	00	64	—
<a href="#">Norway</a> (Lysaker)	00	47	Not required
<a href="#">Poland</a> (Warsaw)	011	48	22



<a href="#">Portugal</a>	00	35	—
<a href="#">Singapore</a> (Singapore)	005	65	Not required
<a href="#">South Africa</a> (Johannesburg)	09/091	27	11
<a href="#">Spain</a> (Madrid)	00	34	91
<a href="#">Sweden</a> (Upplands Vasby)	00	46	8
<a href="#">Switzerland</a> (Geneva)	00	41	22
<a href="#">Taiwan</a>	002	886	—
<a href="#">Thailand</a>	001	66	—
<a href="#">U.K.</a> (Bracknell)	010	44	1344
<a href="#">U.S.A.</a> (Austin, Texas)	011	1	Not required

## Americas Contact Numbers

Country (City)	Department Name or Service	Area Code	Local Number or Toll-Free Number
Antigua and Barbuda	General Support		1-800-805-5924
Barbados	General Support		1-800-534-3066
Bermuda	General Support		1-800-342-0671
Brazil	Customer Support, Technical Support		toll free: 0800 90 3355
	Technical Support Fax	51	51 481-5470
	Sales		toll free: 0800 90 3366
	Web site: <a href="http://www.dell.com/br">http://www.dell.com/br</a>		
Canada (North York, Ontario)	Automated Order-Status System		toll free: 1-800-433-9014
	AutoTech (Automated technical support)		toll free: 1-800-247-9362
	Customer Care (From outside Toronto)		toll free: 1-800-387-5759

	Customer Care (From within Toronto)	416	758-2400
	Customer Technical Support		toll free: 1-800-847-4096
	Sales (Direct Sales—from outside Toronto)		toll free: 1-800-387-5752
	Sales (Direct Sales—from within Toronto)	416	758-2200
	Sales (Federal government, education, and medical)		toll free: 1-800-567-7542
	Sales (Major Accounts)		toll free: 1-800-387-5755
	TechFax		toll free: 1-800-950-1329
Cayman Islands	General Support		1-800-805-7541
Chile (Santiago) <i>NOTE: Customers in Chile call the U.S.A. for sales, customer, and technical assistance</i>	Sales, Customer Support, and Technical Support		toll free: 1230-020-4823
Columbia	General Support		980-9-15-3978
Costa Rica	General Support		800-012-0435
Dominican Republic	General Support		1-800-148-0530
El Salvador	General Support		01-889-753-0777
Guatemala	General Support		1-800-999-0136

Jamaica	General Support		1-800-682-3639
Latin America <i>NOTE: Customers in Latin America call the U.S.A. for sales, customer, and technical assistance.</i>	Customer Technical Support (Austin, Texas, U.S.A.)	512	728-4093
	Customer Service (Austin, Texas, U.S.A.)	512	728-3619
	Fax (Technical Support and Customer Service) (Austin, Texas, U.S.A.)	512	728-3883
	Sales (Austin, Texas, U.S.A.)	512	728-4397
	SalesFax (Austin, Texas, U.S.A.)	512	728-4600 728-3772
Mexico	Customer Technical Support		001-877-384-8979 or 001-877-269-3383
	Sales		50-81-8800 or 01-800-888-3355
	Customer Service		001-877-384-8979 or 001-877-269-3383
	Main		50-81-8800 or 01-800-888-3355
Netherlands Antilles	General Support		001-800-882-15194
Nicaragua	General Support		001-800-220-1006
Panama	General Support		001-800-507-0962
Peru	General Support		0800-50-669

Puerto Rico	General Support		800-805-7545
St. Lucia	General Support		1-800-882-1521
Trinidad and Tobago	General Support		1-800-805-8035
U.S.A. (Austin, Texas)	Automated Order-Status System		toll free: 1-800-433-9014
	AutoTech (for portable and desktop computers)		toll free: 1-800-247-9362
	Dell Home and Small Business Group (for portable and desktop computers):		
	Customer Technical Support (Return Material Authorization Numbers)		toll free: 1-800-624-9896
	Customer Technical Support (Home sales purchased via <a href="http://www.dell.com">http://www.dell.com</a> )		toll free: 1-877-576-3355
	Customer Service (Credit Return Authorization Numbers)		toll free: 1-800-624-9897
	National Accounts (systems purchased by established Dell national accounts [have your account number handy], medical institutions, or value-added resellers [VARs]):A		
	Customer Service and Technical Support (Return Material Authorization Numbers)		toll free: 1-800-822-8965
	Public Americas International (systems purchased by governmental agencies [local, state, or federal] or educational institutions):		
	Customer Service and Technical Support (Return Material Authorization Numbers)		toll free: 1-800-234-1490
	Dell Sales		toll free: 1-800-289-3355 toll free: 1-800-879-3355
	Spare Parts Sales		toll free: 1-800-357-3355
	DellWare™		toll free: 1-800-753-7201
Desktop and Portable Fee-Based		toll free: 1-800-433-9005	

	Technical Support		
	Server Fee-Based Technical Support		toll free: 1-800-967-0765
	Sales (Catalogs)		toll free: 1-800-426-5150
	Fax		toll free: 1-800-727-8320
	TechFax		toll free: 1-800-950-1329
	Dell Services for the Deaf, Hard-of-Hearing, or Speech-Impaired		toll free: 1-877-DELLTTY (1-877-335-5889)
	Switchboard	512	338-4400
U.S. Virgin Islands	General Support		1-877-673-3355
Venezuela	General Support		8001-3605

## Europe Contact Numbers

Country (City)	Department Name or Service	Area Code	Local Number or Toll-Free Number
Austria (Vienna)  <i>NOTE: Customers in Austria call Langen, Germany for Technical Support and Customer Care.</i>	Switchboard	01	491 040
	Home/Small Business Sales	01	795676-02
	Home/Small Business Sales Fax	01	795676-05
	Home/Small Business Customer Care	01	795676-03
	Preferred Accounts/Corporate Customer Care		0660-8056
	Home/Small Business Technical Support	01	795676-04
	Preferred Accounts/Corporate Technical Support		0660-8779
	Web site: <a href="http://support.euro.dell.com">http://support.euro.dell.com</a>		
	E-mail: tech_support_central_europe@dell.com		
	Belgium (Brussels)	Technical Support	02

	Customer Care	02	481 91 19
	Home/Small Business Sales		toll free: 0800 16884
	Corporate Sales	02	481 91 00
	Fax	02	481 92 99
	Switchboard	02	481 91 00
	Web site: <a href="http://support.euro.dell.com">http://support.euro.dell.com</a>		
	E-mail: <a href="mailto:tech_be@dell.com">tech_be@dell.com</a>		
	E-mail for French Speaking Customers: <a href="http://support.euro.dell.com/be/fr/emaildell/">http://support.euro.dell.com/be/fr/emaildell/</a>		
Czech Republic (Prague)	Technical Support	02	22 83 27 27
	Customer Care	02	22 83 27 11
	Fax	02	22 83 27 14
	TechFax	02	22 83 27 28
	Switchboard	02	22 83 27 11
	Web site: <a href="http://support.euro.dell.com">http://support.euro.dell.com</a>		
	E-mail: <a href="mailto:czech_dell@dell.com">czech_dell@dell.com</a>		
Denmark (Horsholm)  <i>NOTE: Customers in Denmark call Sweden for fax technical support.</i>	Technical Support		45170182
	Relational Customer Care		45170184
	Home/Small Business Customer Care		32875505
	Switchboard		45170100
	Fax Technical Support (Upplands Vasby, Sweden)	46	859005594
	Fax Switchboard		45170117
	Web site: <a href="http://support.euro.dell.com">http://support.euro.dell.com</a>		
	E-mail: <a href="mailto:den_support@dell.com">den_support@dell.com</a>  E-mail Support for Servers: <a href="mailto:Nordic_server_support@dell.com">Nordic_server_support@dell.com</a>		
Finland (Helsinki)	Technical Support	09	253 313 60
	Technical Support Fax	09	253 313 81
	Relational Customer Care	09	253 313 38
	Home/Small Business Customer Care	09	693 791 94

	Fax	09	253 313 99	
	Switchboard	09	253 313 00	
	Web site: <a href="http://support.euro.dell.com">http://support.euro.dell.com</a>			
	E-mail: <a href="mailto:fin_support@dell.com">fin_support@dell.com</a>			
France (Paris/Montpellier)	Home and Small Business			
	Technical Support	0825	387 270	
	Customer Care	0825	823 833	
	Fax	0825	004 701	
	Fax (Alternative)	04	99 75 40 01	
	Switchboard	0825	004 700	
	Switchboard (Alternative)	04	99 75 40 00	
	Sales	0825	004 700	
	Web site: <a href="http://support.euro.dell.com">http://support.euro.dell.com</a>			
	E-mail: <a href="http://support.euro.dell.com/fr/fr/emaildell/">http://support.euro.dell.com/fr/fr/emaildell/</a>			
	Corporate			
	Technical Support	0825	004 719	
	Customer Care	0825	338 339	
	Fax	01	55 94 71 01	
	Switchboard	01	55 94 71 00	
	Sales	01	55 94 71 00	
	Web site: <a href="http://support.euro.dell.com">http://support.euro.dell.com</a>			
	E-mail: <a href="http://support.euro.dell.com/fr/fr/emaildell/">http://support.euro.dell.com/fr/fr/emaildell/</a>			
	Germany (Langen)	Technical Support	06103	766-7200
		Home/Small Business Customer Care		0180-5-224400
Global Segment Customer Care		06103	766-9570	
Preferred Accounts Customer Care		06103	766-9420	
Large Accounts Customer Care		06103	766-9560	
Public Accounts Customer Care		06103	766-9555	
Switchboard		06103	766-7000	

	Web site: <a href="http://support.euro.dell.com">http://support.euro.dell.com</a>		
	E-mail: <a href="mailto:tech_support_central_europe@dell.com">tech_support_central_europe@dell.com</a>		
Ireland (Cherrywood)	Technical Support		1850 543 543
	Home User Customer Care	01	204 4095
	Small Business Customer Care	01	204 4026
	Corporate Customer Care	01	279 5011
	Sales	01	204 4444
	SalesFax	01	204 0144
	Fax		204 5960
	Switchboard	01	204 4444
	Web site: <a href="http://support.euro.dell.com">http://support.euro.dell.com</a>		
	E-mail: <a href="mailto:dell_direct_support@dell.com">dell_direct_support@dell.com</a>		
Italy (Milan)	Home and Small Business		
	Technical Support	02	577 826 90
	Customer Care	02	696 821 14
	Fax	02	696 821 13
	Switchboard	02	696 821 11
	Web site: <a href="http://support.euro.dell.com">http://support.euro.dell.com</a>		
	E-mail: <a href="http://support.euro.dell.com/it/it/emaildell/">http://support.euro.dell.com/it/it/emaildell/</a>		
	Corporate		
	Technical Support	02	577 826 90
	Customer Care	02	577 825 55
	Fax	02	575 035 30
	Switchboard	02	577 821
	Web site: <a href="http://support.euro.dell.com">http://support.euro.dell.com</a>		
	E-mail: <a href="http://support.euro.dell.com/it/it/emaildell/">http://support.euro.dell.com/it/it/emaildell/</a>		
Luxembourg	Technical Support (Brussels, Belgium)	02	481 92 88
<i>NOTE: Customers in Luxembourg call Belgium for</i>	Home/Small Business Sales (Brussels, Belgium)		toll free: 080016884



<i>sales, customer, and technical assistance.</i>	Corporate Sales (Brussels, Belgium)	02	481 91 00
	Customer Care (Brussels, Belgium)	02	481 91 19
	Switchboard (Brussels, Belgium)	02	481 91 00
	Fax (Brussels, Belgium)	02	481 92 99
	Web site: <a href="http://support.euro.dell.com">http://support.euro.dell.com</a>		
	E-mail: <a href="mailto:tech_be@dell.com">tech_be@dell.com</a>		
Netherlands (Amsterdam)	Technical Support	020	581 8838
	Customer Care	020	581 8740
	Home/Small Business Sales		toll free: 0800-0663
	Home/Small Business Sales Fax	020	682 7171
	Corporate Sales	020	581 8818
	Corporate Sales Fax	020	686 8003
	Fax	020	686 8003
	Switchboard	020	581 8818
	Web site: <a href="http://support.euro.dell.com">http://support.euro.dell.com</a>		
	E-mail: <a href="mailto:tech_nl@dell.com">tech_nl@dell.com</a>		
Norway (Lysaker)  <i>NOTE: Customers in Norway call Sweden for fax technical support.</i>	Technical Support		671 16882
	Relational Customer Care		671 17514
	Home/Small Business Customer Care		231 62298
	Switchboard		671 16800
	Fax Technical Support (Upplands Vasby, Sweden)	00	46 08 590 05 594
	Fax Switchboard		671 16865
	Web site: <a href="http://support.euro.dell.com">http://support.euro.dell.com</a>		
	E-mail: <a href="mailto:nor_support@dell.com">nor_support@dell.com</a>  E-mail Support for Servers: <a href="mailto:Nordic_server_support@dell.com">Nordic_server_support@dell.com</a>		
Poland (Warsaw)	Customer Service Phone	22	57 95 700
	Customer Care	22	57 95 999
	Sales	22	57 95 999
	Switchboard	22	57 95 999

	Customer Service Fax	22	57 95 806
	Fax	22	57 95 998
	Web site: <a href="http://support.euro.dell.com">http://support.euro.dell.com</a>		
	E-mail: <a href="mailto:pl_support@dell.com">pl_support@dell.com</a>		
Portugal	Technical Support	35	800 834 077
	Customer Care		800 300 415 or 800 834 075
	Sales		800 300 410 or 800 300 411 or 800 300 412 or 351 214 220 710
	Switchboard	34	917 229 200
	Fax	35	121 424 01 12
	E-mail: <a href="http://support.euro.dell.com/es/es/emaildell/">http://support.euro.dell.com/es/es/emaildell/</a>		
Spain (Madrid)	Home and Small Business		
	Technical Support		902 100 130
	Customer Care		902 118 540
	Sales		902 118 541
	Fax		902 118 539
	Web site: <a href="http://support.euro.dell.com">http://support.euro.dell.com</a>		
	E-mail: <a href="http://support.euro.dell.com/es/es/emaildell/">http://support.euro.dell.com/es/es/emaildell/</a>		
	Corporate		
	Technical Support		902 100 130
	Customer Care		902 118 546
	Switchboard	91	722 92 00
	Fax	91	722 95 83
	Web site: <a href="http://support.euro.dell.com">http://support.euro.dell.com</a>		

	E-mail: <a href="http://support.euro.dell.com/es/es/emaildell/">http://support.euro.dell.com/es/es/emaildell/</a>		
Sweden (Upplands Vasby)	Technical Support	08	590 05 199
	Relational Customer Care	08	590 05 642
	Home/Small Business Customer Care	08	587 70 527
	Fax Technical Support	08	590 05 594
	Sales	08	590 05 185
	Web site: <a href="http://support.euro.dell.com">http://support.euro.dell.com</a>		
	E-mail: <a href="mailto:swe_support@dell.com">swe_support@dell.com</a>  E-mail Support for Latitude™ and Inspiron™: <a href="mailto:Swe-nbk_kats@dell.com">Swe-nbk_kats@dell.com</a>  E-mail Support for OptiPlex™ : <a href="mailto:Swe_kats@dell.com">Swe_kats@dell.com</a>  E-mail Support for Servers: <a href="mailto:Nordic_server_support@dell.com">Nordic_server_support@dell.com</a>		
Switzerland (Geneva)	Technical Support (Home and Small Business)		0844 811 411
	Technical Support (Corporate)		0844 822 844
	Customer Care (Home and Small Business)		0848 802 202
	Customer Service (Corporate)		0848 821 721
	Switchboard	022	799 01 01
	Fax	022	799 01 90
	Web site: <a href="http://support.euro.dell.com">http://support.euro.dell.com</a>		
	E-mail for French Speaking HSB and Corporate Customers: <a href="http://support.euro.dell.com/ch/fr/emaildell/">http://support.euro.dell.com/ch/fr/emaildell/</a>		
U.K. (Bracknell)	Technical Support (Corporate/Preferred Accounts/PAD [1000+ employees])	0870	908 0500
	Technical Support (Direct/PAD and General)	0870	908 0800
	Global Accounts Customer Care	01344	723186
	Corporate Customer Care	01344	72 3185
	Preferred Accounts (500-5000 employees) Customer Care	01344	723 196
	Central Government Customer Care	01344	723 193

Local Government Customer Care	01344	723 194
Home/Small Business Sales	0870	907 4000
Home/Small Business Customer Care	0870	906 0010
Corporate/Public Sector Sales	01344	860 456
Web site: <a href="http://support.euro.dell.com">http://support.euro.dell.com</a>		
E-mail: <a href="mailto:dell_direct_support@dell.com">dell_direct_support@dell.com</a>		

## Asia and Other Regions Contact Numbers

Country (City)	Department Name or Service	Area Code	Local Number or Toll-Free Number
Australia (Sydney)	Home and Small Business		1-300-65-55-33
	Government and Business		toll free: 1-800-633-559
	Preferred Accounts Division (PAD)		toll free: 1-800-060-889
	Customer Care		toll free: 1-800-819-339
	Corporate Sales		toll free: 1-800-808-385
	Transaction Sales		toll free: 1-800-808-312
	Fax		toll free: 1-800-818-341
Brunei <i>NOTE: Customers in Brunei call Malaysia for customer assistance.</i>	Customer Technical Support (Penang, Malaysia)		633 4966
	Customer Service (Penang, Malaysia)		633 4949
	Transaction Sales (Penang, Malaysia)		633 4955
China (Xiamen)	Home and Small Business Technical Support		toll free: 800 858 2437
	Corporate Accounts Technical Support		toll free: 800 858 2333
	Customer Experience		toll free: 800 858 2060
	Home and Small Business		toll free: 800 858 2222
	Preferred Accounts Division		toll free: 800 858 2062
	Large Corporate Accounts North		toll free: 800 858 2999
	Large Corporate Accounts East		toll free: 800 858 2020
	Large Corporate Accounts South		toll free: 800 858 2355

	Large Corporate Accounts GCP		toll free: 800 858 2055
	Large Corporate Accounts HK		toll free: 800 964108
	Large Corporate Accounts GCP HK		toll free: 800 907308
Hong Kong	Technical Support		toll free: 800 96 4107
<i>NOTE: Customers in Hong Kong call Malaysia for customer assistance.</i>	Customer Service (Penang, Malaysia)		633 4949
	Transaction Sales		toll free: 800 96 4109
	Corporate Sales		toll free: 800 96 4108
Japan (Kawasaki)	Technical Support (Server)		toll free: 0120-1984-35
	Technical Support Outside of Japan (Server)	81-44	556-4152
	Technical Support (Dimension™ and Inspiron)		toll free: 0120-1982-26
	Technical Support Outside of Japan (Dimension and Inspiron)	81-44	520-1435
	Technical Support (Dell Precision™, OptiPlex, and Latitude)	81-44	toll free: 0120-1984-33
	Technical Support Outside of Japan (Dell Precision, OptiPlex, and Latitude)		556-3894
	Customer Care	044	556-4240
	24-Hour Automated Order Status Service	044	556-3801
	Individual User	044	556-1657
	Business Sales Division (up to 400 employees)	044	556-3494
	Public Sales (Government Agencies, Education Institutions, and Medical Institutions)	044	556-3440
	Preferred Accounts Division Sales (over 400 employees)	044	556-3433
	Global Segment Japan	044	556-3469
	Large Corporate Accounts Sales (over 3500 employees)	044	556-3440
	Faxbox Service	044	556-3490
Switchboard	044	556-4300	

			Web site: <a href="http://support.jp.dell.com">http://support.jp.dell.com</a>
Korea (Seoul)	Technical Support		toll free: 080-200-3800
	Sales		toll free: 080-200-3600
	Customer Service (Penang, Malaysia)		toll free: 604-633-4949
	Customer Service (Seoul, Korea)		080-200-3800
	Fax		2194-6202
	Switchboard		2194-6000
Macau  <i>NOTE: Customers in Macau call Malaysia for customer assistance.</i>	Technical Support		toll free: 0800 582
	Customer Service (Penang, Malaysia)		633 4949
	Transaction Sales		toll free: 0800 581
Malaysia (Penang)	Technical Support		toll free: 1 800 888 298
	Customer Service	04	633 4949
	Transaction Sales		toll free: 1 800 888 202
	Corporate Sales		toll free: 1 800 888 213
New Zealand	Home and Small Business		0800 446 255
	Government and Business		0800 444 617
	Sales		0800 441 567
	Fax		0800 441 566
Singapore (Singapore)  <i>NOTE: Customers in Singapore call Malaysia for customer assistance.</i>	Technical Support		toll free: 800 6011 051
	Customer Service (Penang, Malaysia)	04	633 4949
	Transaction Sales		toll free: 800 6011 054
	Corporate Sales		toll free: 800 6011 053
South Africa (Johannesburg)	Technical Support	011	709 7710
	Customer Care	011	709 7707
	Sales	011	709 7700
	Fax	011	706 0495
	Switchboard	011	709 7700
	Web site:		

	http://support.euro.dell.com		
	E-mail: dell_za_support@dell.com		
Southeast Asian/Pacific Countries (excluding Australia, Brunei, China, Hong Kong, Japan, Korea, Macau, Malaysia, New Zealand, Singapore, Taiwan, and Thailand—refer to individual listings for these countries)	Customer Technical Support, Customer Service, and Sales (Penang, Malaysia)		60 4 633-4810
Taiwan	Technical Support		toll free: 0080 60 1225
	Technical Support (Servers)		toll free: 0080 60 1256
	Customer Service (Penang, Malaysia)		633 4949
	Transaction Sales		toll free: 0080 651 228/0800 33 556
	Corporate Sales		toll free: 0080 651 227/0800 33 555
Thailand <i>NOTE: Customers in Thailand call Malaysia for customer assistance.</i>	Technical Support		toll free: 088 006 007
	Customer Service (Penang, Malaysia)		633 4949
	Sales		toll free: 088 006 009

[Back to Contents Page](#)

# Help Overview: Dell™ Latitude™ C600/C500 User's Guide

 [Technical Assistance](#)

 [Product Information](#)

 [Help Tools](#)

 [Returning Items for Warranty Repair or Credit](#)

 [Problems With Your Order](#)

 [Before You Call](#)

---

## Technical Assistance

If you need assistance with a technical problem, perform the following steps:

1. Run the Dell Diagnostics.
2. Make a copy of the [Diagnostics Checklist](#) and fill it out.
3. Use Dell's extensive suite of online services available at Dell's World Wide Web site (<http://www.dell.com>) for help with installation and troubleshooting procedures.
4. If the preceding steps have not resolved the problem, call Dell for technical assistance.

When prompted by Dell's automated telephone system, enter your Express Service Code to route the call directly to the proper support personnel. If you do not have an Express Service Code, open the Dell Accessories folder, double-click the Express Service Code icon, and follow the directions.



*NOTE: Dell's Express Service Code system may not be available in all countries.*

For instructions on using the technical support service, see "[Technical Support Service](#)" and "[Before You Call](#)."

---

## Help Tools

Dell provides a number of tools to assist you. These tools are described in the following sections.



*NOTE: Some of the following tools are not always available in all locations outside the continental U.S. Please call your local Dell representative for information on availability.*

## World Wide Web

The Internet is your most powerful tool for obtaining information about your computer and other Dell products. Through the Internet, you can access most of the services described in this section, including AutoTech, TechFax, order status, technical support, and product information.

You can access Dell's support Web site at <http://support.dell.com>. To select your country, click the map



that appears. The Welcome to support.dell.com page opens. Enter your system information to access help tools and information.

You can contact Dell electronically by using the following addresses:

- World Wide Web

<http://www.dell.com/>

<http://www.dell.com/ap/> (for Asian/Pacific countries only)

<http://www.euro.dell.com> (for Europe only)

<http://www.dell.com/la/> (for Latin American countries)

- Anonymous file transfer protocol (FTP)

<ftp.dell.com/>

Log in as user: `anonymous`, and use your e-mail address as your password.

- Electronic Support Service

[mobile\\_support@us.dell.com](mailto:mobile_support@us.dell.com)

[support@us.dell.com](mailto:support@us.dell.com)

[apsupport@dell.com](mailto:apsupport@dell.com) (for Asian/Pacific countries only)

[support.euro.dell.com](mailto:support.euro.dell.com) (for Europe only)

- Electronic Quote Service

[sales@dell.com](mailto:sales@dell.com)

[apmarketing@dell.com](mailto:apmarketing@dell.com) (for Asian/Pacific countries only)

- Electronic Information Service

[info@dell.com](mailto:info@dell.com)

## AutoTech Service

Dell's automated technical support service—AutoTech—provides recorded answers to the questions most frequently asked by Dell customers about their portable and desktop computer systems.

When you call AutoTech, you use your touch-tone telephone to select the subjects that correspond to your questions.

The AutoTech service is available 24 hours a day, seven days a week. You can also access this service through the technical support service. For the telephone number to call, see the [contact numbers](#) for your region.

## TechFax Service

Dell takes full advantage of fax technology to serve you better. Twenty-four hours a day, seven days a week, you can call the Dell TechFax line toll-free for all kinds of technical information.

Using a touch-tone phone, you can select from a full directory of topics. The technical information you request is sent within minutes to the fax number you designate. For the TechFax telephone number to call, see the [contact numbers](#) for your region.

### Automated Order-Status System

You can call this automated service to check on the status of any Dell products that you have ordered. A recording prompts you for the information needed to locate and report on your order. For the telephone number to call, see the [contact numbers](#) for your region.

### Technical Support Service

Dell's industry-leading hardware technical support service is available 24 hours a day, seven days a week, to answer your questions about Dell hardware.

Our technical support staff pride themselves on their track record: more than 90 percent of all problems and questions are taken care of in just one toll-free call, usually in less than 10 minutes. When you call, our experts can see records kept on your Dell system to better understand your particular question. Our technical support staff uses computer-based diagnostics to provide fast, accurate answers to questions.

To contact Dell's technical support service, see "[Before You Call](#)" and then call the number for your country as listed in "[Contacting Dell](#)."

---

### Problems With Your Order

If you have a problem with your order, such as missing parts, wrong parts, or incorrect billing, contact Dell for customer assistance. Have your invoice or packing slip handy when you call. For the telephone number to call, see the [contact numbers](#) for your region.

---

### Product Information

If you need information about additional products available from Dell, or if you would like to place an order, visit Dell's World Wide Web site at <http://www.dell.com>. For the telephone number to call to speak to a sales specialist, see "[Contacting Dell](#)."

---

### Returning Items for Warranty Repair or Credit

Prepare all items being returned, whether for repair or credit, as follows:

1. Call Dell to obtain an authorization number, and write it clearly and prominently on the outside of the box.

For the telephone number to call, see the [contact numbers](#) for your region.

2. Include a copy of the invoice and a letter describing the reason for the return.
3. Include a copy of the [Diagnostics Checklist](#) indicating the tests you have run and any error messages reported by the Dell Diagnostics.
4. Include any accessories that belong with the item(s) being returned (power cables, software diskettes, guides, and so on) if the return is for credit.
5. Pack the equipment to be returned in the original (or equivalent) packing materials.

You are responsible for paying shipping expenses. You are also responsible for insuring any product returned, and you assume the risk of loss during shipment to Dell. Collect On Delivery (C.O.D.) packages are not accepted.

Returns that are missing any of the preceding requirements will be refused at our receiving dock and returned to you.

## Before You Call



*NOTE: Have your Express Service Code ready when you call. The code helps Dell's automated-support telephone system direct your call more efficiently.*

Remember to fill out the [Diagnostics Checklist](#). If possible, turn on your system before you call Dell for technical assistance and call from a telephone at or near the computer. You may be asked to type some commands at the keyboard, relay detailed information during operations, or try other troubleshooting steps possible only at the computer system itself. Make sure the system documentation is available.



**CAUTION:** If you need to remove the computer covers, be sure to first disconnect the computer system's power and modem cables from all electrical outlets.

## Diagnostics Checklist

Date:
Name:
Address:
Phone number:
Service tag (bar code on the back of the computer):
Express Service Code:
Return Material Authorization Number (if provided by Dell support technician):
Operating system and version:
Peripherals:

Expansion cards:

Are you connected to a network? Yes No

Network, version, and network card:

Programs and versions:

See your operating system documentation to determine the contents of the system's start-up files. If the computer is connected to a printer, print each file. Otherwise, record the contents of each file before calling Dell.

Error message, beep code, or diagnostic code:

Description of problem and troubleshooting procedures you performed:

[Back to Contents Page](#)