

Dell™ Inspiron™ 6000

Owner's Manual

Model PP12L

Notes, Notices, and Cautions



NOTE: A NOTE indicates important information that helps you make better use of your computer.



NOTICE: A NOTICE indicates either potential damage to hardware or loss of data and tells you how to avoid the problem.



CAUTION: A CAUTION indicates a potential for property damage, personal injury, or death.

Abbreviations and Acronyms

For a complete list of abbreviations and acronyms, see the *Dell Inspiron Help* file. To access the help file, see "Finding Information" on page 9.

If you purchased a Dell™ n Series computer, any references in this document to Microsoft® Windows® operating systems are not applicable.

Information in this document is subject to change without notice.

© 2005 Dell Inc. All rights reserved.

Reproduction in any manner whatsoever without the written permission of Dell Inc. is strictly forbidden.

Trademarks used in this text: *Dell*, the *DELL* logo, *Inspiron*, *Dell Precision*, *Dimension*, *DellNet*, *OptiPlex*, *Latitude*, *PowerEdge*, *PowerConnect*, *PowerVault*, *PowerApp*, and *Dell OpenManage* are trademarks of Dell Inc.; *Intel*, *Celeron*, and *Pentium* are registered trademarks of Intel Corporation; *Microsoft*, *Outlook*, and *Windows* are registered trademarks of Microsoft Corporation; Bluetooth is a registered trademark owned by Bluetooth SIG, Inc. and is used by Dell under license; *EMC* is a registered trademark of EMC Corporation.

Other trademarks and trade names may be used in this document to refer to either the entities claiming the marks and names or their products. Dell Inc. disclaims any proprietary interest in trademarks and trade names other than its own.

Model PP12L

July 2005

P/N D5181

Rev. A05

Contents

	Finding Information	9
1	A Tour of Your Computer	
	Front View	13
	Left Side View	17
	Right Side View	18
	Back View	19
	Bottom View	21
2	Setting Up Your Computer	
	Connecting to the Internet	23
	Setting Up Your Internet Connection	23
	Setting Up a Printer	24
	Printer Cable	24
	Connecting a USB Printer.	24
	Power Protection Devices	25
	Surge Protectors	25
	Line Conditioners	26
	Uninterruptible Power Supplies	26
3	Using a Battery	
	Battery Performance	27
	Checking the Battery Charge	28
	Dell QuickSet Battery Meter	28
	Microsoft Windows Power Meter	28
	Charge Gauge	28
	Low-Battery Warning	29

Charging the Battery	29
Removing a Battery	30
Installing a Battery	30
Storing a Battery	30
4 Using CDs, DVDs, and Other Multimedia	
Using CDs and DVDs	31
Copying CDs and DVDs	31
How to Copy a CD or DVD	31
Using Blank CD-Rs and CD-RWs	32
Helpful Tips	32
Using Dell MediaDirect	33
Connecting Your Computer to a TV or Audio Device	34
S-Video Connection	34
Composite Video Connection	35
Enabling the Display Settings for a TV	37
5 Using the Keyboard and Touch Pad	
Numeric Keypad	39
Key Combinations	40
System Functions	40
Battery	40
CD or DVD Tray	40
Display Functions	40
Radios (Including Wireless Networking and an Internal Card With Bluetooth® Wireless Technology)	40
Power Management	40
Speaker Functions	41
Microsoft® Windows® Logo Key Functions	41
Touch Pad	42
Customizing the Touch Pad	42

6	Using PC Cards	
	PC Card Types	43
	PC Card Blanks	43
	Extended PC Cards	43
	Installing a PC Card	43
	Removing a PC Card or Blank	45
7	Setting Up a Home and Office Network	
	Connecting to a Network Adapter	47
	Network Setup Wizard	48
	Connecting to a Wireless Local Area Network	48
	Determining Your Network Type	48
	Connecting to a Wireless Network in Microsoft® Windows® XP	49
8	Solving Problems	
	Dell Diagnostics	51
	When to Use the Dell Diagnostics	51
	Drive Problems	53
	DVD drive problems	53
	Hard drive problems	54
	E-Mail, Modem, and Internet Problems	55
	Error Messages	56
	IEEE 1394 Device Problems	58
	Keyboard Problems	58
	External keyboard problems	58
	Unexpected characters	59
	Lockups and Software Problems	59
	The computer does not start up	59
	The computer stops responding	60
	A program stops responding	60

A program crashes repeatedly	60
A program is designed for an earlier Windows operating system	60
A solid blue screen appears	60
Other software problems	61
Memory Problems	62
Network Problems	62
PC Card Problems	63
Power Problems	63
Printer Problems	64
Scanner Problems	65
Sound and Speaker Problems	66
No sound from integrated speakers	66
No sound from external speakers	66
No sound from headphones	67
Touch Pad or Mouse Problems	67
Video and Display Problems	68
If the display is blank	68
If the display is difficult to read	69
If only part of the display is readable	69
Drivers	69
What Is a Driver?	69
Identifying Drivers	70
Reinstalling Drivers	70
Restoring Your Operating System	71
Using Microsoft Windows XP System Restore	71
Using Dell PC Restore by Symantec	73
Resolving Software and Hardware Incompatibilities	74

9 Adding and Replacing Parts

Before You Begin	75
Recommended Tools	75
Turning Off Your Computer	75
Before Working Inside Your Computer	76

Hard Drive	77
Returning a Hard Drive to Dell	79
Memory	79
Modem	82
Wireless Mini PCI Card	84
Coin-Cell Battery	86
Display	87
Optical Drive	88
Hinge Cover	89
Keyboard	90
Internal Card With Bluetooth® Wireless Technology	91

10 Appendix



Specifications	93
Using the System Setup Program	99
Overview	99
Viewing the System Setup Screen	99
System Setup Screen	99
Commonly Used Options	99
Dell Technical Support Policy (U.S. Only)	101
Definition of "Dell-Installed" Software and Peripherals	101
Definition of "Third-Party" Software and Peripherals	101
FCC Notices (U.S. Only)	101
Class A	102
Class B	102
FCC Identification Information	102
Macrovision Product Notice	103
Contacting Dell	103

Index	121
------------------------	------------

Finding Information

 **NOTE:** Some features may not be available for your computer or in certain countries.

 **NOTE:** Additional information may ship with your computer.

What Are You Looking For?	Find It Here
<ul style="list-style-type: none">• Warranty information• Terms and Conditions (U.S. only)• Safety instructions• Regulatory information• Ergonomics information• End User License Agreement	<p data-bbox="725 409 1289 440">Dell™ Product Information Guide</p> 
<ul style="list-style-type: none">• How to set up my computer	<p data-bbox="725 760 1289 791">Setup Diagram</p> 
<ul style="list-style-type: none">• Tips on using Microsoft® Windows®• How to play CDs and DVDs• How to use standby mode and hibernate mode• How to change my display resolution• How to clean my computer	<p data-bbox="725 1274 1289 1305">Help File</p> <ol style="list-style-type: none"><li data-bbox="736 1308 1289 1340">1 Click the Start button and click Help and Support.<li data-bbox="736 1343 1289 1374">2 Click User and system guides and click User's guides.<li data-bbox="736 1378 1289 1409">3 Click Dell Inspiron Help.

What Are You Looking For?

- Service Tag and Express Service Code
- Microsoft Windows License Label

Find It Here**Service Tag and Microsoft Windows License**

These labels are located on [the bottom](#) of your computer.

- Use the Service Tag to identify your computer when you use [support.dell.com](#) or contact technical support.

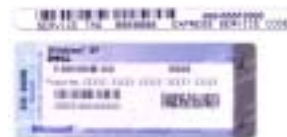

- Enter the Express Service Code to direct your call when contacting technical support.

-
- Solutions — Troubleshooting hints and tips, articles from technicians, online courses, frequently asked questions
 - Community — Online discussion with other Dell customers
 - Upgrades — Upgrade information for components, such as memory, the hard drive, and the operating system
 - Customer Care — Contact information, service call and order status, warranty, and repair information
 - Service and support — Service call status and support history, service contract, online discussions with technical support
 - Reference — Computer documentation, details on my computer configuration, product specifications, and white papers

Dell Support Website — [support.dell.com](#)

NOTE: Select your region to view the appropriate support site.

NOTE: Corporate, government, and education customers can also use the customized Dell Premier Support website at [premier.support.dell.com](#). The website may not be available in all regions.

What Are You Looking For?	Find It Here
<ul style="list-style-type: none"> • Downloads — Certified drivers, patches, and software updates • Notebook System Software (NSS)— If you reinstall the operating system for your computer, you should also reinstall the NSS utility. NSS provides critical updates for your operating system and support for Dell™ 3.5-inch USB floppy drives, Intel® Pentium® M processors, optical drives, and USB devices. NSS is necessary for correct operation of your Dell computer. The software automatically detects your computer and operating system and installs the updates appropriate for your configuration. <p>To download Notebook System Software:</p> <ol style="list-style-type: none"> 1 Go to support.dell.com and click Downloads. 2 Enter your Service Tag or product model. 3 In the Download Category drop-down menu, click All. 4 Select the operating system and operating system language for your computer, and click Submit. 5 Under Select a Device, scroll to System and Configuration Utilities, and click Dell Notebook System Software. 	
<ul style="list-style-type: none"> • How to use Windows XP • Documentation for my computer • Documentation for devices (such as a modem) 	<p>Windows Help and Support Center</p> <ol style="list-style-type: none"> 1 Click the Start button and click Help and Support. 2 Type a word or phrase that describes your problem and click the arrow icon. 3 Click the topic that describes your problem. 4 Follow the instructions on the screen.

A Tour of Your Computer

Front View

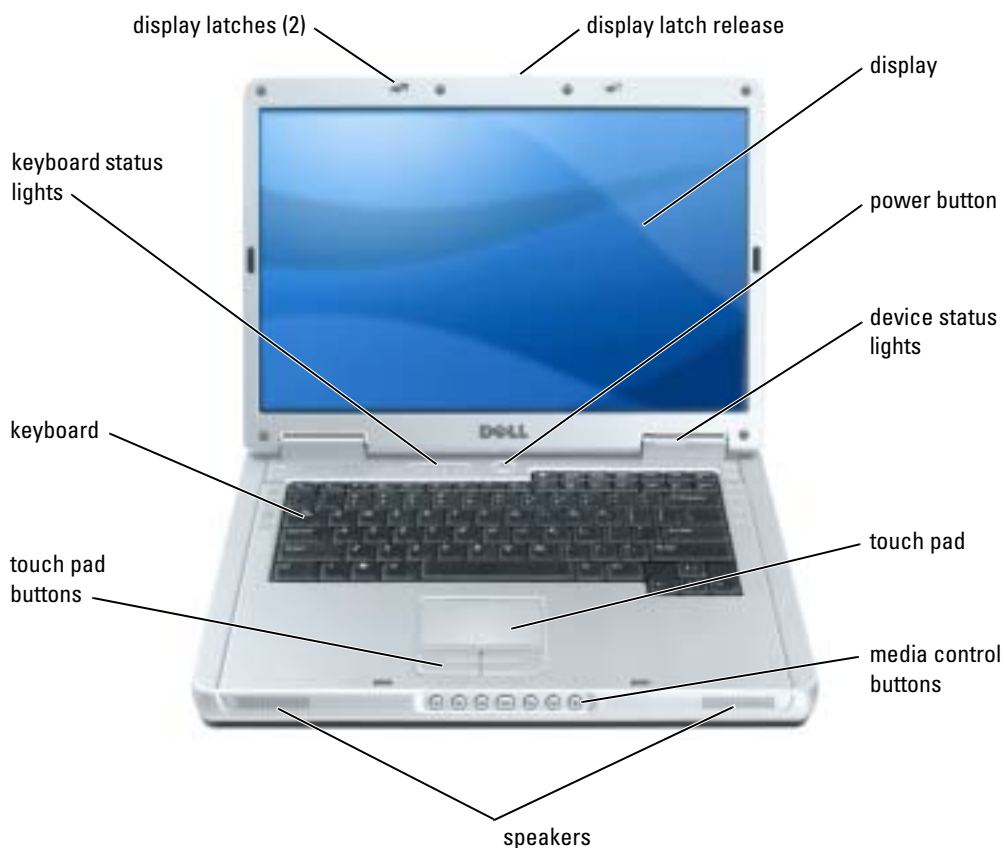

DISPLAY LATCHES — Keeps the display closed.

DISPLAY LATCH RELEASE — Press this to release the display latches and open the display.

DISPLAY — For more information about your display, see the *Dell Inspiron Help* file. To access the help file, see "Finding Information" on page 9.

POWER BUTTON — Press the power button to turn on the computer or to enter or exit a power management mode.

NOTICE: To avoid losing data when you turn off your computer, shut down your computer through the **Start** menu instead of pressing the power button.

DEVICE STATUS LIGHTS



 Turns on when you turn on the computer, and blinks when the computer is in a power management mode.

 Turns on when the computer reads or writes data.

NOTICE: To avoid loss of data, never turn off the computer while the  light is flashing.

 Turns on steadily or blinks to indicate battery charge status.

If the computer is connected to an electrical outlet, the  light operates as follows:

- Solid green: The battery is charging.
- Flashing green: The battery is almost fully charged.







If the computer is running on a battery, the  light operates as follows:

- Off: The battery is adequately charged (or the computer is turned off).
- Flashing orange: The battery charge is low.
- Solid orange: The battery charge is critically low.

TOUCH PAD — Provides the functionality of a mouse.

MEDIA CONTROL BUTTONS — Control CD, DVD, and Media Player playback.



-  Mutes the sound.
-  Turns the volume down.
-  Turns the volume up.
-  Play or pause. This button also launches Dell Media Experience or Microsoft® Windows® Media Center Edition. See "Using Dell MediaDirect" on page 33.
-  Plays the previous track.
-  Plays the next track.
-  Stop.

SPEAKERS — To adjust the volume of the integrated speakers, press the media control buttons or speaker-volume keyboard shortcuts. For more information, see page 41.





TOUCH PAD BUTTONS — Touch pad buttons provide the functionality of a mouse.

KEYBOARD — The keyboard includes a numeric keypad as well as the Microsoft Windows logo key. For information on supported keyboard shortcuts, see "Key Combinations" on page 40.

KEYBOARD STATUS LIGHTS



The green lights located above the keyboard indicate the following:

-  Turns on when the numeric keypad is enabled.
-  Turns on when the uppercase letter function is enabled.
-  Turns on when the scroll lock function is enabled.
-  Turns on when wireless networking is enabled. To enable or disable wireless networking, press <Fn><F2>.
-  Turns on when a card with Bluetooth® wireless technology is enabled.

NOTE: The card with Bluetooth wireless technology is an optional feature, so the  light turns on only if you ordered the card with your computer. For more information, see the documentation that came with your card.

To turn off only the Bluetooth wireless technology functionality, right-click the  icon in the notification area and click **Disable Bluetooth Radio**.

To quickly enable or disable all wireless devices, press <Fn><F2>.

Left Side View

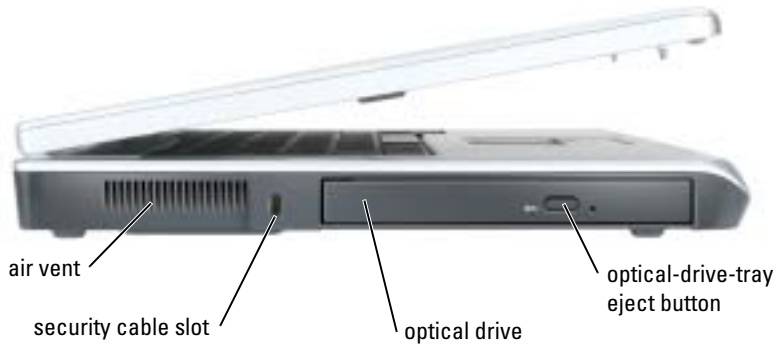

AIR VENT — The computer uses fans to create airflow through the vents, which prevents the computer from overheating.

CAUTION: Do not block, push objects into, or allow dust to accumulate in the air vents. Do not store your computer in a low-airflow environment, such as a closed briefcase, while it is running. Restricting the airflow can damage the computer or cause a fire.

SECURITY CABLE SLOT — Lets you attach a commercially available antitheft device to the computer. For more information, see the instructions included with the device.

NOTICE: Before you buy an antitheft device, ensure that it will work with the security cable slot.



OPTICAL-DRIVE-TRAY EJECT BUTTON — Press this button to eject a CD and DVD from the optical drive.

OPTICAL DRIVE — You can install devices such as a DVD drive or other optical drive in the optical drive bay. For more information, see "Using CDs and DVDs" on page 31.

Right Side View

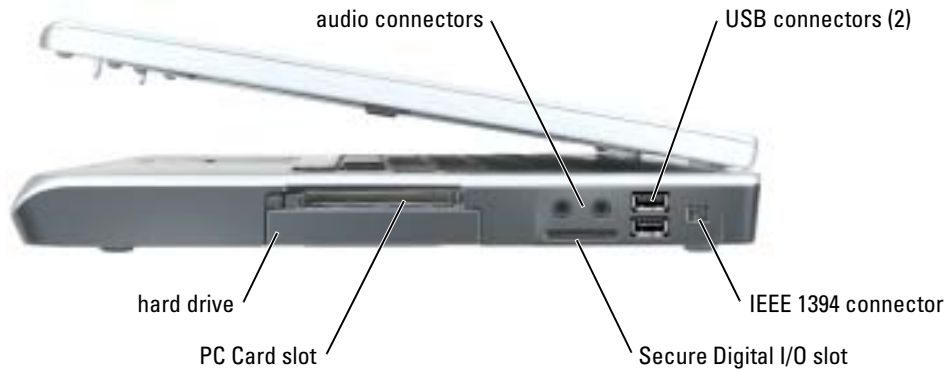

AUDIO CONNECTORS



Attach headphones or speakers to the  connector.

Attach a microphone to the  connector.

USB CONNECTORS — Connect USB devices, such as a mouse, keyboard, or printer. You can also connect the optional floppy drive directly to a USB connector using the optional floppy-drive cable.

IEEE 1394 CONNECTOR — Connects devices supporting IEEE 1394 high-speed transfer rates, such as some digital video cameras.

SECURE DIGITAL I/O SLOT — The Secure Digital I/O slot supports one Secure Digital memory card or other SD I/O device. Use Secure Digital memory cards to save or back up data.

PC CARD SLOT — Supports one PC Card, such as a modem or network adapter. The computer ships with a plastic blank installed in the slot. For more information, see the *Dell™ Inspiron™ Help* file. To access the help file, see "Finding Information" on page 9.

HARD DRIVE — Stores software and data.

Back View

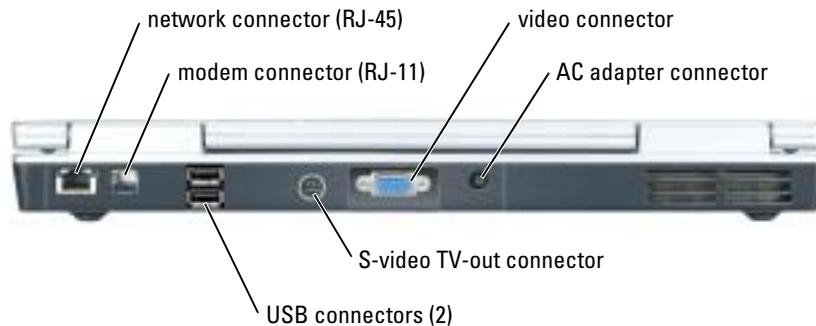

NETWORK CONNECTOR (RJ-45)

NOTICE: The network connector is slightly larger than the modem connector. To avoid damaging the computer, do not plug a telephone line into the network connector.

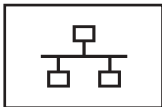

Connects the computer to a network. The green and yellow lights next to the connector indicate activity for wired network communications.

For information on using the network adapter, see the online network adapter documentation supplied with your computer.

MODEM CONNECTOR (RJ-11)



To use the internal modem, connect the telephone line to the modem connector.

For additional information on using the modem, see the online modem documentation supplied with your computer.

USB CONNECTORS

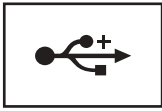

Connect USB devices, such as a mouse, keyboard, or printer.

S-VIDEO TV-OUT CONNECTOR



Connects your computer to a TV. Also connects digital audio capable devices using the TV/digital audio adapter cable.

VIDEO CONNECTOR



Connects an external VGA-compatible monitor. For more information, see the *Dell Inspiron Help* file. To access the help file, see "Finding Information" on page 9.

AC ADAPTER CONNECTOR — Attaches an AC adapter to the computer.



The AC adapter converts AC power to the DC power required by the computer. You can connect the AC adapter with your computer turned either on or off.

⚠ CAUTION: The AC adapter works with electrical outlets worldwide. However, power connectors and power strips vary among countries. Using an incompatible cable or improperly connecting the cable to the power strip or electrical outlet may cause fire or equipment damage.

🔄 NOTICE: When you disconnect the AC adapter cable from the computer, grasp the connector, not the cable itself, and pull firmly but gently to avoid damaging the cable.

Bottom View

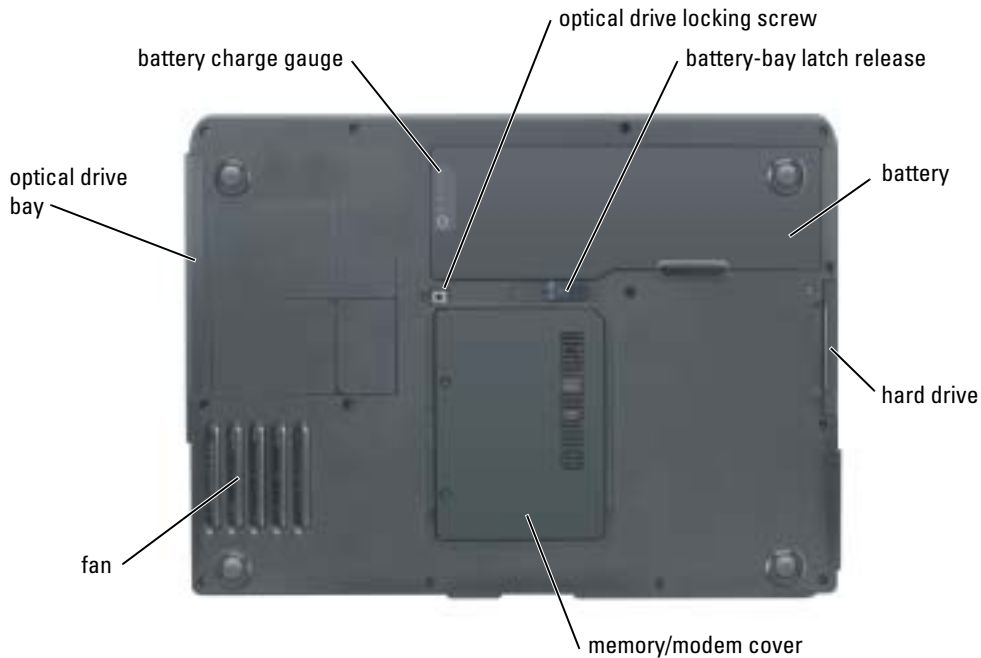

OPTICAL DRIVE LOCKING SCREW — Secures the optical drive in the optical drive bay. For more information, see "Optical Drive" on page 88.

BATTERY-BAY LATCH RELEASE — Releases the battery from the battery bay. See "Removing a Battery" on page 30.

BATTERY — When a battery is installed, you can use the computer without connecting the computer to an electrical outlet. For more information, see "Using a Battery" on page 27.

HARD DRIVE — Stores software and data. For more information, see "Hard Drive" on page 77 and "Hard drive problems" on page 54.

MEMORY/MODEM COVER — Covers the compartment that contains the memory and modem. For more information, see page 79.

FAN — The computer uses fans to create airflow through the vents, which prevents the computer from overheating.

OPTICAL DRIVE BAY — You can install devices such as a DVD drive or other optical drive in the optical drive bay. For more information, see "Optical Drive" on page 88.

BATTERY CHARGE GAUGE — Provides information on the battery charge. For more information, see "Using a Battery" on page 27.

Setting Up Your Computer

Connecting to the Internet

 **NOTE:** ISPs and ISP offerings vary by country.

To connect to the Internet, you need a modem or network connection and an Internet service provider (ISP), such as AOL or MSN. Your ISP will offer one or more of the following Internet connection options:

- Dial-up connections that provide Internet access through a telephone line. Dial-up connections are considerably slower than DSL and cable modem connections.
- DSL connections that provide high-speed Internet access through your existing telephone line. With a DSL connection, you can access the Internet and use your telephone on the same line simultaneously.
- Cable modem connections that provide high-speed Internet access through your local cable TV line.

If you are using a dial-up connection, connect a telephone line to the modem connector on your computer and to the telephone wall jack before you set up your Internet connection. If you are using a DSL or cable modem connection, contact your ISP for setup instructions.

Setting Up Your Internet Connection

To set up an AOL or MSN connection:

- 1 Save and close any open files, and exit any open programs.
- 2 Double-click the **MSN Explorer** or **AOL** icon on the Microsoft® Windows® desktop.
- 3 Follow the instructions on the screen to complete the setup.

If you do not have an **MSN Explorer** or **AOL** icon on your desktop or if you want to set up an Internet connection with a different ISP:

- 1 Save and close any open files, and exit any open programs.
- 2 Click the **Start** button and click **Internet Explorer**.
The **New Connection Wizard** appears.
- 3 Click **Connect to the Internet**.

4 In the next window, click the appropriate option:

- If you do not have an ISP and want to select one, click **Choose from a list of Internet service providers (ISPs)**.
- If you have already obtained setup information from your ISP but you did not receive a setup CD, click **Set up my connection manually**.
- If you have a CD, click **Use the CD I got from an ISP**.

5 Click **Next**.

If you selected **Set up my connection manually**, continue to step 6. Otherwise, follow the instructions on the screen to complete the setup.

 **NOTE:** If you do not know which type of connection to select, contact your ISP.

6 Click the appropriate option under **How do you want to connect to the Internet?**, and then click **Next**.

7 Use the setup information provided by your ISP to complete the setup.

If you are having problems connecting to the Internet, see "E-Mail, Modem, and Internet Problems" on page 55. If you cannot connect to the Internet but have successfully connected in the past, the ISP might have a service outage. Contact your ISP to check the service status, or try connecting again later.

Setting Up a Printer

 **NOTICE:** Complete the operating system setup before you connect a printer to the computer.

See the documentation that came with the printer for setup information, including how to:

- Obtain and install updated drivers.
- Connect the printer to the computer.
- Load paper and install the toner or ink cartridge.
- Contact the printer manufacturer for technical assistance.

Printer Cable

Your printer connects to your computer with a USB cable. Your printer may not come with a printer cable, so if you purchase a cable separately, ensure that it is compatible with your printer. If you purchased a printer cable at the same time you purchased your computer, the cable may arrive in the computer box.

Connecting a USB Printer

 **NOTE:** You can connect USB devices while the computer is turned on.

- 1 Complete the operating system setup if you have not already done so.
- 2 Install the printer driver if necessary. See the documentation that came with your printer.
- 3 Attach the USB printer cable to the USB connectors on the computer and the printer. The USB connectors fit only one way.

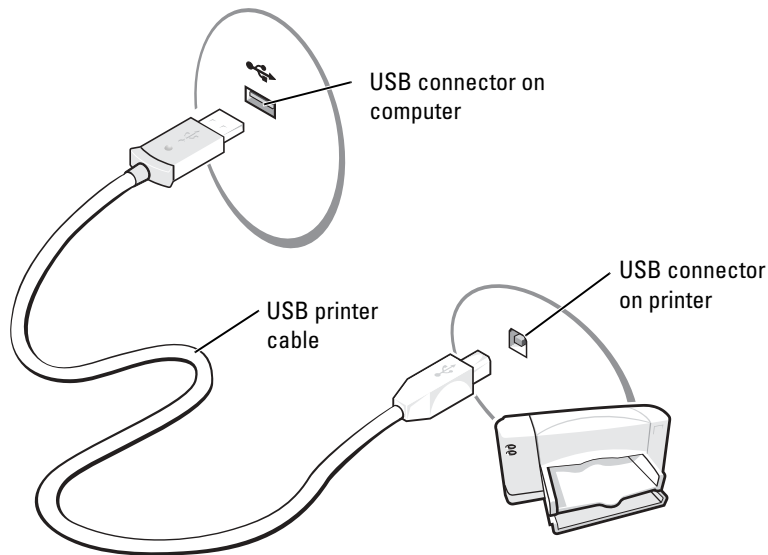

Power Protection Devices

Several devices are available to protect against power fluctuations and failures:

- Surge protectors
- Line conditioners
- Uninterruptible power supplies (UPS)

Surge Protectors

Surge protectors and power strips equipped with surge protection help to prevent damage to your computer from voltage spikes that can occur during electrical storms or following power interruptions. The level of protection is usually commensurate with the cost of the surge protector. Some surge protector manufacturers include warranty coverage for certain types of damage. Carefully read the device warranty when choosing a surge protector. A device with a higher joule rating offers more protection. Compare joule ratings to determine the relative effectiveness of different devices.

NOTICE: Most surge protectors do not protect against power fluctuations or power interruptions caused by nearby lightning strikes. When lightning occurs in your area, disconnect the telephone line from the telephone wall jack and disconnect your computer from the electrical outlet.

Many surge protectors have a telephone jack for modem protection. See the surge protector documentation for modem connection instructions.

NOTICE: Not all surge protectors offer network adapter protection. Disconnect the network cable from the network wall jack during electrical storms.

Line Conditioners

 **NOTICE:** Line conditioners do not protect against power interruptions.

Line conditioners are designed to maintain AC voltage at a fairly constant level.

Uninterruptible Power Supplies

 **NOTICE:** Loss of power while data is being saved to the hard drive may result in data loss or file damage.

 **NOTE:** To ensure maximum battery operating time, connect only your computer to a UPS. Connect other devices, such as a printer, to a separate power strip that provides surge protection.

A UPS protects against power fluctuations and interruptions. UPS devices contain a battery that provides temporary power to connected devices when AC power is interrupted. The battery charges while AC power is available. See the UPS manufacturer documentation for information on battery operating time and to ensure that the device is approved by Underwriters Laboratories (UL).

Using a Battery

Battery Performance

 **CAUTION:** Before you begin any of the procedures in this chapter, follow the safety instructions in the *Product Information Guide*.

For optimal computer performance and to help preserve BIOS settings, operate your Dell™ portable computer with the main battery installed at all times. Use a battery to run the computer when it is not connected to an electrical outlet. One battery is supplied as standard equipment in the battery bay.

 **NOTE:** Battery operating time (the time the battery can hold a charge) decreases over time. Depending on how often the battery is used and the conditions under which it is used, you may need to purchase a new battery during the life of your computer.

Battery operating time varies depending on operating conditions. Operating time is significantly reduced when you perform operations including, but not limited to, the following:

- Using DVD+RW/DVD+R drives
- Using wireless communications devices, PC Cards, or USB devices
- Using high-brightness display settings, 3D screen savers, or other power-intensive programs such as 3D games
- Running the computer in maximum performance mode. For more information, see the *Dell Inspiron Help* file. To access the help file, see "Finding Information" on page 9.

 **NOTE:** It is recommended that you connect your computer to an electrical outlet when writing to a CD or DVD.

You can check the battery charge before you insert the battery into the computer. You can also set power management options to alert you when the battery charge is low.

 **CAUTION:** Using an incompatible battery may increase the risk of fire or explosion. Replace the battery only with a compatible battery purchased from Dell. The lithium-ion battery is designed to work with your Dell computer. Do not use a battery from other computers with your computer.

 **CAUTION:** Do not dispose of batteries with household waste. When your battery no longer holds a charge, call your local waste disposal or environmental agency for advice on disposing of a lithium-ion battery. See "Battery Disposal" in the *Product Information Guide*.

 **CAUTION:** Misuse of the battery may increase the risk of fire or chemical burn. Do not puncture, incinerate, disassemble, or expose the battery to temperatures above 65°C (149°F). Keep the battery away from children. Handle damaged or leaking batteries with extreme care. Damaged batteries may leak and cause personal injury or equipment damage.

Checking the Battery Charge

The Dell QuickSet Battery Meter, the Microsoft® Windows® **Power Meter** window and  icon, the battery charge gauge, and the low-battery warning provide information on the battery charge.

Dell QuickSet Battery Meter

If Dell QuickSet is installed, press <Fn><F3> to display the QuickSet Battery Meter. For more information about Dell QuickSet, see the *Dell Inspiron Help* file. To access the help file, see "Finding Information" on page 9.

The **Battery Meter** window displays status, charge level, and charge completion time for the battery in your computer.

The following icons appear in the **Battery Meter** window:



The computer or docking device is running on battery power.



The computer is connected to AC power and the battery is charging.



The computer is connected to AC power and the battery is fully charged.

For more information about QuickSet, right-click the  icon in the taskbar, and click **Help**.

Microsoft Windows Power Meter

The Windows Power Meter indicates the remaining battery charge. To check the Power Meter, double-click the  icon on the taskbar. For more information about the **Power Meter** tab, see "Power Management" in the *Dell Inspiron Help* file. To access the help file, see "Finding Information" on page 9.

If the computer is connected to an electrical outlet, a  icon appears.

Charge Gauge

Press the status button on the battery charge gauge to illuminate the charge-level lights. Each light represents approximately 20 percent of the total battery charge. For example, if the battery has 80 percent of its charge remaining, four of the lights are on. If no lights appear, the battery has no charge.

Low-Battery Warning



NOTICE: To avoid losing or corrupting data, save your work immediately after a low-battery warning. Then connect the computer to an electrical outlet. If the battery runs completely out of power, hibernate mode begins automatically.

A pop-up window warns you when the battery charge is approximately 90 percent depleted. For more information about low-battery alarms, see "Power Management" in the *Dell Inspiron Help* file. To access the help file, see "Finding Information" on page 9.

Charging the Battery



NOTE: The AC adapter charges a completely discharged battery in approximately 2 hours with the computer turned off. Charge time is longer with the computer turned on. You can leave the battery in the computer as long as you like. The battery's internal circuitry prevents the battery from overcharging.

When you connect the computer to an electrical outlet or install a battery while the computer is connected to an electrical outlet, the computer checks the battery charge and temperature. If necessary, the AC adapter then charges the battery and maintains the battery charge.

If the battery is hot from being used in your computer or being in a hot environment, the battery may not charge when you connect the computer to an electrical outlet.

The battery is too hot to start charging if the  light flashes alternately green and orange. Disconnect the computer from the electrical outlet and allow the computer and the battery to cool to room temperature. Then connect the computer to an electrical outlet to continue charging the battery.

For more information about resolving problems with a battery, see "Power Problems" on page 63.

Removing a Battery

⚠ CAUTION: Before performing these procedures, disconnect the modem from the telephone wall jack.

- 1 Ensure that the computer is turned off.
- 2 Slide and hold the battery-bay latch release on the bottom of the computer, and then remove the battery from the bay.

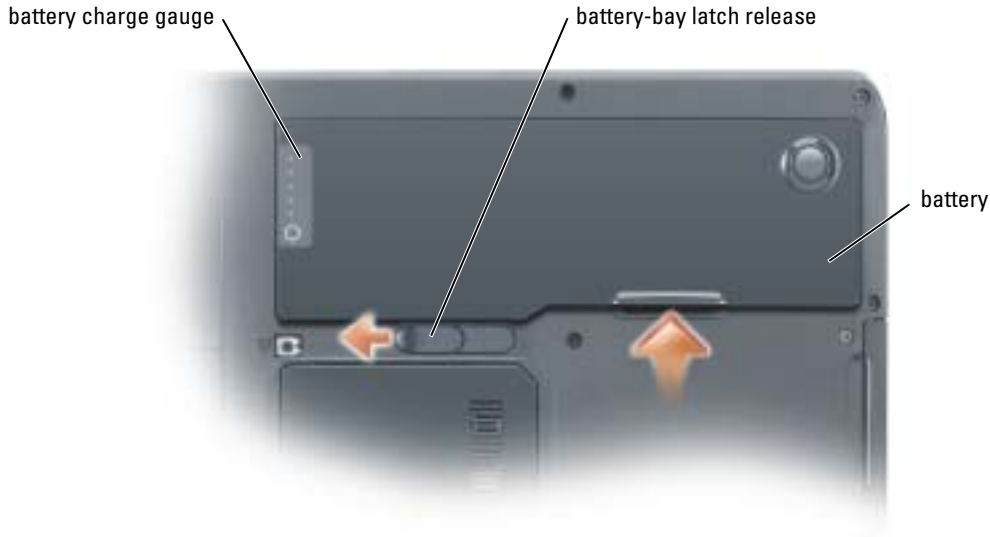

Installing a Battery

⚠ CAUTION: Using an incompatible battery may increase the risk of fire or explosion. Replace the battery only with a compatible battery purchased from Dell. The lithium-ion battery is designed to work with your Dell computer. Do not use a battery from other computers with your computer.

- 1 Slide the battery into the bay at a 45-degree angle.
- 2 Press the other side down until the latch release clicks.

Storing a Battery

Remove the battery when you store your computer for an extended period of time. A battery discharges during prolonged storage. After a long storage period, recharge the battery fully before you use it.

Using CDs, DVDs, and Other Multimedia

Using CDs and DVDs

For information about using CDs and DVDs in your computer, see the *Dell™ Inspiron™ Help* file. To access the help file, see "Finding Information" on page 9.

Copying CDs and DVDs

 **NOTE:** Ensure that you follow all copyright laws when you create CDs or DVDs.

This section applies only to computers that have a DVD-ROM, DVD+RW, DVD+R, DVD-R, or DVD/CD-RW combo drive.

The following instructions show how to make an exact copy of a CD or DVD. You can also use Sonic RecordNow for other purposes, including creating CDs from audio files on your computer and creating MP3 CDs. For instructions, see the Sonic RecordNow documentation that came with your computer. Open Sonic RecordNow, click the question mark icon in the upper-right corner of the window, and then click **RecordNow Help** or **RecordNow Tutorial**.

How to Copy a CD or DVD

 **NOTE:** If you have a DVD/CD-RW combo drive and you experience recording problems, check for available software patches at the Sonic support website at support.sonic.com.

Currently, five DVD-writable disc formats are available: DVD+R, DVD+RW, DVD-R, DVD-RW, and DVD-RAM. The DVD-writable drives installed in Dell™ computers can write to DVD+R and DVD+RW media, and they can read DVD-R and DVD-RW media. However, DVD-writable drives do not write to and might not read DVD-RAM media. In addition, commercially available DVD players for home theater systems might not read all five formats.

 **NOTE:** Most commercial DVDs have copyright protection and cannot be copied using Sonic RecordNow.

- 1 Click the **Start** button, point to **All Programs**→**Sonic**→**RecordNow!**, and then click **RecordNow!**
- 2 Click either the audio tab or the data tab, depending on the kind of CD or DVD you want to copy.

3 Click **Exact Copy**.

4 To copy a CD or DVD:

- *If you have one CD or DVD drive*, ensure that the settings are correct and click **Copy**. The computer reads your source CD or DVD and copies it to a temporary folder on your computer hard drive.

When prompted, insert a blank CD or DVD into the CD or DVD drive and click **OK**.

- *If you have two CD or DVD drives*, select the drive into which you have inserted your source CD or DVD and click **Copy**. The computer copies the data on the CD or DVD to the blank CD or DVD.

When you have finished copying the source CD or DVD, the CD or DVD that you have created automatically ejects.

Using Blank CD-Rs and CD-RWs

Your CD-RW drive can write to two different types of recording media—CD-Rs and CD-RWs (including high-speed CD-RWs). Use blank CD-Rs to record music or permanently store data files. After creating a CD-R, you cannot write to that CD-R again without changing your method of recording (see the Sonic documentation for more information). Use blank CD-RWs to write to CDs or to erase, rewrite, or update data on CDs.

Your DVD-writable drive can write to four different types of recording media—CD-Rs, CD-RWs (including high-speed CD-RWs), DVD+Rs, and DVD+RWs. Blank DVD+Rs can be used to permanently store large amounts of information. After you create a DVD+R disc, you may not be able to write to that disc again if the disc is "finalized" or "closed" during the final stage of the disc creation process. Use blank DVD+RWs if you plan to erase, rewrite, or update information on that disc later.

Helpful Tips

- Use Microsoft® Windows® Explorer to drag and drop files to a CD-R or CD-RW only after you start Sonic RecordNow and open a RecordNow project.
- You must use CD-Rs to burn music CDs that you want to play in regular stereos. CD-RWs do not play in most home or car stereos.
- You cannot create audio DVDs with Sonic RecordNow.
- Music MP3 files can be played only on MP3 players or on computers that have MP3 software installed.
- Do not burn a blank CD-R or CD-RW to its maximum capacity; for example, do not copy a 650-MB file to a 650-MB blank CD. The CD-RW drive needs 1 or 2 MB of the blank CD to finalize the recording.
- Use a blank CD-RW to practice CD recording until you are familiar with CD recording techniques. If you make a mistake, you can erase the data on the CD-RW and try again. You can also use blank CD-RWs to test music file projects before you record the project permanently to a blank CD-R.
- See the Sonic support website at support.sonic.com for additional information.

Using Dell MediaDirect

 **NOTE:** QuickSet, which is automatically installed and enabled on your computer, is necessary for Dell MediaDirect to function. Changing or disabling QuickSet's default settings can limit Dell MediaDirect's functionality. For more information about Dell QuickSet, see the Dell Inspiron Help file. To access the help file, see "Finding Information" on page 9.

If you have Microsoft Windows Media Center Edition or Dell Media Experience installed, you can use Dell MediaDirect to launch your media application by pressing the play/pause/Dell MediaDirect button ►/||.

- If you hold the media control play button for longer than two seconds while you are logged in, Dell MediaDirect launches Microsoft Windows Media Center Edition or Dell Media Experience, depending on your system setup. If both applications are present, Windows Media Center Edition will launch.
- When your computer is open, you can press the media control play button to start the computer from any state and automatically launch the media application.

 **NOTE:** For optimal efficiency, launch from hibernate or standby mode.



play/pause/Dell MediaDirect button

Connecting Your Computer to a TV or Audio Device

NOTE: Video and audio cables for connecting your computer to a TV or other audio device are not included with your computer. Cables may be purchased at most consumer electronics stores. The composite TV-out adapter cable is available for purchase from Dell.

Your TV has either an S-video input connector or a composite video-input connector. Depending on what type of connector is available on your TV, you can use a commercially available S-video cable or composite video cable to connect your computer to your TV. For a TV with only a composite video-input connector, you must also use a composite TV-out adapter cable, which is available from Dell.

The audio connector on the side of the computer enables you to connect the computer to your TV or audio device, using a commercially available audio cable.

NOTE: See the diagrams at the beginning of each subsection to help you determine which method of connection you should use.

When you finish connecting the video and audio cables between your computer and your TV, you must enable your computer to work with the TV. See "Enabling the Display Settings for a TV" on page 37 to ensure that the computer recognizes and works properly with the TV.

S-Video Connection

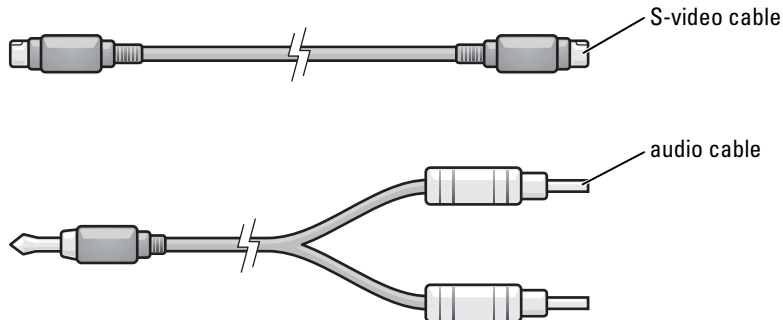

- 1 Turn off the computer and the TV and/or audio device that you want to connect.
- 2 Plug one end of the S-video cable in to the S-video TV-out connector on the computer.

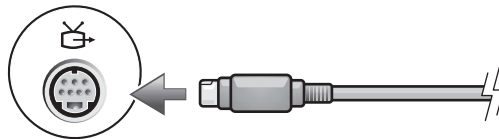

- 3 Plug the other end of the S-video cable in to the S-video input connector on your TV.

- 4 Plug the single-connector end of the audio cable in to the headphone connector on your computer.

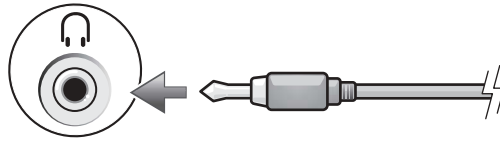

- 5 Plug the two RCA connectors on the other end of the audio cable in to the audio input connectors on your TV or other audio device.
- 6 Turn on the TV, turn on any audio device that you connected (if applicable), and then turn on the computer.
- 7 See "Enabling the Display Settings for a TV" on page 37 to ensure that the computer recognizes and works properly with the TV.

Composite Video Connection

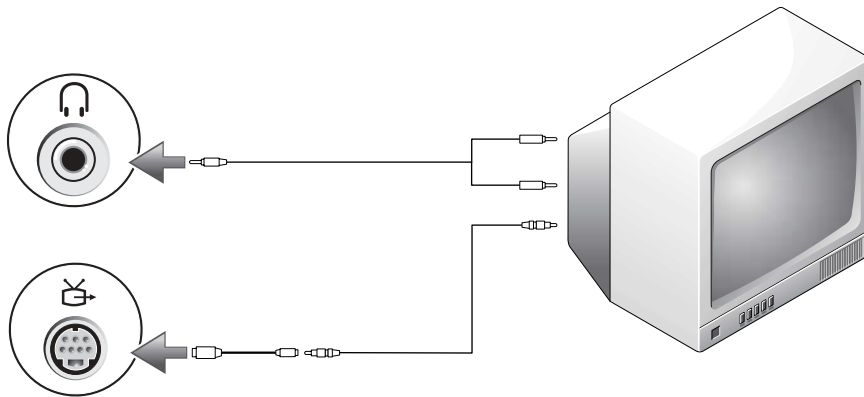

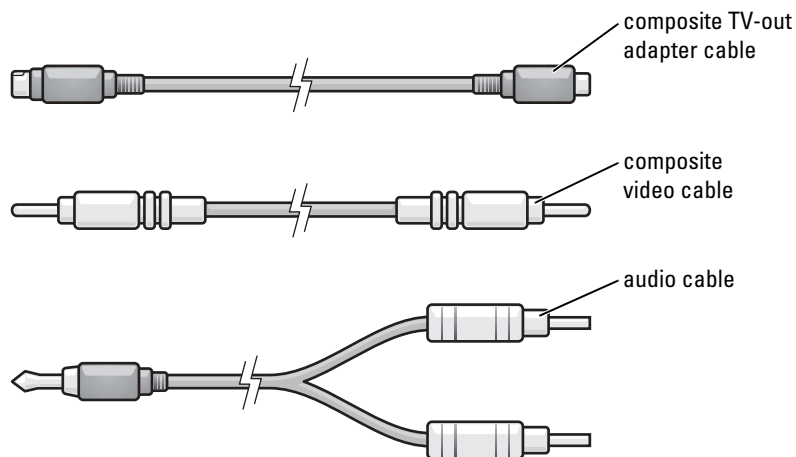

- 1 Turn off the computer and the TV and/or audio device that you want to connect.
- 2 Connect the composite TV-out adapter cable to the S-video TV-out connector on the computer.

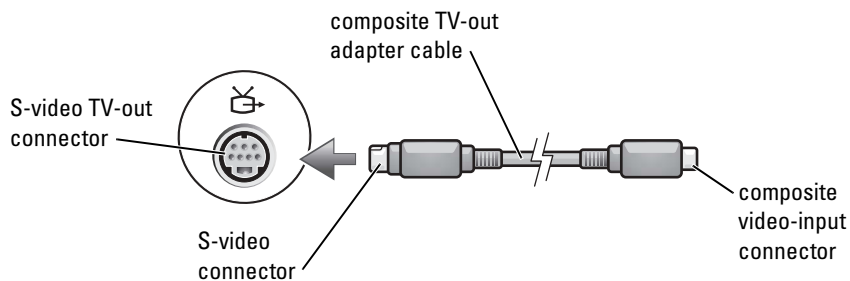

- 3 Plug one end of the composite video cable in to the composite video-input connector on the composite TV-out adapter cable.



- 4 Plug the other end of the composite video cable in to the composite video-input connector on the TV.

- 5 Plug the single-connector end of the audio cable in to the headphone connector on the computer.

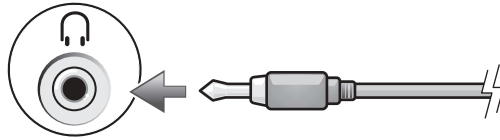

- 6 Plug the two RCA connectors on the other end of the audio cable in to the audio input connectors on your TV or other audio device.
- 7 Turn on the TV and any audio device that you connected (if applicable), and then turn on the computer.
- 8 See "Enabling the Display Settings for a TV" on page 37 to ensure that the computer recognizes and works properly with the TV.

Enabling the Display Settings for a TV

Your computer may have either a video-controller card or a video controller on the system board (known as an *integrated* video controller). See the following subsection that corresponds to the video controller installed in your computer.

Video-Controller Card

 **NOTE:** Ensure that you properly connect the TV before you enable the display settings.

- 1 Click the **Start** button and click **Control Panel**.
- 2 Click **Appearances and Themes**.
- 3 Under or pick a **Control Panel** icon, click **Display**.
- 4 Click the **Settings** tab and click **Advanced**.
- 5 Click the **Displays** tab.
- 6 Click the upper-left corner of the **TV** button to enable the TV.
- 7 Click **OK**.

Integrated Video Controller



NOTE: Ensure that you properly connect the TV before you enable the display settings.

- 1 Click the **Start** button and click **Control Panel**.
- 2 Double-click the **Intel (R) GMA Driver for Mobile** icon.
- 3 *If you want to use only a TV without using the computer display or any other display options:*
 - a In the **Intel (R) Graphics Media Accelerator** window, click **TV**.
 - b Click **Display Settings** and ensure that the settings are correct.

If you want to use a TV and the computer display at the same time:

- a In the **Intel (R) Graphics Media Accelerator** window, click **Intel (R) Dual Display Clone** and ensure that one of the devices listed is a TV.
 - b Click **Display Settings** and ensure that the settings are correct.
- 4 Click **Apply** to view the new settings.
 - 5 Click **OK** to confirm the settings change.
 - 6 Click **OK** to close the **Intel (R) Graphics Media Accelerator** window.

For more information, click **Information** in the **Intel (R) Graphics Media Accelerator** window, and then click the **Support** tab.

Using the Keyboard and Touch Pad

Numeric Keypad

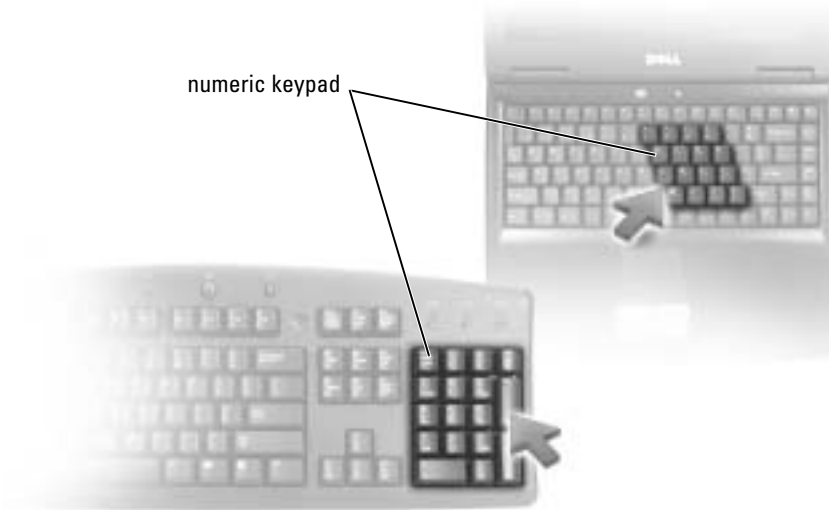

The numeric keypad functions like the numeric keypad on an external keyboard. Each key on the keypad has multiple functions. The keypad numbers and symbols are marked in blue on the right of the keypad keys. To type a number or symbol, press <Fn> and the desired key after enabling the keypad.

- To enable the keypad, press <Num Lk>. The  light indicates that the keypad is active.
- To disable the keypad, press <Num Lk> again.

Key Combinations

System Functions

<Ctrl><Shift><Esc>	Opens the Task Manager window
--------------------	--------------------------------------

Battery

<Fn><F3>	Displays the Dell™ QuickSet Battery Meter. For more information about Dell QuickSet, see the <i>Dell Inspiron Help</i> file. To access the help file, see "Finding Information" on page 9.
----------	--

CD or DVD Tray

<Fn><F10>	Ejects the tray out of the drive (if Dell QuickSet is installed). For more information about Dell QuickSet, see the <i>Dell Inspiron Help</i> file. To access the help file, see "Finding Information" on page 9.
-----------	---

Display Functions

<Fn><F8>	Switches the video image to the next display option. The options include the integrated display, an external monitor, and both displays simultaneously.
<Fn> and up-arrow key	Increases brightness on the integrated display only (not on an external monitor).
<Fn> and down-arrow key	Decreases brightness on the integrated display only (not on an external monitor).

Radios (Including Wireless Networking and an Internal Card With Bluetooth® Wireless Technology)

<Fn><F2>	Enables and disables radios, including wireless networking and Bluetooth wireless technology
----------	--

Power Management

<Fn><Esc>	Activates a power management mode. You can reprogram this keyboard shortcut to activate a different power management mode using the Advanced tab in the Power Options Properties window. See "Power Management" in the <i>Dell Inspiron Help</i> file. To access the help file, see "Finding Information" on page 9.
-----------	--

Speaker Functions

<Fn><Page Up>	Increases the volume of the integrated speakers and external speakers, if attached
<Fn><Page Dn>	Decreases the volume of the integrated speakers and external speakers, if attached
<Fn><End>	Enables and disables the integrated speakers and external speakers, if attached

Microsoft® Windows® Logo Key Functions

Windows logo key and <m>	Minimizes all open windows
Windows logo key and <Shift><m>	Maximizes all windows
Windows logo key and <e>	Runs Windows Explorer
Windows logo key and <r>	Opens the Run dialog box
Windows logo key and <f>	Opens the Search Results dialog box
Windows logo key and <Ctrl><f>	Opens the Search Results-Computer dialog box (if the computer is connected to a network)
Windows logo key and <Pause>	Opens the System Properties dialog box

To adjust keyboard operation, such as the character repeat rate, open the Control Panel, click **Printers and Other Hardware**, and click **Keyboard**. For information about the Control Panel, see the *Dell Inspiron Help* file. To access the help file, see "Finding Information" on page 9.

Touch Pad

The touch pad detects the pressure and movement of your finger to allow you to move the cursor on the display. Use the touch pad and touch pad buttons as you would use a mouse.



- To move the cursor, lightly slide your finger over the touch pad.
- To select an object, lightly tap once on the surface of the touch pad or use your thumb to press the left touch-pad button.
- To select and move (or drag) an object, position the cursor on the object and tap down-up-down on the touch pad. On the second down motion, leave your finger on the touch pad and move the selected object by sliding your finger over the surface.
- To double-click an object, position the cursor on the object and tap twice on the touch pad or use your thumb to press the left touch-pad button twice.

Customizing the Touch Pad

You can use the **Mouse Properties** window to disable the touch pad or adjust their settings.

- 1 Open the Control Panel, click **Printers and Other Hardware**, and then click **Mouse**. For information about the Control Panel, see the *Dell Inspiron Help* file. To access the help file, see "Finding Information" on page 9.
- 2 In the Mouse Properties window, click the **Touch Pad** tab to adjust touch pad settings.
- 3 Click **OK** to save the settings and close the window.

Using PC Cards

PC Card Types

See "Specifications" on page 93 for information on supported PC Cards.

 **NOTE:** A PC Card is not a bootable device.

The PC Card slot has one connector that supports a single Type I or Type II card. The PC Card slot supports CardBus technology and extended PC Cards. "Type" of card refers to its thickness, not its functionality.

PC Card Blanks

Your computer shipped with a plastic blank installed in the PC Card slot. Blanks protect unused slots from dust and other particles. Save the blank for use when no PC Card is installed in the slot; blanks from other computers may not fit your computer.

To remove the blank, see "Removing a PC Card or Blank" on page 45.

Extended PC Cards

An extended PC Card (for example, a wireless network adapter) is longer than a standard PC Card and extends outside the computer. Follow these precautions when using extended PC Cards:

- Protect the exposed end of an installed card. Striking the end of the card can damage the system board.
- Always remove an extended PC Card before you pack the computer in its carrying case.

Installing a PC Card

You can install a PC Card in the computer while the computer is running. The computer automatically detects the card.

PC Cards are generally marked with a symbol (such as a triangle or an arrow) to indicate which end to insert into the slot. The cards are keyed to prevent incorrect insertion. If card orientation is not clear, see the documentation that came with the card.

 **CAUTION:** Before you begin any of the procedures in this section, follow the safety instructions in the *Product Information Guide*.



To install a PC Card:

- 1 Hold the card with the top side of the card facing up. The latch may need to be in the "in" position before you insert the card.
 - 2 Slide the card into the slot until the card is completely seated in its connector.
- If you encounter too much resistance, do not force the card. Check the card orientation and try again.



The computer recognizes most PC Cards and automatically loads the appropriate device driver. If the configuration program tells you to load the manufacturer's drivers, use the floppy disk or CD that came with the PC Card.

Removing a PC Card or Blank

 **NOTICE:** Use the PC Card configuration utility (click the  icon in the taskbar) to select a card and stop it from functioning before you remove it from the computer. If you do not stop the card in the configuration utility, you could lose data. Do not attempt to eject a card by pulling its cable, if one is attached.

 **CAUTION:** Before you begin any of the procedures in this section, follow the safety instructions in the *Product Information Guide*.

Press the latch and remove the card or blank. For some latches, you must press the latch twice: once to pop the latch out, and then a second time to pop the card out.

Save a blank to use when no PC Card is installed in a slot. Blanks protect unused slots from dust and other particles.



Setting Up a Home and Office Network

Connecting to a Network Adapter

Before you connect your computer to a network, the computer must have a network adapter installed and a network cable connected to it.

To connect a network cable:

- 1 Connect the network cable to the network adapter connector on the back of your computer.

 **NOTE:** Insert the cable until it clicks into place, and then gently pull it to ensure that it is secure.

- 2 Connect the other end of the network cable to a network connection device, such as a network wall connector.

 **NOTE:** Do not use a network cable with a telephone wall connector.



Network Setup Wizard

The Microsoft® Windows® XP operating system provides a Network Setup Wizard to guide you through the process of sharing files, printers, or an Internet connection between computers in a home or small office.

- 1 Click the **Start** button, point to **All Programs**→**Accessories**→**Communications**, and then click **Network Setup Wizard**.
- 2 On the welcome screen, click **Next**.
- 3 Click **Checklist for creating a network**.

 **NOTE:** Selecting the connection method labeled "This computer connects directly to the Internet" enables the integrated firewall provided with Windows XP Service Pack 2 (SP2).

- 4 Complete the checklist and required preparations.
- 5 Return to the Network Setup Wizard and follow the instructions on the screen.

Connecting to a Wireless Local Area Network

 **NOTE:** These networking instructions do not apply to internal cards with Bluetooth® wireless technology or cellular products.

Determining Your Network Type

 **NOTE:** Most wireless networks are of the infrastructure type.

Wireless networks fall into two categories—infrastructure networks and ad-hoc networks. An infrastructure network uses routers or access points to connect several computers. An ad-hoc network does not use routers or access points and consists of computers that broadcast to one another. For additional assistance with setting up your wireless connection, go to support.dell.com and search for the keyword *wireless setup*.

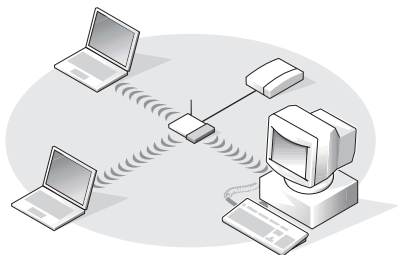

infrastructure network

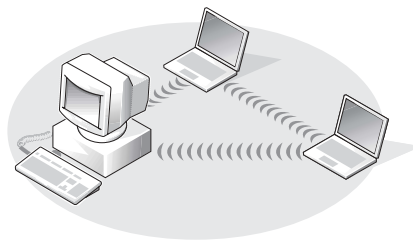

ad-hoc network

Connecting to a Wireless Network in Microsoft® Windows® XP

Your wireless network card requires specific software and drivers in order to connect to a network. The software is already installed. If the software is removed or corrupted, follow the instructions included in the user's guide for your wireless network card. The user's guide is available on the Dell Support website at support.dell.com.

When you turn on your computer, a pop-up appears from the network icon in the notification area whenever a network is detected in the area for which your computer is not configured.



- 1 Click either the pop-up or the network icon to configure your computer for one of the available wireless networks.

The **Wireless Network Connections** window lists the wireless networks available in your area.

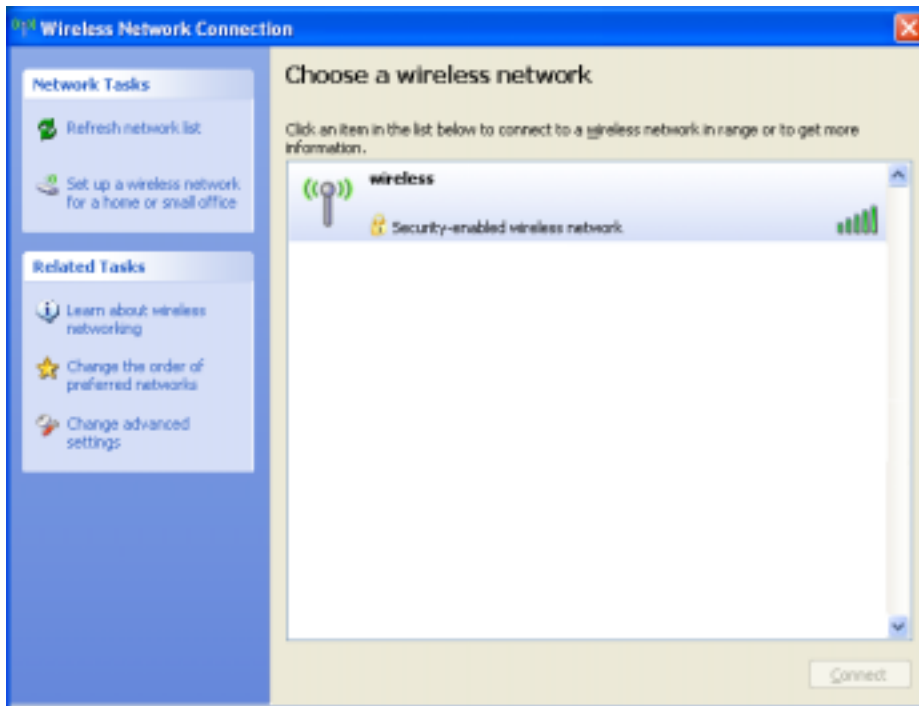

- 2 Click to select the network you want to configure, and then click **Connect** or double-click the network name in the list. If you select a secure network (identified by a  icon), you must enter a WEP or WPA key when prompted.

 **NOTE:** Network security settings are unique to your network. Dell cannot provide this information.

Your network is configured automatically.

 **NOTE:** Your computer can take up to 1 minute to connect to the network.

After your computer is configured for the wireless network you selected, another pop-up notifies you that your computer is connected to the network you selected.



Thereafter, whenever you log on to your computer in the area of the wireless network, the same pop-up notifies you of the wireless network connection.

Solving Problems

Dell Diagnostics



CAUTION: Before you begin any of the procedures in this section, follow the safety instructions in the *Product Information Guide*.

When to Use the Dell Diagnostics

If you experience a problem with your computer, perform the checks in this chapter, and run the Dell Diagnostics before you contact Dell for technical assistance.



NOTICE: The Dell Diagnostics works only on Dell™ computers.

Start the Dell Diagnostics from your hard drive. The Dell Diagnostics is located on a hidden diagnostic utility partition on your hard drive.



NOTE: If your computer cannot display a screen image, see "FCC Notices (U.S. Only)" on page 101.

- 1 Shut down the computer.
- 2 Connect the computer to an electrical outlet.
- 3 Turn on the computer. When the DELL™ logo appears, press <F12> immediately.

If you wait too long and the operating system logo appears, continue to wait until you see the Microsoft® Windows® desktop. Then shut down your computer (see "Turning Off Your Computer" on page 75) and try again.

- 4 When the boot device list appears, highlight **Diagnostics** and press <Enter>.

The computer runs the Pre-boot System Assessment, a series of initial tests of your system board, keyboard, hard drive, and display.

- During the assessment, answer any questions that appear.
- If a failure is detected, the computer stops and beeps. To stop the assessment and restart the computer, press <n>; to continue to the next test, press <y>; to retest the component that failed, press <r>.
- If failures are detected during the Pre-boot System Assessment, write down the error code(s) and contact Dell before continuing on to the Dell Diagnostics. See "FCC Notices (U.S. Only)" on page 101.

If the Pre-boot System Assessment completes successfully, you receive the message `Booting Dell Diagnostic Utility Partition`. Press any key to continue.

- 5 Press any key to start the Dell Diagnostics from the diagnostics utility partition on your hard drive.

Dell Diagnostics Main Menu

- 1 After the Dell Diagnostics loads and the **Main Menu** screen appears, click the button for the option you want.

Option	Function
Express Test	Performs a quick test of devices. This test typically takes 10 to 20 minutes and requires no interaction on your part. Run Express Test first to increase the possibility of tracing the problem quickly.
Extended Test	Performs a thorough check of devices. This test typically takes an hour or more and requires you to answer questions periodically.
Custom Test	Tests a specific device. You can customize the tests you want to run.
Symptom Tree	Lists the most common symptoms encountered and allows you to select a test based on the symptom of the problem you are having.

- 2 If a problem is encountered during a test, a message appears with an error code and a description of the problem. Write down the error code and problem description and follow the instructions on the screen.

If you cannot resolve the error condition, contact Dell. See "FCC Notices (U.S. Only)" on page 101.



NOTE: The Service Tag for your computer is located at the top of each test screen. If you contact Dell, technical support will ask for your Service Tag.

- 3 If you run a test from the **Custom Test** or **Symptom Tree** option, click the applicable tab described in the following table for more information.

Tab	Function
Results	Displays the results of the test and any error conditions encountered.
Errors	Displays error conditions encountered, error codes, and the problem description.
Help	Describes the test and may indicate requirements for running the test.
Configuration	Displays your hardware configuration for the selected device. The Dell Diagnostics obtains configuration information for all devices from system setup, memory, and various internal tests, and it displays the information in the device list in the left pane of the screen. The device list may not display the names of all the components installed on your computer or all devices attached to your computer.
Parameters	Allows you to customize the test by changing the test settings.

- 4 When the tests are complete, close the test screen to return to the **Main Menu** screen. To exit the Dell Diagnostics and restart the computer, close the **Main Menu** screen.

Drive Problems

 **CAUTION:** Before you begin any of the procedures in this section, follow the safety instructions in the *Product Information Guide*.

ENSURE THAT MICROSOFT® WINDOWS® RECOGNIZES THE DRIVE — Click the **Start** button and click **My Computer**. If the floppy, CD, or DVD drive is not listed, perform a full scan with your antivirus software to check for and remove viruses. Viruses can sometimes prevent Windows from recognizing the drive.

TEST THE DRIVE —

- Insert another floppy disk, CD, or DVD to eliminate the possibility that the original one is defective.
- Insert a bootable floppy disk and restart the computer.

CLEAN THE DRIVE OR DISK — See the *Dell Inspiron Help* file. To access the help file, see "Finding Information" on page 9.

ENSURE THAT THE CD IS SNAPPED ONTO THE SPINDLE

CHECK THE CABLE CONNECTIONS

CHECK FOR HARDWARE INCOMPATIBILITIES — See "Restoring Your Operating System" on page 71.

RUN THE DELL DIAGNOSTICS — See "When to Use the Dell Diagnostics" on page 51.

DVD drive problems

 **NOTE:** High-speed CD or DVD drive vibration is normal and may cause noise, which does not indicate a defect in the drive or the CD or DVD.

 **NOTE:** Because of different regions worldwide and different disc formats, not all DVD titles work in all DVD drives.

Problems writing to a DVD+RW drive

CLOSE OTHER PROGRAMS — The DVD+RW drive must receive a steady stream of data when writing. If the stream is interrupted, an error occurs. Try closing all programs before you write to the DVD+RW.

TURN OFF STANDBY MODE IN WINDOWS BEFORE WRITING TO A DVD+RW DISC — See the *Dell Inspiron Help* file or search for the keyword *standby* in the Windows Help and Support Center for information on power management modes. To access help, see "Finding Information" on page 9.

CHANGE THE WRITE SPEED TO A SLOWER RATE — See the help files for your DVD creation software.

VERIFY THAT THE CORRECT MEDIA IS IN USE — DVD+RW drives may use any CD media such as CD-R or CD-RW, but when you use your DVD+RW drive to write to DVD media, be sure to use DVD+R or DVD+RW media only. Using DVD-R/RW media may lead to DVD playback problems or incomplete write or verify operations.

If you cannot eject the DVD or DVD+RW drive tray

- 1 Ensure that the computer is shut down.
- 2 Straighten a paper clip and insert one end into the eject hole at the front of the drive; push firmly until the tray is partially ejected.
- 3 Gently pull out the tray until it stops.

If you hear an unfamiliar scraping or grinding sound

- Ensure that the sound is not caused by the program that is running.
- Ensure that the disk or disc is inserted properly.

Hard drive problems

ALLOW THE COMPUTER TO COOL BEFORE TURNING IT ON — A hot hard drive may prevent the operating system from starting. Try allowing the computer to return to room temperature before turning it on.

RUN CHECK DISK —

- 1 Click the **Start** button and click **My Computer**.
- 2 Right-click **Local Disk C:**.
- 3 Click **Properties**.
- 4 Click the **Tools** tab.
- 5 Under **Error-checking**, click **Check Now**.
- 6 Click **Scan for and attempt recovery of bad sectors**.
- 7 Click **Start**.

E-Mail, Modem, and Internet Problems

 **CAUTION:** Before you begin any of the procedures in this section, follow the safety instructions in the *Product Information Guide*.

 **NOTE:** Connect the modem to an analog telephone jack only. The modem does not operate while it is connected to a digital telephone network.

CHECK THE MICROSOFT OUTLOOK® EXPRESS SECURITY SETTINGS — If you cannot open your e-mail attachments:

- 1 In Outlook Express, click **Tools**, click **Options**, and then click **Security**.
- 2 Click **Do not allow attachments** to remove the checkmark.

CHECK THE TELEPHONE LINE CONNECTION —

CHECK THE TELEPHONE JACK —

CONNECT THE MODEM DIRECTLY TO THE TELEPHONE WALL JACK —

USE A DIFFERENT TELEPHONE LINE —

- Verify that the telephone line is connected to the jack on the modem. (The jack has either a green label or a connector-shaped icon next to it.)
- Ensure that the connector clicks when you insert the telephone line connector into the modem.
- Disconnect the telephone line from the modem and connect it to a telephone. Listen for a dial tone.
- If you have other telephone devices sharing the line, such as an answering machine, fax machine, surge protector, or line splitter, then bypass them and use the telephone to connect the modem directly to the telephone wall jack. If you are using a line that is 3 m (10 ft) or more in length, try a shorter one.

RUN THE MODEM HELPER DIAGNOSTICS — Click the **Start** button, point to **All Programs**, and then click **Modem Helper**. Follow the instructions on the screen to identify and resolve modem problems. (Modem Helper may not be available on certain computers.)

VERIFY THAT THE MODEM IS COMMUNICATING WITH WINDOWS —

- 1 Click the **Start** button and click **Control Panel**.
 - 2 Click **Printers and Other Hardware**.
 - 3 Click **Phone and Modem Options**.
 - 4 Click the **Modems** tab.
 - 5 Click the COM port for your modem.
 - 6 Click **Properties**, click the **Diagnostics** tab, and then click **Query Modem** to verify that the modem is communicating with Windows.
- If all commands receive responses, the modem is operating properly.

ENSURE THAT YOU ARE CONNECTED TO THE INTERNET — Ensure that you have subscribed to an Internet provider. With the Outlook Express e-mail program open, click **File**. If **Work Offline** has a checkmark next to it, click the checkmark to remove it and connect to the Internet. For help, contact your Internet service provider.

SCAN THE COMPUTER FOR SPYWARE — If you are experiencing slow computer performance, you frequently receive pop-up advertisements, or you are having problems connecting to the Internet, your computer might be infected with spyware. Use an anti-virus program that includes anti-spyware protection (your program may require an upgrade) to scan the computer and remove spyware. For more information, go to support.dell.com and search for the keyword *spyware*.

Error Messages

 **CAUTION:** Before you begin any of the procedures in this section, follow the safety instructions in the *Product Information Guide*.

If the message is not listed, see the documentation for the operating system or the program that was running when the message appeared.

BAD COMMAND OR FILE NAME — Ensure that you have spelled the command correctly, put spaces in the proper place, and used the correct pathname.

CD DRIVE CONTROLLER FAILURE — The CD drive does not respond to commands from the computer. See "Drive Problems" on page 53.

DATA ERROR — The hard drive cannot read the data. See "Drive Problems" on page 53.

THE FILE BEING COPIED IS TOO LARGE FOR THE DESTINATION DRIVE — The file that you are trying to copy is too large to fit on the disk, or the disk is too full. Try copying the file to a different disk or use a larger capacity disk.

A FILENAME CANNOT CONTAIN ANY OF THE FOLLOWING CHARACTERS: \ / : * ? " < > | — Do not use these characters in filenames.

INSERT BOOTABLE MEDIA — The operating system is trying to boot to a nonbootable CD. Insert a CD.

NOT ENOUGH MEMORY OR RESOURCES. EXIT SOME PROGRAMS AND TRY AGAIN — You have too many programs open. Close all windows and open the program that you want to use.

OPERATING SYSTEM NOT FOUND — Reinstall the hard drive. See page 77. If the problem persists, contact Dell. See "FCC Notices (U.S. Only)" on page 101.

A REQUIRED .DLL FILE WAS NOT FOUND — The program that you are trying to open is missing an essential file. Remove and then reinstall the program.

- 1** Click the **Start** button and click **Control Panel**.
- 2** Click **Add or Remove Programs**.
- 3** Select the program you want to remove.
- 4** Click **Remove** or **Change/Remove** and follow the prompts on the screen.
- 5** See the program documentation for installation instructions.

X:\ IS NOT ACCESSIBLE. THE DEVICE IS NOT READY — Insert a disk into the drive and try again.

IEEE 1394 Device Problems

 **CAUTION:** Before you begin any of the procedures in this section, follow the safety instructions in the *Product Information Guide*.

ENSURE THAT THE IEEE 1394 DEVICE IS PROPERLY INSERTED INTO THE CONNECTOR

ENSURE THAT THE IEEE 1394 DEVICE IS RECOGNIZED BY WINDOWS —

- 1 Click the Start button and click Control Panel.
- 2 Click **Printers and Other Hardware**.
If your IEEE 1394 device is listed, Windows recognizes the device.

IF YOU HAVE PROBLEMS WITH A DELL-PROVIDED IEEE 1394 DEVICE —

IF YOU HAVE PROBLEMS WITH AN IEEE 1394 DEVICE NOT PROVIDED BY DELL —

Contact Dell or the IEEE 1394 device manufacturer. See "FCC Notices (U.S. Only)" on page 101.

Keyboard Problems

 **CAUTION:** Before you begin any of the procedures in this section, follow the safety instructions in the *Product Information Guide*.

 **NOTE:** Use the integrated keyboard when running the Dell Diagnostics or the system setup program. When you attach an external keyboard, the integrated keyboard remains fully functional.

External keyboard problems

 **NOTE:** When you attach an external keyboard, the integrated keyboard remains fully functional.

CHECK THE KEYBOARD CABLE — Shut down the computer. Disconnect the keyboard cable and check it for damage, and firmly reconnect the cable.

If you are using a keyboard extension cable, disconnect it and connect the keyboard directly to the computer.

CHECK THE EXTERNAL KEYBOARD —

- 1 Shut down the computer, wait 1 minute, and turn it on again.
- 2 Verify that the numbers, capitals, and scroll lock lights on the keyboard blink during the boot routine.
- 3 From the Windows desktop, click the **Start** button, point to **All Programs**→**Accessories**, and click **Notepad**.
- 4 Type some characters on the external keyboard and verify that they appear on the display.

If you cannot verify these steps, you may have a defective external keyboard.

TO VERIFY THAT THE PROBLEM IS WITH THE EXTERNAL KEYBOARD, CHECK THE INTEGRATED KEYBOARD —

- 1 Shut down the computer.
- 2 Disconnect the external keyboard.
- 3 Turn on the computer.
- 4 From the Windows desktop, click the **Start** button, point to **All Programs**→**Accessories**, and click **Notepad**.
- 5 Type some characters on the external keyboard and verify that they appear on the display.

If the characters appear now but did not with the external keyboard, you may have a defective external keyboard. Contact Dell. See "FCC Notices (U.S. Only)" on page 101.

Unexpected characters

DISABLE THE NUMERIC KEYPAD — Press <Num Lk> to disable the numeric keypad if numbers are displayed instead of letters. Verify that the numbers lock light is not lit.

Lockups and Software Problems



CAUTION: Before you begin any of the procedures in this section, follow the safety instructions in the *Product Information Guide*.

The computer does not start up

ENSURE THAT THE AC ADAPTER IS FIRMLY CONNECTED TO THE COMPUTER AND TO THE ELECTRICAL OUTLET

The computer stops responding

 **NOTICE:** You might lose data if you are unable to perform an operating system shutdown.

TURN THE COMPUTER OFF — If you are unable to get a response by pressing a key on your keyboard or moving your mouse, press and hold the power button for at least 8 to 10 seconds until the computer turns off. Then restart your computer.

A program stops responding

END THE PROGRAM —

- 1 Press <Ctrl><Shift><Esc> simultaneously.
- 2 Click **Applications**.
- 3 Click the program that is no longer responding.
- 4 Click **End Task**.

A program crashes repeatedly

 **NOTE:** Software usually includes installation instructions in its documentation or on a floppy disk or CD.

CHECK THE SOFTWARE DOCUMENTATION — If necessary, uninstall and then reinstall the program.

A program is designed for an earlier Windows operating system

RUN THE PROGRAM COMPATIBILITY WIZARD — The Program Compatibility Wizard configures a program so that it runs in an environment similar to non-Windows XP operating system environments.

- 1 Click the **Start** button, point to **All Programs**→**Accessories**, and then click **Program Compatibility Wizard**.
- 2 In the welcome screen, click **Next**.
- 3 Follow the instructions on the screen.

A solid blue screen appears

TURN THE COMPUTER OFF — If you are unable to get a response by pressing a key on your keyboard or moving your mouse, press and hold the power button for at least 8 to 10 seconds until the computer turns off. Then restart your computer.

Other software problems

CHECK THE SOFTWARE DOCUMENTATION OR CONTACT THE SOFTWARE MANUFACTURER FOR TROUBLESHOOTING INFORMATION —

- Ensure that the program is compatible with the operating system installed on your computer.
- Ensure that your computer meets the minimum hardware requirements needed to run the software. See the software documentation for information.
- Ensure that the program is installed and configured properly.
- Verify that the device drivers do not conflict with the program.
- If necessary, uninstall and then reinstall the program.

BACK UP YOUR FILES IMMEDIATELY

USE A VIRUS-SCANNING PROGRAM TO CHECK THE HARD DRIVE, FLOPPY DISKS, OR CDs

SAVE AND CLOSE ANY OPEN FILES OR PROGRAMS AND SHUT DOWN YOUR COMPUTER THROUGH THE Start MENU

SCAN THE COMPUTER FOR SPYWARE — If you are experiencing slow computer performance, you frequently receive pop-up advertisements, or you are having problems connecting to the Internet, your computer might be infected with spyware. Use an anti-virus program that includes anti-spyware protection (your program may require an upgrade) to scan the computer and remove spyware. For more information, go to support.dell.com and search for the keyword *spyware*.

RUN THE DELL DIAGNOSTICS — If all tests run successfully, the error condition is related to a software problem. For information on Dell Diagnostics, see page 51.

Memory Problems

 **CAUTION:** Before you begin any of the procedures in this section, follow the safety instructions in the *Product Information Guide*.

IF YOU RECEIVE AN INSUFFICIENT MEMORY MESSAGE —

- Save and close any open files and exit any open programs you are not using to see if that resolves the problem.
- See the software documentation for minimum memory requirements. If necessary, install additional memory. See page 79.
- Reseat the memory modules to ensure that your computer is successfully communicating with the memory. See page 79.
- Run the Dell Diagnostics. See page 51.

IF YOU EXPERIENCE OTHER MEMORY PROBLEMS —

- Reseat the memory modules to ensure that your computer is successfully communicating with the memory. See page 79.
- Ensure that you are following the memory installation guidelines. See "Memory" on page 79.
- Run the Dell Diagnostics. See "Dell Diagnostics" on page 51.

Network Problems

 **CAUTION:** Before you begin any of the procedures in this section, follow the safety instructions in the *Product Information Guide*.

CHECK THE NETWORK CABLE CONNECTOR — Ensure that the network cable is firmly inserted into both the network connector on the back of the computer and the network jack.

CHECK THE NETWORK LIGHTS ON THE NETWORK CONNECTOR — No light indicates that no network communication exists. Replace the network cable.

RESTART THE COMPUTER AND LOG ON TO THE NETWORK AGAIN

CHECK YOUR NETWORK SETTINGS — Contact your network administrator or the person who set up your network to verify that your network settings are correct and that the network is functioning.

PC Card Problems



CAUTION: Before you begin any of the procedures in this section, follow the safety instructions in the *Product Information Guide*.

CHECK THE PC CARD — Ensure that the PC Card is properly inserted into the connector.

ENSURE THAT THE CARD IS RECOGNIZED BY WINDOWS — Double-click the **Safely Remove Hardware** icon in the Windows taskbar. Ensure that the card is listed.

IF YOU HAVE PROBLEMS WITH A DELL-PROVIDED PC CARD — Contact Dell. See "FCC Notices (U.S. Only)" on page 101.

IF YOU HAVE PROBLEMS WITH A PC CARD NOT PROVIDED BY DELL — Contact the PC Card manufacturer.

Power Problems



CAUTION: Before you begin any of the procedures in this section, follow the safety instructions in the *Product Information Guide*.



NOTE: See the *Dell Inspiron Help* file for information on standby mode. To access the help file, see "Finding Information" on page 9.

CHECK THE POWER LIGHT — When the power light is lit or blinking, the computer has power. If the power light is blinking, the computer is in standby mode—press the power button to exit standby mode. If the light is off, press the power button to turn on the computer.

CHARGE THE BATTERY — The battery charge may be depleted.

- 1 Reinstall the battery.
- 2 Use the AC adapter to connect the computer to an electrical outlet.
- 3 Turn on the computer.

CHECK THE BATTERY STATUS LIGHT — If the battery status light flashes orange or is a steady orange, the battery charge is low or depleted. Connect the computer to an electrical outlet.

If the battery status light flashes green and orange, the battery is too hot to charge. Shut down the computer, disconnect the computer from the electrical outlet, and then let the battery and computer cool to room temperature.

If the battery status light rapidly flashes orange, the battery may be defective. Contact Dell. See "FCC Notices (U.S. Only)" on page 101.

CHECK THE BATTERY TEMPERATURE — If the battery temperature is below 0° C (32° F), the computer will not start up.

TEST THE ELECTRICAL OUTLET — Ensure that the electrical outlet is working by testing it with another device, such as a lamp.

CHECK THE AC ADAPTER — Check the AC adapter cable connections. If the AC adapter has a light, ensure that the light is on.

CONNECT THE COMPUTER DIRECTLY TO AN ELECTRICAL OUTLET — Bypass power protection devices, power strips, and the extension cable to verify that the computer turns on.

ELIMINATE POSSIBLE INTERFERENCE — Turn off nearby fans, fluorescent lights, halogen lamps, or other appliances.

ADJUST THE POWER PROPERTIES — See the *Dell Inspiron Help* file or search for the keyword *standby* in the Help and Support Center. To access help, see "Finding Information" on page 9.

RESEAT THE MEMORY MODULES — If the computer power light turns on but the display remains blank, reinstall the memory modules. See page 79.

Printer Problems



CAUTION: Before you begin any of the procedures in this section, follow the safety instructions in the *Product Information Guide*.



NOTE: If you need technical assistance for your printer, contact the printer's manufacturer.

CHECK THE PRINTER DOCUMENTATION — See the printer documentation for setup and troubleshooting information.

ENSURE THAT THE PRINTER IS TURNED ON

CHECK THE PRINTER CABLE CONNECTIONS —

- See the printer documentation for cable connection information.
- Ensure that the printer cables are securely connected to the printer and the computer.

TEST THE ELECTRICAL OUTLET — Ensure that the electrical outlet is working by testing it with another device, such as a lamp.

VERIFY THAT THE PRINTER IS RECOGNIZED BY WINDOWS —

- 1 Click the **Start** button, click **Control Panel**, and then click **Printers and Other Hardware**.
- 2 Click **View installed printers or fax printers**.
If the printer is listed, right-click the printer icon.
- 3 Click **Properties** and click the **Ports** tab. For a USB printer, ensure that the **Print to the following port(s)**: setting is **USB**.

REINSTALL THE PRINTER DRIVER — See the printer documentation for instructions

Scanner Problems



CAUTION: Before you begin any of the procedures in this section, follow the safety instructions in the *Product Information Guide*.



NOTE: If you need technical assistance for your scanner, contact the scanner's manufacturer.

CHECK THE SCANNER DOCUMENTATION — See the scanner documentation for setup and troubleshooting information.

UNLOCK THE SCANNER — Ensure that your scanner is unlocked if it has a locking tab or button.

RESTART THE COMPUTER AND TRY THE SCANNER AGAIN

CHECK THE CABLE CONNECTIONS —

- See the scanner documentation for cable connection information.
- Ensure that the scanner cables are securely connected to the scanner and the computer.

VERIFY THAT THE SCANNER IS RECOGNIZED BY MICROSOFT WINDOWS —

1 Click the Start button, click Control Panel, and then click Printers and Other Hardware.

2 Click Scanners and Cameras.

If your scanner is listed, Windows recognizes the scanner.

REINSTALL THE SCANNER DRIVER — See the scanner documentation for instructions.

Sound and Speaker Problems



CAUTION: Before you begin any of the procedures in this section, follow the safety instructions in the *Product Information Guide*.

No sound from integrated speakers

ADJUST THE WINDOWS VOLUME CONTROL — Double-click the speaker icon in the lower-right corner of your screen. Ensure that the volume is turned up and that the sound is not muted. Adjust the volume, bass, or treble controls to eliminate distortion.

ADJUST THE VOLUME USING KEYBOARD SHORTCUTS — Press <Fn><End> to disable (mute) or reenable the integrated speakers.

REINSTALL THE SOUND (AUDIO) DRIVER — See "Reinstalling Drivers" on page 70.

No sound from external speakers



NOTE: The volume control in some MP3 players overrides the Windows volume setting. If you have been listening to MP3 songs, ensure that you did not turn the player volume down or off.

ENSURE THAT THE SUBWOOFER AND THE SPEAKERS ARE TURNED ON — See the setup diagram supplied with the speakers. If your speakers have volume controls, adjust the volume, bass, or treble to eliminate distortion.

ADJUST THE WINDOWS VOLUME CONTROL — Click or double-click the speaker icon in the lower-right corner of your screen. Ensure that the volume is turned up and that the sound is not muted.

DISCONNECT HEADPHONES FROM THE HEADPHONE CONNECTOR — Sound from the speakers is automatically disabled when headphones are connected to the computer's front-panel headphone connector.

TEST THE ELECTRICAL OUTLET — Ensure that the electrical outlet is working by testing it with another device, such as a lamp.

ELIMINATE POSSIBLE INTERFERENCE — Turn off nearby fans, fluorescent lights, or halogen lamps to check for interference.

REINSTALL THE AUDIO DRIVER — See "Reinstalling Drivers" on page 70.

RUN THE DELL DIAGNOSTICS — See "When to Use the Dell Diagnostics" on page 51.

No sound from headphones

CHECK THE HEADPHONE CABLE CONNECTION — Ensure that the headphone cable is securely inserted into the headphone connector. For more information, see "Audio Connectors" on page 18.

ADJUST THE WINDOWS VOLUME CONTROL — Click or double-click the speaker icon in the lower-right corner of your screen. Ensure that the volume is turned up and that the sound is not muted.

Touch Pad or Mouse Problems

CHECK THE TOUCH PAD SETTINGS —

- 1 Click the Start button, click Control Panel, and then click Printers and Other Hardware.
- 2 Click Mouse.
- 3 Try adjusting the settings.

CHECK THE MOUSE CABLE — Shut down the computer. Disconnect the mouse cable, check it for damage, and firmly reconnect the cable.

If you are using a mouse extension cable, disconnect it and connect the mouse directly to the computer.

TO VERIFY THAT THE PROBLEM IS WITH THE MOUSE, CHECK THE TOUCH PAD —

- 1 Shut down the computer.
- 2 Disconnect the mouse.
- 3 Turn on the computer.
- 4 At the Windows desktop, use the touch pad to move the cursor around, select an icon, and open it.

If the touch pad operates correctly, the mouse may be defective.

REINSTALL THE TOUCH PAD DRIVER — See "Reinstalling Drivers" on page 70.

Video and Display Problems



CAUTION: Before you begin any of the procedures in this section, follow the safety instructions in the *Product Information Guide*.

If the display is blank



NOTE: If you are using a program that requires a higher resolution than your computer supports, it is recommended that you attach an external monitor to your computer.

CHECK THE BATTERY — If you are using a battery to power your computer, the battery charge may be depleted. Connect the computer to an electrical outlet using the AC adapter, and turn on the computer.

TEST THE ELECTRICAL OUTLET — Ensure that the electrical outlet is working by testing it with another device, such as a lamp.

CHECK THE AC ADAPTER — Check the AC adapter cable connections. If the AC adapter has a light, ensure that the light is on.

CONNECT THE COMPUTER DIRECTLY TO AN ELECTRICAL OUTLET — Bypass power protection devices, power strips, and the extension cable to verify that the computer turns on.

ADJUST THE POWER PROPERTIES — Search for the keyword *standby* in the Windows Help and Support Center. To access help, see "Finding Information" on page 9.

SWITCH THE VIDEO IMAGE — If your computer is attached to an external monitor, press <Fn><F8> to switch the video image to the display.

If the display is difficult to read

ADJUST THE BRIGHTNESS — Press <Fn> and the up- or down-arrow key.

MOVE THE EXTERNAL SUBWOOFER AWAY FROM THE COMPUTER OR MONITOR — If your external speaker system includes a subwoofer, ensure that the subwoofer is at least 60 cm (2 ft) away from the computer or external monitor.

ELIMINATE POSSIBLE INTERFERENCE — Turn off nearby fans, fluorescent lights, halogen lamps, or other appliances.

ROTATE THE COMPUTER TO FACE A DIFFERENT DIRECTION — Eliminate sunlight glare, which can cause poor picture quality.

ADJUST THE WINDOWS DISPLAY SETTINGS —

- 1 Click the **Start** button and then click **Control Panel**.
- 2 Click **Appearance and Themes**.
- 3 Click the area you want to change or click the **Display** icon.
- 4 Try different settings for **Color quality** and **Screen resolution**.

SEE "ERROR MESSAGES" — If an error message appears, see page 56.

If only part of the display is readable

CONNECT AN EXTERNAL MONITOR —

- 1 Shut down your computer and connect an external monitor to the computer.
- 2 Turn on the computer and the monitor and adjust the monitor brightness and contrast controls.

If the external monitor works, the computer display or video controller may be defective. Contact Dell. See "FCC Notices (U.S. Only)" on page 101.

Drivers

What Is a Driver?

A driver is a program that controls a device such as a printer, mouse, or keyboard. All devices require a driver program.

A driver acts like a translator between the device and any other programs that use the device. Each device has its own set of specialized commands that only its driver recognizes.

Dell ships your computer to you with required drivers already installed—no further installation or configuration is needed.

Many drivers, such as the keyboard driver, come with your Microsoft® Windows® operating system. You may need to install drivers if you:

- Upgrade your operating system.
- Reinstall your operating system.
- Connect or install a new device.

Identifying Drivers

If you experience a problem with any device, identify whether the driver is the source of your problem and, if necessary, update the driver.

- 1 Click the **Start** button and click **Control Panel**.
- 2 Under **Pick a Category**, click **Performance and Maintenance**.
- 3 Click **System**.
- 4 In the **System Properties** window, click the **Hardware** tab.
- 5 Click **Device Manager**.
- 6 Scroll down the list to see if any device has an exclamation point (a yellow circle with a [!]) on the device icon.

If an exclamation point is next to the device name, you may need to reinstall the driver or install a new driver. See the following subsection, "Reinstalling Drivers."

Reinstalling Drivers



NOTICE: The Dell Support website at support.dell.com provides approved drivers for Dell™ computers. If you install drivers obtained from other sources, your computer might not work correctly.

Using Windows XP Device Driver Rollback

If a problem occurs on your computer after you install or update a driver, use Windows XP Device Driver Rollback to replace the driver with the previously installed version.

- 1 Click the **Start** button and click **Control Panel**.
- 2 Under **Pick a Category**, click **Performance and Maintenance**.
- 3 Click **System**.
- 4 In the **System Properties** window, click the **Hardware** tab.
- 5 Click **Device Manager**.
- 6 Right-click the device for which the new driver was installed and click **Properties**.
- 7 Click the **Drivers** tab.
- 8 Click **Roll Back Driver**.

If Device Driver Rollback does not resolve the problem, then use System Restore to return your computer to the operating state that existed before you installed the new driver. See "Using Microsoft Windows XP System Restore" on page 71.

Manually Reinstalling Drivers

- 1 After copying the required driver files to your hard drive, click the **Start** button and right-click **My Computer**.
- 2 Click **Properties**.
- 3 Click the **Hardware** tab and click **Device Manager**.
- 4 Double-click the type of device for which you are installing the driver (for example, **Modems** or **Infrared devices**).
- 5 Double-click the name of the device for which you are installing the driver.
- 6 Click the **Driver** tab and click **Update Driver**.
- 7 Click **Install from a list or specific location (Advanced)** and click **Next**.
- 8 Click **Browse** and browse to the location to which you previously copied the driver files.
- 9 When the name of the appropriate driver appears, click **Next**.
- 10 Click **Finish** and restart your computer.

Restoring Your Operating System

You can restore your operating system in the following ways:

- Microsoft Windows XP System Restore returns your computer to an earlier operating state without affecting data files.
- Dell PC Restore by Symantec restores your hard drive to the operating state it was in when you purchased the computer. Dell PC Restore permanently deletes all data on the hard drive and removes any applications installed after you received the computer.

 **NOTE:** Dell PC Restore is available only on computers purchased in certain regions.

Using Microsoft Windows XP System Restore

The Microsoft Windows XP operating system provides System Restore to allow you to return your computer to an earlier operating state (without affecting data files) if changes to the hardware, software, or other system settings have left the computer in an undesirable operating state. See the Windows Help and Support Center for information on using System Restore. To access help, see "Finding Information" on page 9.

 **NOTICE:** Make regular backups of your data files. System Restore does not monitor your data files or recover them.

 **NOTE:** The procedures in this document were written for the Windows default view, so they may not work if you set your Dell™ computer to the Windows Classic view.

Creating a Restore Point

- 1 Click the **Start** button and click **Help and Support**.
- 2 Click **System Restore**.
- 3 Follow the instructions on the screen.

Restoring the Computer to an Earlier Operating State

If problems occur after you install a device driver, use Device Driver Rollback (see page 70) to resolve the problem. If that is unsuccessful, then use System Restore.



NOTICE: Before you restore the computer to an earlier operating state, save and close any open files and exit any open programs. Do not alter, open, or delete any files or programs until the system restoration is complete.

- 1 Click the **Start** button, point to **All Programs**→**Accessories**→**System Tools**, and then click **System Restore**.
- 2 Ensure that **Restore my computer to an earlier time** is selected and click **Next**.
- 3 Click a calendar date to which you want to restore your computer.

The **Select a Restore Point** screen provides a calendar that allows you to see and select restore points. All calendar dates with available restore points appear in boldface type.

- 4 Select a restore point and click **Next**.

If a calendar date has only one restore point, then that restore point is automatically selected. If two or more restore points are available, click the restore point that you prefer.

- 5 Click **Next**.

The **Restoration Complete** screen appears after System Restore finishes collecting data and then the computer restarts.

- 6 After the computer restarts, click **OK**.

To change the restore point, you can either repeat the steps using a different restore point, or you can undo the restoration.

Undoing the Last System Restore



NOTICE: Before you undo the last system restore, save and close all open files and exit any open programs. Do not alter, open, or delete any files or programs until the system restoration is complete.

- 1 Click the **Start** button, point to **All Programs**→**Accessories**→**System Tools**, and then click **System Restore**.
- 2 Click **Undo my last restoration** and click **Next**.

Enabling System Restore

If you reinstall Windows XP with less than 200 MB of free hard-disk space available, System Restore is automatically disabled. To see if System Restore is enabled:

- 1 Click the **Start** button and click **Control Panel**.
- 2 Click **Performance and Maintenance**.
- 3 Click **System**.
- 4 Click the **System Restore** tab.
- 5 Ensure that **Turn off System Restore** is unchecked.

Using Dell PC Restore by Symantec



NOTE: Dell PC Restore is available only on computers purchased in certain regions.

Use Dell PC Restore by Symantec only as the last method to restore your operating system. PC Restore restores your hard drive to the operating state it was in when you purchased the computer. Any programs or files added since you received your computer—including data files—are permanently deleted from the hard drive. Data files include documents, spreadsheets, e-mail messages, digital photos, music files, and so on. If possible, back up all data before using PC Restore.



NOTICE: Using PC Restore permanently deletes all data on the hard drive and removes any applications or drivers installed after you received your computer. If possible, back up the data before using PC Restore.

To use PC Restore:

- 1 Turn on the computer.
During the boot process, a blue bar with **www.dell.com** appears at the top of the screen.
- 2 Immediately upon seeing the blue bar, press <Ctrl><F11>.
If you do not press <Ctrl><F11> in time, let the computer finish restarting, and then restart the computer again.



NOTICE: If you do not want to proceed with PC Restore, click **Reboot** in the following step.

- 3 On the next screen that appears, click **Restore**.
- 4 On the next screen, click **Confirm**.
The restore process takes approximately 6–10 minutes to complete.
- 5 When prompted, click **Finish** to reboot the computer.



NOTE: Do not manually shut down the computer. Click **Finish** and let the computer completely reboot.

- 6 When prompted, click **Yes**.

The computer restarts. Because the computer is restored to its original operating state, the screens that appear, such as the End User License Agreement, are the same ones that appeared the first time the computer was turned on.

- 7 Click **Next**.

The **System Restore** screen appears and the computer restarts.

- 8 After the computer restarts, click **OK**.

Resolving Software and Hardware Incompatibilities

If a device is either not detected during the operating system setup or is detected but incorrectly configured, you can use the Hardware Troubleshooter to resolve the incompatibility.

To resolve incompatibilities using the Hardware Troubleshooter:

- 1 Click the **Start** button and click **Help and Support**.
- 2 Type `hardware troubleshooter` in the **Search** field and click the arrow to start the search.
- 3 Click **Hardware Troubleshooter** in the **Search Results** list.
- 4 In the **Hardware Troubleshooter** list, click **I need to resolve a hardware conflict on my computer**, and click **Next**.

Adding and Replacing Parts

Before You Begin

This chapter provides procedures for removing and installing the components in your computer. Unless otherwise noted, each procedure assumes that the following conditions exist:

- You have performed the steps in "Turning Off Your Computer" (see this page) and "Before Working Inside Your Computer" (see page 76).
- You have read the safety information in your Dell™ *Product Information Guide*.
- A component can be replaced—or if purchased separately—installed by performing the removal procedure in reverse order.

Recommended Tools

The procedures in this document may require the following tools:

- Small flat-blade screwdriver
- Phillips screwdriver
- Small plastic scribe
- Flash BIOS update (see the Dell Support website at support.dell.com)

Turning Off Your Computer



NOTICE: To avoid losing data, save and close any open files and exit any open programs before you turn off your computer.

- 1 Shut down the operating system:
 - a Save and close any open files, exit any open programs, click the **Start** button, and then click **Turn Off Computer**.
 - b In the **Turn off computer** window, click **Turn off**.
The computer turns off after the operating system shutdown process finishes.
- 2 Ensure that the computer and any attached devices are turned off. If your computer and attached devices did not automatically turn off when you shut down your operating system, press and hold the power button for 4 seconds.

Before Working Inside Your Computer

Use the following safety guidelines to help protect your computer from potential damage and to help ensure your own personal safety.



CAUTION: Before you begin any of the procedures in this section, follow the safety instructions in the *Product Information Guide*.



CAUTION: Handle components and cards with care. Do not touch the components or contacts on a card. Hold a card by its edges or by its metal mounting bracket. Hold a component such as a processor by its edges, not by its pins.



NOTICE: Only a certified service technician should perform repairs on your computer. Damage due to servicing that is not authorized by Dell is not covered by your warranty.



NOTICE: When you disconnect a cable, pull on its connector or on its strain-relief loop, not on the cable itself. Some cables have a connector with locking tabs; if you are disconnecting this type of cable, press in on the locking tabs before you disconnect the cable. As you pull connectors apart, keep them evenly aligned to avoid bending any connector pins. Also, before you connect a cable, ensure that both connectors are correctly oriented and aligned.



NOTICE: To avoid damaging the computer, perform the following steps before you begin working inside the computer.

- 1 Ensure that the work surface is flat and clean to prevent the computer cover from being scratched.
- 2 Turn off your computer. See "Turning Off Your Computer" on page 75.



NOTICE: To disconnect a network cable, first unplug the cable from your computer and then unplug it from the network wall jack.

- 3 Disconnect any telephone or network cables from the computer.









NOTICE: To avoid damaging the system board, you must remove the main battery before you service the computer.

- 4 Disconnect your computer and all attached devices from their electrical outlets, slide and hold the battery-bay latch release on the bottom of the computer, and then remove the battery from the bay.



- 5 Remove the optical drive, if installed, from the optical drive bay. See "Optical Drive" on page 88.
- 6 Press the power button to ground the system board.
- 7 Remove any installed PC Cards from the PC Card slot. See "Removing a PC Card or Blank" on page 45.
- 8 Close the display and turn the computer upside down on a flat work surface.
- 9 Remove the hard drive. See "Hard Drive" on page 77.

Hard Drive

-  **CAUTION:** If you remove the hard drive from the computer when the drive is hot, *do not touch* the metal housing of the hard drive.
-  **CAUTION:** Before you begin any of the procedures in this section, follow the safety instructions in the *Product Information Guide*.
-  **NOTICE:** To prevent data loss, turn off your computer (see page 75) before removing the hard drive. Do not remove the hard drive while the computer is on, in standby mode, or in hibernate mode.
-  **NOTICE:** Hard drives are extremely fragile; even a slight bump can damage the drive.
-  **NOTE:** Dell does not guarantee compatibility or provide support for hard drives from sources other than Dell.
-  **NOTE:** If you are installing a hard drive from a source other than Dell, you need to install an operating system, drivers, and utilities on the new hard drive.

To replace the hard drive in the hard drive bay:

- 1 Follow the procedures in "Before You Begin" on page 75.
- 2 Turn the computer over, and remove the hard drive screws.

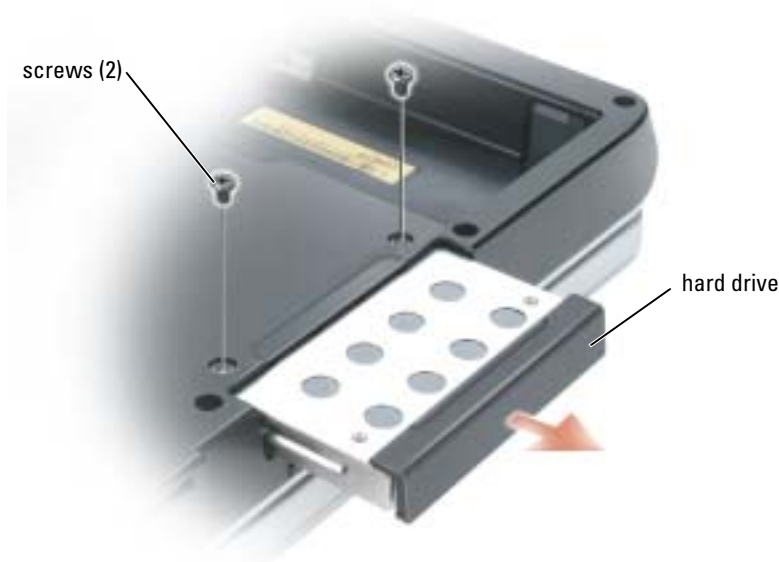

- 3 Slide the hard drive out of the computer.
- 4 Remove the new drive from its packaging.
Save the original packaging for storing or shipping the hard drive.
- 5 **NOTICE:** Use firm and even pressure to slide the drive into place. If you use excessive force, you may damage the connector.
- 6 Slide the hard drive into the bay until it is fully seated.
- 7 Replace and tighten the screws.
- 8 Install the operating system for your computer. See "Restoring Your Operating System" on page 71.
- 9 Install the drivers and utilities for your computer. See "Reinstalling Drivers" on page 70.

Returning a Hard Drive to Dell

Return your old hard drive to Dell in its original or comparable foam packaging. Otherwise, the hard drive may be damaged in transit.

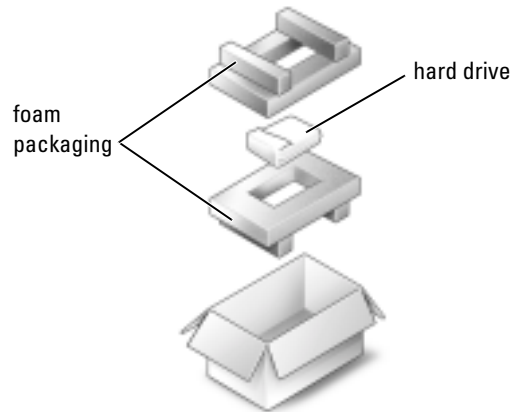

Memory

You can increase your computer memory by installing memory modules on the system board. See "Specifications" on page 93 for information on the memory supported by your computer. Install only memory modules that are intended for your computer.

 **NOTE:** Memory modules purchased from Dell are covered under your computer warranty.

 **CAUTION:** Before you begin any of the procedures in this section, follow the safety instructions in the *Product Information Guide*.

- 1 Follow the procedures in "Before You Begin" on page 75.
- 2 Ground yourself by touching one of the metal connectors on the back of the computer.

 **NOTE:** If you leave the area, ground yourself again when you return to the computer.

- 3 Turn the computer over, loosen the captive screws on the memory module cover, and then remove the memory module cover.



NOTICE: To prevent damage to the memory module connector, do not use tools to spread the memory-module securing clips.

- 4 If you are replacing a memory module, remove the existing module:
 - a Use your fingertips to carefully spread apart the securing clips on each end of the memory module connector until the module pops up.
 - b Remove the module from the connector.

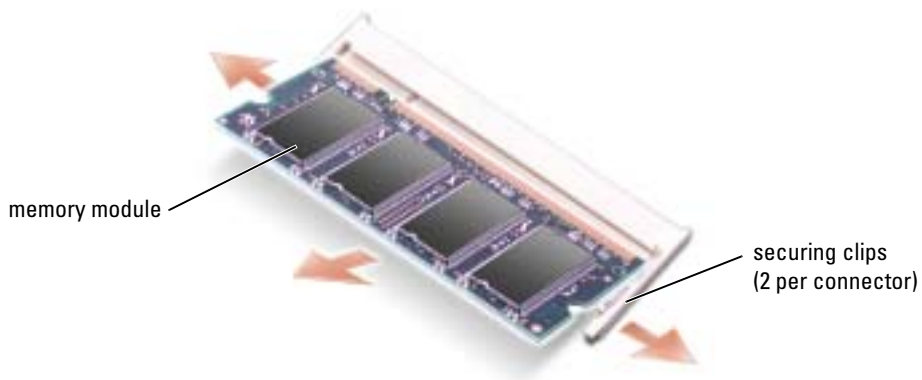

NOTICE: If you need to install memory modules in two connectors, install a memory module in the connector labeled “DIMMA” before you install a module in the connector labeled “DIMMB.” Insert memory modules at a 45-degree angle to avoid damaging the connector.

NOTE: If the memory module is not installed properly, the computer may not boot properly. No error message indicates this failure.

5 Ground yourself and install the new memory module:

- a Align the notch in the module edge connector with the tab in the connector slot.
- b Slide the module firmly into the slot at a 45-degree angle, and rotate the module down until it clicks into place. If you do not feel the click, remove the module and reinstall it.

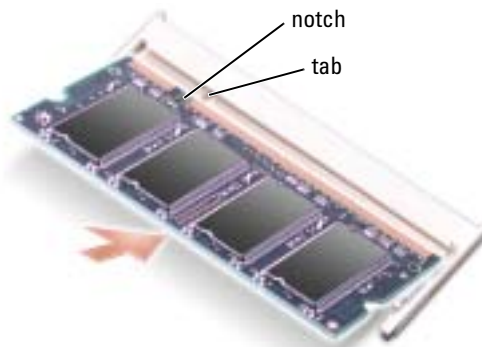

6 Replace the memory module cover.

NOTICE: If the cover is difficult to close, remove the module and reinstall it. Forcing the cover to close may damage your computer.



- 7 Insert the battery into the battery bay, or connect the AC adapter to your computer and an electrical outlet.
- 8 Reinstall the hard drive. See "Hard Drive" on page 77.
- 9 Turn on the computer.

As the computer boots, it detects the additional memory and automatically updates the system configuration information.

To confirm the amount of memory installed in the computer, click the **Start** button, click **Help and Support**, and then click **Computer Information**.

Modem

If you ordered the optional modem at the same time that you ordered your computer, the modem is already installed.

 **CAUTION: Before you begin any of the procedures in this section, follow the safety instructions in the *Product Information Guide*.**

- 1 Follow the procedures in "Before You Begin" on page 75.
- 2 Turn the computer over, loosen the captive screws on the modem cover, and then remove the modem cover.



3 Remove the existing modem:

- a** Remove the screw securing the modem to the system board, and set it aside.
- b** Pull straight up on the attached pull-tab to lift the modem out of its connector on the system board, and disconnect the modem cable.

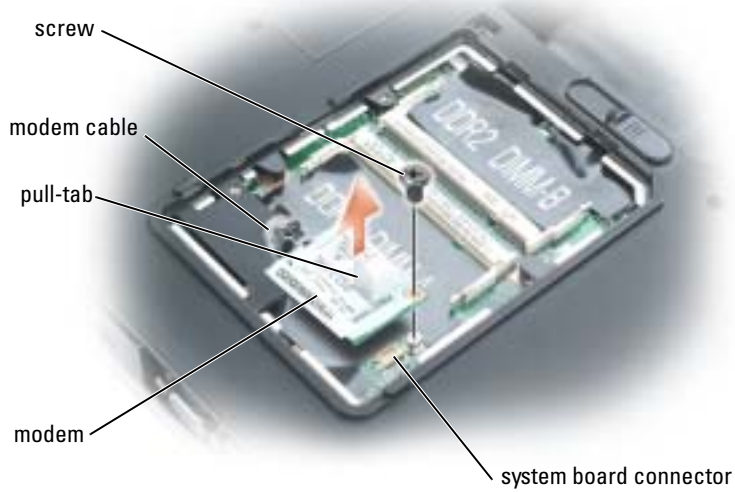

4 Install the replacement modem:

- a** Connect the modem cable to the modem.



NOTICE: The connectors are keyed to ensure correct insertion. If you feel resistance, check the connectors and realign the card.

- b** Align the modem with the screw holes and press the modem into the connector on the system board.
- c** Replace the screw that secures the modem to the system board.

5 Replace the modem cover.

Wireless Mini PCI Card

If you ordered a Mini PCI card with your computer, the card is already installed.

⚠ CAUTION: Before you begin any of the procedures in this section, follow the safety instructions in the *Product Information Guide*.

- 1 Follow the procedures in "Before You Begin" on page 75.
- 2 Remove the hinge cover. See "Hinge Cover" on page 89.
- 3 Remove the keyboard. See "Keyboard" on page 90.
- 4 If a Mini PCI card is not already installed, go to step 5. If you are replacing a Mini PCI card, remove the existing card:
 - a Disconnect the Mini PCI card from any attached cables.
 - b Release the Mini PCI card by spreading the metal securing tabs until the card pops up slightly.
 - c Lift the Mini PCI card out of its connector.

➡ NOTICE: The connectors are keyed to ensure correct insertion. If you feel resistance, check the connectors and realign the card.

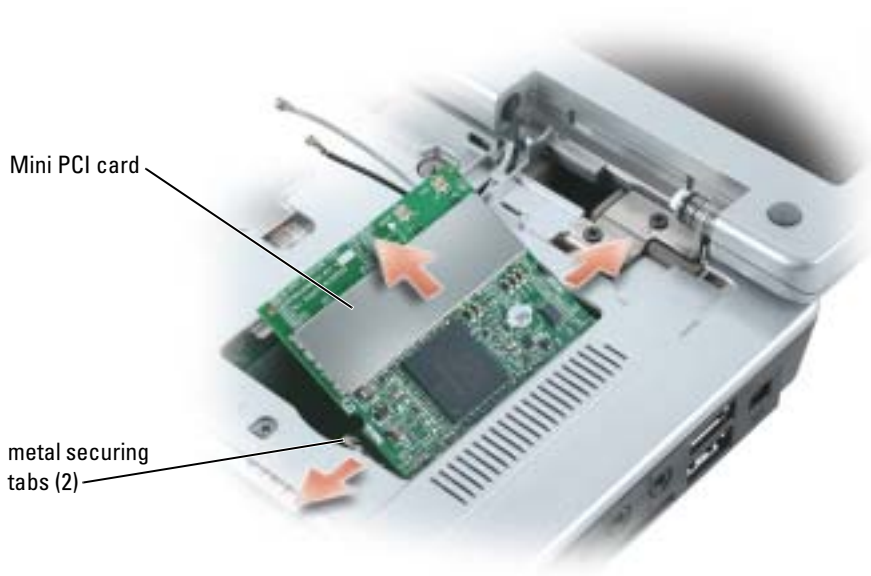

5 Install the replacement Mini PCI card:

- a Align the Mini PCI card with the connector at a 45-degree angle, and press the Mini PCI card into the connector until it clicks.



NOTICE: To avoid damaging the Mini PCI card, never place cables under the card.

- b Connect the antenna cables to the Mini PCI card.

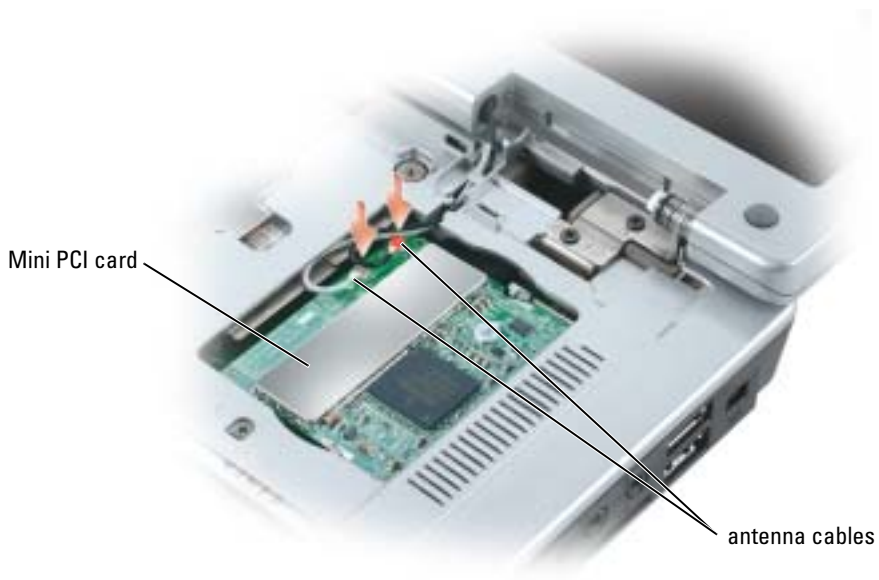

Coin-Cell Battery

⚠ CAUTION: Before you begin any of the procedures in this section, follow the safety instructions in the *Product Information Guide*.

🔄 NOTICE: To avoid electrostatic discharge, ground yourself by using a wrist grounding strap or by periodically touching an unpainted metal surface (such as a connector on the back of the computer).

🔄 NOTICE: To avoid damaging the system board, you must remove the main battery before you begin working inside the computer.

- 1 Follow the procedures in "Before You Begin" on page 75.
- 2 Remove the hinge cover. See "Hinge Cover" on page 89.
- 3 Remove the keyboard. See "Keyboard" on page 90.
- 4 Insert a plastic scribe into the guide on the side of the coin-cell battery compartment, and pop the battery out.

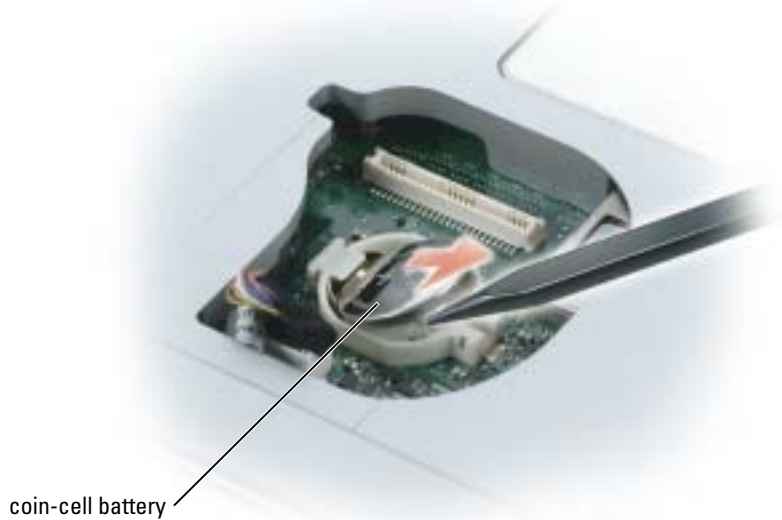

When you replace the battery, insert it at a 30-degree angle under the clip with the positive (identified by a plus [+] symbol) side up, and then push it into place.

Display

⚠ CAUTION: Before you begin any of the procedures in this section, follow the safety instructions in the *Product Information Guide*.

🔄 NOTICE: To avoid electrostatic discharge, ground yourself by using a wrist grounding strap or by periodically touching an unpainted metal surface (such as a connector on the back of the computer).

🔄 NOTICE: To avoid damaging the system board, you must remove the main battery before you begin working inside the computer.

- 1 Follow the procedures in "Before You Begin" on page 75.
- 2 Remove the hinge cover. See "Hinge Cover" on page 89.
- 3 Remove the four screws securing the display.
- 4 Disconnect the antennae cables (pull to separate the connectors).
- 5 Remove the grounding wire screw.
- 6 Disconnect the display cable, using the pull-tab.

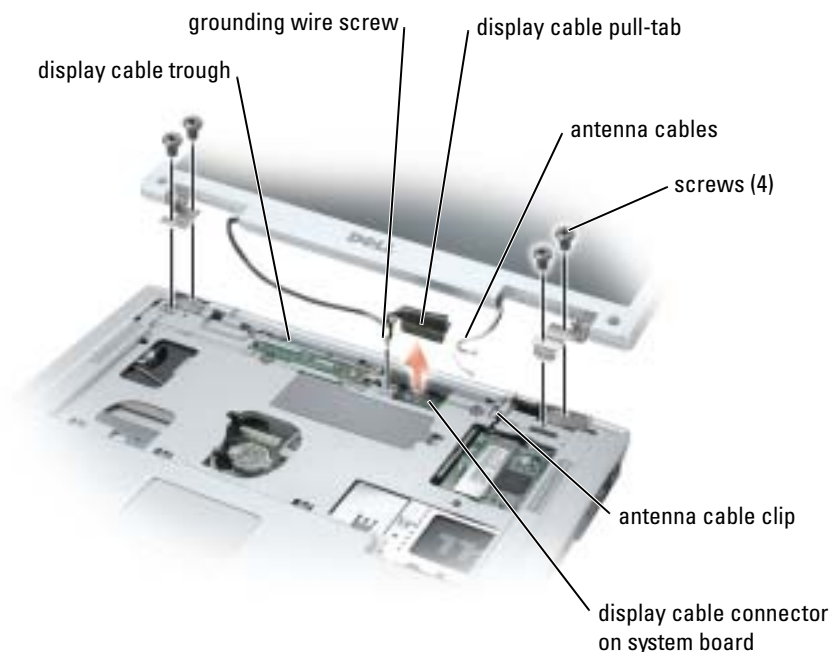

- 7 Lift the display up and away from the computer.

When you replace the display, ensure that the display cable is lying flat in the display cable trough and securely tucked underneath the tabs.

Also, ensure that the antenna cables are not twisted and that they are lying flat in the antenna cable clip.

Optical Drive

⚠ CAUTION: Before you begin any of the procedures in this section, follow the safety instructions in the *Product Information Guide*.

- 1 Turn the computer over.
- 2 Remove the optical-drive security screw.
- 3 Insert a scribe into the notch and push it to the side to release the drive from the bay.

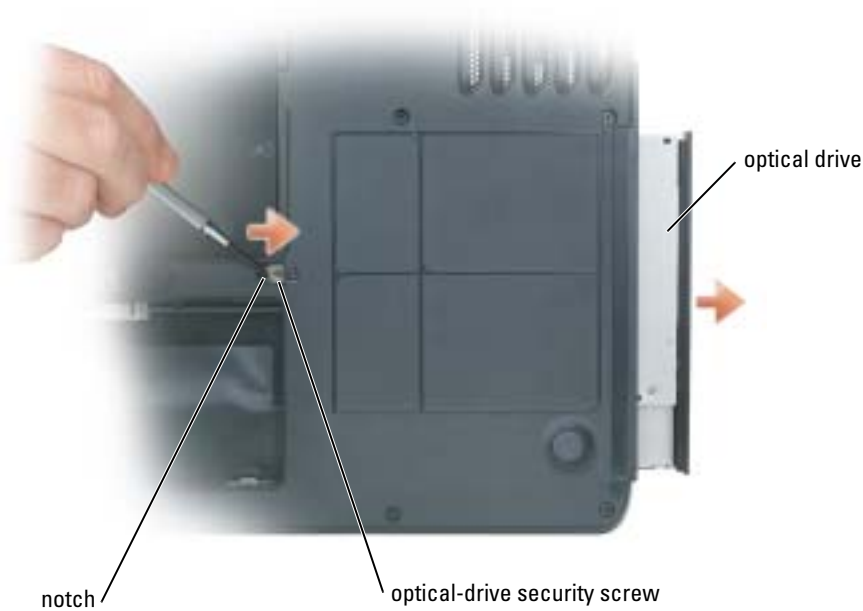

- 4 Slide the drive out of the bay.

Hinge Cover

 **CAUTION:** Before you begin any of the procedures in this section, follow the safety instructions in the *Product Information Guide*.

 **NOTICE:** To avoid electrostatic discharge, ground yourself by using a wrist grounding strap or by periodically touching an unpainted metal surface (such as a connector on the back of the computer).

 **NOTICE:** To avoid damaging the system board, you must remove the main battery before you begin working inside the computer.

1 Follow the procedures in "Before You Begin" on page 75.

2 Remove the hinge cover.:

a Open the display all the way (180 degrees) so that it lies flat against your work surface.

 **NOTICE:** To avoid damaging the hinge cover, do not lift the cover on both sides simultaneously.

b Insert a scribe in the indent to lift the hinge cover on the right side.

c Ease the hinge cover up, moving from right to left, and remove it.

 **NOTE:** When replacing the hinge cover, first insert the left edge and then press from left to right until the cover snaps into place.



Keyboard

⚠ CAUTION: Before you begin any of the procedures in this section, follow the safety instructions in the *Product Information Guide*.

👉 NOTICE: To avoid electrostatic discharge, ground yourself by using a wrist grounding strap or by periodically touching an unpainted metal surface (such as a connector on the back of the computer).

👉 NOTICE: To avoid damaging the system board, you must remove the main battery before you begin working inside the computer.

1 Follow the procedures in "Before You Begin" on page 75.

2 Open the display.

3 Remove the hinge cover. See "Hinge Cover" on page 89.

4 Remove the keyboard:

a Remove the two screws at the top of the keyboard.

👉 NOTICE: The keycaps on the keyboard are fragile, easily dislodged, and time-consuming to replace. Be careful when removing and handling the keyboard.

b Lift up the keyboard and hold it up and slightly forward to allow access to the keyboard connector.

c Pull up on the keyboard connector pull-tab to disconnect the keyboard connector from the system board.



- ➡ **NOTICE:** To avoid scratching the palm rest when replacing the keyboard, hook the five tabs along the front edge of the keyboard into the palm rest, and then secure the keyboard in place.

Internal Card With Bluetooth® Wireless Technology

⚠ **CAUTION:** Before you begin any of the procedures in this section, follow the safety instructions in the *Product Information Guide*.

- ➡ **NOTICE:** To avoid electrostatic discharge, ground yourself by using a wrist grounding strap or by periodically touching an unpainted metal surface (such as a connector on the back of the computer).
- ➡ **NOTICE:** To avoid damaging the system board, you must remove the main battery before you begin working inside the computer.

If you ordered a card with Bluetooth wireless technology with your computer, it is already installed.

- 1 Follow the procedures in "Before You Begin" on page 75.
- 2 If you have not already removed the battery, do so now.
Slide and hold the battery-bay latch release on the bottom of the computer, and then remove the battery from the bay.
- 3 Open the card door and remove it from the computer.
- 4 Pull the card out of the compartment so that you can disconnect the card from its cable and remove it from the computer.
- 5 To replace the card, connect the card to the cable and then carefully insert it into the compartment.
- 6 Replace the card door by inserting the small center tab into the notch at the base of the compartment and snapping the card into place.

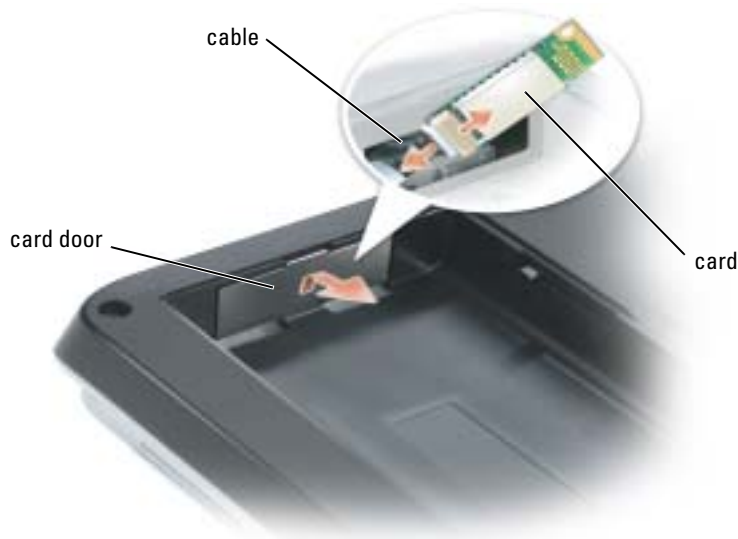

Appendix

Specifications

Processor	
Processor type	Intel® Pentium® M or Intel Celeron® M
L1 cache	32 KB
L2 cache	1 MB, 2 MB
External bus frequency	400 MHz and 533 MHz
System Information	
System chip set	Intel 915GM or Intel 915PM
Data bus width	64 bits
DRAM bus width	Dual channel (2) 64-bit busses
Processor address bus width	32 bits
Flash EPROM	1 MB
Graphics Bus	PCI-E X16
PCI bus	32 bits
PC Card	
CardBus controller	Ricoh R5C841
PC Card connector	one (supports one Type I or Type II card)
Cards supported	3.3 V and 5 V
PC Card connector size	68 pins
Data width (maximum)	PCMCIA 16 bits CardBus 32 bits
Memory	
Memory module connector	two user-accessible SODIMM connectors
Memory module capacities	256 MB, 512 MB, and 1 GB

Memory (continued)

Memory type	1.8-V SODIMM DDR-2
Minimum memory	256 MB
Maximum memory	2 GB

Ports and Connectors

Audio	microphone connector, stereo headphone/speakers connector
IEEE 1394a	4-pin serial connector
Mini PCI	one Type IIIA Mini PCI card slot
Modem	RJ-11 port
Network adapter	RJ-45 port
S-video TV-out	7-pin mini-DIN connector (optional S-video to composite video adapter cable)
USB	four 4-pin USB 2.0-compliant connectors
Video	15-hole connector
SDI/O	one slot

Communications

Modem:	
Type	v.92 56K MDC
Controller	softmodem
Interface	internal AC'97 bus
Network adapter	10/100 Ethernet LAN on system board
Wireless	internal Mini PCI Wi-Fi and Bluetooth® wireless technology support

Video

Video type:	integrated on system board
Data bus	PCI
Video controller	Intel 915 GM
Video memory	Up to 64 MB of shared memory
LCD interface	LVDS
TV support	NTSC/PAL

Video (continued)

Video type:	discrete video card
Data bus	PCI Express X16
Video controller	ATI Mobility Radeon X300
Video memory	64 MB and 128 MB
LCD interface	LVDS
TV support	NTSC or PAL in S-video and composite modes

Audio

Audio type	AC'97 (Soft Audio)
Audio controller	
Stereo conversion	18-bit (analog-to-digital and digital-to-analog)
Interfaces:	
Internal	PCI bus/AC'97
External	microphone-in connector, stereo headphones/speakers connector
Speaker	two 4-ohm speakers
Internal speaker amplifier	1-W channel into 4 ohms
Volume controls	keyboard shortcuts, program menus, media control buttons
Audio controller	Sigmatel STAC9751 AC'97 Codec

Display

Type (active-matrix TFT)	15.4-inch WXGA, WSXGA+, and WUXGA
Dimensions:	
Height	222.5 mm (8.8 inches)
Width	344.5 mm (13.6 inches)
Diagonal	391.2 mm (15.4 inches)
Maximum resolutions:	
WXGA	1280 x 800 at 16.7 million colors
WSXGA+	1680 x 1050 at 16.7 million colors
WUXGA	1920 x 1200 at 16.7 million colors

Display (continued)

Refresh rate	60 Hz
Operating angle	0° (closed) to 180°
Viewing angles:	
Horizontal	±65° (WSXGA+, WUXGA) ±40° (WXGA)
Vertical	±50° (WSXGA+, WUXGA) +10°/-30° (WXGA)
Pixel pitch:	
WXGA	0.258 mm
WSXGA+	0.197 mm
WUXGA	0.173 mm
Power consumption (panel with backlight) (typical)	6.0 W (maximum)
Controls	brightness can be controlled through keyboard shortcuts

Keyboard

Number of keys	87 (U.S. and Canada); 88 (Europe); 91 (Japan)
Layout	QWERTY/AZERTY/Kanji

Touch Pad

X/Y position resolution (graphics table mode)	240 cpi
Size:	
Width	73.0-mm (2.9-inch) sensor-active area
Height	42.9-mm (1.7-inch) rectangle

Battery

Type	9-cell "smart" lithium ion 6-cell "smart" lithium ion
Dimensions:	
Depth	88.5 mm (3.5 inches)
Height	21.5 mm (0.8 inch)
Width	139.0 mm (5.5 inches)

Battery (continued)

Weight	0.4 kg (0.9 lb) (9 cell) 0.3 kg (0.6 lb) (6 cell)
Voltage	14.8 VDC
Charge time (approximate):	
Computer off	2 hours
Operating time	Battery operating time varies depending on operating conditions and can be significantly reduced under certain power-intensive conditions. See "Power Problems" on page 63. See "Using a Battery" on page 27 for more information on battery life.
Life span (approximate)	500 discharge/charge cycles
Temperature range:	
Operating	0° to 35°C (32° to 95°F)
Storage	-40° to 65°C (-40° to 149°F)
Coin-cell battery	CR-2032

AC Adapter

Input voltage	90–264 VAC
Input current (maximum)	1.7 A
Input frequency	47–63 Hz
Output current	4.5 A (maximum at 4-second pulse); 3.5 A (continuous)
Output power	65 W
Rated output voltage	19.5 VDC
Dimensions:	
Height	27.9 mm (1.1 inches)
Width	58.4 mm (2.3 inches)
Depth	133.9 mm (5.6 inches)
Weight (with cables)	0.4 kg (0.9 lb)
Temperature range:	
Operating	0° to 35°C (32° to 95°F)
Storage	-40° to 65°C (-40° to 149°F)

Physical

Height	38 mm (1.5 inches)
Width	354 mm (13.9 inches)
Depth	260 mm (10.2 inches)
Weight (with 6-cell battery):	
Configurable to less than	3.08 kg (6.8 lb)

Environmental

Temperature range:

Operating	0° to 40°C (32° to 104°F)
Storage	-40° to 65°C (-40° to 149°F)

Relative humidity (maximum):

Operating	10% to 90% (noncondensing)
Storage	5% to 95% (noncondensing)

Maximum vibration (using a random-vibration spectrum that simulates user environment):

Operating	0.9 GRMS
Storage	1.3 GRMS

Maximum shock (measured with hard drive in head-parked position and a 2-ms half-sine pulse):

Operating	122 G
Storage	163 G

Altitude (maximum):

Operating	-15.2 to 3048 m (-50 to 10,000 ft)
Storage	-15.2 to 10,668 m (-50 to 35,000 ft)

Using the System Setup Program

Overview

 **NOTE:** Your operating system may automatically configure most of the options available in system setup, thus overriding options that you set through system setup. (An exception is the **External Hot Key** option, which you can disable or enable only through system setup.) For more information on configuring features for your operating system, see the Windows Help and Support Center. To access help, see "Finding Information" on page 9.

The system setup screens display the current setup information and settings for your computer, such as:

- System configuration
- Basic device-configuration settings
- System security and hard-drive password settings
- Power management settings
- Boot (start-up) configuration and display settings
- Docking-device settings
- Wireless control settings

 **NOTICE:** Unless you are an expert computer user or are directed to do so by Dell technical support, do not change the system setup settings. Certain changes might make your computer work incorrectly.

Viewing the System Setup Screen

- 1 Turn on (or restart) your computer.
- 2 When the DELL™ logo appears, press <F2> immediately. If you wait too long and the Windows logo appears, continue to wait until you see the Windows desktop. Then shut down your computer and try again.

System Setup Screen

The system setup screen consists of three windows of information. The window on the left contains an expandable hierarchy of control categories. If you select (highlight) a category (such as **System**, **Onboard Devices**, or **Video**) and press <Enter>, you can show or hide the related subcategories. The window on the right contains information about the category or subcategory selected in the window on the left.

The window at the bottom tells you how to control system setup with key functions. Use these keys to select a category, modify its settings, or exit system setup.

Commonly Used Options

Certain options require that you reboot the computer for new settings to take effect.

Changing the Boot Sequence

The *boot sequence*, or *boot order*, tells the computer where to look to find the software needed to start the operating system. You can control the boot sequence and enable/disable devices using the **Boot Order** page of system setup.

 **NOTE:** To change the boot sequence on a one-time-only basis, see "Performing a One-Time Boot" on page 100.

The **Boot Order** page displays a general list of the bootable devices that may be installed in your computer, including but not limited to the following:

- Diskette Drive
- Internal HDD
- USB Storage Device
- CD/DVD/CD-RW drive
- Modular bay HDD

 **NOTE:** Only devices that are preceded by a number are bootable.

During the boot routine, the computer starts at the top of the list and scans each enabled device for the operating system start-up files. When the computer finds the files, it stops searching and starts the operating system.

To control the boot devices, select (highlight) a device by pressing the down-arrow or up-arrow key, and then enable or disable the device or change its order in the list.

- To enable or disable a device, highlight the item and press the space bar. Enabled items are preceded by a number; disabled items are not preceded by a number.
- To reorder a device in the list, highlight the device and press either <u> to move the device up the list or <d> to move a device down the list.

Boot sequence changes take effect as soon as you save the changes and exit system setup.

Performing a One-Time Boot

You can set a one-time-only boot sequence without entering system setup. (You can also use this procedure to boot the Dell Diagnostics on the diagnostics utility partition on your hard drive.)

- 1 Shut down the computer through the **Start** menu.
- 2 Connect the computer to an electrical outlet.
- 3 Turn on the computer. When the DELL logo appears, press <F2> immediately. If you wait too long and the Windows logo appears, continue to wait until you see the Windows desktop. Then shut down your computer and try again.
- 4 When the boot device list appears, highlight the device from which you want to boot and press <Enter>.

The computer boots to the selected device.

The next time you reboot the computer, the previous boot order is restored.

Dell Technical Support Policy (U.S. Only)

Technician-assisted technical support requires the cooperation and participation of the customer in the troubleshooting process and provides for restoration of the operating system, software programs, and hardware drivers to the original default configuration as shipped from Dell, as well as the verification of appropriate functionality of the computer and all Dell-installed hardware. In addition to this technician-assisted technical support, online technical support is available at support.dell.com. Additional technical support options may be available for purchase.

Dell provides limited technical support for the computer and any "Dell-installed" software and peripherals¹. Support for third-party software and peripherals is provided by the original manufacturer, including those purchased and/or installed through Dell Software and Peripherals, Readyware, and Custom Factory Integration².

- ¹ Repair services are provided pursuant to the terms and conditions of your limited warranty and any optional support service contract purchased with the computer.
- ² All Dell-standard components included in a Custom Factory Integration (CFI) project are covered by the standard Dell limited warranty for your computer. However, Dell also extends a parts replacement program to cover all nonstandard, third-party hardware components integrated through CFI for the duration of the computer's service contract.

Definition of "Dell-Installed" Software and Peripherals

Dell-installed software includes the operating system and some of the software programs that are installed on the computer during the manufacturing process (Microsoft[®] Office, Norton Antivirus, and so on).

Dell-installed peripherals include any internal expansion cards, or Dell-branded module bay or PC Card accessories. In addition, any Dell-branded monitors, keyboards, mice, speakers, microphones for telephonic modems, docking stations/port replicators, networking products, and all associated cabling are included.

Definition of "Third-Party" Software and Peripherals

Third-party software and peripherals include any peripheral, accessory, or software program sold by Dell not under the Dell brand (printers, scanners, cameras, games, and so on). Support for all third-party software and peripherals is provided by the original manufacturer of the product.

FCC Notices (U.S. Only)

Most Dell computers are classified by the Federal Communications Commission (FCC) as Class B digital devices. To determine which classification applies to your computer, examine all FCC registration labels located on the bottom, side, or back panel of your computer, on card-mounting brackets, and on the cards themselves. If any one of the labels carries a Class A rating, your entire computer is considered to be a Class A digital device. If *all* labels carry an FCC Class B rating as distinguished by either an FCC ID number or the FCC logo, (FC), your computer is considered to be a Class B digital device.

Once you have determined your computer's FCC classification, read the appropriate FCC notice. Note that FCC regulations provide that changes or modifications not expressly approved by Dell could void your authority to operate this equipment.

This device complies with Part 15 of the FCC Rules. Operation is subject to the following two conditions:

- This device may not cause harmful interference.
- This device must accept any interference received, including interference that may cause undesired operation.

Class A

This equipment has been tested and found to comply with the limits for a Class A digital device pursuant to Part 15 of the FCC Rules. These limits are designed to provide reasonable protection against harmful interference when the equipment is operated in a commercial environment. This equipment generates, uses, and can radiate radio frequency energy and, if not installed and used in accordance with the manufacturer's instruction manual, may cause harmful interference with radio communications. Operation of this equipment in a residential area is likely to cause harmful interference, in which case you will be required to correct the interference at your own expense.

Class B

This equipment has been tested and found to comply with the limits for a Class B digital device pursuant to Part 15 of the FCC Rules. These limits are designed to provide reasonable protection against harmful interference in a residential installation. This equipment generates, uses, and can radiate radio frequency energy and, if not installed and used in accordance with the manufacturer's instruction manual, may cause interference with radio communications. However, there is no guarantee that interference will not occur in a particular installation. If this equipment does cause harmful interference to radio or television reception, which can be determined by turning the equipment off and on, you are encouraged to try to correct the interference by one or more of the following measures:

- Reorient or relocate the receiving antenna.
- Increase the separation between the equipment and the receiver.
- Connect the equipment into an outlet on a circuit different from that to which the receiver is connected.
- Consult the dealer or an experienced radio/television technician for help.

FCC Identification Information

The following information is provided on the device or devices covered in this document in compliance with FCC regulations:

- Model number: PP12L
- Company name:

Dell Inc.
One Dell Way
Round Rock, Texas 78682 USA
512-338-4400

Macrovision Product Notice

This product incorporates copyright protection technology that is protected by U.S. patents and other intellectual property rights. Use of this copyright protection technology must be authorized by Macrovision, and is intended for home and other limited viewing uses only unless otherwise authorized by Macrovision. Reverse engineering or disassembly is prohibited.

Contacting Dell

To contact Dell electronically, you can access the following websites:

- www.dell.com
- support.dell.com (technical support)
- premiersupport.dell.com (technical support for educational, government, healthcare, and medium/large business customers, including Premier, Platinum, and Gold customers)

For specific web addresses for your country, find the appropriate country section in the table below.

NOTE: Toll-free numbers are for use within the country for which they are listed.

NOTE: In certain countries, technical support specific to Dell XPS portable computers is available at a separate telephone number listed for participating countries. If you do not see a telephone number listed that is specific for XPS portable computers, you may contact Dell through the technical support number listed and your call will be routed appropriately.

When you need to contact Dell, use the electronic addresses, telephone numbers, and codes provided in the following table. If you need assistance in determining which codes to use, contact a local or an international operator.

Country (City) International Access Code Country Code City Code	Department Name or Service Area, Website and E-Mail Address	Area Codes, Local Numbers, and Toll-Free Numbers
Anguilla	General Support	toll-free: 800-335-0031
Antigua and Barbuda	General Support	1-800-805-5924
Argentina (Buenos Aires) International Access Code: 00 Country Code: 54 City Code: 11	Website: www.dell.com.ar E-mail: us_latin_services@dell.com E-mail for desktop and portable computers: la-techsupport@dell.com E-mail for servers and EMC [®] storage products: la_enterprise@dell.com Customer Care Tech Support Tech Support Services Sales	toll-free: 0-800-444-0730 toll-free: 0-800-444-0733 toll-free: 0-800-444-0724 0-810-444-3355
Aruba	General Support	toll-free: 800-1578
Australia (Sydney) International Access Code: 0011 Country Code: 61 City Code: 2	E-mail (Australia): au_tech_support@dell.com E-mail Customer Care (Australia and New Zealand): apcustserv@dell.com Home and Small Business Government and Business Preferred Accounts Division (PAD) Customer Care (after sales) Technical Support (portables and desktops) Technical Support (servers and workstations) Corporate Sales Transaction Sales Fax	1-300-655-533 toll-free: 1-800-633-559 toll-free: 1-800-060-889 toll-free 1-333-55(option 3) toll-free: 1-300-655-533 toll-free: 1-800-733-314 toll-free: 1-800-808-385 toll-free: 1-800-808-312 toll-free: 1-800-818-341

Country (City) International Access Code Country Code City Code	Department Name or Service Area, Website and E-Mail Address	Area Codes, Local Numbers, and Toll-Free Numbers
Austria (Vienna)	Website: support.euro.dell.com	
International Access Code: 900	E-mail: tech_support_central_europe@dell.com	
Country Code: 43	Home/Small Business Sales	0820 240 530 00
City Code: 1	Home/Small Business Fax	0820 240 530 49
	Home/Small Business Customer Care	0820 240 530 14
	Preferred Accounts/Corporate Customer Care	0820 240 530 16
	Technical Support for XPS portable computers only	0820 240 530 81
	Home/Small Business Technical Support for all other Dell computers	0820 240 530 14
	Preferred Accounts/Corporate Technical Support	0660 8779
	Switchboard	0820 240 530 00
Bahamas	General Support	toll-free: 1-866-278-6818
Barbados	General Support	1-800-534-3066
Belgium (Brussels)	Website: support.euro.dell.com	
International Access Code: 00	E-mail for French-speaking Customers: support.euro.dell.com/be/fr/emaildell/	
Country Code: 32	Technical Support for XPS portable computers only	02 481 92 96
City Code: 2	Technical Support for all other Dell computers	02 481 92 88
	Technical Support Fax	02 481 92 95
	Customer Care	02 713 15 65
	Corporate Sales	02 481 91 00
	Fax	02 481 92 99
	Switchboard	02 481 91 00
Bermuda	General Support	1-800-342-0671
Bolivia	General Support	toll-free: 800-10-0238
Brazil	Website: www.dell.com/br	
International Access Code: 00	Customer Support, Technical Support	0800 90 3355
Country Code: 55	Technical Support Fax	51 481 5470
City Code: 51	Customer Care Fax	51 481 5480
	Sales	0800 90 3390
British Virgin Islands	General Support	toll-free: 1-866-278-6820

Country (City) International Access Code Country Code City Code	Department Name or Service Area, Website and E-Mail Address	Area Codes, Local Numbers, and Toll-Free Numbers
Brunei	Customer Technical Support (Penang, Malaysia)	604 633 4966
Country Code: 673	Customer Care (Penang, Malaysia)	604 633 4888
	Transaction Sales (Penang, Malaysia)	604 633 4955
Canada (North York, Ontario)	Online Order Status: www.dell.ca/ostatus	
International Access Code: 011	AutoTech (automated technical support)	toll-free: 1-800-247-9362
	Customer Care (Home Sales/Small Business)	toll-free: 1-800-847-4096
	Customer Care (med./large business, government)	toll-free: 1-800-326-9463
	Technical Support (Home Sales/Small Business)	toll-free: 1-800-847-4096
	Technical Support (med./large bus., government)	toll-free: 1-800-387-5757
	Technical Support (printers, projectors, televisions, handhelds, digital jukebox, and wireless)	1-877-335-5767
	Sales (Home Sales/Small Business)	toll-free: 1-800-387-5752
	Sales (med./large bus., government)	toll-free: 1-800-387-5755
	Spare Parts Sales & Extended Service Sales	1 866 440 3355
Cayman Islands	General Support	1-800-805-7541
Chile (Santiago)	Sales, Customer Support, and Technical Support	toll-free: 1230-020-4823
Country Code: 56		
City Code: 2		

Country (City) International Access Code Country Code City Code	Department Name or Service Area, Website and E-Mail Address	Area Codes, Local Numbers, and Toll-Free Numbers
China (Xiamen) Country Code: 86 City Code: 592	Technical Support website: support.dell.com.cn Technical Support E-mail: cn_support@dell.com Customer Care E-mail: customer_cn@dell.com	
	Technical Support Fax	592 818 1350
	Technical Support (Dell™ Dimension™ and Inspiron)	toll-free: 800 858 2969
	Technical Support (OptiPlex™, Latitude™, and Dell Precision™)	toll-free: 800 858 0950
	Technical Support (servers and storage)	toll-free: 800 858 0960
	Technical Support (projectors, PDAs, switches, routers, and so on)	toll-free: 800 858 2920
	Technical Support (printers)	toll-free: 800 858 2311
	Customer Care	toll-free: 800 858 2060
	Customer Care Fax	592 818 1308
	Home and Small Business	toll-free: 800 858 2222
	Preferred Accounts Division	toll-free: 800 858 2557
	Large Corporate Accounts GCP	toll-free: 800 858 2055
	Large Corporate Accounts Key Accounts	toll-free: 800 858 2628
	Large Corporate Accounts North	toll-free: 800 858 2999
	Large Corporate Accounts North Government and Education	toll-free: 800 858 2955
	Large Corporate Accounts East	toll-free: 800 858 2020
	Large Corporate Accounts East Government and Education	toll-free: 800 858 2669
	Large Corporate Accounts Queue Team	toll-free: 800 858 2572
	Large Corporate Accounts South	toll-free: 800 858 2355
	Large Corporate Accounts West	toll-free: 800 858 2811
	Large Corporate Accounts Spare Parts	toll-free: 800 858 2621
Colombia	General Support	980-9-15-3978
Costa Rica	General Support	0800-012-0435

Country (City) International Access Code Country Code City Code	Department Name or Service Area, Website and E-Mail Address	Area Codes, Local Numbers, and Toll-Free Numbers
Czech Republic (Prague)	Website: support.euro.dell.com	
International Access Code: 00	E-mail: czech_dell@dell.com	
Country Code: 420	Technical Support	22537 2727
	Customer Care	22537 2707
	Fax	22537 2714
	Tech Fax	22537 2728
	Switchboard	22537 2711
Denmark (Copenhagen)	Website: support.euro.dell.com	
International Access Code: 00	E-mail: support.euro.dell.com/dk/da/emaildell/	
Country Code: 45	Technical Support for XPS portable computers only	7010 0074
	Technical Support for all other Dell computers	7023 0182
	Customer Care (Relational)	7023 0184
	Home/Small Business Customer Care	3287 5505
	Switchboard (Relational)	3287 1200
	Switchboard Fax (Relational)	3287 1201
	Switchboard (Home/Small Business)	3287 5000
	Switchboard Fax (Home/Small Business)	3287 5001
Dominica	General Support	toll-free: 1-866-278-6821
Dominican Republic	General Support	1-800-148-0530
Ecuador	General Support	toll-free: 999-119
El Salvador	General Support	01-899-753-0777
Finland (Helsinki)	Website: support.euro.dell.com	
International Access Code: 990	E-mail: support.euro.dell.com/fi/fi/emaildell/	
Country Code: 358	Technical Support	09 253 313 60
City Code: 9	Customer Care	09 253 313 38
	Fax	09 253 313 99
	Switchboard	09 253 313 00

Country (City) International Access Code Country Code City Code	Department Name or Service Area, Website and E-Mail Address	Area Codes, Local Numbers, and Toll-Free Numbers
France (Paris) (Montpellier) International Access Code: 00 Country Code: 33 City Codes: (1) (4)	Website: support.euro.dell.com E-mail: support.euro.dell.com/fr/fr/emaildell/ Home and Small Business Technical Support for XPS portable computers only Technical Support for all other Dell computers Customer Care Switchboard Switchboard (calls from outside of France) Sales Fax Fax (calls from outside of France) Corporate Technical Support Customer Care Switchboard Sales Fax	0825 387 129 0825 387 270 0825 823 833 0825 004 700 04 99 75 40 00 0825 004 700 0825 004 701 04 99 75 40 01 0825 004 719 0825 338 339 01 55 94 71 00 01 55 94 71 00 01 55 94 71 01
Germany (Langen) International Access Code: 00 Country Code: 49 City Code: 6103	Website: support.euro.dell.com E-mail: tech_support_central_europe@dell.com Technical Support for XPS portable computers only Technical Support for all other Dell computers Home/Small Business Customer Care Global Segment Customer Care Preferred Accounts Customer Care Large Accounts Customer Care Public Accounts Customer Care Switchboard	06103 766-7222 06103 766-7200 0180-5-224400 06103 766-9570 06103 766-9420 06103 766-9560 06103 766-9555 06103 766-7000

Country (City) International Access Code Country Code City Code	Department Name or Service Area, Website and E-Mail Address	Area Codes, Local Numbers, and Toll-Free Numbers
Greece International Access Code: 00 Country Code: 30	Website: support.euro.dell.com E-mail: support.euro.dell.com/gr/en/emaildell/ Technical Support Gold Service Technical Support Switchboard Gold Service Switchboard Sales Fax	00800-44 14 95 18 00800-44 14 00 83 2108129810 2108129811 2108129800 2108129812
Grenada	General Support	toll-free: 1-866-540-3355
Guatemala	General Support	1-800-999-0136
Guyana	General Support	toll-free: 1-877-270-4609
Hong Kong International Access Code: 001 Country Code: 852	Website: support.ap.dell.com Technical Support E-mail: apsupport@dell.com Technical Support (Dimension and Inspiron) Technical Support (OptiPlex, Latitude, and Dell Precision) Technical Support (PowerApp™, PowerEdge™, PowerConnect™, and PowerVault™) Customer Care Large Corporate Accounts Global Customer Programs Medium Business Division Home and Small Business Division	2969 3188 2969 3191 2969 3196 3416 0910 3416 0907 3416 0908 3416 0912 2969 3105
India	E-mail: india_support_desktop@dell.com india_support_notebook@dell.com india_support_Server@dell.com Technical Support Sales (Large Corporate Accounts) Sales (Home and Small Business)	1600338045 and 1600448046 1600 33 8044 1600 33 8046

Country (City) International Access Code Country Code City Code	Department Name or Service Area, Website and E-Mail Address	Area Codes, Local Numbers, and Toll-Free Numbers
Ireland (Cherrywood)	Website: support.euro.dell.com	
International Access Code: 16	E-mail: dell_direct_support@dell.com	
Country Code: 353	Technical Support for XPS portable computers only	1850 200 722
City Code: 1	Technical Support for all other Dell computers	1850 543 543
	U.K. Technical Support (dial within U.K. only)	0870 908 0800
	Home User Customer Care	01 204 4014
	Small Business Customer Care	01 204 4014
	U.K. Customer Care (dial within U.K. only)	0870 906 0010
	Corporate Customer Care	1850 200 982
	Corporate Customer Care (dial within U.K. only)	0870 907 4499
	Ireland Sales	01 204 4444
	U.K. Sales (dial within U.K. only)	0870 907 4000
	Fax/Sales Fax	01 204 0103
	Switchboard	01 204 4444
Italy (Milan)	Website: support.euro.dell.com	
International Access Code: 00	E-mail: support.euro.dell.com/it/it/emailedell/	
Country Code: 39	Home and Small Business	
City Code: 02	Technical Support	02 577 826 90
	Customer Care	02 696 821 14
	Fax	02 696 821 13
	Switchboard	02 696 821 12
	Corporate	
	Technical Support	02 577 826 90
	Customer Care	02 577 825 55
	Fax	02 575 035 30
	Switchboard	02 577 821
Jamaica	General Support (dial from within Jamaica only)	1-800-682-3639

Country (City) International Access Code Country Code City Code	Department Name or Service Area, Website and E-Mail Address	Area Codes, Local Numbers, and Toll-Free Numbers
Japan (Kawasaki)	Website: support.jp.dell.com	
International Access Code: 001	Technical Support (servers)	toll-free: 0120-198-498
Country Code: 81	Technical Support outside of Japan (servers)	81-44-556-4162
City Code: 44	Technical Support (Dimension and Inspiron)	toll-free: 0120-198-226
	Technical Support outside of Japan (Dimension and Inspiron)	81-44-520-1435
	Technical Support (Dell Precision, OptiPlex, and Latitude)	toll-free:0120-198-433
	Technical Support outside of Japan (Dell Precision, OptiPlex, and Latitude)	81-44-556-3894
	Technical Support (PDAs, projectors, printers, routers)	toll-free: 0120-981-690
	Technical Support outside of Japan (PDAs, projectors, printers, routers)	81-44-556-3468
	Faxbox Service	044-556-3490
	24-Hour Automated Order Service	044-556-3801
	Customer Care	044-556-4240
	Business Sales Division (up to 400 employees)	044-556-1465
	Preferred Accounts Division Sales (over 400 employees)	044-556-3433
	Large Corporate Accounts Sales (over 3500 employees)	044-556-3430
	Public Sales (government agencies, educational institutions, and medical institutions)	044-556-1469
	Global Segment Japan	044-556-3469
	Individual User	044-556-1760
	Switchboard	044-556-4300
Korea (Seoul)	E-mail: krsupport@dell.com	
International Access Code: 001	Technical Support	toll-free: 080-200-3800
Country Code: 82	Technical Support (Dimension, PDA, Electronics and Accessories)	toll-free: 080-200-3801
City Code: 2	Sales	toll-free: 080-200-3600
	Fax	2194-6202
	Switchboard	2194-6000

Country (City) International Access Code Country Code City Code	Department Name or Service Area, Website and E-Mail Address	Area Codes, Local Numbers, and Toll-Free Numbers
Latin America	Customer Technical Support (Austin, Texas, U.S.A.)	512 728-4093
	Customer Service (Austin, Texas, U.S.A.)	512 728-3619
	Fax (Technical Support and Customer Service) (Austin, Texas, U.S.A.)	512 728-3883
	Sales (Austin, Texas, U.S.A.)	512 728-4397
	SalesFax (Austin, Texas, U.S.A.)	512 728-4600 or 512 728-3772
Luxembourg	Website: support.euro.dell.com	
International Access Code: 00	Technical Support	342 08 08 075
Country Code: 352	Home/Small Business Sales	+32 (0)2 713 15 96
	Corporate Sales	26 25 77 81
	Customer Care	+32 (0)2 481 91 19
	Fax	26 25 77 82
Macao	Technical Support	toll-free: 0800 105
Country Code: 853	Customer Service (Xiamen, China)	34 160 910
	Transaction Sales (Xiamen, China)	29 693 115
Malaysia (Penang)	Website: support.ap.dell.com	
International Access Code: 00	Technical Support (Dell Precision, OptiPlex, and Latitude)	toll-free: 1 800 880 193
Country Code: 60	Technical Support (Dimension, Inspiron, and Electronics and Accessories)	toll-free: 1 800 881 306
City Code: 4	Technical Support (PowerApp, PowerEdge, PowerConnect, and PowerVault)	toll-free: 1800 881 386
	Customer Care	toll-free: 1800 881 306 (option 6)
	Transaction Sales	toll-free: 1 800 888 202
	Corporate Sales	toll-free: 1 800 888 213

Country (City) International Access Code Country Code City Code	Department Name or Service Area, Website and E-Mail Address	Area Codes, Local Numbers, and Toll-Free Numbers
Mexico International Access Code: 00 Country Code: 52	Customer Technical Support Sales Customer Service Main	001-877-384-8979 or 001-877-269-3383 50-81-8800 or 01-800-888-3355 001-877-384-8979 or 001-877-269-3383 50-81-8800 or 01-800-888-3355
Montserrat	General Support	toll-free: 1-866-278-6822
Netherlands Antilles	General Support	001-800-882-1519
Netherlands (Amsterdam) International Access Code: 00 Country Code: 31 City Code: 20	Website: support.euro.dell.com Technical Support for XPS portable computers only Technical Support for all other Dell computers Technical Support Fax Home/Small Business Customer Care Relational Customer Care Home/Small Business Sales Relational Sales Home/Small Business Sales Fax Relational Sales Fax Switchboard Switchboard Fax	020 674 45 94 020 674 45 00 020 674 47 66 020 674 42 00 020 674 4325 020 674 55 00 020 674 50 00 020 674 47 75 020 674 47 50 020 674 50 00 020 674 47 50

Country (City) International Access Code Country Code City Code	Department Name or Service Area, Website and E-Mail Address	Area Codes, Local Numbers, and Toll-Free Numbers
New Zealand	E-mail (New Zealand): nz_tech_support@dell.com	
International Access Code: 00	E-mail Customer Care (Australia and	
Country Code: 64	New Zealand): apcustserv@dell.com	
	Customer Care	toll-free: 0800-289-335 (option 3)
	Technical Support (for desktop and portable computers)	toll-free: 0800 446 255
	Technical Support (for servers and workstations)	toll-free: 0800 443 563
	Home and Small Business	0800 446 255
	Government and Business	0800 444 617
	Sales	0800 441 567
	Fax	0800 441 566
Nicaragua	General Support	001-800-220-1006
Norway (Lysaker)	Website: support.euro.dell.com	
International Access Code: 00	E-mail: support.euro.dell.com/no/no/emaildell/	
Country Code: 47	Technical Support for XPS portable computers only	815 35 043
	Technical Support for all other Dell products	671 16882
	Relational Customer Care	671 17575
	Home/Small Business Customer Care	23162298
	Switchboard	671 16800
	Fax Switchboard	671 16865
Panama	General Support	001-800-507-0962
Peru	General Support	0800-50-669
Poland (Warsaw)	Website: support.euro.dell.com	
International Access Code: 011	E-mail: pl_support_tech@dell.com	
Country Code: 48	Customer Service Phone	57 95 700
City Code: 22	Customer Care	57 95 999
	Sales	57 95 999
	Customer Service Fax	57 95 806
	Reception Desk Fax	57 95 998
	Switchboard	57 95 999

Country (City) International Access Code Country Code City Code	Department Name or Service Area, Website and E-Mail Address	Area Codes, Local Numbers, and Toll-Free Numbers
Portugal	Website: support.euro.dell.com	
International Access Code: 00	E-mail: support.euro.dell.com/pt/en/emaildell/	
Country Code: 351	Technical Support	707200149
	Customer Care	800 300 413
	Sales	800 300 410 or 800 300 411 or 800 300 412 or 21 422 07 10
	Fax	21 424 01 12
Puerto Rico	General Support	1-800-805-7545
St. Kitts and Nevis	General Support	toll-free: 1-877-441-4731
St. Lucia	General Support	1-800-882-1521
St. Vincent and the Grenadines	General Support	toll-free: 1-877-270-4609
Singapore (Singapore)	Website: support.ap.dell.com	
International Access Code: 005	Technical Support (Dimension, Inspiron, and Electronics and Accessories)	toll-free: 1800 394 7430
Country Code: 65	Technical Support (OptiPlex, Latitude, and Dell Precision)	toll-free: 1800 394 7488
	Technical Support (PowerApp, PowerEdge, PowerConnect, and PowerVault)	toll-free: 1800 394 7478
	Customer Care	toll-free: 1 800 394 7430 (option 6)
	Transaction Sales	toll-free: 1 800 394 7412
	Corporate Sales	toll-free: 1 800 394 7419
Slovakia (Prague)	Website: support.euro.dell.com	
International Access Code: 00	E-mail: czech_dell@dell.com	
Country Code: 421	Technical Support	02 5441 5727
	Customer Care	420 22537 2707
	Fax	02 5441 8328
	Tech Fax	02 5441 8328
	Switchboard (Sales)	02 5441 7585

Country (City) International Access Code Country Code City Code	Department Name or Service Area, Website and E-Mail Address	Area Codes, Local Numbers, and Toll-Free Numbers
South Africa (Johannesburg)	Website: support.euro.dell.com	
International Access Code: 09/091	E-mail: dell_za_support@dell.com	
Country Code: 27	Gold Queue	011 709 7713
City Code: 11	Technical Support	011 709 7710
	Customer Care	011 709 7707
	Sales	011 709 7700
	Fax	011 706 0495
	Switchboard	011 709 7700
Southeast Asian and Pacific Countries	Customer Technical Support, Customer Service, and Sales (Penang, Malaysia)	604 633 4810
Spain (Madrid)	Website: support.euro.dell.com	
International Access Code: 00	E-mail: support.euro.dell.com/es/es/emaildell/	
Country Code: 34	Home and Small Business	
City Code: 91	Technical Support	902 100 130
	Customer Care	902 118 540
	Sales	902 118 541
	Switchboard	902 118 541
	Fax	902 118 539
	Corporate	
	Technical Support	902 100 130
	Customer Care	902 115 236
	Switchboard	91 722 92 00
	Fax	91 722 95 83

Country (City) International Access Code Country Code City Code	Department Name or Service Area, Website and E-Mail Address	Area Codes, Local Numbers, and Toll-Free Numbers
Sweden (Upplands Vasby)	Website: support.euro.dell.com	
International Access Code: 00	E-mail: support.euro.dell.com/se/sv/emaildell/	
Country Code: 46	Technical Support for XPS portable computers only	0771 340 340
City Code: 8	Technical Support for all other Dell products	08 590 05 199
	Relational Customer Care	08 590 05 642
	Home/Small Business Customer Care	08 587 70 527
	Employee Purchase Program (EPP) Support	20 140 14 44
	Technical Support Fax	08 590 05 594
	Sales	08 590 05 185
Switzerland (Geneva)	Website: support.euro.dell.com	
International Access Code: 00	E-mail: Tech_support_central_Europe@dell.com	
Country Code: 41	E-mail for French-speaking HSB and Corporate Customers: support.euro.dell.com/ch/fr/emaildell/	
City Code: 22	Technical Support for XPS portable computers only	0848 33 88 57
	Technical Support (Home and Small Business) for all other Dell products	0844 811 411
	Technical Support (Corporate)	0844 822 844
	Customer Care (Home and Small Business)	0848 802 202
	Customer Care (Corporate)	0848 821 721
	Fax	022 799 01 90
	Switchboard	022 799 01 01
Taiwan	Website: support.ap.dell.com	
International Access Code: 002	E-mail: ap_support@dell.com	
Country Code: 886	Technical Support (OptiPlex, Latitude, Inspiron, Dimension, and Electronics and Accessories)	toll-free: 00801 86 1011
	Technical Support (PowerApp, PowerEdge, PowerConnect, and PowerVault)	toll-free: 00801 60 1256
	Customer Care	toll-free: 00801 60 1250 (option 5)
	Transaction Sales	toll-free: 00801 65 1228
	Corporate Sales	toll-free: 00801 651 227

Country (City) International Access Code Country Code City Code	Department Name or Service Area, Website and E-Mail Address	Area Codes, Local Numbers, and Toll-Free Numbers
Thailand	Website: support.ap.dell.com	
International Access Code: 001 Country Code: 66	Technical Support (OptiPlex, Latitude, and Dell Precision)	toll-free: 1800 0060 07
	Technical Support (PowerApp, PowerEdge, PowerConnect, and PowerVault)	toll-free: 1800 0600 09
	Customer Care	toll-free: 1800 006 007 (option 7)
	Corporate Sales	toll-free: 1800 006 009
	Transaction Sales	toll-free: 1800 006 006
Trinidad/Tobago	General Support	1-800-805-8035
Turks and Caicos Islands	General Support	toll-free: 1-866-540-3355
U.K. (Bracknell)	Website: support.euro.dell.com	
International Access Code: 00 Country Code: 44 City Code: 1344	Customer Care website: support.euro.dell.com/uk/en/ECare/Form/Home.asp E-mail: dell_direct_support@dell.com	
	Technical Support (Corporate/Preferred Accounts/PAD [1000+ employees])	0870 908 0500
	Technical Support for XPS portable computers only	0870 366 4180
	Technical Support (direct and general) for all other products	0870 908 0800
	Global Accounts Customer Care	01344 373 186
	Home and Small Business Customer Care	0870 906 0010
	Corporate Customer Care	01344 373 185
	Preferred Accounts (500–5000 employees) Customer Care	0870 906 0010
	Central Government Customer Care	01344 373 193
	Local Government & Education Customer Care	01344 373 199
	Health Customer Care	01344 373 194
	Home and Small Business Sales	0870 907 4000
	Corporate/Public Sector Sales	01344 860 456
	Home and Small Business Fax	0870 907 4006
Uruguay	General Support	toll-free: 000-413-598-2521

Country (City) International Access Code Country Code City Code	Department Name or Service Area, Website and E-Mail Address	Area Codes, Local Numbers, and Toll-Free Numbers
U.S.A. (Austin, Texas)	Automated Order-Status Service	toll-free: 1-800-433-9014
International Access Code: 011	AutoTech (portable and desktop computers)	toll-free: 1-800-247-9362
Country Code: 1	Technical Support (Dell TV, Printers, and Projectors) for Relationship customers	toll-free 1-877-459-7298
	Consumer (Home and Home Office) Technical Support for all other Dell products	toll-free: 1-800-624-9896
	Customer Service	toll-free: 1-800-624-9897
	DellNet™ Service and Support	toll-free: 1-877-Dellnet (1-877-335-5638)
	Employee Purchase Program (EPP) Customers	toll-free: 1-800-695-8133
	Financial Services website: www.dellfinancialservices.com	
	Financial Services (lease/loans)	toll-free: 1-877-577-3355
	Financial Services (Dell Preferred Accounts [DPA])	toll-free: 1-800-283-2210
	Business	
	Customer Service and Technical Support	toll-free: 1-800-456-3355
	Employee Purchase Program (EPP) Customers	toll-free: 1-800-695-8133
	Printers and Projectors Technical Support	toll-free: 1-877-459-7298
	Public (government, education, and healthcare)	
	Customer Service and Technical Support	toll-free: 1-800-456-3355
	Employee Purchase Program (EPP) Customers	toll-free: 1-800-695-8133
	Dell Sales	toll-free: 1-800-289-3355 or toll-free: 1-800-879-3355
	Dell Outlet Store (Dell refurbished computers)	toll-free: 1-888-798-7561
	Software and Peripherals Sales	toll-free: 1-800-671-3355
	Spare Parts Sales	toll-free: 1-800-357-3355
	Extended Service and Warranty Sales	toll-free: 1-800-247-4618
	Fax	toll-free: 1-800-727-8320
	Dell Services for the Deaf, Hard-of-Hearing, or Speech-Impaired	toll-free: 1-877-DELLTTY (1-877-335-5889)
U.S. Virgin Islands	General Support	1-877-673-3355
Venezuela	General Support	8001-3605

Index

A

- audio connectors, 18
- audio device
 - connecting, 34
- audio. *See speakers*

B

- battery
 - charge gauge, 22, 28
 - charging, 29
 - checking the charge, 28
 - description, 21
 - installing, 30
 - low-battery warning, 29
 - performance, 27
 - power meter, 28
 - removing, 30
 - storing, 30
- blanks
 - PC Cards, 43
 - removing, 45
- Bluetooth wireless technology
 - card
 - device status light, 16
 - installing, 91
- boot sequence, 100

C

- CardBus technology
 - PC Cards, 43
- CD drive
 - problems, 53
- CD-RW drive
 - problems, 53
- CDs, 31
- Check Disk, 54
- coin-cell battery
 - replacing, 86
- computer
 - crashes, 60
 - restore to previous operating state, 71
 - slow performance, 56, 61
 - specifications, 93
 - stops responding, 60
- conflicts
 - software and hardware incompatibilities, 74
- connecting
 - audio device, 34
 - TV, 34
- copying CDs
 - helpful tips, 32
 - how to, 31
- copying DVDs
 - helpful tips, 32
 - how to, 31

D

- Dell
 - contacting, 101
 - support policy, 101
 - support site, 10
- Dell Diagnostics, 51
- Dell MediaDirect, 15, 33
- Dell Premier Support website, 9-10
- device status lights, 14
- diagnostics
 - Dell, 51
- display
 - description, 13-14
 - removing, 87
- display latch, 13
- display settings for a TV
 - enabling in Windows XP, 37
- documentation
 - help file, 9
 - online, 10
 - Setup Diagram, 9
 - System Information Guide, 9
- Dolby headphones
 - setting up, 37
- drivers
 - about, 69
 - identifying, 70
 - reinstalling, 70

drives
 problems, 53
 See *hard drive*

DVD drive
 problems, 53

DVDs, 31

E

error messages, 56

F

fan
 description, 17, 22

FCC notice, 101

Finding Information
 documentation, 9

floppy drive
 connecting to a USB
 connector, 18

H

hard drive
 description, 22
 problems, 54
 replacing, 77
 returning to Dell, 79

hardware
 conflicts, 74

Hardware Troubleshooter, 74

Help and Support Center, 11

help file, 9

hinge cover
 removing, 89

I

IEEE 1394 connector
 description, 18
 problems, 58

Internet connection, 23

IRQ conflicts, 74

K

keyboard
 description, 16
 numeric keypad, 39
 problems, 58
 removing, 90
 shortcuts, 40

keyboard status lights
 description, 16

keypad
 numeric, 39

L

labels
 Microsoft Windows, 10
 Service Tag, 10

M

media control buttons
 description, 15
 play/pause/Dell
 MediaDirect, 15, 33

memory
 installing, 79
 removing, 80

memory/modem cover
 description, 22

messages
 error, 56

Microsoft Windows label, 10

Mini PCI card
 installing, 84

modem
 installing, 82

modem connector
 description, 19

monitor. See *display*

N

network
 problems, 62

network connector
 description, 19

O

operating system
 reinstalling Windows XP, 71

optical drive
 description, 18

optical drive bay
description, 22

optical-drive-tray eject
button
description, 18

P

PC Card slot
description, 19

PC Cards
blanks, 43, 45
CardBus technology, 43
extended, 43
installing, 43
removing, 45
slots, 43
types, 43
wireless network adapter, 43

PC Restore, 73

power
line conditioners, 25
problems, 63
protection devices, 25
surge protectors, 25
UPS, 25

power light
conditions indicated by, 63

printer
cable, 24
connecting, 24
problems, 64
USB, 24

problems
blue screen, 60
CD drive, 53
CD-RW drive, 53
computer crashes, 60
computer does not start up, 59
computer stops responding, 60
conditions indicated by power
light, 63
conflicts, 74
Dell Diagnostics, 51
drives, 53
DVD drive, 53
error messages, 56
hard drive, 54
IEEE 1394, 58
keyboard, 58
lockups, 59
network, 62
power, 63
printer, 64
program crashes, 60
program stops responding, 60
programs and Windows
compatibility, 60
restore to previous operating
state, 71
scanner, 65
slow computer
performance, 56, 61
software, 59-61
sound and speakers
spyware, 56, 61
technical support policy, 101
video and display, 68

Q

QuickSet, 28, 33, 40

R

RAM. See *memory*
regulatory notice
FCC, 101
reinstalling
Windows XP, 71

S

safety instructions, 9
scanner
problems, 65
screen. See *display*
Secure Digital I/O slot, 19
security cable slot
description, 17
Service Tag, 10
Setup Diagram, 9
software
conflicts, 74
problems, 60-61
sound
volume
sound. See *speakers*
speakers
description, 15
volume

specifications, 93

spyware, 56, 61

support

- contacting Dell, 101
- policy, 101

S-video TV-out connector

- connecting a TV, 34
- description, 20

System Restore, 71

system setup program

- commonly used options, 99
- purpose, 99
- screens, 99
- viewing, 99

T

technical support

- policy, 101

telephone numbers, 101

touch pad, 42

- customizing, 42
- description, 15

troubleshooting

- conflicts, 74
- Dell Diagnostics, 51
- external keyboard
 - problems, 58
- Hardware Troubleshooter, 74
- Help and Support Center, 11
- restore to previous operating state, 71

TV

- connecting, 34
- enabling display settings in Windows XP, 37

U

uninterruptible power supply.

- See *UPS*

UPS, 25

USB connectors

- description, 20

V

video

- problems, 68

video connector

- description, 20

W

warranty, 9

Windows XP

- Device Driver Rollback, 70
- enabling display settings for a TV, 37
- Hardware Troubleshooter, 74
- Help and Support Center, 11
- PC Restore, 73
- Program Compatibility Wizard, 60
- reinstalling, 71
- System Restore, 71

wireless network, 48

wireless network adapter

- PC Cards, 43