



Dell™ Latitude™ D610 Service Manual

Before You Begin	Palm Rest
System Components	Fan
Internal Card With Bluetooth® Wireless Technology	Microprocessor Thermal-Cooling Assembly
Hard Drive	Microprocessor Module
Center Control Cover	Speaker Assembly
Keyboard	Base Latch
Memory Module, Modem, and Devices	System Board
Coin-Cell Battery	Flashing the BIOS
Mini PCI Card	Pin Assignments for I/O Connectors
Display Assembly and Display Latch	

Notes, Notices, and Cautions

-  **NOTE:** A NOTE indicates important information that helps you make better use of your computer.
-  **NOTICE:** A NOTICE indicates either potential damage to hardware or loss of data and tells you how to avoid the problem.
-  **CAUTION:** A CAUTION indicates a potential for property damage, personal injury, or death.

Information in this document is subject to change without notice.
© 2004–2005 Dell Inc. All rights reserved.

Reproduction in any manner whatsoever without the written permission of Dell Inc. is strictly forbidden.

Trademarks used in this text: *Dell*, the *DELL* logo, and *Latitude* are trademarks of Dell Inc.; *Intel* is a registered trademark of Intel Corporation; *Bluetooth* is a registered trademark owned by Bluetooth SIG, Inc. and is used by Dell Inc. under license.

Other trademarks and trade names may be used in this document to refer to either the entities claiming the marks and names or their products. Dell Inc. disclaims any proprietary interest in trademarks and trade names other than its own.

Model PP11L

November 2005 Rev. A01

Before You Begin

Dell™ Latitude™ D610 Service Manual

- [Preparing to Work Inside the Computer](#)
 - [Recommended Tools](#)
 - [Computer Orientation](#)
 - [Screw Identification](#)
-

Preparing to Work Inside the Computer

⚠ CAUTION: Only a certified service technician should perform repairs on your computer. Damage due to servicing that is not authorized by Dell is not covered by your warranty. Read and follow applicable instructions in the safety instructions in the *Product Information Guide* that came with the computer.

⚠ CAUTION: To prevent static damage to components inside your computer, discharge static electricity from your body before you touch any of your computer's electronic components. You can do so by touching an unpainted metal surface.

⚠ CAUTION: Handle components and cards with care. Do not touch the components or contacts on a card. Hold a card by its edges or by its metal mounting bracket. Hold a component such as a microprocessor by its edges, not by its pins.

➡ NOTICE: To avoid damaging the computer, perform the following steps before you begin working inside the computer.

1. Ensure that the work surface is flat and clean to prevent scratching the computer cover.
2. Save any work in progress and exit all open programs.
3. Turn off the computer and all attached devices.

🔌 NOTE: Ensure that the computer is off and not in a power management mode. If you cannot shut down the computer using the computer operating system, press and hold the power button for 4 seconds.

4. If the computer is connected to a docking device, undock it.
5. Disconnect the computer from the electrical outlet.
6. To avoid possible damage to the system board, wait 10 to 20 seconds and then disconnect any attached devices.
7. Disconnect all other external cables from the computer.
8. Remove any installed PC Cards from the PC Card slot.
9. Close the display and turn the computer upside down on a flat work surface.

➡ NOTICE: To avoid damaging the system board, you must remove the main battery before you service the computer.

10. Slide and hold the battery-bay latch release on the bottom of the computer, and then remove the battery from the bay.



11. Remove any installed memory modules, Mini PCI cards, and devices, including a second battery if one is installed.
12. Remove the hard drive (see "[Removing the Hard Drive](#)").

Recommended Tools

The procedures in this manual require the following tools:

- 1 #1 Phillips screwdriver
- 1 ¼-inch flat-blade screwdriver
- 1 Small plastic scribe
- 1 Flash BIOS update program floppy or CD

Computer Orientation















1	back
2	right
3	front
4	left

Screw Identification

When you are removing and replacing components, photocopy "[Screw Identification](#)" as a tool to lay out and keep track of the screws. The placemat provides the number of screws and their sizes.



<p>Optional Device: (1 each)</p>  <p><i>M2 x 3 mm</i></p>	<p>Hard Drive: (2 each)</p>  <p><i>M3 x 3 mm</i></p>	<p>Keyboard: (2 each)</p>  <p><i>M2.5 x 5 mm</i> 63PDH</p>
--	---	---

<p>Display Assembly: (4 each)</p>  <p>M2.5 x 5 mm 63PDH</p>	<p>Display Bezel: (6 each)</p>  <p>M2.5 x 5 mm 63PDH</p>	<p>Display Panel: (4 each)</p>  <p>M2 x 3 mm 7P786</p>
<p>Display Latch: (1 each)</p>  <p>M2.5 x 5 mm 63PDH</p>	<p>Palm Rest: (2 each at top)</p>  <p>M2.5 x 5 mm 63PDH</p> <p>(13 each at bottom)</p>  <p>M2.5 x 8 mm 3R690</p>	<p>Fan: (2 each)</p>  <p>M2.5 x 8 mm 3R690</p>
<p>Speakers: (2 each—1 on each side)</p>  <p>M2.5 x 5 mm 63PDH</p>	<p>Modem: (1 each)</p>  <p>M2 x 3 mm 4270E</p>	<p>System Board: (5 each)</p>  <p>M2 x 3 mm 4270E</p>

[Back to Contents Page](#)

Flashing the BIOS

Dell™ Latitude™ D610 Service Manual

1. Ensure that the AC adapter is plugged in and that the main battery is installed properly.



NOTE: If you use a BIOS update program CD to flash the BIOS, set up the computer to boot from a CD before inserting the CD.

2. Insert the BIOS update program floppy or CD, and turn on the computer.

Follow the instructions that appear on the screen. The computer continues to boot and updates the new BIOS. When the flash update is complete, the computer will automatically reboot.

3. Press <F2> during POST to enter the system setup program.
4. Press <Alt> and <F> to reset the computer defaults.
5. Press <Esc Suspend>, select **Save changes and reboot**, and press <Enter> to save configuration changes.
6. Remove the flash BIOS update program floppy or CD from the drive and restart the computer.

[Back to Contents Page](#)

Internal Card With Bluetooth® Wireless Technology

Dell™ Latitude™ D610 Service Manual

- [Removing the Internal Card With Bluetooth® Wireless Technology](#)
- [Installing the Internal Card With Bluetooth® Wireless Technology](#)

⚠ CAUTION: Before performing the following procedures, read the safety instructions in your *Product Information Guide*.

➡ NOTICE: To avoid electrostatic discharge, ground yourself by using a wrist grounding strap or by periodically touching an unpainted metal surface (such as the back panel) on the computer.

Removing the Internal Card With Bluetooth® Wireless Technology

1. Follow the instructions in "[Preparing to Work Inside the Computer](#)."
2. Remove the battery.
3. Press down and pull on the tab to open the card door.
4. Disconnect the card cable connector from the card, and remove the door with the card from the computer.

➡ NOTICE: Press down the lever gently to avoid damaging it.

5. Holding the card by the card connector, press down the lever, and lift the card off the plastic knob.
6. Slide the card out of the plastic brackets.

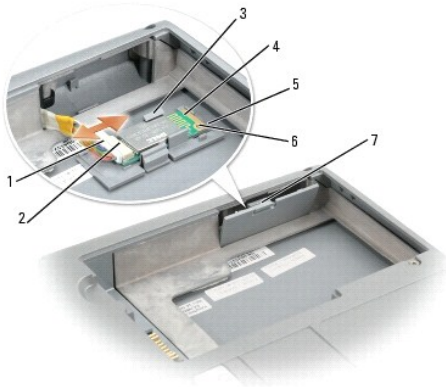

1	card cable connector
2	card connector
3	plastic brackets (2)
4	internal card with Bluetooth wireless technology
5	lever
6	plastic knob
7	tab on card door

Installing the Internal Card With Bluetooth® Wireless Technology

1. Slide the card into the plastic brackets on the door, and press the card onto the plastic knob.

➡ NOTICE: Be careful not to break the plastic when closing the door.

2. Connect the card to the card cable connector, slide the door with the card into the card compartment, and gently press the door into position.
 3. Replace the battery.
-

[Back to Contents Page](#)

Coin-Cell Battery

Dell™ Latitude™ D610 Service Manual

- [Removing the Coin-Cell Battery](#)
- [Installing the Coin-Cell Battery](#)

⚠ CAUTION: Before you begin any of the procedures in this section, follow the safety instructions in the *Product Information Guide*.

⚠ CAUTION: To prevent static damage to components inside your computer, discharge static electricity from your body before you touch any of your computer's electronic components. You can do so by touching an unpainted metal surface.

Removing the Coin-Cell Battery

1. Follow the instructions in "[Preparing to Work Inside the Computer](#)."
2. Turn over the computer, loosen the captive screw from the modem cover, and lift the cover away from the computer.



1	captive screw
2	modem cover

3. Disconnect the coin-cell battery cable connector from the battery connector on the system board, and slide the coin-cell battery out of the securing sleeve.



1	coin-cell battery
2	battery connector on system board

3	coin-cell battery cable connector
4	securing sleeve

Installing the Coin-Cell Battery

1. Connect the coin-cell battery cable connector to the battery connector on the system board.
 2. Slide the battery into the securing sleeve.
 3. Replace the modem cover.
-

[Back to Contents Page](#)

Microprocessor Module

Dell™ Latitude™ D610 Service Manual

- [Removing the Microprocessor Module](#)
- [Installing the Microprocessor Module](#)

Removing the Microprocessor Module

⚠ CAUTION: Before you begin any of the procedures in this section, follow the safety instructions in the *Product Information Guide*.

➡ **NOTICE:** To avoid electrostatic discharge, ground yourself by using a wrist grounding strap or by periodically touching an unpainted metal surface (such as the back panel) on the computer.

➡ **NOTICE:** Do not touch the processor die. Press and hold the microprocessor down on the substrate on which the die is mounted while turning the cam screw to prevent intermittent contact between the cam screw and microprocessor.

➡ **NOTICE:** To avoid damage to the microprocessor, hold the screwdriver so that it is perpendicular to the microprocessor when turning the cam screw.

1. Follow the instructions in "[Preparing to Work Inside the Computer](#)."
2. Remove the center control cover (see "[Removing the Center Control Cover](#)").
3. Remove the keyboard (see "[Removing the Keyboard](#)").
4. Remove the display assembly (see "[Removing the Display Assembly](#)").
5. Remove the palm rest (see "[Removing the Palm Rest](#)").

➡ **NOTICE:** To ensure maximum cooling for the microprocessor, do not touch the heat transfer areas on the microprocessor thermal-cooling assembly. The oils in your skin reduce the heat transfer capability of the thermal pads.

6. Remove the microprocessor thermal-cooling assembly.

➡ **NOTICE:** When removing the microprocessor module, pull the module straight up. Be careful not to bend the pins on the microprocessor module.

7. To loosen the ZIF socket, use a small flat-blade screwdriver and rotate the ZIF-socket cam screw counterclockwise until you cannot turn the screw any further.

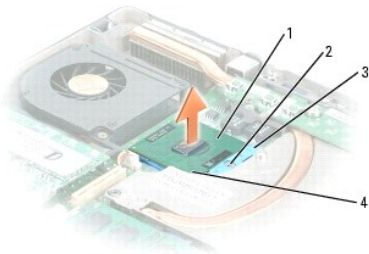

1	microprocessor
2	ZIF-socket cam screw
3	ZIF socket
4	pin-1 corner

🔧 **NOTE:** The ZIF-socket cam screw secures the microprocessor to the system board. Take note of the arrow on the ZIF-socket cam screw.

🔧 **NOTE:** See Mini RSL for microprocessor part numbers.

8. Lift the microprocessor module from the system board.
-

Installing the Microprocessor Module

➡ **NOTICE:** Ensure that the cam lock is in the fully open position before seating the microprocessor module. Seating the microprocessor module properly in the ZIF socket does not require force.

➡ **NOTICE:** A microprocessor module that is not properly seated can result in an intermittent connection or permanent damage to the microprocessor and ZIF socket.

1. Align the pin-1 corner of the microprocessor module with the pin-1 corner of the ZIF socket, and insert the microprocessor module.

🔍 **NOTE:** The pin-1 corner of the microprocessor module has a triangle that aligns with the triangle on the pin-1 corner of the ZIF socket.

➡ **NOTICE:** You must position the microprocessor module correctly in the ZIF socket to avoid permanent damage to the module and the socket.

When the microprocessor module is correctly seated, all four corners are aligned at the same height. If one or more corners of the module are higher than the others, the module is not seated correctly.

2. Tighten the ZIF socket by turning the cam screw clockwise until you cannot turn the screw any further to secure the microprocessor module to the system board.
3. Replace the other computer parts you removed earlier in this procedure.
4. Update the BIOS using a flash BIOS update program CD. For instructions on how to flash the BIOS, see "[Flashing the BIOS.](#)"

[Back to Contents Page](#)

Display Assembly and Display Latch

Dell™ Latitude™ D610 Service Manual

- [Display Assembly](#)
- [Display Bezel](#)
- [Display Panel](#)
- [Display Latch](#)

Display Assembly

- ⚠ **CAUTION:** Before you begin any of the procedures in this section, follow the safety instructions in the *Product Information Guide*.
- ➡ **NOTICE:** To avoid electrostatic discharge, ground yourself by using a wrist grounding strap or by periodically touching an unpainted metal surface (such as the back panel) on the computer.
- ➡ **NOTICE:** You must remove the display assembly before you remove the palm rest.

Removing the Display Assembly

1. Follow the instructions in "[Preparing to Work Inside the Computer](#)."
 2. Remove the center control cover (see "[Removing the Center Control Cover](#)").
 3. Remove the keyboard (see "[Removing the Keyboard](#)").
 4. Open the display approximately 180 degrees so that it lies flat against your work surface.
 5. Loosen the captive screw that secures the display cable to the heat sink on the system board.
 6. Use the pull-tab to remove the display cable from the display connector on the system board.
- 🔧 **NOTE:** If a Mini PCI card is installed, remove the two antenna cables from the card and from the routing clips.



1	antenna cables (2)
2	M2.5 x 5-mm screws (4)
3	display
4	captive screw on heat sink
5	display connector on system board
6	pull-tab on display-cable connector

7. Remove the four M2.5 x 5-mm screws.

8. Lift the display assembly up and out of the computer base.

Installing the Display Assembly

1. Align the display assembly over the screw holes in the base of the computer.
2. Tighten the four M2.5 x 5-mm screws.
3. Route the two antenna cables under the routing clips.

 **NOTE:** Ensure that you route the antenna cables under the routing clips. Failure to do so could result in your keyboard not seating properly.



4. Replace the keyboard (see "[Installing the Keyboard](#)").
5. Replace the center control cover (see "[Installing the Center Control Cover](#)").

Display Bezel

 **CAUTION:** Before you begin any of the procedures in this section, follow the safety instructions in the *Product Information Guide*.

 **NOTICE:** To avoid electrostatic discharge, ground yourself by using a wrist grounding strap or by periodically touching an unpainted metal surface (such as the back panel) on the computer.

Removing the Display Bezel

1. Follow the instructions in "[Preparing to Work Inside the Computer](#)."
2. Remove the center control cover (see "[Removing the Center Control Cover](#)").
3. Remove the keyboard (see "[Removing the Keyboard](#)").
4. Remove the display assembly (see "[Removing the Display Assembly](#)").
5. Use a plastic scribe tool to pry the six display bumpers out of the screw holes located on the front of the bezel.

6. Remove the six M2.5 x 5-mm screws located on the front of the bezel.

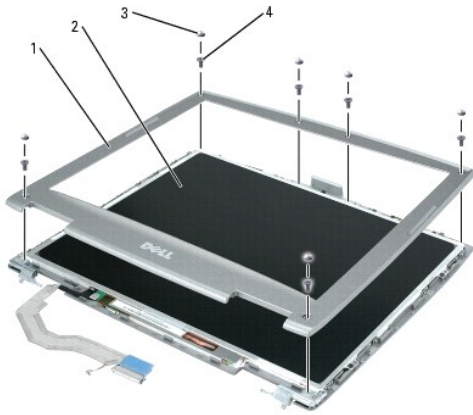

1	display bezel
2	display panel
3	display bumpers (6)
4	M2.5 x 5-mm screws (6)

 **NOTICE:** Carefully separate the bezel from the top cover to avoid damage to the bezel.

7. Starting at the bottom of the display panel (by the Dell™ logo), use your fingers to separate the bezel from the top cover by lifting the inside edge of the bezel and rotating away from the top cover.

 **NOTE:** Follow the same procedure on all four sides of the display bezel until it snaps completely off.



Installing the Display Bezel

1. Starting at any corner, use your fingers to gently snap the bezel in place securing the display panel.
2. Tighten the six M2.5 x 5-mm screws on the front of the bezel.
3. Replace the six display bumpers around the display assembly.

Display Panel

 **CAUTION:** Before you begin any of the procedures in this section, follow the safety instructions in the *Product Information Guide*.

 **NOTICE:** To avoid electrostatic discharge, ground yourself by using a wrist grounding strap or by touching an unpainted metal surface on the computer.

Removing the Display Panel

1. Follow the instructions in ["Preparing to Work Inside the Computer."](#)
2. Remove the center control cover (see ["Removing the Center Control Cover"](#)).
3. Remove the keyboard (see ["Removing the Keyboard"](#)).
4. Remove the display assembly (see ["Removing the Display Assembly"](#)).
5. Remove the display bezel (see ["Removing the Display Bezel"](#)).
6. Remove the antenna cables from the routing clips on the side of the display panel.



7. Remove the four M2 x 3-mm screws (two on each side) from the display panel.

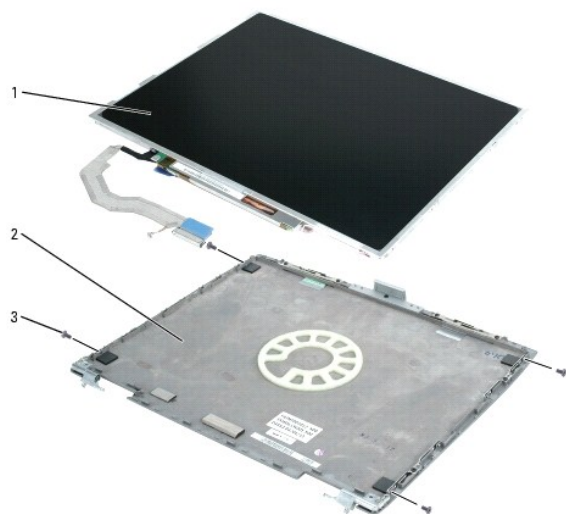

1	display panel
2	top cover
3	M2 x 3-mm screws (4)

- Remove the display panel from the top cover.
- Use the pull-tab to disconnect the bottom flex-cable connector from the inverter connector.

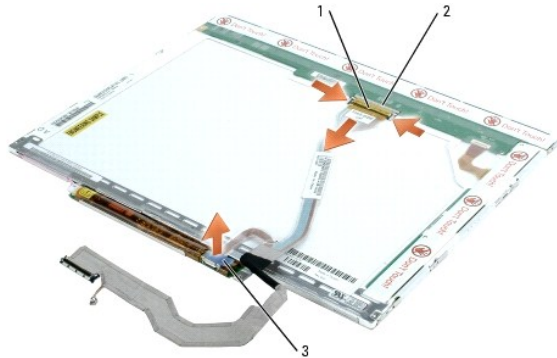

1	top flex-cable connector
2	top display-cable connector
3	pull-tab on bottom flex-cable connector

- Press in both sides of the top display cable connector, and pull the display cable connector away from the top flex-cable connector.

Installing the Display Panel

- Connect the top display cable connector to the top flex-cable connector.
- Connect the bottom flex-cable connector to the inverter connector.
- Replace the display panel inside the top cover.
- Tighten the four M2 x 3-mm screws (two on each side) around the display panel.
- Replace the display bezel (see "[Installing the Display Bezel](#)").

Display Latch

- NOTICE:** Disconnect the computer and any attached devices from electrical outlets, and remove any installed batteries.
- NOTICE:** To avoid electrostatic discharge, ground yourself by using a wrist grounding strap or by touching an unpainted metal surface on the computer.

Removing the Display Latch

- Follow the instructions in "Preparing to Work Inside the Computer."
- Remove the center control cover (see "[Removing the Center Control Cover](#)").
- Remove the keyboard (see "[Removing the Keyboard](#)").
- Remove the display assembly (see "[Removing the Display Assembly](#)").
- Remove the display bezel (see "[Removing the Display Bezel](#)").
- Remove the M2.5 x 5-mm screw that secures the display latch to the top cover.

7. Remove the display latch (see "[Removing the Display Latch](#)").

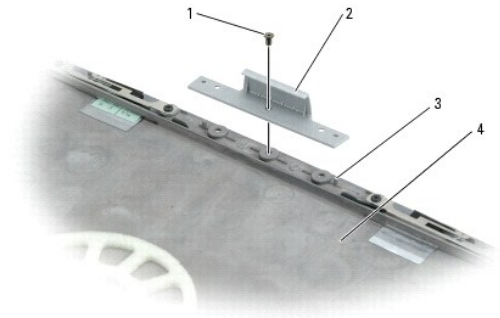

1	M2.5 x 5-mm screw
2	display latch
3	guide pins (2)
4	top cover

Installing the Display Latch

1. Align the latch on the guide pins located on the top cover.
2. Insert and tighten the M2.5 x 5-mm screw that secures the display latch to the top cover.

[Back to Contents Page](#)

Fan

Dell™ Latitude™ D610 Service Manual

- [Removing the Fan](#)
- [Installing the Fan](#)

⚠ CAUTION: Before you begin any of the procedures in this section, follow the safety instructions in the *Product Information Guide*.

🔌 NOTICE: To avoid electrostatic discharge, ground yourself by using a wrist grounding strap or by periodically touching an unpainted metal surface (such as the back panel) on the computer.

Removing the Fan

1. Follow the instructions in "[Preparing to Work Inside the Computer](#)."
2. Remove the center control cover (see "[Removing the Center Control Cover](#)").
3. Remove the keyboard (see "[Removing the Keyboard](#)").
4. Remove the display assembly (see "[Removing the Display Assembly](#)").
5. Remove the palm rest (see "[Removing the Palm Rest](#)").
6. Remove the fan cable from the fan connector on the system board.
7. Remove the two M2.5 x 8-mm screws from the fan, and pull the fan off the system board.

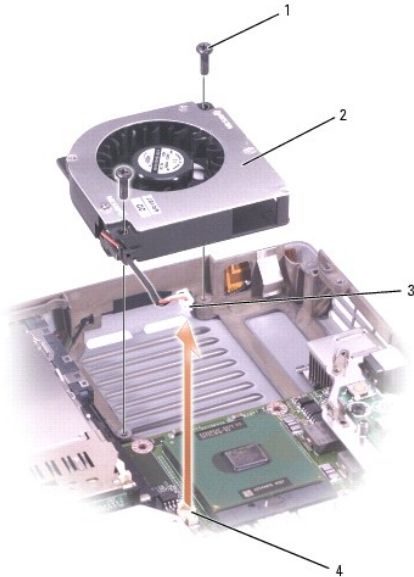

1	M2.5 x 8-mm screws (2)
2	fan
3	fan cable connector
4	fan connector on system board

Installing the Fan

1. Connect the fan cable connector to the fan connector on the system board.
2. Secure the two M2.5 x 8-mm screws on the fan, and slide the fan back onto the system board.

[Back to Contents Page](#)

Hard Drive

Dell™ Latitude™ D610 Service Manual

- [Removing the Hard Drive](#)
- [Installing the Hard Drive](#)

- ⚠ **CAUTION:** If you remove the hard drive from the computer when the drive is hot, *do not touch* the metal housing of the hard drive.
 - ⚠ **CAUTION:** Before you begin any of the procedures in this section, follow the safety instructions in the *Product Information Guide*.
 - ➡ **NOTICE:** To prevent data loss, shut down your computer before removing the hard drive. Do not remove the hard drive while the computer is on, in standby mode, or in hibernate mode.
 - ➡ **NOTICE:** Hard drives are extremely fragile; even a slight bump can damage the drive.
 - 📌 **NOTE:** Dell does not guarantee compatibility or provide support for hard drives from sources other than Dell.
-

Removing the Hard Drive

1. Follow the instructions in "[Preparing to Work Inside the Computer](#)."
2. Turn the computer over. Use a standard #1 Phillips screwdriver to remove the two M3 x 3- mm screws.



1	M3 x 3-mm screws (2)
2	hard drive

- ➡ **NOTICE:** When the hard drive is not in the computer, store it in protective antistatic packaging.

3. Slide the hard drive out of the computer.
-

Installing the Hard Drive

- ➡ **NOTICE:** Use firm and even pressure to slide the drive into place. If you force the hard drive into place using excessive force, you may damage the connector.

1. Slide the drive into the bay until it is fully seated.
2. Replace and tighten the screws.
3. Install the operating system for your computer. For instructions, see "Reinstalling Microsoft Windows XP" in your *User's Guide*.
4. Install the drivers and utilities for your computer. For instructions, see "Reinstalling Drivers and Utilities" in your *User's Guide*.

5. Press the hard drive cover down until it is fully seated in the bay, and tighten the screws.
 6. Install the operating system for your computer.
 7. Install the drivers and utilities for your computer.
-

[Back to Contents Page](#)

[Back to Contents Page](#)

Center Control Cover

Dell™ Latitude™ D610 Service Manual

- [Removing the Center Control Cover](#)
- [Installing the Center Control Cover](#)

⚠ CAUTION: Before you begin any of the procedures in this section, follow the safety instructions in the *Product Information Guide*.

👉 NOTICE: To avoid electrostatic discharge, ground yourself by using a wrist grounding strap or by periodically touching an unpainted metal surface (such as the back panel) on the computer.

Removing the Center Control Cover

1. Follow the instructions in "[Preparing to Work Inside the Computer](#)."
2. Open the display all the way (180 degrees) so that it lies flat against your work surface.
3. Starting on the right side of the computer, use a plastic scribe to gently pry up the center control cover.



1	center control cover
---	----------------------

Installing the Center Control Cover

Gently snap the center control cover into place starting from left to right.

[Back to Contents Page](#)

Keyboard

Dell™ Latitude™ D610 Service Manual

- [Removing the Keyboard](#)
- [Installing the Keyboard](#)

⚠ CAUTION: Before you begin any of the procedures in this section, follow the safety instructions in the *Product Information Guide*.

👉 NOTICE: To avoid electrostatic discharge, ground yourself by using a wrist grounding strap or by periodically touching an unpainted metal surface (such as the back panel) on the computer.

Removing the Keyboard

1. Follow the instructions in "[Preparing to Work Inside the Computer](#)."
2. Remove the center control cover (see "[Removing the Center Control Cover](#)").
3. Remove the two M2.5 x 5-mm screws across the top of the keyboard.

👉 NOTICE: When you remove the keyboard, pull up gently to avoid damaging the keyboard cable.

4. Lift and rotate the keyboard clockwise 90 degrees to access the pull-tab.
5. Using the keyboard cable pull-tab, pull up to disconnect the keyboard cable connector from the keyboard connector on the system board.

👉 NOTICE: The keycaps on the keyboard are fragile, easily dislodged, and time-consuming to replace. Be careful when removing and handling the keyboard.

6. Remove the keyboard (see "[Removing the Keyboard](#)").

🔍 NOTE: When you replace the keyboard, ensure that the keyboard tabs are completely in place to avoid scratching the palm rest.



1	M2.5 x 5-mm screws (2)
2	keyboard cable pull-tab
3	keyboard connector on system board
4	keyboard tabs (5)
5	palm rest

Installing the Keyboard

1. Connect the keyboard cable connector to the keyboard connector on the system board.

2. Slide the keyboard tabs at the bottom of the keyboard into the base of the computer.

 **NOTE:** You may need to slightly push the keyboard tabs into the base of the computer.

3. Tighten the two M2.5 x 5-mm screws across the top of the keyboard.

4. Replace the center control cover (see "[Installing the Center Control Cover](#)").

[Back to Contents Page](#)

Base Latch

Dell™ Latitude™ D610 Service Manual

- [Removing the Base Latch](#)
- [Installing the Base Latch](#)

⚠ CAUTION: Before you begin any of the procedures in this section, follow the safety instructions in the *Product Information Guide*.

🔧 NOTICE: To avoid electrostatic discharge, ground yourself by using a wrist grounding strap or by periodically touching an unpainted metal surface (such as the back panel) on the computer.

Removing the Base Latch

1. Follow the instructions in "[Preparing to Work Inside the Computer](#)."
2. Remove the center control cover (see "[Removing the Center Control Cover](#)").
3. Remove the keyboard (see "[Removing the Keyboard](#)").
4. Remove the display assembly (see "[Removing the Display Assembly](#)").
5. Remove the palm rest (see "[Removing the Palm Rest](#)").
6. Remove the speaker assembly (see "[Removing the Speaker Assembly](#)").
7. Pull the base latch straight up and out of the computer base (no screws secure it in place).

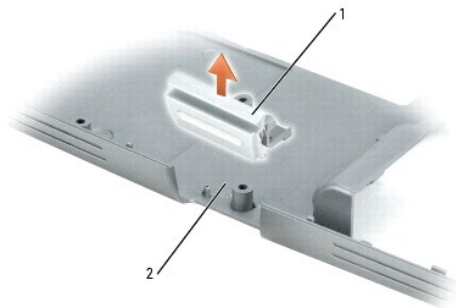

1	base latch
2	computer base

Installing the Base Latch

1. Slide the latch over the notch located in the center of the system base.
 2. Replace the speaker assembly to secure the latch in place.
-

Mini PCI Card

Dell™ Latitude™ D610 Service Manual

- [Removing the Mini PCI Card](#)
- [Installing the Mini PCI Card](#)

⚠ CAUTION: Before you begin any of the procedures in this section, follow the safety instructions in the *Product Information Guide*.

👉 NOTICE: To avoid electrostatic discharge, ground yourself by using a wrist grounding strap or by periodically touching an unpainted metal surface (such as the back panel) on the computer.

Removing the Mini PCI Card

1. Follow the instructions in "[Preparing to Work Inside the Computer](#)".
2. Remove the center control cover (see "[Removing the Center Control Cover](#)").
3. Remove the keyboard (see "[Removing the Keyboard](#)").

🔧 NOTE: If a Mini PCI card is not already installed, install the Mini PCI card. If you are replacing a Mini PCI card, remove the existing card:

4. Remove the antenna cables from the routing clips.
5. Disconnect the antenna cables from the Mini PCI card.

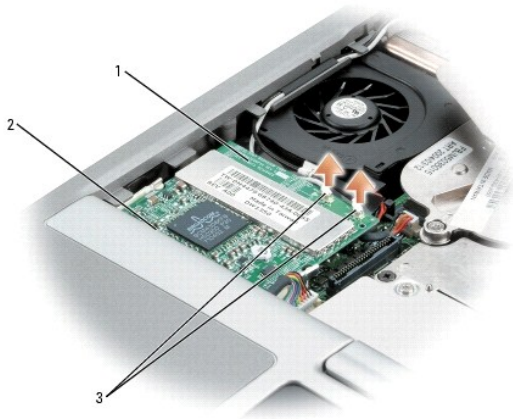

1	Mini PCI card
2	Mini PCI card connector
3	antenna cables (2)

👉 NOTICE: To prevent damage to the Mini PCI card connector, do not use tools to spread the securing clips that secure the card.

6. Release the Mini PCI card by spreading the metal securing tabs until the card pops up slightly.
7. Remove the Mini PCI card from the Mini PCI card connector at a 45-degree angle.



1	Mini PCI card
2	metal securing tabs (2)

Installing the Mini PCI Card

- ➔ **NOTICE:** To avoid damaging the antenna cables or the Mini PCI card, never place the cables under the card.
 - ➔ **NOTICE:** The connectors are keyed to ensure correct insertion. If you feel resistance, check the connectors and realign the card.
1. Align the Mini PCI card with the connector at a 45-degree angle, and press the Mini PCI card into the connector until it clicks.
- ➔ **NOTICE:** Ensure the antenna cables are properly secured by the routing clips on the left side of the fan. Failure to do so may cause damage to the antenna cables and the fan.



1	Mini PCI card
2	metal securing tabs (2)

2. Connect the antenna cables to the Mini PCI card.

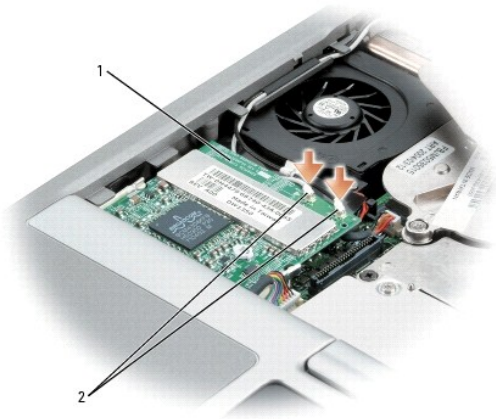

1	Mini PCI card
2	antenna wires (2)

3. Replace the keyboard (see "[Installing the Keyboard](#)").
4. Replace the center control cover (see "[Installing the Center Control Cover](#)").

[Back to Contents Page](#)

Palm Rest

Dell™ Latitude™ D610 Service Manual

- [Removing the Palm Rest](#)
- [Installing the Palm Rest](#)

⚠ CAUTION: Before you begin any of the procedures in this section, follow the safety instructions in the *Product Information Guide*.

🔌 NOTICE: To avoid electrostatic discharge, ground yourself by using a wrist grounding strap or by periodically touching an unpainted metal surface (such as the back panel) on the computer.

Removing the Palm Rest

1. Follow the instructions in "[Preparing to Work Inside the Computer](#)."
2. Remove the center control cover (see "[Removing the Center Control Cover](#)").
3. Remove the keyboard (see "[Removing the Keyboard](#)").
4. Remove the display assembly (see "[Removing the Display Assembly](#)").
5. Remove the two M2.5 x 5-mm screws from the top of the palm rest.
6. Disconnect the touch pad cable from the connector on the system board.

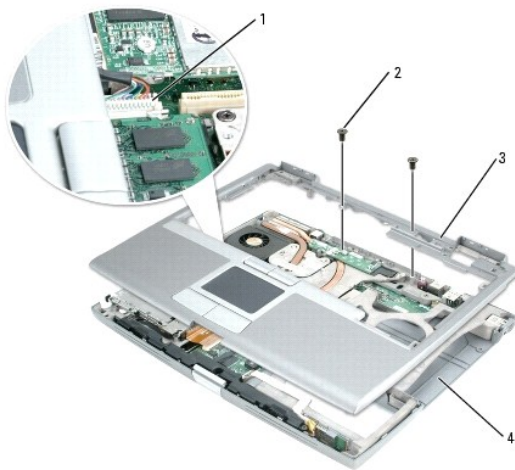

1	touch pad connector
2	screws (2) at top of palm rest
3	palm rest
4	computer base

7. Turn the computer over and remove the thirteen M2.5 x 8-mm screws.

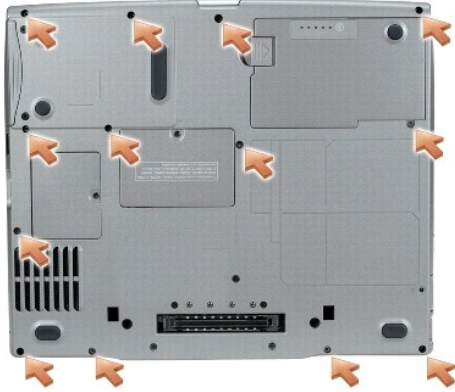

1	M2.5 x 8-mm screws (13)
---	-------------------------

🔗 **NOTICE:** Carefully separate the palm rest from the computer base to avoid damage to the palm rest.

8. Starting at the back center of the palm rest, use your fingers to separate the palm rest from the computer base by lifting the inside of the palm rest while pushing in on the outside.

Installing the Palm Rest

1. Align the palm rest with the computer base and snap into place.
2. Connect the touch pad cable to the connector on the system board.
3. Replace the three M2.5 x 5-mm screws on the top of the palm rest.
4. Turn the computer over and replace the thirteen M2.5 x 8-mm screws.
5. Replace the display assembly.
6. Replace the keyboard (see "[Installing the Keyboard](#)").
7. Replace the center control cover (see "[Installing the Center Control Cover](#)").

[Back to Contents Page](#)

Pin Assignments for I/O Connectors

Dell™ Latitude™ D610 Service Manual

- [USB Connector](#)
 - [Video Connector](#)
 - [Parallel Connector](#)
-

USB Connector

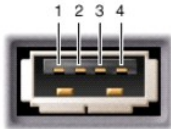

Pin	Signal
1	USB5V+
2	USBP-
3	USBP+
4	GND

Video Connector



Pin	Signal	Pin	Signal
1	CRT_R	9	5V+
2	CRT_G	10	GND
3	CRT_B	11	MONITOR_DETECT-
4	NC	12	DDC_DATA
5	GND	13	CRT_HS
6	GND	14	CRT_VS
7	GND	15	DDC_CLK
8	GND		

Parallel Connector

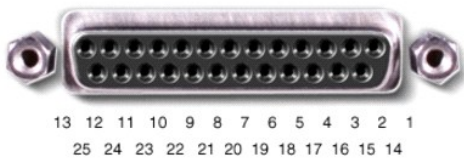

Pin	Signal	Pin	Signal
1	STROBE-	10	ACK-
2	PD0	11	BUSY
3	PD1	12	PE
4	PD2	13	SLCT
5	PD3	14	AFD/3M-
6	PD4	15	ERROR-
7	PD5	16	INIT-
8	PD6	17	SLIN-
9	PD7	18-25	GND

[Back to Contents Page](#)

Speaker Assembly

Dell™ Latitude™ D610 Service Manual

- [Removing the Speaker Assembly](#)
- [Installing the Speaker Assembly](#)

⚠ CAUTION: Before you begin any of the procedures in this section, follow the safety instructions in the *Product Information Guide*.

➡ NOTICE: To avoid electrostatic discharge, ground yourself by using a wrist grounding strap or by periodically touching an unpainted metal surface (such as the back panel) on the computer.

Removing the Speaker Assembly

1. Follow the instructions in "[Preparing to Work Inside the Computer](#)."
2. Remove the center control cover (see "[Removing the Center Control Cover](#)").
3. Remove the keyboard (see "[Removing the Keyboard](#)").
4. Remove the display assembly (see "[Removing the Display Assembly](#)").
5. Remove the palm rest (see "[Removing the Palm Rest](#)").
6. Disconnect the speaker cable from the speaker connector on the system board.

➡ NOTICE: Handle the speaker assembly with care to avoid damaging it.

7. Remove the two M2.5 x 5-mm screws (one on each side) from the speaker assembly.
8. Remove the speaker assembly by pulling it straight up and out of the computer base.

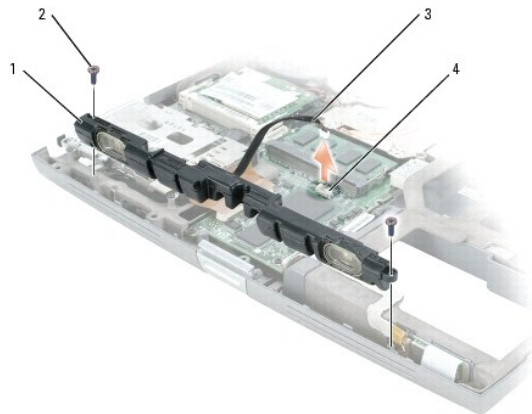

1	speaker assembly	3	speaker cable
2	M2.5 x 5-mm screws (2)	4	speaker connector on system board

Installing the Speaker Assembly

1. Slide the speaker assembly over the notch located in the center of the computer base.
 2. Replace the two M2.5 x 5-mm screws (one on each side) on the speaker assembly.
 3. Reconnect the speaker cable to the speaker connector on the system board.
-

System Board

Dell™ Latitude™ D610 Service Manual

- [Removing the System Board](#)
- [Installing the System Board](#)

Removing the System Board

⚠ CAUTION: Before you begin any of the procedures in this section, follow the safety instructions in the *Product Information Guide*.

👉 NOTICE: To avoid electrostatic discharge, ground yourself by using a wrist grounding strap or by periodically touching an unpainted metal surface (such as the back panel) on the computer.

The system board's BIOS chip contains the Service Tag, which is also visible on a barcode label on the bottom of the computer. The replacement kit for the system board includes a CD that provides a utility for transferring the Service Tag to the replacement system board.

👉 NOTICE: Disconnect the computer and any attached devices from electrical outlets, and remove any installed batteries.

👉 NOTICE: To avoid electrostatic discharge, ground yourself by using a wrist grounding strap or by touching an unpainted metal surface on the computer.

1. Follow the instructions in "[Preparing to Work Inside the Computer](#)."
2. Remove the center control cover (see "[Removing the Center Control Cover](#)").
3. Remove the keyboard (see "[Removing the Keyboard](#)").
4. Remove the display assembly (see "[Removing the Display Assembly](#)").
5. Remove the palm rest (see "[Removing the Palm Rest](#)").
6. Remove the fan (see "Removing the Fan").
7. Remove the microprocessor thermal-cooling assembly (see "[Removing the Microprocessor Thermal-Cooling Assembly](#)").
8. Remove the microprocessor (see "[Removing the Microprocessor Module](#)").
9. Remove the speaker assembly (see "Removing the Speaker Assembly").
10. Remove the internal card with Bluetooth® wireless technology (see step #4).
11. Remove the four M2x3 screws that secure the PCMCIA card cage to the system board.

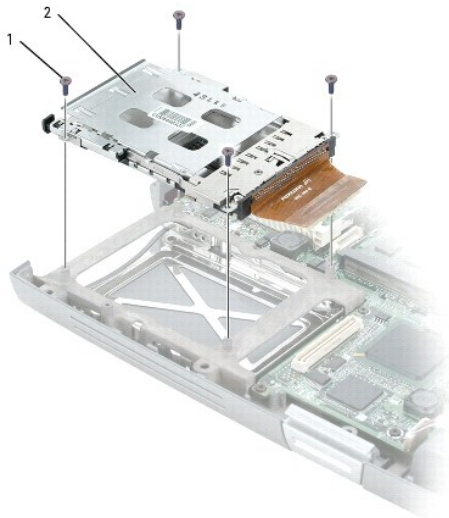

1	M2.5 x 4-mm screws (4)
2	PCMCIA card cage

12. Turn the computer over and remove the five M2 x 3-mm screws labeled "B" that secure the system board assembly to the computer base.

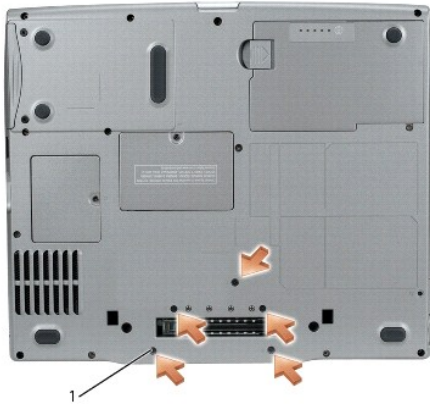

1	M2 x 3-mm screws (5)
---	----------------------

13. Pull out the system board assembly starting from the front of the palm rest.

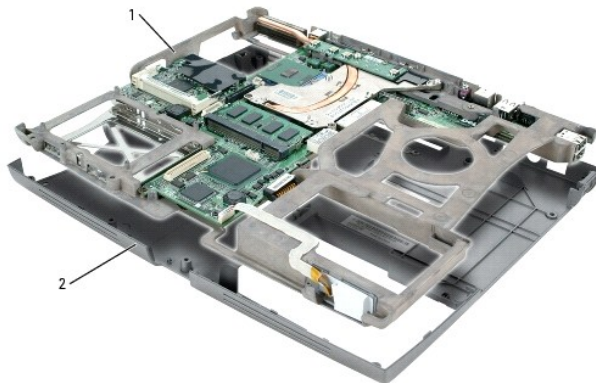

1	system board assembly
2	computer base

Installing the System Board

1. Follow all of the steps in "[Removing the System Board](#)" in reverse order.

NOTICE: Before turning on the computer, replace all screws and ensure that no stray screws remain inside the computer. Failure to do so may result in damage to the computer.

2. Turn on the computer.

NOTE: After replacing the system board, enter the computer Service Tag into the BIOS of the replacement system board.

3. Insert the CD that accompanied the replacement system board into the appropriate drive. Follow the instructions that appear on the screen.

System Components

Dell™ Latitude™ D610 Service Manual

- ➔ **NOTICE:** Only a certified service technician should perform repairs on your computer. Damage due to servicing that is not authorized by Dell is not covered by your warranty.
- ➔ **NOTICE:** Unless otherwise noted, each procedure in this document assumes that a part can be replaced by performing the removal procedure in reverse order.

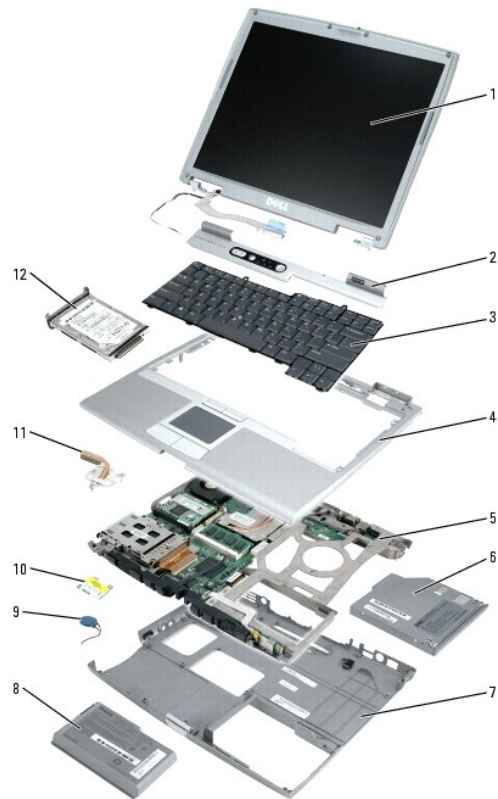

1	display assembly
2	center control cover
3	keyboard
4	palm rest
5	system board assembly
6	optical device
7	computer base
8	primary battery
9	coin-cell battery
10	modem
11	thermal cooling assembly
12	hard drive

Microprocessor Thermal-Cooling Assembly

Dell™ Latitude™ D610 Service Manual

- [Removing the Microprocessor Thermal-Cooling Assembly](#)
- [Installing the Microprocessor Thermal-Cooling Assembly](#)

Removing the Microprocessor Thermal-Cooling Assembly

⚠ CAUTION: Before you begin any of the procedures in this section, follow the safety instructions in the *Product Information Guide*.

🔌 NOTICE: To avoid electrostatic discharge, ground yourself by using a wrist grounding strap or by periodically touching an unpainted metal surface (such as the back panel) on the computer.

🔌 NOTICE: Disconnect the computer and any attached devices from electrical outlets, and remove any installed batteries.

1. Follow the instructions in "[Preparing to Work Inside the Computer](#)."
2. Remove the center control cover (see "[Removing the Center Control Cover](#)").
3. Remove the keyboard (see "[Removing the Keyboard](#)").
4. Remove the display assembly (see "[Removing the Display Assembly](#)").
5. Remove the palm rest (see "[Removing the Palm Rest](#)").

🔧 NOTE: You can remove the microprocessor thermal-cooling assembly with the fan attached.

6. Loosen in consecutive order the three captive screws, labeled "1" through "3," that secure the microprocessor thermal-cooling assembly to the system board.

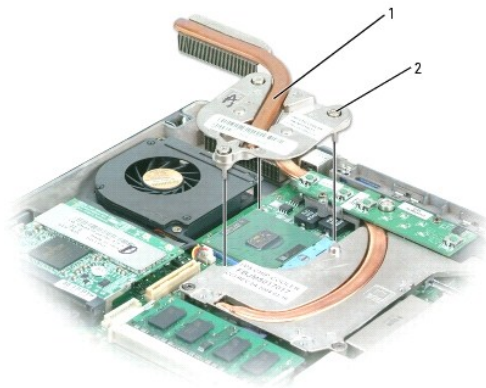

1	microprocessor thermal-cooling assembly
2	captive screws (3)

7. Lift to remove the microprocessor thermal-cooling assembly away from the system board.

Installing the Microprocessor Thermal-Cooling Assembly

1. Place the microprocessor thermal-cooling assembly on the system board.
 2. Tighten the three captive screws, labeled "1" through "3," in consecutive order.
-

[Back to Contents Page](#)

[Back to Contents Page](#)

Dell™ Latitude™ D610 Service Manual



NOTE: A NOTE indicates important information that helps you make better use of your computer.



NOTICE: A NOTICE indicates either potential damage to hardware or loss of data and tells you how to avoid the problem.



CAUTION: A CAUTION indicates a potential for property damage, personal injury, or death.

Information in this document is subject to change without notice.
© 2004–2005 Dell Inc. All rights reserved.

Reproduction in any manner whatsoever without the written permission of Dell Inc. is strictly forbidden.

Trademarks used in this text: *Dell*, the *DELL* logo, and *Latitude* are trademarks of Dell Inc.; *Intel* is a registered trademark of Intel Corporation; *Bluetooth* is a registered trademark owned by Bluetooth SIG, Inc. and is used by Dell Inc. under license.

Other trademarks and trade names may be used in this document to refer to either the entities claiming the marks and names or their products. Dell Inc. disclaims any proprietary interest in trademarks and trade names other than its own.

Model PP11L

November 2005 Rev. A01

[Back to Contents Page](#)

Memory Module, Modem, and Devices

Dell™ Latitude™ D610 Service Manual

- [Memory Module](#)
- [Modem](#)
- [Devices](#)

Memory Module

⚠ CAUTION: Before you begin any of the procedures in this section, follow the safety instructions in the *Product Information Guide*.

⚠ CAUTION: To prevent static damage to components inside your computer, discharge static electricity from your body before you touch any of your computer's electronic components. You can do so by touching an unpainted metal surface.

🔧 NOTE: You can only use DDR2 memory modules in your computer.

🔧 NOTE: Memory modules purchased from Dell are covered under your computer warranty.

Your computer has two user-accessible SODIMM sockets, one accessed from beneath the keyboard (DIMM A), and the other accessed from the bottom of the computer (DIMM B).

Removing the Memory Module From DIMM A

1. Follow the instructions in "[Preparing to Work Inside the Computer](#)."
2. Remove the center control cover (see "[Removing the Center Control Cover](#)").
3. Remove the keyboard (see "[Removing the Keyboard](#)").



1 memory module (DIMM A)

➡ NOTICE: To prevent damage to the memory module connector, do not use tools to spread the inner metal tabs that secure the memory module.

➡ NOTICE: Handle memory modules by their edges, and do not touch the components on a module.

🔧 NOTE: If you are replacing a memory module, remove the existing module.

4. Use your fingertips to carefully spread apart the securing clips on each end of the memory module connector until the module pops up.
5. Remove the module from the connector.

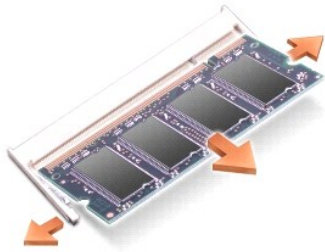

- ➡ **NOTICE:** If you need to install memory modules in two connectors, install a memory module in the connector labeled "DIMM B" before you install a module in the connector labeled "DIMM A."

Removing the Memory Module From DIMM B

1. Follow the instructions in "[Preparing to Work Inside the Computer.](#)"
2. Turn the computer over, loosen the captive screw in the memory module cover, and then remove the cover.



1	captive screw
---	---------------

- ➡ **NOTICE:** To prevent damage to the memory module connector, do not use tools to spread the inner metal tabs that secure the memory module.
- ➡ **NOTICE:** Handle memory modules by their edges, and do not touch the components on a module.
- 🔧 **NOTE:** If you are replacing a memory module, remove the existing module.

3. Use your fingertips to carefully spread apart the securing clips on each end of the memory module connector until the module pops up.
4. Remove the module from the connector.

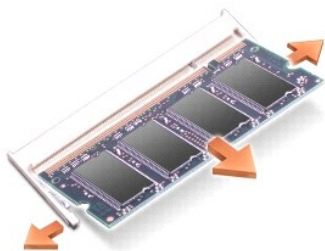

Installing the Memory Module

1. Ground yourself and install the new memory module:
 - a. Align the notch in the module with the slot in the center of the connector.
 - b. Slide the edge of the module firmly into the connector, and rotate the module down until you feel a click. If you do not feel the click, remove the module and reinstall it.

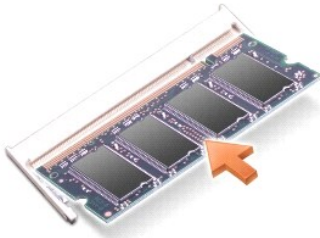

 **NOTE:** If the memory module is not installed properly, the computer does not boot. No error message indicates this failure.

2. Replace the cover and tighten the captive screw.

 **NOTICE:** If the memory module cover is difficult to close, remove the module and reinstall it. Forcing the cover to close may damage your computer.

3. Insert the battery into the battery bay, or connect the AC adapter to your computer and an electrical outlet.

4. Turn on the computer.

As the computer boots, it detects the additional memory and automatically updates the system configuration information.

Modem

 **CAUTION:** Before you begin any of the procedures in this section, follow the safety instructions in the *Product Information Guide*.

 **CAUTION:** To prevent static damage to components inside your computer, discharge static electricity from your body before you touch any of your computer's electronic components. You can do so by touching an unpainted metal surface.

 **NOTICE:** Handle components and cards by their edges, and avoid touching pins and contacts.

Removing the Modem

1. Follow the instructions in "[Preparing to Work Inside the Computer](#)."
2. Turn the computer over, and loosen the captive screw on the modem cover.
3. Place your finger under the indentation and lift the cover open.



1	captive screw
---	---------------

4. Remove the M2 x 3-mm screw that attaches the modem.
5. Pull up on the pull-tab to disconnect the modem from the connector on the system board.



1	M2 x 3-mm screw
2	modem

➔ **NOTICE:** Do not disconnect the modem cable from the system board.

6. Disconnect the modem cable from the modem.

Installing the Modem

1. Connect the modem cable to the modem.

➔ **NOTICE:** Ensure that the modem cable is routed correctly when you replace the modem.

➔ **NOTICE:** Do not press down on the left side of the modem while installing it.

2. Align the connector on the bottom of the modem with the modem connector on the system board and then press down on the right side of the modem to seat both connectors.
3. Replace the M2 x 3-mm screw.

4. Replace the modem cover.

Devices

Your computer ships with an optical drive installed in the module bay. However, the device security screw is not installed in the optical drive but packaged separately. When you install your device in the module bay, you can install the device security screw.

- ➔ **NOTICE:** Insert devices into the module bay before you dock and turn on the computer.
- 🔍 **NOTE:** You do not need to install the device security screw unless you want to secure the module inside the computer for security purposes.

Removing the Device if the Security Screw Is Not Installed

- ➔ **NOTICE:** To prevent damage to devices, place them in a safe, dry place when they are not installed in the computer. Avoid pressing down on them or placing heavy objects on top of them.

1. Press the device latch release so that the latch release pops out.



1	device latch release
---	----------------------

2. Pull the device by the latch release to remove the device from the module bay.



Removing the Device if the Security Screw Is Installed

1. If the computer is connected to a docking device (docked), undock it. See the documentation that came with your docking device for instructions.

- ➔ **NOTICE:** To prevent damage to devices, place them in a safe, dry place when they are not installed in the computer. Avoid pressing down on them or placing heavy objects on top of them.

2. Close the display and turn the computer over.
3. Use a #1 Phillips screwdriver to remove the M2 x 3-mm screw from the bottom of the computer.



1	M2 x 3-mm screw
---	-----------------

4. Press the device latch release so that the latch release pops out.
5. Pull the device by the latch release to remove the device from the module bay.



Installing the Device

1. Slide the device into the bay until it clicks in place.
2. Press the latch release back into position and replace the security screw if needed.

[Back to Contents Page](#)