



Alienware® M14x Service Manual

[Before You Begin](#)
[Base Cover](#)
[Battery Pack](#)
[Optical Drive](#)
[Hard Drive](#)
[Memory Module\(s\)](#)
[Center-Control Cover](#)
[Keyboard](#)
[Palm-Rest Assembly](#)
[Wireless Mini-Card\(s\)](#)
[Power-Button Board](#)
[Status-Light Board](#)

[Speakers](#)
[Subwoofer](#)
[Internal Card With Bluetooth® Wireless Technology](#)
[Coin-Cell Battery](#)
[Display Assembly](#)
[Mini-Card Board](#)
[System Board](#)
[Thermal Fan](#)
[Thermal Cooling Assembly](#)
[Processor Module](#)
[System Setup](#)
[Flashing the BIOS](#)

Notes, Cautions, and Warnings

-  **NOTE:** A NOTE indicates important information that helps you make better use of your computer.
 -  **CAUTION:** A CAUTION indicates potential damage to hardware or loss of data if instructions are not followed.
 -  **WARNING:** A WARNING indicates a potential for property damage, personal injury, or death.
-

Information in this document is subject to change without notice.
© 2011 Dell Inc. All rights reserved.

Reproduction of these materials in any manner whatsoever without the written permission of Dell Inc. is strictly forbidden.

Trademarks used in this text: Dell™ and the DELL logo are trademarks of Dell Inc.; Alienware® is a trademark or registered trademark of Alienware Corporation; Microsoft®, Windows®, and the Windows start button logo  are either trademarks or registered trademarks of Microsoft Corporation in the United States and/or other countries; Bluetooth® is a registered trademark owned by Bluetooth SIG, Inc. and is used by Dell under license.

Other trademarks and trade names may be used in this document to refer to either the entities claiming the marks and names or their products. Dell Inc. disclaims any proprietary interest in trademarks and trade names other than its own.

Regulatory model: P18G Regulatory type: P18G001

2011 - 02 Rev. A00

Battery Pack

Alienware® M14x Service Manual

- [Removing the Battery Pack](#)
- [Replacing the Battery Pack](#)

- ⚠ WARNING:** Before working inside your computer, read the safety information that shipped with your computer. For additional safety best practices information, see the Regulatory Compliance Homepage at dell.com/regulatory_compliance.
- ⚠ CAUTION:** To avoid electrostatic discharge, ground yourself by using a wrist grounding strap or by periodically touching an unpainted metal surface (such as a connector on your computer).
- ⚠ CAUTION:** Only a certified service technician should perform repairs on your computer. Damage due to servicing that is not authorized by Dell is not covered by your warranty.
- ⚠ CAUTION:** To avoid damage to the computer, use only the battery designed for this particular Alienware computer. Do not use batteries designed for other Alienware computers.
-

Removing the Battery Pack

1. Follow the instructions in [Before You Begin](#).
2. Remove the base cover (see [Removing the Base Cover](#)).
3. Disconnect the battery-pack cable from the connector on the system board.
4. Loosen the two captive screws that secure the battery pack to the computer base.
5. Using the pull-tab, lift the battery pack off the computer base.

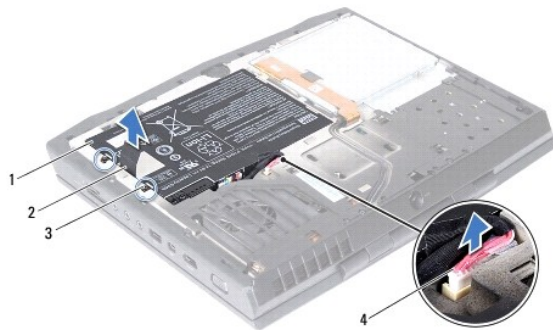

1	battery pack	2	pull-tab
3	captive screws (2)	4	battery-pack cable

Replacing the Battery Pack

- ⚠ CAUTION:** To avoid damage to the computer, use only the battery designed for this particular Alienware computer.

1. Follow the instructions in [Before You Begin](#).
 2. Place the battery pack in the battery bay and tighten the two captive screws that secure the battery pack to the computer base.
 3. Connect the battery-pack cable to the connector on the system board.
 4. Replace the base cover (see [Replacing the Base Cover](#)).
-

[Back to Contents Page](#)

Before You Begin

Alienware® M14x Service Manual

- [Recommended Tools](#)
- [Turning Off Your Computer](#)
- [Before Working Inside Your Computer](#)
- [Contacting Alienware](#)

This manual provides procedures for removing and installing the components in your computer. Unless otherwise noted, each procedure assumes that the following conditions exist:

- 1 You have performed the steps in [Turning Off Your Computer](#) and [Before Working Inside Your Computer](#).
- 1 You have read the safety information that shipped with your computer.
- 1 A component can be replaced or—if purchased separately—installed by performing the removal procedure in reverse order.

Recommended Tools

The procedures in this document may require the following tools:

- 1 Small flat-blade screwdriver
- 1 Phillips screwdriver
- 1 Plastic scribe
- 1 BIOS executable update program at support.dell.com

Turning Off Your Computer

 **CAUTION:** To avoid losing data, save and close all open files and exit all open programs before you turn off your computer.

1. Save and close all open files and exit all open programs.
2. Click **Start** , and then click **Shut Down**.

The computer turns off after the operating system shutdown process finishes.

3. Ensure that the computer and any attached devices are turned off. If your computer and attached devices did not automatically turn off when you shut down your operating system, press and hold the power button for at least 8 to 10 seconds until the computer turns off.

Before Working Inside Your Computer

Use the following safety guidelines to help protect your computer from potential damage and to help to ensure your own personal safety.

 **WARNING:** Before working inside your computer, read the safety information that shipped with your computer. For additional safety best practices information, see the Regulatory Compliance Homepage at dell.com/regulatory_compliance.

 **CAUTION:** To avoid electrostatic discharge, ground yourself by using a wrist grounding strap or by periodically touching an unpainted metal surface (such as a connector on your computer).

 **CAUTION:** Handle components and cards with care. Do not touch the components or contacts on a card. Hold a card by its edges or by its metal mounting bracket. Hold a component such as a processor by its edges, not by its pins.

 **CAUTION:** Only a certified service technician should perform repairs on your computer. Damage due to servicing that is not authorized by Dell™ is not covered by your warranty.

 **CAUTION:** When you disconnect a cable, pull on its connector or on its pull-tab, not on the cable itself. Some cables have connectors with locking tabs; if you are disconnecting this type of cable, press in on the locking tabs before you disconnect the cable. As you pull connectors apart, keep them evenly aligned to avoid bending any connector pins. Also, before you connect a cable, ensure that both connectors are correctly oriented and aligned.

 **CAUTION:** To avoid damaging the computer, perform the following steps before you begin working inside the computer.

1. Ensure that the work surface is flat and clean to prevent the computer cover from being scratched.

2. Turn off your computer (see [Turning Off Your Computer](#)).

 **CAUTION:** To disconnect a network cable, first unplug the cable from your computer and then unplug the cable from the network device.

3. Disconnect all telephone or network cables from the computer.
4. Press and eject any installed cards from the 9-in--1 Media Card Reader.
5. Disconnect your computer and all attached devices from their electrical outlets.
6. Disconnect all attached devices from your computer.

 **CAUTION:** To help prevent damage to the system board, remove the main battery (see [Removing the Battery Pack](#)) before working inside the computer.

7. Remove the battery pack (see [Removing the Battery Pack](#)).
8. Turn the computer top-side up, open the display, and press the power button to ground the system board.

Contacting Alienware

For customers in the United States/Canada, call 1-800-ALIENWARE.

 **NOTE:** If you do not have an active Internet connection, you can find contact information on your purchase invoice, packing slip, bill, or Dell product catalog.

Dell provides several online and telephone-based support and service options. Because availability varies by country and product, some services may not be available in your area.

To contact Dell for sales, technical support, or customer service issues:

1. Go to dell.com/contactdell.
2. Select your country or region.
3. Select the appropriate service or support link based on your need.
4. Choose the method of contacting Dell that is convenient for you.

[Back to Contents Page](#)

System Setup

Alienware® M14x Service Manual

● [Configuring the System Setup](#)

Configuring the System Setup

The System Setup options allow you to:

- 1 Change the system configuration information after you add, change or remove any hardware in your laptop.
- 1 Set or change a user-selectable option.
- 1 View the installed amount of memory or set the type of hard drive installed.

Before you use System Setup, it is recommended that you write down the current System Setup information for future reference.

 **CAUTION:** Do not change the settings in System Setup unless you are an expert computer user. Certain changes can cause your computer to work incorrectly.

Entering System Setup

1. Turn on (or restart) your laptop.

 **NOTE:** Keyboard failure may result when a key on the keyboard is held down for extended periods of time. To avoid possible keyboard failure, press and release <F2> in even intervals until the System Setup screen appears.

2. While the laptop is booting, press <F2> immediately before the operating system logo appears to access the **BIOS Setup Utility**. If an error occurs during Power On Self Test (POST), you may also enter the **BIOS Setup Utility** by pressing <F2> when prompted.

 **NOTE:** If you wait too long and the operating system logo appears, continue to wait until you see the Microsoft Windows desktop, then shut down your laptop and try again.

System Setup Screens

The **BIOS Setup Utility** window displays current or changeable configuration information for your laptop. Information is divided into five menus: **Main**, **Advanced**, **Security**, **Boot**, and **Exit**.

Key functions appear at the bottom of the **BIOS Setup Utility** window and lists keys and their functions within the active field.

System Setup Options

 **NOTE:** Depending on your computer and installed devices, the items listed in this section may not appear, or may not appear exactly as listed.

Main Menu	
System Time (hh:mm:ss)	Displays the system time.
System Date (mm/dd/yy)	Displays the system date.
Alienware	Displays the model number of your computer.
Service Tag	Displays the service tag of your computer.
BIOS Version	Displays the BIOS version.
EC Version	Displays the EC firmware version.
ME version	Displays the Intel ME firmware version.
CPU	Displays the type of processor installed.
CPU Frequency	Displays the speed of the processor.
CPU L3 Cache	Displays the processor cache size.
CPUID	Displays the ID of the processor.
Integrated Graphics	Displays the integrated graphics
Discrete Graphics	Displays the discrete graphics
Total Memory	Displays the total memory available in your computer.
Memory Bank 0	Displays the memory size installed in DIMM 0.
Memory Bank 1	Displays the memory size installed in DIMM 1.

Advanced Menu	
Intel SpeedStep	Allows you to enable or disable the Intel SpeedStep technology. Disabling this feature may improve performance, but will greatly reduce battery life.
Virtualization	Allows you to enable or disable the Intel Virtualization technology.
USB Emulation	Allows you to enable or disable the USB emulation feature. This feature defines how the BIOS, in the absence of a USB-aware operating system, handles USB devices. USB emulation is always enabled during POST. NOTE: You cannot boot any type of USB device (floppy, hard drive, or memory key) when this option is off.
USB Wake Support	Allows you to enable USB devices to wake the computer from standby or to disable the USB wake support feature. NOTE: If USB Powershare is enabled, a device connected to the USB Powershare connector may not wake the computer.
USB Power Share	Allows you to charge USB devices when the computer is turned off or in standby mode. <ul style="list-style-type: none"> AC Only: Charge USB devices when connected to AC adapter only. AC and Battery: Charge USB devices when connected to AC adapter and when the computer is running on battery. Disabled: Disables USB PowerShare.
Integrated Network	Allows you to enable or disable the on-board LAN controller. <ul style="list-style-type: none"> Disabled: Internal LAN is disabled and is not visible to the operating system. Enabled: Internal LAN is enabled.
High Definition Audio	Allows you to enable or disable the internal high definition audio device. <ul style="list-style-type: none"> Disabled: The internal audio device is disabled and is not visible to the operating system. Enabled: The internal audio device is enabled.
SD Card Reader	Allows you to enable or disable the internal SD card reader.
Performance Options	Allows you to configure fields in the Performance Options sub-menu (for more information, see Advanced — Performance Options Menu).
SATA Operation	Allows you to configure the operating mode of the integrated SATA hard drive controller. <ul style="list-style-type: none"> ATA: SATA is configured for ATA mode. AHCI: SATA is configured for AHCI mode.
SATA HARD DRIVE 1	Displays the installed SATA hard drive model.
Adapter Warnings	Allows you to choose if the computer should display warning messages when you use certain power adapters. The computer displays these messages if you attempt to use a power adapter that has too little capacity for your configuration. <ul style="list-style-type: none"> Disabled: BIOS will not detect unsupported AC adapters and will not display any message on the screen. Enabled: BIOS will detect unsupported AC adapters and display an error on the screen.
Charger Behavior	Allows you to enable or disable battery charging.
Advanced — Performance Options Menu	
CPU Turbo Mode	Allows you to enable or disable the Intel CPU turbo mode performance option.
Overclocking Features	Allows you to enable or disable the global overclocking feature. <ul style="list-style-type: none"> Disabled: The overclocking feature is disabled. Enabled: Displays additional overclocking options.
Override Turbo settings	Allows you to override CPU turbo mode settings.
Long Duration Power Limit	Allows you to set the turbo mode power limit 1 value in watts.
Long Duration Time Window	Allows you to set the turbo mode time 1 value in seconds.
Short Duration Power Limit	Allows you to enable or disable short duration power limit.
Short Duration Time Window	Allows you to set the turbo mode power limit 2 value in watts.
Bus Clock	
Current Frequency	Displays the current bus clock frequency.
New Frequency in 10KHz increments	Allows you to enter a new bus clock frequency in 10 KHz increments.
Apply New Bus Clock Frequency	Allows you to apply the new bus clock frequency <ul style="list-style-type: none"> Immediately: The new bus clock frequency is applied immediately.

	<ul style="list-style-type: none"> 1 Once: The new bus clock frequency is applied once until the next reboot. 1 Permanently: The new bus clock frequency is applied permanently after the next reboot.
Memory Overclocking	
Memory Override Support	<p>Allows you to enable or disable the memory override option support.</p> <ul style="list-style-type: none"> 1 Disabled: The memory override support is disabled. 1 Enabled: Displays additional memory override support options.
Memory Voltage	Allows you to increase memory voltage.
Memory Frequency	Allows you to set memory frequency.
XMP DIMM Profile	Allows you to configure different XMP options.
Wireless Menu	
Bluetooth	<p>Allows you to enable or disable the internal Bluetooth device.</p> <ul style="list-style-type: none"> 1 Disabled: The internal Bluetooth device is disabled and is not visible to the operating system. 1 Enabled: The internal Bluetooth device is enabled.
Wireless Network	<p>Allows you to enable or disable the internal wireless device.</p> <ul style="list-style-type: none"> 1 Disabled: The internal wireless device is disabled and is not visible to the operating system. 1 Enabled: The internal wireless device is enabled.
WWAN	<p>Allows you to enable or disable the internal WWAN device.</p> <ul style="list-style-type: none"> 1 Disabled: The internal WWAN device is disabled and is not visible to the operating system. 1 Enabled: The internal WWAN device is enabled.
Wireless Switch/Hotkey	Allows you to disable all internal wireless devices.
Security Menu	
Supervisor Password	Displays if the supervisor password is clear or set.
User Password	Displays if the user password is clear or set.
Set Service Tag	<p>Displays the service tag of the computer when the service tag is present.</p> <p>Displays a field to input the service tag manually when the service tag is absent.</p>
Set Supervisor Password	Allows you to set the supervisor password. The supervisor password controls access to the system setup utility.
Set User Password	Allows you to set the user password. The user password controls access to the computer at boot.
Computrace	Allows you to enable or disable Computrace security feature.
Boot Menu	
<p>Use the up or down arrow keys to change the boot device priority. You can choose from:</p> <ul style="list-style-type: none"> 1 Hard Drive 1 USB Storage 1 CD/DVD/BD 1 Removal Devices 1 Network 	
Exit Menu	
Exit Saving Changes	Allows you to exit System Setup and save your changes to CMOS.
Save Change Without Exit	Allows you remain in System Setup and save your changes to CMOS.
Exit Discarding Changes	Allows you to exit System Setup and load previous values from CMOS for all Setup items.
Load Optimal Defaults	Allows you to load default values for all Setup items.
Discard Changes	Allows you to load previous values from CMOS for all Setup items.

[Back to Contents Page](#)

Base Cover

Alienware® M14x Service Manual

- [Removing the Base Cover](#)
- [Replacing the Base Cover](#)

WARNING: Before working inside your computer, read the safety information that shipped with your computer. For additional safety best practices information, see the Regulatory Compliance Homepage at dell.com/regulatory_compliance.

CAUTION: To avoid electrostatic discharge, ground yourself by using a wrist grounding strap or by periodically touching an unpainted metal surface (such as a connector on your computer).

CAUTION: Only a certified service technician should perform repairs on your computer. Damage due to servicing that is not authorized by Dell is not covered by your warranty.

Removing the Base Cover

1. Follow the instructions in [Before You Begin](#).
2. Turn the computer over.
3. Loosen the two captive screws that secure the base cover to the computer base.
4. Slide and lift the base cover off the computer base.



1	captive screws (2)	2	base cover
---	--------------------	---	------------

Replacing the Base Cover

1. Follow the instructions in [Before You Begin](#).
 2. Align the tabs on the base cover with the slots on the computer base and slide the base cover until it snaps into place.
 3. Tighten the two captive screws that secure the base cover to the computer base.
-

[Back to Contents Page](#)

Internal Card With Bluetooth® Wireless Technology

Alienware® M14x Service Manual

- [Removing the Bluetooth Card](#)
- [Replacing the Bluetooth Card](#)

WARNING: Before working inside your computer, read the safety information that shipped with your computer. For additional safety best practices information, see the Regulatory Compliance Homepage at dell.com/regulatory_compliance.

CAUTION: To avoid electrostatic discharge, ground yourself by using a wrist grounding strap or by periodically touching an unpainted metal surface (such as a connector on your computer).

CAUTION: Only a certified service technician should perform repairs on your computer. Damage due to servicing that is not authorized by Dell is not covered by your warranty.

CAUTION: To help prevent damage to the system board, remove the main battery (see [Removing the Battery Pack](#)) before working inside the computer.

If you ordered a card with Bluetooth wireless technology with your computer, it is already installed.

Removing the Bluetooth Card

1. Follow the instructions in [Before You Begin](#).
2. Remove the base cover (see [Removing the Base Cover](#)).
3. Remove the battery pack (see [Removing the Battery Pack](#)).
4. Remove the center-control cover (see [Removing the Center-Control Cover](#)).
5. Remove the keyboard (see [Removing the Keyboard](#)).
6. Remove the palm-rest assembly (see [Removing the Palm-Rest Assembly](#)).
7. Disconnect the Bluetooth-card cable from the connector on the system board.
8. Remove the screw that secures the Bluetooth card to the computer base.
9. Note the routing of Bluetooth card cable and remove the cable from the routing guides.
10. Lift the Bluetooth card along with the cable off the computer base.

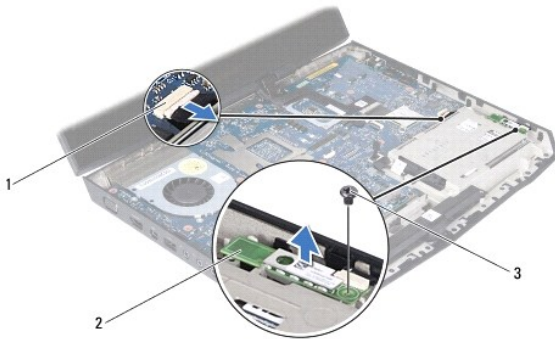

1	Bluetooth-card cable connector	2	Bluetooth card
3	Screw		

Replacing the Bluetooth Card

1. Follow the instructions in [Before You Begin](#).
2. Align the screw hole on the Bluetooth card with the screw hole on the system board.
3. Replace the screw that secures the Bluetooth card to the computer base.
4. Connect the Bluetooth-card cable to the connector on the system board.
5. Replace the palm-rest assembly (see [Replacing the Palm-Rest Assembly](#)).
6. Replace the keyboard (see [Replacing the Keyboard](#)).
7. Replace the center-control cover (see [Replacing the Center-Control Cover](#)).
8. Replace the battery pack (see [Replacing the Battery Pack](#)).
9. Replace the base cover (see [Replacing the Base Cover](#)).

 **CAUTION:** Before turning on the computer, replace all screws and ensure that no stray screws remain inside the computer. Failure to do so may result in damage to the computer.

[Back to Contents Page](#)

[Back to Contents Page](#)

Coin-Cell Battery

Alienware® M14x Service Manual

- [Removing the Coin-Cell Battery](#)
- [Replacing the Coin-Cell Battery](#)

- WARNING:** Before working inside your computer, read the safety information that shipped with your computer. For additional safety best practices information, see the Regulatory Compliance Homepage at dell.com/regulatory_compliance.
- CAUTION:** To avoid electrostatic discharge, ground yourself by using a wrist grounding strap or by periodically touching an unpainted metal surface (such as a connector on your computer).
- CAUTION:** Only a certified service technician should perform repairs on your computer. Damage due to servicing that is not authorized by Dell is not covered by your warranty.
- CAUTION:** To help prevent damage to the system board, remove the main battery (see [Removing the Battery Pack](#)) before working inside the computer.
-

Removing the Coin-Cell Battery

1. Follow the instructions in [Before You Begin](#).
2. Remove the base cover (see [Removing the Base Cover](#)).
3. Remove the battery pack (see [Removing the Battery Pack](#)).
4. Remove the center-control cover (see [Removing the Center-Control Cover](#)).
5. Remove the keyboard (see [Removing the Keyboard](#)).
6. Remove the palm-rest assembly (see [Removing the Palm-Rest Assembly](#)).
7. Disconnect the coin-cell battery cable from the connector on the system board.
8. Pry up the coin-cell battery from the slot on the computer base.



1	coin-cell battery cable	2	coin-cell battery
---	-------------------------	---	-------------------

Replacing the Coin-Cell Battery

1. Follow the instructions in [Before You Begin](#).
2. Use the adhesive on the coin-cell battery and adhere it to slot on the computer base.
3. Connect the coin-cell battery cable to the connector on the system board.
4. Replace the palm-rest assembly (see [Replacing the Palm-Rest Assembly](#)).

5. Replace the keyboard (see [Replacing the Keyboard](#)).
6. Replace the center-control cover (see [Replacing the Center-Control Cover](#)).
7. Replace the battery pack (see [Replacing the Battery Pack](#)).
8. Replace the base cover (see [Replacing the Base Cover](#)).

 **CAUTION:** Before turning on the computer, replace all screws and ensure that no stray screws remain inside the computer. Failure to do so may result in damage to the computer.

[Back to Contents Page](#)

Display Assembly

Alienware® M14x Service Manual

- [Removing the Display Assembly](#)
- [Replacing the Display Assembly](#)

- WARNING:** Before working inside your computer, read the safety information that shipped with your computer. For additional safety best practices information, see the Regulatory Compliance Homepage at dell.com/regulatory_compliance.
- CAUTION:** To avoid electrostatic discharge, ground yourself by using a wrist grounding strap or by periodically touching an unpainted metal surface (such as a connector on your computer).
- CAUTION:** Only a certified service technician should perform repairs on your computer. Damage due to servicing that is not authorized by Dell is not covered by your warranty.
- CAUTION:** To help prevent damage to the system board, remove the main battery (see [Removing the Battery Pack](#)) before working inside the computer.
-

Removing the Display Assembly

1. Follow the instructions in [Before You Begin](#).
2. Remove the base cover (see [Removing the Base Cover](#)).
3. Remove the battery pack (see [Removing the Battery Pack](#)).
4. Disconnect the antenna cables from the Mini-Card(s) (see [Removing the Mini-Card\(s\)](#)).
5. Note the routing of the Mini-Card antenna cables and remove them from the routing guides on the computer base.

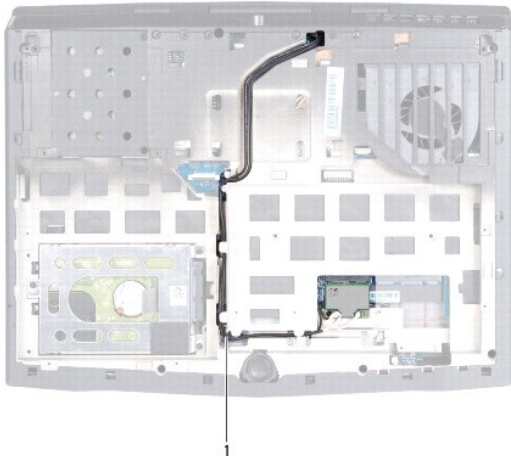

1	Mini-Card antenna cables
---	--------------------------

6. Turn the computer over and open the display as far as possible.
7. Remove the center-control cover (see [Removing the Center-Control Cover](#)).
8. Remove the keyboard (see [Removing the Keyboard](#)).
9. Remove the palm-rest assembly (see [Removing the Palm-Rest Assembly](#)).
10. Using the pull tab, disconnect the display cable from the connector on the system board.
11. Disconnect the touch-screen board cable from the connector on the system board.
12. Remove the four screws that secure the display assembly to the computer base.

13. Gently slide the Mini-Card antenna cables out through the slot on the computer base.
14. Lift the display assembly off the computer.

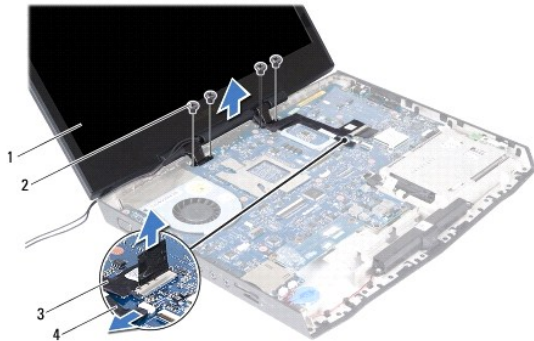

1	display assembly	2	screws (4)
3	display cable	4	touch-screen board cable

Replacing the Display Assembly

1. Follow the instructions in [Before You Begin](#).
2. Slide the antenna cables in through the slot on the computer base.
3. Place the display assembly in position and replace the four screws that secure the display assembly to the computer base.
4. Connect the display cable to the connector on the system board.
5. Connect the touch-screen board cable to the connector on the system board.
6. Turn the computer over and route the Mini-Card antenna cables through the routing guides on the computer base.
7. Connect the Mini-Card antenna cables to the Mini-Card(s) (see [Replacing the Mini-Card\(s\)](#)).
8. Replace the palm-rest assembly (see [Replacing the Palm-Rest Assembly](#)).
9. Replace the keyboard (see [Replacing the Keyboard](#)).
10. Replace the center-control cover (see [Replacing the Center-Control Cover](#)).
11. Replace the battery pack (see [Replacing the Battery Pack](#)).
12. Replace the base cover (see [Replacing the Base Cover](#)).

CAUTION: Before turning on the computer, replace all screws and ensure that no stray screws remain inside the computer. Failure to do so may result in damage to the computer.

[Back to Contents Page](#)

[Back to Contents Page](#)

Thermal Fan

Alienware® M14x Service Manual

- [Removing the Thermal Fan](#)
- [Replacing the Thermal Fan](#)

- WARNING:** Before working inside your computer, read the safety information that shipped with your computer. For additional safety best practices information, see the Regulatory Compliance Homepage at www.dell.com/regulatory_compliance.
- CAUTION:** Only a certified service technician should perform repairs on your computer. Damage due to servicing that is not authorized by Dell™ is not covered by your warranty.
- CAUTION:** To avoid electrostatic discharge, ground yourself by using a wrist grounding strap or by periodically touching an unpainted metal surface (such as a connector on your computer).
- CAUTION:** To help prevent damage to the system board, remove the main battery (see [Removing the Battery Pack](#)) before working inside the computer.
-

Removing the Thermal Fan

1. Follow the instructions in [Before You Begin](#).
2. Follow the instructions from [step 2](#) to [step 17](#) in Removing the System Board.
3. Disconnect the thermal fan cable from the connector on the system board.
4. Remove the three screws that secure the thermal fan to the system board.
5. Lift the thermal fan and gently peel the tape that secures the thermal fan to the heat sink.
6. Lift the thermal fan off the system board.

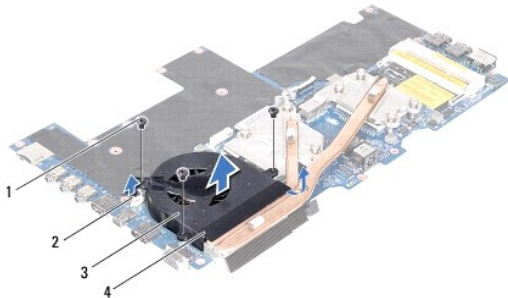

1	screws (3)	2	thermal fan cable connector
3	thermal fan	4	tape

Replacing the Thermal Fan

1. Follow the instructions in [Before You Begin](#).
2. Align the screw holes on the thermal fan with the screw holes on the system board.
3. Adhere the tape to secure the thermal fan to the heat sink.
4. Replace the three screws that secure the thermal fan to the system board.
5. Connect the thermal fan cable to the connector on the system board.

6. Follow the instructions from [step 5](#) to [step 20](#) in Replacing the System Board.

 **CAUTION:** Before turning on the computer, replace all screws and ensure that no stray screws remain inside the computer. Failure to do so may result in damage to the computer.

[Back to Contents Page](#)

Flashing the BIOS

Alienware® M14x Service Manual

1. Turn on the computer.
2. Go to support.dell.com/support/downloads.
3. Locate the BIOS update file for your computer:

 **NOTE:** The Service Tag for your computer is located on a label at the bottom of the computer.

If you have your computer's Service Tag:

- a. Click **Enter a Service Tag**.
- b. Enter your computer's Service Tag in the **Enter a service tag:** field, click **Go**, and proceed to [step 4](#).

If you do not have your computer's Service Tag:

- a. Click **Select Model**.
- b. Select the type of product in the **Select Your Product Family** list.
- c. Select the product brand in the **Select Your Product Line** list.
- d. Select the product model number in the **Select Your Product Model** list.

 **NOTE:** If you have selected a different model and want to start over again, click **Start Over** on the top right of the menu.

- e. Click **Confirm**.
4. A list of results appear on the screen. Click **BIOS**.
 5. Click **Download Now** to download the latest BIOS file.
The **File Download** window appears.
 6. Click **Save** to save the file on your desktop. The file downloads to your desktop.
 7. Click **Close** if the **Download Complete** window appears.
The file icon appears on your desktop and is titled the same as the downloaded BIOS update file.
 8. Double-click the file icon on the desktop and follow the instructions on the screen.

Hard Drive

Alienware® M14x Service Manual

- [Removing the Hard Drive](#)
- [Replacing the Hard Drive](#)

- ⚠ **WARNING:** If you remove the hard drive from the computer when the drive is hot, do not touch the metal housing of the hard drive.
- ⚠ **WARNING:** Before working inside your computer, read the safety information that shipped with your computer. For additional safety best practices information, see the Regulatory Compliance Homepage at dell.com/regulatory_compliance.
- ⚠ **CAUTION:** To avoid electrostatic discharge, ground yourself by using a wrist grounding strap or by periodically touching an unpainted metal surface (such as a connector on your computer).
- ⚠ **CAUTION:** To help prevent damage to the system board, remove the main battery (see [Removing the Battery Pack](#)) before working inside the computer.
- ⚠ **CAUTION:** To prevent data loss, turn off your computer (see [Turning Off Your Computer](#)) before removing the hard-drive assembly. Do not remove the hard drive while the computer is On or in Sleep state.
- ⚠ **CAUTION:** Hard drives are extremely fragile. Exercise care when handling the hard drive.
- ⚠ **CAUTION:** Only a certified service technician should perform repairs on your computer. Damage due to servicing that is not authorized by Dell is not covered by your warranty.
- ⚠ **CAUTION:** When you disconnect a cable, pull on its connector or on its pull-tab, not on the cable itself. Some cables have connectors with locking tabs; if you are disconnecting this type of cable, press in on the locking tabs before you disconnect the cable. As you pull connectors apart, keep them evenly aligned to avoid bending any connector pins. Also, before you connect a cable, ensure that both connectors are correctly oriented and aligned.
- 🔧 **NOTE:** Dell or Alienware does not guarantee compatibility or provide support for hard drives from sources other than Dell.
- 🔧 **NOTE:** If you are installing a hard drive from a source other than Dell or Alienware, you need to install an operating system, drivers, and utilities on the new hard drive.

Removing the Hard Drive

1. Follow the instructions in [Before You Begin](#).
2. Remove the base cover (see [Removing the Base Cover](#)).
3. Remove the battery pack (see [Removing the Battery Pack](#)).
4. Follow the instructions from [step 4](#) to [step 6](#) in [Removing the Optical Drive](#).
5. Loosen the three captive screws that secure the hard-drive assembly to the computer base.
6. Using the pull-tab, gently lift the hard-drive assembly and then disconnect the hard-drive interposer.
7. Lift the hard-drive assembly off the computer base.

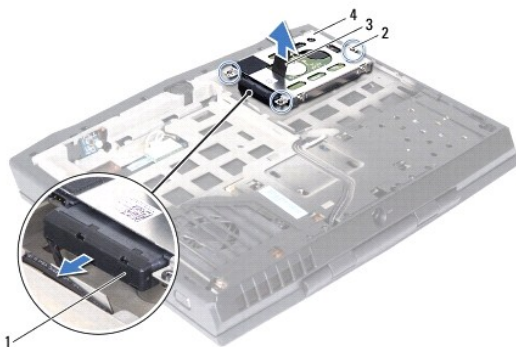

1	hard-drive interposer	2	captive screws (3)
---	-----------------------	---	--------------------

3	pull-tab	4	hard-drive assembly
---	----------	---	---------------------

8. Remove the four screws that secure the hard-drive bracket to the hard drive.
9. Lift the hard-drive bracket away from the hard drive.

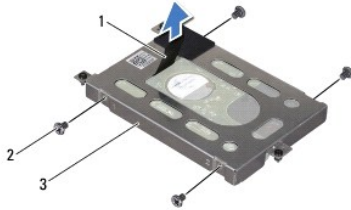

1	pull tab	2	screws (4)
3	hard-drive bracket		

CAUTION: When the hard drive is not in the computer, store it in protective antistatic packaging (see "Protecting Against Electrostatic Discharge" in the safety instructions that shipped with your computer).

Replacing the Hard Drive

1. Follow the instructions in [Before You Begin](#).
2. Remove the new drive from its packaging.
Save the original packaging for storing or shipping the hard drive.
3. Place the hard drive in the hard-drive bracket.
4. Replace the four screws that secure the hard-drive bracket to the hard drive.
5. Connect the interposer to the hard drive.
6. Place the hard-drive assembly in the computer base.
7. Tighten the three captive screws that secure the hard-drive assembly to the computer base.
8. Follow the instructions from [step 7](#) to [step 9](#) in [Replacing the Optical Drive](#).
9. Replace the battery pack (see [Replacing the Battery Pack](#)).
10. Replace the base cover (see [Replacing the Base Cover](#)).

CAUTION: Before turning on the computer, replace all screws and ensure that no stray screws remain inside the computer. Failure to do so may result in damage to the computer.

11. Install the operating system for your computer, as needed.
12. Install the drivers and utilities for your computer, as needed.

[Back to Contents Page](#)

Thermal Cooling Assembly

Alienware® M14x Service Manual

- [Removing the Thermal Cooling Assembly](#)
- [Replacing the Heat Sink](#)

- ⚠ **WARNING:** Before working inside your computer, read the safety information that shipped with your computer. For additional safety best practices information, see the Regulatory Compliance Homepage at dell.com/regulatory_compliance.
 - ⚠ **WARNING:** If you remove the heat sink from the computer when the heat sink is hot, do not touch the metal housing of the heat sink.
 - ⚠ **CAUTION:** Only a certified service technician should perform repairs on your computer. Damage due to servicing that is not authorized by Dell is not covered by your warranty.
 - ⚠ **CAUTION:** To avoid electrostatic discharge, ground yourself by using a wrist grounding strap or by periodically touching an unpainted metal surface (such as a connector on your computer).
 - ⚠ **CAUTION:** To help prevent damage to the system board, remove the main battery (see [Removing the Battery Pack](#)) before working inside the computer.
-

Removing the Thermal Cooling Assembly

1. Follow the instructions in [Before You Begin](#).
2. Follow the instructions from [step 2](#) to [step 18](#) in Removing the System Board.
3. In sequential order (indicated on the heat sink), loosen the seven captive screws that secure the heat sink to the system board.
4. Carefully lift heat sink away from the system board.

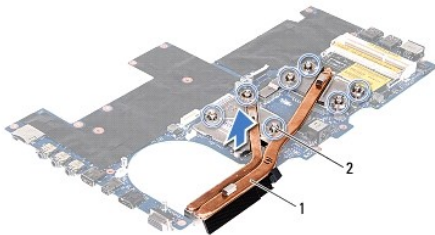

1	heat sink	2	captive screws (7)
---	-----------	---	--------------------

Replacing the Heat Sink

- 🔍 **NOTE:** The original thermal grease can be reused if the original processor and heat sink are reinstalled together. If either the processor or the heat sink is replaced, use the thermal pad provided in the kit to ensure that thermal conductivity is achieved.

1. Follow the instructions in [Before You Begin](#).
2. Clean the thermal grease from the bottom of the heat sink and reapply it.
3. Align the seven captive screws on the heat sink with the screw holes on the system board and tighten the screws in sequential order (indicated on the heat sink).
4. Follow the instructions from [step 4](#) to [step 20](#) in Replacing the System Board.

- ⚠ **CAUTION:** Before turning on the computer, replace all screws and ensure that no stray screws remain inside the computer. Failure to do so may result in damage to the computer.
-

[Back to Contents Page](#)

[Back to Contents Page](#)

Center-Control Cover

Alienware® M14x Service Manual

- [Removing the Center-Control Cover](#)
- [Replacing the Center-Control Cover](#)

- WARNING:** Before working inside your computer, read the safety information that shipped with your computer. For additional safety best practices information, see the Regulatory Compliance Homepage at dell.com/regulatory_compliance.
- CAUTION:** To avoid electrostatic discharge, ground yourself by using a wrist grounding strap or by periodically touching an unpainted metal surface (such as a connector on your computer).
- CAUTION:** Only a certified service technician should perform repairs on your computer. Damage due to servicing that is not authorized by Dell is not covered by your warranty.
- CAUTION:** To help prevent damage to the system board, remove the main battery (see [Removing the Battery Pack](#)) before working inside the computer.
-

Removing the Center-Control Cover

1. Follow the instructions in [Before You Begin](#).
2. Remove the base cover (see [Removing the Base Cover](#)).
3. Remove the battery pack (see [Removing the Battery Pack](#)).
4. Remove the three screws that secure the center-control cover to the computer base.

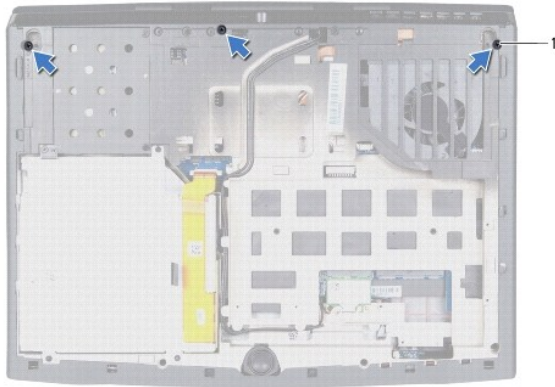

1	screws (3)
---	------------

5. Turn the computer over and open the display as far as possible.
6. Gently pry the center-control cover and then ease the tabs on the center-control cover out of the slots on the palm-rest assembly.
7. Lift the center-control cover off the computer base.



1	center-control cover
---	----------------------

Replacing the Center-Control Cover

1. Follow the instructions in [Before You Begin](#).
2. Align the tabs on the center-control cover with the slots on the palm rest assembly.
3. Gently press around the edges of the center control cover till it snaps in place.
4. Close the display and turn the computer over.
5. Replace the three screws that secure the center-control cover to the computer base.
6. Replace the battery pack (see [Replacing the Battery Pack](#)).
7. Replace the base cover (see [Replacing the Base Cover](#)).

CAUTION: Before turning on the computer, replace all screws and ensure that no stray screws remain inside the computer. Failure to do so may result in damage to the computer.

[Back to Contents Page](#)

[Back to Contents Page](#)

Mini-Card Board

Alienware® M14x Service Manual

- [Removing the Mini-Card Board](#)
- [Replacing the Mini-Card Board](#)

- WARNING:** Before working inside your computer, read the safety information that shipped with your computer. For additional safety best practices information, see the Regulatory Compliance Homepage at dell.com/regulatory_compliance.
- CAUTION:** To avoid electrostatic discharge, ground yourself by using a wrist grounding strap or by periodically touching an unpainted metal surface (such as a connector on your computer).
- CAUTION:** Only a certified service technician should perform repairs on your computer. Damage due to servicing that is not authorized by Dell is not covered by your warranty.
- CAUTION:** To help prevent damage to the system board, remove the main battery (see [Removing the Battery Pack](#)) before working inside the computer.
-

Removing the Mini-Card Board

1. Follow the instructions in [Before You Begin](#).
2. Remove the base cover (see [Removing the Base Cover](#)).
3. Remove the battery pack (see [Removing the Battery Pack](#)).
4. Remove the Mini-Card(s) (see [Removing the Mini-Card\(s\)](#)).
5. Remove the center-control cover (see [Removing the Center-Control Cover](#)).
6. Remove the keyboard (see [Removing the Keyboard](#)).
7. Remove the palm-rest assembly (see [Removing the Palm-Rest Assembly](#)).
8. Remove the three screws that secure the Mini-Card board to the computer base.
9. Lift the Mini-Card board to disconnect the connector on the mini-card board from the connector on the system board.

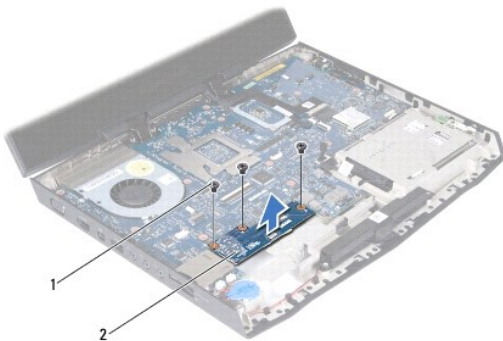

1	screws (3)	2	mini-card board
---	------------	---	-----------------

Replacing the Mini-Card Board

1. Follow the instructions in [Before You Begin](#).
2. Align the connector on the mini-card board with the connector on the system board and press gently.

3. Replace the three screws that secure the mini-card board to the computer base.
4. Replace the palm-rest assembly (see [Replacing the Palm-Rest Assembly](#)).
5. Replace the keyboard (see [Replacing the Keyboard](#)).
6. Replace the center-control cover (see [Replacing the Center-Control Cover](#)).
7. Replace the Mini-Card(s) (see [Replacing the Mini-Card\(s\)](#)).
8. Replace the battery pack (see [Replacing the Battery Pack](#)).
9. Replace the base cover (see [Replacing the Base Cover](#)).

 **CAUTION:** Before turning on the computer, replace all screws and ensure that no stray screws remain inside the computer. Failure to do so may result in damage to the computer.

[Back to Contents Page](#)

[Back to Contents Page](#)

Keyboard

Alienware® M14x Service Manual

- [Removing the Keyboard](#)
- [Replacing the Keyboard](#)

- WARNING:** Before working inside your computer, read the safety information that shipped with your computer. For additional safety best practices information, see the Regulatory Compliance Homepage at dell.com/regulatory_compliance.
- CAUTION:** To avoid electrostatic discharge, ground yourself by using a wrist grounding strap or by periodically touching an unpainted metal surface (such as a connector on your computer).
- CAUTION:** Only a certified service technician should perform repairs on your computer. Damage due to servicing that is not authorized by Dell is not covered by your warranty.
- CAUTION:** To help prevent damage to the system board, remove the main battery (see [Removing the Battery Pack](#)) before working inside the computer.
-

Removing the Keyboard

1. Follow the instructions in [Before You Begin](#).
2. Remove the base cover (see [Removing the Base Cover](#)).
3. Remove the battery pack (see [Removing the Battery Pack](#)).
4. Remove the center-control cover (see [Removing the Center-Control Cover](#)).
5. Remove the three screws that secure the keyboard to the computer base.

CAUTION: The keycaps on the keyboard are fragile, easily dislodged, and time-consuming to replace. Be careful when removing and handling the keyboard.

CAUTION: Be extremely careful when removing and handling the keyboard. Failure to do so could result in scratching the display panel.

6. Pry the keyboard up and without pulling hard carefully lift the keyboard towards the display.

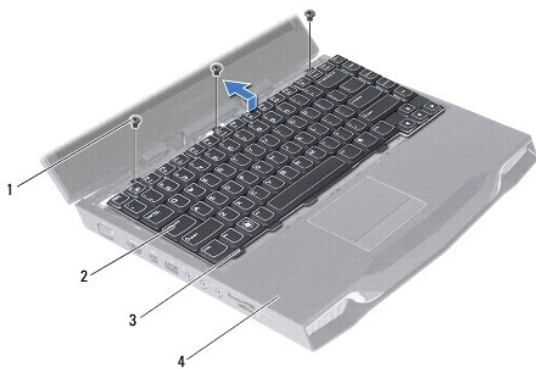

1	screws (3)	2	keyboard
3	tabs (4)	4	palm-rest assembly

7. Lift the release latches on the connectors on the system board and disconnect the keyboard cable and backlit keyboard cable.
8. Lift the keyboard off the palm-rest assembly.



1	keyboard cable	2	backlit keyboard cable
---	----------------	---	------------------------

Replacing the Keyboard

1. Follow the instructions in [Before You Begin](#).
2. Slide the keyboard cable and backlit keyboard cable into the connectors on the system board and press down on the connector latches to secure the cables.
3. Slide the tabs on the keyboard into the slots on the palm-rest assembly and lower the keyboard into place.
4. Gently press around the edges of the keyboard to secure the keyboard under the tab on the palm-rest assembly.
5. Replace the three screws that secure the keyboard to the computer base.
6. Replace the center-control cover (see [Replacing the Center-Control Cover](#)).
7. Replace the battery pack (see [Replacing the Battery Pack](#)).
8. Replace the base cover (see [Replacing the Base Cover](#)).

CAUTION: Before turning on the computer, replace all screws and ensure that no stray screws remain inside the computer. Failure to do so may result in damage to the computer.

[Back to Contents Page](#)

[Back to Contents Page](#)

Status-Light Board

Alienware® M14x Service Manual

- [Removing the Status-Light Board](#)
- [Replacing the Status-Light Board](#)

- ⚠ WARNING:** Before working inside your computer, read the safety information that shipped with your computer. For additional safety best practices information, see the Regulatory Compliance Homepage at www.dell.com/regulatory_compliance.
- ⚠ CAUTION:** To avoid electrostatic discharge, ground yourself by using a wrist grounding strap or by periodically touching an unpainted metal surface (such as a connector on your computer).
- ⚠ CAUTION:** Only a certified service technician should perform repairs on your computer. Damage due to servicing that is not authorized by Dell™ is not covered by your warranty.
- ⚠ CAUTION:** To help prevent damage to the system board, remove the main battery (see [Removing the Battery Pack](#)) before working inside the computer.
-

Removing the Status-Light Board

1. Follow the instructions in [Before You Begin](#).
2. Remove the base cover (see [Removing the Base Cover](#)).
3. Remove the battery pack (see [Removing the Battery Pack](#)).
4. Remove the center-control cover (see [Removing the Center-Control Cover](#)).
5. Remove the keyboard (see [Removing the Keyboard](#)).
6. Remove the palm-rest assembly (see [Removing the Palm-Rest Assembly](#)).
7. Turn the palm-rest assembly over.
8. Note the routing of status-light board cable and remove the cable from the routing guides.

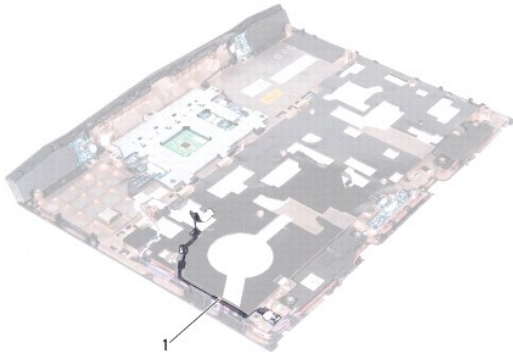

1	status-light board cable
---	--------------------------

9. Remove the screw that secures the status-light board to the palm-rest assembly.
10. Lift the status-light board along with its cable away from the palm-rest assembly.

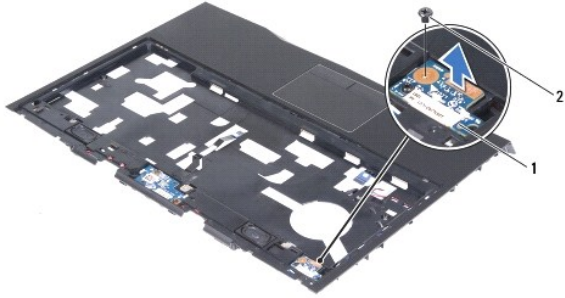

1	status-light board	2	screw
---	--------------------	---	-------

Replacing the Status-Light Board

1. Follow the instructions in [Before You Begin](#).
2. Align the slot on the status-light board with the alignment post on the palm rest assembly.
3. Replace the screw that secures the status-light board to the palm-rest assembly.
4. Route the status-light board cable through the routing guides on the palm-rest assembly.
5. Replace the palm-rest assembly (see [Replacing the Palm-Rest Assembly](#)).
6. Replace the keyboard (see [Replacing the Keyboard](#)).
7. Replace the center-control cover (see [Replacing the Center-Control Cover](#)).
8. Replace the battery pack (see [Replacing the Battery Pack](#)).
9. Replace the base cover (see [Replacing the Base Cover](#)).

CAUTION: Before turning on the computer, replace all screws and ensure that no stray screws remain inside the computer. Failure to do so may result in damage to the computer.

[Back to Contents Page](#)

[Back to Contents Page](#)

Memory Module(s)

Alienware® M14x Service Manual

- [Removing the Memory Module\(s\)](#)
- [Replacing the Memory Module\(s\)](#)

WARNING: Before working inside your computer, read the safety information that shipped with your computer. For additional safety best practices information, see the Regulatory Compliance Homepage at dell.com/regulatory_compliance.

CAUTION: To avoid electrostatic discharge, ground yourself by using a wrist grounding strap or by periodically touching an unpainted metal surface (such as a connector on your computer).

CAUTION: Only a certified service technician should perform repairs on your computer. Damage due to servicing that is not authorized by Dell is not covered by your warranty.

CAUTION: To help prevent damage to the system board, remove the main battery (see [Removing the Battery Pack](#)) before working inside the computer.

You can increase your computer memory by installing memory modules on the system board. See "Specifications" in your *Mobile Manual* for information on the type of memory supported by your computer.

NOTE: Memory modules purchased from Dell or Alienware are covered under your computer warranty.

Your computer has two user-accessible SODIMM connectors.

Removing the Memory Module(s)

1. Follow the instructions in [Before You Begin](#).
2. Remove the base cover (see [Removing the Base Cover](#)).
3. Remove the battery pack (see [Removing the Battery Pack](#)).
4. Loosen the two captive screws that secure the memory-module cover to the computer base.
5. Slide the tabs on the memory-module cover out of the slots on the computer base.



1	captive screws (2)	2	memory-module cover
---	--------------------	---	---------------------

CAUTION: To prevent damage to the memory-module connector, do not use tools to spread the memory module securing clips.

6. Use your fingertips to carefully spread apart the securing clips on each end of the memory-module connector until the memory module pops up.

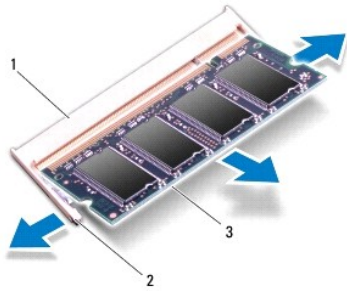

1	memory-module connector	2	securing clips (2)
3	memory module		

7. Remove the memory module from the memory-module connector.

Replacing the Memory Module(s)

1. Follow the instructions in [Before You Begin](#).

NOTE: If you need to install memory modules in two connectors, install a memory module in the lower connector before you install a memory module in the upper connector.

2. Align the notch in the memory module with the tab in the memory-module connector.
3. Slide the memory module firmly into the connector at a 45-degree angle, and press the memory module down until it clicks into place. If you do not hear the click, remove the memory module and reinstall it.

NOTE: If the memory module is not installed properly, the computer may not boot.

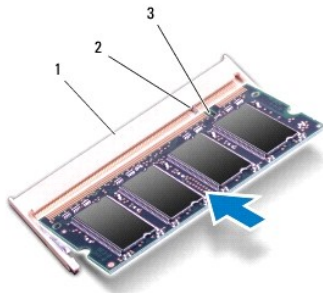

1	memory-module connector	2	tab
3	notch		

4. Slide the tabs on the memory-module cover into the slots on the computer base and lower the memory-module cover into place.
5. Tighten the two captive screws that secure the memory-module cover to the computer base.
6. Replace the battery pack (see [Replacing the Battery Pack](#)).
7. Replace the base cover (see [Replacing the Base Cover](#)).

CAUTION: Before turning on the computer, replace all screws and ensure that no stray screws remain inside the computer. Failure to do so may result in damage to the computer.

8. Turn on the computer.

As the computer boots, it detects the additional memory and automatically updates the system configuration information.

To confirm the amount of memory installed in the computer:

Click **Start**  → **Control Panel** → **System and Security** → **System**.

[Back to Contents Page](#)

[Back to Contents Page](#)

Wireless Mini-Card(s)

Alienware® M14x Service Manual

- [Removing the Mini-Card\(s\)](#)
- [Replacing the Mini-Card\(s\)](#)

- WARNING:** Before working inside your computer, read the safety information that shipped with your computer. For additional safety best practices information, see the Regulatory Compliance Homepage at dell.com/regulatory_compliance.
- CAUTION:** To avoid electrostatic discharge, ground yourself by using a wrist grounding strap or by periodically touching an unpainted metal surface (such as a connector on your computer).
- CAUTION:** Only a certified service technician should perform repairs on your computer. Damage due to servicing that is not authorized by Dell™ is not covered by your warranty.
- CAUTION:** To help prevent damage to the system board, remove the main battery (see [Removing the Battery Pack](#)) before working inside the computer.
- NOTE:** Dell or Alienware does not guarantee compatibility or provide support for Mini-Cards from sources other than Dell or Alienware.

If you ordered a wireless Mini-Card with your computer, the card is already installed.

Your computer supports two Mini-Card slots:

- 1 One full Mini-Card slot — for WWAN
- 1 One half Mini-Card slot — for WLAN

NOTE: Depending on the configuration of the computer when it was sold, the Mini-Card slot may or may not have a Mini-Card installed.

Removing the Mini-Card(s)

1. Follow the instructions in [Before You Begin](#).
2. Remove the base cover (see [Removing the Base Cover](#)).
3. Remove the battery pack (see [Removing the Battery Pack](#)).
4. Disconnect the antenna cables from the Mini-Card.

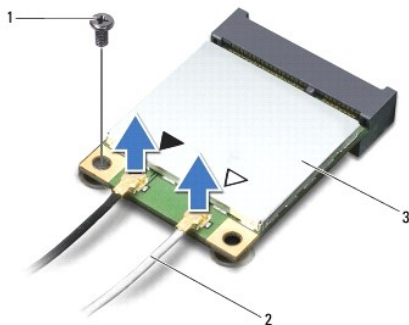

1	screw	2	antenna cables (2)
3	Mini-Card		

5. Remove the screw that secures the Mini-Card to the system board.
6. Lift the Mini-Card out of the connector on the system board.

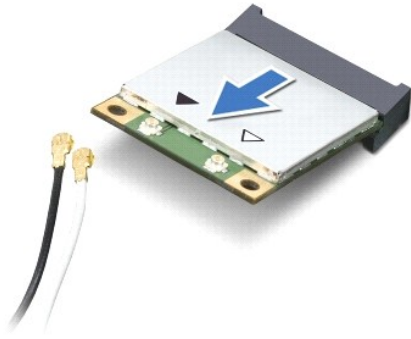

CAUTION: When the Mini-Card is not in the computer, store it in protective antistatic packaging. For more information, see "Protecting Against Electrostatic Discharge" in the safety information that shipped with your computer.

Replacing the Mini-Card(s)

1. Follow the instructions in [Before You Begin](#).
2. Remove the new Mini-Card from its packaging.

CAUTION: Use firm and even pressure to slide the card into place. If you use excessive force, you may damage the connector.

CAUTION: The connectors are keyed to ensure correct insertion. If you feel resistance, check the connectors on the card and on the system board, and realign the card.

3. Insert the Mini-Card connector at a 45-degree angle into the connector on the system board.
4. Press the other end of the Mini-Card down into the slot on the system board and replace the screw that secures the Mini-Card to the system board.
5. Connect the appropriate antenna cables to the Mini-Card you are installing. The following table provides the antenna cable color scheme for each Mini-Card supported by your computer.

Connectors on the Mini-Card	Antenna Cable Color Scheme
WWAN (2 antenna cables)	
Main WWAN (white triangle)	white with gray stripe
Auxiliary WWAN (black triangle)	black with gray stripe
WLAN (2 antenna cables)	
Main WLAN (white triangle)	white
Auxiliary WLAN (black triangle)	black

6. Replace the battery pack (see [Replacing the Battery Pack](#)).
7. Replace the base cover (see [Replacing the Base Cover](#)).

CAUTION: Before turning on the computer, replace all screws and ensure that no stray screws remain inside the computer. Failure to do so may result in damage to the computer.

8. Install the drivers and utilities for your computer, as required.

NOTE: If you are installing a Mini-card from a source other than Dell or Alienware, you must install the appropriate drivers and utilities.

[Back to Contents Page](#)

Optical Drive

Alienware® M14x Service Manual

- [Removing the Optical Drive](#)
- [Replacing the Optical Drive](#)

- WARNING:** Before working inside your computer, read the safety information that shipped with your computer. For additional safety best practices information, see the Regulatory Compliance Homepage at dell.com/regulatory_compliance.
- CAUTION:** Only a certified service technician should perform repairs on your computer. Damage due to servicing that is not authorized by Dell is not covered by your warranty.
- CAUTION:** To avoid electrostatic discharge, ground yourself by using a wrist grounding strap or by periodically touching an unpainted metal surface (such as a connector on your computer).
- CAUTION:** To help prevent damage to the system board, remove the main battery (see [Removing the Battery Pack](#)) before working inside the computer.
-

Removing the Optical Drive

1. Follow the instructions in [Before You Begin](#).
2. Remove the base cover (see [Removing the Base Cover](#)).
3. Remove the battery pack (see [Removing the Battery Pack](#)).
4. Lift the connector latch and pull the pull-tab to disconnect the optical-drive cable from the connector on the system board.
5. Loosen the four captive screws that secure the optical drive to the computer base.
6. Using the pull-tab, lift the optical drive off the computer base.

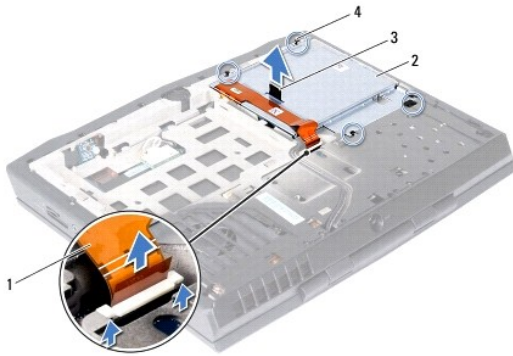

1	optical-drive cable	2	optical drive
3	pull tab	4	captive screws (4)

7. Remove the two screws that secure the optical-drive cable connector to the optical drive.
8. Disconnect the optical-drive cable from the connector on the optical drive.
9. Gently peel the optical-drive cable from the optical-drive bracket.

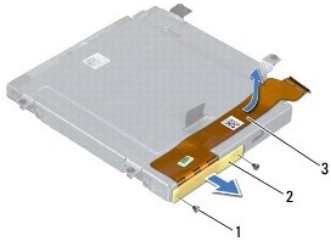

1	screws (2)	2	optical-drive cable connector
3	optical-drive cable		

10. Remove the four screws that secure the optical-drive bracket to the optical drive.

11. Using the pull-tab, lift the optical-drive bracket off the optical drive.

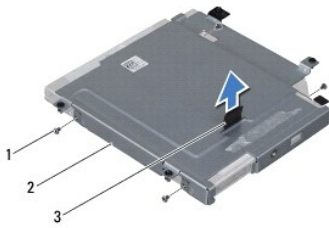

1	screws (4)	2	optical-drive bracket
3	pull tab		

Replacing the Optical Drive

1. Follow the instructions in [Before You Begin](#).
2. Align the screw holes on the optical-drive bracket with the screw holes on the optical drive.
3. Replace the four screws that secure the optical-drive bracket to the optical drive.
4. Adhere the optical-drive cable to the optical-drive bracket.
5. Connect the optical-drive cable connector to the connector on the optical drive.
6. Replace the two screws that secure the the optical-drive cable to the optical drive.
7. Align the captive screws on the optical drive with the screw holes on the computer base.
8. Tighten the four captive screws that secure the optical drive to the computer base.
9. Slide the optical-drive cable into the connector on the system board, and press down on the connector latch to secure the cable.
10. Replace the battery (see [Replacing the Battery Pack](#)).
11. Replace the base cover (see [Removing the Base Cover](#)).

 **CAUTION:** Before turning on the computer, replace all screws and ensure that no stray screws remain inside the computer. Failure to do so may result in damage to the computer.

[Back to Contents Page](#)

[Back to Contents Page](#)

Palm-Rest Assembly

Alienware® M14x Service Manual

- [Removing the Palm-Rest Assembly](#)
- [Replacing the Palm-Rest Assembly](#)

- WARNING:** Before working inside your computer, read the safety information that shipped with your computer. For additional safety best practices information, see the Regulatory Compliance Homepage at dell.com/regulatory_compliance.
- CAUTION:** To avoid electrostatic discharge, ground yourself by using a wrist grounding strap or by periodically touching an unpainted metal surface (such as a connector on your computer).
- CAUTION:** Only a certified service technician should perform repairs on your computer. Damage due to servicing that is not authorized by Dell is not covered by your warranty.
- CAUTION:** To help prevent damage to the system board, remove the main battery (see [Removing the Battery Pack](#)) before working inside the computer.
-

Removing the Palm-Rest Assembly

1. Follow the instructions in [Before You Begin](#).
2. Remove the base cover (see [Removing the Base Cover](#)).
3. Remove the battery pack (see [Removing the Battery Pack](#)).
4. Remove the nine screws that secure the palm-rest assembly to the computer base.

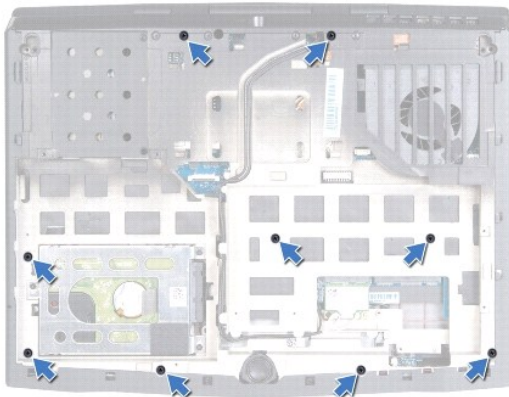

5. Turn the computer over and open the display as far as possible.
 6. Remove the center-control cover (see [Removing the Center-Control Cover](#)).
 7. Remove the keyboard (see [Removing the Keyboard](#)).
- CAUTION:** Pull the pull-tabs on top of the connectors to avoid damage to the connectors.
8. Lift the connector latches and pull the pull-tabs to disconnect the touch-pad cable and power-button board cable from the connectors on the system board.
 9. Disconnect the speakers cable and status-light board cable from the connectors on the system board.
 10. Remove the two screws that secure the palm-rest assembly to the computer base.
 11. Carefully pry out the palm-rest assembly along the rear edge and then ease the palm-rest assembly from the computer base.
- CAUTION:** Carefully separate the palm rest assembly from the computer base to avoid damage to the palm rest assembly.

12. Lift the palm-rest assembly off the computer base.

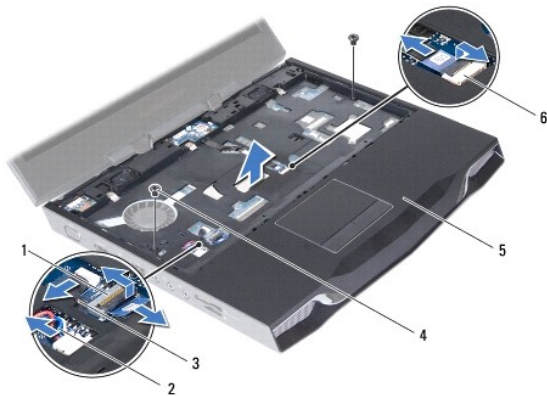

1	touch-pad cable connector	2	speakers cable
3	status-light board cable	4	screws (2)
5	palm-rest assembly	6	power-button board cable connector

Replacing the Palm-Rest Assembly

1. Follow the instructions in [Before You Begin](#).
2. Align the palm-rest assembly on the computer base and gently snap the palm-rest assembly into place.
3. Replace the two screws that secure the palm-rest assembly to the computer base.
4. Connect the speaker cable and status-light board cable to the connectors on the system board.
5. Slide the touch-pad cable and power-button board cable into their connectors on the system board, and press down on their connector latches to secure the cables.
6. Replace the keyboard (see [Replacing the Keyboard](#)).
7. Replace the center-control cover (see [Replacing the Center-Control Cover](#)).
8. Close the display and turn the computer over.
9. Replace the nine screws that secure the palm-rest assembly to the computer base.
10. Replace the battery pack (see [Replacing the Battery Pack](#)).
11. Replace the base cover (see [Replacing the Base Cover](#)).

CAUTION: Before turning on the computer, replace all screws and ensure that no stray screws remain inside the computer. Failure to do so may result in damage to the computer.

[Back to Contents Page](#)

Processor Module

Alienware® M14x Service Manual

- [Removing the Processor Module](#)
- [Replacing the Processor Module](#)

- WARNING:** Before working inside your computer, read the safety information that shipped with your computer. For additional safety best practices information, see the Regulatory Compliance Homepage at dell.com/regulatory_compliance.
- CAUTION:** Only a certified service technician should perform repairs on your computer. Damage due to servicing that is not authorized by Dell is not covered by your warranty.
- CAUTION:** To avoid electrostatic discharge, ground yourself by using a wrist grounding strap or by periodically touching an unpainted metal surface (such as a connector on your computer).
- CAUTION:** To help prevent damage to the system board, remove the main battery (see [Removing the Battery Pack](#)) before working inside the computer.
-

Removing the Processor Module

1. Follow the instructions in [Before You Begin](#).
2. Follow the instructions from [step 2](#) to [step 19](#) in Removing the System Board.

CAUTION: To prevent intermittent contact between the ZIF-socket cam screw and the processor when removing or replacing the processor, press to apply slight pressure to the centre of the processor while turning the cam screw.

CAUTION: To avoid damage to the processor, hold the screwdriver so that it is perpendicular to the processor when turning the cam screw.

3. To loosen the ZIF socket, use a small, flat-blade screwdriver and rotate the ZIF-socket cam screw counterclockwise until it comes to the cam stop.

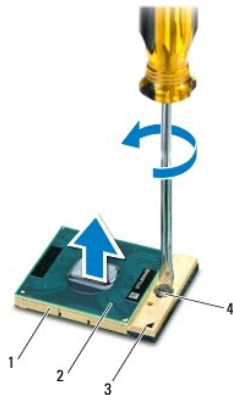

1	ZIF socket	2	processor module
3	pin-1 corner	4	ZIF-socket cam screw

CAUTION: To ensure maximum cooling for the processor module, do not touch the heat transfer areas on the processor thermal-cooling assembly. The oils in your skin can reduce the heat transfer capability of the thermal pads.

CAUTION: When removing the processor module, pull the module straight up. Be careful not to bend the pins on the processor module.

4. Lift the processor module off the ZIF socket.
-

Replacing the Processor Module

 **NOTE:** If a new processor module is installed, you will receive a new thermal cooling assembly, which will include an affixed thermal pad, or you will receive a new thermal pad along with documentation to illustrate proper installation.

1. Follow the instructions in [Before You Begin](#).
2. Align the pin-1 corner of the processor module with the pin-1 corner of the ZIF socket.

 **NOTE:** The pin-1 corner of the processor module has a triangle that aligns with the triangle on the pin-1 corner of the ZIF socket.

3. Place the processor module lightly in the ZIF socket and ensure that the processor module is positioned correctly.

 **CAUTION:** To avoid damage to the processor module, hold the screwdriver perpendicular to the processor module when turning the cam screw.

4. Tighten the ZIF socket by turning the cam screw clockwise to secure the processor module to the system board.
5. Follow the instructions from [step 3](#) to [step 20](#) in Replacing the System Board.

 **CAUTION:** Before turning on the computer, replace all screws and ensure that no stray screws remain inside the computer. Failure to do so may result in damage to the computer.

[Back to Contents Page](#)

[Back to Contents Page](#)

Power-Button Board

Alienware® M14x Service Manual

- [Removing the Power-Button Board](#)
- [Replacing the Power-Button Board](#)

- WARNING:** Before working inside your computer, read the safety information that shipped with your computer. For additional safety best practices information, see the Regulatory Compliance Homepage at dell.com/regulatory_compliance.
- CAUTION:** To avoid electrostatic discharge, ground yourself by using a wrist grounding strap or by periodically touching an unpainted metal surface (such as a connector on your computer).
- CAUTION:** Only a certified service technician should perform repairs on your computer. Damage due to servicing that is not authorized by Dell is not covered by your warranty.
- CAUTION:** To help prevent damage to the system board, remove the main battery (see [Removing the Battery Pack](#)) before working inside the computer.
-

Removing the Power-Button Board

1. Follow the instructions in [Before You Begin](#).
2. Remove the base cover (see [Removing the Base Cover](#)).
3. Remove the battery pack (see [Removing the Battery Pack](#)).
4. Remove the center-control cover (see [Removing the Center-Control Cover](#)).
5. Remove the keyboard (see [Removing the Keyboard](#)).
6. Remove the palm-rest assembly (see [Removing the Palm-Rest Assembly](#)).
7. Carefully peel the power-button board cable from the palm-rest assembly.
8. Remove the two screws that secure the power-button board to the palm-rest assembly.
9. Lift the power-button board along with its cable away from the palm-rest assembly.

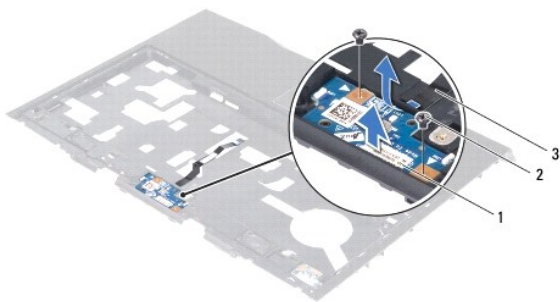

1	power-button board	2	screws (2)
3	power-button board cable		

Replacing the Power-Button Board

1. Follow the instructions in [Before You Begin](#).
2. Slide the power-button board cable through the slot on the palm-rest assembly.
3. Use the alignment posts on the palm-rest assembly to place the power-button board in place.

4. Replace the two screws that secure the power-button board to the palm- rest assembly.
5. Adhere the power-button board cable to the palm-rest assembly.
6. Replace the palm-rest assembly (see [Replacing the Palm-Rest Assembly](#)).
7. Replace the keyboard (see [Replacing the Keyboard](#)).
8. Replace the center-control cover (see [Replacing the Center-Control Cover](#)).
9. Replace the battery pack (see [Replacing the Battery Pack](#)).
10. Replace the base cover (see [Replacing the Base Cover](#)).

 **CAUTION:** Before turning on the computer, replace all screws and ensure that no stray screws remain inside the computer. Failure to do so may result in damage to the computer.

[Back to Contents Page](#)

[Back to Contents Page](#)

Speakers

Alienware® M14x Service Manual

- [Removing the Speakers](#)
- [Replacing the Speakers](#)

- WARNING:** Before working inside your computer, read the safety information that shipped with your computer. For additional safety best practices information, see the Regulatory Compliance Homepage at dell.com/regulatory_compliance.
- CAUTION:** To avoid electrostatic discharge, ground yourself by using a wrist grounding strap or by periodically touching an unpainted metal surface (such as a connector on your computer).
- CAUTION:** Only a certified service technician should perform repairs on your computer. Damage due to servicing that is not authorized by Dell is not covered by your warranty.
- CAUTION:** To help prevent damage to the system board, remove the main battery (see [Removing the Battery Pack](#)) before working inside the computer.
-

Removing the Speakers

1. Follow the instructions in [Before You Begin](#).
2. Remove the base cover (see [Removing the Base Cover](#)).
3. Remove the battery pack (see [Removing the Battery Pack](#)).
4. Remove the center-control cover (see [Removing the Center-Control Cover](#)).
5. Remove the keyboard (see [Removing the Keyboard](#)).
6. Remove the palm-rest assembly (see [Removing the Palm-Rest Assembly](#)).
7. Turn the palm-rest assembly over.
8. Note the routing of speakers cable and remove the cable from the routing guides.
9. Remove the four screws that secure the speakers to the palm-rest assembly.
10. Lift the speakers along with its cable away from the palm-rest assembly.

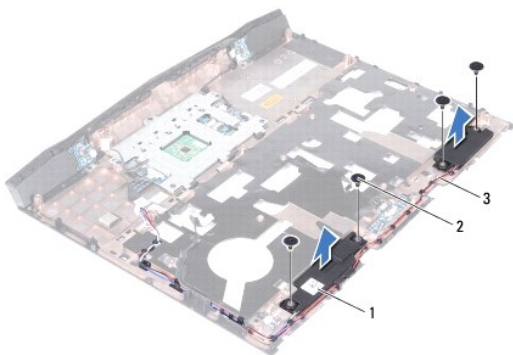

1	speakers (2)	2	screws (4)
3	speakers cable		

Replacing the Speakers

1. Follow the instructions in [Before You Begin](#).
2. Align the screw holes on the speakers with the screw holes on the palm-rest assembly and route the speakers cable through the routing guides.
3. Replace the four screws that secure the speakers to the palm-rest assembly.
4. Replace the palm-rest assembly (see [Replacing the Palm-Rest Assembly](#)).
5. Replace the keyboard (see [Replacing the Keyboard](#)).
6. Replace the center-control cover (see [Replacing the Center-Control Cover](#)).
7. Replace the battery pack (see [Replacing the Battery Pack](#)).
8. Replace the base cover (see [Replacing the Base Cover](#)).

 **CAUTION:** Before turning on the computer, replace all screws and ensure that no stray screws remain inside the computer. Failure to do so may result in damage to the computer.

[Back to Contents Page](#)

[Back to Contents Page](#)

Subwoofer

Alienware® M14x Service Manual

- [Removing the Subwoofer](#)
- [Replacing the Subwoofer](#)

- ⚠ WARNING:** Before working inside your computer, read the safety information that shipped with your computer. For additional safety best practices information, see the Regulatory Compliance Homepage at dell.com/regulatory_compliance.
- ⚠ CAUTION:** To avoid electrostatic discharge, ground yourself by using a wrist grounding strap or by periodically touching an unpainted metal surface (such as a connector on your computer).
- ⚠ CAUTION:** Only a certified service technician should perform repairs on your computer. Damage due to servicing that is not authorized by Dell is not covered by your warranty.
- ⚠ CAUTION:** To help prevent damage to the system board, remove the main battery (see [Removing the Battery Pack](#)) before working inside the computer.
-

Removing the Subwoofer

1. Follow the instructions in [Before You Begin](#).
2. Remove the base cover (see [Removing the Base Cover](#)).
3. Remove the battery pack (see [Removing the Battery Pack](#)).
4. Remove the center-control cover (see [Removing the Center-Control Cover](#)).
5. Remove the keyboard (see [Removing the Keyboard](#)).
6. Remove the palm-rest assembly (see [Removing the Palm-Rest Assembly](#)).
7. Disconnect the subwoofer cable from the connector on the system board.
8. Note the routing of subwoofer cable and remove the cable from the routing guides.
9. Lift the subwoofer along with the cable off the computer base.

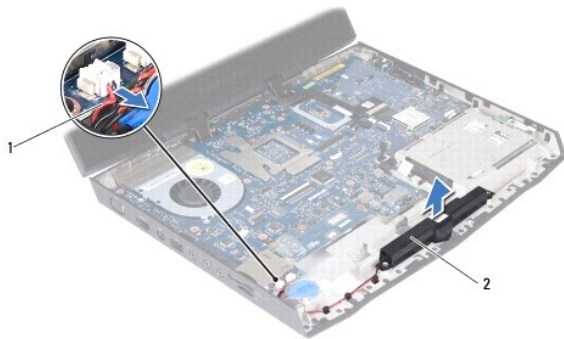

1	subwoofer cable	2	subwoofer
---	-----------------	---	-----------

Replacing the Subwoofer

1. Follow the instructions in [Before You Begin](#).
2. Align the slots on the subwoofer with the alignment posts on the computer base.

3. Route the subwoofer cable through the routing guides.
4. Connect the subwoofer cable to the connector on the system board.
5. Replace the palm-rest assembly (see [Replacing the Palm-Rest Assembly](#)).
6. Replace the keyboard (see [Replacing the Keyboard](#)).
7. Replace the center-control cover (see [Replacing the Center-Control Cover](#)).
8. Replace the battery pack (see [Replacing the Battery Pack](#)).
9. Replace the base cover (see [Replacing the Base Cover](#)).

 **CAUTION:** Before turning on the computer, replace all screws and ensure that no stray screws remain inside the computer. Failure to do so may result in damage to the computer.





[Back to Contents Page](#)

[Back to Contents Page](#)

System Board

Alienware® M14x Service Manual

- [Removing the System Board](#)
- [Replacing the System Board](#)
- [Entering the Service Tag in the BIOS](#)

-  **WARNING:** Before working inside your computer, read the safety information that shipped with your computer. For additional safety best practices information, see the Regulatory Compliance Homepage at dell.com/regulatory_compliance.
-  **CAUTION:** To avoid electrostatic discharge, ground yourself by using a wrist grounding strap or by periodically touching an unpainted metal surface (such as a connector on your computer).
-  **CAUTION:** Only a certified service technician should perform repairs on your computer. Damage due to servicing that is not authorized by Dell is not covered by your warranty.
-  **CAUTION:** To help prevent damage to the system board, remove the main battery (see [Removing the Battery Pack](#)) before working inside the computer.
-  **CAUTION:** Handle components by their edges, and avoid touching pins and contacts.

The system board's BIOS chip contains the Service Tag, which is also visible on a barcode label at the bottom of the computer.

Removing the System Board

1. Follow the instructions in [Before You Begin](#).
2. Remove any installed card or blank from the 9-in-1 Media Card reader.
3. Remove the base cover (see [Removing the Base Cover](#)).
4. Remove the battery pack (see [Removing the Battery Pack](#)).
5. Remove the Mini-Card(s) (see [Removing the Mini-Card\(s\)](#)).
6. Follow the instructions from [step 4](#) to [step 6](#) in [Removing the Optical Drive](#).
7. Follow the instructions from [step 5](#) to [step 7](#) in [Removing the Hard Drive](#).
8. Remove the memory module(s) (see [Removing the Memory Module\(s\)](#)).
9. Remove the center-control cover (see [Removing the Center-Control Cover](#)).
10. Remove the keyboard (see [Removing the Keyboard](#)).
11. Remove the palm-rest assembly (see [Removing the Palm-Rest Assembly](#)).
12. Remove the Mini-Card board (see [Removing the Mini-Card Board](#)).
13. Using the pull-tab, disconnect the display cable from the connector on the system board.
14. Disconnect the touch-screen board cable, Bluetooth card cable, hard-drive cable, coin-cell battery cable, and subwoofer cable from the connectors on the system board.
15. Remove the five screws that secure the system board to the computer base.
16. Lift and ease the connectors on the system board out of the slots on the computer base.

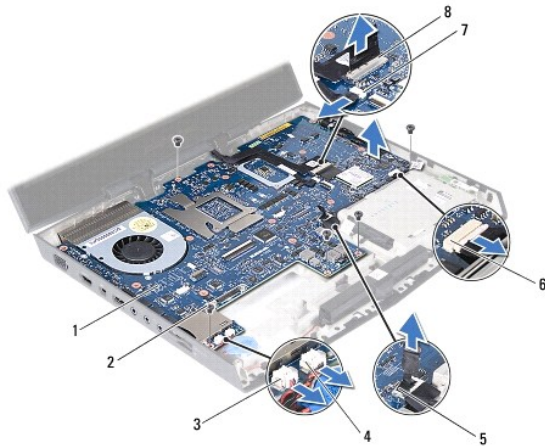

1	system board	2	screws (5)
3	subwoofer cable connector	4	coin-cell battery cable connector
5	hard-drive cable connector	6	Bluetooth card cable connector
7	touch-screen board cable connector	8	display-cable connector

17. Turn the system board over.
18. Remove the thermal fan (see [Removing the Thermal Fan](#)).
19. Remove the thermal cooling assembly (see [Removing the Thermal Cooling Assembly](#)).
20. Remove the processor module (see [Removing the Processor Module](#)).

Replacing the System Board

1. Follow the instructions in [Before You Begin](#).
2. Replace the processor module (see [Replacing the Processor Module](#)).
3. Replace the thermal cooling assembly (see [Replacing the Heat Sink](#)).
4. Replace the thermal fan (see [Replacing the Thermal Fan](#)).
5. Turn the system board over.
6. Align the connectors on the system board with the slots on the computer base and place it on the computer base.
7. Replace the five screws that secure the system board to the computer base.
8. Connect the touch-screen board cable, Bluetooth card cable, hard-drive cable, coin-cell battery cable, and subwoofer cable to the respective system board connectors.
9. Connect the display cable to the connector on the system board.
10. Replace the Mini-Card board (see [Replacing the Mini-Card Board](#)).
11. Replace the palm rest assembly (see [Replacing the Palm-Rest Assembly](#)).
12. Replace the keyboard (see [Replacing the Keyboard](#)).
13. Replace the center-control cover (see [Replacing the Center-Control Cover](#)).

14. Replace the memory module(s) (see [Replacing the Memory Module\(s\)](#)).
15. Follow the instructions from [step 5](#) to [step 7](#) in [Replacing the Hard Drive](#).
16. Follow the instructions from [step 7](#) to [step 9](#) in [Replacing the Optical Drive](#).
17. Replace the Mini-Card(s) (see [Replacing the Mini-Card\(s\)](#)).
18. Replace the battery pack (see [Replacing the Battery Pack](#)).
19. Replace the base cover (see [Replacing the Base Cover](#)).
20. Replace any cards or blank that you removed from the 9-in-1 Media Card reader.

 **CAUTION:** Before turning on the computer, replace all screws and ensure that no stray screws remain inside the computer. Failure to do so may result in damage to the computer.

21. Turn on the computer.

 **NOTE:** After you have replaced the system board, enter the computer Service Tag into the BIOS of the replacement system board.

22. Enter the service tag (see [Entering the Service Tag in the BIOS](#)).
-

Entering the Service Tag in the BIOS

1. Ensure that the AC adapter is plugged in and that the main battery is installed properly.
 2. Turn on the computer.
 3. Press <F2> during POST to enter the system setup program.
 4. Navigate to the security tab and enter the service tag in the **Set Service Tag** field.
-

[Back to Contents Page](#)

[Back to Contents Page](#)

Alienware® M14x Service Manual



NOTE: A NOTE indicates important information that helps you make better use of your computer.



CAUTION: A CAUTION indicates potential damage to hardware or loss of data if instructions are not followed.



WARNING: A WARNING indicates a potential for property damage, personal injury, or death.

Information in this document is subject to change without notice.
© 2011 Dell Inc. All rights reserved.

Reproduction of these materials in any manner whatsoever without the written permission of Dell Inc. is strictly forbidden.

Trademarks used in this text: Dell™ and the DELL logo are trademarks of Dell Inc.; Alienware® is a trademark or registered trademark of Alienware Corporation; Microsoft®, Windows®, and the Windows start button logo  are either trademarks or registered trademarks of Microsoft Corporation in the United States and/or other countries; Bluetooth® is a registered trademark owned by Bluetooth SIG, Inc. and is used by Dell under license.

Other trademarks and trade names may be used in this document to refer to either the entities claiming the marks and names or their products. Dell Inc. disclaims any proprietary interest in trademarks and trade names other than its own.

2011 - 02 Rev. A00

[Back to Contents Page](#)