

Aspire 5534 Series

Quick Guide

Copyright © 2009. Acer Incorporated.
All Rights Reserved.

Aspire 5534 Series Quick Guide
Original Issue: 08/2009

Aspire 5534 Series Notebook PC

Model number: _____

Serial number: _____

Date of purchase: _____

Place of purchase: _____

First things first

We would like to thank you for making an acer notebook your choice for meeting your mobile computing needs.

Your guides

To help you use your Acer notebook, we have designed a set of guides:

First off, the **Just for Starters...** poster helps you get started with setting up your computer.

The **Aspire Generic User Guide** contains useful information applying to all models in the Aspire product series. It covers basic topics such as using the keyboard and audio, etc. Please understand that due to its nature, the **Generic User Guide** as well as the **AcerSystem User Guide** mentioned below will occasionally refer to functions or features which are only contained in certain models of the series, but not necessarily in the model you purchased. Such instances are marked in the text with language such as "only for certain models".

The **Quick Guide** introduces you to the basic features and functions of your new computer. For more on how your computer can help you to be more productive, please refer to the **AcerSystem User Guide**. This guide contains detailed information on such subjects as system utilities, data recovery, expansion options and troubleshooting. In addition it contains warranty information and the general regulations and safety notices for your notebook. It is available in Portable Document Format (PDF) and comes preloaded on your notebook. Follow these steps to access it:

- 1 Click on  **Start, All Programs, AcerSystem.**
- 2 Click on **AcerSystem User Guide.**



Note: Viewing the file requires Adobe Reader. If Adobe Reader is not installed on your computer, clicking on **AcerSystem User Guide** will run the Adobe Reader setup program first. Follow the instructions on the screen to complete the installation. For instructions on how to use Adobe Reader, access the **Help and Support** menu.



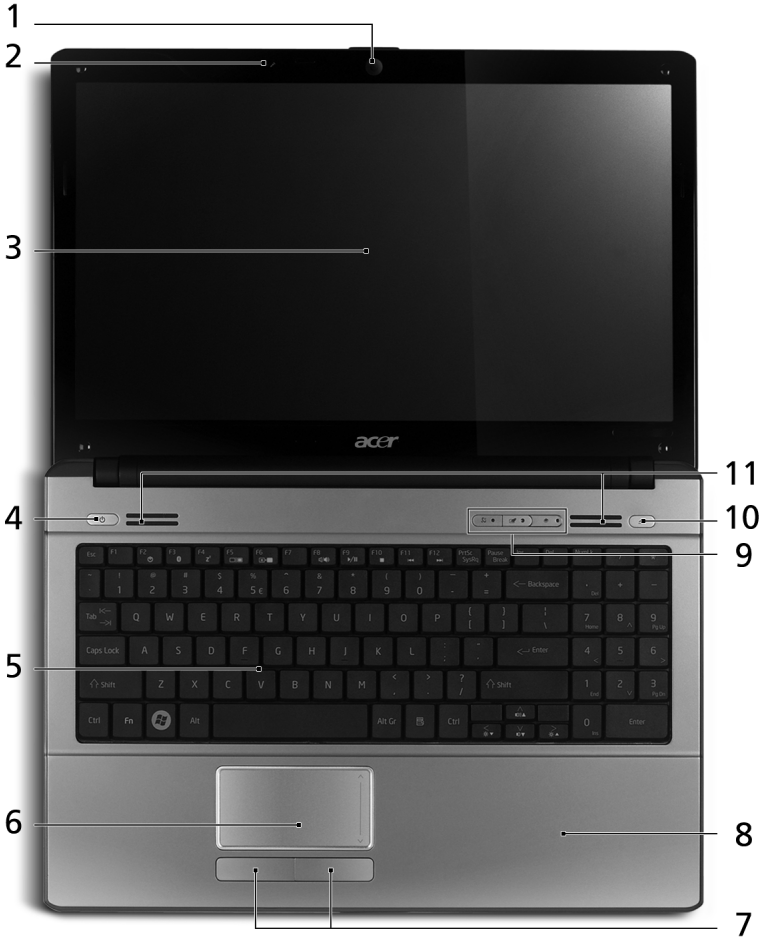

Your Acer notebook tour

After setting up your computer as illustrated in the **Just for Starters...** poster, let us show you around your new Acer notebook.

Top view













#	Icon	Item	Description
1		Acer Crystal Eye webcam	Web camera for video communication. (only for certain models)

#	Icon	Item	Description
2		Microphone	Internal microphone for sound recording.
3		Display screen	Also called Liquid-Crystal Display (LCD), displays computer output (Configuration may vary by models).
4		Power button / indicator	Turns the computer on and off. / Indicates the computer's power status.
5		Keyboard	For entering data into your computer.
6		Touchpad	Touch-sensitive pointing device which functions like a computer mouse.
7		Click buttons (left and right)	The left and right buttons function like the left and right mouse buttons.
8		Palmrest	Comfortable support area for your hands when you use the computer.
9		Wireless LAN communication button/indicator	Enables/disables the wireless LAN function. Indicates the status of wireless LAN communication.
		Touchpad toggle	Turns the internal touchpad on and off.
		HDD	Indicates when the hard disk drive is active.
10		Eject button	Presses to eject the optical disk from the drive.
11		Speakers	Left and right speakers deliver stereo audio output.

Hotkeys



The computer employs hotkeys or key combinations to access most of the computer's controls like screen brightness and volume output.

To activate hotkeys, press and hold the **<Fn>** key before pressing the other key in the hotkey combination.

Hotkey	Icon	Function	Description
<Fn> + <F2>		System property	Starts System Property for displaying system information.
<Fn> + <F3>		Bluetooth	Enables/disables the Bluetooth function. (only for certain models)
<Fn> + <F4>		Sleep	Puts the computer in Sleep mode.
<Fn> + <F5>		Display toggle	Switches display output between the display screen, external monitor (if connected) and both.
<Fn> + <F6>		Screen blank	Turns the display screen backlight off to save power. Press any key to return.
<Fn> + <F8>		Speaker toggle	Turns the speakers on and off.
<Fn> + <↑>		Brightness up	Increases the screen brightness.
<Fn> + <↓>		Brightness down	Decreases the screen brightness.
<Fn> + <△>		Volume up	Increases the sound volume.
<Fn> + <▽>		Volume down	Decreases the sound volume.

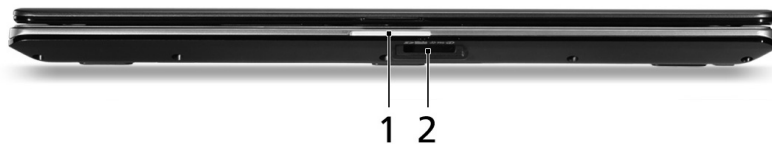
Closed front view



#	Icon	Item	Description
1		Battery ¹	Indicates the computer's battery status. 1. Charging: The light shows amber when the battery is charging. 2. Fully charged: The light shows blue when in AC mode.
2		Multi-in-1 card reader	Accepts Secure Digital (SD), MultiMediaCard (MMC), Memory Stick (MS), Memory Stick PRO (MS PRO), xD-Picture Card (xD). Note: Push to remove/install the card. Only one card can operate at any given time.

1. The front panel indicators are visible even when the computer cover is closed up.





Rear view

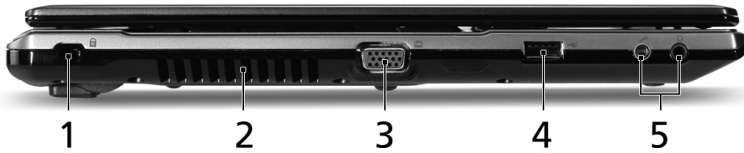

#	Icon	Item	Description
1		Battery bay	Houses the computer's battery pack.



Left view



#	Icon	Item	Description
1		Kensington lock slot	Connects to a Kensington-compatible computer security lock. Note: Wrap the computer security lock cable around an immovable object such as a table or handle of a locked drawer. Insert the lock into the notch and turn the key to secure the lock. Some keyless models are also available.
2		Ventilation slots	Enable the computer to stay cool, even after prolonged use.
3		External display (VGA) port	Connects to a display device (e.g., external monitor, LCD projector).
4		USB 2.0 port	Connect to USB 2.0 devices (e.g., USB mouse, USB camera).
5		Microphone-in jack	Accepts inputs from external microphones.
		Headphones/speaker/line-out jack	Connects to audio line-out devices (e.g., speakers, headphones).





Right view

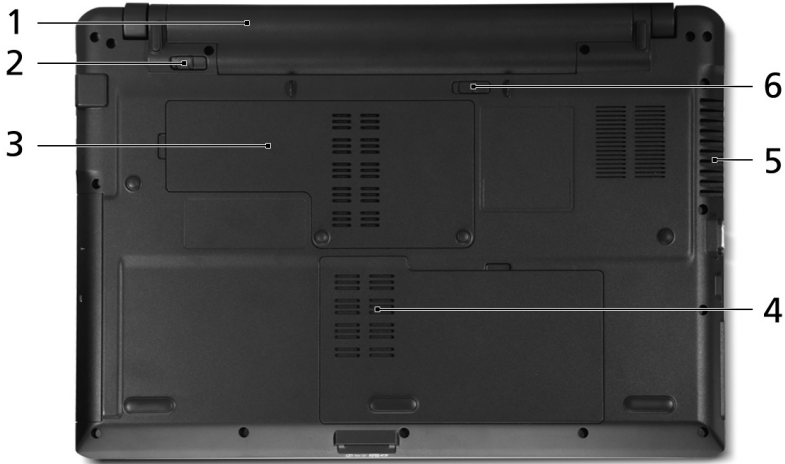

#	Icon	Item	Description
1		Optical drive	Internal optical drive; accepts CDs or DVDs.
2		Optical disk access indicator	Lights up when the optical drive is active.
3		Emergency eject hole	Ejects the optical drive tray when the computer is turned off. Note: Insert a paper clip to the emergency eject hole to eject the optical drive tray when the computer is off.
4		USB 2.0 port	Connects to USB 2.0 devices (e.g., USB mouse, USB camera).
5		Ethernet (RJ-45) port	Connects to an Ethernet 10/100/1000-based network.
6		DC-in jack	Connects to an AC adapter.

Base view



#	Icon	Item	Description
1		Battery bay	Houses the computer's battery pack.
2		Battery lock	Locks the battery in position.
3		Memory compartment	Houses the computer's main memory.
4		Hard disk bay	Houses the computer's hard disk (secured with screws).
5		Ventilation slots and cooling fan	Enable the computer to stay cool, even after prolonged use. Note: Do not cover or obstruct the opening of the fan.
6		Battery release latch	Releases the battery for removal.

Specifications

Operating system	<ul style="list-style-type: none"> Genuine Windows 7[®]
Platform	<ul style="list-style-type: none"> AMD Athlon™ 64 X2 dual-core processor* AMD Athlon™ 64 single-core processor* AMD M780G Chipset Acer InViLink™ Nplify™ 802.11b/g/Draft-N* Acer InViLink™ 802.11b/g*
System memory	<ul style="list-style-type: none"> Dual-channel support Up to 2 GB of DDR2 667 MHz memory, upgradeable to 4 GB using two soDIMM modules
Display	<ul style="list-style-type: none"> 15.6" HD 1366 x 768 16:9 aspect ratio
Graphics	<ul style="list-style-type: none"> ATI Radeon™ HD 3200 Graphics
Storage subsystem	<ul style="list-style-type: none"> 2.5" hard disk drive DVD-Super Multi double-layer drive Multi-in-1 card reader
Audio	<ul style="list-style-type: none"> Two built-in stereo speakers High-definition audio support MS-Sound compatible Built-in microphone
Communication	<ul style="list-style-type: none"> Integrated Acer Crystal Eye webcam* WLAN: <ul style="list-style-type: none"> Acer InViLink™ Nplify™ 802.11b/g/Draft-N* Acer InViLink™ 802.11b/g* LAN: Gigabit Ethernet; Wake-on-LAN ready
Dimensions	<ul style="list-style-type: none"> 380 (W) x 259 (D) x 26.4/30.8 (H) mm (14.82 x 10.1 x 1.02/1.2 inches) 2.4 kg (5.3 lbs.) with 6-cell battery pack
Privacy control	<ul style="list-style-type: none"> BIOS user, supervisor, HDD passwords Kensington lock slot
Power subsystem	<ul style="list-style-type: none"> ACPI 3.0 48.8 W 4400 mAh 3-pin 65 W AC adapter ENERGY STAR[®]*
Special keys and controls	<ul style="list-style-type: none"> 99-/100-/103-key keyboard Touchpad pointing device

I/O interface	<ul style="list-style-type: none">• Multi-in-1 card reader (SD™, MMC, MS, MS PRO, xD)• USB 2.0 port• External display (VGA) port• Headphones/speaker/line-out jack• Microphone-in jack• Ethernet (RJ-45) port• DC-in jack for AC adapter
Environment	<ul style="list-style-type: none">• Temperature:<ul style="list-style-type: none">• Operating: 5 °C to 35 °C• Non-operating: -20 °C to 65 °C• Humidity (non-condensing):<ul style="list-style-type: none">• Operating: 20% to 80%• Non-operating: 20% to 80%



.....

Note: * Only for certain models.



.....

Note: The specifications listed above are for reference only. The exact configuration of your PC depends on the model purchased.