

Aspire 8942 Series

Quick Guide

© 2009 All Rights Reserved.

Aspire 8942 Series Quick Guide
Original Issue: 11/2009

Aspire 8942 Series Notebook PC

Model number: _____

Serial number: _____

Date of purchase: _____

Place of purchase: _____

First things first

We would like to thank you for making an Acer notebook your choice for meeting your mobile computing needs.

Your guides

To help you use your Acer notebook, we have designed a set of guides:

First off, the **Just for Starters...** poster helps you get started with setting up your computer.

The **Aspire Series Generic User Guide** contains useful information applying to all models in the Aspire product series. It covers basic topics such as using the keyboard and audio, etc. Please understand that due to its nature, the **Generic User Guide** as well as the **AcerSystem User Guide** mentioned below will occasionally refer to functions or features which are only contained in certain models of the series, but not necessarily in the model you purchased. Such instances are marked in the text with language such as "only for certain models".

The **Quick Guide** introduces you to the basic features and functions of your new computer. For more on how your computer can help you to be more productive, please refer to the **AcerSystem User Guide**. This guide contains detailed information on such subjects as system utilities, data recovery, expansion options and troubleshooting. In addition it contains warranty information and the general regulations and safety notices for your notebook. It is available in Portable Document Format (PDF) and comes preloaded on your notebook. Follow these steps to access it:

- 1 Click on  **Start > All Programs > AcerSystem.**
- 2 Click on **AcerSystem User Guide.**



.....

Note: Viewing the file requires Adobe Reader. If Adobe Reader is not installed on your computer, clicking on **AcerSystem User Guide** will run the Adobe Reader setup program first. Follow the instructions on the screen to complete the installation. For instructions on how to use Adobe Reader, access the **Help and Support** menu.







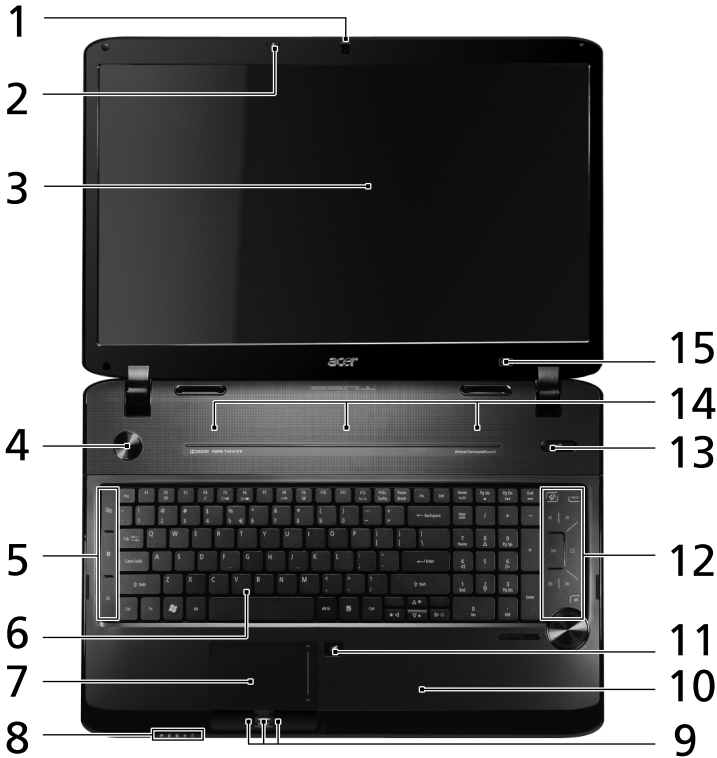



Your Acer notebook tour



After setting up your computer as illustrated in the **Just for Starters...** poster, let us show you around your new Acer notebook.

Top view



#	Icon	Item	Description
1		Acer Crystal Eye webcam	Web camera for video communication. (only for certain models)
2		Microphone	Internal microphone for sound recording.
3		Display screen	Also called Liquid-Crystal Display (LCD), displays computer output (Configuration may vary by models).

#	Icon	Item	Description
4		Power button	Turns the computer on and off.
5		Backup key	Launches Acer Backup Management for three-step data backup.
		Bluetooth communication button/indicator	Enables/disables the Bluetooth function. Indicates the status of Bluetooth communication. (only for certain models)
		Wireless LAN communication button/indicator	Enables/disables the wireless LAN function. Indicates the status of wireless LAN communication.
6		Keyboard	For entering data into your computer.
7		Touchpad	Touch-sensitive pointing device which functions like a computer mouse.
8		HDD	Indicates when the hard disk drive is active.
		Num Lock	Lights up when Num Lock is activated.
		Caps Lock	Lights up when Caps Lock is activated.
		Power ¹	Indicates the computer's power status.
		Battery ¹	Indicates the computer's battery status. 1. Charging: The light shows amber when the battery is charging. 2. Fully charged: The light shows blue when in AC mode.
9		Click buttons (left, center* and right)	The left and right buttons function like the left and right mouse buttons. *The center button serves as Acer Bio-Protection fingerprint reader supporting Acer FingerNav 4-way control function (only for certain models).
10		Palmrest	Comfortable support area for your hands when you use the computer.
11		Touchpad toggle	Turns the internal touchpad on and off.
12		Acer MediaTouch	Touch sensitive controls for Acer Arcade, volume (up/down) and media (play/pause, stop, previous, next); with mute and hold keys.









#	Icon	Item	Description
13		Acer PowerSmart key	Puts your computer into power-saving mode.
14		Speakers	Deliver stereo audio output.
15		Screen blank	Turns the display screen backlight off to save power. Press any key to return. (only for certain models)

1. The front panel indicators are visible even when the computer cover is closed up.

Hotkeys



The computer employs hotkeys or key combinations to access most of the computer's controls like screen brightness and volume output.

To activate hotkeys, press and hold the **<Fn>** key before pressing the other key in the hotkey combination.

Hotkey	Icon	Function	Description
<Fn> + <F2>		System property	Starts System Property for displaying system information.
<Fn> + <F4>		Sleep	Puts the computer in Sleep mode.
<Fn> + <F5>		Display toggle	Switches display output between the display screen, external monitor (if connected) and both.
<Fn> + <F6>		Screen blank	Turns the display screen backlight off to save power. Press any key to return.
<Fn> + <F8>		Speaker toggle	Turns the speakers on and off.
<Fn> + <F9>		Keyboard backlight toggle	Turns the keyboard backlight on or off.
<Fn> + <↑>		Brightness up	Increases the screen brightness.
<Fn> + <↓>		Brightness down	Decreases the screen brightness.

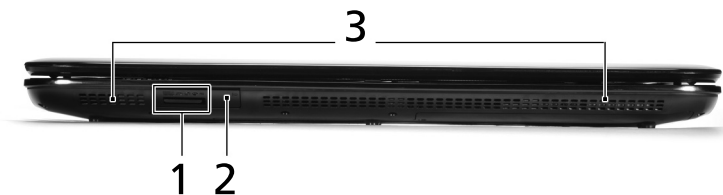
Closed front view



#	Icon	Item	Description
1		Multi-in-1 card reader	Accepts Secure Digital (SD), MultiMediaCard (MMC), Memory Stick (MS), Memory Stick PRO (MS PRO), xD-Picture Card (xD). Note: Push to remove/install the card. Only one card can operate at any given time.
2		CIR receiver	Receives signals from a remote control.
3		Speakers	Deliver stereo audio output.









Rear view



#	Item	Description
1	Tuba	Tuba CineBass subwoofer for low-frequency audio output.
2	Ventilation slots	Enable the computer to stay cool, even after prolonged use.





Left view



#	Icon	Item	Description
1		DC-in jack	Connects to an AC adapter.
2		Ethernet (RJ-45) port	Connects to an Ethernet 10/100/1000-based network.
3		External display (VGA) port	Connects to a display device (e.g., external monitor, LCD projector).
4	DISPLAY	DISPLAY port	Supports high definition digital video connections.
5	HDMI	HDMI port	Supports high definition digital video connections.
6	eSATA	eSATA port	Connects to eSATA devices (only for certain models).
7		USB 2.0 port	Connects to USB 2.0 devices (e.g., USB mouse, USB camera).
8		4-pin IEEE 1394 port	Connects to IEEE 1394 devices.
9		Line-in jack	Accepts audio line-in devices (e.g., audio CD player, stereo walkman, mp3 player)
		Microphone-in jack	Accepts inputs from external microphones.
		Headphones/speaker/line-out jack with SPDIF support	Connects to audio line-out devices (e.g., speakers, headphones).
10		ExpressCard/54 slot	Accepts one ExpressCard/54 module.





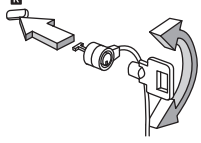

Right view

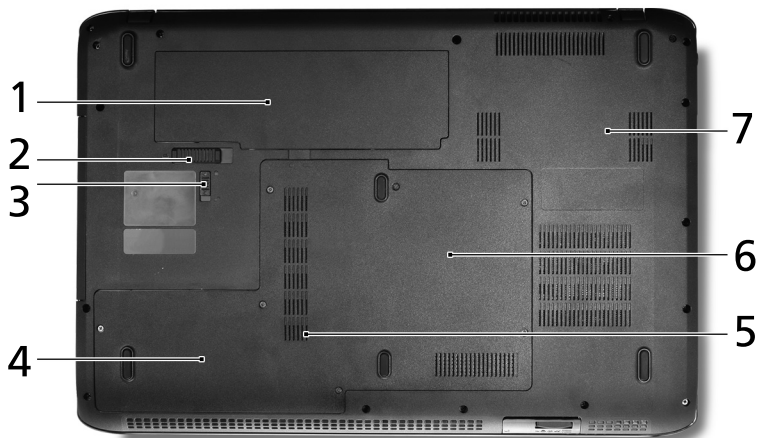

#	Icon	Item	Description
1		USB 2.0 port	Connects to USB 2.0 devices (e.g., USB mouse, USB camera).
2		Optical drive	Internal optical drive; accepts CDs or DVDs.
3		Optical disk access indicator	Lights up when the optical drive is active.
4		Optical drive eject button	Ejects the optical disk from the drive.
5		Emergency eject hole	Ejects the optical drive tray when the computer is turned off. Note: Insert a paper clip to the emergency eject hole to eject the optical drive tray when the computer is off.
6		USB 2.0 port	Connects to USB 2.0 devices (e.g., USB mouse, USB camera).
7		RF-in port	Accepts input signals from digital TV-tuner devices. (only for certain models)
8		Kensington lock slot	Connects to a Kensington-compatible computer security lock.  Note: Wrap the computer security lock cable around an immovable object such as a table or handle of a locked drawer. Insert the lock into the notch and turn the key to secure the lock. Some keyless models are also available.

Base view



#	Icon	Item	Description
1		Battery bay	Houses the computer's battery pack.
2		Battery release latch	Releases the battery for removal.
3		Battery lock	Locks the battery in position.
4		Hard disk bay- Secondary	Houses the computer's hard disk (secured with screws) (for certain models only).
5		Hard disk bay-Main	Houses the computer's hard disk (secured with screws).
6		Memory compartment	Houses the computer's main memory.
7		Ventilation slots and cooling fan	Enable the computer to stay cool, even after prolonged use. Note: Do not cover or obstruct the opening of the fan.

Specifications

Operating system	<ul style="list-style-type: none"> • Genuine Windows® 7
CPU/chipset	<ul style="list-style-type: none"> • Intel® Core™ i7 processor* • Intel® Core™ i5 processor* • Intel® Core™ i3 processor* • Intel® HM55 Express Chipset
System memory	<ul style="list-style-type: none"> • Dual-Channel SDRAM support • Up to 4 GB of DDR3 1066 MHz memory, upgradeable to 8 GB using two soDIMM modules
Display	<ul style="list-style-type: none"> • 16:9 aspect ratio • 18.4" Full HD 1920 x 1080
TV-tuner	<ul style="list-style-type: none"> • Digital TV-tuner supporting DVB-T*
Graphics	<ul style="list-style-type: none"> • ATI Mobility Radeon™ HD 5850* • ATI Mobility Radeon™ HD 5650*
Audio	<ul style="list-style-type: none"> • Dolby®-optimized surround sound system with five built-in stereo speakers and one subwoofer • True5.1-channel surround sound output • High-definition audio support • S/PDIF (Sony/Philips Digital Interface) support for digital speakers • MS-Sound compatible • Acer Purezone technology with two built-in stereo microphones
Storage subsystem	<ul style="list-style-type: none"> • 2.5" hard disk drive • Optical drive options: <ul style="list-style-type: none"> • Blu-ray Disc™ Writer/DVD-Super Multi double-layer drive* • Blu-ray Disc™/DVD-Super Multi double-layer drive* • DVD-Super Multi double-layer drive* • Multi-in-1 card reader

Communication	<p>Acer Video Conference, featuring:</p> <ul style="list-style-type: none"> • Integrated Acer Crystal Eye webcam* • Acer PureZone technology* • WLAN: <ul style="list-style-type: none"> • Intel® Centrino® Ultimate-N 6300 802.11a/g/n* • Intel® Centrino® Advanced-N 6200 802.11a/g/n* • Intel® Centrino® Wireless-N 1000 802.11b/g/n* • Acer InviLink™ Nplify™ 802.11b/g/n* • Acer InviLink™ 802.11b/g* • WPAN: Bluetooth® 2.1+Enhanced Data Rate (EDR)* • LAN: Gigabit Ethernet; Wake-on-LAN ready
Privacy control	<ul style="list-style-type: none"> • Acer Bio-Protection fingerprint solution* • BIOS user, supervisor, HDD passwords • Kensington lock slot
Dimensions and weight	<ul style="list-style-type: none"> • 440 (W) x 295 (D) x 31/43.8 (H) mm (17.34 x 11.62 x 1.22/1.73 inches) • 4.6 kg (10.1 lbs.) with 8-cell battery
Power subsystem	<ul style="list-style-type: none"> • ACPI 3.0 • 71 W 4800 mAh battery • 3-pin 120 W AC adapter • ENERGY STAR®*
Special keys and controls	<ul style="list-style-type: none"> • 103-/104-/107-key keyboard • Touchpad pointing device
I/O interface	<ul style="list-style-type: none"> • ExpressCard®/54 slot • Acer Bio-Protection fingerprint reader* • Multi-in-1 card reader (SD/MMC/MS/MS PRO/xD) • USB 2.0 port • IEEE 1394 port • HDMI™ port with HDCP support • DISPLAY port • eSATA port • External display (VGA) port • Consumer infrared (CIR) port • RF-in jack* • Headphones/speaker/line-out jack with S/PDIF support • Microphone-in jack • Line-in jack • Ethernet (RJ-45) port • DC-in jack for AC adapter

Environment	<ul style="list-style-type: none">• Temperature:<ul style="list-style-type: none">• Operating: 5 °C to 35 °C• Non-operating: -20 °C to 65 °C• Humidity (non-condensing):<ul style="list-style-type: none">• Operating: 20% to 80%• Non-operating: 20% to 80%
-------------	---



.....

Note: * Only for certain models



.....

Note: The specifications listed above are for reference only. The exact configuration of your PC depends on the model purchased.

What you need to enjoy TV (only for certain models)



Note: The following content is for general reference only. Actual product specifications may vary.

If your computer has a TV-tuner, it includes a complete set of cables, NTSC converter, optional DVB-T antenna (only for certain models), and a remote control for use with the Windows Media Center.

These include:

- 1 Antenna connector and cable converter

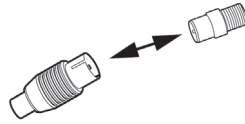

- 2 Optional DVB-T (digital TV) antenna, VHF and UHF compatible (only for certain models)
- 3 Remote control

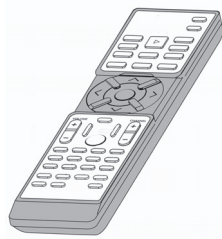

Copy-protected media files

To prevent illegal distribution, some digital media files are secured with a license. This license specifies how you may use the file and the duration of the license. For example, a license can specify whether you can copy the file to a portable device or play it on another computer.

The terms of the license are specified by the person or company that provided the file, or the TV broadcaster that provided the content. Windows Media Center cannot play protected files unless you acquire a license for that content. There are many different ways you may acquire licensed files; the most common is to download them from content providers (such as a record company). The content provider may issue a license when you download the file. Otherwise, when you play a file for which you have no license, Windows Media Center attempts to acquire one automatically or prompts you to acquire one.

Additionally, some TV content might be marked as protected by the TV content owner, broadcaster, or originator. The terms of the content protection are specified by the content provider and transmitted with the TV show. If the show is recorded, the content protection terms are stored with the recorded TV file and enforced upon playback. Some shows or portions of a recorded show might be restricted to play on the PC that it was recorded on. If you attempt to play the recorded TV file on another computer, you are notified that it is restricted content and you cannot play it.

In addition, some protected media files or portions of files might have a license that expires after a specified amount of time. If you try to access the media file after the license expires, you are notified that the media file is no longer available.



Note: Not all display adapters and associated drivers support restricted content. If support for restricted content is added, you may need to update the driver for your video adapter. For more information, contact your hardware manufacturer.

Enjoying TV with Windows Media Center

Computers that include Windows Media Center Edition or InstantOn Arcade may be used to watch TV and to access video content (via an audio/video connection to an external device, such as a video camera).

Choose your input type

The audio/video connection may be either a DVB-T digital antenna (only for certain models) or a PAL/SECAM or NTSC connector. Please refer to the appropriate section:

Watching TV using the optional DVB-T (digital TV) antenna (only for certain models)

DVB-T digital TV is an international standard that is used to transmit terrestrial television services in digital format. It is gradually replacing analog broadcasts in many countries. The DVB-T digital antenna can be used with Windows Media Center to watch local DVB-T digital TV broadcasts on your notebook PC.

To connect the digital antenna

- 1 Plug the antenna cable into the RF jack of your computer.

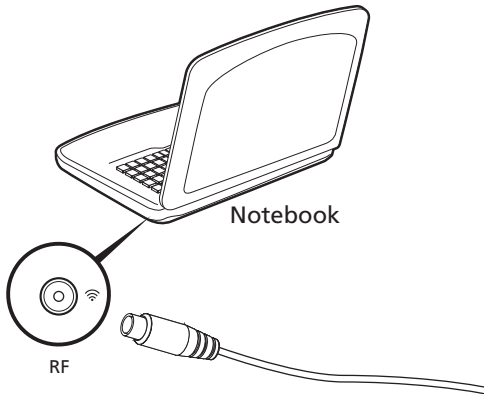

Note: Do not twist or loop the antenna cable. Extending the antenna cable up to 20 cm to improve signal quality.

Watching TV with an external antenna or cable socket

You may use conventional TV cables (connected to an external antenna or cable socket) to watch TV on your computer.

Connecting antenna cables

To connect your cables:

- 1 Plug the antenna connector into the RF jack of your computer.
- 2 Connect the other end to your TV cable, using the cable converter if necessary.

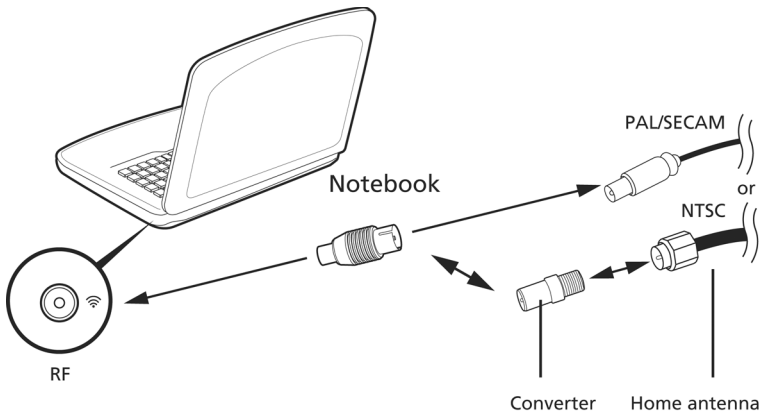

Important! Please ensure you use the correct cable system for your region before attempting to connect the antenna cable.

Running the Windows Media Center Setup wizard

To watch TV on your computer, you need to run the Windows Media Center TV Setup Wizard. Follow these steps to complete the TV function setup:

- 1 Open Windows Media Center from the **Start, All Programs** menu. This will open the Windows Media Center welcome screen.
- 2 Click **Tasks, settings, TV**, followed by **Set Up TV Signal** to begin the TV setup process.
- 3 If you have already configured some settings, Windows Media Center will warn you that changing your settings may affect any current/scheduled recordings. Click **Yes**, followed by **Next** to begin the setup.
- 4 Windows Media Center will automatically detect your region. If the default choice is correct, select **Yes**, followed by **Next**. If incorrect, first select **No**, followed by **Next**, before choosing your correct region. Select **Next** to continue.
- 5 Next, you will be presented with a choice of TV signals. Select **Antenna**, then select **DVB-T**.
- 6 You will then be asked if you have a set-top box. Select **No**, then press **OK** to continue.
- 7 Windows Media Center will then scan for available TV services. Click **Start Scan** to continue.
- 8 Next, select whether you want to use the TV guide service. Choose **Yes** or **No**, before clicking **Next** to continue. If you select **Yes**, you will be directed to the TV guide agreement and enter-postcode pages.
- 9 When complete, you will be prompted to save the scan results. Click **Finish** to save the results and exit.
- 10 You are now ready to begin watching TV.



.....
Note: For more details on how to set up TV channels, please refer to the Windows Media Center help file.

Begin watching TV

To begin watching TV, you need to open Windows Media Center:

- 1 Click **Start**, **All Programs**, and **Windows Media Center**. This will open the Windows Media Center main page.
- 2 Select **TV** from the main page
- 3 Click on **Live TV** to begin watching.

If you have not started your computer, you may use InstantOn Arcade (only for certain models):

- 1 Push the InstantOn button on your computer.
- 2 Push the **Live TV** button on your remote.

Remote control

If your computer is bundled with a remote control for use with Windows Media Center, the table below explains the functions.



When using Windows, pushing the POWER button will put your computer into Standby mode; pushing it again to resume. When using InstantOn Arcade, push the POWER button to shut down your computer.

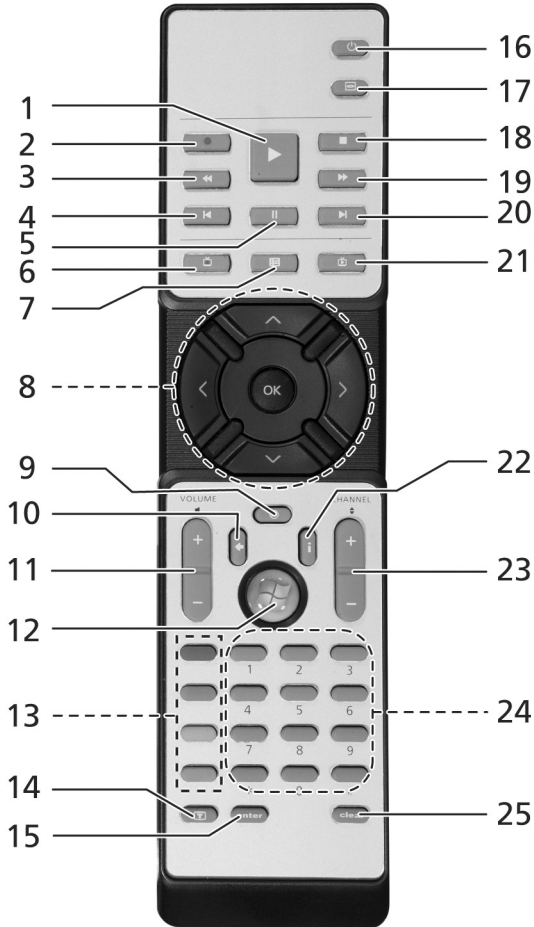

Remote functions

#	Item	Description
1	Play	Play selection
2	Record	Record TV
3	Rewind	Reverse playback or go to previous picture
4	Skip Backward	Skip a section backward
5	Pause	Pause playback
6	Recorded TV	Display Recorded TV page
7	Guide	Display the Guide
8	Navigation/ OK buttons	Navigate and confirm selection
9	Mute	Toggle audio on/off
10	Back	Return to an earlier screen
11	Volume + / -	Increase or decrease the audio playback level
12	Start	Open or close Windows Media Center
13	Color buttons	Teletext shortcut functions*
14	TeleText*	Turn teletext on or off
15	Enter	Activate the current selection
16	Power	Enter or wake from Standby mode
17	DVD Menu	Display DVD menu
18	Stop	Stop current playing or recording operation
19	Fast Forward	Speed up playback or go to next picture
20	Skip Forward	Skip a section forward
21	Live TV	Show live TV
22	Information	Provide information about the current selection
23	Channel + / -	Change the channel
24	0-9 buttons	Enter TV channel or other input
25	Clear	Clear current input

*TeleText regions only.