

Aspire 3620/TravelMate 2420 Series Service Guide

Service guide files and updates are available on the ACER/CSD web; for more information, please refer to <http://csd.acer.com.tw>

PRINTED IN TAIWAN

Revision History

Please refer to the table below for the updates made on Aspire 3620/TravelMate 2420 service guide.

Date	Chapter	Updates
2006/01/13	Chapter 1	Add Intel® Pentium® M 730/740 Processor (2 MB L2 cache, 1.73GHz, 533 MHz FSB) to page 1.

Copyright

Copyright © 2005 by Acer Incorporated. All rights reserved. No part of this publication may be reproduced, transmitted, transcribed, stored in a retrieval system, or translated into any language or computer language, in any form or by any means, electronic, mechanical, magnetic, optical, chemical, manual or otherwise, without the prior written permission of Acer Incorporated.

Disclaimer

The information in this guide is subject to change without notice.

Acer Incorporated makes no representations or warranties, either expressed or implied, with respect to the contents hereof and specifically disclaims any warranties of merchantability or fitness for any particular purpose. Any Acer Incorporated software described in this manual is sold or licensed "as is". Should the programs prove defective following their purchase, the buyer (and not Acer Incorporated, its distributor, or its dealer) assumes the entire cost of all necessary servicing, repair, and any incidental or consequential damages resulting from any defect in the software.

Acer is a registered trademark of Acer Corporation.

Intel is a registered trademark of Intel Corporation.

Pentium and Pentium II/III are trademarks of Intel Corporation.

Other brand and product names are trademarks and/or registered trademarks of their respective holders.

Conventions

The following conventions are used in this manual:

SCREEN MESSAGES	Denotes actual messages that appear on screen.
NOTE	Gives bits and pieces of additional information related to the current topic.
WARNING	Alerts you to any damage that might result from doing or not doing specific actions.
CAUTION	Gives precautionary measures to avoid possible hardware or software problems.
IMPORTANT	Reminds you to do specific actions relevant to the accomplishment of procedures.

Preface

Before using this information and the product it supports, please read the following general information.

1. This Service Guide provides you with all technical information relating to the BASIC CONFIGURATION decided for Acer's "global" product offering. To better fit local market requirements and enhance product competitiveness, your regional office MAY have decided to extend the functionality of a machine (e.g. add-on card, modem, or extra memory capability). These LOCALIZED FEATURES will NOT be covered in this generic service guide. In such cases, please contact your regional offices or the responsible personnel/channel to provide you with further technical details.
2. Please note WHEN ORDERING FRU PARTS, that you should check the most up-to-date information available on your regional web or channel. If, for whatever reason, a part number change is made, it will not be noted in the printed Service Guide. For ACER-AUTHORIZED SERVICE PROVIDERS, your Acer office may have a DIFFERENT part number code to those given in the FRU list of this printed Service Guide. You MUST use the list provided by your regional Acer office to order FRU parts for repair and service of customer machines.

Table of Contents

Chapter 1	System Specifications	1
	Features	1
	System Block Diagram	3
	Board Layout	4
	Top View	4
	Bottom View	5
	Your Acer Notebook tour	7
	Aspire 3620 front View	7
	TravelMate 2420 front view	8
	Closed Front View	9
	Left View	10
	Right View	10
	Rear Panel	11
	Bottom Panel	11
	Indicators	12
	Easy-Launch Buttons	13
	Touchpad Basics	14
	Using the Keyboard	16
	Lock Keys and embedded numeric keypad	16
	Windows Keys	17
	Hot Keys	17
	Special Key	19
	Acer Empowering Technology	20
	Acer eDataSecurity Management	20
	Acer eLock Management	22
	Acer ePerformance Management	23
	Acer eRecovery Management	24
	Acer eSettings Management	25
	Acer ePower Management	26
	Hardware Specifications and Configurations	29
Chapter 2	System Utilities	37
	BIOS Setup Utility	37
	Navigating the BIOS Utility	38
	Information	39
	Main	40
	Security	42
	Boot	46
	Exit	47
	BIOS Flash Utility	48
Chapter 3	Machine Disassembly and Replacement	49
	General Information	50
	Before You Begin	50
	Disassembly Procedure Flowchart	51
	Removing the Battery Pack	53
	Removing the Wireless LAN Card/the HDD Module/the Memory/ the ODD Module and the LCD Module	54
	Removing the Memory and the HDD Module	54
	Removing the ODD Module	55
	Removing the LCD Module	55
	Disassembling the Main Unit	58

Table of Contents

Separate the Main Unit Into the Upper and the Lower Case Assembly	58
Disassembling the Lower Case Assembly	58
Disassembling the Upper Case Assembly	60
Disassembling the LCD Module	62
Disassembling the External Modules	64
Disassembling the HDD Module	64
Disassembling the ODD Module	64
Chapter 4 Troubleshooting	65
System Check Procedures	66
External Diskette Drive Check	66
External CD-ROM Drive Check	66
Keyboard or Auxiliary Input Device Check	66
Memory check	67
Power System Check	67
Touchpad Check	69
Power-On Self-Test (POST) Error Message	70
Index of Error Messages	71
Phoenix BIOS Beep Codes	74
Index of Symptom-to-FRU Error Message	78
Intermittent Problems	81
Undetermined Problems	82
Chapter 5 Jumper and Connector Locations	83
Top View	83
Bottom View	84
Chapter 6 FRU (Field Replaceable Unit) List	85
Aspire 3620/TravelMate 2420 Exploded Diagram	86

System Specifications

Features

Below is a brief summary of the computer's many feature:

Platform and memroy

- Intel® Pentium® M 725 Processor (2 MB L2 cache, 1.6GHz, 400 MHz FSB) or Intel® Pentium® M 730/740Processor (2 MB L2 cache, 1.73GHz, 533 MHz FSB)
- Intel® Celeron M 370/380/390 Processor (1 MB L2 cache, 1.50/1.60/1.70GHz, 400MHz FSB)
- Intel® 910GML+ICH6M
- Two DIMM slots support 128MB to 2GB system memory

Display and graphics

- 14.1" WXGA color TFT LCD, 1280 x 800 pixel resolution, supporting simultaneous multi-window viewing on dual display via Acer DridVista™
- 16.7 million colors
- Intel® GMA 900 integrated 3D graphics, with up to 128 MB of VRAM, supporting Microsoft® directX® 9.0 and dual independent display
- Simultaneous LCD and CRT display, with LCD panel refresh rate at 70 Hz
- MPEG-2/DVD hardware-assisted capability

Storage subsystem

- 40/60/80/100/120 GB ATA/100 hard disk drive
- Optical drive options:
 - ▶DVD-Dual double layer drive
 - ▶DVD/CD-RW combo drive

Input devices

- 88/89-key keyboard
- Built-in touchpad with 4-way integrated scroll button
- Four easy-launch buttons
- Two front-access buttons: WLAN LED-button and Bluetooth® LED-button

Audio

- Audio system with two built-in speakers and microphone
- Intel High-Definition audio support
- Sound Blaster Pro™ and MS-Sound compatible
- S/PDIF (Sony/Philips Digital Interface) support for digital speakers

Communication

- Modem: 56K ITU V.92 modem with PTT approval; wake-on ring ready
- LAN: 10/100 Mbps Fast Ethernet; wake-on-LAN ready
- WLAN: integrated Acer InviLink™ 802.11b/g WI-Fi® CERTIFIED™ solution; Acer SignalUp™ technology support

-
- WPAN: integrated Bluetooth®

Human-centric design and ergonomics

- Rugged, yet extremely portable design
- Stylish appearance
- Full-size keyboard with four programmable launch keys
- Ergonomically-centered touchpad pointing device
- Internet 4-way scroll button

I/O Ports

- Three USB 2.0 ports
- PC Card slot (one type II)
- External display (VGA) port
- Headphones/speaker/line-out jack with S/PDIF
- Microphone-in jack
- Line-in jack
- Ethernet (RJ-45) port
- Modem (RJ-11) port
- DC-in jack for AC adaptor

Environment

- Temperature:
 - operating: 5° C to 35° C
 - Non-operating: -20° C to 65° C
- Humidity (non-condensing):
 - operating: 20%~80%
 - Non-operating: 20%~80%

System Block Diagram

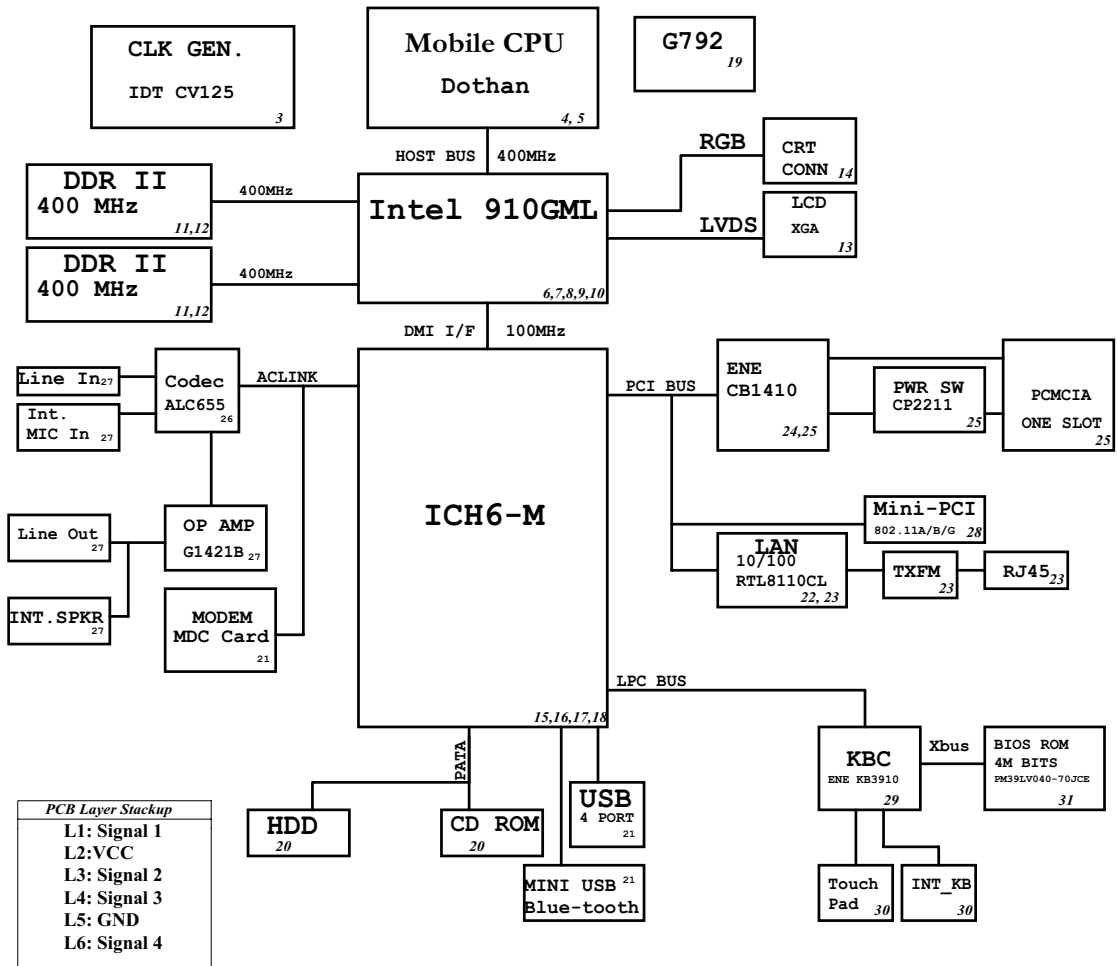

Board Layout

Top View

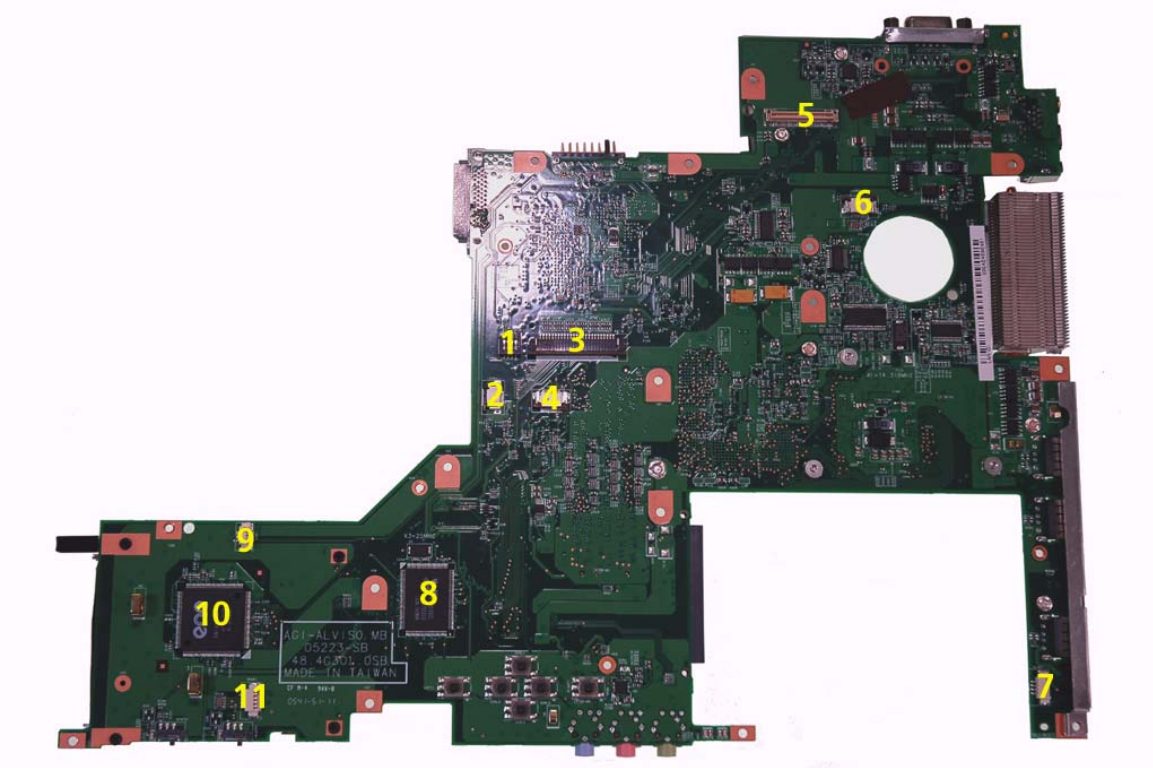

1	SW1	Switch	7	BLUE1	Bluetooth Cable Connector
2	LEDB1	LED Board Cable Connector	8	U39	LAN Connector: RTL8100CL
3	KB1	Keyboard Connector	9	RTC1	RTC Battery Connector
4	TPAD1	Touchpad Cable Connector	10	U40	Keyboard Controller: ENE CB-1410QF
5	LCD1	LCD Cable Connector	11	SPKR1	Speaker Set Cable Connector
6	LAUNCH1	Launch Board Cable Connector			

Bottom View

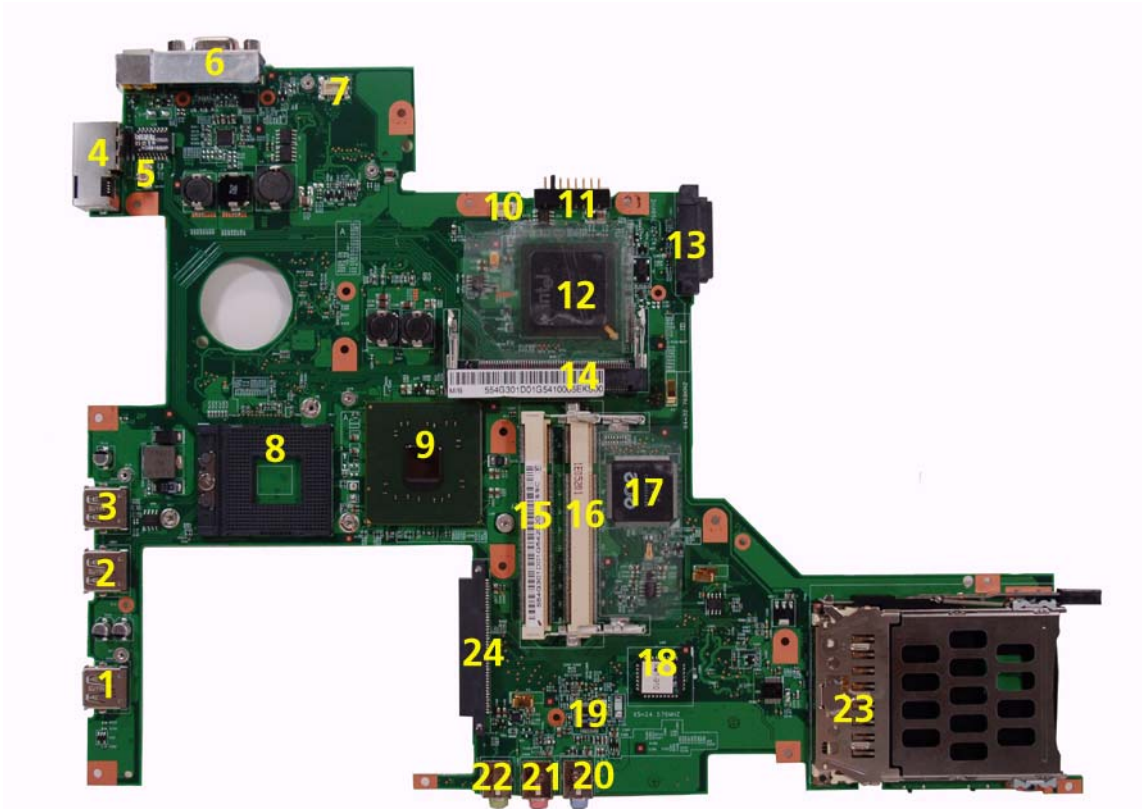

NOTE: This is engineering sample. The image above may not be exactly the same as the real main board you get.

1	USB2	USB port	13	ODD1	ODD Connector
2	USB3	USB port	14	WIN1	Wireless LAN Card Slotr
3	USB4	USB port	15	DM1	DIMM Slot1
4	LAN1	RJ11+RJ45 (Modem Port+ Ethernet Port)	16	DM3	DIMM Slot2
5	MDCW1	Modem Cable Connector	17	U44	Keyboard Controller (ENE KB3910SF)
6	CRT1	External Display Port	18	U49	BIOS ROM
7	MDC	Modem Board Connector	19	U32	Audio Codec (Realtek ACL)
8	U41	CPU Socket	20	LIN1	Line-in Jack
9	U38	North Bridge ()	21	MIC2	Headphones/Speakers/Line-Out Jack
10	FAN1	System Fan Cable Connector	22	LOUT1	Line-in Jack
11	BAT1	Battery Connector	23	PC1	PC Card Slot
12	U	South Bridge ()	24	HDD1	HDD Connector

Jumper Settings

PIN	Description
Pin1-Pin8	Clear Password
Pin2-Pin7	No Function
Pin3-Pin6	No Function
Pin4-Pin5	No Function

Your Acer Notebook tour

After knowing your computer features, let us show you around your new TravelMate computer.

Aspire 3620 front View





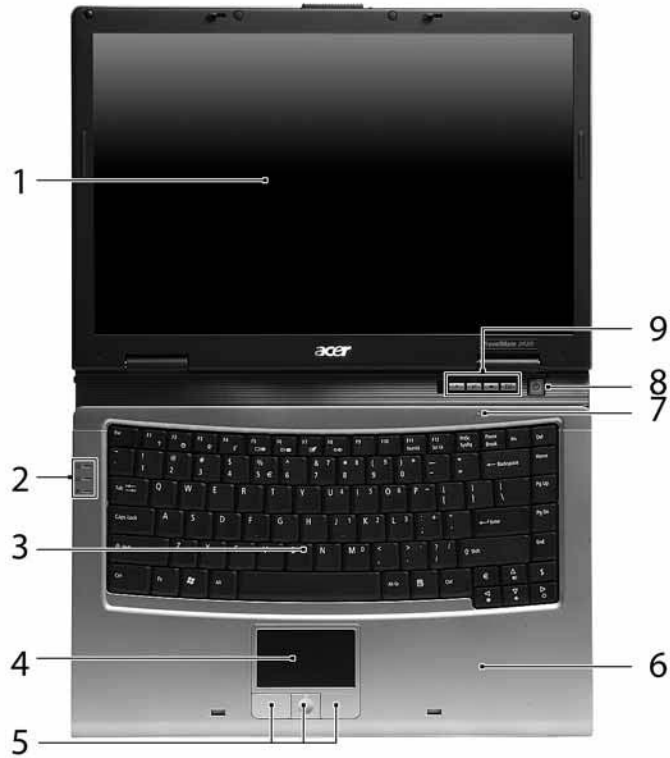



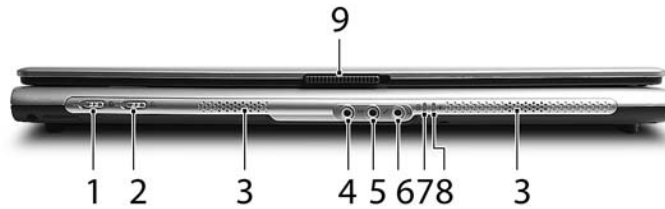

TravelMate 2420 front view



#	Icon	Item	Description
1		Display screen	Also called LCD (liquid-crystal display), displays computer output.
2		Status indicators	Light-Emitting Diodes (LEDs) that light up to show the status of the computer's functions and components.
3		Keyboard	For entering data into your computer.
4		Touchpad	Touch-sensitive pointing device which functions like a computer mouse.
5		Click buttons (left, center and right)	The left and right buttons function like the left and right mouse buttons; the center button serves as a 4-way scroll button.
6		Palmrest	Comfortable support area for our hands when you use the computer.
7		Microphone	Internal microphone for sound recording.
8		Power button	Turns the computer on and off.
9		Easy-launch Buttons	Buttons for launching frequently used programs.

Closed Front View



#	Icon	Item	Description
1		Bluetooth® communication button/indicator	Press to enable/disable Bluetooth function. Lights to indicate the status of Bluetooth-communications.
2		Wireless communication button/indicator	Press to enable/disable Wireless function. Lights to indicate the status of wireless LAN communications.
3		Speakers	Left and right speakers deliver stereo audio output.
4		Line-in jack	Accepts audio line-in devices (e.g., audio CD player, stereo walkman).
5		Microphone-in jack	Accepts input from external microphones.
6		Headphones/speakers/line-out jack with S/PDIF support	Connects to audio line-out devices (e.g., speakers, headphones).
7		Battery indicator	Indicates the computer's battery status.
8		Power indicator	Indicates the computer's power status
9		Latch	Locks and release the lid.



Left View



#	Icon	Item	Description
1		Kensington lock slot	Connects to a Kensington-compatible computer security lock.
2		Optical drive	Internal optical drive; accepts CDs or DVDs.
3		Optical disk access indicator	Lights up when the optical drive is active.
4		Optical drive eject button	Ejects the optical disk from the drive.
5		Emergency eject hole	Ejects the optical drive tray when the computer is turned off.
6		PC Card slot eject button	Ejects the PC Card from the slot.
7		PC Card slot	Accepts on Type II PC Card.

Right View





#	Icon	Item	Description
1		Three USB 2.0 ports	Connect to USB 2.0 devices (e.g., USB mouse, USB camera).
2		Ventilation slots	Enable the computer to stay cool, even after prolong use.
3		Modem (RJ-11) port	Connects to a phone line.

4		Ethernet (RJ-45)	Connects to an Ethernet 10/100/1000-based network.
---	---	------------------	--

Rear Panel



#	Icon	Item	Description
1		DC-in jack	Connects to an AC adapter.
		External display (VGA) port	Connects to a display device (e.g., external monitor, LCD projector).
		Battery	Powers the computer

Bottom Panel

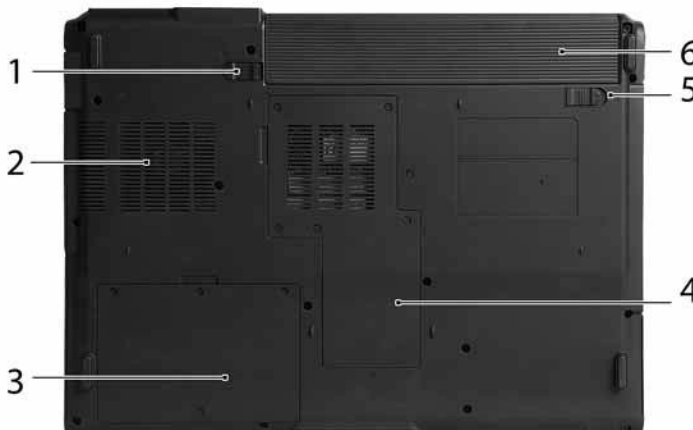

#	Item	Description
1	Battery lock	Locks the battery in position.
2	Cooling fan	Helps keep the computer cool. Note: Do not cover or obstruct the opening of the fan.

3	Hard disk bay	Houses the computer's hard disk (secured with screws)
4	Memory compartment	Houses the computer's main memory.
5	Battery release latch	Release the battery for removal.
6	Battery bay	Houses the computer's battery pack.

Indicators

The computer has four easy-to-read status indicators on the upper-right above the keyboard, and four on the front panel.







Aspire 3620:



TravelMate 2420:



The power, battery and wireless communication status indicators are visible even when the LCD display is closed.

Icon	Function	Description
	Cap lock	Lights when Cap Lock is activated
	Num lock	Lights when Num Lock is activated.
	HDD	Indicates when the hard disc or optical drive is active.
	Bluetooth	Indicates the status of Bluetooth communication.
	Wireless LAN	Indicates the status of wireless LAN communication.
	Battery	Lights up when the battery is being charged.
	Power	Lights up when the computer is on.

NOTE: 1. **Charging:** The light shows amber when the battery is charging. 2. **Fully charged:** The light shows green when in AC mode.

Easy-Launch Buttons

Located above the keyboard are four buttons. These buttons are called easy-launch buttons. They are: mail Web browser, Empowering Key “*e*” and one user-programmable button.

Press “*e*” to run the Acer Empowering Technology. The mail and Web browser buttons are pre-set to email and Internet programs, but can be reset by users. To set the Web browser, mail and programmable buttons, run the Acer Launch Manager.



Launch key	Default application
P	User-programmable
P	User-programmable
<i>e</i>	Acer Empowering Technology (user-programmable)
Web browser	Internet browser (user-programmable)
Mail	Email application (user-programmable)

Touchpad Basics

The following teaches you how to use the touchpad:

Aspire 3620:

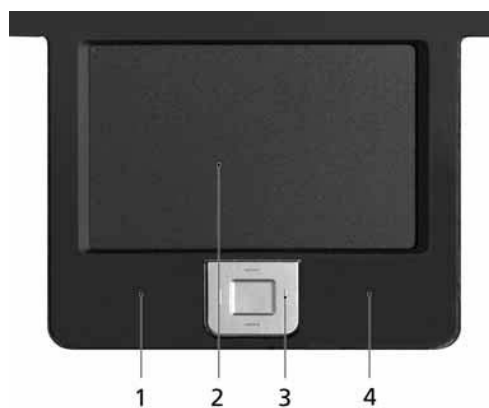

TravelMate 2420:



- Move your finger across the touchpad (2) to move the cursor.
- Press the left (1) and right (4) buttons located beneath the touchpad to perform selection and execution functions. These two buttons are similar to the left and right buttons on a mouse. Tapping on the touchpad is the same as clicking the left button.
- Use the 4-way scroll (3) button to scroll up or down and move left or right a page. This button mimics your cursor pressing on the right scroll bar of Windows applications.

Function	Left Button (1)	Right Button (4)	Main touchpad (2)	Center button (3)
Execute	Click twice quickly		Tap twice (at the same speed as double-clicking the mouse button)	
Select	Click once		Tap once	
Drag	Click and hold, then use finger to drag the cursor on the touchpad		Tap twice (at the same speed as double-clicking a mouse button) then hold finger to the touchpad on the second tap to drag the cursor.	
Access context menu		Click once		
Scroll				Click and hold to move up/down/left/right.

NOTE: Keep your fingers dry and clean when using the touchpad. Also keep the touchpad dry and clean. The touchpad is sensitive to finger movements. Hence, the lighter the touch, the better the response. Tapping too hard will not increase the touchpad's responsiveness.

Using the Keyboard

The keyboard has full-sized keys and an embedded keypad, separate cursor keys, two Windows keys and twelve function keys.

Lock Keys and embedded numeric keypad

The keyboard has three lock keys which you can toggle on and off.

Aspire 3620:



TravelMate 2420:



Lock Key	Description
Caps Lock	When Caps Lock is on, all alphabetic characters typed are in uppercase.
Num lock <Fn>+<F11>	When Num Lock is on, the embedded keypad is in numeric mode. The keys function as a calculator (complete with the arithmetic operators +, -, *, and /). Use this mode when you need to do a lot of numeric data entry. A better solution would be to connect an external keypad.
Scroll lock <Fn>+<F12>	When Scroll Lock is on, the screen moves one line up or down when you press the up or down arrow keys respectively. Scroll Lock does not work with some applications.









The embedded numeric keypad functions like a desktop numeric keypad. It is indicated by small characters located on the upper right corner of the keycaps. To simplify the keyboard legend, cursor-control key symbols are not printed on the keys.

Desired Access	Num Lock On	Num Lock Off
Number keys on embedded keypad	Type numbers in a normal manner.	
Cursor-control keys on embedded keypad	Hold <Shift> while using cursor-control keys.	Hold <Fn> while using cursor-control keys.

Desired Access	Num Lock On	Num Lock Off
Main keyboard keys	Hold <Fn> while typing letters on embedded keypad.	Type the letters in a normal manner.

Windows Keys

The keyboard has two keys that perform Windows-specific functions.

Key	Icon	Description
Windows key 		<p>Pressed alone, this key has the same effect as clicking on the Windows Start button; it launches the Start menu. It can also be used with other keys to provide a variety of function:</p> <ul style="list-style-type: none">  + <Tab> Activates next taskbar button.  + <E> Opens the My Computer window  + <F1> Opens Help and Support.  + <F> Opens the Find: All Files dialog box.  + <R> Opens the Run dialog box.  + M Minimizes all windows. <p><Shift>+  + <M> Undoes the minimize all windows action.</p>
 Application key		This key has the same effect as clicking the right mouse button; it opens the application's context menu.

Hot Keys

The computer employs hotkeys or key combinations to access most of the computer's controls like screen brightness, volume output and the BIOS utility.

To activate hot keys, press and hold the <Fn> key before pressing the other key in the hotkey combination.

Aspire 3620:



TravelMate 2420:



Hot Key	Icon	Function	Description
Fn-F1	?	Hot key help	Displays help on hot keys.
Fn-F2		Acer eSetting	Launches the Acer eSettings in Acer eManager.
Fn-F3		Acer ePowerManagement	Launches the Acer ePowerManagement in Acer eManager.
Fn-F4	Z ^z	Sleep	Puts the computer in Sleep mode.
Fn-F5		Display toggle	Switches display output between the display screen, external monitor (if connected) and both.
Fn-F6		Screen blank	Turns the display screen backlight off to save power. Press any key to return.
Fn-F7		Touchpad toggle	Turns the internal touchpad on and off.
Fn-F8		Speaker toggle	Turns the speakers on and off.
Fn-↑		Volume up	Increases the speaker volume.
Fn-↓		Volume down	Decreases the speaker volume.
Fn-☀		Brightness up	Increases the screen brightness.

Hot Key	Icon	Function	Description
Fn-☰		Brightness down	Decreases the screen brightness

Special Key

You can locate the Euro symbol and US dollar sign at the upper-center and/or bottom-right of your keyboard. To type:

Aspire 3620:



TravelMate 2420:

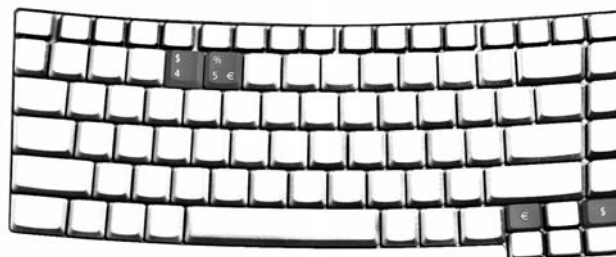

The Euro symbol

1. Open a text editor or word processor.
2. Either directly press the **<Euro>** symbol at the bottom-right of the keyboard, or hold **<Alt Gr>** and then press the **<5>** symbol at the upper-center of the keyboard.

The US dollar sign

1. Open a text editor or word processor.
2. Either directly press the **<Dollar>** key at the bottom-right of the keyboard, or hold **<Shift>** and then press the **<4>** key at the upper-center of the keyboard.

NOTE: This function varies by the operating system version.

NOTE: Some fonts and software do not support the Euro symbol. Please refer to www.microsoft.com/typography/faq/faq12.htm for more information.

Acer Empowering Technology

Acer's innovative Empowering Technology makes it easy for you to access frequently used functions and manage your new Acer notebook. It features the following handy utilities:

- Acer eDataSecurity Management** protects data with passwords and advanced encryption algorithms.
- Acer eLock Management** limits access to external storage media.
- Acer ePerformance Management** improves system performance by optimizing disk space, memory and registry settings.
- Acer eRecovery Management** backs up/recovers data flexibly, reliably and completely.
- Acer eSettings Management** accesses system information and adjusts settings easily.
- Acer ePower Management** extends battery power via versatile usage profiles.
- Acer ePresentation Management** connects to a projector and adjusts display settings conveniently.



For more information, press the < *e* > key to launch the Empowering Technology menu, then click on the appropriate utility and select the Help function.

Acer eDataSecurity Management

Acer eDataSecurity Management is handy file encryption utility that protects your files from being accessed by unauthorized persons. It is conveniently integrated with Windows explorer as a shell extension for quick and

easy data encryption/decryption and also supports on-the-fly file encryption for MSN Messenger and Microsoft Outlook.

There are two passwords that can be used to encrypt/decrypt a file; the supervisor password and the file-specific password. The supervisor password is a “master” password that can decrypt any file on your system; the file-specific password will be used to encrypt files by default, or you can choose to enter your own file-specific password when encrypting a file.

NOTE: The password used to encrypt a file is the unique key that the system needs to decrypt it. If you lose the password, the supervisor password is the only other key capable of decrypting the file. If you lose both passwords, there will be no way to decrypt your encrypted file! **Be sure to safeguard all related passwords!**



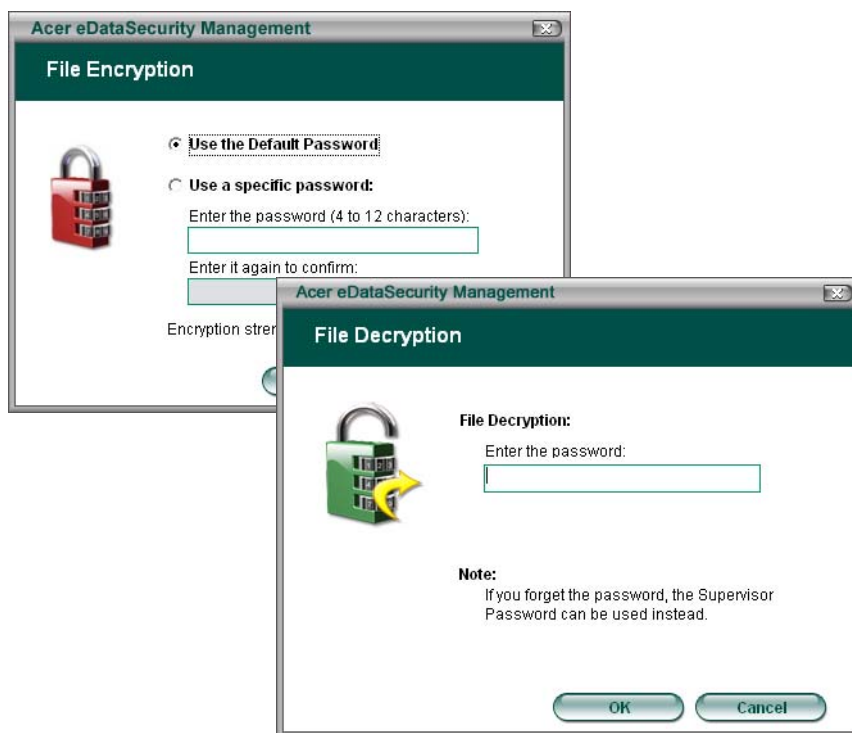

Acer eLock Management

Acer eLock Management is a security utility that allows you to lock up your removable data, optical and floppy drives to ensure that data can't be stolen while your notebook is unattended.

- Removable data devices - includes USB disk drives, USB pen drives, USB flash drives, USB MP3 drives, USB memory card readers, IEEE 1394 disk drives and any other removable disk drives that can be mounted as a file system when plugged into the system.
- Optical drive devices - includes any kind of CD-ROM or DVD-ROM drives.
- Floppy disk drives - 3.5-inch disks only.

To activate Acer eLock Management, a password must be set first. Once set, you may apply lock to any of the three kinds of devices. Lock(s) will immediately be set without any reboot necessary, and will remain locked after rebooting, until unlocked.

If you do not set a password, Acer eLock Management will reset back to the initial status with all locks removed.

NOTE: If you lose your password, there is no method to reset it except by reformatting your notebook or taking your notebook to an Acer Customer Service Center. Be sure to remember or write down your password.



Acer ePerformance Management

Acer ePerformance Management is a system optimization tool that boosts the performance of your Acer notebook. It provides you with the following options to enhance overall system performance:

- Memory optimization - releases unused memory and check usage.
- Disk optimization - removes unneeded items and files.
- Speed optimization - improves the usability and performance of your Windows XP system.



Acer eRecovery Management

Acer eRecovery Management is a powerful utility that does away with the need for recovery disks provided by the manufacturer. The Acer eRecovery Management utility occupies space in a hidden partition on your system's HDD. User-created backups are stored on D:\ drive. Acer eRecovery Management provides you with:

- Password protection.
- Recovery of applications and drivers.
- Image/data backup:
 - Back up to HDD (set recovery point).
 - Back up to CD/DVD.
- Image/data recovery tools:
 - Recover from a hidden partition (factory defaults).
 - Recover from the HDD (most recent user-defined recovery point).
 - Recover from CD/DVD.



NOTE: If your computer did not come with a Recovery CD or System CD, please use Acer eRecovery Management's "System backup to optical disk" feature to burn a backup image to CD or DVD. To ensure the best results when recovering your system using a CD or Acer eRecovery Management, detach all peripherals (except the external Acer ODD, if your computer has one), including your Acer ezDock.

Acer eSettings Management

Acer eSettings Management allows you to inspect hardware specifications and to monitor the system health status. Furthermore, Acer eSettings Management enables you to optimize your Windows operating system, so your computer runs faster, smoother and better.

Acer eSettings Management also:

- Provides a simple graphical user interface for navigating through the program effortlessly.
- Displays general system status and advanced monitoring for power users.
- Logs when a hardware component has been removed or replaced.
- Permits you to migrate personal settings.
- Keeps a history log of all alerts that were previously issued.



Acer ePower Management

Acer ePower Management features a straightforward user interface. To launch it, select Acer ePower Management from the Empowering Technology interface, or double-click the Acer ePower Management icon in the task tray.

Acer Mode

The default setting is “Maximum Performance.” You can adjust CPU speed, LCD brightness and other settings, or click on buttons to turn the following functions on/off: Wireless LAN, Bluetooth, CardBus, Memory Card, Audio, and Wired LAN.

DC Mode

To suit your usage, there are four pre-defined profiles - Entertainment, Presentation, Word Processing, and Maximum Battery. Or, you can define up to three of your own profiles.

Create new power scheme

1. Assign a name for the new scheme.
2. Choose existing scheme to use as a template.
3. Select whether used for mains (AC) or battery mode.
4. Choose which power options best fit your needs, then click OK.
5. The new profile will appear on the main screen.

Battery status

For real-time battery life estimates based on current usage, refer to the panel on the lower left-hand side of the window.

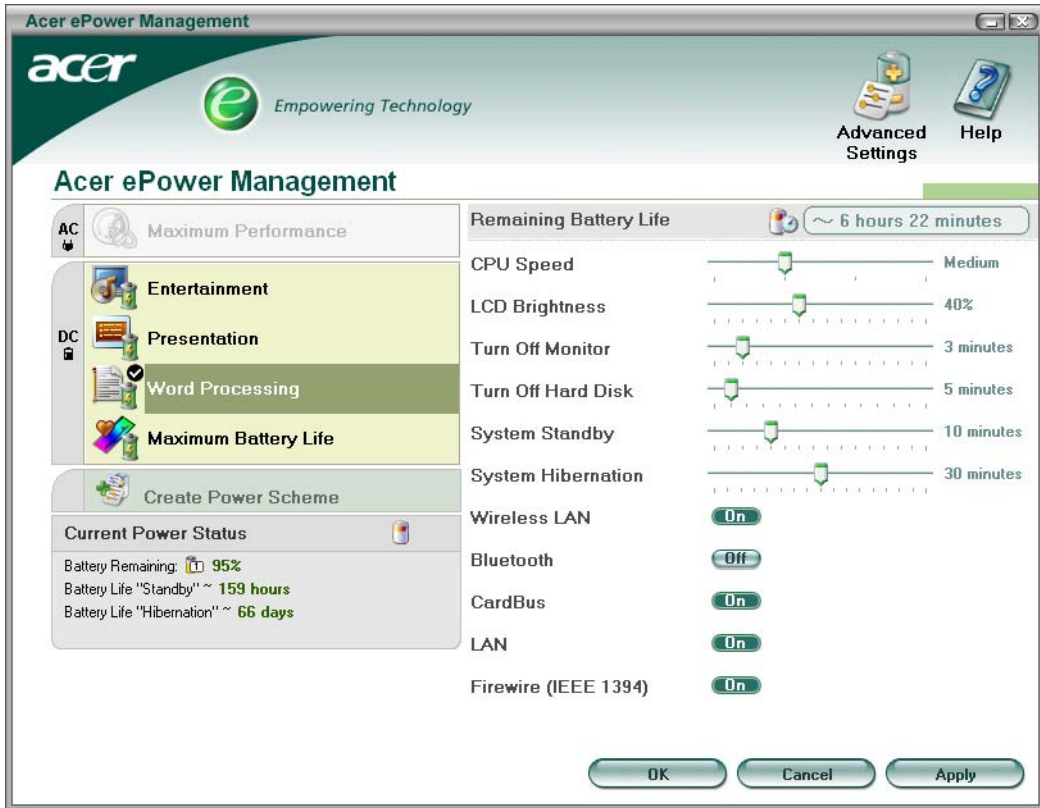

You can also click “Advanced Settings” to:

- Set alarms.
- Re-load factory defaults.
- Select what actions will be taken when the cover is closed, and set passwords for accessing the system after Hibernation or Standby.
- View information about Acer ePower Management.

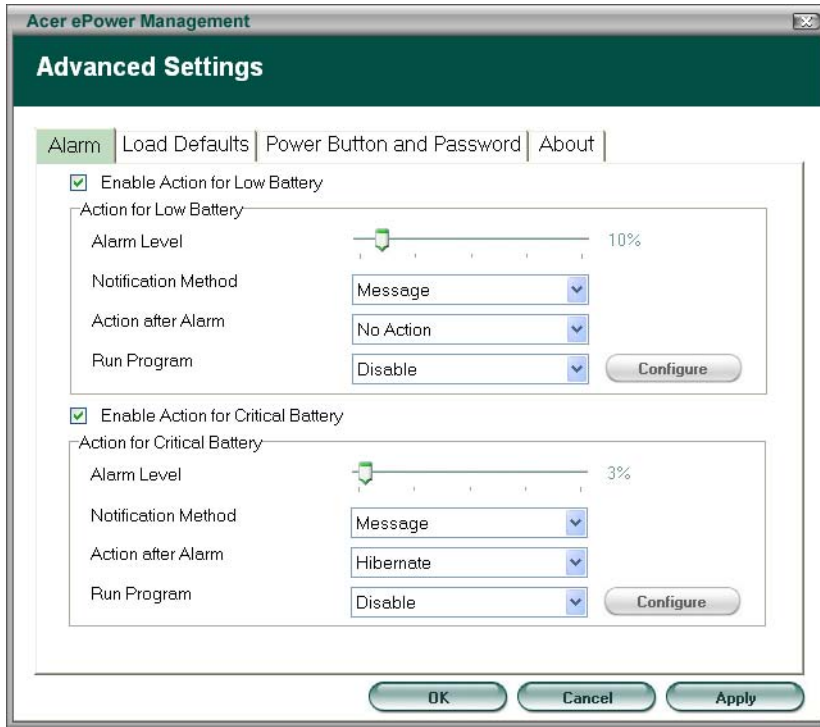

Acer ePresentation Management

Acer ePresentation Management lets you select from two of the most common projector resolutions: XGA and SVGA.

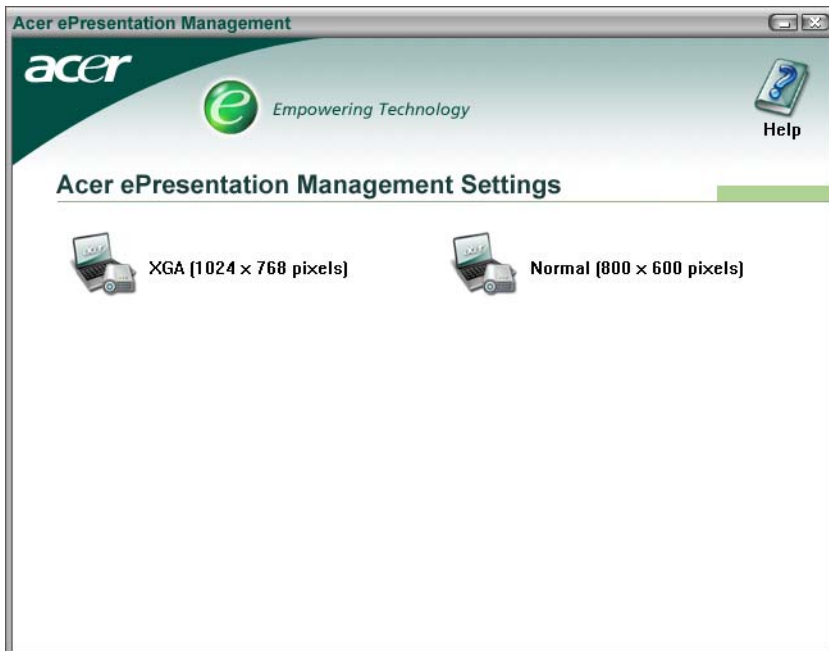

Hardware Specifications and Configurations

Processor

Item	Specification
CPU type	Intel® Pentium® M 725/730 Processor (2 MB L2 cache, 1.6GHz, 400/533 MHz FSB) Intel® Celeron M 370/380/390 Processor (1 MB L2 cache, 1.50/1.60/1.70GHz, 400MHz FSB)
Core logic	Intel® 910GML+ICH6M
CPU package	Intel socketable 478pin Micro-BGA
CPU core voltage	0.944~1.3V

BIOS

Item	Specification
BIOS vendor	Phneoix
BIOS Version	3A03
BIOS ROM type	PMC PM39LV040, 512KX8 CMOS Boot Block Flash Memory
BIOS ROM size	512KB Flash BIOS
BIOS package	32-pin PLCC
Supported protocols	ACPI 1.0b, PC Card 95, SM BIOS 2.3, IEEE1284-ECP/EPP, PCI 2.2, PnP 1.0a, DMI 2.0, PS/2 keyboard and mouse, USB 2.0, VGA BIOS, CD-ROM bootable, IEEE 1394
BIOS password control	Set by setup manual

Second Level Cache

Item	Specification
Cache controller	Built-in CPU
Cache size	2MB for Intel® Pentium® M 725A Processor 1MB for Intel® Celeron M 360/370/380 Processor
1st level cache control	Always enabled
2st level cache control	Always enabled
Cache scheme control	Fixed in write-back

System Memory

Item	Specification
Memory controller	Built-in Intel® 910GML
Memory size	0MB (no on-board memory)
DIMM socket number	2 sockets
Supports memory size per socket	1024MB
Supports maximum memory size	2G (by two 1024MB SO-DIMM module)
Supports DIMM type	DDR 2 Synchronous DRAM
Supports DIMM Speed	400 MHz
Supports DIMM voltage	1.8V and 0.9V
Supports DIMM package	200-pin soDIMM
Memory module combinations	You can install memory modules in any combinations as long as they match the above specifications.

Memory Combinations

Slot 1	Slot 2	Total Memory
0MB	128MB	128MB
0MB	256MB	256MB
0MB	512MB	512MB
0MB	1024MB	1024MB
128MB	128MB	256MB
128MB	256MB	384MB
128MB	512MB	640MB
128MB	1024MB	1152MB
256MB	128MB	384MB
256MB	256MB	512MB
256MB	512MB	768MB
256MB	1024MB	1280MB
512MB	128MB	640MB
512MB	256MB	768MB
512MB	512MB	1024MB
512MB	1024MB	1536MB
1024MB	0MB	1024MB
1024MB	128MB	1152MB
1024MB	256MB	1280MB
1024MB	512MB	1536MB
1024MB	1024MB	2048MB

NOTE: Above table lists some system memory configurations. You may combine DIMMs with various capacities to form other combinations. On above table, the configuration of slot 1 and slot 2 could be reversed.

LAN Interface

Item	Specification
Chipset	Realtek 8110CL
Supports LAN protocol	10/100Mbps
LAN connector type	RJ45
LAN connector location	Right side
Features	Integrated 10/100 BASE-T transceiver Wake on LAN support compliant with ACPI 2.0 PCI v2.2

Modem Interface

Item	Specification
Data modem data baud rate (bps)	56K
Supports modem protocol	V.92
Modem connector type	RJ11
Modem connector location	Right side

Bluetooth Interface

Item	Specification
Chipset	Built-in ICH6-M

Bluetooth Interface

Item	Specification
Data throughput	723 bps (full speed data rate)
Protocol	Bluetooth 1.1 (Upgradeable to Bluetooth 1.2 when SIG specification is ratified).
Interface	USB 1.1
Connector type	Mini-USB

Wireless Module 802.11b/g (optional device)

Item	Specification
Chipset	Built-in ICH6-M
Data throughput	11~54 Mbps
Protocol	802.11b+g
Interface	Mini-PCI type II (What does PCI Bus means on the system block diagram?)

Hard Disk Drive Interface

Item			
Vendor & Model Name	Seagate 40G ST9402112A Toshiba MK4025GAS Hitachi HTS421240H9AT00 WD WD400UE-22HCT0 Samsung M40MP0402H	Seagate ST96812A Seagate ST960821A Toshiba MK6025GAS HGST HTS541260H9AT00 WD WD600UE-22HCT0	TOSHIBA MK8025GAS HITACHI HTS421280H9AT00 SEAGATE ST9808210A SEAGATE ST98823A TOSHIBA MK8026GAX HGST HTS541280H9AT00 WD WD800UE-22HCT0
Capacity (MB)	40000	60000	80000
Bytes per sector	512	512	512
Data heads	2	3 (for Hitachi and Seagate) 4 (for Toshiba)	4 (for Hitachi) 3 (for Seagate)
Drive Format			
Disks	1	2	2
Spindle speed (RPM)	4200 RPM	4200 RPM	4200 RPM
Performance Specifications			
Buffer size	2048KB	8192KB	8192KB
Interface	ATA/ATAPI-6; ATA-6	ATA/ATAPI-6; ATA-6	ATA/ATA-6; ATA-6
Max. media transfer rate (disk-buffer, Mbytes/s)	372	350	350
Data transfer rate (host-buffer, Mbytes/s)	100 MB/Sec. Ultra DMA mode-5	100 MB/Sec. Ultra DMA mode-5	100 MB/Sec. Ultra DMA mode-5
DC Power Requirements			
Voltage tolerance	5V(DC) +/- 5%	5V(DC) +/- 5%	5V(DC) +/- 5%

Combo Drive Interface

Item	Specification	
Vendor & model name	DVD/CDRW HLDS GCC-4244N	
Performance Specification	With CD Diskette	With DVD Diskette
Transfer rate (KB/sec)	Sustained: Max 3.6Mbytes/sec	Sustained: Max 10.8Mbytes/sec
Buffer Memory	2MB	
Interface	Enhanced IDE(ATAPI) compatible	
Applicable disc format	DVD: DVD-ROM, (DVD-5, DVD-9, DVD-10, DVD-18),DVD-R (read, single border), DVD-RW, DVD-RAM (2.6GB, 4.7GB) CD: CD-DA, CD-ROM, CD-ROM XA, CD-R, CD-RW Photo (Multisession) Video CD, CD-Extra, (CD+), CD-test	
Loading mechanism	Load: Manual Release: (a) Electrical Release (Release Button) (b) Release by ATAPI command (c) Emergency Release	
Power Requirement		
Input Voltage	5 V +/- 5 % (Operating)	

DVD-Dual Interface

Item	Specification	
Vendor & model name	LITEON SOSW-833S PIONEER DVR-K16RA	
Performance Specification	With CD Diskette	With DVD Diskette
Transfer rate (KB/sec)	Sustained: Max 3.6Mbytes/sec	Sustained: Max 10.8Mbytes/sec
Buffer Memory	2MB	
Interface	Enhanced IDE(ATAPI) compatible	
Applicable disc format	Support disc formats 1. Reads data in each CD-ROM, CD-ROM XA, CD-1, Video CD, CD-Extra and CD-Text 2. Reads data in Photo CD (single and Multi-session) 3. Reads standard CD-DA 4. Reads and writes CD-R discs 5. Reads and writes CD-RW discs 6. Reads and writes in each dVD+R/RW (Ver. 1.1) 7. Reads data in each DVD-ROM and DVD-R (Ver. 2.0 for Authoring) 8. Reads and writes in each DVD-R (Ver. 2.0 for general), DVD-RW and DVD+R/RW (Ver1.1)	
Loading mechanism	Load: Manual Release: (a) Electrical Release (Release Button) (b) Release by ATAPI command (c) Emergency Release	
Power Requirement		
Input Voltage	5 V +/- 5 % (Operating)	

Audio Interface

Item	Specification
Audio Controller	ALC655
Audio onboard or optional	Built-in

Audio Interface

Item	Specification
Mono or Stereo	Stereo
Resolution	16 bit stereo digital to analog converter 16 bit stereo analog to digital converter
Compatibility	AC97
Mixed sound source	Line-in, CD
Voice channel	8/16-bit, mono/stereo
Sampling rate	44,1 KHz (48K byte for AC97 interface)
Internal microphone	Yes
Internal speaker / Quantity	Yes/2

Video Interface

Item	Specification
Chipset	Built-in Intel® 910GML
Package	35.5 mm x 40 mm 1257 pin mBGA
Interface	internal PCIE
Supports ZV (Zoomed Video) port	Yes

Video Memory

Item	Specification
Chipset	Built-in Intel® 910GML
Memory size	64MB/128MB
Interface	DDR2

USB Port

Item	Specification
Chipset	Built-in ICH6-M
USB Compliancy Level	2.0
OHCI	USB 1.1 and USB 2.0 Host controller
Number of USB port	3
Location	Three on the right side
Serial port function control	Enable/Disable by BIOS Setup

PCMCIA Port

Item	Specification
PCMCIA controller	ENE CB1410
Supports card type	Type-II
Number of slots	One type-II
Access location	Left panel
Supports ZV (Zoomed Video) port	No ZV support
Supports 32 bit CardBus	Yes

System Board Major Chips

Item	Controller
Core logic	Intel® 910GML+ICH6-M
VGA	Built in Intel®910GML
LAN	RealTek 8110CL
USB 2.0	Built in ICH6-M
Super I/O controller	This model does not employ Super I/O controller since it does not have FIR, IEEE 1394 function
MODEM	Built-in ICH6-M
Bluetooth	Built-in ICH6-M
Wireless 802.11 b+g	Built-in ICH6-M
PCMCIA	ENE CB1410
Audio	Realtek ALC655

Keyboard

Item	Specification
Keyboard controller	ENE KB 3910
Total number of keypads	88-/89-key
Windows logo key	Yes
Internal & external keyboard work simultaneously	Plug USB keyboard to the USB port directly: Yes

Battery

Item	Specification
Vendor & model name	Sanyo (6cell) 2.0 Sony (6cell) 2.0 Panasonic (6cell) 2.0 Snayo (6cell) 2.4 Sony (6cell) 2.4 Panasonic (6cell)2.4 Sanyo (9cell) 2.4
Battery Type	Li-ion
Pack capacity	4000 mAh forSanyo (6cell) 2.0 3920 mAh Sony (6cell) 2.0 3900 mAh Panasonic (6cell) 2.0 4800 mAh Snayo (6cell) 2.4 4800 mAh Sony (6cell) 2.4 4800 mAh Panasonic (6cell)2.4 Sanyo (9cell) 2.4
Number of battery cell	6/9
Package configuration	3 cells in series, 2 series in parallel 3 cells in series, 3 series in parallel
Normal voltage	14.8V
Charge voltage	16.8+-0.2v

LCD 14.1" inch

Item	Specification			
Vendor & model name	AU B141EW01	CMO N14111-L02	QDI QD14TL01-03	SAMSUNG LTN141W1-L01
Screen Diagonal (mm)	14.1 inches	14.1 inches	14.1 inches	14.1 inches
Active Area (mm)	304.1x228.1	304.1x228.1	304.1x228.1	
Display resolution (pixels)	1024x768 XGA	1024x768 XGA	1024x768 XGA	
Pixel Pitch	0.297x0.297	0.099x0.297	0.297x0.297	
Pixel Arrangement	R.G.B. Vertical Stripe	R.G.B. Vertical Stripe	R.G.B. Vertical Stripe	
Display Mode	Normally White	Normally White	Normally White	
Typical White Luminance (cd/m ²) also called Brightness	180 (5 point average) 150 (5 point average)	160	150	
Luminance Uniformity	N/A	N/A	70	
Contrast Ratio	300	300	250	
Response Time (Optical Rise Time/Fall Time)msec	24/11 15/35	8/17	10/25	
Nominal Input Voltage VDD	+3.3V Typ.	+3.3V	3.3V	
Typical Power Consumption (watt)	5.6/5.7	3.96	N/A	
Weight	550	570	600	
Physical Size(mm)	317.3x242.0x6.0	317.3x242.0x5.9	317.3x242.0x6.5	
Electrical Interface	1 channel LVDS	1 channel LVDS	1 channel LVDS	
Support Color	262K colors (RGB 6-bit data driver)	262,144	262,144	
Viewing Angle (degree) Horizontal: Right/Left Vertical: Upper/Lower	40/40 10/30	45/45 15/35	40/40 20/40	
Temperature Range(° C) Operating Storage (shipping)	0 to +50 -20 to +60	0 to +50 -25 to +60	0 to +50 -20 to +60	

LCD Inverter

Item	Specification
Vendor & model name	Darfon/V189-301GP
Brightness conditions	N/A
Input voltage (V)	9~21
Input current (mA)	2.56 (max)
Output voltage (V, rms)	780V (2000V for kick off)
Output current (mA, rms)	6.5 (max)
Output voltage frequency (k Hz)	65K Hz (max)

AC Adaptor

Item	Specification
Input rating	90V AC to 264V AC, 47Hz to 63Hz

AC Adaptor

Item	Specification
Maximum input AC current	1.7A
Inrush current	220A@115VAC 220A@230VAC
Efficiency	82% min. @115VAC input full load

System Power Management

ACPI mode	Power Management
Mech. Off (G3)	All devices in the system are turned off completely.
Soft Off (G2/S5)	OS initiated shutdown. All devices in the system are turned off completely.
Working (G0/S0)	Individual devices such as the CPU and hard disc may be power managed in this state.
Suspend to RAM (S3)	CPU set power down VGA Suspend PCMCIA Suspend Audio Power Down Hard Disk Power Down CD-ROM Power Down Super I/O Low Power mode
Save to Disk (S4)	Also called Hibernation Mode. System saves all system states and data onto the disc prior to power off the whole system.

System Utilities

BIOS Setup Utility

The BIOS Setup Utility is a hardware configuration program built into your computer's BIOS (Basic Input/Output System).

Your computer is already properly configured and optimized, and you do not need to run this utility. However, if you encounter configuration problems, you may need to run Setup. Please also refer to Chapter 4 Troubleshooting when problem arises.

To activate the BIOS Utility, press **F2** during POST (when "Press <F2> to enter Setup" message is prompted on the bottom of screen).

Press **F2** to enter setup. The default parameter of F12 Boot Menu is set to "disabled". If you want to change boot device without entering BIOS Setup Utility, please set the parameter to "enabled".

Press <F12> during POST to enter multi-boot menu. In this menu, user can change boot device without entering BIOS SETUP Utility.

PhoenixBIOS Setup Utility			
Information	Main	Security	Boot Exit
CPU Type :	Intel (R) Pentium (R) M processor 1.60GHz		
CPU Speed :	1600MHz		
HDD Model Name :	ST96812A - (PM)		
HDD Serial Number :	PIONEER DVD-RW DVR-K16RA		
ATAPI Model Name :	None		
ATAPI Serial Number :	None		
System BIOS Ver:	V0.05		
VGA BIOS Ver	1227		
KBC Ver	01.00		
Serial Number	xxxxxxxxxxxxxxxxxxxxxxxxxxxx		
Asset Tag Number	N/A		22 Byte
Produce Name	Aspire 3620/TravelMate 2420		32 Byte
Manufacturer Name:	Acer		16 Byte
UUID:	xxxxxxxxxxxxxxxxxxxxxxxxxxxx		16 Byte
			32 Byte
F1 Help	↑↓ Select Item	F5/F6 Change Values	F9 Setup Defaults
Esc Exit	←→ Select Menu	Enter Select ▶ Sub-Menu	F10 Save and Exit

Navigating the BIOS Utility

There are six menu options: Info., Main, System Devices, Security, Boot, and Exit.

Follow these instructions:

- ❑ To choose a menu, use the cursor left/right keys (← →).
- ❑ To choose a parameter, use the cursor up/down keys (↑ ↓).
- ❑ To change the value of a parameter, press F8 or F6.
- ❑ A plus sign (+) indicates the item has sub-items. Press ENTER to expand this item.
- ❑ Press ESC while you are in any of the menu options to go to the Exit menu.
- ❑ In any menu, you can load default settings by pressing F8. You can also press F6 to save any changes made and exit the BIOS Setup Utility.

NOTE: You can change the value of a parameter if it is enclosed in square brackets. Navigation keys for a particular menu are shown on the bottom of the screen. Help for parameters are found in the Item Specific Help part of the screen. Read this carefully when making changes to parameter values. **Please note that system information is subject to different models.**

Information

PhoenixBIOS Setup Utility

Information
Main
Security
Boot
Exit

```

CPU Type :           Intel (R) Pentium (R) M processor 1.60GHz
CPU Speed :          1600MHz
HDD Model Name :     ST96812A - (PM)
HDD Serial Number :  PIONEER DVD-RW DVR-K16RA
ATAPI Model Name :   None
ATAPI Serial Number : None
System BIOS Ver:     V0.05
VGA BIOS Ver         1227
KBC Ver              01.00
Serial Number         xxxxxxxxxxxxxxxxxxxxxxxxx
Asset Tag Number      N/A                               22 Byte
Produce Name          Aspire 3620/TravelMate 2420        32 Byte
Manufacturer Name:    Acer                               16 Byte
UUID:                 xxxxxxxxxxxxxxxxxxxxxxxxx          16 Byte
                                                              32 Byte
    
```

F1 Help
↑↓ Select Item
F5/F6 Change Values
F9 Setup Defaults
Esc Exit
←→ Select Menu
Enter Select ▶ Sub-Menu
F10 Save and Exit

NOTE: The system information is subject to different models.

Parameter	Description
CPU Type	This field shows the CPU type and speed of the system.
IDE1 Model Name	This field shows the model name of HDD installed on primary IDE master.
IDE1 Serial Number	This field displays the serial number of HDD installed on primary IDE master.
IDE2I Model Name	This field displays the mofel name of devices installed on secondary IDE master. The hard disk drive or optical drive model name is automatically detected by the system.
IDE2 Serial Number	This field shows the serial number of devices installed on secondary IDE master.
System BIOS ver	Displays system BIOS version.
VGA BIOS Ver	This field displays the VGA firmware version of the system.
KBC Ver	This field shows the keyboard
Serial Number	This field displays the serial number of this unit.
Asset Tag Number	This field displays the asset tag number of the system.
Product Name	This field shows product name of the system.
Manufacturer Name	This field displays the manufacturer of this system.
UUID Number	This will be visible only when an internal LAN device is presenting. UUID=32bytes

Main

The Main screen displays a summary of your computer hardware information, and also includes basic setup parameters. It allows the user to specify standard IBM PC AT system parameters.

PhoenixBIOS Setup Utility				
Information	Main	Security	Boot	Exit
				Item Specific Help
System Time:	[09:03:49]			<Tab>, <Shift-Tab>, or <Enter> selects field.
System Date:	[11/29/2005]			
System Memory:	640 KB	Shows system base memory size		
Extended Memory:	510 MB	Shows extended memory size		
Video Memory	[128MB]	VGA memory size		
Quiet Boot:	[Enabled]			
Power on display:	[Auto]			
Network boot	[Enabled]			
F12 Boot Menu	[Disabled]			
D2D Recovery	[Enabled]			
F1 Help	↑↓ Select Item	F5/F6 Change Values	F9 Setup Defaults	
Esc Exit	←→ Select Menu	Enter Select	▶ Sub-Menu	F10 Save and Exit

NOTE: The screen above is for your reference only. Actual values may differ.

The table below describes the parameters in this screen. Settings in **boldface** are the default and suggested parameter settings.

Parameter	Description	Format/Option
System Time	Sets the system time. The hours are displayed with 24-hour format.	Format: HH:MM:SS (hour:minute:second) System Time
System Date	Sets the system date.	Format MM/DD/YYYY (month/day/year) System Date
System Memory	This field reports the memory size of the system. Memory size is fixed to 640MB	
Extended Memory	This field reports the memory size of the extended memory in the system. Extended Memory size=Total memory size-1MB	
VGA Memory	Shows the VGA memory size. VGA Memory size=64/128MB	
Quiet Boot	Determines if Customer Logo will be displayed or not; shows Summary Screen is disabled or enabled. Enabled: Customer Logo is displayed, and Summary Screen is disabled. Disabled: Customer Logo is not displayed, and Summary Screen is enabled.	Option: Enabled or Disabled
Power on display	Auto: During power process, the system will detect if any display device is connected on external video port. If any external display device is connected, the power on display will be in CRT (or projector) only mode. Otherwise it will be in LCD only mode. Both: Simultaneously enable both the integrated LCD screen and the system's external video port (for an external CRT or projector).	Option: Auto or Both
Network Boot	Enables, disables the system boot from LAN (remote server).	Option: Enabled or Disabled
F12 Boot Menu	Enables, disables Boot Menu during POST.	Option: Disabled or Enabled
D2D Recovery	Enables, disables D2D Recovery function. The function allows the user to create a hidden partition on hard disc drive to store operation system and restore the system to factory defaults.	Option: Enabled or Disabled

NOTE: The sub-items under each device will not be shown if the device control is set to disable or auto. This is because the user is not allowed to control the settings in these cases.

Security

The Security screen contains parameters that help safeguard and protect your computer from unauthorized use.

PhoenixBIOS Setup Utility			
Information	Main	Security	Boot Exit
User Password is : Clear Supervisor Password is : Clear			Item Specific Help Supervisor Password controls accesses of the whole setup utility. It can be used to boot up when Password on boot is enabled.
Set User Password [Enter] Set Supervisor Password [Enter]			
Primary HardDisk Security [Disabled]			
Password on Boot [Disabled]			
F1 Help	↑ ↓ Select Item	F5/F6 Change Values	F9 Setup Defaults
Esc Exit	← → Select Menu	Enter Select ▶ Sub-Menu	F10 Save and Exit

The table below describes the parameters in this screen. Settings in **boldface** are the default and suggested parameter settings.

Parameter	Description	Option
User Password is	Shows the setting of the user password.	Clear or Set
Supervisor Password is	Shows the setting of the Supervisor password	Clear or Set
Set User Password	Press Enter to set the user password. When user password is set, this password protects the BIOS Setup Utility from unauthorized access. The user can enter Setup menu only and does not have right to change the value of parameters.	
Set Supervisor Password	Press Enter to set the supervisor password. When set, this password protects the BIOS Setup Utility from unauthorized access. The user can not either enter the Setup menu nor change the value of parameters.	
Primary HardDisk Security	Enables or disables primary hard disk security function.	
Password on Boot	Defines whether a password is required or not while the events defined in this group happened. The following sub-options are all requires the Supervisor password for changes and should be grayed out if the user password was used to enter setup.	Disabled or Enabled

NOTE: When you are prompted to enter a password, you have three tries before the system halts. Don't forget your password. If you forget your password, you may have to return your notebook computer to your dealer to reset it.

Setting a Password

Follow these steps as you set the user or the supervisor password:

1. Use the **↑** and **↓** keys to highlight the Set Supervisor Password parameter and press the **ENTER** key. The Set Supervisor Password box appears:

Set Supervisor Password

Enter New Password []

Confirm New Password []

2. Type a password in the "Enter New Password" field. The password length can not exceeds 8 alphanumeric characters (A-Z, a-z, 0-9, not case sensitive). Retype the password in the "Confirm New Password" field.

IMPORTANT: Be very careful when typing your password because the characters do not appear on the screen.

3. Press **ENTER**.
4. After setting the password, the computer sets the User Password parameter to "Set".
4. If desired, you can opt to enable the Password on boot parameter.
5. When you are done, press **F10** to save the changes and exit the BIOS Setup Utility.

Removing a Password

Follow these steps:

1. Use the **↑** and **↓** keys to highlight the Set Supervisor Password parameter and press the **ENTER** key. The Set Password box appears:

Set Supervisor Password		
Enter current password	[]
Enter New Password	[]
Confirm New Password	[]

2. Type the current password in the Enter Current Password field and press **ENTER**.
3. Press **ENTER** twice **without** typing anything in the Enter New Password and Confirm New Password fields. The computer then sets the Supervisor Password parameter to “Clear”.
4. When you have changed the settings, press **F10** to save the changes and exit the BIOS Setup Utility.

Changing a Password

1. Use the **↑** and **↓** keys to highlight the Set Supervisor Password parameter and press the **ENTER** key. The Set Password box appears:

Set Supervisor Password		
Enter current password	[]
Enter New Password	[]
Confirm New Password	[]

2. Type the current password in the Enter Current Password field and press **ENTER**.
3. Type a password in the Enter New Password field. Retype the password in the Confirm New Password field.
4. Press **ENTER**. After setting the password, the computer sets the User Password parameter to “Set”.
5. If desired, you can enable the Password on boot parameter.
6. When you are done, press **F10** to save the changes and exit the BIOS Setup Utility.

If the verification is OK, the screen will display as following.

Setup Notice
Changes have been saved.
[continue]

The password setting is complete after the user presses **F10**.

If the current password entered does not match the actual current password, the screen will show you the Setup Warning.

Setup Warning
Invalid password
Re-enter Password
[continue]

If the new password and confirm new password strings do not match, the screen will display the following message.

Setup Warning
Password do not match
Re-enter Password

Boot

This menu allows the user to decide the order of boot devices to load the operating system. Bootable devices includes the distette drive in module bay, the onboard hard disk drive and the CD-ROM in module bay.

PhoenixBIOS Setup Utility				
Information	Main	Security	Boot	Exit
+Hard Drive Floppy Devices CD-ROM/DVD Drive Network Boot			Item Specific Help	
			Keys used to view or configure devices: <Enter> to expands or collapses devices with a + or - <F5> and <F6> moves the device up or down.	
F1 Help	↑↓ Select Item	F5/F6 Change Values	F9 Setup Defaults	
Esc Exit	←→ Select Menu	Enter Select ▶ Sub-Menu	F10 Save and Exit	

Exit

The Exit screen contains parameters that help safeguard and protect your computer from unauthorized use.

PhoenixBIOS Setup Utility

Information Main Security Boot Exit

Exit Saving Changes
Exit Discarding Changes
Load Setup Defaults
Discard Changes
Save Changes

Item Specific Help

Exit System Setup and save your changes to CMOS.

F1 Help ↑↓ Select Item F5/F6 Change Values F9 Setup Defaults
Esc Exit ←→ Select Menu Enter Select F10 Save and Exit

The table below describes the parameters in this screen.

Parameter	Description
Exit Saving Changes	Exit System Setup and save your changes to CMOS.
Exit Discarding Changes	Exit utility without saving setup data to CMOS.
Load Setup Default	Load default values for all SETUP item.
Discard Changes	Load previous values from CMOS for all SETUP items.
Save Changes	Save Setup Data to CMOS.

BIOS Flash Utility

The BIOS flash memory update is required for the following conditions:

- New versions of system programs
- New features or options
- Restore a BIOS when it becomes corrupted.

Use the Phlash utility to update the system BIOS flash ROM.

NOTE: If you do not have a crisis recovery diskette at hand, then you should create a **Crisis Recovery Diskette** before you use the Phlash utility.

NOTE: Do not install memory-related drivers (XMS, EMS, DPMS) when you use the Phlash.

NOTE: Please use the AC adaptor power supply when you run the Phlash utility. If the battery pack does not contain enough power to finish BIOS flash, you may not boot the system because the BIOS is not completely loaded.

Follow the steps below to run the Phlash.

1. Prepare a bootable diskette.
2. Copy the flash utilities to the bootable diskette.
3. Then boot the system from the bootable diskette. The flash utility has auto-execution function.

Machine Disassembly and Replacement

This chapter contains step-by-step procedures on how to disassemble the notebook computer for maintenance and troubleshooting.

To disassemble the computer, you need the following tools:

- Wrist grounding strap and conductive mat for preventing electrostatic discharge
- Small Philips screw driver
- Philips screwdriver
- Plastic flat head screw driver
- Tweezers

NOTE: The screws for the different components vary in size. During the disassembly process, group the screws with the corresponding components to avoid mismatch when putting back the components. When you remove the stripe cover, please be careful not to scrape the cover.

General Information

Before You Begin

Before proceeding with the disassembly procedure, make sure that you do the following:

1. Turn off the power to the system and all peripherals.
2. Unplug the AC adapter and all power and signal cables from the system.
3. Remove the battery pack.

Disassembly Procedure Flowchart

The flowchart on the succeeding page gives you a graphic representation on the entire disassembly sequence and instructs you on the components that need to be removed during servicing. For example, if you want to remove the system board, you must first remove the keyboard, then disassemble the inside assembly frame in that order.

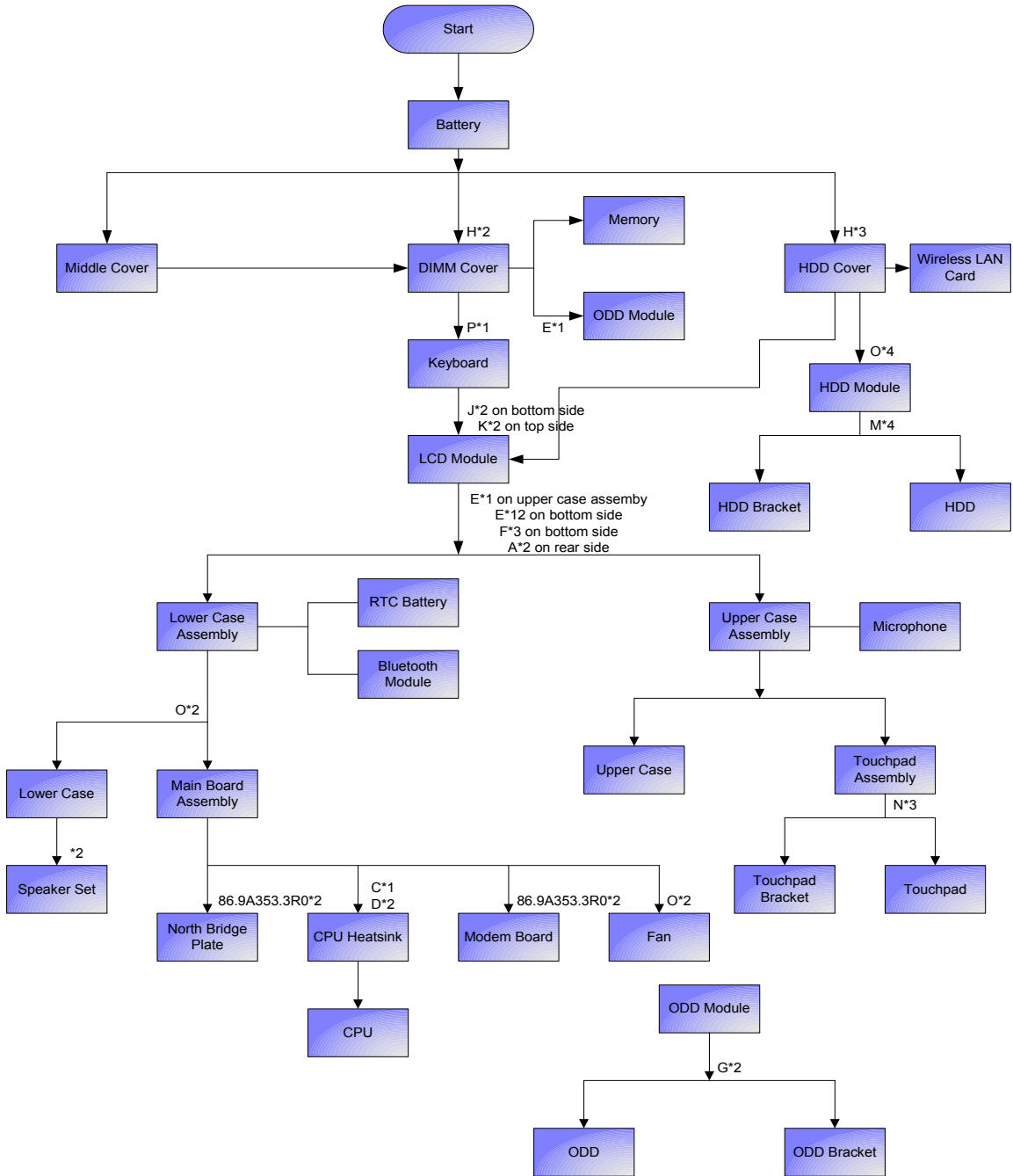

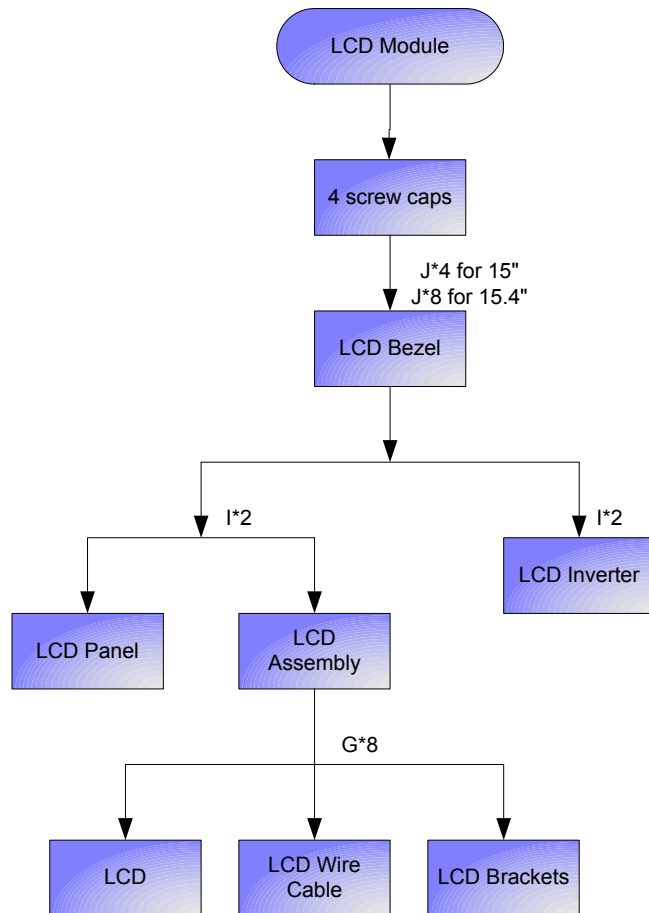

Screw List

Item	Description	Part Number
A	SCW HEX NYL I#R-40/O#4-40 L5.5	34.00015.081
B	SCREW MACH WAFER M2*L4 NI	86.00059.220 (PC Card slot x4)
C	CPU SCREW M2.5*4.3L (2.3 KG)	86.00D01.230
D	CPU SCREW M2.5*4.3L (1.55 KG)	86.00D02.230
E	SCREW M2.5-6	86.9A323.6R0
F	SCRW M2.5*L8(NON NYLOK)	86.9A323.8R0
G	SCREW M2*3 NYLON 1JMCPC-420325	86.9A352.3R0
H	SCREW	86.9A352.4R0
I	SCREW M2.5*4L(NYLOCK)BLACK ZN	86.9A353.4R0
J	SCREW M2.5X6	86.9A353.6R0
K	SRW M2.5*8L B/ZN NYLOK 700	86.9A353.8R0
L	SCRW M2.5*L3(NON NYLOK)	86.9A523.3R0
M	SCREW M3x4(86.9A524.4R0)	86.9A524.4R0
N	SCREW WAFER NYLOK NI 2ML3	86.9A552.3R0
O	SCRW M2*4 WAFER NI	86.9A552.4R0
P	SCRW M2.5*3 WAFER NI	86.9A553.3R0

Removing the Battery Pack

1. Unlock the battery lock.
2. Slide the battery latch then remove the battery.



Removing the Wireless LAN Card/the HDD Module/the Memory/the ODD Module and the LCD Module

Removing the Memory and the HDD Module

1. Remove the five screws fastening the DIMM cover.
2. Detach the DIMM cover carefully.



3. Pop out the memory carefully.
4. Disconnect wireless main and auxiliary antenna from the wireless LAN card.
5. Pop out the wireless LAN card and remove it.



6. Remove the three screws fastening the HDD cover.
7. Detach the HDD cover from the main unit.



8. Remove the four screws fastening the HDD module.
9. Then detach the HDD module carefully.



Removing the ODD Module

1. First, remove the screw fastening the ODD module as shown.
2. Push the ODD module outwards then remove it.



Removing the LCD Module

1. Detach the middle cover from the main unit carefully.
2. Disconnect the launch board FFC from the launch board.



3. Remove the middle cover (with launch board and microphone) from the main unit.
4. Disconnect the microphone cable from the launch board.



5. Take out the microphone from the middle cover.
6. Remove the two screws fastening the launch board.
7. Then remove the launch board from the middle cover.



8. Remove the screw holding the keyboard.
9. Turn over the keyboard as shown.
10. Disconnect the keyboard cable.



11. Remove the keyboard from the main unit.
12. Tear off the tapes fastening the wireless antenna cable.



13. Pull the antenna set from the main unit.
14. Disconnect the LCD cable.
15. Turn over the notebook then remove two screws fastening the LCD module.



16. Remove two screws fastening the LCD hinges.
17. Then detach the LCD module from the main unit.



Disassembling the Main Unit

Separate the Main Unit Into the Upper and the Lower Case Assembly

1. Disconnect the touchpad cable and the LED FFC from the main board.
2. Remove the 15 screws on the bottom as shown.
3. Detach the upper case assembly from the lower case assembly carefully.

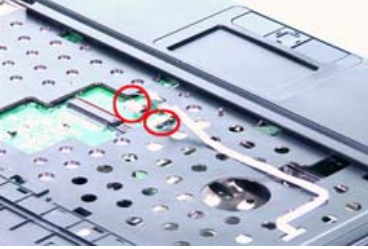

Disassembling the Lower Case Assembly

4. Turn over the lower case assembly to the bottom side, then disconnect the fan cable.
5. Turn over the lower case assembly to the front side, then detach the bluetooth module.



6. Disconnect the Bluetooth cable from the main board.
7. Disconnect the Bluetooth cable from the Bluetooth module as shown.



8. Disconnect the speaker set cable from the main board.
9. Remove the four screws fastening the main board to the lower case.
10. Detach the main board from the lower case carefully.



11. Remove the two screws holding the speaker set.
12. Take out the speaker set from the lower case.



13. Remove the three screws fastening the system fan.
14. Detach the fan from the lower case.



15. Disconnect the RTC battery cable then detach the RTC battery.
16. Disconnect the launch board FFC from the main board.



17. Disconnect the modem cable from the main board.
18. Disconnect the modem board from the main board.
19. Disconnect the modem cable from the modem board as shown.

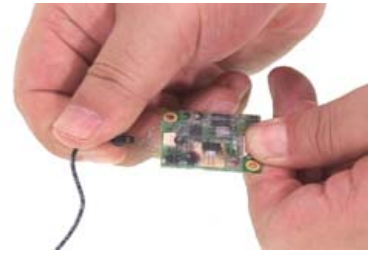

20. Remove the five screws fastening the heatsink.
21. Remove the heatsink from the main board.



22. Use a flat-headed screwdriver to release the CPU socket lock.
23. Remove the CPU from the CPU socket carefully.



Disassembling the Upper Case Assembly

1. Remove the two screws fastening the LED board.
2. The remove the LED board from the upper case assembly carefully.

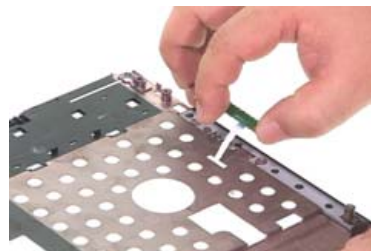

3. Disconnect the LED board FFC from the LED board.
4. Disconnect the touchpad FFC then remove it.

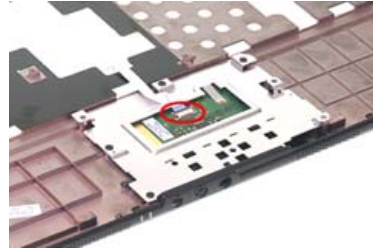

5. Remove the four screws fastening the touchpad bracket.
6. Remove the touchpad bracket (with touchpad).
7. Detach the touchpad from the touchpad bracket.

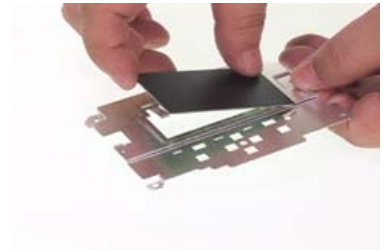
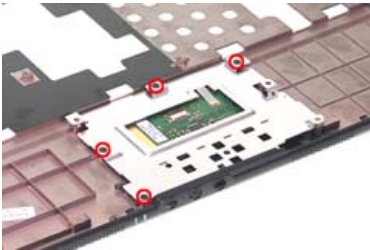

Disassembling the LCD Module

1. Remove the four screw caps as shown.
2. Remove the four screws holding the LCD bezel.
3. Then detach the LCD bezel from the LCD module.



4. Remove the two screws fastening the LCD inverter.
5. Take out the LCD inverter from the LCD cover, then disconnect the LCD cable from the inverter.
6. Remove the two screws holding the LCD to the LCD panel.

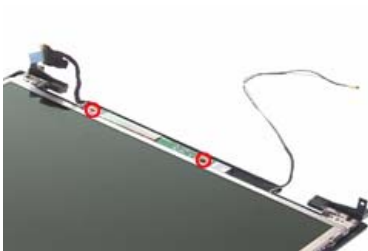

7. Remove the LCD assembly from the LCD panel as shown.
8. Remove the two screws fastening the wireless antenna set.
9. Detach the wireless antenna set from the LCD panel on one side.



10. Detach the wireless antenna set on the other side.
11. Remove the two screws fastening the LCD hinges.
12. Then remove the LCD hinges from the LCD panel.

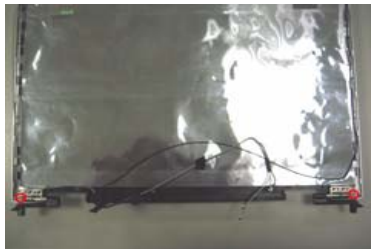

13. Tear off the tape fastening the LCD cable.
14. Disconnect the LCD cable from the LCD.
15. Tear off another tape holding the LCD cable.



16. Remove the four screws fastening the LCD right bracket.
17. Remove the right bracket from the LCD.

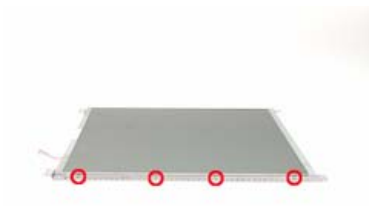

18. Remove the four screws fastening the LCD left bracket.
19. Remove the left bracket from the LCD.

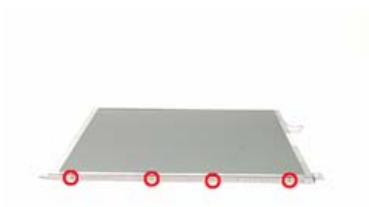

Disassembling the External Modules

Disassembling the HDD Module

1. Remove the four screws fastening the HDD bracket.
2. Remove the HDD bracket.

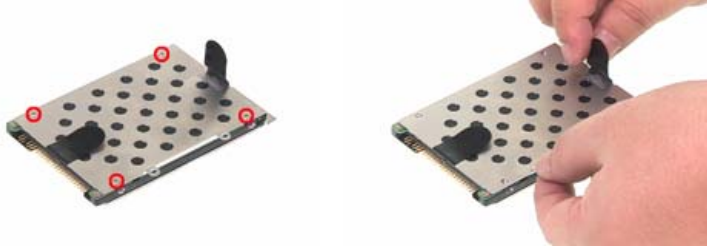

Disassembling the ODD Module

1. Remove the two screws holding the ODD fix holder bracket.
2. Then remove the ODD fix holder bracket.
3. Remove the two screws fastening the ODD rail bracket then remove the rail bracket.

Troubleshooting

Use the following procedure as a guide for computer problems.

NOTE: The diagnostic tests are intended to test only Acer products. Non-Acer products, prototype cards, or modified options can give false errors and invalid system responses.

1. Obtain the failing symptoms in as much detail as possible.
2. Verify the symptoms by attempting to re-create the failure by running the diagnostic test or by repeating the same operation.
3. Use the following table with the verified symptom to determine which page to go to.

Symptoms (Verified)	Go To
Power failure. (The power indicator does not go on or stay on.)	"Power System Check" on page 67.
POST does not complete. No beep or error codes are indicated.	"Power-On Self-Test (POST) Error Message" on page 70 "Undetermined Problems" on page 82
POST detects an error and displayed messages on screen.	"Error Message List" on page 71
Other symptoms (i.e. LCD display problems or others).	"Power-On Self-Test (POST) Error Message" on page 70
Symptoms cannot be re-created (intermittent problems).	Use the customer-reported symptoms and go to "Power-On Self-Test (POST) Error Message" on page 70 "Intermittent Problems" on page 81 "Undetermined Problems" on page 82

System Check Procedures

External Diskette Drive Check

Do the following to isolate the problem to a controller, driver, or diskette. A write-enabled, diagnostic diskette is required.

NOTE: Make sure that the diskette does not have more than one label attached to it. Multiple labels can cause damage to the drive or cause the drive to fail.

Do the following to select the test device.

1. Boot from the diagnostics diskette and start the diagnostics program.
2. See if FDD Test is passed as the program runs to FDD Test.
3. Follow the instructions in the message window.

If an error occurs with the internal diskette drive, reconnect the diskette connector on the system board.

If the error still remains:

1. Reconnect the external diskette drive/DVD-ROM module.
2. Replace the external diskette drive/CD-ROM module.
3. Replace the main board.

External CD-ROM Drive Check

Do the following to isolate the problem to a controller, drive, or CD-ROM. Make sure that the CD-ROM does not have any label attached to it. The label can cause damage to the drive or can cause the drive to fail.

Do the following to select the test device:

1. Boot from the diagnostics diskette and start the diagnostics program.
2. See if CD-ROM Test is passed when the program runs to CD-ROM Test.
3. Follow the instructions in the message window.

If an error occurs, reconnect the connector on the System board. If the error still remains:

1. Reconnect the external diskette drive/CD-ROM module.
2. Replace the external diskette drive/CD-ROM module.
3. Replace the main board.

Keyboard or Auxiliary Input Device Check

Remove the external keyboard if the internal keyboard is to be tested.

If the internal keyboard does not work or an unexpected character appears, make sure that the flexible cable extending from the keyboard is correctly seated in the connector on the system board.

If the keyboard cable connection is correct, run the Keyboard Test.

If the tests detect a keyboard problem, do the following one at a time to correct the problem. Do not replace a non-defective FRU:

1. Reconnect the keyboard cables.
2. Replace the keyboard.
3. Replace the main board.

The following auxiliary input devices are supported by this computer:

- Numeric keypad
- External keyboard

If any of these devices do not work, reconnect the cable connector and repeat the failing operation.

Memory check

Memory errors might stop system operations, show error messages on the screen, or hang the system.

1. Boot from the diagnostics diskette and start the doagmpstotics program (please refer to main board).
2. Go to the diagnostic memory in the test items.
3. Press F2 in the test items.
4. Follow the instructions in the message window.

NOTE: Make sure that the DIMM is fully installed into the connector. A loose connection can cause an error.

Power System Check

To verify the symptom of the problem, power on the computer using each of the following power sources:

1. Remove the battery pack.
2. Connect the power adapter and check that power is supplied.
3. Disconnect the power adapter and install the charged battery pack; then check that power is supplied by the battery pack.

If you suspect a power problem, see the appropriate power supply check in the following list:

- “Check the Power Adapter” on page 68
- “Check the Battery Pack” on page 69

Check the Power Adapter

Unplug the power adapter cable from the computer and measure the output voltage at the plug of the power adapter cable. See the following figure

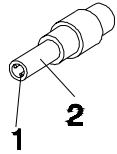

Pin 1: +19 to +20.5V
Pin 2: 0V, Ground

1. If the voltage is not correct, replace the power adapter.
2. If the voltage is within the range, do the following:
 - Replace the System board.
 - If the problem is not corrected, see “Undetermined Problems” on page 82.
 - If the voltage is not correct, go to the next step.

NOTE: An audible noise from the power adapter does not always indicate a defect.

3. If the power-on indicator does not light up, check the power cord of the power adapter for correct continuity and installation.
4. If the operational charge does not work, see “Check the Battery Pack” on page 69.

Check the Battery Pack

To check the battery pack, do the following:

From Software:

1. Check out the Power Management in control Panel
2. In Power Meter, confirm that if the parameters shown in the screen for Current Power Source and Total Battery Power Remaining are correct.
3. Repeat the steps 1 and 2, for both battery and adapter.
4. This helps you identify first the problem is on recharging or discharging.

From Hardware:

1. Power off the computer.
2. Remove the battery pack and measure the voltage between battery terminals 1(+) and 6(ground). See the following figure

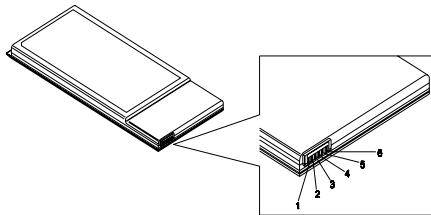

3. If the voltage is still less than 7.5 Vdc after recharging, replace the battery.

To check the battery charge operation, use a discharged battery pack or a battery pack that has less than 50% of the total power remaining when installed in the computer.

If the battery status indicator does not light up, remove the battery pack and let it return to room temperature. Re-install the battery pack.

If the charge indicator still does not light up, replace the battery pack. If the charge indicator still does not light up, replace the DC/DC charger board.

Touchpad Check

If the touchpad doesn't work, do the following actions one at a time to correct the problem. Do not replace a non-defective FRU:

1. Reconnect the touchpad cables.
2. Replace the touchpad.
3. Replace the system board.

After you use the touchpad, the pointer drifts on the screen for a short time. This self-acting pointer movement can occur when a slight, steady pressure is applied to the touchpad pointer. This symptom is not a hardware problem. No service actions are necessary if the pointer movement stops in a short period of time.

Power-On Self-Test (POST) Error Message

The POST error message index lists the error message and their possible causes. The most likely cause is listed first.

NOTE: Perform the FRU replacement or actions in the sequence shown in FRU/Action column, if the FRU replacement does not solve the problem, put the original part back in the computer. Do not replace a non-defective FRU.

This index can also help you determine the next possible FRU to be replaced when servicing a computer.

If the symptom is not listed, see “Undetermined Problems” on page 82.

The following lists the error messages that the BIOS displays on the screen and the error symptoms classified by function.

NOTE: Most of the error messages occur during POST. Some of them display information about a hardware device, e.g., the amount of memory installed. Others may indicate a problem with a device, such as the way it has been configured.

NOTE: If the system fails after you make changes in the BIOS Setup Utility menus, reset the computer, enter Setup and install Setup defaults or correct the error.

Index of Error Messages

Error Code List

Error Codes	Error Messages
006	Equipment Configuration Error Causes: 1. CPU BIOS Update Code Mismatch 2. IDE Primary Channel Master Drive Error (The causes will be shown before "Equipment Configuration Error")
010	Memory Error at xxxx:xxxx:xxxxh (R:xxxxh, W:xxxxh)
070	Real Time Clock Error
071	CMOS Battery Bad
072	CMOS Checksum Error
110	System disabled. Incorrect password is specified.
<No error code>	Battery critical LOW In this situation BIOS will issue 4 short beeps then shut down system, no message will show.
<No error code>	Thermal critical High In this situation BIOS will shut down system, not show message.

Error Message List

Error Messages	FRU/Action in Sequence
Failure Fixed Disk	Reconnect hard disk drive connector. "Load Default Settings" in BIOS Setup Utility. Hard disk drive System board
Stuck Key	see "Keyboard or Auxiliary Input Device Check" on page 66.
Keyboard error	see "Keyboard or Auxiliary Input Device Check" on page 66.
Keyboard Controller Failed	see "Keyboard or Auxiliary Input Device Check" on page 66.
Keyboard locked - Unlock key switch	Unlock external keyboard
Monitor type does not match CMOS - Run Setup	Run "Load Default Settings" in BIOS Setup Utility.
Shadow RAM Failed at offset: nnnn	BIOS ROM System board
System RAM Failed at offset: nnnn	DIMM System board
Extended RAM Failed at offset: nnnn	DIMM System board
System battery is dead - Replace and run Setup	Replace RTC battery and Run BIOS Setup Utility to reconfigure system time, then reboot system.
System CMOS checksum bad - Default configuration used	RTC battery Run BIOS Setup Utility to reconfigure system time, then reboot system.
System timer error	RTC battery Run BIOS Setup Utility to reconfigure system time, then reboot system. System board

Error Message List

Error Messages	FRU/Action in Sequence
Real time clock error	RTC battery Run BIOS Setup Utility to reconfigure system time, then reboot system. System board
Previous boot incomplete - Default configuration used	Run "Load Default Settings" in BIOS Setup Utility. RTC battery System board
Memory size found by POST differed from CMOS	Run "Load Default Settings" in BIOS Setup Utility. DIMM System board
Diskette drive A error	Check the drive is defined with the proper diskette type in BIOS Setup Utility See "External Diskette Drive Check" on page 66.
Incorrect Drive A type - run SETUP	Check the drive is defined with the proper diskette type in BIOS Setup Utility
System cache error - Cache disabled	System board
CPU ID:	System board
DMA Test Failed	DIMM System board
Software NMI Failed	DIMM System board
Fail-Safe Timer NMI Failed	DIMM System board
Device Address Conflict	Run "Load Default Settings" in BIOS Setup Utility. RTC battery System board
Allocation Error for device	Run "Load Default Settings" in BIOS Setup Utility. RTC battery System board
Failing Bits: nnnn	DIMM BIOS ROM System board
Fixed Disk n	None
Invalid System Configuration Data	BIOS ROM System board
I/O device IRQ conflict	Run "Load Default Settings" in BIOS Setup Utility. RTC battery System board
Operating system not found	Enter Setup and see if fixed disk and drive A: are properly identified. Diskette drive Hard disk drive System board

Error Message List

No beep Error Messages	FRU/Action in Sequence
No beep, power-on indicator turns off and LCD is blank.	Power source (battery pack and power adapter). See "Power System Check" on page 67.. Ensure every connector is connected tightly and correctly. Reconnect the DIMM. LED board. System board.
No beep, power-on indicator turns on and LCD is blank.	Power source (battery pack and power adapter). See "Power System Check" on page 67.. Reconnect the LCD connector Hard disk drive LCD inverter ID LCD cable LCD Inverter LCD System board
No beep, power-on indicator turns on and LCD is blank. But you can see POST on an external CRT.	Reconnect the LCD connectors. LCD inverter ID LCD cable LCD inverter LCD System board
No beep, power-on indicator turns on and a blinking cursor shown on LCD during POST.	Ensure every connector is connected tightly and correctly. System board
No beep during POST but system runs correctly.	Speaker System board

Phoenix BIOS Beep Codes

Code	Beeps	POST Routine Description
02h		Verify Real Mode
03h		Disable Non-Maskable Interrupt (NMI)
04h		Get CPU type
06h		Initialize system hardware
08h		Initialize chipset with initial POST values
09h		Set IN POST flag
0Ah		Initialize CPU registers
0Bh		Enable CPU cache
0Ch		Initialize caches to initial POST values
0Eh		Initialize I/O component
0Fh		Initialize the local bus IDE
10h		Initialize Power Management
11h		Load alternate registers with initial POST values
12h		Restore CPU control word during warm boot
13h		Initialize PCI Bus Mastering devices
14h		Initialize keyboard controller
16h	1-2-2-3	BIOS ROM checksum
17h		Initialize cache before memory autosize
18h		8254 timer initialization
1Ah		8237 DMA controller initialization
1Ch		Reset Programmable Interrupt Controller
20h	1-3-1-1	Test DRAM refresh
22h	1-3-1-3	Test 8742 Keyboard Controller
24h		Set ES segment register to 4 GB
26h		Enable A20 line
28h		Autosize DRAM
29h		Initialize POST Memory Manager
2Ah		Clear 215 KB base RAM
2Ch	1-3-4-1	RAM failure on address line xxxx
2Eh	1-3-4-3	RAM failure on data bits xxxx of low byte of memory bus
2Fh		Enable cache before system BIOS shadow
30h	1-4-1-1	RAM failure on data bits xxxx of high byte of memory bus
32h		Test CPU bus-clock frequency
33h		Initialize Phoenix Dispatch Manager
36h		Warm start shut down
38h		Shadow system BIOS ROM
3Ah		Autosize cache
3Ch		Advanced configuration of chipset registers
3Dh		Load alternate registers with CMOS values
42h		Initialize interrupt vectors
45h		POST device initialization

Code	Beeps	POST Routine Description
46h	2-1-2-3	Check ROM copyright notice
48h		Check video configuration against CMOS
49h		Initialize PCI bus and devices
4Ah		Initialize all video adapters in system
4Bh		QuietBoot start (optional)
4Ch		Shadow video BIOS ROM
4Eh		Display BIOS copyright notice
50h		Display CPU type and speed
51h		Initialize EISA board
52h		Test keyboard
54h		Set key click if enabled
58h	2-2-3-1	Test for unexpected interrupts
59h		Initialize POST display service
5Ah		Display prompt "Press F2 to enter SETUP"
5Bh		Disable CPU cache
5Ch		Test RAM between 512 and 640 KB
60h		Test extended memory
62h		Test extended memory address lines
64h		Jump to User Patch1
66h		Configure advanced cache registers
67h		Initialize Multi Processor APIC
68h		Enable external and CPU caches
69h		Setup System Management Mode (SMM) area
6Ah		Display external L2 cache size
6Bh		Load custom defaults (optional)
6Ch		Display shadow-area message
6Eh		Display possible high address for UMB recovery
70h		Display error messages
72h		Check for configuration errors
76h		Check for keyboard errors
7Ch		Set up hardware interrupt vectors
7Eh		Initialize coprocessor if present
80h		Disable onboard Super I/O ports and IRQs
81h		Late POST device initialization
82h		Detect and install external RS232 ports
83h		Configure non-MCD IDE controllers
84h		Detect and install external parallel ports
85h		Initialize PC-compatible PnP ISA devices
86h		Re-initialize onboard I/O ports
87h		Configure Motherboard Configurable Devices (optional)
88h		Initialize BIOS Area
89h		Enable Non-Maskable Interrupts (NMI)
8Ah		Initialize Extended BIOS Data Area
8Bh		Test and initialize PS/2 mouse

Code	Beeps	POST Routine Description
8Ch		Initialize floppy controller
8Fh		Determine number of ATA drives (optional)
90h		Initialize hard-disk controllers
91h		Initialize local-bus hard-disk controllers
92h		Jump to UserPatch2
93h		Build MPTABLE for multi-processor boards
95h		Install CD ROM for boot
96h		Clear huge ES segment register
97h		Fixup Multi Processor table
98h	1-2	Search for option ROMs. One long, two short beeps on checksum failure.
99h		Check for SMART drive (optional)
9Ah		Shadow option ROMs
9Ch		Set up Power Management
9Dh		Initialize security engine (optional)
9Eh		Enable hardware interrupts
9Fh		Determine number of ATA and SCSI drives
A0h		Set time of day
A2h		Check key lock
A4h		Initialize Typematic rate
A8h		Erase F2 prompt
AAh		Scan for F2 key stroke
ACh		Enter SETUP
AEh		Clear Boot flag
B0h		Check for errors
B2h		POST done- prepare to boot operating system
B4h	1	One short beep before boot
B5h		Terminate QuietBoot (optional)
B6h		Check password (optional)
B9h		Prepare Boot
BAh		Initialize DMI parameters
BBh		Initialize PnP Option ROMs
BCh		Clear parity checkers
BDh		Display MultiBoot menu
BEh		Clear screen (optional)
BFh		Check virus and backup reminders
C0h		Try to boot with INT 19
C1h		Initialize POST Error Manager (PEM)
C2h		Initialize error logging
C3h		Initialize error display function
C4h		Initialize system error handler
C5h		PnPnd dual CMOS (optional)
C6h		Initialize notebook docking (optional)
C7h		Initialize notebook docking late
C8h		Force check (optional)
C9h		Extended checksum (optional)

Code	Beeps	POST Routine Description
D2h		Unknown interrupt

Code	Beeps	POST Routine Description
E0h		Initialize the chipset
E1h		Initialize the bridge
E2h		Initialize the CPU
E3h		Initialize the system timer
E4h		Initialize system I/O
E5h		Check force recovery boot
E6h		Checksum BIOS ROM
E7h		Go to BIOS
E8h		Set Huge Segment
E9h		Initialize Multi Processor
EAh		Initialize OEM special code
EBh		Initialize PIC and DMA
ECh		Initialize Memory type
EDh		Initialize Memory size
EEh		Shadow Boot Block
EFh		System memory test
F0h		Initialize interrupt vectors
F1h		Initialize Run Time Clock
F2h		Initialize video
F3h		Initialize System Management Mode
F4h	1	Output one beep before boot
F5h		Boot to Mini DOS
F6h		Clear Huge Segment
F7h		Boot to Full DOS

Index of Symptom-to-FRU Error Message

LCD-Related Symptoms

Symptom / Error	Action in Sequence
LCD backlight doesn't work LCD is too dark LCD brightness cannot be adjusted LCD contrast cannot be adjusted	Enter BIOS Utility to execute "Load Setup Default Settings", then reboot system. Reconnect the LCD connectors. Keyboard (if contrast and brightness function key doesn't work). LCD inverter ID LCD cable LCD inverter LCD System board
Unreadable LCD screen Missing pels in characters Abnormal screen Wrong color displayed	Reconnect the LCD connector LCD inverter ID LCD cable LCD inverter LCD System board
LCD has extra horizontal or vertical lines displayed.	LCD inverter ID LCD inverter LCD cable LCD System board

Indicator-Related Symptoms

Symptom / Error	Action in Sequence
Indicator incorrectly remains off or on, but system runs correctly	Reconnect the inverter board Inverter board System board

Power-Related Symptoms

Symptom / Error	Action in Sequence
Power shuts down during operation	Power source (battery pack and power adapter). See "Power System Check" on page 67. Battery pack Power adapter Hard drive & battery connection board System board
The system doesn't power-on.	Power source (battery pack and power adapter). See "Power System Check" on page 67. Battery pack Power adapter Hard drive & battery connection board System board
The system doesn't power-off.	Power source (battery pack and power adapter). See "Power System Check" on page 67. Hold and press the power switch for more than 4 seconds. System board

Power-Related Symptoms

Symptom / Error	Action in Sequence
Battery can't be charged	See "Check the Battery Pack" on page 69. Battery pack System board

PCMCIA-Related Symptoms

Symptom / Error	Action in Sequence
System cannot detect the PC Card (PCMCIA)	PCMCIA slot assembly System board
PCMCIA slot pin is damaged.	PCMCIA slot assembly

Memory-Related Symptoms

Symptom / Error	Action in Sequence
Memory count (size) appears different from actual size.	Enter BIOS Setup Utility to execute "Load Default Settings, then reboot system. DIMM System board

Speaker-Related Symptoms

Symptom / Error	Action in Sequence
In Windows, multimedia programs, no sound comes from the computer.	Audio driver Speaker System board
Internal speakers make noise or emit no sound.	Speaker System board

Power Management-Related Symptoms

Symptom / Error	Action in Sequence
The system will not enter hibernation	See "Save to Disk (S4)" on page 36. Keyboard (if control is from the keyboard) Hard disk drive System board
The system doesn't enter hibernation mode and four short beeps every minute.	Press Fn+  and see if the computer enters hibernation mode. Touchpad Keyboard Hard disk connection board Hard disk drive System board
The system doesn't enter standby mode after closing the LCD	See "Save to Disk (S4)" on page 36. LCD cover switch System board
The system doesn't resume from hibernation mode.	See "Save to Disk (S4)" on page 36. Hard disk connection board Hard disk drive System board
The system doesn't resume from standby mode after opening the LCD.	See "Save to Disk (S4)" on page 36. LCD cover switch System board

Power Management-Related Symptoms

Symptom / Error	Action in Sequence
Battery fuel gauge in Windows doesn't go higher than 90%.	Remove battery pack and let it cool for 2 hours. Refresh battery (continue use battery until power off, then charge battery). Battery pack System board
System hangs intermittently.	Reconnect hard disk/CD-ROM drives. Hard disk connection board System board

Peripheral-Related Symptoms

Symptom / Error	Action in Sequence
System configuration does not match the installed devices.	Enter BIOS Setup Utility to execute "Load Default Settings", then reboot system. Reconnect hard disk/CD-ROM/diskette drives.
External display does not work correctly.	Press Fn+F5, LCD/CRT/Both display switching System board
USB does not work correctly	System board
Print problems.	Ensure the "Parallel Port" in the "Onboard Devices Configuration" of BIOS Setup Utility is set to Enabled. Onboard Devices Configuration Run printer self-test. Printer driver Printer cable Printer System Board
Serial or parallel port device problems.	Ensure the "Serial Port" in the Devices Configuration" of BIOS Setup Utility is set to Enabled. Device driver Device cable Device System board

Keyboard/Touchpad-Related Symptoms

Symptom / Error	Action in Sequence
Keyboard (one or more keys) does not work.	Reconnect the keyboard cable. Keyboard System board
Touchpad does not work.	Reconnect touchpad cable. Touchpad board System board

Modem-Related Symptoms

Symptom / Error	Action in Sequence
Internal modem does not work correctly.	Modem phone port modem combo board System board

NOTE: If you cannot find a symptom or an error in this list and the problem remains, see "Undetermined Problems" on page 82.

Intermittent Problems

Intermittent system hang problems can be caused by a variety of reasons that have nothing to do with a hardware defect, such as: cosmic radiation, electrostatic discharge, or software errors. FRU replacement should be considered only when a recurring problem exists.

When analyzing an intermittent problem, do the following:

1. Run the advanced diagnostic test for the system board in loop mode at least 10 times.
2. If no error is detected, do not replace any FRU.
3. If any error is detected, replace the FRU. Rerun the test to verify that there are no more errors.

Undetermined Problems

The diagnostic problems does not identify which adapter or device failed, which installed devices are incorrect, whether a short circuit is suspected, or whether the system is inoperative.

Follow these procedures to isolate the failing FRU (do not isolate non-defective FRU).

NOTE: Verify that all attached devices are supported by the computer.

NOTE: Verify that the power supply being used at the time of the failure is operating correctly. (See “Power System Check” on page 67.):

1. Power-off the computer.
2. Visually check them for damage. If any problems are found, replace the FRU.
3. Remove or disconnect all of the following devices:
 - Non-Acer devices
 - Printer, mouse, and other external devices
 - Battery pack
 - Hard disk drive
 - DIMM
 - CD-ROM/Diskette drive Module
 - PC Cards
4. Power-on the computer.
5. Determine if the problem has changed.
6. If the problem does not recur, reconnect the removed devices one at a time until you find the failing FRU.
7. If the problem remains, replace the following FRU one at a time. Do not replace a non-defective FRU:
 - System board
 - LCD assembly

Jumper and Connector Locations

Top View

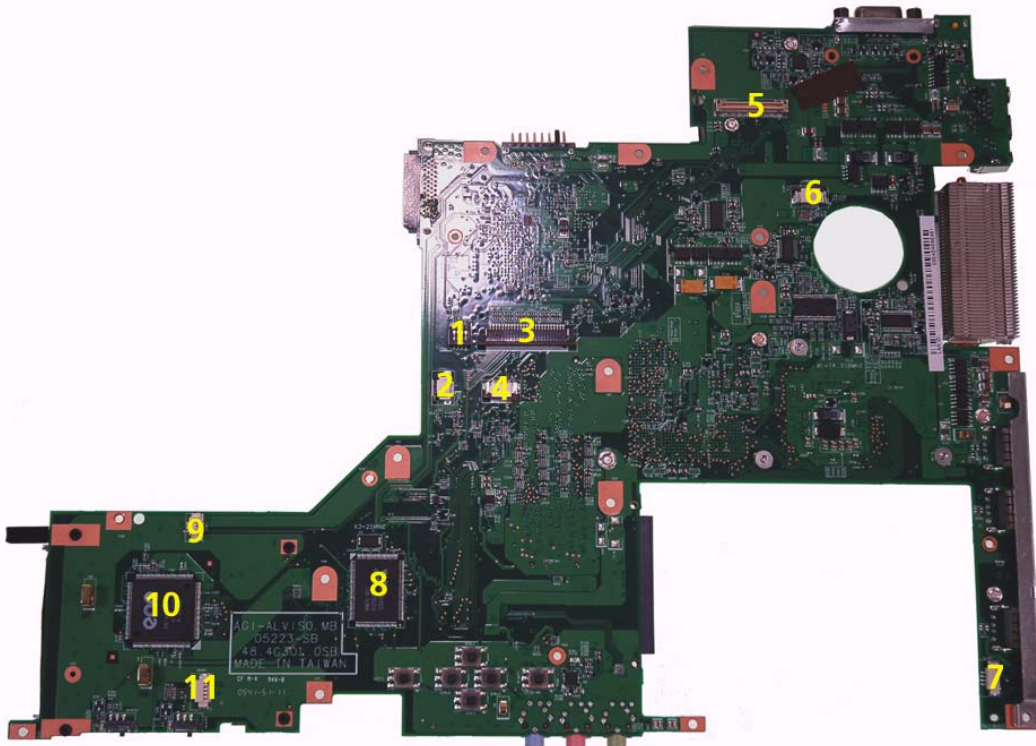

1	SW1	Switch	7	BLUE1	Bluetooth Cable Connector
2	LEDB1	LED Board Cable Connector	8	U39	LAN Connector: RTL8100CL
3	KB1	Keyboard Connector	9	RTC1	RTC Battery Connector
4	TPAD1	Touchpad Cable Connector	10	U40	Keyboard Controller: ENE CB-1410QF
5	LCD1	LCD Cable Connector	11	SPKR1	Speaker Set Cable Connector
6	LAUNCH1	Launch Board Cable Connector			

Bottom View

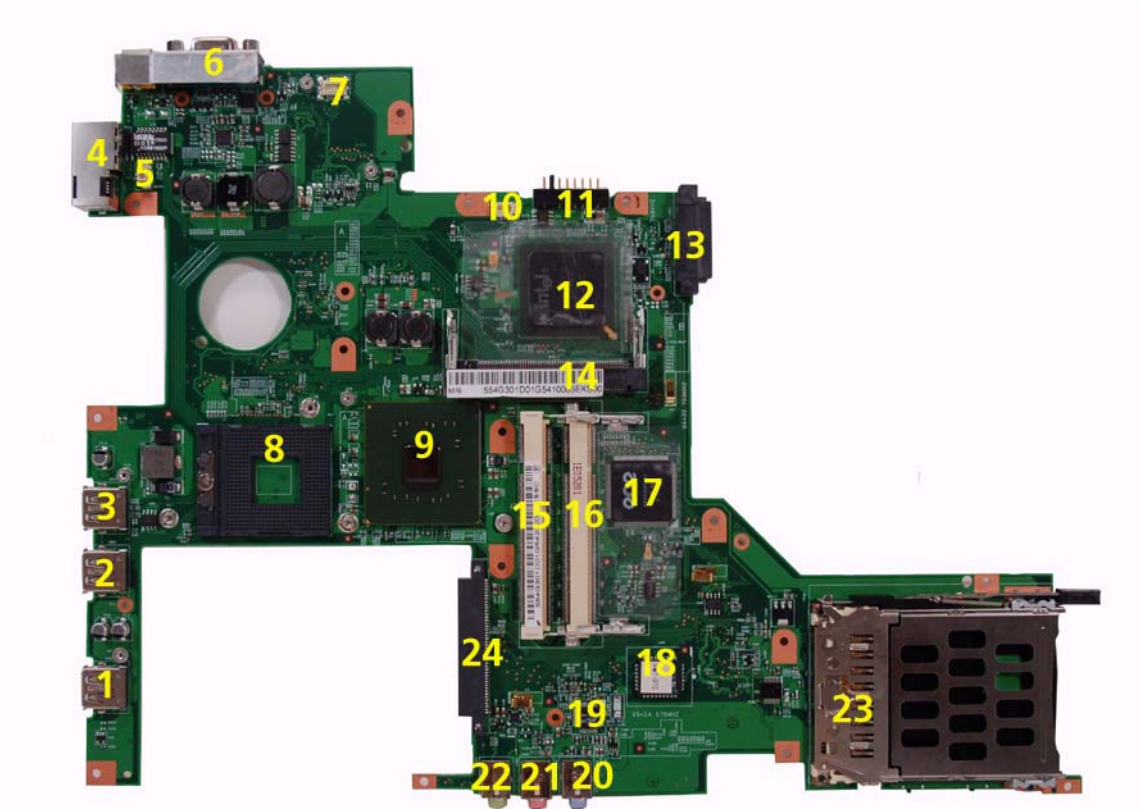

NOTE: This is engineering sample. The image above may not be exactly the same as the real main board you get.

1	USB2	USB port	13	ODD1	ODD Connector
2	USB3	USB port	14	WIN1	Wireless LAN Card Slotr
3	USB4	USB port	15	DM1	DIMM Slot1
4	LAN1	RJ11+RJ45 (Modem Port+ Ethernet Port)	16	DM3	DIMM Slot2
5	MDCW1	Modem Cable Connector	17	U44	Keyboard Controller (ENE KB3910SF)
6	CRT1	External Display Port	18	U49	BIOS ROM
7	MDC	Modem Board Connector	19	U32	Audio Codec (Realtek ACL)
8	U41	CPU Socket	20	LIN1	Line-in Jack
9	U38	North Bridge ()	21	MIC2	Headphones/Speakers/Line-Out Jack
10	FAN1	System Fan Cable Connector	22	LOUT1	Line-in Jack
11	BAT1	Battery Connector	23	PC1	PC Card Slot
12	U	South Bridge ()	24	HDD1	HDD Connector

FRU (Field Replaceable Unit) List

This chapter gives you the FRU (Field Replaceable Unit) listing in global configurations of Aspire 3620/TravelMate 2420. Refer to this chapter whenever ordering for parts to repair or for RMA (Return Merchandise Authorization).







Please note that WHEN ORDERING FRU PARTS, you should check the most up-to-date information available on your regional web or channel. For whatever reasons a part number change is made, it will not be noted on the printed Service Guide. For ACER AUTHORIZED SERVICE PROVIDERS, your Acer office may have a DIFFERENT part number code from those given in the FRU list of this printed Service Guide. You MUST use the local FRU list provided by your regional Acer office to order FRU parts for repair and service of customer machines.

NOTE: To scrap or to return the defective parts, you should follow the local government ordinance or regulations on how to dispose it properly, or follow the rules set by your regional Acer office on how to return it.

Aspire 3620/TravelMate 2420 Exploded Diagram





Aspire 3620/TravelMate 2420 FRU List



Category	No.	Part Name and Description	Acer Part No.
Adapter			
		ADAPTER 65W DELTA SADP-65KB DBE	AP.06501.007
		ADAPTER 65W LITEON PA-1650-02WR	AP.06503.011
		ADAPTER 65W LISHIN SLS0335A19A54LF	AP.06506.003
Battery			
		BATTERY PACK LI 6CELL 2.0MAH SANYO	BT.00603.014
		BATTERY PACK LI+ 6CELL 2.0MAH SONY	BT.00604.006
		BATTERY PACK LI 6CELL 2.0MAH PANASONIC	BT.00605.002
		BATTERY PACK LI+ 6CELL 2.4MAH SANYO	BT.00603.012
		BATTERY PACK LI+ 6CELL 2.4MAH SONY	BT.00604.005
		BATTERY PACK LI+ 6CELL 2.4MAH PANASONIC	BT.00605.003
		BATTERY PACK LI+ 9CELL 2.4MAH SANYO	BT.00903.004
Boards			
		WIRELESS LAN BOARD 802.11BG FOXCONN ATHEROS EU	54.A74V1.001
		WIRELESS LAN BOARD 802.11BG FOXCONN BCM4318	54.A74V1.002
		MODEM BOARD FOXCONN T60M845.01	54.A56V1.001
		TOUCHPAD BOARD SYNAPTICS TM51-389	56.TB1V1.001
		LAUNCH BOARD	55.TB2V1.002
		LED BOARD	55.TB2V1.001



Category	No.	Part Name and Description	Acer Part No.
		BLUETOOTH MODULE FOXCONN BCM2045 Note: The bluetooth module does not contain the black mylar as the image shows..	54.TB2V1.001
Cables			
		MODEM CABLE	50.TB2V1.005
		LED CABLE	50.TB2V1.003
		TOUCHPAD CABLE	50.TB2V1.001
		LAUNCH BOARD CABLE	50.TB2V1.002
		BLUETOOTH CABLE	50.TB2V1.004
		POWER CORD 2.5A 125V USA	27.01518.781
		POWER CORD 10A 250V 3PIN CHINA	27.01518.591
		POWER CORD 10A 125V US	27.T30V1.001
		POWER CORD 7A 250V 2PIN KOREAN	27.01518.531
		POWER CORD 3A 250V 3PIN UK	27.01518.541
		POWER CORD 220V 3PIN EUR	27.T30V1.004
		POWER CORD 7A 125V 2PIN JAPEN	27.01518.551
		POWER CORD 10A 3PIN BK	27.01518.561
		POWER CORD 10A 250V 3PIN ITALY	27.01518.611
		POWER CORD 10A 250V 3PIN BK SOUTH AFRICA	27.01518.571
		POWER CORD 10A 250V SWISS	27.01518.581
		POWER CORD 2.5A 250V AUSTRALIA	27.01518.621

Category	No.	Part Name and Description	Acer Part No.
		POWER CORD 2.5A 250V SOUTH AFRICA BK	27.01518.631
		POWER CODE 7A 125V JAPAN 2PIN	27.03518.161
Case/Cover/Bracket/Assembly			
		LOWERCASE W/SPEAKER	60.TB2V1.001
Speaker			
		SPEAKER	23.TB2V1.001
Case/Cover/Bracket/Assembly			
		MIDDLE COVER	60.AA6V1.003
		MIDDLE COVER (TM)	60.TB2V1.003
		MINI CARD COVER	TBD
		DIMM COVER	42.TB2V1.001
		HDD COVER	42.TB2V1.002

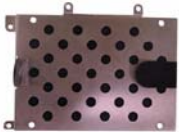





Category	No.	Part Name and Description	Acer Part No.
		TOUCHPAD BRACKET	33.TB2V1.001
		UPPER CASE	60.AA6V1.002
		UPPER CASE (TM)	60.TB2V1.002
Combo Module			
		COMBO MODULE 24X	6M.TB2V1.001
		OPTICAL FIX HOLDER BRACKET	33.TB2V1.002
		OPTICAL RAIL HOLDER	33.TB2V1.003
		OPTICAL BEZEL GBASE FOR COMBO	42.TB2V1.003
		COMBO MODULE 24X HLDS GCC-4244N LF 1.00AB W/O BEZEL	KO.0240A.005
		COMBO MODULE 24X LITEON SOSC-2485K W/O BEZEL	KO.02409.015
CPU/Processor			
		CPU CEL-M370 1.5GMHZ INTEL	KC.NV001.370
		CPU DOTHAN730 1.6GMHZ INTEL	KC.N0001.730



Category	No.	Part Name and Description	Acer Part No.
		CPU DOTHAN740 1.73GMHZ INTEL	KC.N0001.740
		CPU DOTHAN725A 1.6GMHZ INTEL	KC.NA001.725
		CPU CEL-M370 1.5G MHZ INTEL	KC.NC001.370
		CPU CEL-M380 1.6GMHZ INTEL	KC.NV001.380
		CPU CEL-M390 1.7GMHZ INTEL	KC.NV001.390
		CPU CEL-M360 1.4GMHZ INTEL	KC.NV001.360
DVD Module			
		DVD-RW MODULE 8X	6M.TB2V1.002
		OPTICAL FIX HOLDER BRACKET	33.TB2V1.002
		OPTICAL RAIL HOLDER	33.TB2V1.003
		OPTICAL BEZEL GBASE FOR DUAL	42.TB2V1.003 42.TB2V1.004 (TM)
		DVD-RW DRIVE 8X S-MUTI HLDS GSA-4082N W/O BEZEL	KU.0080D.017
		DVD-RW DRIVE 8X DUAL LITEON SOSW-833S W/O BEZEL	KU.00804.012
		DUAL PIO/DVR-K16RA AG1 NOBZ LF	KU.00805.019
		DUAL PAN/UJ-850 AG1 NOBZL LF	KU.00807.022
		DUAL HLD/GWA-4082N MORAR GCP03	KU.0080D.019
		S-MUTI PAN/UJ-850 AG1 NOBZL LF	KU.00807.025
Fan			
		FAN SUNON AG1	23.TB2V1.003
HDD/Hard Disk Drive			
		HDD MODULE 40G	TBD

Category	No.	Part Name and Description	Acer Part No.
		ASSY HDD BRACKET AG1	33.TB2V1.004
		HDD 40GB SEAGATE ST9402112A	KH.04001.014
		HDD 40GB TOSHIBA MK4025GAS	KH.04004.005
		HDD 40GB HGST HTS421240H9AT00	KH.04007.013
		HDD 40GB WD WD400UE-22HCT0	KH.04008.025
		HDD 40GB SAMSUNG M40MP0402H	KH.0400B.003
		HDD MODULE 60G	TBD
		ASSY HDD BRACKET AG1	33.TB2V1.004
		HDD 60GB SEAGATE ST96812A	KH.06001.004
		HDD 60GB SEAGATE ST960812A	KH.06001.003
		HDD 60GB TOSHIBA MK6025GAS	KH.06004.004
		HDD 60G TOSHIBA	KH.06004.007
		HDD 60GB HGST HTS541260H9AT00	KH.06007.010
		HDD 60GB WD WD600UE-22HCT0	KH.06008.002
		HDD MODULE 80G	TBD
		HDD BRACKET	33.TB2V1.004
		HDD 80G TOSHIBA MK8025GAS	KH.08004.003
		HDD 80G HITACHI HTS421280H9AT00	KH.08007.011
		HDD 80G SEAGATE ST980829A	KH.08001.013
		HDD 80G SEAGATE ST98823A	KH.08001.014
		HDD 80G TOSHIBA MK8026GAX	KH.08004.004
		HDD 80G HGST HTS541280H9AT00	KH.08007.012
		HDD 80G WD WD800UE-22HCT0	KH.08008.027
		HDD MODULE 100G	TBD
		HDD BRACKET	33.TB2V1.004
		HDD 100GB SEAGATE ST9100825A	KH.10001.003
		HDD 100G TOSHIBA MK1031GAS	KH.10004.001
		HDD 100G HITACHI HTS421210H9AT00	KH.10007.002
		HDD 100G SEAGATE ST9100824A	KH.10001.004
		HDD 100G SATA SAMSUNG HM100JI	KH.1000B.001
		HDD MODULE 120G	TBD
		HDD BRACKET	33.TB2V1.004
		HDD 120G SEAGATE ST9120824A	KH.12001.014
		HDD 120G SEAGATE ST9120821A	KH.12001.015
Heatsink			

Category	No.	Part Name and Description	Acer Part No.
		CPU HEATSINK W/SCREW W/O FAN	34.TB2V1.001
Keyboard			
		KEYBOARD 89KEY DARFON NSK-H3M00 SWISS	KB.A2707.011
		KEYBOARD 88KEY DARFON NSK-H30M02 TAIWAN(CHINESE)	KB.A2707.002
		KEYBOARD 88KEY DARFON NSK-H3M03 THAI	KB.A2707.004
		KEYBOARD 89KEY DARFON NSK-H3M06 PORTUGA	KB.A2707.012
		KEYBOARD 88KEY DARFON NSK-H3M0A ARABIA	KB.A2707.013
		KEYBOARD 89KEY DARFON NSK-H3M0C CZECH	KB.A2707.016
		KEYBOARD 89KEY DARFON NSK-H3M0D DANISH	KB.A2707.019
		KEYBOARD 89KEY NSK-H30M0E DARFON ITALY	KB.A2707.009
		KEYBOARD 89KEY DARFON NSK-H3M0F FRENCH	KB.A2707.010
		KEYBOARD 89KEY DARFON NSK-H30M0G GERMAN	KB.A2707.008
		KEYBOARD 88KEY DARFON NSK-H3M0H HB	KB.A2707.024
		KEYBOARD 88KEY DARFON NSK-H3M0L GK	KB.A2707.023
		KEYBOARD 89KEY DARFON NSK-H3M0M CF	KB.A2707.021
		KEYBOARD 89KEY DARFON NSK-H3M0N NORWEGIAN	KB.A2707.018
		KEYBOARD 89KEY DARFON NSK-H3M0Q HG	KB.A2707.017
		KEYBOARD 88KEY DARFON NSK-H3M0R RUSSIAN	KB.A2707.025
		KEYBOARD 89KEY DARFON NSK-H3M0S SP	KB.A2707.003
		KEYBOARD 89KEY DARFON NSK-H3M0T TURKISH	KB.A2707.020
		KEYBOARD 89KEY DARFON NSK-H3M0U UK	KB.A2707.007
		KEYBOARD 89KEY DARFON NSK-H3M0W SWEDEN	KB.A2707.015

Category	No.	Part Name and Description	Acer Part No.
		KEYBOARD 89KEY DARFON NSK-H3M1A BELGIUM	KB.A2707.014
		KEYBOARD 89KEY DARFON NSK-H3M1B BR	KB.A2707.005
		KEYBOARD 88KEY DARFON NSK-H3M1D US-INTERNATIONAL	KB.A2707.001
Keyboard (TM)			
		KEYBOARD 89KEY DARFON NSK-AEK00 SWISS	KB.T5007.011
		KEYBOARD 88KEY DARFON NSK-AEK02 TAIWAN(CHINESE)	KB.T5007.002
		KEYBOARD 88KEY DARFON NSK-AEK03 THAI	KB.T5007.004
		KEYBOARD 89KEY DARFON NSK-AEK06 PORTUGA	KB.T5007.012
		KEYBOARD 88KEY DARFON NSK-AEK0A ARABIC	KB.T5007.013
		KEYBOARD 89KEY DARFON NSK-AEK0C CZECH	KB.T5007.016
		KEYBOARD 89KEY DARFON NSK-AEK0D DANISH	KB.T5007.019
		KEYBOARD 89KEY DARFON NSK-AEK0E ITALY	KB.T5007.009
		KEYBOARD 89KEY DARFON NSK-AEK0F FRENCH	KB.T5007.010
		KEYBOARD 88KEY DARFON NSK-AEK0G GERMAN	KB.T5007.008
		KEYBOARD 88KEY DARFON NSK-AEK0H HB	KB.T5007.024
		KEYBOARD 88KEY DARFON NSK-AEK0L GK	KB.T5007.023
		KEYBOARD 89KEY DARFON NSK-AEK0M CF	KB.T5007.021
		KEYBOARD 89KEY DARFON NSK-AEK0N NORWEGIAN	KB.T5007.018
		KEYBOARD 89KEY DARFON NSK-AEK0Q HG	KB.T5007.017
		KEYBOARD 88KEY DARFON NSK-AEK0R RUSSIAN	KB.T5007.025
		KEYBOARD 89KEY DARFON NSK-AEK0S SP	KB.T5007.003
		KEYBOARD 89KEY DARFON NSK-AEK0T TURKISH	KB.T5007.020
		KEYBOARD 89KEY DARFON NSK-AEK0U UK	KB.T5007.007
		KEYBOARD 89KEY DARFON NSK-AEK0W SWEDEN	KB.T5007.015
		KEYBOARD 89KEY DARFON NSK-AEK1A BELGIUM	KB.T5007.014
		KEYBOARD 89KEY DARFON NSK-AEK1B BR	KB.T5007.005
		KEYBOARD DARFON NSK-N7082 US-INTERNATIONAL	KB.T5007.001

Category	No.	Part Name and Description	Acer Part No.
		KEYBOARD 89KEY DARFON NSK-AEK1F SV	KB.T5007.026
LCD Module			
		LCD MODULE 14.1" WXGA W/ ANTENNA NONE GLARE	6M.TB2V1.011
		INVERTER BOARD 15.4" FOXCONN T62I240.00	19.A46V1.003
		WIRELESS ANTENNA LEFT/RIGHT	25.TB2V1.001
		LCD/INVERTER CABLE 14.1" WXGA	50.TB2V1.006
		LCD BRACKET RIGHT Note: Right bracket is the upper one.	33.TB1V1.003
		LCD BRACKET LEFT Note: Left bracket is the lower one	33.TB1V1.004
		LCD PANEL 14.1" W/HINGE	60.TB2V1.004
		LCD BEZEL 14.1" W/LOGO	60.TB2V1.005

Category	No.	Part Name and Description	Acer Part No.
		HINGE PACK LEFT/RIGHT	6K.TB2V1.001
		LCD 14.1" WXGA AU B141EW01 V.1 NONE GLARE	LK.14105.013
		LCD 14" WXGA SAMSUNG LTN141W1-L01 NONE GLARE	LK.14106.004
		LCD 14.1" WXGA LG LP141WX1-TL02 NONE GLARE	LK.14108.002
		LCD 14.1" WXGA QDI QD14TL01-03 NONE GLARE 420G	LK.14109.004
		LCD 14" WXGA CMO N141I1-L02 NONE GLARE	LK.1410D.004
		LCD MODULE 14.1" WXGA GLARE W/ANTENNA	6M.TB2V1.012
		INVERTER BOARD 15.4" FOXCONN T62I240.00	19.A46V1.003
		WIRELESS ANTENNA LEFT/RIGHT	25.TB2V1.001
		LCD/INVERTER CABLE 14.1" WXGA	50.TB2V1.007
		LCD BRACKET RIGHT	33.TB1V1.003
		LCD BRACKET LEFT	33.TB1V1.004
		LCD PANEL 14.1" W/HINGE	60.TB2V1.004
		LCD BEZEL 14.1" W/LOGO	60.TB2V1.005
		HINGE PACK LEFT/RIGHT	6K.TB2V1.001
		LCD 14.1" WXGA CMO N141I1-L03 GLARE	LK.1410D.005
		LCD 14.1" WXGA QDI QD14TL01-02 GLARE 420G	LK.14109.005
		LCD 14.1" WXGA AU B141EW01 V.0 GLARE TYPE	LK.14105.014
		LCD 14.1" WXGA SAMSUNG LTN141W1-L01 GLARE	LK.14106.005
		LCD 14.1" WXGA LG LP141WX1-TL03 GLARE	LK.14108.003
Mainboard			
		MAINBOARD AG1910 W/O CPU W/ PCMCIA SLOT & RTC BATTERY	MB.TB201.001
Battery			

Category	No.	Part Name and Description	Acer Part No.
		RTC BATTERY	23.TB2V1.004
	PCMCIA Slot/PC Card Slot		
		PCMCIA SLOY	22.TB2V1.001
Memory			
		SDIMM 256M INFINEON HYS64T32000HDL-3.7-A	KN.25602.023
		DIMM 256M NANYA NT256T64UH4A1FN-37B	KN.25603.029
		SDIMM 256M MICRON MT4HTF3264HY-53EB3	KN.25604.027
		SDIMM 256M SAMSUNG M470T3354CZ3-CD5	KN.2560B.017
		SDIMM 256M HYNIX HYMP532S64P6-C4	KN.2560G.006
		SDIMM 512M INFINEON MHYS64T64020HDL-3.7-A	KN.51202.021
		SDIMM 512M NANYA NT512T64UH8A1FN-37B	KN.51203.023
		SDIMM 512M MICRON MT8HTF6464HDY-53EB3	KN.51204.019
		SDIMM 512M SAMSUNG M470T6554CZ3-CD5	KN.5120B.015
		SDIMM 512M HYNIX HYMP564S64P6-C4	KN.5120G.005
Miscellaneous			
		LCD SCREW RUBBER LCD RUBBER CUSHION	47.A46V1.002
			LCD SCREW RUBBER
		NAME PLATE	40.AA6V1.001
	NAME PLIATE (TM)	40.TB2V1.001	
Screws			
		SCW HEX NYL I#R-40/O#4-40 L5.5	34.00015.081
		SCRW MACH WAFER M2.5*L3 ZN S N	86.00B34.530

Category	No.	Part Name and Description	Acer Part No.
		SCRW M2*L3 BLACK	86.00C31.220
		SCRW M2 X 2	86.00C34.620
		SCR M2.5*12L B-ZN NYLOK I-HEAD	86.5A353.120
		SCRW WH MS+CBZ M2.5+L4 BLACK	86.9A323.4R0
		SCREW	86.9A352.4R0
		SCREW M2.5*4L(NYLOCK) BLACK ZN	86.9A353.4R0
		SCRW M2.5*5 WAFER B-ZN	86.9A353.5R0
		SCRW MAC WAFER M2*L2.5 ZN S_NO	86.9A452.2R5
		SCREW M3x4 (86.9A524.4R0)	86.9A524.4R0
		SCREW M2 X L8 (DIA 6MM)	86.T28V1.005
		SCREW WAFER NYLOK NI 2ML3	86.9A552.3R0
		SCRW M2.5*3 WAFER NI	86.9A553.3R0
		SCREW NYLOK M2.5-5	86.9A553.5R0
Microphone			
		MICROPHONE	23.TB2V1.002

A

AFLASH Utility 48
Audio 32

B

Battery Pack 53
BIOS 29
 package 29
 password control 29
 ROM size 29
 ROM type 29
 vendor 29
 Version 29
BIOS Supports protocol 29
BIOS Utility 37
 Navigating 38
 Onboard Device Configuration 43
 Security 41, 42
 System Security 47
Board Layout
 Bottom View 5
 Top View 4, 83

C

Cache
 controller 29
 size 29
CardBus 33

D

DIMM
 external 54, 58
 removing 54, 58
Disassembly
 Battery Pack 52
 LCD Module 62
 Procedure Flowchart 51
Disassemblyt
 the Main Unit 60
Display 3
DVD-ROM Interface 32

E

Error Symptom-to-Spare Part Index 70
External CD-ROM Drive Check 66

F

Features 1
Flash Utility 48
Floppy Disk
 removing the 62
FRU (Field Replaceable Unit) List 85

H

Hard disk 31
HDD 31
Hot Keys 16

I

Indicators 12
Intermittent Problems 81

J

Jumper and Connector Locations 83
 Bottom View 84
 Top View 83

K

Keyboard 34
Keyboard or Auxiliary Input Device Check 66

L

L2 cache 29

M

Memory Check 67
Modem 30

N

num lock
 on indicator 13

P

Panel 7
 Bottom 11
 left 7
PC Card 12, 33
PCMCIA 33
Power System Check 67
 Battery Pack 69
 Power Adapter 68
Processor 29

S

Second Level Cache 29

System

 Block Diagram 3

System Check Procedures 66

System Memory 29

System Utilities 37

T

Top 83

Touchpad Check 69

Troubleshooting 65

U

Undetermined Problems 82

USB 33

utility

 BIOS 37

V

Video 33