Welcome.....7

Using Your VAIO Notebook.....9

Using the Keyboard.....	9
The notebook keyboard keys	11
Indicators	13
Indicator lights	13
The Windows key in combination with other keys	14
The Fn key in combination with other keys	15
Using the Touchpad	17
Using PC Cards	19
Connecting VAIO Computers	22
If your notebook is connected to the optional docking station	
23	
VAIO Action Setup.....	25
Using the Center Jog Dial Control	26
Using the center Jog Dial control	26
Launcher mode	27
Guide Mode	28
Using the center Jog Dial control with Sony software	28
Using the center Jog Dial control with other software	29
Using Memory Stick Media	30
Types of Memory Stick media.....	30
Write-protecting a Memory Stick media	32
Formatting a Memory Stick media	32
Notes on Memory Stick media	33
Cautions on Memory Stick media	33
Using Power Saving Modes	35
Normal mode	35
Standby mode	35
Hibernate mode.....	35

Using a Phone Line 37
Using the LAN 38

Connecting Peripheral Devices 39

Connecting the Optional Docking Station 39
 Connecting the notebook to the docking station 41
 Disconnecting the notebook from the docking station 42
Connecting the Floppy Disk Drive 47
Connecting an Optical Drive 49
 Playing a DVD 50
 Handling and cleaning CD and DVD media 51
 Writing data to CD-R/RW media 51
Connecting a Printer 53
 To connect a printer 53
Connecting an i.LINK Device 55
Connecting an External Display 58
 To connect a monitor 58
 To connect a projector 59
Connecting a USB Device 62
 To connect a USB device 62
Connecting External Speakers 64
Connecting an External Microphone 65

Customizing Your VAIO Notebook 67

Displaying the Sony Notebook Setup Screen 67
 Sony Notebook Setup tabs 69

Controlling Power Management	70
Viewing the Power Management status icons	70
Activating the Power Management toolbar	70
Power Management profiles	71
Power Management commands	73
Conserving battery power	74
Displaying Battery Information	75
To activate the battery information toolbar	75
Battery icon descriptions	75
Displaying detailed battery information	76
Selecting the Display Mode	78
Changing the window design of Sony software	80

Adding Memory **81**

Precautions and Procedures.....	81
Installing a Memory Module.....	83
Removing a Memory Module	87

About the Software on Your Notebook ... **89**

Overview	89
DVgate	95
To defragment a partition	95
DVgate plug-in for Adobe Premiere.....	95
MovieShaker	97
Importing images and sound clips	97
Create a movie using Shaker	97
Editing clips and scenes.....	98
Saving a movie.....	99

OpenMG Jukebox	100
Electronic Music Distribution (EMD) services	100
To start OpenMG Jukebox 2.0.....	101
To record a CD.....	102
To transfer songs (check-in/check-out).....	103
Additional OpenMG Jukebox features	105
Notes on using Portable Players.....	106
PictureGear	107
Managing your pictures	107
Creating a photo album.....	107
Using Panorama Maker.....	107
Making still images and panoramic from MPEG	108
Smart Capture	109
Using Still mode.....	110
Using Net Movie mode.....	114
Using ImageStation.....	117
VisualFlow	120
To use VisualFlow	120
Application, Driver, and System Recovery CDs ...	121
Using Your Recovery CDs	122
Using the Application Recovery CD(s)	122
Using the Driver Recovery CD(s).....	123
Using the System Recovery CD(s)	123
Recovering Microsoft Word	125
Software Support Information	126

Troubleshooting..... 129

Troubleshooting Your Notebook	129
Troubleshooting the Docking Station	133
Troubleshooting the LCD Screen	135

Troubleshooting the Mouse and Touchpad	136
Troubleshooting Drives, PC Cards, and Peripheral De- vices	137
Troubleshooting the Software	139
Troubleshooting the Modem	140
Troubleshooting Audio	141
Troubleshooting the Printer	142
Getting Help	143
Support Options	143
VAIO Support Agent	145
To use the Quick Fix Wizard	145
To use Common Solutions	147
To use Support Central	149
About automatic updates	153
Index	157

Change text in this variable definition to document title.

Welcome

Congratulations on your purchase of this Sony VAIO® computer, and welcome to the VAIO User Guide. This user guide provides detailed information on all aspects of using your new VAIO computer, from keyboard functions to preinstalled software applications. In the left navigation window, click the topics you want to learn more about, and that information will be displayed in the main window.

Change text in this variable definition to document title.

Using Your VAIO Notebook

This section describes the following aspects of your new computer:

- Using the Keyboard
- Using the Touchpad
- Using PC Cards
- Connecting VAIO Computers
- VAIO Action Setup
- Using the Center Jog Dial Control
- Using Memory Stick Media
- Using Power Saving Modes
- Using a Phone Line
- Using the LAN

Using the Keyboard

Your notebook keyboard is very similar to that of a typewriter, but the keyboard has additional keys that perform specific computer-related tasks.

Change text in this variable definition to document title.

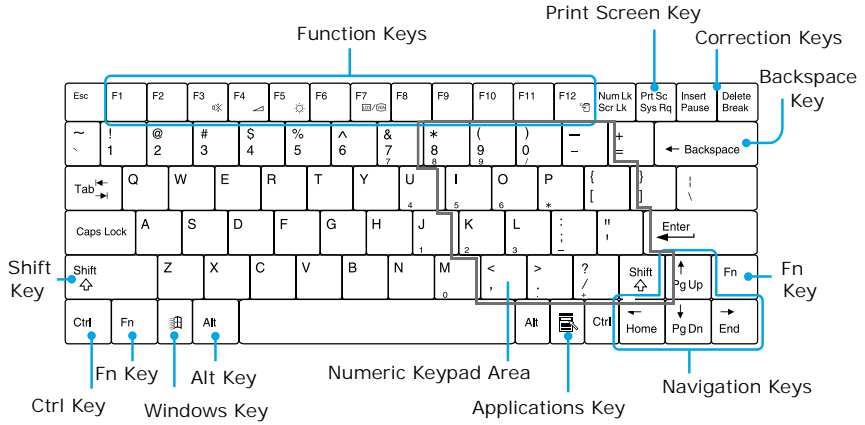

Keyboard







The notebook keyboard keys

<i>Key</i>	<i>Description</i>
Numeric keypad area	<p>The numeric keypad area contains the keys found on a typical calculator. Use this area to type numbers or to perform mathematical calculations such as addition and subtraction. Note the following:</p> <ul style="list-style-type: none"><input type="checkbox"/> To activate the numeric keypad, press the Num Lock key, which causes the Num Lock light to come on and remain on until the numeric keypad is deactivated.<input type="checkbox"/> To deactivate the Num Lock key, press the Num Lock key again, which causes the Num Lock light to go off.
Navigation keys	<p>The Left/Right/Up/Down arrows are devoted to move the cursor on the screen and also function as the Home, End, Page Up, and Page Down keys, respectively.</p>
Correction keys	<p>The Insert, Backspace, and Delete keys enable you to make corrections in your documents.</p>
Function keys	<p>The 12 function keys along the top of the keyboard are used to perform designated tasks. For example, in many applications, F1 is the Help key. The task associated with each function key may vary from one application to the next.</p>
Escape key	<p>The Esc (Escape) key is used to cancel commands.</p>
Print Screen key	<p>The Print Screen key takes an electronic snapshot of the screen and places it in the Windows Clipboard. You can then paste the screen shot into a document and print it.</p>

Change text in this variable definition to document title.

Key	Description
Operator keys	Several keys are always used with at least one other key: Ctrl, Alt, and Shift. When held down with another key, the Ctrl (Control) and Alt (Alternate) keys offer another way to give commands. For example, in many applications, instead of choosing the Save command from a menu, you can hold down Ctrl and press S (referred to as Ctrl+S). The Shift key operates the same way as on a typewriter; it is used to produce capital letters or special symbols such as @ and \$.
Windows key 	The key with the Windows logo displays the Windows Start menu; it is the equivalent of clicking the Start button on the task bar. See “Indicators” for more information.
Fn key	The Fn keys at the left and right sides work the same and are used in combination with other keys to issue commands. See “The Fn key in combination with other keys” for more information.
Applications key 	The Applications key displays a shortcut menu of context-sensitive choices; pressing this key is the equivalent of clicking the right mouse button.



Indicators

<i>Indicator</i>	<i>Function</i>
Power 	Light is green when the notebook is powered on, flashes amber when the notebook is in Standby mode, and turns off when the notebook is in Hibernate mode or is powered off.
Battery 	Indicates the status of the battery, which is attached at the rear of the notebook.
Memory Stick 	Indicates the Memory Stick slot is in use.
Docking Station 	Indicates the Docking Station is in use.







Indicator lights

<i>Light</i>	<i>On</i>	<i>Off</i>
Hard disk 	Data is being read from or written to the hard drive. Do not enter Standby mode or turn off the notebook when this indicator light is on.	The hard drive is not being accessed.

Change text in this variable definition to document title.

<i>Light</i>	<i>On</i>	<i>Off</i>
Num Lock 	The number keys in the numeric keypad are active.	The character keys in the keypad area are active.
Caps Lock 	Letters appear in uppercase as you type. The Shift key lowers the case of typed letters when Caps Lock is on.	Letters appear in lower case as you type (unless you hold down the Shift key).
Scroll Lock 	The screen scrolls differently. (Exactly how it scrolls depends on the specific application. It has no effect in many applications.)	Information moves across the display normally.

The Windows key in combination with other keys

<i>Combination</i>	<i>Function</i>
 + F1	Displays Windows Help.
 + Tab	Switches the selected button on the taskbar.
 + E	Displays Windows Explorer.
 + F	Displays the Windows Find: All Files window to find a file or folder. This is the equivalent of selecting Find then Files or Folders from the Start menu.
 + Ctrl + F	Displays the Windows Find: Computer window where you can locate other computers. This is the equivalent of selecting Find then Computer from the Start menu.
 + M	Minimizes all displayed windows.

Combination Function

Shift +  + M Returns all minimized windows to their previous size.





 + R Displays the Run window. This is the equivalent of selecting Run from the Start menu.





Fn +  + Insert Displays the Properties window. This is the equivalent of clicking the System icon in the Control Panel.

The Fn key in combination with other keys

**Combination/
Feature Functions**

Fn+  (F3) Toggles the built-in speaker off and on.
Speaker switch



Fn+  (F4) Adjusts the built-in speaker volume.
Speaker volume To increase volume, press Fn+F4, then  or .
To decrease volume, press Fn+F4, then  or .

Fn+  (F5) Adjusts brightness of the LCD.
Brightness control To increase light intensity, press Fn+F5, then  or .
To decrease light intensity, press Fn+F5, then  or .

Change text in this variable definition to document title.

**Combination/
Feature**

Functions

Fn+  / 
(F7)
Switch to the
external display

Toggles through the LCD and external display.

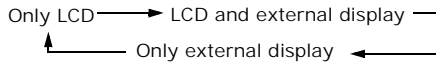

Fn+  (F12)
Hibernate

Provides for the lowest level of power consumption. When you execute this command, the state of the system and state of the peripheral devices are written to the hard disk and the system power is turned off. To return the system to the original state, use the power switch to turn on power.

Fn +F
Display control

Minimizes or maximizes the display window. Maximizing the display window allows you to view the display at a greater resolution.



You can also carry out these functions using the center Jog Dial™ control. Some functions are not available until Windows launches.

Using the Touchpad

The keyboard contains a cursor-pointing device called a touchpad. You can point to, select, drag, and scroll objects on the screen using the built-in touchpad.

Touchpad

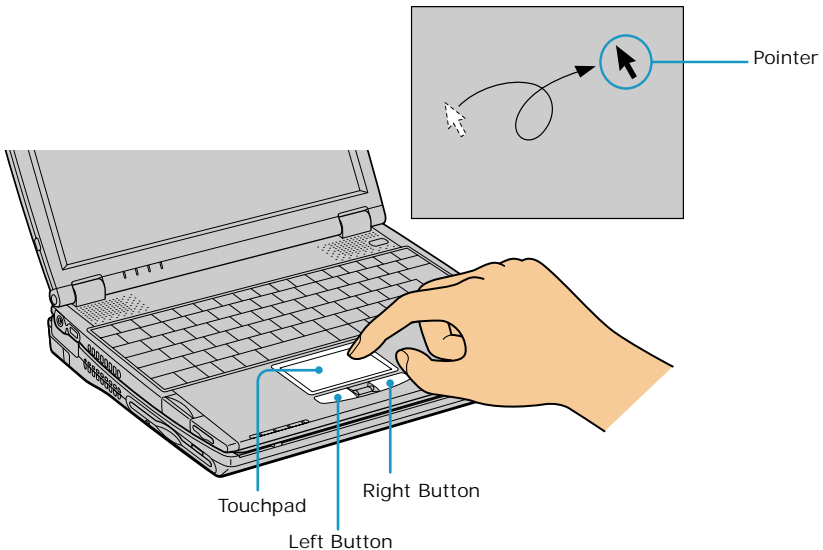

Actions	Descriptions
Point	Slide one finger on the touchpad to place the pointer on an item or object.
Click	Press the left button once.
Double-click	Press the left button twice.
Right-click	Press the right button once. In many applications, this action displays a shortcut menu of context-sensitive choices.
Drag	Slide one finger while pressing the left button.
Scroll	Move your finger along the right edge of the touchpad to scroll vertically. Move your finger along the bottom edge to scroll horizontally. (The scroll function is available only with applications that support a touchpad scroll feature.)

Change text in this variable definition to document title.



See Mouse Properties for information on touchpad features, such as clicking both buttons simultaneously, adjusting touchpad speed, and Easy Launcher functions. To access Mouse Properties, press the Start button, select Settings, and then select Control Panel. Double-click the Mouse icon in the Control Panel.

Using PC Cards

Your notebook includes a PC Card slot. PC Cards allow you to connect portable external devices.

 Note the following:

- The PC Card slot can accommodate one Type I or Type II PC Card and is compatible with a CardBus.
- Some PC Cards may require that you disable idle devices when using the PC Card. You can use Sony Notebook Setup to disable devices. See “Displaying the Sony Notebook Setup Screen” for more information.
- Be sure to use the most recent software driver provided by the PC Card manufacturer.
- If an “!” mark appears on the Device Manager tab in the System Properties dialog box, remove the software driver then reinstall it.

To insert a PC Card

 You do not need to shut down the notebook before inserting or removing a PC Card.

- 1 Insert the PC Card into the PC Card slot with front label facing up.
- 2 Gently push the card into the slot until the card is fixed into the connector and the release button pops out.

Inserting PC Card

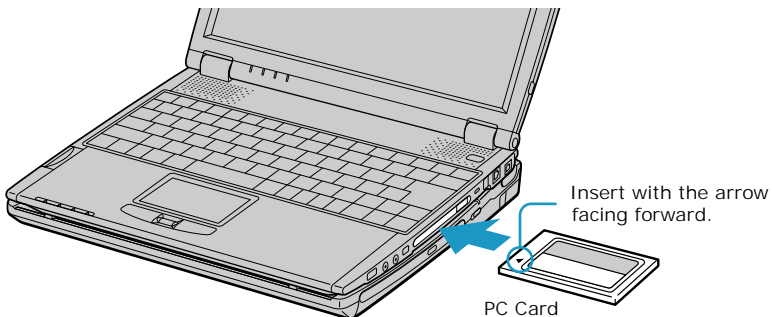

Change text in this variable definition to document title.

 Note the following:

- Do not force a card into the slot. It may damage the connector pins.
- If you have difficulty inserting a card, check that you are inserting the card with the correct orientation.
- Do not carry your notebook while the head of the PC Card (such as a wireless LAN card) is out of the slot. Pressure or shock may damage the connector pins.
- See the manual that came with your PC Card for more information on its use.

To remove a PC Card

 If your notebook is turned on, perform the following procedure to remove the PC Card from the notebook. Otherwise, your system might crash and you might lose data that you did not previously save.

If your notebook is turned off, do not perform this procedure.

- 1** Close any application that uses the PC Card, otherwise data may be lost.
- 2** Click the Unplug or Eject Hardware icon in the taskbar and select the card.
- 3** Click Stop, in the Stop a Hardware device dialog box, confirm the device to stop and click OK.
- 4** Click Close to close the Unplug or Eject Hardware window.
- 5** Pull the PC Card release button up and press it in toward the notebook.

Removing PC Card

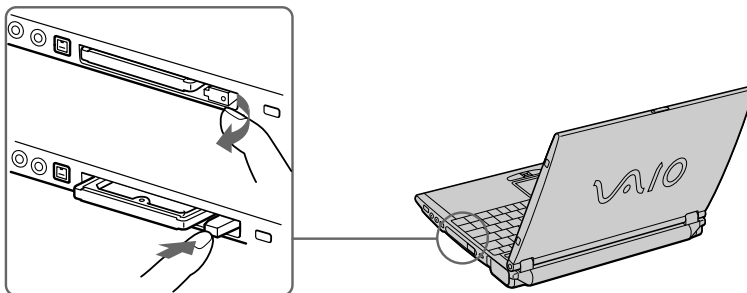

- 6 Gently grasp the card and pull it out.



Do not choose a USB disk or a Sony i.LINK optical drive in the Stop a Hardware device dialog box.

If you removed a Sony i.LINK optical drive by mistake, disconnect the docking station and reconnect it. See “Disconnecting the notebook from the docking station” for more information.



In some cases, if your notebook alternates between normal power operation and power saving mode while the PC Card is inserted, the notebook may not recognize the connected device. In such a case, reboot your notebook to correct the problem.

Connecting VAIO Computers

The preinstalled Smart Connect software enables you to use an optional i.LINK®* cable to connect your VAIO notebook to another VAIO computer that also has Smart Connect. You can then use one computer to edit, copy or delete files on the other computer. You can also print from a printer attached to either computer.

See Smart Connect online help for more information.

Connecting with an i.LINK cable

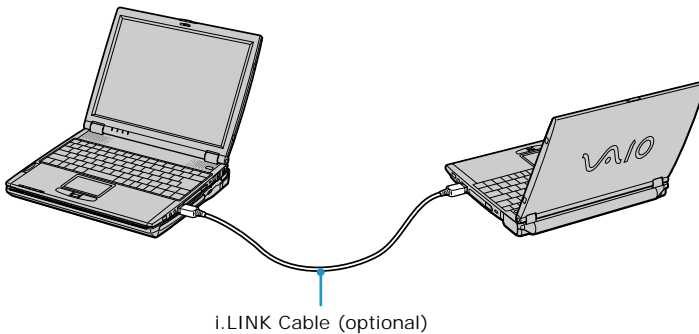

 Note the following:

- When you connect two VAIO computers, you must assign each computer a unique name. The computers can be identified by this unique name when the two computers are networked together.
- If you have previously purchased a VAIO computer or notebook that does not have Smart Connect 3.0 software preinstalled, consult the Sony Web site for support options (<http://www.sony.com/pcsupport>).

* i.LINK is a trademark of Sony used only to designate that a product contains an IEEE 1394 connection. The i.LINK connection may vary, depending on the software applications, operating system, and i.LINK-compatible devices. All products with an i.LINK connection may not communicate with each other.

Please refer to the documentation that came with your i.LINK-compatible device for information on operating conditions and proper connection. Before connecting i.LINK-compatible PC peripherals to your system, such as CD-RW or hard disk drive, confirm their operating system compatibility and required operating conditions.

If your notebook is connected to the optional docking station

If you want to exchange data with another computer using the optional i.LINK cable and your notebook is connected to the docking station, perform the following:

- 1 Disconnect your notebook from the docking station as described in the “Disconnecting the notebook from the docking station” section.
- 2 Disconnect the AC adapter and all cables from the docking station.
- 3 Using a thin pen tip, set the i.LINK network switch on the bottom of the docking station to the side marked ●.



Do not set the i.LINK network switch when the notebook is on. The notebook will malfunction.

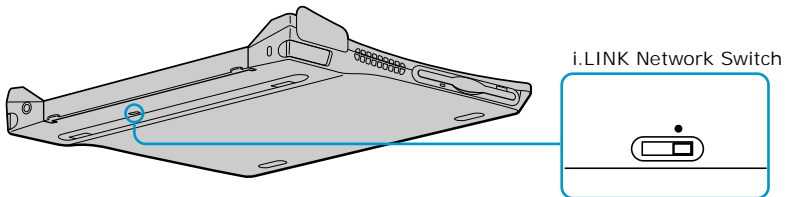

i.LINK Network Switch

- 4 Connect the docking station to your notebook as described in the “Connecting the notebook to the docking station” section.
- 5 Turn on the notebook, and use the i.LINK cable to connect your notebook to another computer.
- 6 After you have finished the tasks you needed to perform to end the “smart connect” session, proceed as follows:
 - Disconnect your notebook from the docking station.
 - Disconnect the i.LINK cable and all other cables from the docking station.

Change text in this variable definition to document title.

- ❑ Set the i.LINK network switch to the unmarked side.

VAIO Action Setup

VAIO Action Setup manages the settings for your notebook's center Jog Dial™ control, Memory Stick® media, and i.LINK® interface. An overview of some of the functions controlled by VAIO Action Setup is provided below. For more information on changing the settings using VAIO Action Setup, right-click the Jog Dial Utility icon  or  in the task tray and click Help Topics.

Using the Center Jog Dial Control

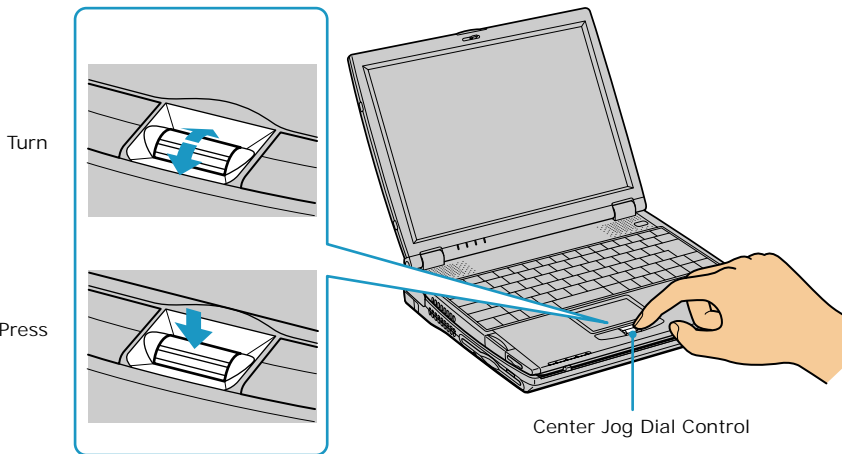

Your notebook is equipped with a center Jog Dial control located below the touchpad and between the left and right buttons. The center Jog Dial control enables you to open an application, folder, or document from a predefined list by rotating and pressing the center Jog Dial control. In addition, when you press the center Jog Dial control, you can turn on your notebook automatically and start the selected application or document.

Center Jog Dial Control



The Jog Dial control window always appears in the display. It is either in the launcher mode or in the guide mode.

Using the center Jog Dial control

This section explains how to use the center Jog Dial control. For information on how to change the settings of the center Jog Dial control, right-click the Jog Dial Utility icon  or  in the task tray and click Help Topics.

Launcher mode

The Jog Dial control window is in launcher mode until a software application is launched or the Jog Dial control window becomes active. When you select an item in the Jog Dial window and it is displayed between orange bars, you can press the center Jog Dial control to view a submenu of that item.

Using Launcher mode

To use the center Jog Dial control, click the Jog Dial control window or the Jog Dial Utility icon in the task tray. Alternatively, you can press the Ctrl key and the center Jog Dial control while the Jog Dial window is active to switch to launcher mode.

Jog Dial Launcher



To select a desired item, proceed as follows:

Change text in this variable definition to document title.

- 1 Rotate the center Jog Dial control to select the item you want, then press the center Jog Dial control. The Jog Dial launcher window switches to guide mode and shows the function of the center Jog Dial control.

Jog Dial Guide



- 2 Rotate or press the center Jog Dial control to use the desired function.
- 3 To select another item, repeat steps 1 through 3 above.

Guide Mode

The Jog Dial control window is in the guide mode when software is in use and the software window is active. Depending on the software you are using, you can select items from the displayed list using the center Jog Dial control. You can switch between guide mode and launcher mode by pressing the Ctrl key and the center Jog Dial control.

Using Guide mode

The Jog Dial control window displays the function of the center Jog Dial control.

Using the center Jog Dial control with Sony software

If Sony software that supports the center Jog Dial control is active, you can use the functions of the center Jog Dial control that are allocated to that software. For more information on functions allocated to software, see the software application's online Help.

Using the center Jog Dial control with other software

If the software you are using does not support the center Jog Dial control, you can still use the center Jog Dial control to scroll the window or adjust the window size.

Using a dialog box

When a window such as Screen Properties is active, the Dialog box is displayed in the Jog Dial window. You can select an item in the window by rotating the center Jog Dial control. Pressing the center Jog Dial control is the equivalent of pressing Enter or Select.

Jog Dial Guide Dialog Box





Using Memory Stick Media

This compact, portable, and versatile recording medium has a data capacity exceeding that of a floppy disk. The medium is specially designed for exchanging and sharing digital data with compatible products. Because it is removable, the media can be used for external data storage.

Types of Memory Stick media

The following two types of Memory Stick media can be used with your notebook:

- ❑ MagicGate™  media (hereafter called MG Memory Stick media), which is provided with copyright protection.
- ❑ Memory Stick  media, which does not have the same copyright protection as MagicGate media.

Some music files encoded with secure copyright protection may be stored on MG Memory Stick media but not on regular Memory Stick media. You can also use MagicGate media-compatible devices to record and playback music when they are connected to your notebook.

You can store mixed data on the Memory Stick media. For example, you can copy an image on to MG Memory Stick media that already contains music.

What is MagicGate media?

MagicGate media provides copyright protection that consists of authentication and encryption technology. Authentication technology ensures that protected content is only transferred between compliant devices and media. Protected content is recorded and transferred in an encrypted format to prevent unauthorized duplication or playback.



MG Memory Stick media has the MG mark .

To insert a Memory Stick media

- 1 Insert the Memory Stick media with the arrow facing upward and toward the Memory Stick media slot.



Inserting the media in the wrong direction may damage the connector pins.

- 2 Carefully slide the Memory Stick media in until it clicks in place.

Inserting Memory Stick Media

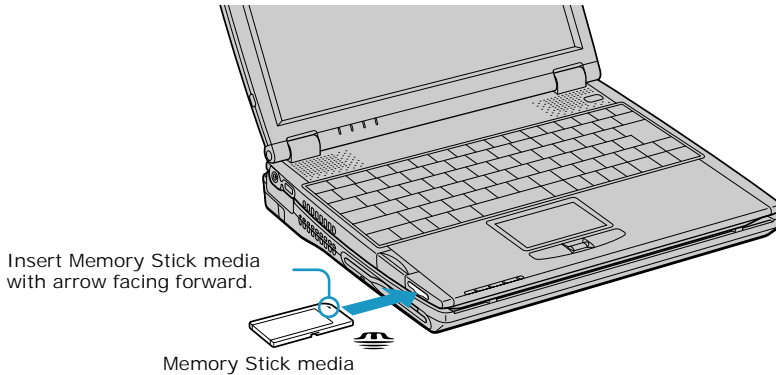

 At the default setting, Visual Flow™ application starts automatically when you insert a Memory Stick media. You can change this setting in VAIO Action Setup.

To view the contents of Memory Stick media

Click the Removable Disk (S:) icon under My Computer to see the contents of the Memory Stick media.

To remove a Memory Stick media

- 1 Ensure that the access light is off.
- 2 Push the Memory Stick media in toward the notebook.
- 3 When the Memory Stick media ejects, pull it out.

 Be careful when removing the Memory Stick media, as it may eject completely from the slot.

Write-protecting a Memory Stick media

Memory Stick media is designed with a write-protect tab to protect valuable data from accidental erasure or overwriting. Move the tab to the right or left to set or release write-protection.

Write-protect off Data can be saved on the Memory Stick media.

Write-protect on Data can be read from but not saved on the Memory Stick media.

Using the Write-protect Tab

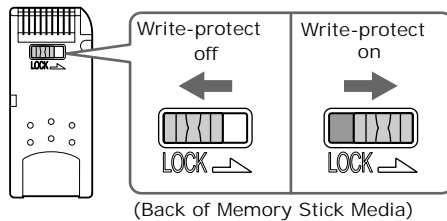

Formatting a Memory Stick media

Memory Stick media is formatted for immediate use when you purchase it. If you need to reformat a Memory Stick media, use the Memory Stick Formatter that is provided with the media. Follow the procedures included here. For more details about using Memory Stick Formatter, refer to Formatter Help.



Reformatting erases all current data that is stored on a Memory Stick media. Before you reformat, confirm that the media does not contain files you want to keep.

- 1 Insert the Memory Stick media into the notebook. See “To insert a Memory Stick media” for information on inserting Memory Stick media.
- 2 Click the Start button, point to Programs, click Memory Stick Utility, and then click Memory Stick Formatter.
- 3 Click Start Formatter. Memory Stick Formatter begins.

Notes on Memory Stick media

- ❑ When the erasure prevention switch of the Memory Stick media is set to LOCK, data cannot be recorded or erased.
- ❑ Before using Memory Stick media, back up important data.
- ❑ Wait a minimum of 10 seconds after the Memory Stick media finishes reading or writing data before removing the media.
- ❑ If the media is removed prematurely, a blue screen with an error message appears, prompting you to continue or exit. Reinsert the media into the slot and press Enter to continue. This allows the media to finish reading or writing data.
- ❑ You can enjoy video clips that you have recorded with Memory Stick media-compatible video camera recorders.
- ❑ The media slot can accommodate one Memory Stick media at a time.
- ❑ You may copy images from a digital video camera using Memory Stick media.
- ❑ Only MagicGate™ Memory Stick media can be used with copyright protected data such as music.
- ❑ Copyright protected music cannot be checked-out to any Memory Stick media other than MG Memory Stick media.
- ❑ Recorded music is limited to private use only. Using recorded music for any other purpose requires permission of the copyright holders.
- ❑ Sony is not responsible for music files that cannot be recorded from a CD or downloaded from other sources.
- ❑ Formatting Memory Stick media erases all data (including music data) previously saved to it. Before you format Memory Stick media, confirm that the media does not contain files you want to keep.

Cautions on Memory Stick media

- ❑ Do not use the media in locations that are subject to static electricity or electrical noise.
- ❑ Do not touch the media connector with your finger or metallic objects.
- ❑ Do not attach labels other than the supplied label to a media.
- ❑ Do not bend, drop, or apply strong shock to the media.
- ❑ Do not disassemble or modify the media.

Change text in this variable definition to document title.

- ❑ Do not allow the media to get wet.
- ❑ Do not use or store the media in a location that is subject to:
 - ❑ Extremely high temperatures, such as in a car parked in the sun
 - ❑ Direct sunlight
 - ❑ High humidity or places with corrosive substances
- ❑ To prolong the life of the media, use the supplied storage case. See the instructions that come with your media for more information on use.

Using Power Saving Modes

When you use a battery as the source of power for your notebook, you can take advantage of power management settings to conserve battery life. In addition to the normal operating mode, which allows you to turn off specific devices, your notebook has two distinct power saving modes: Standby and Hibernate. When using battery power, be aware that the notebook automatically enters Hibernate mode when the remaining battery charge drops below 5 percent, regardless of the power management setting you select.



If the battery level falls below 10 percent, you should either attach the AC adapter to recharge the battery or shut down your notebook and insert a fully charged battery.

Normal mode

Normal mode is the normal state of your notebook when it is in use. The power indicator light displays green when your notebook is in this mode. To save power, you can turn off a specific device such as the LCD or the hard disk.

Standby mode

In Standby Mode the notebook saves the current state of the system in RAM and switches off power to the CPU. The amber power indicator light flashes in this mode.

To activate Standby mode

To activate Standby mode, press the power button and release it immediately. You can also use the PowerPanel utility to enter Standby mode.

To return to Normal mode

Press any key to return to normal mode.

Hibernate mode

In the Hibernate mode, the state of the system is saved on the hard drive and power is turned off. The power indicator light is off in this mode.

To activate Hibernate mode

To activate Hibernate mode, press the key combination Fn+F12.

 The "Save to Disk Manager" window appears, and then the notebook enters Hibernate mode.

Do not move the notebook until its power indicator light turns off.

To return to Normal mode

To return to normal mode, turn on the notebook by pressing the power button. The notebook returns to its previous state.

 When returning from Hibernate mode, the system status stored on the hard disk is erased and the notebook starts normally if you press the power button and hold for more than four seconds.

- ❑ Time required to return to normal mode
Standby requires less time than Hibernate to return to normal mode.
- ❑ Power consumption
Standby uses more power than Hibernate.

Using a Phone Line

You need to connect a phone line to take advantage of online services, the Internet, and Sony Customer Support.

In order to register your Sony VAIO® notebook, register your software online, and use Sony Customer Support, you must connect the notebook to a phone line.

- 1 Gently peel back the rubber phone jack cover. Pulling the phone jack cover too hard could damage it.



Do not plug the phone cable into the Ethernet port  located to the left of the phone jack as this may damage your notebook.

- 2 Plug one end of the phone cable into the phone jack, under the phone jack cover. Make sure you insert the phone cable from the rear of the notebook and that the modular jack clicks into place.
- 3 Plug the other end into the wall jack.

Plugging Phone Cable into Phone Jack

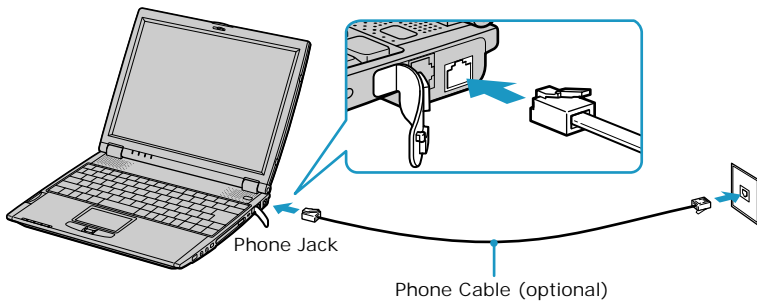



Your notebook does not work with party lines, cannot be connected to a coin-operated telephone, and may not work with multiple phone lines or a private branch exchange (PBX). Some of these connections might result in excess electrical current and could cause a malfunction in the internal modem.

Using the LAN

You can connect your notebook to 10Base-T and 100Base-TX-type Local Area Networks (LANs). For the detailed settings and devices needed to connect to the network, please ask your network administrator.

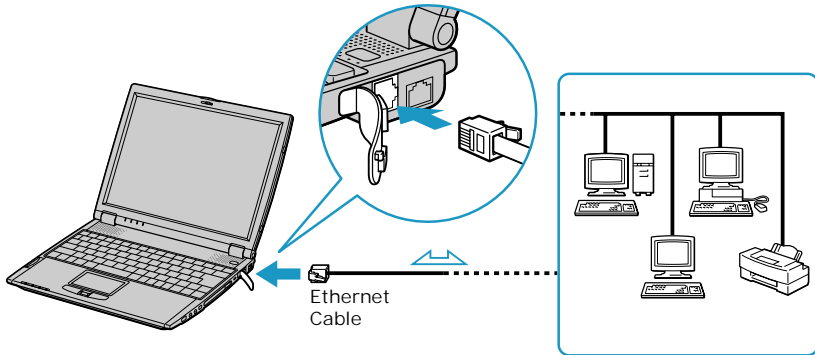
Connecting to LAN



Only connect 10Base-T and 100Base-TX cables to the  (Ethernet port). Do not connect any other type of network cable or any telephone line. Connecting cables other than those listed above may result in an electric current overload and could cause a malfunction, excessive heat, or fire in the port. To connect the unit to the network, contact your network administrator.

Connecting Peripheral Devices

You can add functionality to your notebook by connecting it to a variety of peripherals, as discussed in the following sections:

- Connecting the Optional Docking Station
- Connecting the Floppy Disk Drive
- Connecting an Optical Drive
- Connecting a Printer
- Connecting an i.LINK Device
- Connecting an External Display
- Connecting a USB Device
- Connecting External Speakers
- Connecting an External Microphone

Connecting the Optional Docking Station





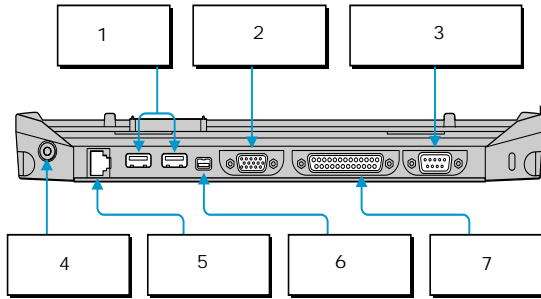

Your notebook supports an optional docking station that provides the following:

- A floppy disk drive.
- An optical drive.
- A back panel that enables you to connect additional peripherals to your notebook as shown below.

Change text in this variable definition to document title.

Back Panel



- | | | | |
|---|--|---|---|
| 1 |  USB ports | 5 |  Ethernet port
(10BaseT/100Base-TX) |
| 2 |  Monitor port | 6 |  i.LINK* [®] (IEEE 1394)
S400 port |
| 3 |  Serial port | 7 |  Printer port |
| 4 |  DC In port | | |

Left

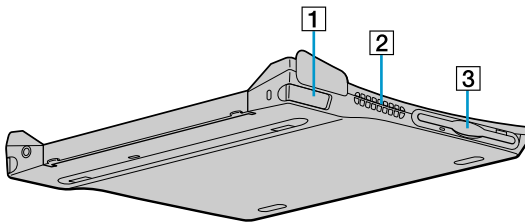

- | | | | |
|---|------------|---|-------------------|
| 1 | Left lever | 3 | Floppy disk drive |
| 2 | Air vent | | |

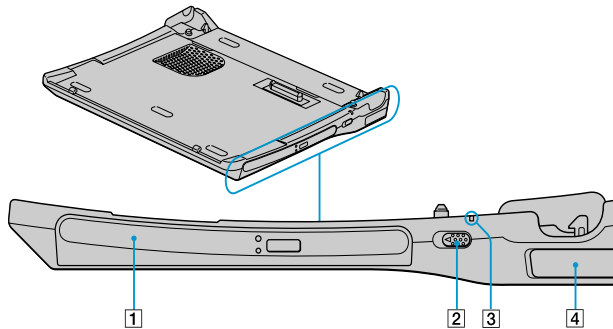
Right

- | | | | |
|---|---------------|---|-----------------|
| 1 | Optical drive | 3 | DC In indicator |
| 2 | UNDOCK switch | 4 | Right lever |

Connecting the notebook to the docking station

You may connect your notebook to the docking station as long as it is not in power saving mode, i.e., Standby or Hibernate. Connecting the notebook while it is in power saving mode may result in data loss or a computer malfunction.



Note the following *before* connecting your notebook to the docking station:

- Disconnect the VGA, USB, AC, and Ethernet devices from your notebook. Leaving these devices connected while you connect the docking station could damage them.
- Ensure that the battery is installed. If you install a charged battery, you can connect the docking station while the notebook is on.

Follow the procedure below to connect your notebook to the docking station:

- 1 Plug one end of the AC adapter cable into the DC In port of the docking station and the other end into an AC outlet. The LED of the DC In port switches on.
- 2 Holding the notebook with the front side facing you, insert the two holes on the front of the notebook into the two corresponding latches protruding from the front side of the docking station.

Latching the Notebook to the Docking Station

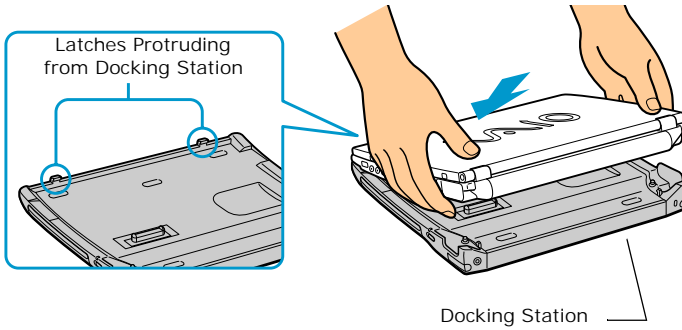

- 3 Firmly press with your thumbs the two rear corners of the notebook, until your notebook clicks in place and is securely fastened to the docking station.



Be careful not to press the top of the notebook too strongly; the LCD display may be damaged.

Securing the Notebook to the Docking Station

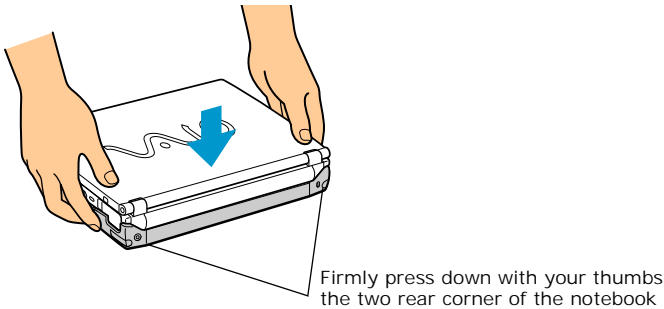

Disconnecting the notebook from the docking station

There are two procedures to consider when disconnecting your notebook from the docking station:

- Disconnecting the docking station when the notebook is *off*.
- Disconnecting the docking station when the notebook is *on*.



Beware of the following to ensure proper operation of your notebook:

- Do *not* disconnect the notebook from the docking station while the docking indicator is on.
- Do *not* disconnect the docking station during power saving modes, i.e., while the notebook is in Standby or Hibernate mode.
- If you do any of the above, you may lose data or cause the notebook to malfunction.
- Do *not* disconnect the notebook from the docking station, if the battery power is low; you may lose data. Shut down your notebook first, then disconnect from the docking station.

Perform the appropriate procedure below to disconnect the docking station.

Disconnecting the docking station when the notebook is off



Before disconnecting your notebook from the docking station, ensure the following:

- All i.LINK devices are disconnected from your notebook and docking station.
- No object is placed on top of the notebook.

Change text in this variable definition to document title.

- 1 Pull out the two release levers on either side of the rear corners of the docking station, to release the notebook from the docking station.

Releasing the Notebook from the Docking Station

Pull release levers on either side of rear corners of docking station

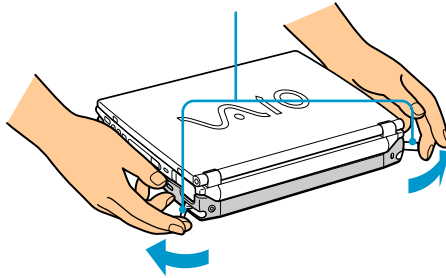

- 2 Remove the notebook from the docking station, while moving the notebook slightly back to disengage it from the two front latches of the docking station.

Removing the Notebook from the Docking Station

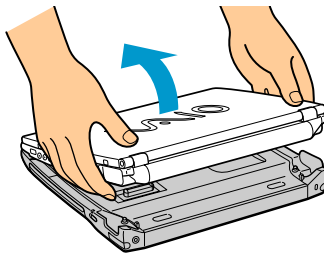

Disconnecting the docking station when the notebook is on

You can use the Start Menu in the Windows task tray or the UNDOCK switch on the docking station to disconnect your notebook from the docking station while the notebook is on.

From the Start menu

- 1 Click the Start menu in the Windows task tray.
- 2 Select Eject PC to access the “Undock Complete” dialog box.



Wait for the docking indicator light to switch off before undocking the notebook.



Once the “Undock Complete” dialog box appears, continue on to step 3 to finish undocking the notebook. This prevents from leaving the notebook on the docking station in this released state for too long.

Docking Indicator Light

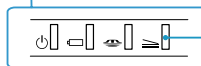
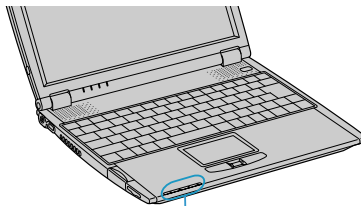

Docking Indicator Light

- 3 Release and remove your notebook as described in the “Disconnecting the docking station when the notebook is off” section.

Using the UNDOCK switch

- 1 Pull the UNDOCK switch on the right side of your notebook. The “Undock Complete” dialog box appears.



Once the “Undock Complete” dialog box appears, continue on to step 2 to finish undocking the notebook. This prevents from leaving the notebook on the docking station in this released state for too long.

Change text in this variable definition to document title.

UNDOCK switch

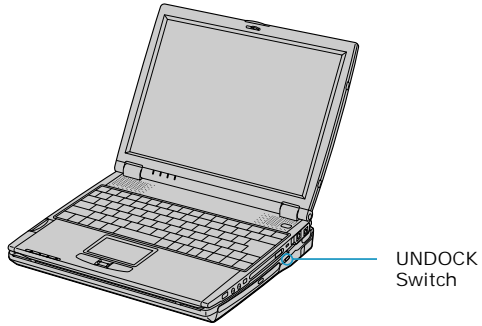

- 2 Release and remove your notebook as described in the “Disconnecting the docking station when the notebook is off” section.

Connecting the Floppy Disk Drive

You can use the floppy disk drive in the optional docking station. If you do not utilize the docking station drive, you can connect an optional PCGA-UFD5 floppy disk drive to one of the two USB ports ♪ on your notebook.



Do not use an optional PCGA-UFD5 floppy disk drive while your notebook is connected to the docking station.

To insert a floppy disk

- 1 Hold the floppy disk with the label side facing up.
- 2 Gently push the floppy disk into the drive until it clicks into place.

Inserting Floppy Disk

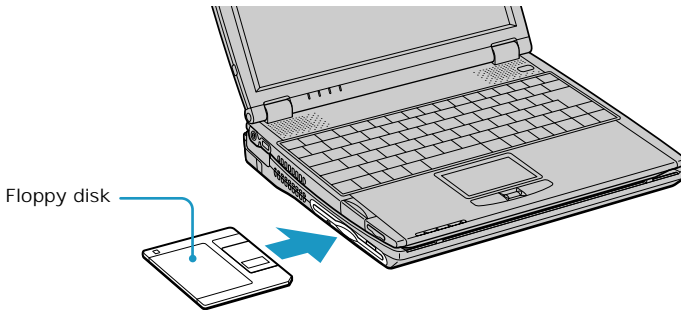

To remove a floppy disk

- When you finish using the floppy disk, wait until the LED indicator light turns off and then press the Eject button to remove the floppy disk.

Removing Floppy Disk

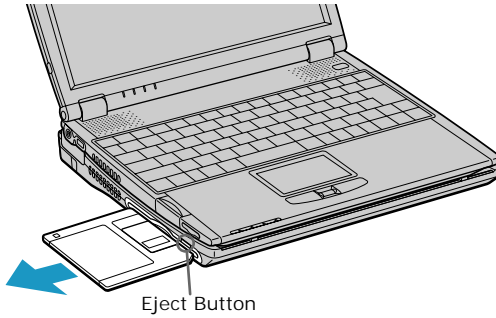

Notes on handling floppy disks

- Do not open the shutter manually and touch the surface of the floppy disk.
- Keep floppy disks away from magnets.
- Keep floppy disks away from direct sunlight and other heat sources.

Connecting an Optical Drive

You may use the optional PCGA-DSD5 CD-RW/DVD Docking Station or PCGA-DSD5 DVD Docking Station with your notebook. Both Sony optional docking stations come with a built-in optical drive. If you do not utilize the docking station drive, you can connect an optional optical drive, such as PCGA-CD51/A, to the PCMCIA PC Card slot.



Do not use an optional optical drive while your notebook is connected to the docking station.

To insert a disc



If you are using a PC Card (such as a wireless LAN card) with its head out of the slot, remove it before you insert a disc.

- 1 Press the Eject button. The disc tray slides out.

Inserting a Disc

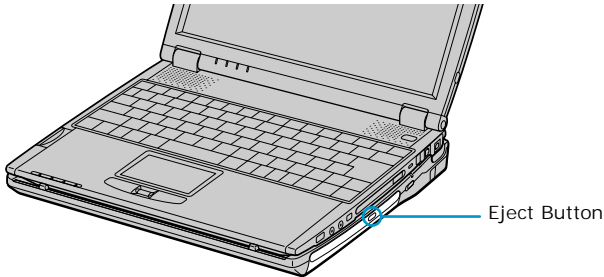

- 2 Place the disc in the tray with the label side facing up. Push the disc onto the hub until the disc clicks into place.

Inserting Disc

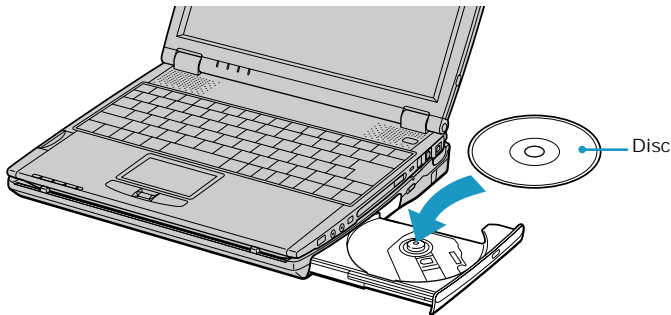

- 3 Close the tray by pushing it gently. The BUSY indicator on the drive flashes while your notebook reads data from the disc.



When the notebook is in power saving mode, the tray will not open.

Playing a DVD

- ❑ To achieve optimum performance when playing DVDs, it is recommended that you close all open applications before playing a DVD movie.
- ❑ When playing DVD movies on battery power, set the power management profile to DVD. With other profiles, the movies are choppy. As an alternative, you can set the power management profile to Automatic Profile Selection, which will cause the DVD profile to be selected automatically whenever you insert a DVD. See “Controlling Power Management” for information on how to set the power management profile.
- ❑ You can play DVDs using the WinDVD® software. See the help file that came with the WinDVD software for details.
- ❑ Some discs recorded at 20 or 24 bits may produce noise while playing. If you have audio devices connected, this may cause damage to your hearing and the speakers. Reduce the volume before playing such discs.

 Note the following for playing a DVD:

- Do not switch between LCD and external display while playing a DVD video.
- Do not put your notebook into power saving mode while playing a DVD video.
- Do not install the software that comes with DVD51/A drive.
- Some DVD videos may allow limited operations or functions, or present sound noise or dropped frames.



Memory-resident disc utilities, such as the screen saver and virus checker, may cause unstable operation or data loss. Deactivate these utilities (if they are active) before writing data to a disc.

Handling and cleaning CD and DVD media

Proper care of the disc is essential to maintain its reliability. Follow these guidelines:

Handling

- Do not drop or bend the disc.
- Do not touch the surface of the disc. Fingerprints and dust on the surface of a disc may cause read errors.

Cleaning

- For normal cleaning, hold the disc by its edge and use a soft cloth to wipe the surface from the center out.
- If the disc is badly soiled, moisten a soft cloth with water, wring it out well, and use it to wipe the surface of the disc from the center out. Wipe off any remaining moisture with a dry soft cloth.
- Do not use solvents such as benzene, thinner, commercially available cleaners or anti-static spray, as they may cause damage to the disc.

Writing data to CD-R/RW media

You can use Drag'n Drop CD™ software to write data to a CD-R or CD-RW. To use Drag'n Drop CD, see the online help manual that comes with the software.



Note the following when using an optical drive to write to a CD-R/RW:

- For optimal writing speed, deactivate the screen saver and exit anti-virus software before writing data to a disc.
- For best results, use CD-Rs that are compatible with 4x speed.
- Do not put your notebook into power saving mode while using Drag'n Drop CD.



Beware of the following:

- Do not use the Eject PC option in Windows or press the UNDOCK switch on the docking station while writing data to a CD-R or CD-RW. Doing so may severely damage your notebook.
- Do not strike or shake the notebook while writing data to a disc.
- Memory-resident disc utilities, such as the screen saver and virus checker, may cause unstable operation or data loss. Deactivate these utilities (if they are active) before writing data to a disc.
- Always use the AC adapter as the power source for your notebook when you are writing data to a CD-R or CD-RW. Using battery power may result in data transfer failure.

Connecting a Printer

- ❑ You can connect a Windows 2000 compatible parallel port printer to the optional docking station.
- ❑ You can also connect a Windows 2000 compatible USB printer to either of your notebook's two USB ports.



Turn off the notebook before connecting peripherals. In normal use, you should turn on the peripherals before turning on your notebook.

To connect a printer

To a parallel port

- 1 Locate the  Printer port on the docking station.
- 2 Plug the printer cable (supplied with the printer) into the Printer port.

Connecting a Printer to the Docking Station

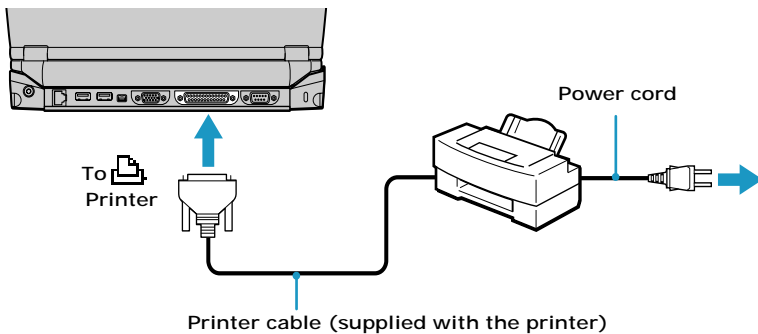

To USB ports

- 1 Locate the  USB ports on your notebook and printer.
- 2 Plug the optional USB printer cable into one of the two USB ports.

Connecting a USB Printer

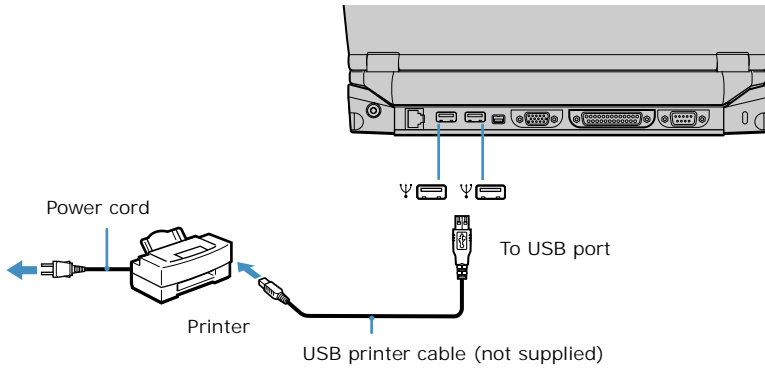

Note the following:

- See the manuals that came with your printer for more information on printer installation and operation.
- Before operating the printer, ensure that the Printer setting in the Sony Notebook Setup software is properly set. See "Displaying the Sony Notebook Setup Screen" for more information.

Connecting an i.LINK* Device

Your VAIO notebook includes an  i.LINK (IEEE 1394) S400 port, which you can use to connect to a compatible i.LINK device such as a digital video camera recorder.

To connect a digital video camera recorder

Plug one end of an i.LINK cable into the  S400 port on the right side of the notebook and the other end into the DV In/Out port on the digital video camera recorder. If your digital video camera recorder includes a Memory Stick® media slot, you can copy images from it to your notebook via a Memory Stick media. Copy images to the Memory Stick media and insert the media into the Memory Stick media slot on your notebook. See “Using Memory Stick Media” for more information on using Memory Stick media.

* i.LINK is a trademark of Sony used only to designate that a product contains an IEEE 1394 connection. The i.LINK connection may vary, depending on the software applications, operating system, and i.LINK-compatible devices. All products with an i.LINK connection may not communicate with each other.

Please refer to the documentation that came with your i.LINK-compatible device for information on operating conditions and proper connection. Before connecting i.LINK-compatible PC peripherals to your system, such as CD-RW or hard disk drive, confirm their operating system compatibility and required operating conditions.

Change text in this variable definition to document title.

Connecting Digital Video Camera Recorder

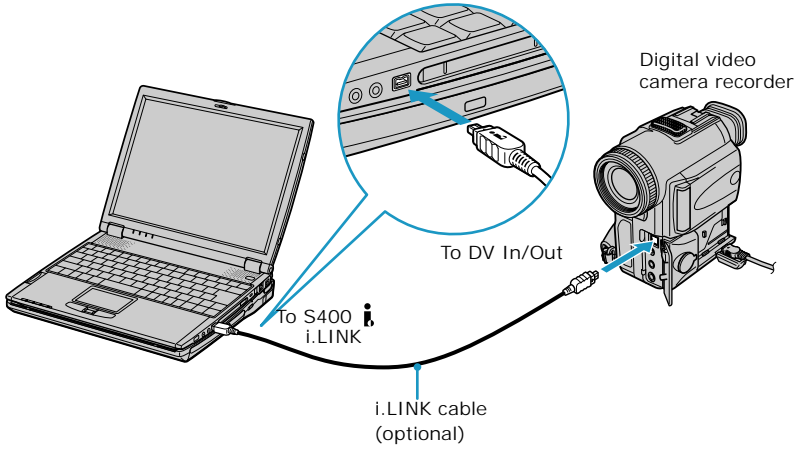

 Note the following:

- ❑ The above figure displays connection to a Sony digital video camera; your digital video camera recorder may need to be connected differently.
- ❑ Only Sony digital video cameras and ports labeled "DV In/Out" or "i.LINK" are compatible i.LINK devices.
- ❑ See the manual that came with your digital video camera recorder for more information on installation and use.
- ❑ The i.LINK port does not supply power to external devices. If the external device requires power from the i.LINK port, you cannot use the device with your notebook.
- ❑ The VAIO notebook supports transfer rates up to 400 Mbps; however, the actual transfer rate is the lowest transfer rate of the external device.
- ❑ The i.LINK features available may vary depending on the software applications you use. See the documentation that came with your software for more information.
- ❑ You can connect a digital video camera to the i.LINK port on your notebook or the i.LINK port on the optional port replicator. When a camera is connected to the i.LINK port on the notebook, you should not connect any other devices to the i.LINK port on the port replicator. When a camera is connected to the i.LINK port on the port replicator, you should not connect any other devices to the i.LINK port on the notebook.

i.LINK cables compatible with your VAIO notebook include cables with the following part numbers: VMC-IL4415A (a 1.5-meter cable with a 4-pin connector at each end), VMC-IL4615A (a 1.5-meter cable with a 4-pin connector at one end and a 6-pin connector at the other). You can purchase these cables from your local retailer, through the Sony VAIO® Direct Web site (<http://vaio.sonystyle.com>) or by calling 1-888-315-7669 (toll free).

Connecting an External Display

You can connect a computer display (monitor) or projector to your notebook or docking station.

To connect a monitor

Using the notebook

- 1 Locate the monitor port on the left side of the notebook.
- 2 Plug the optional display cable into the monitor port.

 Ensure that one end of the power cord of the monitor is plugged into the display, and the other end is plugged into an AC outlet.

Connecting Monitor

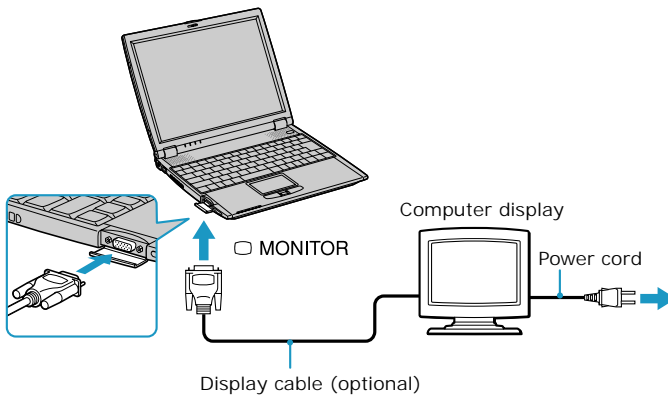

 You cannot use the Monitor port on your notebook when the docking station is connected to the notebook.

Using the docking station

- 1 Locate the  monitor port on the rear panel of the docking station.
- 2 Plug the optional display cable into the monitor port.

 Ensure that one end of the power cord of the monitor is plugged into the display, and the other end is plugged into an AC outlet.

Connecting Monitor

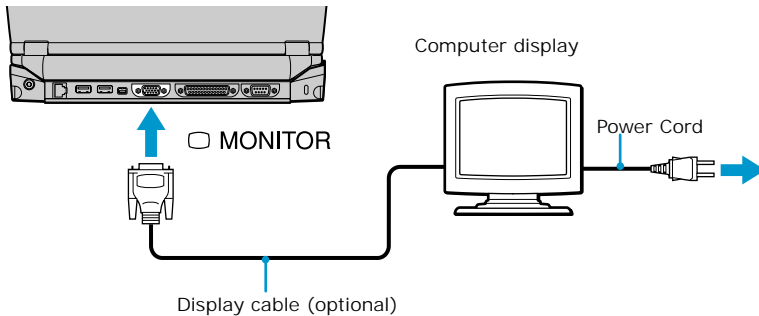

 See the manuals that came with your printer, and the docking station if applicable, for more information on printer installation and operation.

To connect a projector

You can use a projector, such as the Sony LCD Projector, as an external display.

Using the notebook

- 1 Locate the monitor port on the left side of the notebook.
- 2 Plug the RGB signal cable into the monitor port.
- 3 Plug the audio cable into the green Headphone jack on the right side of the notebook.

Connecting projector

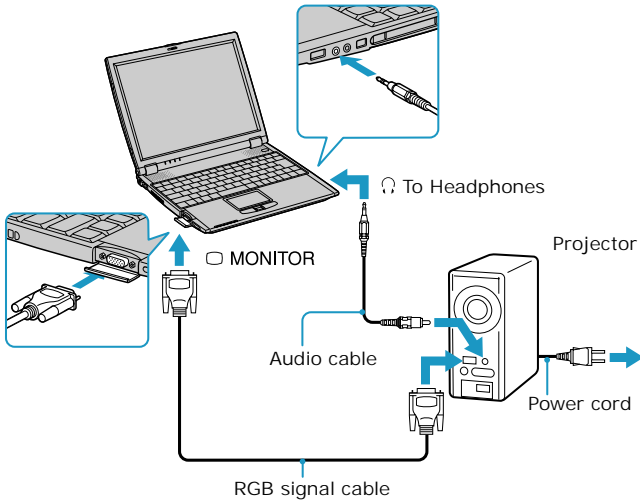

Using the docking station

- 1 Locate the monitor port on the rear panel of the docking station.
- 2 Plug the optional monitor adapter into the monitor port.
- 3 Plug the audio cable into the green Headphone jack on the right side of the notebook.

Connecting projector

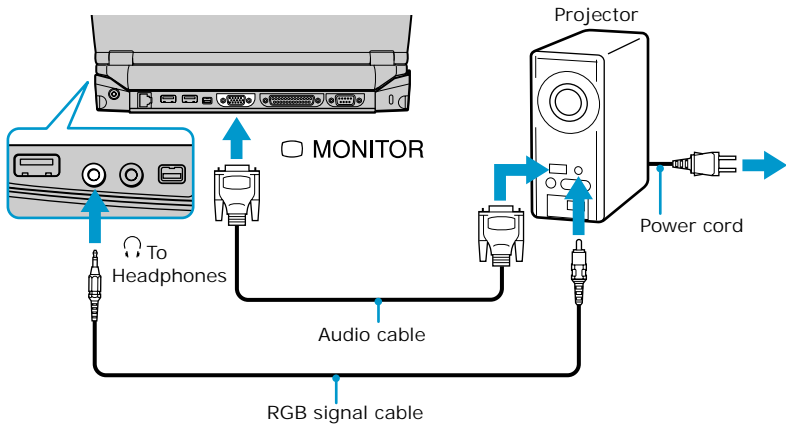

Note the following:

- See the manual that came with your projector for more information on installation and operation.
- You cannot use the Monitor port on your notebook when the docking station is connected to the notebook.

To select a display

When you connect an external display to the monitor port, you can press **Fn+F7** to toggle the output between the Liquid Crystal Display (LCD), the external monitor, or both devices. See “Selecting the Display Mode” for more information.

Connecting a USB Device

You can connect a Universal Serial Bus (USB) devices such as an external mouse, keyboard, speaker, and microphone to your notebook.

To connect a USB device

Using the notebook

- 1 Locate a  USB port on the notebook. There are two USB ports on the notebook, one on the right side and one on the left side.
- 2 Plug on end of the USB cable into a port and the other end into the USB device.

Connecting USB Device

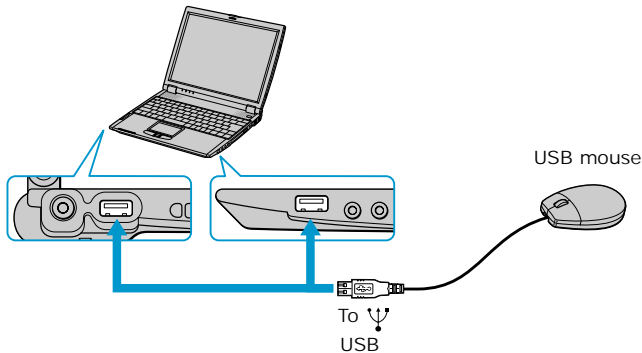

Using the docking station

- 1 Locate a  USB port on the optional docking station. There are two USB ports located on the back side of the docking station.
- 2 Plug one end of the USB cable into a port and the other end into the USB device.

Connecting USB Device

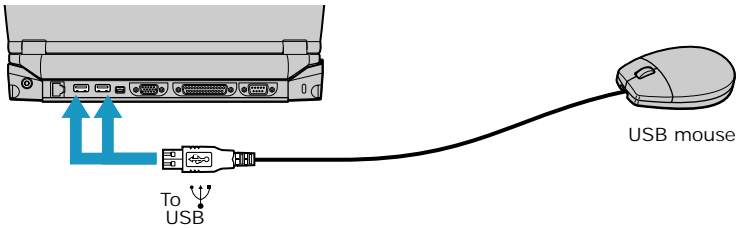

You can use an optional Sony USB mouse PCGA-UMS1 series (not supplied) with this notebook. Since the USB mouse software driver is preinstalled in the notebook, you simply plug the USB mouse into the USB port to use it. One USB port supports one USB device.

 See the manual that came with your USB device for more information on its installation and use.

Connecting External Speakers

You can connect external speakers to your notebook to enhance the sound quality of your computer.

 Note the following when connecting external speakers:

- Make sure your speakers are designed for computer use.
- Turn down the volume of the speakers before you turn them on.
- Do not place floppy disks on the speakers; the magnetic field of the speakers may damage the data on the floppy disks.

To connect external speakers

- 1 Locate the green Headphone jack on the right side of your notebook.
- 2 Plug the speaker cable into the Headphone jack.

Connecting Speakers to the Headphone Jack

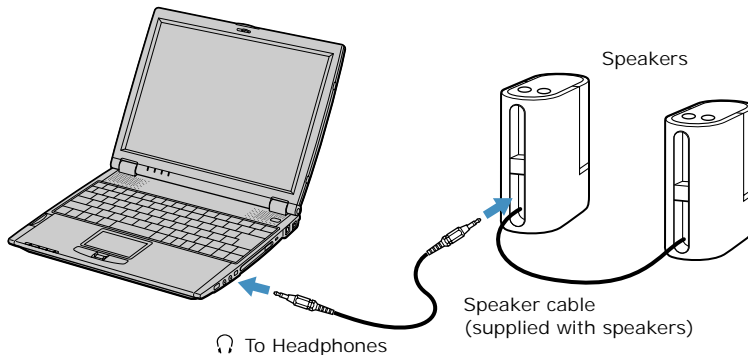

 See the manual that comes with your speakers for more information on installation and use.

Connecting an External Microphone

You can use an external microphone to enhance the quality of the sound input.

 Make sure your microphone is designed for computer use. The microphone should be compliant with the plug-in power microphone.

To connect an external microphone

- 1 Locate the red Microphone jack on the right side of your notebook.
- 2 Plug the microphone cable into the Microphone jack.

Connecting Microphone to Microphone Jack

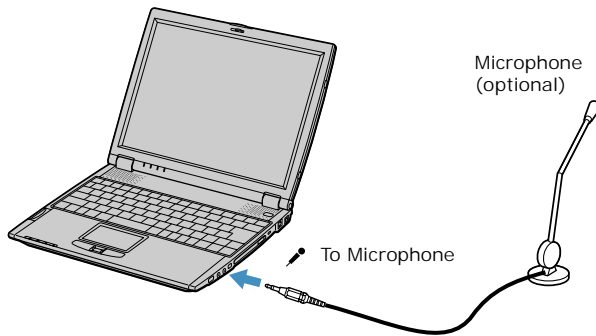

 See the manual that comes with your microphone for more information on installation and use.

Change text in this variable definition to document title.

Customizing Your VAIO Notebook

The following sections briefly describe how to change your notebook's default settings:

- Displaying the Sony Notebook Setup Screen
- Controlling Power Management
- Displaying Battery Information
- Selecting the Display Mode

Displaying the Sony Notebook Setup Screen

To display the Sony Notebook Setup screen:

- 1** Click the Start button on the Windows® taskbar.
- 2** Point to VAIO and click Sony Notebook Setup.

Change text in this variable definition to document title.

Sony Notebook Setup Screen

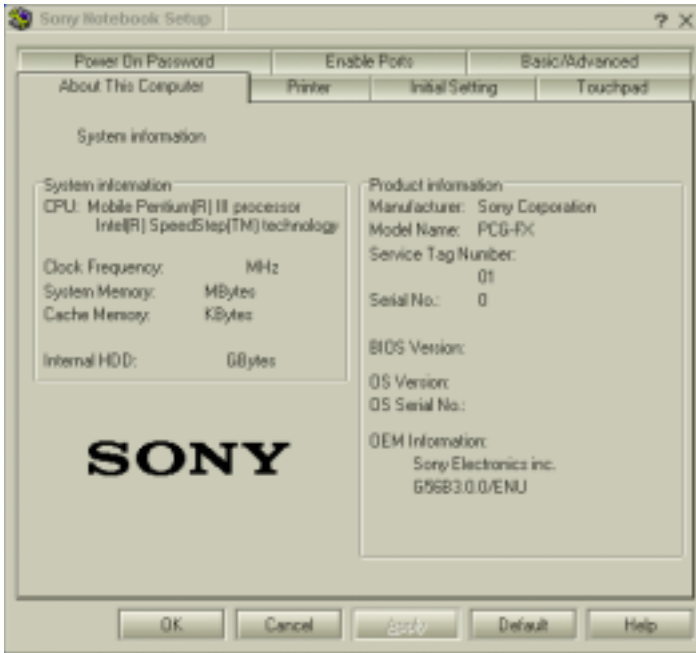

- 3 Select the tab for the item you want to change. See “Sony Notebook Setup tabs” for more information.
- 4 After you finish making your changes, click OK.

Sony Notebook Setup tabs

<i>Tab</i>	<i>Description</i>
About This Computer	Display system information, including memory capacity, serial number, and BIOS version.
Printer	Select printer port mode settings.
Initial Setting	Change the volume of the sounds that play while the operating system is loading. Select the order of drives and devices from which you want to load the operating system. You can specify the hard drive as well as other drives inserted into your notebook.
Touchpad	When you connect an optional mouse to the Serial port of your notebook, you can make your touchpad inactive. You can also customize the settings of your mouse using the mouse utility.
Power On Password	Set the password to secure your notebook.
Enable Ports	Enable or disable ports. Disabling ports releases resources to the system. To change the serial settings, click Advanced on the Basic/Advanced tab.
Basic/Advanced	Switch between Advanced mode (additional screens with advanced settings) and Basic mode of display.



For more information about each option, click Help on the Sony Notebook Setup screen to display the Help file.

Controlling Power Management

The PowerPanel™ utility allows you to control the power settings of your notebook and provides key information about system activity and battery life. The following sections briefly describe how to conserve your notebook's battery power. You can also refer to PowerPanel help for more detailed information. To activate a profile or command, see “Displaying Battery Information” for more information.

Viewing the Power Management status icons

The Power Management status icons are displayed in the task tray at the lower right side of your screen. Move the pointer over the icons to see the tool tip that displays information about the active profile. The Battery status icon indicates the battery power level and the CPU status icon indicates the performance level of the CPU.

Activating the Power Management toolbar

- 1 Right-click on the taskbar at the bottom of the screen.
- 2 Select Toolbars from the pop-up menu, and then click Power Management. The Power Management toolbar appears on the taskbar.

The current profile icon is highlighted on the Power Management toolbar. It is the first icon farthest to the left, and its appearance changes depending on which power management profile is currently selected. To change the power management profile, click the current profile icon, then select a new profile from the pop-up list. See “Power Management profiles” for a description of available options. To select another power management profile, click that icon in the Power Management toolbar.



When you use the battery pack to power your notebook, your system selects the Maximum Battery Life power management profile by default. If you select a different power management profile while using battery power, the new profile is selected automatically the next time you use the battery pack to power your notebook.

Refer to PowerPanel help for information on customizing the Power Management toolbar.

Customizing Power Management settings

You can customize power management settings, such as the system timer and the brightness of the screen. To customize a setting:

- 1 Click the Current Profile icon on the Power Management toolbar.
- 2 Select Edit/Create Profiles from the menu.
- 3 Click a profile whose setting you want to change, from the list in the left panel.
- 4 Double-click an item whose setting you want to change from the list in the right panel.
- 5 Click the desired setting.
- 6 Click the File menu, then click Save.
- 7 Click the File menu, then click Exit.

Power Management profiles

The PowerPanel utility provides several predefined power management profiles. Each profile consists of a group of power management settings that are designed to meet specific power management goals—ranging from maximum power management to no power management. You can change the settings for any of the predefined profiles (except for the Disable Power Management profile), or you can create your own profile to suit your portable computing needs. The predefined profiles are:

Change text in this variable definition to document title.

Icon

Description



Maximum Performance

Provides the best system performance while still conserving power.



Maximum Battery Life

Provides power saving features to give you maximum battery life and good performance. It slows the notebook and puts it into Standby mode after a specified time period.



Disable Power Management

Turns off all power management features such as Standby and Hibernate modes.

You can not change the settings of this profile.



AC Power

The power management state when AC power is in use. Similar to the Power Management Off setting. Power Management automatically loads the AC profile unless you disable this feature.



Games

Disables the display and the Hard Disk Standby timer.



Presentation

Keeps the display on at all times while it conserves power. This option is ideal for slide show presentations. You can establish settings for LCD (Video) Standby, Hard Disk Standby, and Standby to optimize power management for your system.



Camera

Optimizes performance and power requirements for camera usage.



DVD

Optimizes performance and power requirements for DVD usage.

Icon

Description



Word Processing

Optimizes power management with longer timeouts on the hard disk and display screen. You can also establish settings for LCD (Video) Standby, Hard Disk Standby, and Standby to optimize power management for your system.



Spreadsheet

Optimizes performance and power requirements for spreadsheet applications.



Communications

Extends battery life by initiating a quick display timeout. The Internal modem remains powered. You can also establish settings for LCD (Video) Standby, Hard Disk Standby, and Standby to optimize power management for your system.



Automatic Profile Selection

Automatically switches to a profile suitable for active applications.

Power Management commands

PowerPanel™ also provides power management commands that you can use to activate specific power management functions and to control power for a specific device. You can use these commands to override a profile setting or initiate an immediate action.

Change text in this variable definition to document title.

Icon

Description



Standby Mode

Puts the system into Standby mode, a power management state that saves the state of the system and peripheral devices in memory (RAM). Power consumption reduces to a minimum, and the system remains on. To return the system to the active state, press any key or the power button on your notebook.



Hibernate Mode

Provides for the lowest level of power consumption. The system writes the state of the system and peripheral devices to the hard disk and turns off the system power. To return the system to the original state, use the power button to turn on power. The system saves the data in the Save to Disk Partition on the hard drive.

Conserving battery power

When using the notebook with a battery, the LCD display and the hard drive can be set to switch off automatically to conserve battery power.

See “Power Management profiles” for more information.

Displaying Battery Information

You can display detailed information for each of the batteries in your notebook. The following sections briefly describe how to display your notebook's general battery information. Refer to PowerPanel help for more detailed information.

To activate the battery information toolbar

- 1 Right-click on the taskbar at the bottom of the screen.
- 2 Select Toolbars from the pop-up menu, then click Battery Information. The Battery Information toolbar appears on the taskbar.

You can also view the total capacity remaining in the battery by placing the pointer over the battery status icon in the task tray on the lower right side of the screen.

Battery Information Toolbar



- **Percentage indicator** — Displays the percentage of the remaining battery capacity.
- **Time indicator** — Displays estimated time (hours/minutes) remaining before the battery fully drains, also referred to as the time-to-empty.

Battery icon descriptions

<i>Battery Icon</i>	<i>Battery Status</i>
---------------------	-----------------------



Charging

Change text in this variable definition to document title.

Battery Icon Battery Status



Fully charged



Discharging



No battery

Displaying detailed battery information

Double-click the battery icon on the task tray to display the Battery Information window. The screen appears displaying the Battery tab, which contains information such as the estimated time-to-empty and charging time.

Battery Information Window



Customizing the Battery Information toolbar and alarm system

You can customize the Battery Information toolbar to suit your portable computing needs, including modifications to the alarm settings. Refer to PowerPanel help for more information.

Selecting the Display Mode

This notebook uses the Intel® video controller, which enables you to select the desired display when the notebook is connected to an external monitor. When you connect an external display, you can switch the display mode between your notebook's LCD display and the external monitor.

To select the display mode, proceed as follows: (See also the "Connecting an External Display" section.)

- 1** Click the Start button, point to Settings, then click Control Panel. The Control Panel appears.
- 2** Double-click Display to access the Display Properties window.

- 3 Click the Settings tab, then click the Advanced button to display the Intel® 82815 Graphics Controller Properties dialog box.

Intel® 82815 Graphics Controller Properties Screen



- 4 Click the Intel® 82815 Graphics Technology tab, then click the Graphics Properties button.
- 5 Click the Driver Configuration tab.
- 6 Ensure that the Synchronous Display Mode box is selected, then click Apply.
- 7 Click the Device tab.
- 8 Select the type of display.

Change text in this variable definition to document title.

 You may not be able to display the notebook LCD screen and an external display or projector at the same time, depending on the types of computer displays and projectors you are using.

Turn on the notebook after you turn on the peripheral devices.

Changing the window design of Sony software

To change the window design

- 1** Click the Start button, point to Settings, then point to Control Panel.
- 2** Click UI Design Selector.
- 3** Click << or >> and select the desired design.
- 4** Click Apply.
- 5** The “UI Design Selector” window design changes. The window design for your Sony software will match the “UI Design Selector” window.
- 6** To try another selection, click << or >> then click OK.
- 7** The UI Design Selector closes and the Sony software window design displays.

 This feature is available with UI Design Selector-compatible software only.

Adding Memory

In the future you may want to install memory modules to expand the functionality of your notebook. The amount of memory on your notebook will vary depending on the model you purchased. Expansion memory modules are available as options. For memory upgrades, use only PC100 (CL2) SDRAM SO-DIMM (gold lead contacts). This section describes how to replace memory modules in your computer:

- Precautions and Procedures
- Installing a Memory Module
- Removing a Memory Module

Precautions and Procedures



Sony recommends memory upgrades be performed by an authorized Sony Service Center. To find the nearest center or agent, see <http://www.sony.com/pcsupport>.

Make sure that you observe the proper safety precautions when you install a memory module in your notebook. See the bulleted list below. Be careful when adding memory. Mistakes when installing or removing a memory module may cause a malfunction.

- The procedures described below assume familiarity with the general terminology associated with personal computers and with the safety practices and regulatory compliance required for using and modifying electronic equipment.
- Disconnect the system from its power source and from any telecommunications links, networks, or modems before you open the system or follow any of the procedures described below. Failure to do so may result in personal injury or equipment damage.

Change text in this variable definition to document title.

- ❑ Electrostatic discharge (ESD) can damage disk drives and other components. Perform the procedures described below only at an ESD workstation. If such a station is not available, do not work in a carpeted area, and do not handle materials that produce or hold static electricity (cellophane wrappers, for example). Ground yourself by maintaining contact with an unpainted metal portion of the chassis while performing the procedure.
- ❑ Do not open the memory module package until you are ready to install the module. The package protects the module from ESD.
- ❑ Use the special bag for preventing ESD or use aluminum foil when you store the memory module.

Installing a Memory Module

- 1 Shut down your notebook and disconnect all peripheral devices, such as your printer.
- 2 Unplug the notebook and remove the battery packs.
- 3 Wait until the notebook cools down. Then unscrew the two screws with the ← mark on the bottom of your notebook.

Screws on Bottom of Notebook

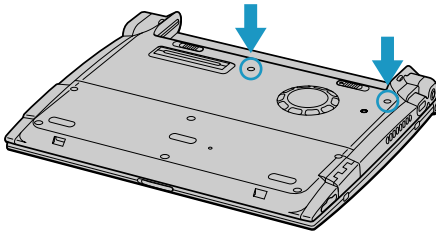

- 4 Slide the LCD lock lever and lift the cover. Slide the keyboard toward the LCD display, then lift it away slightly.

Lifting the Keyboard

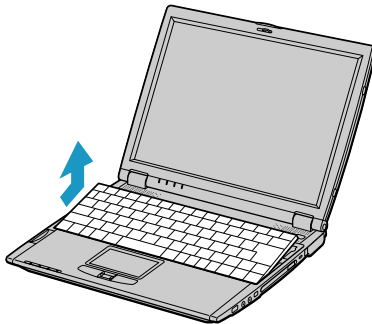

Change text in this variable definition to document title.

- 5 Lift the keyboard from the LCD display side, then gently turn it over on the touchpad space. Be careful not to detach the cable when lifting the keyboard.

Turning the Keyboard

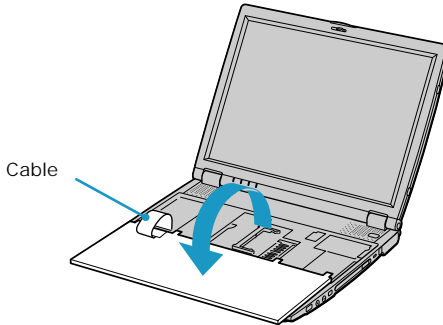

- 6 You must remove the existing memory module. See “Removing a Memory Module” for instructions.
- 7 Remove the memory module from its packaging.
- 8 Install the memory module.

 Note the following:

- Be careful not to touch the other components on the motherboard.
- Be sure that both ends of the memory module click into place.

Installing the Memory Module

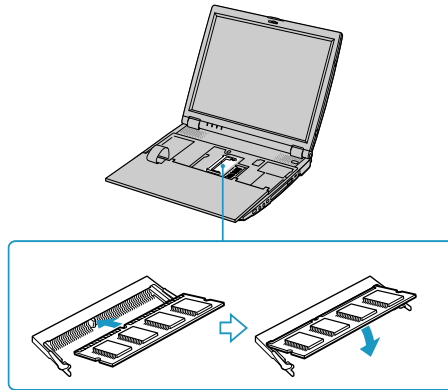

- 9 Gently replace the keyboard, then press it into your notebook. Be careful not to detach the cable when lifting the keyboard.

Replacing the Keyboard

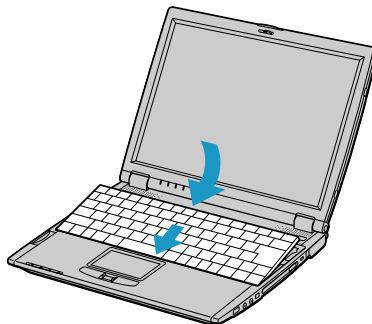

Change text in this variable definition to document title.

- 10** Close the notebook cover, then tighten the screws on the bottom of the computer.

Removing a Memory Module

- 1** Perform steps 1 to 5 in the “Installing a Memory Module” section.
- 2** Touch a metal object (such as the port panel on the back of your notebook) to discharge static electricity.
- 3** Remove the memory module.
- 4** Perform steps 8 and 9 in the “Installing a Memory Module” section.

Change text in this variable definition to document title.

About the Software on Your Notebook

Your VAIIO® notebook is ready to help you work, play, learn, and communicate as soon as you turn it on. This section provides you with the following information:

- Overview
- Using Your Recovery CDs
- Software Support Information

Overview

Adobe Acrobat Reader®

Adobe Systems Inc.

Acrobat Reader software allows you to view, navigate, and print electronic documents in Adobe Portable Document Format (PDF)—an open file format that is intended to preserve the fidelity of documents created on all major computer platforms.

America Online®

America Online, Inc.

America Online is a popular Internet online service. Stay in touch with family and friends with easy-to-use e-mail, manage your personal finances, get the latest news and sports scores, and chat with thousands of others who share your interests.

CompuServe® 2000

CompuServe Interactive Services Inc.

CompuServe is the most comprehensive source of organized business and educational information online today. CompuServe allows you to access the vastness of the Internet, without wasting time wading through it. Maximize your time online with CompuServe.

Drag'n Drop CD®

DigiOn Inc. and Easy Systems Japan Ltd.

Drag'n Drop CD is designed to be the most simple software to make your own CD. Users can create their own best AudioCD, or data CD that can be read in many PCs. With Drag'n Drop CD you can also create your own backup CD from the original CD that you own.

DVgate™

Sony Electronics Inc.

Connect a digital video camera recorder to the i.LINK® port and capture your own video clips and still images. You can edit the clips from your video, add others, and combine clips into new movie segments. You can also save your images in a variety of popular file formats.

JogDial Utility

Sony Electronics Inc.

JogDial Utility allows you to easily scroll, launch applications, access settings, and perform other useful functions by manipulating the center Jog Dial™ control, which is located near the touchpad.

Microsoft® Word

Microsoft Corporation

Microsoft Word makes it easy to create common Web, e-mail, and print documents for use around the world. It embraces HTML as a first-class file format and extends this software's ease-of-use to the Web and e-mail. Word also extends that ease-of-use to international users, making it simple to create multilingual documents.

MovieShaker™

Sony Electronics Inc.

Sony's original MovieShaker software creates personal movies that have transitions, background music and text. Just import your video clips and "shake" with the click of a mouse. Your personal movies are easy to create and fun to share with family and friends. (See the "MovieShaker" section for more information.)

Netscape Communicator®

Netscape Communications Corporation

Netscape Communicator is an all-in-one Internet tool that makes it easy to browse the Web, send Internet e-mail, chat, read newsgroups and compose great Web documents.

Norton AntiVirus™

Symantec Corporation

Norton AntiVirus is the world's leading anti-virus software. Just install it and forget it. It's always working in the background to protect your PC, and now it automatically updates its virus definitions when you're connected to the Internet. It also scans files you download from the Web, as well as attachments you get through e-mail.

OpenMG™ Jukebox

Sony Electronics Inc.

OpenMG Jukebox software enables you to import digital audio files by downloading audio files from Electronic Music Distributino (EMD) services over digital networks, such as the Internet. You can record audio CDs onto your hard drive in a variety of formats.

PictureGear™

Sony Electronics Inc.

This image management software displays images from your hard drive, a Sony Digital Still Camera, or a Sony Mavica® Camera. The images appear in a convenient light-table format, so that you can easily view the contents of an entire folder. (See the "PictureGear" section for more information.)

PowerPanel™

Phoenix Technologies Ltd.

The PowerPanel utility controls the power management of your notebook and provides key information about system activity and battery life. Automatic power management selects the most appropriate profile, depending on the application with which you are working and the conditions of use. See the "Controlling Power Management" or PowerPanel help for details.

Prodigy Internet®

Prodigy Communications Corporation

An online service that helps you find what you need online faster and smarter. Prodigy delivers powerful online content such as sports scores, stock quotes, news, and easy access to Excite, plus quality customer service, all at a competitive price.

Quicken® 2001

Intuit, Inc.

Quicken is a fast, easy way to organize your finances. Quicken works just like your checkbook, so it is easy to learn and use. Quicken manages all your finances, bank accounts, credit cards, investments, and loans. You can even pay your bills online.

QuickTime™

Apple Computer, Inc.

QuickTime is the Apple technology that makes video, sound, music, 3D, and virtual reality come alive for your Internet browser and Windows.

RealJukebox®

RealNetworks Inc.

RealJukebox is one of the world's most widely used personal music management systems. Using RealJukebox, you can capture the contents of a music CD, manage and play back your music and view various music related information via the Internet. This custom RealJukebox for Sony allows seamless check-out capabilities to a wide range of Sony personal audio devices, and offers convenient links to Sony products and music service home pages.

RealPlayer®

RealNetworks Inc.

RealPlayer is the RealNetworks video and audio player which lets you access 2,500 radio stations featuring music, news and sports.

RealProducer® G2

RealNetworks Inc.

RealProducer converts your audio and video files, or live feeds, into RealAudio and RealVideo for the Internet or your intranet. RealProducer is easy to use, gives you better control over your content, and is packed with exclusive features. Featuring support for CD-quality RealAudio 8 and VHS-quality RealVideo 8, RealProducer is an excellent choice for both beginners and pros.

Smart Capture

Sony Electronics Inc.

Smart Capture is a fun new way to send multimedia messages via e-mail. Smart Capture manages the i.LINK connection between your notebook and a Sony Digital Handycam® camcorder that supports the i.LINK interface. It allows you to capture compressed video or still images that you can save or share via e-mail. A smart solution to computer, digital audio/video and network convergence.

Smart Connect

Sony Electronics Inc.

Smart Connect allows you to use an i.LINK cable to connect your VAIO notebook to another computer that supports Smart Connect. You can then use one computer to copy, delete, and edit files on the other computer. You can also print from a printer attached to either computer.

VAIO Action Setup

Sony Electronics Inc.

VAIO Action Setup manages the settings for your notebook's Shortcut keys and i.LINK interface.

VAIO Support Agent

Sony Electronics Inc.

VAIO Support Agent provides immediate, interactive, on-line support.

VisualFlow™

Sony Electronics Inc.

VisualFlow is a state-of-the-art Sony multimedia browser designed specifically for Memory Stick media. It displays any still pictures, movie, or sound files stored in a Memory Stick media in a visually pleasing, artistic manner.

VisualFlow not only plays a selected movie or sound file, but also enables playback of files by other applications like PictureGear, Memory Stick Slideshow, and Windows Explorer.

WinDVD™ 2000

InterVideo, Inc.

WinDVD is a simple-to-use DVD player including all the features you would expect to find in a standard consumer DVD player, while also offering advanced display and navigation features such as zoom, pan, bookmark, and time search.

DVgate

In order to improve the performance of your notebook's DVgate™ motion software, the hard disk drive on your notebook has been formatted with two partitions, C and D. The C partition holds 40 percent, and the D partition holds 60 percent of the entire drive capacity. DVgate software saves files to the D partition. This prevents large video captures from consuming the available space on your C partition. To maintain optimum performance of DVgate software, you should defragment or format the D partition regularly.

To defragment a partition



Before you defragment a partition, make sure you back up all files that you want to save.

- Click the Start button in the Windows® taskbar.
- Click Programs, then Accessories, then System Tools, and then Disk Defragmenter. The Disk Defragmenter window appears.

Select the drive you want to defragment from the list, and click the Defragment button. See Windows® Help for more information on defragmenting.

DVgate plug-in for Adobe Premiere

If your VAIO® notebook does not come with Adobe Premiere pre-installed and you subsequently purchase that software, you must install a plug-in to enable DVgate™ 2.3 software.

Installing the DVgate plug-in

To install the plug-in for Adobe Premiere® 5.1 and 5.1LE, proceed as follows:

- Click Start in the Windows® taskbar and select Run.
- Click Browse and, from your C: drive, select Program Files, and Sony, and Dvgate, and Premiere Plug-in, and then 5.1.
- Select "Setup.exe" and click Open. Then click OK to install the plug-in.

To install the plug-in for Adobe Premiere® 6.0, proceed as follows:

- Click Start in the Windows® taskbar and select Run.

Change text in this variable definition to document title.

- ❑ Click Browse and, from your C: drive, select Program Files, and Sony, and Dvgate, and Premiere Plug-in, and then 6.0.
- ❑ Select “Setup.exe” and click Open. Then click OK to install the plug-in.



MovieShaker

This application can be used to create fun and innovative movies without any knowledge of film editing. In a few simple steps, motion pictures can be combined with special effects, still images (pictures), and music files and then saved in a format most computers can play.

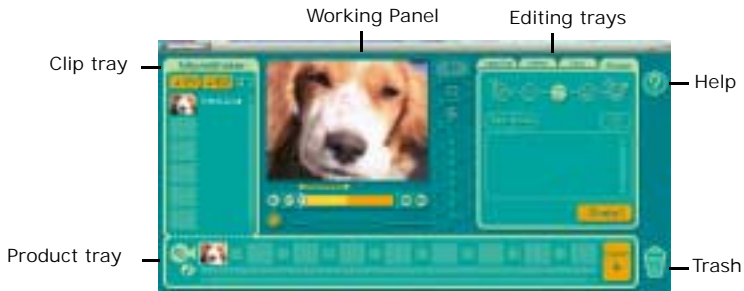
Main Window



Importing images and sound clips

- 1 Click  (File Import) or  (DV Import).
- 2 Find the file you want to add.
- 3 Select the file.
- 4 Click Open. The file is added to the Clip tray.



Importing files over 75 seconds in length may cause MovieShaker software to stop responding.

Create a movie using Shaker

After adding clip(s) to the Clip tray, you can create a short movie using the Shaker feature. Shaker randomly select clips from the Clip tray to create a 30-second scene.

- 1 Click the Shake tab.
- 2 Select a mood by clicking a face in the Shaker tray.

Change text in this variable definition to document title.

Shaker Tray



- 3 Click **Shake!** . A 30-second scene is automatically generated and saved to the Product tray.
- 4 To preview, switch the Work Panel to Product tray mode and press play.



Scenes created with Shaker begin with black frame and after processing are placed in the first available slot on the Product tray. Limit the number of scenes placed on the Product tray to 10 or less. MovieShaker software may stop responding if too many scenes are placed on the Product tray.

Editing clips and scenes

You can edit your movie by adding effects and text, adjusting the color and contrast, and modifying the length of clips.

Working Panel

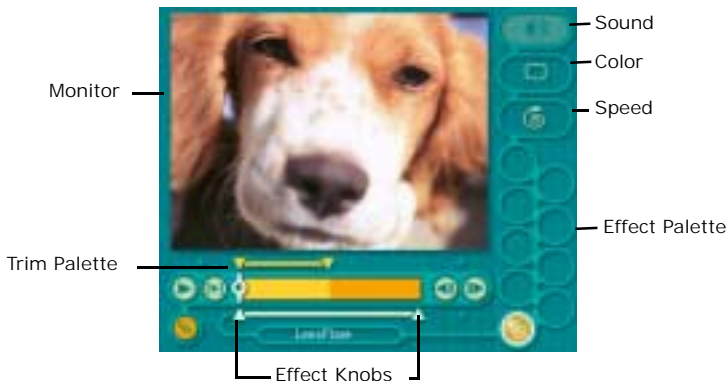

Adding effects to a scene or a clip:

- 1 Double-click the clip or scene to move it to the Working Panel.
- 2 Select the Effects tab from the Editing tray.
- 3 Drag and drop the Effect you want to add from the Effects tray to the Effects palette on the Working Panel.



To preview an Effect, click on the clip in the Working panel monitor. Your clip displays with the new effect on the Effect tray monitor.

- 4 See help for instructions on adjusting effect duration and replaying clips/scenes.

Saving a movie

- 1 Verify that the clip(s) you want to save is on the Product tray. See Help for more details on saving movies.
- 2 Click Export.
- 3 Select the format in which you want the document to be saved.
- 4 Click Next.
- 5 Locate the folder to which you want the file saved.
- 6 Name the file.
- 7 Click Save.



Exporting movies may take a long time to complete—Saving movies as DV (Digital Video) takes the longest and Quick-Save is the fastest. MovieShaker can play video files up to 65 MB in length.



For DV playback and smooth video playback, we recommend the following resolution/refresh rates: 1024 x 768/75 Hz or lower.

OpenMG Jukebox

OpenMG Jukebox is a software application that utilizes Sony Corporation's copyright protection technology. OpenMG Jukebox maintains the holder's copyrights by preventing unauthorized distribution of digital audio files.

OpenMG Jukebox software enables you to play and record audio CDs and import digital audio files while maintaining the copyright information of the contents. When you record an audio CD with OpenMG Jukebox, it is encoded in ATRAC3 format onto your notebook's hard drive. You can download digital audio files from Electronic Music Distribution (EMD) services. The imported data can be played on your notebook or transferred to external devices or media. OpenMG Jukebox converts your existing MP3 and WAV format audio files into OpenMG format (WAV format audio files are converted into ATRAC3 format or changed into OpenMG MP3 format).



Your VAIO® Notebook ships with OpenMG Jukebox 2.0 installed. Other external devices that are compatible with OpenMG Jukebox may contain an earlier version of the software (Version 1.0, 1.1, or 1.2). Do not install an earlier version of OpenMG Jukebox on your notebook, as this may cause the software to work improperly or damage your audio files.

Electronic Music Distribution (EMD) services

EMD allows you to download music files via the Internet. To use Internet services that are compatible with OpenMG Jukebox, you need:

- ❑ Access to the Internet from your notebook. Sign up with an Internet Service Provider (ISP) and configure your notebook for Internet access before using EMD services.
- ❑ An EMD service provider. Consult the provider for details regarding service.



To protect your personal data, Sony uses Secure Sockets Layer (SSL), an encryption protocol for communication between your browser and Sony's World Wide Web (WWW) server. If you are accessing the Internet from an enterprise Local Area Network (LAN), you may not be able to use SSL due to the proxy server of the LAN. Contact your network administrator for more information.

To start OpenMG Jukebox 2.0

- 1 From the Start button on the Windows taskbar, select Programs, OpenMG Jukebox, and then click on OpenMG Jukebox. The CDDB[®] Music Recognition Service Registration wizard appears.
- 2 Follow the onscreen instructions to complete registration.



To register with CDDB, you will need Internet access from your notebook. For more information regarding CDDB registration, click the Help button.

- 3 When you have registered with CDDB, the “Set OpenMG Jukebox as the Application for playing Audio CD” dialog box appears. You can set OpenMG Jukebox as the default application for playing audio CDs by selecting the appropriate checkbox.
- 4 Click OK. The OpenMG Jukebox window appears.

OpenMG Jukebox 2.0 Basic Features

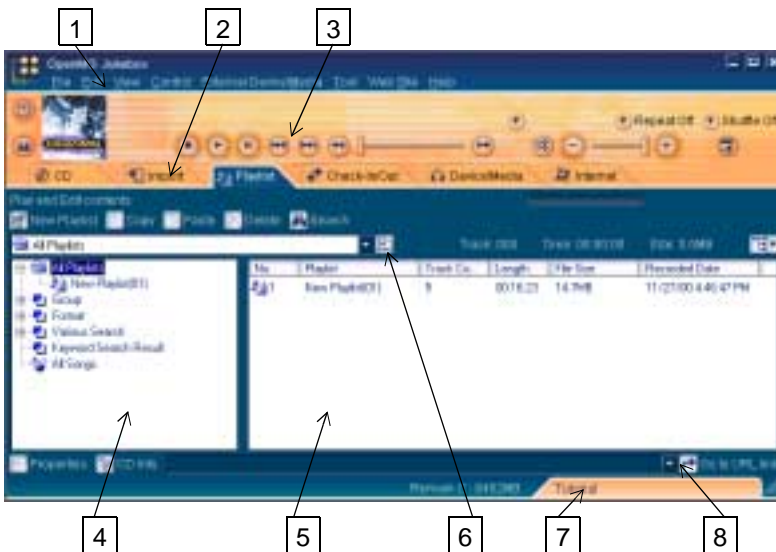

Change text in this variable definition to document title.

1 Menu bar Displays OpenMG Jukebox menus.	5 File List view Lists the items under the selected folder in the File Tree view.
2 Screen Tabs Change the operational sheet view according to function.	6 Drop-down list Displays the playlists, audio files, etc., of the current screen tab.
3 Player control buttons Control playback (play, stop, pause, etc.).	7 Tutorial tab Opens and closes the Tutorial screen.
4 File Tree view Displays the folders on your notebook.	8 URL drop-down list Displays URL address information if available. Clicking the “Go to URL link” button connects to the Internet Web page of the URL.

To record a CD

You can record songs from audio CDs and import them to playlists within OpenMG Jukebox.



When you record from an audio CD on your optical drive for the first time, the “CD Drive Optimization” dialog box appears. Click Start to verify your optical drive. After the verification is performed, recording begins.

- 1** Insert an audio CD into the optical drive.
- 2** Click the CD tab.
- 3** Select the Bit Rate, CD drive, and Record to location from the drop-down lists.

CD tab screen

- 4 To select certain tracks from your CD, uncheck any unwanted tracks. You can also click the empty checkbox next to Select All (clears all checkboxes), and then select the desired tracks.
- 5 Click  Rec to Jukebox to begin recording. When the recording is finished, the new playlist appears in the File Tree view of the Playlist screen tab.
- 6 To name the album and songs, type the name, or retrieve it from the CDDB Web site on the Internet at <http://www.cddb.com/cddb2info/using.html>.

To transfer songs (check-in/check-out)

You can transfer songs between the playlists of your OpenMG Jukebox and external devices/media. For details on using your external devices/media, see the user guide that came with your product. These instructions are for the Check-in/Check-out 1 step mode; for information on 2 step mode, see “Changing the check-in/check-out settings” in the OpenMG Jukebox Help menu.

Change text in this variable definition to document title.

Check-out

- 1 Connect the external device/media to your notebook.
- 2 Click the Check-in/Out tab to display the Check-in/Out screen. Your notebook recognizes the connected external device/media and lists the information on the right side of the screen.

Check-In/Out tab screen





- 3 Select the Playlist containing the song that you want to check out. The songs in the playlist are listed in the Playlist view in the center of the screen.
- 4 In the Playlist view, select the song to be checked out. To check out more than one song at a time, hold down the Ctrl key and click the songs to be selected.
- 5 Click  (Out), or drag and drop the song to the desired position in the song list of the external device/media. Check-out begins.



To cancel Check-out, click  (Stop), or click Cancel in the Processing dialog box displayed during Check-out.

Check-in

You can only check-in songs recorded on external devices/media to the hard drive of the same notebook from which the songs were checked out.

- 1 Connect the external device/media to your notebook.
- 2 Click on the Check-in/Out tab to display the Check-in/Out screen. Your notebook recognizes the connected external device/media and lists the information on the right side of the screen.
- 3 Select the song to be checked in from the song list of the external device or media. To check in more than one song at a time, hold down the Ctrl key and click on the additional songs to be selected.
- 4 Click  (In), or drag and drop the song(s) to the Playlist view. If you want to check in all of the songs in the external device/media, click  (In All). Check-in begins.



To cancel check-in, click  (Stop), or click Cancel in the Processing dialog box displayed during the Check-out process.

For more information about using OpenMG Jukebox 2.0 software, go to the online OpenMG Jukebox Help file. You can access the OpenMG Jukebox Help file using either of the following instructions:

- 1 Click the Start button on the Windows taskbar, select Programs, and OpenMG Jukebox, and then OpenMG Jukebox Help.
- 2 From the OpenMG Jukebox Help menu, select OpenMG Jukebox Help.

Additional OpenMG Jukebox features

- ❑ **OpenMG Jukebox Tutorial** — In the Tutorial screen, the available operations of OpenMG Jukebox are briefly described. By clicking items in the screen, you are guided directly to the desired operations of OpenMG Jukebox.
- ❑ **OpenMG Jukebox Backup Tool** — Allows you to back up and restore all the data managed by OpenMG Jukebox, including music, graphics, and information. You must be connected to the Internet to use OpenMG Jukebox Backup Tool.

- ❑ **Import audio files in various formats** — You can import downloaded or stored audio files in various formats, such as MP3, WAV, or WMT (which is compliant with Windows Media Technologies with the extensions .asf or .wma), and manage them on the Playlist of OpenMG Jukebox.
- ❑ **Manage imported songs on the Playlist** — By registering imported songs to the Playlist of OpenMG Jukebox, additional features are made available other than playback. You can create a list of songs categorized by genre or artist, display the created list on a Playlist, and manage these songs in a hierarchical structure by using Playlist folders. You can also edit songs so that multiple songs are created as one (Combine), or divide one song into two (Divide).
- ❑ **Simple mode** — Allows you to perform playback operations only. The operation panel in simple mode is much smaller than in full mode. This is especially useful when you want to play songs with OpenMG Jukebox while using other software, or when you feel that the operation panel in full mode is too large. Additionally, the design of the operation panel in simple mode can be changed by adding a new Skin. Therefore, you can enjoy various panel designs when the skins supporting OpenMG Jukebox soon become available.

Notes on using Portable Players

If you have purchased a Portable Player such as NW-MS7 or NW-E3, do not install the version of OpenMG Jukebox that came with the Portable Player. Your notebook already has OpenMG Jukebox version 2.0 preinstalled. Overwriting OpenMG Jukebox version 2.0 for VAIO computers may generate malfunctions.

To connect your Portable Player to your VAIO[®] Notebook, you need a plug-in for OpenMG Jukebox version 2.0. For details, refer to Sony Walkman[®] Product Support on the Web at <http://www.sony.com/walkmanproductsupport>.



Due to the incompatibility between Windows 2000 Professional software and NW-MS7 Portable Player hardware, connecting a NW-MS7 Portable Player to your VAIO notebook is not possible.

PictureGear

PictureGear software is a digital image management application that allows you to see all the images stored in any directory on your notebook. Thumbnail views provide quick reminders of your pictures. Brighten, contrast, enhance, resize, crop, and color-correct your pictures. Create panoramic views, animations, screen savers, wallpaper, still pictures from MPEG, and even html photo albums.

Managing your pictures

Use the collection feature to manage your pictures.

- 1 Click the Folder tab and browse to locate your pictures.
- 2 Select the pictures you want to have in a collection.
- 3 From Collection menu, select Create New Collection.
- 4 Enter a name for the collection and then click OK.

Creating a photo album

- 1 Select the pictures you want to use to make an album.
- 2 From the Utilities menu, select Album Maker.
- 3 Choose the type of Album you want and click OK.
- 4 Now add more pictures, frames, text, and effects.
- 5 When you are finished, select Create Album in File menu or click the Create Album icon on the toolbar.
- 6 Designate the folder where you want to save the Album.
- 7 Enter the Target Album name, select Thumbnails and click OK.
- 8 The new album can be viewed using most internet browsers.

Using Panorama Maker

Panorama Maker stitches a group of still images into a 360 degree panoramic picture. The source images should be the same size and overlap 20 percent.

How to stitch a panoramic picture:

Change text in this variable definition to document title.

- 1 Gather the source images into the same folder or collection.
- 2 Select the images you want to use.



Sony recommends using 12 landscaped or 16 portrait pictures.

- 3 From the Utilities menu select Panorama Maker.
- 4 Select the correct lens and click OK. (If 35mm lens is selected, the prompt does not appear; to select a different lens, click the lens icon.)
- 5 Click the panoramic icon, near the bottom of the window.
- 6 Click Full Stitch.

Making still images and panoramic from MPEG

- 1 Select the MPEG file.
- 2 From the Movie/Sound menu, select Scene break down. Then select Movie Stitch, to create a panoramic picture.

Smart Capture

Smart Capture is a Sony-designed application that manages the i.LINK®* connection between your notebook and a compatible i.LINK digital camera or camcorder. You can capture and enhance video or still images to share with your family and friends over the Internet or through e-mail.

Smart Capture main window



1 Mode indicator

Displays the current mode (Still or Net Movie).

5 Help button

Connects you directly to the online Smart Capture help.

* i.LINK is a trademark of Sony used only to designate that a product contains an IEEE 1394 connection. The i.LINK connection may vary, depending on the software applications, operating system, and i.LINK-compatible devices. All products with an i.LINK connection may not communicate with each other.

Please refer to the documentation that came with your i.LINK-compatible device for information on operating conditions and proper connection. Before connecting i.LINK-compatible PC peripherals to your system, such as CD-RW or hard disk drive, confirm their operating system compatibility and required operating conditions.

2 Mode dial Switches Smart Capture from Still mode to Net Movie mode with a single click of your mouse.	6 Capture button Captures your individual still images in the same manner as a camera. You can select different characteristics for the Capture button when capturing a Net Movie.
3 Options button Displays the configuration options available for either Still or Net Movie mode.	7 Application Switch drop-down list Switches between the Still image and Net movie modes, using a drop-down list.
4 Effects button Displays the special effects that you can apply to your pictures or video clips.	8 Image window Displays the still or video image from your digital camera or camcorder.

Using Still mode

- 1 From the Start button, point to Programs, point to Smart Capture, and then click on Smart Capture. The Smart Capture main window appears.
- 2 Connect your compatible i.LINK digital camera or camcorder to your notebook with an i.LINK cable. An image appears in the Smart Capture main window.



The Smart Capture main window opens with a blue screen image, indicating that there is no data input from a digital camera or camcorder. When you connect your digital camera or camcorder to your system with an i.LINK cable and turn it on, an image appears in the main window. Some cameras and camcorders need to have a recording media inserted before an image can be displayed in the Smart Capture window. Consult the manual that came with your digital camera or camcorder for more information.

- 3 Check that the Mode dial is set to Still. Click on the Mode dial to switch between Still mode and Net Movie mode.
- 4 Click on the Options button to view the available options for your still image capture. The Still Image Options window appears.

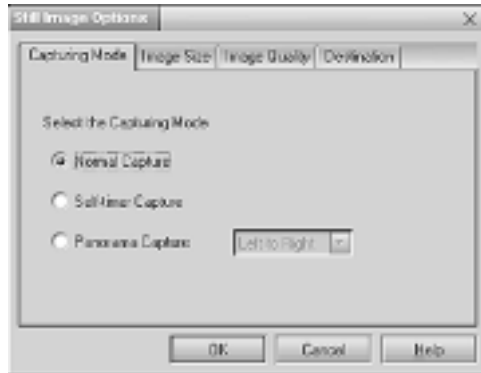
Still Image Options window

The Still Image Options window has four tabs:

- ❑ **Capturing Mode** — You can choose between Normal, Self-timer or Panorama Capture modes.
 - ❑ **Image Size** — Select the image size, horizontal by vertical in pixels.
 - ❑ **Image Quality** — Set the quality of your pictures as they are being saved by selecting Fine, Standard or Economy image quality.
 - ❑ **Destination** — Select a file destination for your pictures.
- 5 Click on the Effects button to select a special image effect. The Effect Setting window appears. Use the drop-down list to view and customize the available effects.

Change text in this variable definition to document title.

Effect Setting window

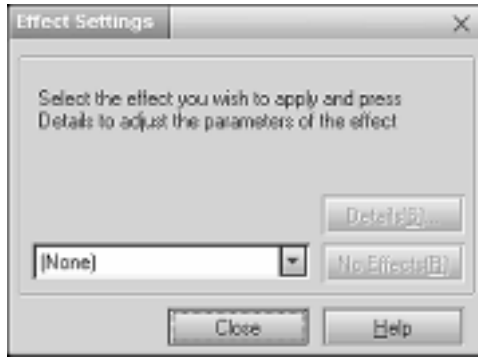

 You can use a different special effect for each picture, or you can remove all special effects by clicking on the No Effects button.

Capturing a picture in Still mode

- 1 Use your digital camera or camcorder to locate the image you want to capture. When you see the desired image in the Smart Capture window, click

on the Capture button. The Still Viewer window appears. You can capture one picture or several pictures at a time.

Still Viewer window



- 2 Click on the arrows or drag the scroll bar to view the pictures. As each image is captured, it displays in the Still Viewer window with a balloon for your comments and an identifying number in the viewer's queue.

Managing pictures in Still mode

From the Still Viewer window, you can perform various functions using the task buttons:

- ❑ **Delete** — Discard any or all of your still images by clicking on the Delete button. Select a single image or all and the image(s) is “torn” and removed from the Still Viewer window.
- ❑ **Upload** — Send your still images online to the ImageStation Web site to share with your family and friends. ImageStation stores your still images online when you register for this free service. See “Using ImageStation” for more information.
- ❑ **Mail** — E-mail your still images to your family and friends. Click on the Mail button and your e-mail application launches with a new message window containing the still image.

Change text in this variable definition to document title.

- ❑ **Save** — Click on the Save button to save your still image in a variety of formats, to a location of your choice.

 You must be connected to the Internet before attempting to upload or e-mail your still images or videos.

Using Net Movie mode

- 1 From the Start button on the Windows taskbar, point to Programs, point to Smart Capture, and then click on Smart Capture. The Smart Capture main window appears.
- 2 Connect your compatible i.LINK digital camcorder to your notebook with an i.LINK cable. An image appears in the Smart Capture main window.
- 3 Check that the Mode dial is set to Net Movie. Click on the Mode dial to switch between Still mode and Net Movie mode.
- 4 Click on the Options button to view the available options for your movie capture. The Recording Options window appears.

Recording Options window

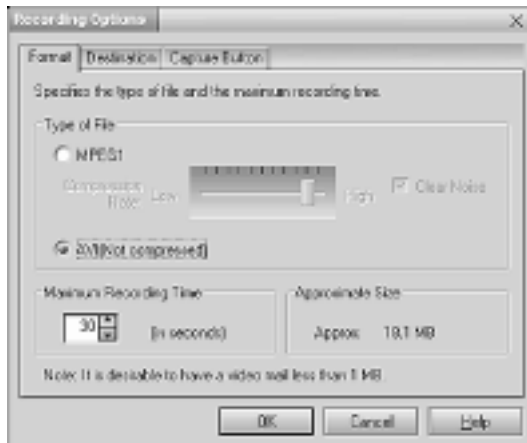

The Recording Options window has three tabs:

- ❑ **Format** — You can adjust the compression rate for your movies in MPEG1 format or choose the AVI option for no compression. You can also set the maximum recording time for your movie capture.
 - ❑ **Destination** — Select a file destination for your movies when recording video clips.
 - ❑ **Capture Button** — Set the characteristics of the Capture button. You can start and stop recording by pressing the Capture button (this is the default characteristic). You can select Anti-Ground Shooting, which allows recording to occur only while the Capture button is pressed. Recording will stop when you release the button.
- 5 Click on the Effects button to select a special image effect. The Effect Setting window appears. Use the drop-down list to view and customize the available effects.



You can remove all special effects by clicking on the No Effects button.

Capturing a movie in Net Movie mode

- 1 Use your digital camcorder to locate the view(s) you want to capture. When you see the desired view in either the Smart Capture window or your camcorder's viewfinder, press the Capture button to begin recording your movie. The Movie Player window appears.
- 2 Click on the Capture button when you have finished recording your movie and the first frame of your movie appears in the Movie Player window. You can record a movie for approximately 30 seconds. The Movie Player feature will automatically stop recording when this time limit is reached.



If you have set the Capture button to use the Anti-Ground setting, you must press and hold the Capture button to continue recording.

Change text in this variable definition to document title.

Movie Player window



- 3 You can review your movie from the Movie Player window by using the play, pause and stop buttons. Click on the arrows or drag the scroll bar to view your movie. Each frame is displayed with an identifying number in the queue.

Managing your movie in Net Movie mode

From the Movie Player window, you can perform various functions using the task buttons:

- ❑ **Delete** — Discard any frame or the entire movie by clicking on the Delete button. The frame or movie is removed from the Movie Player window.
- ❑ **Upload** — Compress and send your movies online to the ImageStation Web site to share with your family and friends. ImageStation stores your movies online when you register for this free service. See “Using ImageStation” below.
- ❑ **Mail** — E-mail your movies to family and friends. Click on the Mail button and your e-mail application launches with a new message window containing the movie.

- ❑ **Save** — Click on the Save button to compress and save your movie in a variety of formats, to a location of your choice.

Using ImageStation

ImageStationSM is a free online service that allows you to store your pictures and movies on the Internet to share with family and friends. ImageStation requires an Internet connection and registration for the Web-based service. You must be connected to the Internet before uploading your pictures or movies with Smart Capture and ImageStation.

Uploading with Movie Player

- 1 Click on the Upload Button in Movie Player. The Compression Settings when Uploading window appears.

Compression Settings when Uploading window

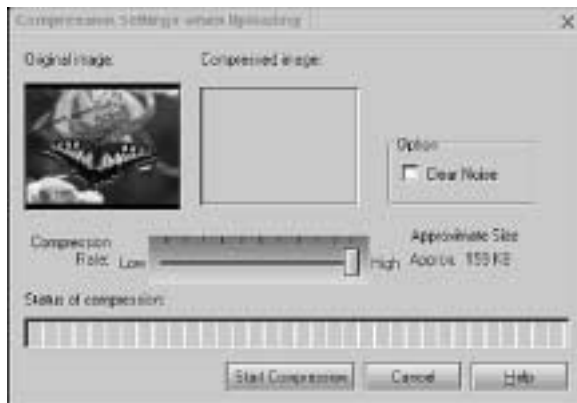

- 2 Select the compression rate and press the Start Compression button. The ImageStation Login window appears. See steps 2 to 4 in the next section, “Uploading with Still Viewer,” for further uploading information.



Sony recommends that your movie file size not exceed 254 MB if compressed, or 2 GB if not compressed. Large movie files take longer to upload to the ImageStation Web site.

Change text in this variable definition to document title.

Uploading with Still Viewer

- 1 Click on the Upload button in Still Viewer. The ImageStation Login window appears.

ImageStation Login window



- 2 For first time users, the ImageStation registration wizard guides you through the initial registration process. Follow the onscreen instructions. If you are already a registered member, provide your login name and password. The Image Uploader window appears.

Image Uploader window



- 3 From the Still Viewer or Movie Player window, click on the Upload button to transfer your pictures or movies to the ImageStation Web site. The Image Uploader window displays your Internet connection and upload status. Click on  to see thumbnail previews of your pictures or movies.



The ImageStation preview feature is available when you upload two or more pictures or a movie. No preview is shown if a single picture is being uploaded.

- 4** Go to <http://www.imagestation.com> to view your uploaded pictures or movies. Follow the onscreen instructions to access your ImageStation account. The ImageStation Web site may ask you to complete a full login again, if your current session is not active.

VisualFlow

VisualFlow software is a Sony state-of-the-art multimedia browser designed specifically for Memory Stick media. It displays any still picture, movie, or sound files stored in a Memory Stick media in a visually pleasing, artistic manner. VisualFlow software plays a selected movie or sound file, and enables playback of files by other applications such as PictureGear™, PictureToy™, Memory Stick Slideshow, and Windows® Explorer.

To use VisualFlow

- 1 From the Start menu, point to Programs, point to VisualFlow, and then click on VisualFlow.



If your system is compatible with Memory Stick media, the VAIO Action Setup may be configured to launch the VisualFlow browser upon insertion of a Memory Stick media. In this case, the VisualFlow application starts automatically when a Memory Stick media is inserted.

- 2 Click on an icon in the View section on the main toolbar to select a display layout.
- 3 Click on an icon in the Sort section on the main toolbar to select a sorting method.
- 4 Placing your cursor on the left end of the main toolbar activates the current Memory Stick properties.
- 5 Placing your cursor on the right end of the main toolbar activates a secondary toolbar with more functions.
- 6 Click on an image to show a normal view centered on the screen. Double-clicking an image shows an enlarged view.
- 7 The movie file starts playback when the view is enlarged. Click again on the movie files to restore the view to normal.



While an image is enlarged, the Launch toolbar appears at the bottom of the window. Any associated application can be activated from this point.

Application, Driver, and System Recovery CDs

Your notebook comes with the following application, driver, and system recovery CDs. (See “Using Your Recovery CDs” for information on how to use your recovery CD(s).)

Application Recovery CD(s)

Sony Electronics Inc.

This CD enables you to reinstall individual applications if they become corrupted or erased.

Driver Recovery CD(s)

Sony Electronics Inc.

This CD enables you to reinstall individual device drivers if they become corrupted or erased.

System Recovery CD(s)

Sony Electronics Inc.

This CD enables you to format the C:\ partition of the hard disk drive, then reinstall the operating system and software titles that shipped with your notebook, if they become corrupted or are erased. Use it to restore the hard disk of the VAIO® notebook you purchased. This CD restores your notebook to its original state, so user data and applications will be lost.

Using Your Recovery CDs

The following sections describe how to use the Application Recovery, Driver Recovery, and System Recovery utilities.

Using the Application Recovery CD(s)

The Application Recovery CD utility enables you to reinstall individual applications if they become corrupted or are accidentally erased. Reinstalling an individual software title may correct a problem you are experiencing with your notebook or software application; you may not need to reinstall the entire contents of your hard drive. If you need to reinstall all the software titles that shipped with your notebook, use the System Recovery CD(s). See “Using the System Recovery CD(s)” for more information.

You can also use the Application Recovery CD to install Windows 2000 drivers on your notebook.



You must be in Windows to run the Application Recovery CD. If you have any questions on using the Application Recovery CD, contact Sony Customer Support.

To use the Application Recovery CD(s)

- 1** Turn on your notebook. If your notebook is already on, close all applications.
- 2** When the Windows desktop appears, insert the Sony Application Recovery CD in the optical drive. The Application Recovery utility loads automatically.
- 3** When the Application Recovery menu appears, select the icon for the application you want to restore and then follow the on-screen instructions to complete the recovery process.



Your system may include one or two Application Recovery CDs. If you have two Application Recovery CDs, insert the first CD to run the Application Recovery program. You may be prompted to insert the second CD, depending on the application you wish to restore.

Using the Driver Recovery CD(s)

The Driver Recovery CD utility allows you to reinstall individual drivers and repair software applications if they become corrupted or are accidentally erased. You can reinstall an individual driver to correct a problem that you are experiencing with your computer, hardware, or software application. VAIO Support Agent uses a vault feature on the Driver Recovery CD(s) to repair software applications.



You must be in Windows to run the Driver Recovery CD utility.

To use the Driver Recovery CD(s)

- 1** Turn on your notebook. If your notebook is already on, close all applications.
- 2** When the Windows desktop appears, insert the Driver Recovery CD in the optical drive. The Driver Recovery utility loads automatically.
- 3** When the Driver Recovery menu appears, follow the on-screen instructions to complete the recovery process.

To repair software applications using VAIO Support Agent

The Driver Recovery CD utility has an information vault that contains the original characteristics for the preinstalled software applications that are protected by VAIO Support Agent.

Using the System Recovery CD(s)



This CD restores your notebook to its original state, so user data and applications will be lost.

You can use the System Recovery CD(s) to reinstall the operating system and software titles that shipped with your notebook if they become corrupted or are erased. You may not need to reinstall the entire contents of your hard drive. If you experience a problem with your notebook, reinstalling an individual device driver or software title may correct the problem. Use the Application Recovery CD(s) to reinstall individual applications. See “Using the Application Recovery CD(s)” for more information.

The System Recovery CD contains a backup copy of all the software originally installed on your hard disk drive. **It can be used only to recover the hard disk of the notebook you purchased.**

The System Recovery utility gives you Full Restore with Format, that is it formats the hard disk drive then restores all the original software.



Full Restore with Format removes all the information on the hard disk drive. You will lose any software you have installed and any other files you have created since you started to use your notebook. This means you will have to reinstall any applications that were not included with the notebook when you purchased it. If you have any questions on using the System Recovery CD, contact Sony Customer Support.

To use the System Recovery CD(s)

- 1 Insert the Sony System Recovery CD in the optical drive.
- 2 Shut down your notebook as described in “Shutting Down Your Notebook” in the printed Quick Start.
- 3 Wait four seconds and turn on your notebook.
- 4 Click OK to signify you have read and accept the Microsoft End-User License Agreement.
- 5 When the System Recovery menu appears, follow the on-screen instructions to complete the recovery process.

If your notebook does not start from the Recovery CD

- 1 Press the power button and hold it for more than four seconds to turn off the notebook.
- 2 Turn on the notebook. When the Sony logo is displayed, press the F2 key. The BIOS setup menu screen appears.
- 3 Press the arrow keys to select the Exit menu.
- 4 Press the arrow keys to select “Get Default Values” and then press the Enter key. The message “Load default configuration now?” appears.
- 5 Check that “Yes” is selected, then press the Enter key.

- 6 Press the arrow keys to select “Exit” (Save Changes) and then press the Enter key. The message “Save configuration changes and exit now?” appears.
- 7 Check that “Yes” is selected, then press the Enter key. The notebook restarts from the Recovery CD.



Your system may include one or two System Recovery CDs. If you have two System Recovery CDs, insert the first CD to run the System Recovery program. You are prompted to insert the second CD once the information from the first CD has been installed.

The recovery process takes from 30 to 60 minutes to complete.

After recovering your system using the SRCD, you may be prompted to insert your ARCD after restarting Windows. Insert the ARCD to automatically complete recovery of your system.

Recovering Microsoft Word

If you recover your operating system using the System Recovery CD, Microsoft Word will not be recovered. Use the supplied Word CD-ROM to recover this application.

Change text in this variable definition to document title.

Software Support Information

Adobe Acrobat Reader®

Web site	http://www.adobe.com
telephone	206-675-6126 (fee-based support)
e-mail	techdocs@adobe.com
hours	M-F, 6 A.M.-5 P.M. Pacific time

America Online®

Web site	http://www.aol.com
telephone	800-827-3338
hours	7 days a week, 24 hours a day

CompuServe® 2000

Web site	http://www.compuserve.com
telephone	800-848-8990

Drag'n Drop CD®

Web site	http://www.easy.co.jp/dde/sony/tosupportne.html
----------	---

Netscape Communicator®

Web site	http://www.netscape.com
telephone	888-4SONYPC (888-476-6972)
hours	7 days a week, 24 hours a day

Norton AntiVirus™

Web site	http://www.symantec.com/techsupp
telephone	800-927-3991 / 900-646-0007*
hours	7 days a week, 24 hours a day

*Support from 1-800-927-3991 is fee-based per incident. Support from 1-900-646-0007 is fee-based per minute. The online support is free of charge.

Prodigy Internet®

Web site	http://www.prodigy.com
telephone	800-213-0992
hours	7 A.M. - 3 A.M. eastern time

Quicken® 2001

Web site	http://www.intuit.com/support
telephone	900-555-4688
hours	7 days a week, 24 hours a day

QuickTime™

Web site	http://www.apple.com
telephone	512-674-8700
hours	7 days a week, 6 A.M. - 6 P.M. Pacific time

RealJukebox®, RealPlayer®, RealProducer® G2

Web site	http://www.realn networks.com
telephone	206-674-2681
fax	206-674-3586
e-mail	http://service.real.com (online form)
hours	M-F, 8 A.M. - 5 P.M. Pacific time

Sony Applications

Web site	http://www.sony.com/pcsupport
telephone	888-4SONYPC (888-476-6972)*
hours	7 days a week, 24 hours a day

* Support from 1-888-4SONYPC is free of charge for 90 days after the original date of purchase.

Windows® Operating System, Word

Web site	http://www.microsoft.com/support
telephone	888-4SONYPC (888-476-6972)*
hours	7 days a week, 24 hours a day

* Support from 1-888-4SONYPC is free of charge for 90 days after the original date of purchase.

Change text in this variable definition to document title.

WinDVD™ 2000

Web site	http://www.intervideo.com/jsp/Support.jsp
----------	---

e-mail	support@intervideo.com
--------	--

Sony Service Center

For the Sony Service Center nearest you, call 1-888-4SONYPC (1-888-476-6972) or find Sony Customer Service on the Web at <http://www.sony.com/pcsupport>.

Troubleshooting

This section describes how to solve common problems you may encounter when using your notebook. Many problems have simple solutions, so try these suggestions before you contact Sony PC Support (<http://www.sony.com/pcsupport>). Consult the following sections:

- Troubleshooting Your Notebook
- Troubleshooting the Docking Station
- Troubleshooting the LCD Screen
- Troubleshooting the Mouse and Touchpad
- Troubleshooting Drives, PC Cards, and Peripheral Devices
- Troubleshooting the Software
- Troubleshooting the Modem
- Troubleshooting Audio
- Troubleshooting the Printer

Troubleshooting Your Notebook

My notebook does not start.

- Check that the notebook is plugged into a power source and that it is turned on. Check that the power indicator on the front panel of the notebook indicates that the power is on.
- Check that the battery packs are inserted properly and that they are charged.
- Make sure there is no floppy disk in the floppy disk drive.
- Confirm that the power cord and all cables are connected firmly, as described in “Connecting a Power Source” in the printed Quick Start.
- If you plugged the notebook into a power strip or UPS, make sure the power strip or UPS is turned on and working.

Change text in this variable definition to document title.

- ❑ If you are using an external display, check that it is plugged into a power source and turned on. Check that the brightness and contrast controls are adjusted correctly. See the manual that came with your display for details.
- ❑ Moisture condensation may have occurred. Do not use the notebook for at least one hour and then turn on the notebook.
- ❑ Take the battery pack off the notebook, unplug the power cord and plug it again, then turn on the power.
- ❑ If you shut down your notebook using a series of program errors, the power control button may not function. Push the Reset switch on the back of your notebook with a thin, pointed object to start your notebook. If your notebook still does not start, remove the AC adapter and battery pack and wait one minute, then reattach them and press the power button.

My notebook starts, but my system doesn't start properly.

When the internal backup battery is low on power, your system may not start properly, and the message "Press <F1> to resume, <F2> to setup" may appear at the bottom of the screen. In such a case, proceed as follows:

- 1 Press F2. The BIOS Setup menu appears.
- 2 Set the date (month/day/year). Press Enter.
- 3 Press ↓ to select System Time, then set the time (hour: minute: second). Press Enter.
- 4 Press → to select Exit, then press ↓ to select Get Default Values. The message "Load default configuration now?" appears.
- 5 Select Yes and press Enter.
- 6 Select Exit (Save Changes), then press Enter. The message "Save Configuration changes and exit now?" appears.
- 7 Select Yes, then press Enter. The notebook restarts.



If this occurs on a regular basis, contact Sony PC Support (<http://www.sony.com/pcsupport/>).

My notebook starts, but the message “Operating system not found” appears and Windows does not start.

- ❑ Make sure there is no floppy disk in the floppy disk drive (non-bootable).
- ❑ If a non-bootable floppy disk is in the drive, proceed as follows:
 - 1 Turn off the notebook, then remove the floppy disk.
 - 2 Restart the notebook and confirm that Windows starts properly.
- ❑ If Windows still does not start, follow the steps below to initialize the BIOS:
 - 1 Remove any floppy disk from the floppy disk drive.
 - 2 Turn off the notebook.
 - 3 Remove any peripheral devices connected to the notebook.
 - 4 Turn on the notebook.
 - 5 Press the F2 key when the Sony logo appears, to access the BIOS setup menu.
 - 6 Press the directional arrow keys to select the Exit menu.
 - 7 Press the arrow keys to select “Get Default Values” then press Enter. The message “Load default configuration now?” appears.
 - 8 Select Yes, then press Enter.
 - 9 Use the directional arrow keys to select “Exit” (Save Changes), then press Enter. The message “Save configuration changes and exit now?” appears.
 - 10 Select Yes, then press Enter. The notebook restarts.

If your notebook continues to display the message “Operating system not found,” and Windows does not start, use your supplied System Recovery CD to restore the software titles shipped with your notebook. See “Using the System Recovery CD(s)” for more information.



The System Recovery CD restores your notebook to its original state, so user data and applications will be lost.

My notebook stops responding or does not shut down.

It is best to use the Shut Down command on the Windows Start menu to shut down your notebook. Using other methods, including those listed below, may result in loss of unsaved data.

- ❑ Click the Start button on the Windows taskbar, then click Shut Down, then click Restart.
- ❑ If the preceding step does not work, press Ctrl+Alt+Delete simultaneously and click Shut Down on the Windows Security window to restart the notebook.
- ❑ If the preceding step does not work, press and hold the power button for at least four seconds to turn off the power.
- ❑ If the preceding step does not work, unplug the notebook from the AC adapter and remove the battery pack from your notebook.
- ❑ If your notebook stops responding while playing a CD or DVD, press Ctrl+Alt+Delete and click Shut Down on the Windows Security screen to restart your notebook.



Pressing Ctrl+Alt+Delete simultaneously or turning off the notebook with the power switch may result in data loss in files that are currently open.

My notebook is unstable.

Your notebook's operating system may become unstable if a lower power state, such as Hibernate, is initiated then changed before the notebook completely enters the lower power state. To restore the notebook to its normal operating stability:

- 1 Close all open applications.
- 2 Press and hold the power button for four seconds or longer to shut down the notebook.

The sound of my notebook's fan is too loud.

Use the PowerPanel utility to change the Thermal Control Strategy setting to Quiet. This setting slows down the CPU speed. See PowerPanel help for more information.

Troubleshooting the Docking Station

I cannot operate the optical drive in the docking station, when the docking station is connected to the notebook.

Follow these steps to set the i.LINK network switch.

- 1 Disconnect your notebook from the docking station.
- 2 Disconnect the AC adapter and all cables from your docking station.
- 3 Set the i.LINK network switch on the bottom of the docking station to the unmarked side, with a thin pen tip.
- 4 Connect the docking station to the notebook.
- 5 Turn on your notebook.



Do not set the i.LINK network switch when the notebook is on. This causes the notebook to malfunction.

Set the i.LINK network switch after removing all cables connected to the docking station.

I cannot operate the optical drive in the docking station, when the docking station is connected to the notebook and the notebook is connected to another computer via i.LINK.

Set the i.LINK network switch at the bottom of the docking station to the marked ● side. See “If your notebook is connected to the optional docking station” for more information.

An error message appears while disconnecting the docking station, even after following the correct procedure for disconnecting the docking station.

Close the software in use, disconnect other devices being used, then try to disconnect the docking station from the notebook.

I cannot remove the disc.

You cannot remove the disc when the notebook is in power saving mode. Return to normal mode, then press the Eject button.

Change text in this variable definition to document title.

The disc tray does not eject even after I press the Eject button.

Open the tray by inserting a sharp, pointed object (such as a paper clip) in the manual eject hole.

Troubleshooting the LCD Screen

My LCD screen is blank.

- Verify that the notebook is plugged into a power source and that it is turned on.
- Verify that the power indicator on the notebook is on.
- Verify that the battery pack(s) is inserted properly and is charged.
- The notebook may be in LCD (Video) Standby mode. Press any key to activate the screen.
- The display mode may be set to external display mode. Press and hold the Fn key while pressing F7 several times.

My LCD screen continues to show the previous screen.

Press the Windows key and D key twice to refresh the screen.

The image on my connected external display is not centered or sized properly.

Use the controls on your external display to adjust the image. See the manual that came with your display for more information.

I want to change the video resolution of my display.

- 1** Click Start, point to Settings, point to Control Panel, then double-click the Display icon. The Display Properties dialog box appears.
- 2** Click on the Settings tab.
- 3** Move the Screen Area slider to change your video resolution.

Troubleshooting the Mouse and Touchpad

My mouse does not work.

- ❑ If you are using an external mouse, verify that the mouse is plugged into the mouse connector. See “Connecting a USB Device” for more information.
- ❑ If you are using an optional Sony USB mouse PCGA-UMS1 series, verify that the mouse is plugged into the USB port.

My touchpad does not work properly.

- ❑ You may have disabled the touchpad without connecting a mouse to the notebook. To enable the touchpad:
 - 1 Click Start > Programs > Sony Notebook Setup.
 - 2 Select the Touchpad tab.
 - 3 Click Use touchpad and click OK.
- ❑ If your touchpad is interpreting a single tap as a double-click, adjust the button assignments as follows:
 - 1 Click Start, point to Control Panel, then double-click on the Mouse icon. The Mouse Properties dialog box appears.
 - 2 Change the button assignments in the Mouse Properties dialog box. (One of the buttons is assigned to the double-click action.)

The pointer does not move (while using the Touchpad or Mouse).

Click the Start button on the Windows taskbar, select Shut Down to display the Shut Down Windows dialog box, then press Enter.

- ❑ If you cannot turn off your notebook as described in the step above, press Ctrl+Alt+Delete and click Shut Down on the Windows Security screen to restart the notebook.
- ❑ If you cannot restart your notebook as described in the step above, press and hold the power button for more than four seconds to turn off the notebook.
- ❑ If the pointer does not move while playing a disc, press Ctrl+Alt+Delete to stop playback and restart the notebook.

Troubleshooting Drives, PC Cards, and Peripheral Devices

My floppy disk drive can not write to a floppy disk.

- ❑ If the floppy disk is write-protected, disable the write-protect feature or use a floppy disk that is not write-protected.
- ❑ Verify that the floppy disk is properly inserted into the floppy disk drive.

My optical drive is not playing my CD or DVD properly.

- ❑ Make sure the label of the disc is facing up.
- ❑ If the disc requires software, make sure the software is installed according to the manufacturer's instructions.
- ❑ A dirty or damaged disc may cause the notebook to stop responding while it tries to read the disc. If necessary, restart the notebook, remove the disc, and check disc for dirt or damage.
- ❑ If you see video but can not hear audio, check all of the following:
 - ❑ Check that your optical drive does not have the mute setting enabled.
 - ❑ Check the volume setting in the audio mixer.
 - ❑ If you are using external speakers, check the volume settings, and then check the connections between your external speakers and the notebook.
 - ❑ Click Start, point to Settings, point to Control panel, then double-click System. The System Properties dialog box appears.
 - ❑ Click the Device Manager tab.
 - ❑ Verify that the correct drivers are installed properly.
- ❑ Do not use adhesive labels to identify the CD. The label may come off while the disc is in use in the optical drive and cause the drive to malfunction.
- ❑ If a region code warning appears when you try to use your optical drive, it may be that the DVD you are trying to play is incompatible with the optical drive. Verify that the region code listing on the DVD packaging is region "1" or "0".
- ❑ Moisture condensation may have occurred. Leave the notebook idle for at least 1 hour with the notebook turned on.

My optical drive tray does not open.

- ❑ Make sure the notebook is turned on.
- ❑ Press the Eject button on the optical drive.
- ❑ If the Eject button does not work, open the tray by inserting a thin pen tip in the hole to the right of the Eject button.

I cannot use digital video (DV) devices. The message “DV equipment seems to be disconnected or turned off” appears.

- ❑ Verify that the DV device is turned on and that the cables are properly connected.
- ❑ If you are using multiple i.LINK devices, the combination of the connected devices may cause unstable operation. In this case, proceed as follows:
 - 1 Turn off your notebook and all connected devices.
 - 2 Disconnect the devices that are not in use.
 - 3 Ensure that all other devices are properly connected.
 - 4 Restart your notebook.

My PC Card does not work.

- ❑ Make sure the PC Card is compatible with Microsoft® Windows®.
- ❑ Use the Sony Notebook Setup utility to disable devices you are not currently using.

Troubleshooting the Software

My software program stops responding or crashes.

Contact the software publisher or designated provider for technical support. See “Software Support Information” for contact information.

When I click an application icon, the message “You must insert the application CD into your optical drive” appears and the software does not start.

- Some titles require specific files that are located on the application CD. Insert the disc and try starting the program again.
- Make sure you place the CD in the tray with the label side facing up.

I hear background “noise” while using Windows Media Player to play my music CDs.

Sony suggests using the preinstalled Media Bar software to play audio CDs.

The application cannot find a file while a PC Card is inserted.

Some PC Cards when inserted in a notebook that is connected to the docking station may change the drive letters of the disk drives in the docking station. If this occurs, an application you are using may not be able to find files.

To correct this condition perform one of the following steps:

- Remove the PC Card and restart your notebook, and do not insert the PC Card while using that application.
- Change the drive letters of the disk drives of the docking station or of the PC Card. Refer to the Windows help files or the manuals of the application to change the drive letters.

Troubleshooting the Modem

My modem does not work.

- ❑ Check that the phone line is plugged into the line jack. See “Using a Phone Line” for more information.
- ❑ Check that the phone line is working by plugging the line in an ordinary phone and listening for a dial tone.
- ❑ Verify that the phone number the program is dialing is correct.
- ❑ Verify that the software you are using is compatible with the notebook’s modem. (All preinstalled Sony programs are compatible.)



My modem connection is slow.

Your notebook is equipped with a V.90/K56flex-compatible modem. Many factors may influence modem connection speed, including telephone line noise or compatibility with telephone equipment (such as fax machines or other modems). If you think your modem is not connecting properly to other PC-based modems, fax machines, or your Internet Service Provider, proceed as follows:

- ❑ Have your phone company verify that your phone line is free from any line noise.
- ❑ If your problem is fax-related, check that there are no problems with the fax machine you are calling and that it is compatible with fax modems.
- ❑ If you are having a problem connecting with your Internet Service Provider, check that the ISP is not experiencing technical problems.
- ❑ If you have a second phone line available, try connecting the modem to that line.

Troubleshooting Audio

My speakers have no sound.

- ❑ If the built-in speakers are turned off, press Fn+F3 or use the Jog Dial control to turn on the speakers.
- ❑ If the speaker volume is turned to the minimum, press Fn+F4, then press  or  to increase the volume, or you can use the Jog Dial control to control the volume.
- ❑ If nothing is displayed when you press Fn+F3 or Fn+F4, proceed as follows:
 - 1 Click Start, point to Settings, point to Control panel, then double-click System. The System Properties dialog box appears.
 - 2 Click the Device Manager tab.
 - 3 Set the sound device to enable.
- ❑ If your notebook is powered by batteries, verify that the battery packs are inserted properly and that they are charged.
- ❑ If you are using an application that has its own volume control, verify that the volume is turned up.
- ❑ Check the volume controls in Windows®.
- ❑ If you connect external speakers:
 - ❑ Verify that the speakers are properly connected and the volume is turned up.
 - ❑ If the speakers have a mute button, make sure the button is off.
 - ❑ If the speakers are powered by batteries, verify that the batteries are inserted properly and that they are charged.
- ❑ If you have connected an audio cable to the Headphone jack, disconnect the cable.

My microphone does not work.

If you are using an external microphone, verify that the microphone is plugged into the Microphone jack. See “Connecting an External Microphone” for more information.

Troubleshooting the Printer

I cannot print.

- ❑ The default setting for the printer port mode is correct for most printers. If you cannot print, try changing the printer port mode. In the Sony Notebook Setup screen, select the Printer tab. If the printer port mode is set to ECP, change it to bi-directional; if the printer port mode is set to bi-directional, change it to ECP. See “Displaying the Sony Notebook Setup Screen” for information on using Sony Notebook Setup.
- ❑ Your connected printer may not function after the notebook resumes from a power saving mode. If this occurs, proceed as follows to reset the printer connection:
 - 1 Click My Computer icon on the desktop, then click on the Control Panel folder.
 - 2 Click on the Printers folder.
 - 3 Right-click on the icon of the printer that is malfunctioning, then select Properties to access the Properties window.
 - 4 Click OK to close the Properties window. The printer should function properly.

Getting Help

Sony provides you with several support options to answer questions about your VAIO notebook or the preinstalled software. Refer to these resources in the order they are listed.

Support Options

1 VAIO® User Guide and VAIO® Quick Start

The online VAIO® *User Guide* and printed VAIO® *Quick Start* provide you with information on how to maximize your notebook capabilities and solve common problems. To access the online user guide, click Start in the Windows® taskbar, select Help Center and VAIO Documentation. The quick start is supplied with your notebook.

2 Manuals and online help files that may accompany your preinstalled software

Most of the manuals for preinstalled software are located on your hard disk drive as online help files. You can access the online help files from the Help menu in the specific application. A printed manual is available for some applications.

3 VAIO Support Agent

VAIO Support Agent can be accessed from the Windows desktop. Using advanced diagnostic technology, Sony's VAIO Support Agent runs scheduled protections of your applications, network settings, and other important software settings. When your software is protected, you can use VAIO Support Agent to repair software problems by restoring your software to any of the previously protected states.

4 Sony PC Support

Provides instant access to information on commonly encountered problems. Enter a description of your problem and the Knowledge Database searches for the corresponding solutions online. You can access the Sony PC Support at: <http://www.sony.com/pcsupport>.

5 Sony Fax-on-Demand

This service, which requires a fax machine or your fax software, provides answers to commonly asked questions. You can use this automated service to request a list of available topics then select the topics that you want to receive. To contact the Sony fax-on-demand service, call: 1-888-4SONYPC (1-888-476-6972).

6 Calling Sony Customer Support

Sony provides software support free of charge for 90 days after the original date of purchase. You can speak with a Sony Customer Support Representative without using your notebook by calling: 1-888-4SONYPC (1-888-476-6972).

VAIO Support Agent

VAIO Support Agent helps you repair your own software problems without the assistance of a support analyst. VAIO Support Agent's advanced diagnostic technology identifies and tracks characteristics of your software applications and basic network settings. These diagnostics protect and store information in a retrievable format that enables you to restore your software to a previous working state. Sony has identified the software items that are protected by the VAIO Support Agent utility.

VAIO Support Agent has three features to help you fix your software problems: Quick Fix Wizard, Common Solutions, and Support Central. This section briefly describes these three features, and the automatic update capability of the VAIO Support Agent.

VAIO Support Agent main window



To use the Quick Fix Wizard

The VAIO Support Agent records and maintains a history of the VAIO Support Agent protected applications by taking a “snapshot” of the application at regular, timed intervals and storing it for future use. Should a problem develop with one of the protected applications, you can use the Quick Fix Wizard feature to

retrieve the date/time (snapshot) that was recorded when the application worked correctly. The Quick Fix Wizard repairs the protected application files without altering the data files you have created using the application.

To use the Quick Fix Wizard, follow these steps:

- 1 From the VAIO Support Agent main window, click the Quick Fix Wizard button. The Welcome window appears.
- 2 Click Next. The “Quick Fix Wizard: Begin VAIO Support Agent Diagnostics” dialog box appears.
- 3 Select the “Diagnose and fix my software” option.
- 4 Select the software you wish to repair from the drop-down list.



To view a list of software applications protected by VAIO Support Agent, click on the “Pick the software:” drop-down list.

- 5 Next, select a date/time from the drop-down list that corresponds to the last time when the software worked properly.
- 6 Click Next to continue. Follow the instructions on the screen.

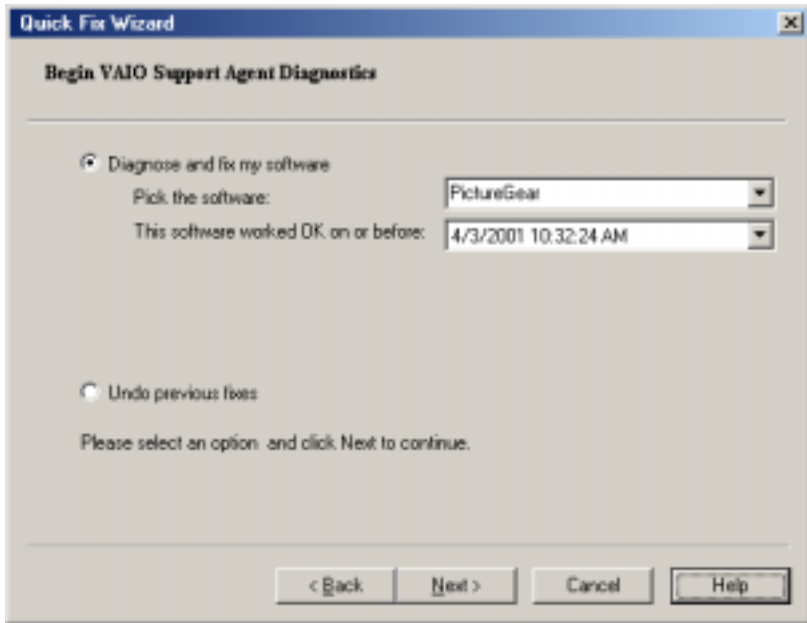
Quick Fix Wizard: Begin VAIO Support Agent Diagnostics dialog box**To use Common Solutions**

Common Solutions offers automated, One-Click Fixes to repair common software problems. These solutions can integrate information such as knowledge base articles and Frequently Asked Questions (FAQs). You can run One-Click Fixes directly from VAIO Support Agent or from a Web browser.

- 1 Click the Common Solutions button. The Common Solutions dialog box appears.
- 2 Double-click on the desired category to expand and view available SupportActions.
 - ❑ VAIO Support Local Server (C:/program files/support.com...) provides a list of SupportActions available on your notebook's hard disk drive.
 - ❑ VAIO Support Local Server (<http://sdcglobal4.sel.sony.com...>) provides a list of SupportActions available from the Internet.

Change text in this variable definition to document title.

Common Solutions dialog box (1st level)

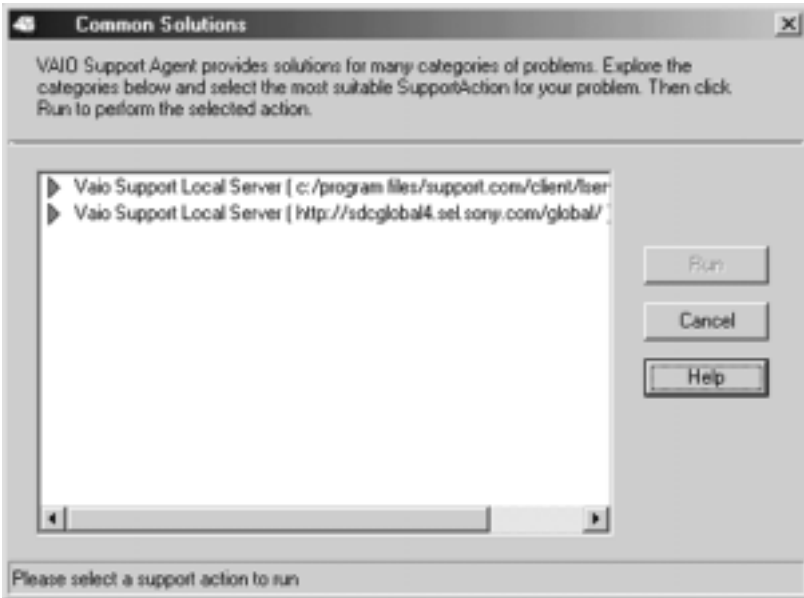

 Connect to the Internet before attempting to view the category, “Vaio Support Local Server (<http://sdcglobal4.sel.sony.com...>).” This category is unavailable without an Internet connection.

- 3 Click the resize arrows next to the SupportAction categories to expand or collapse the categories.

Common Solutions dialog box (2nd level)

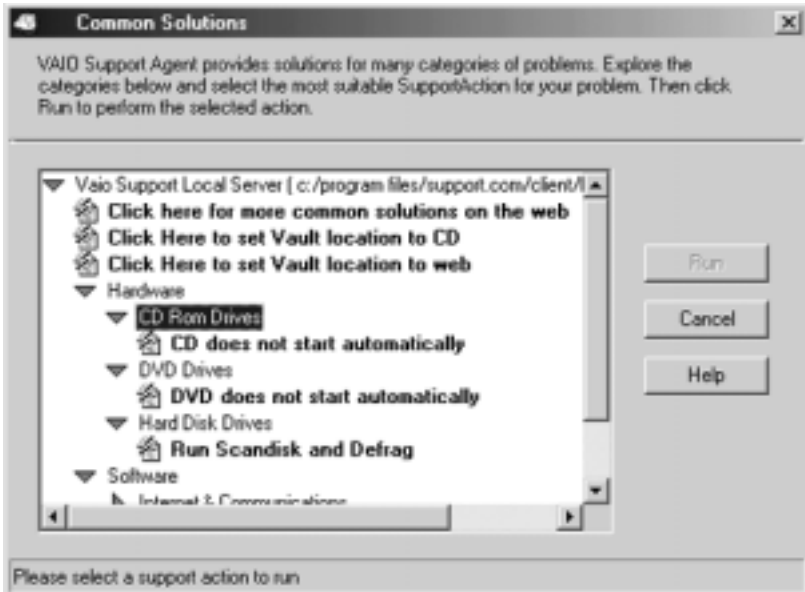

- 4 Select the appropriate SupportAction from the list.
- 5 Click Run or double-click the desired SupportAction. The available SupportActions are shown in bold type.

 You cannot undo One-Click Fixes.

To use Support Central

The Support Central feature uses Internet resources to help you fix your software. Support Central searches the Internet for answers to your questions, additional information from knowledge base systems, and the latest software updates for your protected software. Support Central also lets you contact live support agents for additional help.

Change text in this variable definition to document title.

- 1 Connect to the Internet.
- 2 From the VAIO Support Agent main window, click Support Central. The Support Central Welcome page appears.

 You must have Internet access to use Support Central.

Support Central: Welcome page



- 3 Click Enter Portal to begin using Support Central. First-time users will be asked to register with Support Central.

 Support Central retains your registration information, so you are only required to register once. If you log on to your notebook with a different user name or have recovered your system using the System Recovery CDs, Support Central may require you to register again.

Support Central: Registration page

Support Central

What's New!

sony style VAIO

Please complete the information on this form so that we have a complete record of your support issue.

This should only need to enter this information once. If you send an e-mail to us in the future using Live Support we will display this information for you to review and update.

Please note: If you uninstalled the VAIO Support Agent software, use the System Recovery CD to recover your entire system or log on to your system using a different user name you may need to reenter this information the next time you use this page.

After you complete the information on this form, please click "Submit". If you have questions as to how the information you provide on this form may be used, please e-mail us at 22362122022.

Thank you for using Support Central and the VAIO Support Agent.

Phone Number (no area code) *

First Name *

Address Initial *

Last Name *

Company Name *

Address 1 *

Address 2 *

City *

State/Province *

ZIP or Postal Code *

Email Address *

Product Model # *

Product Serial # *

Place of Purchase *

Purchase Date (MM/DD/YYYY) *

Submit

Change text in this variable definition to document title.

Support Central: Current Issues page



When you log on to Support Central, the Current Issues page displays, enabling you to continue working on your open issues or to close them if you are finished. Support Central has a tracking feature that stores your current issues, enabling you to return and work on them later.

Support Central: Support Wizard page



If you log on to Support Central with a new issue, or if you do not have any open issues, the Support Wizard appears. You can begin searching on the new issues.



You must be connected to the Internet to use Support Central.

About automatic updates

The VAIO Support Agent is dormant as a background process. Every 24 hours, the Agent self-activates to contact the Sony Support Server to check for new updates or fixes needed for your system. This updating action only occurs while you are connected to the Internet and when more than 24 hours has passed since the last update.

Each time the VAIO Support Agent prepares to check for updates, the Agent Status Update dialog box appears and asks you to respond, unless you have previously selected the option, “Always accept updates and do not prompt me again.”

Agent Status Update

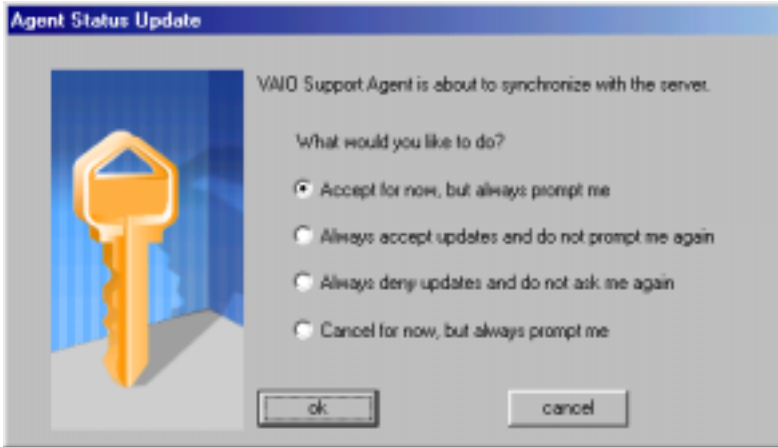



You can choose from four response options:

- Give the Agent your permission to contact the Sony Support Server for any updates or fixes that are available specifically for your notebook. The Agent continues to prompt you for your permission to retrieve updates.
- Give the Agent your permission to contact the Sony Support Server for any updates or fixes that are available specifically for your notebook. The Agent automatically retrieves updates without further prompting.
- Deny the Agent your permission to contact the Sony Support Server for any updates or fixes. The Agent discontinues any update retrieval and does not prompt again for your permission to update.
- Deny the Agent your permission to contact the Sony Support Server for the current update or fix. The Agent discontinues the current update retrieval, but prompts again for your permission for the next scheduled update.

Update notification

Once you have granted permission for the system to check for updates or fixes, the Agent contacts the Sony Support Server. Available updates or fixes may be displayed to you in one of two ways. An update or fix may be displayed in a

window with an explanation and instructions to follow. Others will cause the ambulance icon  on your task tray to blink. You should always check the ambulance icon in the task tray after the system checks for updates. If the icon is blinking, double-click the ambulance icon to view the update.

 When clicking on the flashing ambulance icon, you must be connected to the Internet to receive an update.

VAIO Support Agent properties

To control the VAIO Support Agent automatic update feature, follow these steps:

- 1 In the VAIO Support Agent main screen, select Tools, then select Properties. The VAIO Support Agent Properties dialog box appears.
- 2 Select one of three options to customize the automatic update feature.
- 3 Click OK.

VAIO Support Agent Properties window

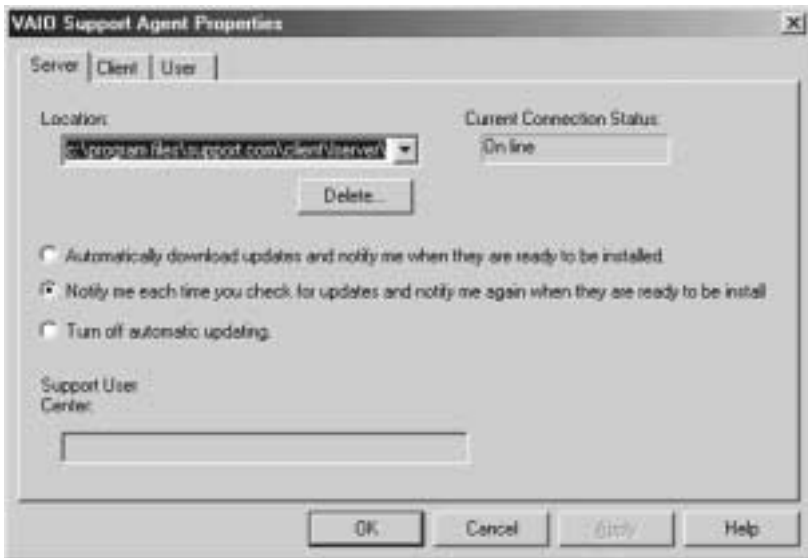

Change text in this variable definition to document title.

Index

A

- About This Computer tab 69
- AC Profile power setting 72
- adjusting
 - brightness 15
- Alt key 12
- Application Recovery CD 122
- Applications key 12
- audio
 - troubleshooting 141

B

- Basic/Advanced tab 69
- battery pack
 - charge status icons 75
 - indicator lights 13
 - power management settings 70
 - power saving modes 35
- BatteryScope utility 75
- brightness
 - adjusting 15
- built-in speaker 15
 - volume 15
- buttons
 - Start 67

C

- cameras
 - digital video recorder 55
- canceling commands 11
- Caps Lock
 - indicator light 14
- CD-ROM discs

- inserting 49
- CD-ROM drive
 - closing lid 50
 - connecting 19
- CD-ROMs
 - handling 51
- choosing
 - display mode 78
- cleaning
 - CD and DVD media 51
- coin-operated telephones 37
- computer 143
 - indicators 13
 - setup screen 67
 - troubleshooting 129, 139
- connecting 49
 - CD-ROM drive 19
 - coin-operated telephones 37
 - digital video camera recorder 55
 - external speakers 64
 - floppy disk drive 47
 - i.LINK device 55
 - microphone 65
 - multiple phone lines 37
 - network 19, 40
 - optical drive 49
 - party phone lines 37
 - PBX 37
 - phone line 37
 - port replicator 39
 - printer 53
 - projector 59

- USB device 62
- connectors
 - network 40
 - Serial port 40
- correction keys 11, 12
- Ctrl key 12
- cursor-movement keys 11
- D**
- digital video camera recorder 55
- diskettes
 - ejecting 47
 - handling 48
 - inserting into drive 47
 - troubleshooting 137
- display
 - connecting external 58
 - connecting projector 59
 - mode 78
 - options 61
 - selecting 61
- docking station
 - troubleshooting 133
- Driver Recovery CD 123
- drives
 - troubleshooting 137
- DV In/Out 55
- DVD drive
 - connecting 49
- DVD-ROM drive tray
 - troubleshooting 138
- DVD-ROMs
 - handling 51
- DVGate 95
- E**
- Eject button 47
- ejecting
 - diskettes 47
- Electronic Music Distribution (EMD)
 - services 100
- EMD services 100
- Escape key 11
- external devices
 - display 58
 - projector 59
 - speakers 64
- F**
- floppy disk drive 47
 - troubleshooting 137
- Fn key 12
 - combination commands 15
- function keys 12
- G**
- getting help 143
- Guide Mode 28
- H**
- handling
 - CD-ROMs and DVD-ROMs 51
 - diskettes 48
- hard drive
 - indicator light 13
- hardware
 - online support 143
- headphone
 - connector 59, 60
- help 143
- I**
- i.LINK 55
 - connecting 55
- IEEE1394 55
- ImageStation 117
- indicator lights 13
 - battery 13
 - Caps Lock 14
 - hard drive 13
 - Num Lock 14
 - Scroll Lock 14

- indicators 13
- Insert key 11, 12
- inserting
 - diskettes into drive 47
- J**
- Jog Dial 26
- K**
- keyboard 9–15
 - Fn key 15
 - using 9
 - Windows key 14
- L**
- Launcher Mode 27
- LCD
 - selecting to display output 61
 - troubleshooting 135
- M**
- MagicGate 30
- Maximum Battery Life power setting 72
- Maximum Performance power setting 72
- memory
 - adding 81
- Memory Stick card slot 30
- Memory Stick media 30
 - displaying contents 31
- microphone
 - connecting 65
 - troubleshooting 141
- modem
 - troubleshooting 140
- monitor
 - connecting external display 58
 - selecting 61
 - switching among 16
- mouse
 - troubleshooting 136
- mouse properties 18
- MovieShaker 97
- multiple phone lines 37
- N**
- navigation keys 11
- network
 - connector 40
 - port replicator 40
- Notebook Setup tabs 69
- Num Lock
 - indicator light 14
- numeric keypad area 11
- O**
- OpenMG Jukebox 100
- operator keys 12
- optical drive 49
- P**
- party phone lines 37
- PBX 37
- PC Card
 - inserting 19
 - removing 20
 - troubleshooting 137
 - Type II 19
 - using 19
- peripheral devices
 - troubleshooting 137
- phone
 - connecting line 37
 - jack 37
- PictureGear 107
- port replicator
 - connecting 39
 - network 40
- power 13
- power management
 - settings 70
- Power Management Off power setting

- 72
- Power On
 - Password tab 69
- power saving modes 30, 35
 - System Hibernation 16, 35
 - System Idle 35
 - System Suspend 35
- power setting
 - AC Profile 72
 - Maximum Battery Life 72
 - Maximum Performance 72
 - Power Management Off 72
 - System Suspend 74
- PowerPanel
 - activating 70
 - customizing toolbar 71, 74
- Print Screen key 11
- printer
 - connecting 53
 - troubleshooting 142
- Printer tab 69
- R**
- Recovery CD 122
- removing
 - diskettes 47
- restoring data 122
- S**
- Scroll Lock
 - indicator light 14
- selecting
 - display 61
 - LCD 61
 - monitor 61
- Serial connector 40
- setting up your PC
 - support 143
- setup screen
 - About This Computer tab 69
 - Basic/Advanced tab 69
 - displaying 67
 - Power On Password tab 69
 - Printer tab 69
 - Touchpad tab 69
- setup tabs 69
- Shift key 12
- Smart Capture 109
- software
 - DVGate 95
 - ImageStation 117
 - MovieShaker 97
 - overview 89
 - PictureGear 107
 - Smart Capture 109
 - troubleshooting 139
 - VisualFlow 120
- Sony Fax-on-Demand service 144
- Sony Notebook Setup screen 67
- speakers
 - external 64
 - troubleshooting 141
- Start button 67
- support
 - VAIO Support Agent 145
- Support Central 149
- support options 143
- switching
 - display 16
 - monitor 16
- System Hibernation mode 16, 35
- System Suspend mode 35, 74
- T**
- technical support 143
 - VAIO Support Agent 145
- touchpad
 - troubleshooting 136
 - using 17
- Touchpad tab 69

- troubleshooting 129
 - audio 141
 - docking station 133
 - drives, PC Cards, and peripherals 137
 - LCD screen 135
 - modem 140
 - mouse and touchpad 136
 - printer 142
 - software 139
- U**
- USB
 - connecting 62
 - connector 62
 - mouse 62
- using
 - floppy disk drive 47
 - Jog Dial 26
 - keyboard 9
 - Memory Stick 30
 - PC Cards 19
 - phone line 37
 - touchpad 17
 - VAIO Action Setup 25
- V**
- VAIO Action Setup 25
- VAIO Support Agent 145
 - Support Central 149
- VAIO® Action Setup 25
- video camera recorder 55
- VisualFlow 120
- W**
- window design of Sony software 80
- Windows
 - Explorer 14
 - Find window 14
 - Help 14
 - key 12
- key combinations 14
- taskbar 132