

SONY®

VAIO® Z505 SuperSlim Pro™ Notebook User Guide

PCG-Z505JE/PCG-Z505JEK/PCG-Z505JS/PCG-Z505JSK



Notice to Users

© 2000 Sony Electronics Inc. All rights reserved. This manual and the software described herein, in whole or in part, may not be reproduced, translated, or reduced to any machine-readable form without prior written approval.

SONY ELECTRONICS INC. PROVIDES NO WARRANTY WITH REGARD TO THIS MANUAL, THE SOFTWARE, OR OTHER INFORMATION CONTAINED HEREIN AND HEREBY EXPRESSLY DISCLAIMS ANY IMPLIED WARRANTIES OF MERCHANTABILITY OR FITNESS FOR ANY PARTICULAR PURPOSE WITH REGARD TO THIS MANUAL, THE SOFTWARE, OR SUCH OTHER INFORMATION. IN NO EVENT SHALL SONY ELECTRONICS INC. BE LIABLE FOR ANY INCIDENTAL, CONSEQUENTIAL, OR SPECIAL DAMAGES, WHETHER BASED ON TORT, CONTRACT, OR OTHERWISE, ARISING OUT OF OR IN CONNECTION WITH THIS MANUAL, THE SOFTWARE, OR OTHER INFORMATION CONTAINED HEREIN OR THE USE THEREOF.

Sony Electronics Inc. reserves the right to make any modification to this manual or the information contained herein at any time without notice. The software described herein is governed by the terms of a separate user license agreement.

This product contains software owned by Sony and licensed by third parties. Use of such software is subject to the terms and conditions of license agreements enclosed with this product. Some of the software may not be transported or used outside the United States. Software specifications are subject to change without notice and may not necessarily be identical to current retail version.

Updates and additions to software may require an additional charge. Subscriptions to online service providers may require a fee and credit card information. Financial services may require prior arrangements with participating financial institutions.

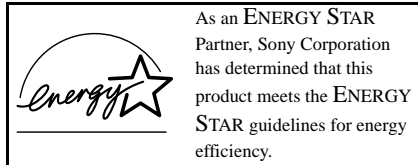

The International ENERGY STAR Office Equipment Program is an international program that promotes energy saving through the use of computers and other office equipment. The program backs the development and dissemination of products with functions that effectively reduce energy consumption. It is an open system in which business proprietors can participate voluntarily. The targeted products are office equipment such as computers, displays, printers, facsimiles and copiers. Their standards and logos are uniform among participating nations. ENERGY STAR is a U.S. registered mark.

Sony, i.LINK, Jog Dial, Handycam, PictureGear, DVgate, VAIO, the VAIO logo, Z505 SuperSlim Pro, MagicGate, **Memory Stick**, and the **Memory Stick** logo, are trademarks of Sony Corporation. MS-DOS, Windows, the Windows 2000 logo, and the Windows 98 logo are registered trademarks of Microsoft Corporation.

All other trademarks are trademarks of their respective owners.

Owner's Record

The model number and serial number are located on the bottom of your Sony VAIO® Z505 SuperSlim Pro™ notebook. Record the serial number in the space provided here. Refer to the model and serial number when you call your Sony Service Center.

Model Number: PCG-5211/
PCG-5212/PCG-5201/PCG-5202

Serial Number: _____

Safety Information

WARNING

- To prevent fire or shock hazard, do not expose your notebook to rain or moisture.
- To avoid electrical shock, do not open the cabinet. Refer servicing to qualified personnel only.
- Never install modem or telephone wiring during a lightning storm.
- Never install telephone jacks in wet locations unless the jack is specifically designed for wet locations.
- Never touch uninsulated telephone wire or terminals unless the telephone line has been disconnected at the network interface.
- Use caution when installing or modifying telephone lines.
- Avoid using the modem during an electrical storm.
- Do not use the modem or a telephone to report a gas leak in the vicinity of the leak.
- A socket outlet should be as close as possible to the unit and easily accessible.

AVERTISSEMENT

- Pour prévenir tout risque d'incendie ou d'électrocution, garder cet appareil à l'abri de la pluie et de l'humidité.
- Pour prévenir tout risque d'électrocution, ne pas ouvrir le châssis de cet appareil et ne confier son entretien qu'à une personne qualifiée.

- Ne jamais effectuer l'installation de fil modem ou téléphone durant un orage électrique.
- Ne jamais effectuer l'installation d'une prise téléphonique dans un endroit mouillé à moins que la prise soit conçue à cet effet.
- Ne jamais toucher un fil téléphonique à découvert ou un terminal à moins que la ligne téléphonique n'ait été débranché de l'interface réseau.
- Soyez très prudent lorsque vous installez ou modifiez les lignes téléphoniques.
- Évitez d'utiliser le modem durant un orage électrique.
- N'utilisez pas le modem ni le téléphone pour prévenir d'une fuite de gaz si vous êtes près de la fuite.
- L'appareil doit être le plus près possible d'une prise murale pour en faciliter l'accès.

! Caution: To reduce the risk of fire, use only No. 26 AWG or larger telecommunication line cord.

! Attention : Afin de réduire les risques d'incendie, n'utilisez qu'un cordon de communication NO. 26 AWG ou plus gros.

Regulatory Information

If you have any questions about this product, you can reach the Sony Customer Information Service Center at 1-888-4SONYPC; or write to the Sony Customer Information Service Center at 12451 Gateway Blvd., Ft. Meyers, FL 33913, or find Sony Customer Service on the Web at: <http://www.sony.com/pcsupport>.

The number below is for FCC-related matters only.

Declaration of Conformity

Trade Name: SONY
Model No.: PCG-5211/PCG-5212/
PCG-5201/PCG-5202

Responsible Party: Sony Electronics Inc.
Address: 1 Sony Drive
Park Ridge, NJ 07656
Telephone: 201-930-6972

This device complies with Part 15 of the FCC rules. Operation is subject to the following two conditions:
(1) This device may not cause harmful interference, and
(2) this device must accept any interference received, including interference that may cause undesired operation.

This equipment has been tested and found to comply with the limits for a Class B digital device, pursuant to Part 15 of the Rules. These limits are designed to provide reasonable protection against harmful interference in a residential installation. This equipment generates, uses, and can radiate radio frequency energy and, if not installed and used in accordance with the instructions, may cause harmful interference to radio communications. However, there is no guarantee that interference will not occur in a particular installation. If this equipment does cause harmful interference to radio or television reception, which can be determined by turning the equipment off and on, the user is encouraged to try to correct the interference by one or more of the following measures:

- Reorient or relocate the receiving antenna.
- Increase the separation between the equipment and the receiver.
- Connect the equipment into an outlet on a circuit different from that to which the receiver is connected.
- Consult the dealer or an experienced radio/TV technician for help.

You are cautioned that any changes or modifications not expressly approved in this manual could void your authority to operate this equipment.

Only peripherals (computer input/output devices, terminals, printers, etc.) that comply with FCC Class B limits may be attached to this computer product.

Operation with noncompliant peripherals is likely to result in interference to radio and television reception.

All cables used to connect peripherals must be shielded and grounded. Operation with cables, connected to peripherals, that are not shielded and grounded, may result in interference to radio and television reception.

FCC Part 68

This equipment complies with Part 68 of the FCC rules. On the bottom of this equipment is a label that contains, among other information, the FCC Ringer Equivalence Number (REN) for this equipment. If requested, this information must be provided to the telephone company.

This modem uses the USOC RJ-11 telephone jack.

The REN is used to determine the quantity of devices which may be connected to the telephone line. Excessive RENs on the telephone line may result in the devices not ringing in response to an incoming call. In most, but not all areas, the sum of the RENs should not exceed five (5.0). To be certain of the number of devices that may be

connected to the line, as determined by the total RENs, contact the telephone company to determine the maximum REN for the calling area.

If the terminal equipment causes harm to the telephone network, the telephone company will notify you in advance that temporary discontinuance of service may be required. But if advance notice is not practical, the telephone company will notify the customer as soon as possible. Also, you will be advised of your right to file a complaint with the FCC if you believe it is necessary.

The telephone company may make changes in its facilities, equipment, operations or procedures that could affect the operations of the equipment. If this happens, the telephone company will provide advance notice in order for you to make the necessary modifications in order to maintain uninterrupted service.

If trouble is experienced with this equipment, you can reach the Sony Customer Information Service Center at 1-888-4SONYPC; or write to the Sony Customer Information Service Center at 12451 Gateway Blvd., FL 33913, or find Sony Customer Service on the web at <http://www.sony.com/pcsupport>.

Repair of this equipment should be made only by a Sony Service Center or Sony authorized agent. For the Sony Service Center nearest you, call 1-888-4SONYPC (1-888-476-6972).

This equipment cannot be used on public coin service provided by the telephone company. Connection to Party Line Service is subject to state and possible provincial tariffs. (Contact the state or provincial utility service commission, public service commission, or corporation commission for information.)

Telephone Consumer Protection Act of 1991 (United States)

The Telephone Consumer Protection Act of 1991 makes it unlawful for any person to use a computer or other electronic device to send any message via a telephone facsimile machine unless such message clearly contains, in a margin at the top or bottom of each transmitted page or on the first page of the transmission, the date and time it is sent and an identification of the business, other entity, or individual sending the message, and the telephone number of the sending machine or such business, other entity, or individual.

In order to program this information into your facsimile machine, see your fax software documentation.

Telephone Consumer Guidelines (Canada)

Please refer to your telephone directory under 'Privacy Issues' and/or 'Terms of Service.' For more detailed information, please contact:

CRTC

Terrasses de la Chaudière, Tour centrale
1 promenade du Portage, 5 étage Hull PQ
K1A 0N2.

This Class B digital apparatus complies with Canadian ICES-003.

Cet appareil numérique de la classe B est conforme à la norme NMB-003 du Canada.

DISPOSAL OF LITHIUM ION BATTERY

You can return your unwanted lithium ion batteries to your nearest Sony Service Center or Factory Service Center.



In some areas the disposal of lithium ion batteries in household or business trash may be prohibited.

For the Sony Service Center nearest you, call 1-888-476-6972 in the United States or 1-800-961-7669 in Canada.

! Do not handle damaged or leaking lithium ion batteries.

! Ne pas manipuler les batteries au lithium-ion qui fuient ou sont endommagées.

! Danger of explosion if battery is incorrectly replaced. Replace only with the same or equivalent type recommended by the manufacturer. Discard used batteries according to the manufacturer's instructions.

! Une batterie non conforme présente un danger d'explosion. La remplacer seulement par une batterie identique ou de type équivalent recommandé par le fabricant. Évacuer les batteries usées selon les directives du fabricant.

! The battery pack used in this device may present a fire or chemical burn hazard if mistreated. Do not disassemble, heat above 212°F (100°C) or incinerate. Dispose of used battery promptly. Keep away from children.

! La manutention incorrecte du module de batterie de cet appareil présente un risque d'incendie ou de brûlures chimiques. Ne pas démonter, incinérer ou exposer à une température de plus de 100°C. Évacuer promptement la batterie usée. Garder hors de portée des enfants.

INDUSTRY CANADA NOTICE

NOTICE: The Industry Canada label identifies certified equipment. This certification means that the equipment meets certain telecommunications network protective, operational and safety requirements as prescribed in the appropriate Terminal Equipment Technical Requirements document(s). The Department does not guarantee the equipment will operate to the user's satisfaction.

Before installing this equipment, users should ensure that it is permissible to be connected to the facilities of the local telecommunications company. The equipment must also be installed using an acceptable method of connection.

The customer should be aware that compliance with the above conditions may not prevent degradation of service in some situations.

Repairs to certified equipment should be coordinated by a representative designated by the supplier. Equipment malfunctions or any repairs or alterations made by the user to this equipment may give the

telecommunications company cause to request that the user disconnect the equipment.

Users should ensure for their own protection that the electrical ground connections of the power utility, telephone lines and internal metallic water pipe system, if present, are connected together. This precaution may be particularly important in rural areas.

CAUTION: Users should not attempt to make such connections themselves, but should contact the appropriate electrical inspection authority, or electrician, as appropriate.

NOTICE: The Ringer Equivalence Number (REN) assigned to each terminal device provides an indication of the maximum number of terminals allowed to be connected to a telephone interface. The termination on an interface may consist of any combination of devices subject only to the requirement that the sum of the Ringer Equivalence Numbers of all the devices does not exceed 5. The Ringer Equivalence Number for this equipment is 1.3.

AVIS DE L'INDUSTRIE CANADA

AVIS: L'étiquette d'Industrie Canada identifie le matériel homologué.

Cette étiquette certifie que le matériel est conforme aux normes de protection, d'exploitation et de sécurité des réseaux de télécommunications, comme le prescrivent les documents concernant les exigences techniques relatives au matériel terminal. Le Ministère n'assure toutefois pas que le matériel fonctionnera à la satisfaction de l'utilisateur.

Avant d'installer ce matériel, l'utilisateur doit s'assurer qu'il est permis de le raccorder aux installations de l'entreprise locale de télécommunication. Le matériel doit également être installé en suivant une méthode acceptée de raccordement.

L'abonné ne doit pas oublier qu'il est possible que la conformité aux conditions énoncées ci-dessus n'empêche pas la dégradation du service dans certaines situations.

Les réparations de matériel homologué doivent être coordonnées par un représentant désigné par le fournisseur. L'entreprise de télécommunications peut demander à l'utilisateur de débrancher un appareil à la suite de réparations ou de modifications effectuées par l'utilisateur ou à cause de mauvais fonctionnement.

Pour sa propre protection, l'utilisateur doit s'assurer que tous les fils de mise à la terre de la source d'énergie électrique, des lignes téléphoniques et des canalisations d'eau métalliques, s'il y en a, sont raccordés ensemble. Cette précaution est particulièrement importante dans les régions rurales.

Avertissement: L'utilisateur ne doit pas tenter de faire ces raccordements lui-même; il doit avoir recours à un service d'inspection des installations électriques, ou à un électricien, selon le cas.

AVIS: L'indice d'équivalence de la sonnerie (IES) assigné à chaque dispositif terminal indique le nombre maximal de terminaux qui peuvent être raccordés à une interface.

La terminaison d'une interface téléphonique peut consister en une combinaison de quelques dispositifs, à la seule condition que la somme d'indices d'équivalence de la sonnerie de tous les dispositifs n'excède pas 5.

L'indice d'équivalence de la sonnerie de ce matériel est de 1.3.

| Contents

<i>Welcome</i>	1
Features	1
Unpacking Your Notebook	2
Manuals	2
Software CDs	3
Recovery CDs	3
Other	3
Ergonomic Considerations.....	4
Notes on Setup	5
Handling Your Notebook.....	6
<i>Setting Up Your VAIO® Notebook</i>	7
Locating Controls and Connectors.....	7
Front.....	7
Back	8
Left	8
Right.....	9
Bottom	10
Connecting a Power Source	11
Using the AC Adapter.....	11
Notes on the AC Adapter	11
Using Battery Power.....	12
Additional Notes On Batteries.....	15
Starting Your Computer	16
Shutting Down Your Computer	17
Handling the LCD Screen.....	18

Using the Keyboard	19
Combinations and Functions with the Windows Key	21
Indicators.....	22
Combinations and Functions with the Fn Key	23
Using Memory Stick® Media	24
i.LINK® Interface	27
Using the Touchpad.....	28
Using Smart Pad.....	29
Using the Floppy Disk Drive.....	30
Using PC Cards	32
Cleaning Your Notebook	35
VAIO Action Setup	36
The Jog Dial™ Control	36
Using the Jog Dial™ Control.....	37
Launcher Mode	37
Guide Mode	38
Using the Jog Dial Control with Sony Software.....	38
Using the Jog Dial Control with Other Software	38
Using Smart Connect	40
Using Power Saving Modes.....	41
Normal Mode	41
System Idle Mode	41
System Suspend Mode.....	42
System Hibernation Mode.....	42
<i>Connecting Peripheral Devices</i>	<i>43</i>
Connecting a Phone Line	44
Connecting to the Local Area Network (LAN).....	46
Connecting the i.LINK® Port Replicator	47
Connecting a Printer.....	49
Connecting an External Display	50
Connecting the CD/CDRW/DVD Drive	52
Connecting an i.LINK® device	55
Connecting a Universal Serial Bus (USB) Device	57
Connecting an External Display.....	59

Adding Memory	61
To Install a Memory Module.....	62
To Remove a Memory Module	63
<i>About Your Software</i>	<i>65</i>
MovieShaker™	65
Importing Images and Sound Clips	65
Create a Movie using Shaker.....	66
Editing Clips and Scenes.....	67
Saving a Movie	68
PictureGear™	69
Managing Your Pictures	69
Creating a Photo Album	69
Using Panorama Maker	70
Making Still Images and Panoramic from MPEG	70
Getting Help	71
<i>Troubleshooting</i>	<i>72</i>
Using the System and Application Recovery CDs.....	78
Using the System Recovery CD(s).....	78
Using the Application Recovery CD(s).....	80
Hard Drive Partition.....	81
Specifications	82
 <i>Index</i>	<i>85</i>

Welcome

Congratulations on your purchase of the Sony VAIO® Z505 SuperSlim Pro™ notebook. Sony has combined leading-edge technology in audio, video computing and communications to provide you with state-of-the-art personal computing.

Features



For a complete description of the specifications of your VAIO Z505 SuperSlim Pro Notebook, see page 82

- ❑ **Exceptional performance:** Your notebook includes a fast Mobile Intel® Pentium® III processor and a V.90-compatible modem.*
- ❑ **Portability:** The high-capacity lithium-ion battery provides hours of use without AC power.
- ❑ **Sony audio and video quality:** High-quality MPEG1 video, which supports full-screen display (12.1-inch Active Matrix LCD screen) and enables you to take advantage of today's advanced multimedia applications, games, and entertainment software.
- ❑ **Windows® Operating System:** Your system includes Windows® 98 Second Edition or Windows® 2000.
- ❑ **Communications:** Access popular online services, send e-mail, browse the Internet, and use fax features.

* Actual upload and download speeds may vary due to line conditions, ISP support, and government regulations.

Unpacking Your Notebook

Remove the following hardware items from the box:

Main unit

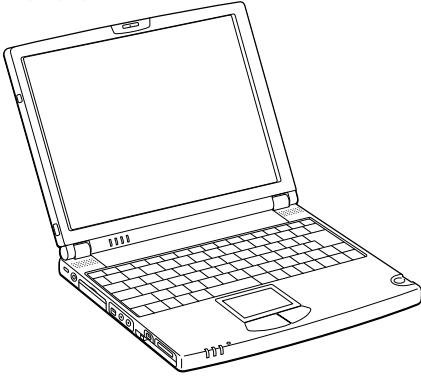

i.LINK port replicator

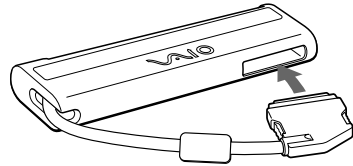

Mini-USB cable



Rechargeable battery pack

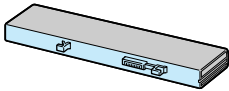

AC adapter

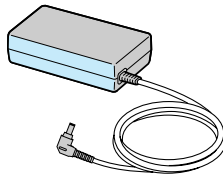

Power cord

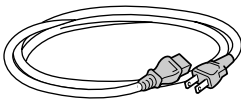

USB floppy disk drive



Manuals

- The VAIO® Z505 SuperSlim Pro™ Notebook User Guide (this manual) contains information on how to get the most from your computer, find help, and solve common problems. It also includes product specifications.
- Sony Read Me First contains Troubleshooting and Errors, the most up-to-date information on using your computer, and software support information.
- The Microsoft® Windows® 98 Second Edition Getting Started manual or Microsoft® Windows® 2000 Professional Getting Started Manual explains how to use the basic features of the Windows operating system.

Software CDs

Microsoft® Word 2000

Recovery CDs

- ❑ System Recovery CD(s)
- ❑ Application Recovery CD(s)



To use these recovery CDs, you need to purchase either the PCG-CD51 CD-ROM drive, the PCGA-CDRW51 CD-RW drive, or the PCGA-DVD51 DVD drive.

Other

- ❑ Setting up your VAIO® Z505 SuperSlim Pro™ Notebook (poster)
- ❑ Packet containing special product offers

Ergonomic Considerations

You will be using your notebook computer as a portable device in a variety of environments. Whenever possible, you should attempt to apply the following ergonomic considerations to both stationary and portable environments.

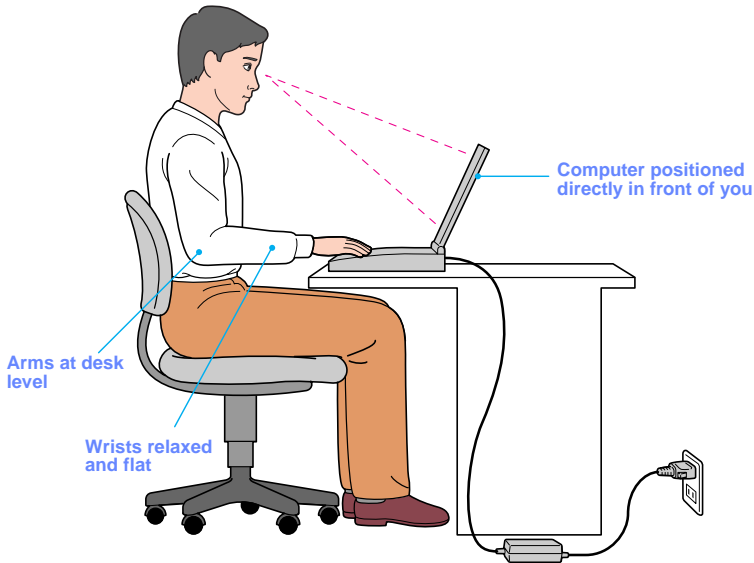

- ❑ **Position of your computer** – Place the computer directly in front of you as you work. Keep your forearms horizontal, with your wrists in a neutral, comfortable position while using the keyboard, touchpad, or external mouse. Let your upper arms hang naturally at your sides. Take breaks during sessions with your computer. Excessive use of the computer may strain muscles or tendons.
- ❑ **Furniture and posture** – Sit in a chair with good back support and armrests. Adjust the level of the chair so your feet are flat on the floor. A footrest may make you more comfortable. Sit in a relaxed, upright posture and avoid slouching forward or leaning far backward.
- ❑ **Viewing angle of the computer's display** – Use the display's tilting feature to find the best position. You can reduce eye strain and muscle fatigue by adjusting the tilt of the display to the proper position. Adjust the brightness setting of the display also.

- ❑ **Lighting** – Choose a location where windows and lights do not create glare and reflection on the display. Use indirect lighting to avoid bright spots on the display. You can also purchase accessories for your display that help reduce glare. Proper lighting adds to your comfort and work effectiveness.
- ❑ **Placement of an external display** – When using an external display, set the display at a comfortable viewing distance. Make sure the display screen is at eye level or slightly lower when you are sitting in front of the monitor.

Notes on Setup

- ❑ Do not place your computer in a location subject to:
 - Heat sources, such as radiators or air ducts
 - Direct sunlight
 - Excessive dust
 - Moisture or rain
 - Mechanical vibration or shock
 - Strong magnets or speakers that are not magnetically shielded
 - Ambient temperature of more than 95° F (35° C) or less than 18° F (10° C)
 - High humidity
- ❑ Do not place electronic equipment near your computer. The computer's electromagnetic field may cause a malfunction.
- ❑ Provide adequate air circulation to prevent internal heat buildup. Do not place your computer on porous surfaces such as rugs or blankets, or near materials such as curtains or draperies that may block its ventilation slots. Leave a space of at least 8 inches (20 cm) behind the back panel of the computer.
- ❑ If the computer is brought directly from a cold location to a warm one, moisture may condense inside your computer. In this case, allow at least an hour before turning on your computer. If any problems occur, unplug your computer, and contact your Sony Service Center.
- ❑ The computer uses high-frequency radio signals and may cause interference to radio or TV reception. Should this occur, relocate the computer a suitable distance away from the set.
- ❑ Use only specified peripheral equipment and interface cables; otherwise, problems may result.
- ❑ Do not use cut or damaged connection cables.

- ❑ Your computer will not work with party lines, cannot be connected to a coin-operated telephone, and may not work with multiple phone lines or a private branch exchange (PBX).
- ❑ If the telephone company makes a service call to your home or office and determines that your computer is responsible for a problem, the telephone company may bill you for the service call. Also, if you do not disconnect your computer when it is adversely affecting the telephone line, the telephone company has the right to disconnect your service until you correct the problem.

Handling Your Notebook

- ❑ Clean the cabinet with a soft, dry cloth or a soft cloth lightly moistened with a mild detergent solution. Do not use any type of abrasive pad, scouring powder, or solvent such as alcohol or benzine, as these may damage the finish of your computer.
- ❑ Should any solid object or liquid fall into the computer, shut down your computer and then unplug it. You may want to have the computer checked by qualified personnel before operating it any further.
- ❑ Do not drop the computer or place heavy objects on top of the computer.

Setting Up Your VAIO® Notebook

Locating Controls and Connectors

Front

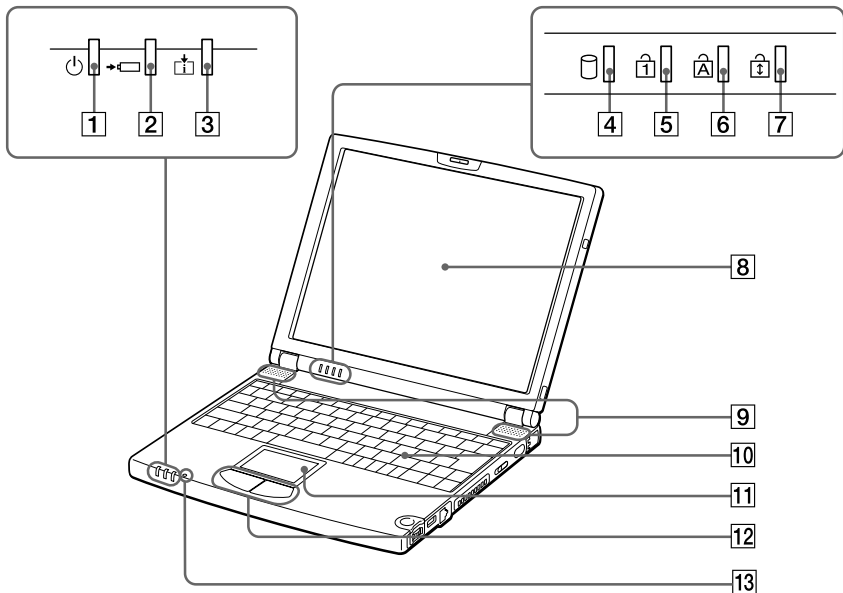

1 Power indicator (pages 16, 22)

2 Battery indicator (page 22)

3 Information indicator (pages 13, 22)

4 Hard disk drive indicator (page 22)

5 Num Lock indicator (page 22)

6 Caps Lock indicator (page 22)

7 Scroll Lock indicator (page 22)

8 LCD screen (pages 23)

9 Speakers (pages 23, 76)

10 Keyboard (page 19)

11 Touchpad (page 28)

12 Left/right button (page 28)

13 Microphone

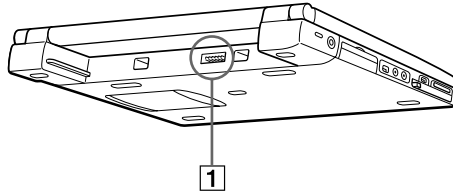

Back

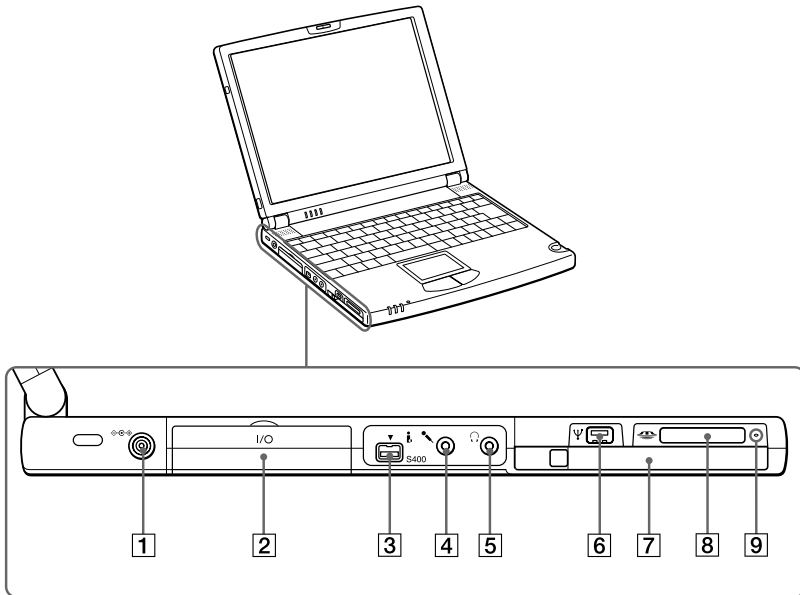

- 1 Battery connector (page 12)

Left



- | | | | |
|---|---|---|--|
| 1 | ⚡ DC In connector (page 11) | 6 | mini USB connector |
| 2 | I/O i.LINK® port replicator connector (page 47) | 7 | PC Card slot (page 32) |
| 3 | S400 i.LINK (IEEE1394) (page 55) | 8 |  Memory Stick® slot (page 24) |
| 4 |  Microphone connector | 9 | Memory Stick® indicator light |
| 5 |  Headphone connector (page 51) | | |

Right

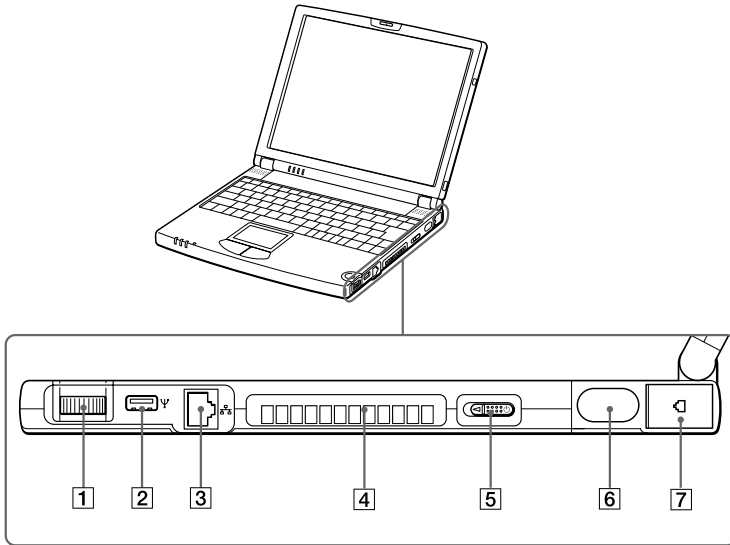

- | | | | |
|----------|--------------------------------------|----------|---------------------------|
| 1 | Jog Dial control (page 36) | 5 | Power switch |
| 2 | USB connector (page 57) | 6 | Infrared port |
| 3 | Ethernet network connector (page 46) | 7 | Phone line jack (page 44) |
| 4 | Air vent | | |

! **Warning:** Only connect 10BASE-T and 100BASE-TX cables to the  (Ethernet network) connector. Do not connect any other type of network cable or any telephone line. Connecting cables other than those listed above may result in an electric current overload and could cause a malfunction, excessive heat, or fire in the connector. To connect the unit to the network, contact your network administrator.

Bottom

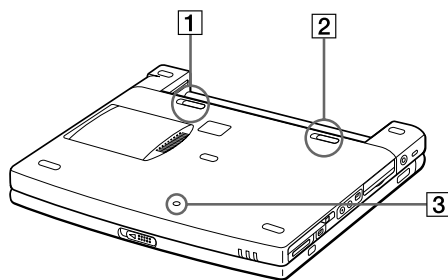

1 Battery release lever (page 14)

3 Reset switch

2 Battery lock lever (pages 12, 14)

Connecting a Power Source

You can use either AC power or a rechargeable battery pack as a power source.

Using the AC Adapter

- 1 Plug the cable attached to the AC adapter (PCGA-ACX1) into the DC In connector on the computer.
- 2 Plug one end of the power cord into the AC adapter.
- 3 Plug the other end of the power cord into an AC outlet.

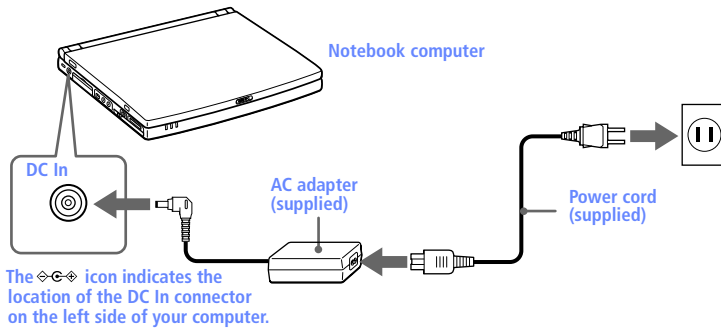

Notes on the AC Adapter

- ❑ Your computer operates on 100V-240V AC 50/60 Hz.
- ❑ Do not share the AC outlet with other power-consuming equipment, such as a copy machine or shredder.
- ❑ You can purchase a power strip with a surge protector. This device prevents damage to your computer caused by sudden power surges such as those that may occur during an electrical storm.
- ❑ Do not place heavy objects on the power cord.
- ❑ To disconnect the cord, pull it out by the plug. Never pull the cord itself.
- ❑ Unplug your computer from the wall outlet if you will not be using the computer for a long time.
- ❑ When the AC adapter is not used, unplug it from the AC outlet.
- ❑ Use only the AC adapter supplied. Do not use any other AC adapter.

Using Battery Power

You can use a battery pack as a source of power. The PCGA-BPZ51 battery pack that comes with your computer is not fully charged at the time of purchase. Follow the steps below to insert and charge the battery pack.

 You can also purchase the triple-capacity PCGA-BPZ52 battery pack as a separate option. See "Using Power Saving Modes" on page 41 for power management information.

To insert the battery pack

You can insert or remove the battery pack without turning off the computer when your computer is connected to the AC adapter. Before inserting or removing a battery pack, close the cover.

- 1 Move the lock lever on the bottom of the computer to the **UNLOCK** position.

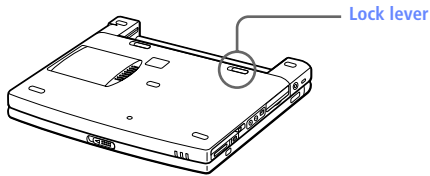

- 2 Align the grooves and tabs on the battery with the tabs and notches on the back of the computer, and then slide the battery toward the computer until it clicks into place.

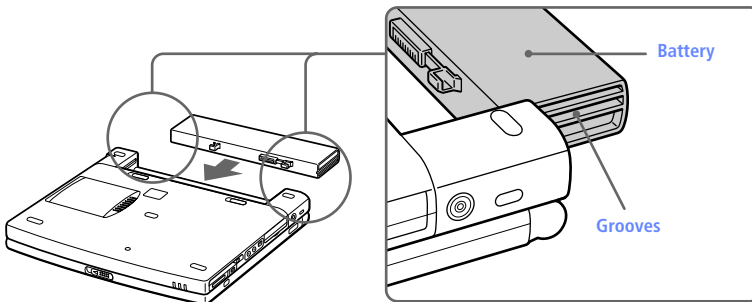

- 3 Slide the lock lever into the **LOCK** position to secure the battery on the computer.

To charge the battery pack

- 1 Connect the AC adapter to the computer.
- 2 Insert the battery pack.

The computer automatically charges the battery (the battery indicator light flashes in a double-blink pattern as the battery charges). When the battery is 85% full, the battery indicator light turns off. This process takes approximately one and one half hours. To charge the battery completely, continue charging for an additional hour.

The  battery indicator light on the front of the computer indicates the status of the battery pack.

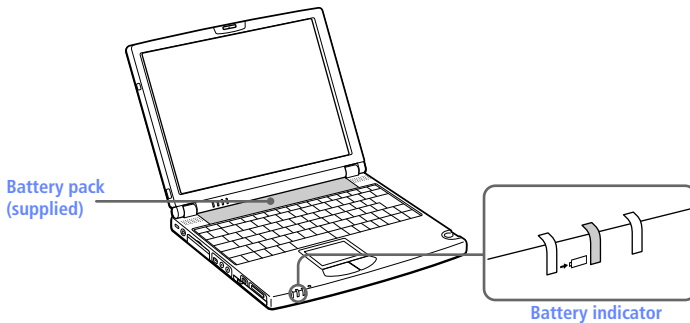

Battery Indicator Light Status

Meaning

On	The computer is using battery power.
Single blink	The battery is running out of power.
Double blink	The battery is charging.
Off	The computer is using AC power.

 Both the battery and power indicators blink when the battery is running out of power.

Keep the battery pack in the computer while it is directly connected to AC power. The battery pack continues to charge while you are using the computer.

If your battery level falls to less than 10%, you should either attach the AC adapter to recharge the battery or shut down your computer and insert a fully-charged battery.

You can extend battery life by changing the power management modes in the PowerPanel utility. See "Using Power Saving Modes" on page 41.

The battery pack supplied with your computer is a lithium ion battery and can be recharged at any time. Charging a partially discharged battery does not affect battery life.

The battery indicator light is on while you use the battery pack as a power source. When battery life is nearly depleted, the battery indicator starts flashing.

For some software applications and some peripheral devices, your computer may not enter System Hibernation mode when the battery life is low. To avoid loss of data when using battery power, you should save your data frequently and manually activate a power management mode, such as System Suspend or System Hibernation.

To remove the battery pack

You can insert or remove the battery pack without turning off the computer when your computer is connected to the AC adapter. Before inserting or removing a battery pack, close the cover.

- 1 Turn off the computer and close the cover.
- 2 Slide the lock lever to the **UNLOCK** position.
- 3 Slide the release lever to the **UNLOCK** position and slide the battery away from the computer.

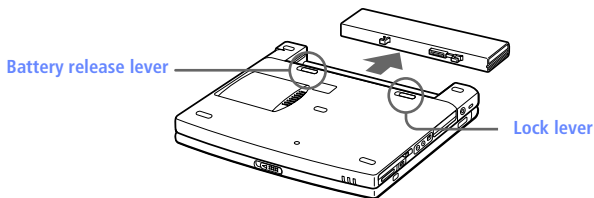

You may lose data if you remove the battery pack while the computer is on and not connected to the AC adapter or if you remove the battery while the computer is in System Suspend mode.

Additional Notes On Batteries

- ❑ Never leave the battery pack in temperatures above 140° F (60° C), such as under direct sunlight or in a car parked in the sun.
- ❑ Battery life is shorter in a cold environment. This is due to decreased battery efficiency at low temperatures.
- ❑ Charge the batteries at temperatures between 50° F and 80° F (10° C to 30° C). Lower temperatures require a longer charging time.
- ❑ While the battery is in use or being discharged, the battery pack heats up. This is normal and is not cause for concern.
- ❑ Keep the battery pack away from all sources of heat.
- ❑ Keep the battery pack dry.
- ❑ Do not open or try to disassemble the battery pack.
- ❑ Do not expose the battery pack to any mechanical shock.
- ❑ If you are not using the computer for an extended period of time, remove the battery pack from the computer to prevent damage to the battery.
- ❑ If, after fully charging the battery pack, the battery power is still low, the battery pack may be reaching the end of its life and should be replaced.
- ❑ You do not need to discharge the battery before recharging.
- ❑ If you have not used the battery pack for a considerable amount of time, recharge the battery.

Starting Your Computer

- 1 Slide the LCD lock lever in the direction of the arrow, and lift the cover.

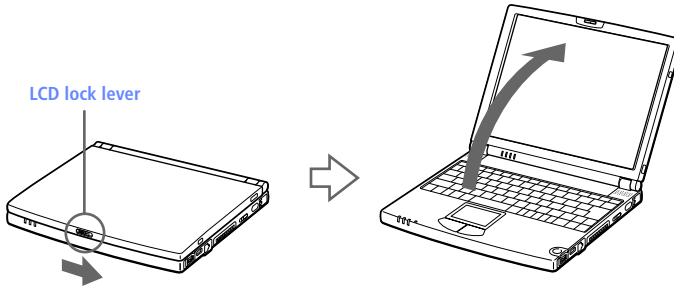

- 2 Slide the power switch on the right side toward the front of the computer until the green power indicator light turns on.

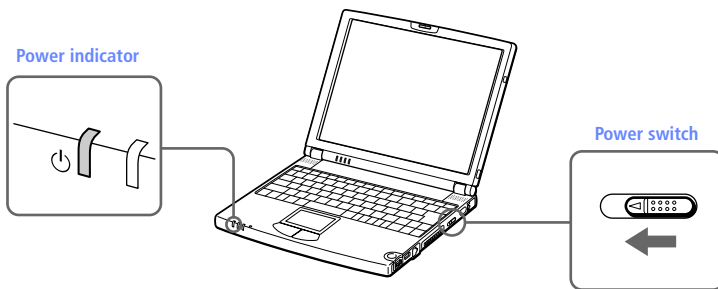

If you hold the power switch in the On position for more than four seconds, the computer turns off.

- 3 If necessary, adjust the brightness controls for the LCD display. To decrease the brightness, press Fn+F5 and then the down or left arrow key. To increase the brightness, press Fn+F5 and then the up or right arrow key.

Shutting Down Your Computer

! To avoid potential loss of data, follow these steps to shut down your computer.

- 1 Click the Start button on the Windows® taskbar.
- 2 Click Shut Down at the bottom of the Start menu to display the Shut Down Windows dialog box.
- 3 Select Shut down.
- 4 Click OK.



Respond to any prompts warning you to save documents.

- 5 Wait for your computer to turn off automatically. The power indicator turns off.
- 6 Turn off any peripherals connected to your computer.



If you are unable to shut down your computer using the steps described above, press the Ctrl+Alt+Delete keys at the same time to restart the computer. If you are unable to restart the computer in this way, you can slide the power switch forward and hold for four seconds. This operation may result in data loss.

During a period of inactivity, you can conserve battery life by using System Suspend mode. See “Controlling Power Management” in the online manual Customizing Your VAIO® Z505 SuperSlim Pro™ Notebook. To access the online documents, click the Start button, point to Help Center, and click VAIO User Manuals.

Handling the LCD Screen



- ❑ Do not leave the LCD facing the sun as it can damage the LCD. Be careful when using the computer near a window.
- ❑ Do not scratch the LCD or exert pressure on it. This could cause malfunction.
- ❑ Using the computer in low temperature conditions may produce a residual image on the screen. This is not a malfunction. When the computer returns to normal temperature, the screen returns to normal.
- ❑ The screen becomes warm during operation. This is normal and does not indicate a malfunction.
- ❑ The LCD is manufactured using high-precision technology. You may, however, see tiny black points and/or bright points (red, blue, or green) that continuously appear on the LCD. This is a normal result of the manufacturing process and does not indicate a malfunction.

Using the Keyboard

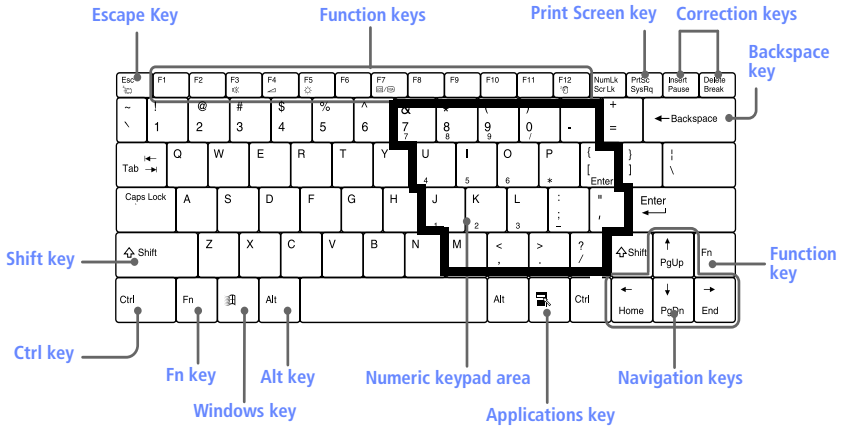
Your keyboard is very similar to a typewriter's, but the keyboard has additional keys that perform specific computer-related tasks.









Key	Description
Numeric keypad area	Contains the keys found on a typical calculator. Use the numeric keypad area to type numbers or to perform mathematical calculations such as addition and subtraction. Note that you must press the Num Lock key to activate the numeric keypad. (When you do so, the Num Lock light will be on.)
Navigation keys	Several keys are devoted to moving the cursor on the screen (the four arrow keys which also function as the Home, End, Page Up, and Page Down keys).
Correction keys	The Insert, Back Space, and Delete keys enable you to make corrections in your documents.
Function keys	The 12 function keys along the top of the keyboard are used to perform designated tasks. For example, in many applications, F1 is the Help key. The task associated with each function key may vary from one application to the next.
Escape key	The Esc (Escape) key is used to cancel commands.

<i>Key</i>	<i>Description</i>
Print Screen key	The Print Screen key takes an electronic snapshot of the screen and places it in the Windows Clipboard. You can then paste the screen shot into a document and print it.
Operator keys	Several keys are always used with at least one other key: Ctrl, Alt, and Shift. When held down with another key, the Ctrl (Control) and Alt (Alternate) keys offer another way to give commands. For example, in many applications, instead of choosing the Save command from a menu, you can hold down Ctrl and press S (referred to as Ctrl+S). The Shift key operates the same way as on a typewriter; it is used to produce capital letters or special symbols such as @ and \$.
Windows key 	The key with the Windows logo displays the Windows Start menu; it is the equivalent of clicking the Start button on the task bar. See “Combinations and Functions with the Windows Key” on page 21.
Fn key	The Fn key is used in combination with other keys to issue commands. The Fn keys at the left and right sides both work the same. See “Combinations and Functions with the Fn Key” on page 23.
Applications key 	The Applications key displays a shortcut menu of context-sensitive choices; pressing this key is the equivalent of clicking the right mouse button.

Combinations and Functions with the Windows Key

<i>Combinations</i>	<i>Functions</i>
⊞ + F1	Displays Windows Help.
⊞ + Tab	Switches the selected button on the taskbar.
⊞ + E	Displays Windows Explorer.
⊞ + F	Displays the Windows Find: All Files window to find a file or folder. This is the equivalent of selecting Find and then Files or Folders from the Start menu.
⊞ + Ctrl + F	Displays the Windows Find: Computer window where you can locate other computers. This is the equivalent of selecting Find and then Computer from the Start menu.
⊞ + M	Minimizes all displayed windows.
Shift + ⊞ + M	Returns all minimized windows to their previous size.
⊞ + R	Displays the Run window. This is the equivalent of selecting Run from the Start menu.
Fn + ⊞ + Insert	Displays the Properties window. This is the equivalent of clicking the System icon in the Control Panel.

Indicators

<i>Indicators</i>	<i>Functions</i>	
Power 	Lights when the power to the computer is turned on. Flashes in System Suspend mode. Turns off when the computer is in System Hibernation mode or powered off.	
Battery 	Indicates the status of the battery attached at the rear of the computer.	
Information 	Depending on the VAIO Action Setup setting, the Information indicator lights when you have received new e-mail and/or retrieve e-mail.	
<i>Light</i>	<i>On</i>	<i>Off</i>
Hard disk 	Data is being read from or written to the hard drive. Do not enter System Suspend mode or turn off the computer when this indicator light is on.	The hard drive is not being accessed.
Num Lock 	The number keys in the numeric keypad are active.	The character keys in the keypad area are active.
Caps Lock 	The letters appear in uppercase as you type. The Shift key lowers the case of typed letters when Caps Lock is on.	Letters appear in lower case as you type (unless you hold down the Shift key).
Scroll Lock 	The screen scrolls differently. (Exactly how it scrolls depends on the specific application. It has no effect in many applications.)	Information moves across the display normally.

Combinations and Functions with the Fn Key

Combinations/ Feature

Functions

Fn+  (ESC)
System Suspend

Puts the system into System Suspend mode, a power management state. To return the system to the active state, press any key or press the power switch on your computer.

Fn+  (F3)
Speaker switch



Toggles the built-in speaker off and on.

Fn+  (F4)
Speaker volume

Adjusts the built-in speaker volume.
To increase volume, press Fn+F4, then **↑** or **→**.
To decrease volume, press Fn+F4, then **↓** or **←**.

Fn+  (F5)
Brightness control

Adjusts the brightness of the LCD.
To increase light intensity, press Fn+F5 and then **↑** or **→**.
To decrease light intensity, press Fn+F5 and then **↓** or **←**.

Fn+  /  (F7)
Switch to the external display

Toggles through the LCD, external display (connected to the  Monitor connector on the port replicator) and both LCD and external display.

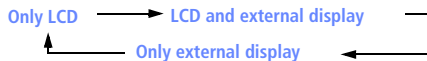

Fn+  (F12)
System Hibernation

Provides for the lowest level of power consumption. When you execute this command, the state of the system and state of the peripheral devices are written to the hard disk and the system power is turned off. To return the system to the original state, use the power switch to turn on power.

Fn+B
Mega-Bass switch

Toggles the mega-bass function off and on. This feature is available with headphone only.

Fn+S
System Idle

Puts the system into System Idle mode, a power management state. To return the system to the active state, press any key.



You can also carry out these functions using the Jog Dial control.

Some functions are not available until Windows launches.

Using **Memory Stick®** Media

This new compact, portable, and versatile recording medium has a data capacity exceeding that of a floppy disk. The media is specially designed for exchanging and sharing digital data with compatible products. Because it is removable, the media can be used for external data storage.

 The VAIO Z505 SuperSlim notebooks are not compatible with MagicGate™ **Memory Stick** media.

You can enjoy video clips that you have recorded with **Memory Stick**-compatible video camera recorders.

The media slot can accommodate one media at a time.

To copy images from a digital video camera via **Memory Stick** media, see "Connecting an i.LINK® device" on page 55.

To copy images from a digital still camera via the **Memory Stick** media, see "To connect a digital still camera" in the online manual "Customizing Your VAIO® Z505 SuperSlim Pro™ Notebook."

To insert a **Memory Stick** media

Insert the media into the slot until the media is fixed into the connector.

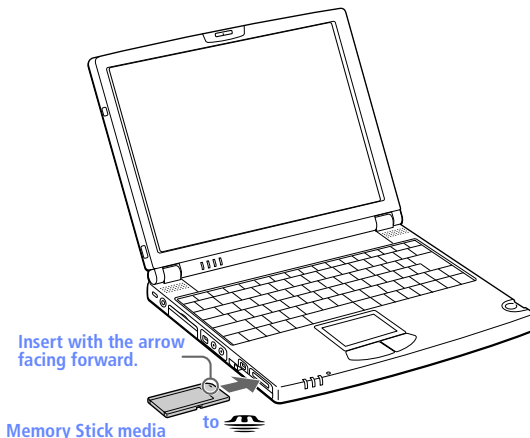

When the media is connected properly, you can see the contents by clicking the Removable Disk (S:) icon.



Do not insert the media in the wrong direction as this may damage the connector pins in the slot or the media itself.



Warning: When copying data between Memory Stick media with different memory capacity, use the drag and drop method to copy data. Do not use the Copy Disk function of Windows. The Copy Disk function will result in the loss of the installed memory.

To remove a **Memory Stick** media

Make sure the access light is off. Push the media in toward the computer. When the media comes out, pull it out. The **Memory Stick** window closes automatically when you remove the media.



When the media's erasure prevention switch is set to LOCK, data cannot be recorded or erased.

Before using **Memory Stick** media, you should back up important data.

Wait a minimum of 10 seconds after the media finishes reading or writing data before removing it. If the media is removed prematurely, a blue screen with an error message appears, prompting you to continue or exit. Re-insert the media into the slot and press Enter to continue. This allows the media to finish reading or writing data.

To avoid damaging data:

- Do not remove a media or turn off the power while the access light is on.
- Do not use the media in locations that are subject to static electricity or electrical noise.
- Do not touch the media connector with your finger or metallic objects.
- Do not attach labels other than the supplied label to a media.
- Do not bend, drop, or apply strong shock to the media.
- Do not disassemble or modify the media.
- Do not allow the media to get wet.
- Do not use or store the media in a location that is subject to:
 - Extremely high temperatures, such as in a car parked in the sun
 - Direct sunlight
 - High humidity or places with corrosive substances

To prolong the life of the media, use the supplied storage case. See the instructions that come with your media for more information on use.

To Create Self-Launching Slide Shows

To create a slide show that launches automatically when you insert a media, follow these steps to transfer images from your hard drive to a media.

- 1 Insert the media into the media slot.
- 2 Click the My Computer icon on the desktop.
- 3 Click the Removable Disk (S:) icon.
- 4 Create a new folder and name it “DCIM.”
- 5 Open the DCIM folder and create a new folder named “100MSDCF.”
- 6 Click the Start button, select VAIO, then click PictureGear™ to launch the PictureGear application.
- 7 Select the digital images you want to save in your slide show.
- 8 From the PictureGear File menu, select Format Conversion.
- 9 Select **Memory Stick** as the Output Format.
- 10 Use the Browse button to select the DCIM/100MSDCF folder on the Removable Disk (S:) drive.
- 11 Click OK to save the file.

You can also add MPEG1 video files to your Slide Show by following the steps below. Note that the order in which digital still photos (DSC0xxxx files) and video clips (MOV0xxxx files) appear in your Slide Show is determined by the number (xxxx) in the file name.

- 1 Insert the media into the card slot.
- 2 Double-click the My Computer icon on the desktop.
- 3 Double-click the Removable Disk S: icon.
- 4 Create a new folder and name it “MSSONY.”
- 5 Open the MSSONY folder and create a new folder named “MOML0001.”
- 6 Copy the MPEG file into the MOML0001 folder.
- 7 Rename the MPEG file MOV0xxxx.mpg, where xxxx is any four-digit number.

To set VAIO Action Setup to launch **Memory Stick** automatically, see *Customizing Your VAIO® Z505 SuperSlim Pro™ Notebook*.

i.LINK® Interface

Your computer comes equipped with an i.LINK S400 port. The port is a digital interface (IEEE 1394) for high-speed communication. By using your computer, a Sony Digital Handycam® Camcorder or other compatible camera that supports the i.LINK interface, the DVgate software preinstalled on your computer, and the i.LINK interface, you can easily create and edit your own home videos. For more information on connecting an i.LINK device, see “Connecting an i.LINK® device” on page 55 of this manual.

Using the Touchpad

The keyboard contains a cursor-pointing device called a touchpad. You can point to, select, drag, and scroll objects on the screen using the built-in touchpad.

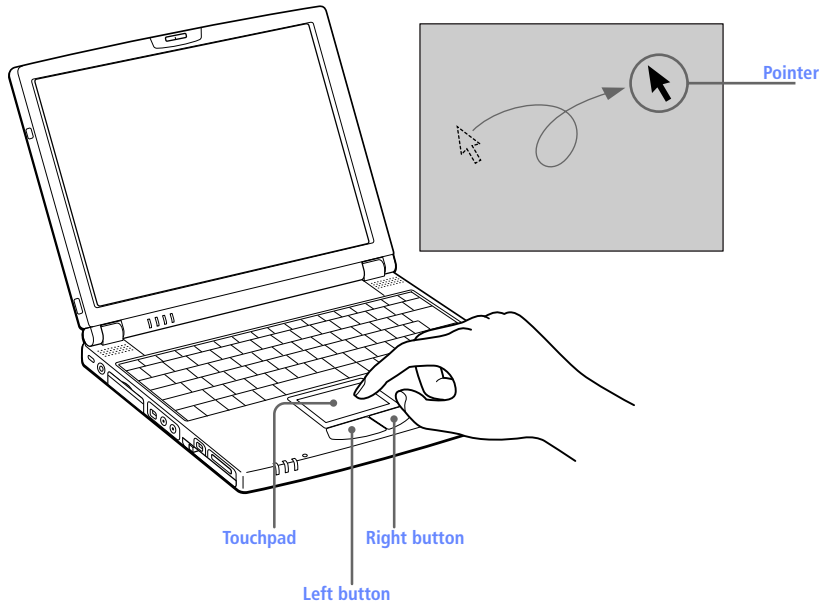

<i>Actions</i>	<i>Descriptions</i>
Point	Slide one finger on the touchpad to place the pointer on an item or object.
Click	Press the left button once.
Double-click	Press the left button twice.
Right-click	Press the right button once. In many applications, this action displays a shortcut menu of context-sensitive choices.
Drag	Slide one finger while pressing the left button.
Scroll	Move your finger along the right edge of the touchpad to scroll vertically. Move your finger along the bottom edge to scroll horizontally. (The scroll function is available only with applications that support a touchpad scroll feature.)



See Mouse Properties for information on touchpad features, such as clicking both buttons simultaneously, adjusting touchpad speed, and Easy Launcher functions. To access Mouse Properties, press the Start button, select Settings, and then select Control Panel. Double-click the Mouse icon in the Control Panel.

Using Smart Pad

Smart Pad is an application that lets you create memos by writing on the touchpad using your finger.

To use Smart Pad

- 1 Click the Start button on the Windows taskbar.
- 2 Point to Programs, point to Smart Utilities, and then click Smart Pad.
- 3 Press the F10 key.

Smart Pad enters tablet mode. In this mode the touchpad corresponds with the Smart Pad screen. This means that what you write on the touchpad appears on the screen in the corresponding location. For example, when you write letters on the left corner of the touchpad, the letters appear on the left corner of the screen.

- 4 To write, move your finger slowly on the touchpad.

As you write, the letters you wrote on the touchpad appear on the screen.



Click Help on the Smart Pad screen to display the Help file.

Using the Floppy Disk Drive

You can connect the floppy disk drive to the Ψ (USB) connector on your computer:

To connect the floppy disk drive



You do not need to shut down the computer before connecting or disconnecting the floppy disk drive.

Plug the USB cable from the floppy disk drive into the Ψ (USB) connector on the computer. The VAIO logo on the disk drive should be facing up.

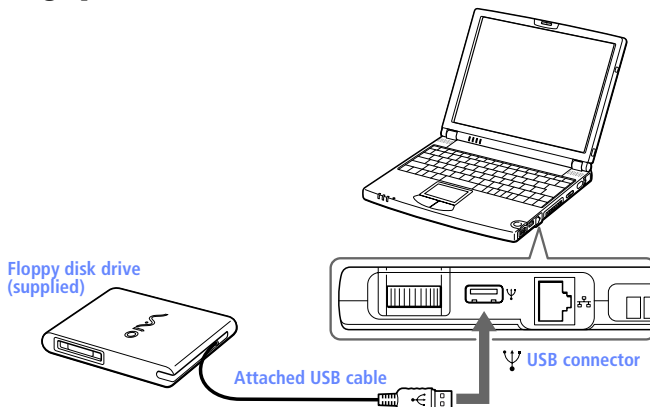

To use two USB devices at the same time, plug the second device into the Ψ connector on the left side of the computer, using the supplied conversion adapter.

To insert a diskette

- 1 Hold the diskette with the label side facing up.
- 2 Gently push the diskette into the drive until it clicks into place.

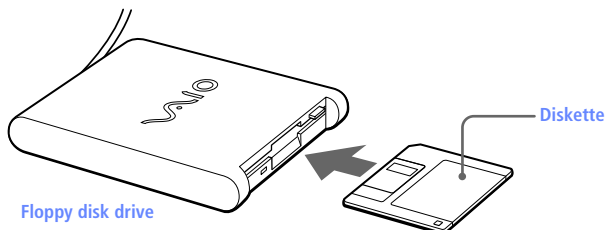

To remove a diskette

- ❑ When you finish using the diskette, wait until the LED indicator turns off and then press the Eject button to remove the diskette.

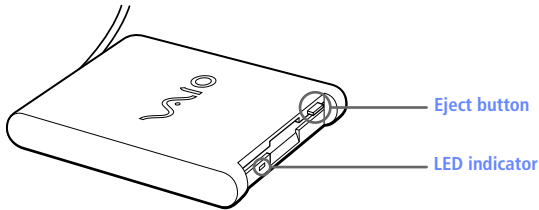

Handling Diskettes

- ❑ Do not open the shutter manually and touch the surface of the diskette.
- ❑ Keep diskettes away from magnets.
- ❑ Keep diskettes away from direct sunlight and other heat sources.

To remove the floppy disk drive

Wait until the LED indicator turns off, and then unplug the USB cable from the computer.

To carry the floppy disk drive

Fold the floppy disk cable into the compartment on the side of the floppy disk drive.

Using PC Cards

Your computer includes a PC card slot. PC cards allow you to connect portable external devices, such as a CD-ROM drive.

 The PC card slot can accommodate one Type I or Type II PC card. This slot is compatible with 16 bit card and Card Bus. ZV (Zoomed Video) port is not available.

Some PC cards may require that you disable idle devices when using the PC card. You can use Sony Notebook Setup to disable devices. See "Displaying the Sony Notebook Setup Screen" in the online manual Customizing Your VAIO® Z505 SuperSlim Pro™ Notebook for details.

Be sure to use the most recent software driver provided by the PC card manufacturer.

If an "!" mark appears on the Device Manager tab in the System Properties dialog box, remove the software driver and then reinstall it.

To insert a PC card

 You do not need to shut down the computer before inserting or removing a PC card.

- 1 Pull the PC card release button up away from the computer and push it in towards the computer.**

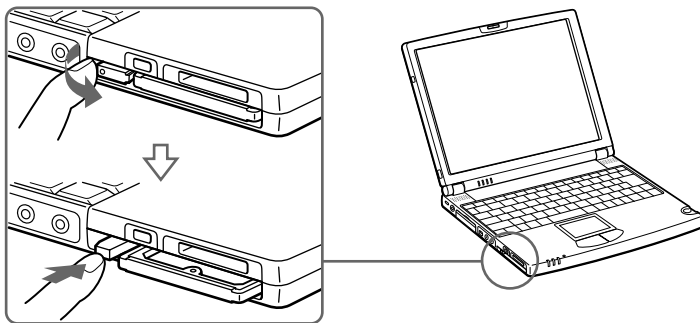

- 2 Remove the PC card slot protector.

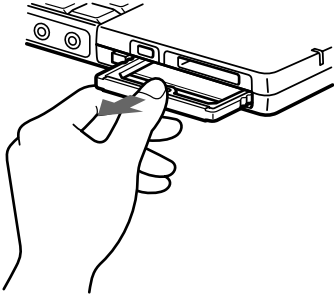

- 3 Insert the PC card into the PC card slot, front label facing up. Gently push the card into the slot until the card is fixed into the connector. The release button comes out.

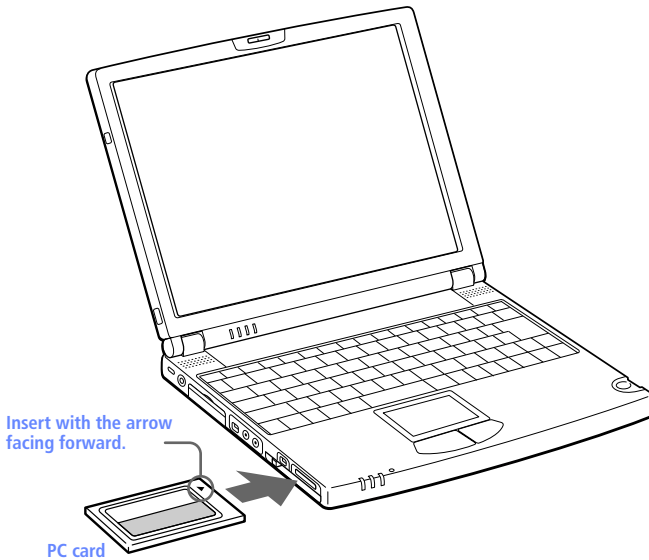

Do not force a card into the slot. It may damage the connector pins.

If you have difficulty inserting a card, check that you are inserting the card with the correct orientation.

See the manual that came with your PC card for more information on its use.

To remove a PC card

For some PC cards, if you alternate between normal power operation and the System Suspend or System Hibernation power management modes while the card is inserted, you may find that a device connected to your system is not recognized. Reboot your system to correct the problem.

- 1 Close any applications that use the PC card, otherwise data may be lost.
- 2 Click the PC card icon in the taskbar and close the card.
- 3 Pull the PC card release button up and press it in towards the computer.

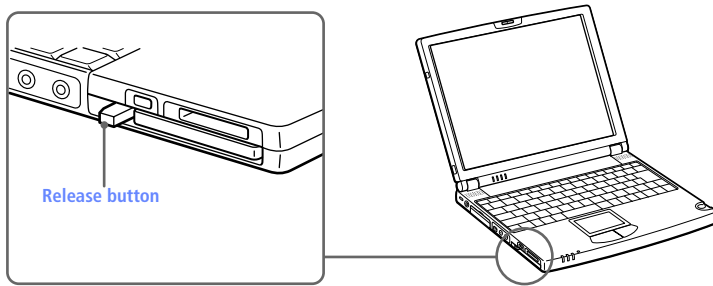



- 4 Gently grasp the card and pull it out.
- 5 Insert the PC card slot protector into the empty slot.

Cleaning Your Notebook

- ❑ Make sure to disconnect the power cord before cleaning the computer.
- ❑ Avoid rubbing the LCD screen as this can damage the screen. Use a soft, dry cloth to wipe the LCD screen.
- ❑ Clean the computer with a soft cloth lightly moistened with a mild detergent solution. Do not use any type of abrasive pad, scouring powder or solvent, such as alcohol or benzine.

VAIO Action Setup

VAIO Action Setup manages the settings for your computer's Jog Dial™ control, **Memory Stick®** media, and i.LINK® interface. An overview of some of the functions controlled by VAIO Action Setup is provided below. For more information on changing the settings using VAIO Action Setup, right-click the Jog Dial control icon  or , in the task tray and click Help Topics.

The Jog Dial™ Control

Your computer is equipped with a Jog Dial control on the right side of the unit. The Jog Dial control enables you to open an application, folder, or document from a predefined list by rotating and pressing the Jog Dial control. In addition, when you press the Jog Dial control, you can turn on your computer automatically and start the selected application or document.

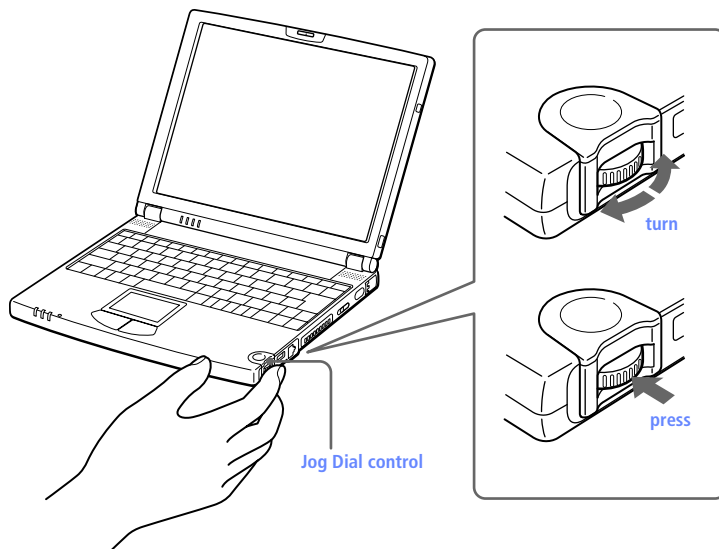

The Jog Dial control window always appears in the display. It is either in the launcher mode or in the guide mode.

Using the Jog Dial™ Control

This section explains how to use the Jog Dial control. For information on how to change the Jog Dial control's settings, right-click the Jog Dial control icon in the task tray and click Help Topics.

Launcher Mode

The Jog Dial control window is in launcher mode until a software application is launched or the Jog Dial control window becomes active. When an arrow is displayed next to an item in the Jog Dial control window, you can display a submenu of that item by selecting it and pressing the Jog Dial control button.

Using Launcher Mode

To use the Jog Dial control, click the Jog Dial control window or the Jog Dial control icon in the task tray. Alternatively, you can press the Jog Dial control while pressing the Ctrl key on the keyboard to switch to the launcher mode.

- 1 Turn the Jog Dial control to select the item you want, then press the Jog Dial control. The window switches to the guide mode, and shows the Jog Dial's function.



- 2 Turn or press the Jog Dial control to use the desired function.
- 3 To select another item, switch to the launcher mode and repeat from step 1.

Guide Mode

The Jog Dial control window is in the guide mode when software is in use and the software window is active. Depending on the software you are using, you can select items from the displayed list using the Jog Dial control. Some Sony software applications have two modes in List View, Simple Menu and Full Menu. You can switch the mode by pressing the shift key while turning the Jog Dial control.

Using Guide Mode

The Jog Dial control window displays the Jog Dial's function.

Using the Jog Dial Control with Sony Software

If Sony software that supports the Jog Dial control is active, you can use the Jog Dial's functions that are allocated to that software. For more information on functions allocated to software, see the software applications online Help.

Using the Jog Dial Control with Other Software

If the software you are using does not support the Jog Dial control, you can still perform the following functions:

<i>Action</i>	<i>Description</i>
Maximize Window*	Press the Jog Dial control button to maximize the size of the active window. Press again to return to normal window size.
Minimize Window*	Press the Jog Dial control button to minimize the size of the active window. Press again to return to normal window size.
Finish Window*	Press the Jog Dial control button to close the active application.
Scroll*	Press the Jog Dial control button to begin scrolling within the active window.
Jog Dial Launcher	Press the Jog Dial control button to return the Jog Dial control to Jog Launcher mode.
Menu Bar	Press the Jog Dial control button, then use the Jog Dial control to scroll through the active window's toolbar.

* Some software does not support these functions.

Using a Dialog Box

When a window such as Screen Properties is active, the Dialog box is displayed in the Jog Dial window. You can select an item in the window by rotating the Jog Dial control. Pressing the Jog Dial control is the equivalent of pressing Enter.

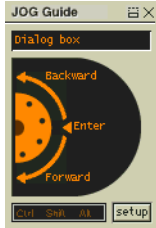

Using Smart Connect

The preinstalled Smart Connect software allows you to use an i.LINK® cable (optional) to connect your VAIO Z505 SuperSlim Pro notebook to another VAIO computer that also has Smart Connect. You can then use one computer to copy, delete, and edit files on the other computer. You can also print from a printer attached to either computer. See the Smart Connect online help for more information.

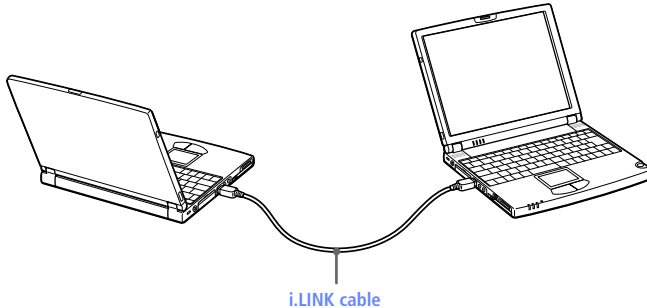

i.LINK cables compatible with your VAIO Z505 SuperSlim Pro notebook include cables with the following part numbers: VMC-IL4415 (a 1.5-meter cable with a 4-pin connector at each end), VMC-IL4615 (a 1.5-meter cable with a 4-pin connector at one end and a 6-pin connector at the other), and VMC-IL4408A (a 0.8-meter cable with a 4-pin connector at each end). You can purchase these cables from your local retailer, through the Sony VAIO® Direct Web site (<http://www.sonydirect.com/notebookaccessories/>), or by calling 1-888-315-7669 (toll free)

Using Power Saving Modes

When you use a battery as the source of power for your computer, you can take advantage of power management settings to conserve battery life. In addition to the normal operating mode, which allows you to turn off specific devices, your computer has three distinct power saving modes: System Idle, System Suspend, and System Hibernation. When using battery power, you should be aware that the computer automatically enters System Hibernation mode when the remaining battery charge drops to approximately 10%, regardless of the power management setting you select.



If your battery level falls to less than 10%, you should either attach the AC adapter to recharge the battery or shut down your computer and insert a fully charged battery.

Normal Mode

This is the normal state of your computer when it is in use. The green power indicator light is on in this mode. To save power, you can turn off a specific device such as the LCD or the hard disk.



For details, see "Controlling Power Management" in the online manual Customizing Your VAIO® Z505 SuperSlim Pro™ Notebook.

System Idle Mode

This mode is convenient if you do not need to use your computer for a brief period. The hard disk and video display enter a low power state, and the CPU clock and processor stop. The power indicator light is tan in this mode.

To activate System Idle Mode

Press Fn+S. You can also use the PowerPanel utility to enter System Idle mode.

To return to normal Mode

Press any key.

System Suspend Mode

The computer saves the current state of the system in RAM and switches off power to the CPU. The tan power indicator light flashes in this mode.

To activate System Suspend Mode

Press Fn+Esc. You can also use the PowerPanel utility to enter System Suspend mode.

To return to normal Mode

Press any key.

System Hibernation Mode

The state of the system is saved on the hard drive and power is turned off. The power indicator light is off in this mode.

To activate System Hibernation Mode

Press Fn+F12. You can also use the PowerPanel utility to enter System Hibernation mode.

To return to normal Mode

Turn on the computer by sliding the power switch forward. The computer returns to its previous state.



When returning from System Hibernation mode, the system status stored on the hard disk is erased and the computer starts normally if you slide the power switch forward and hold for more than four seconds.

- **Time to return to normal mode:**
System Idle requires less time than System Suspend, and System Suspend requires less time than System Hibernation.
- **Power consumption:**
System Idle uses more power than System Suspend, and System Suspend uses more power than System Hibernation.

Connecting Peripheral Devices

You can add functionality to your computer by connecting any of these peripherals:

- ❑ Phone line (page 44)
- ❑ Port replicator (page 47)
 - Printer (page 49)
 - External display (page 50)
 - Desktop computer or serial device
- ❑ CD-ROM drive (page 52)
- ❑ i.LINK device (page 55)
- ❑ Universal Serial Bus (USB) device (page 57)
- ❑ External display (page 59)

Connecting a Phone Line

You need to connect a phone line to take advantage of online services, the Internet, and Sony Customer Support.

 In order to register your Sony VAIO® Z505 SuperSlim Pro™ notebook, register your software online, and use Sony Customer Support, you must connect to a phone line. Also, you must register your computer to receive the extended warranty.

1 Open the phone line jack cover. The cover opens only to a 45-degree angle.

 Do not plug the phone cable into the Ethernet connector  as this may damage your notebook.

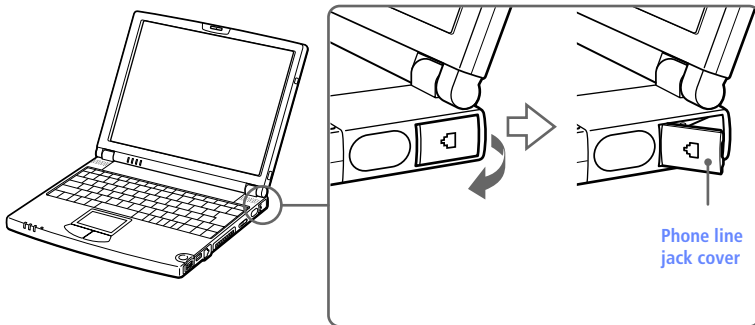

2 Plug one end of the phone cable (optional) into the jack on the inside of the phone line jack cover. Make sure you insert the phone cable from the rear of the computer and that the modular jack clicks into place.

3 Plug the other end into the wall jack.

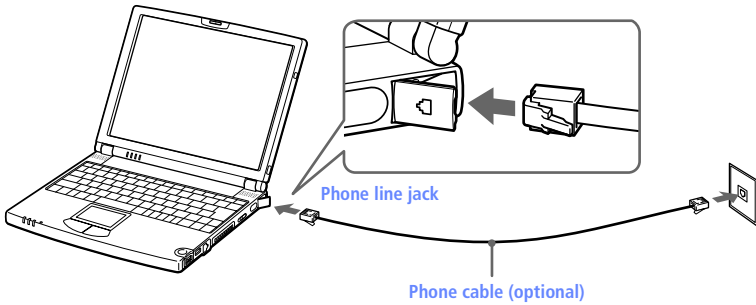

Your computer does not work with party lines, cannot be connected to a coin-operated telephone, and may not work with multiple phone lines or a private branch exchange (PBX). Some of these connections might result in excess electrical current and could cause a malfunction in the internal modem.

Connecting to the Local Area Network (LAN)

You can connect your computer to 10BASE-T and 100BASE-TX-type networks. For the detailed settings and devices needed to connect to the network, please ask your system manager.

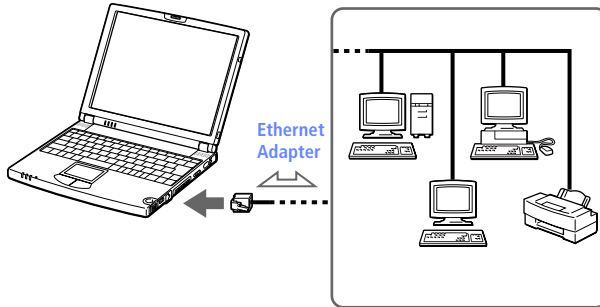

! **Warning:** Only connect 10BASE-T and 100BASE-TX cables to the  (Ethernet network) connector. Do not connect any other type of network cable or any telephone line. Connecting cables other than those listed above may result in an electric current overload and could cause a malfunction, excessive heat, or fire in the connector. To connect the unit to the network, contact your network administrator.



(For Windows® 98 operating systems only) By the default settings, your computer is unable to connect to the network. To connect to the network, check "Ethernet" in Sony Notebook Setup.

Connecting the i.LINK® Port Replicator

You can use the PCGA-UPR5 i.LINK port replicator (supplied) to connect peripheral devices such as a printer or external display. The port replicator has five ports, including an i.LINK port.

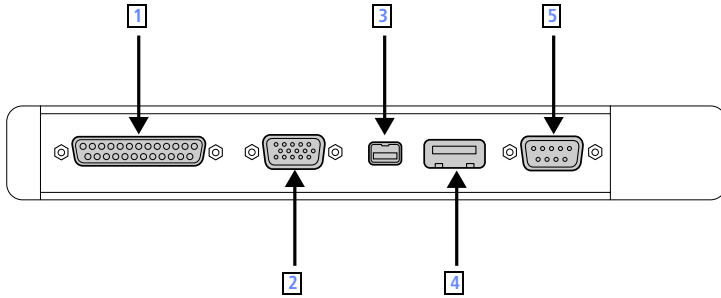

1  Printer (page 49)

2  Monitor (page 50)

3  i.LINK® device (page 55)

4  USB device (page 57)

5  Serial

To Attach the Port Replicator

- 1 Turn off the computer.
- 2 Open the port replicator connector cover on the left side of the computer.

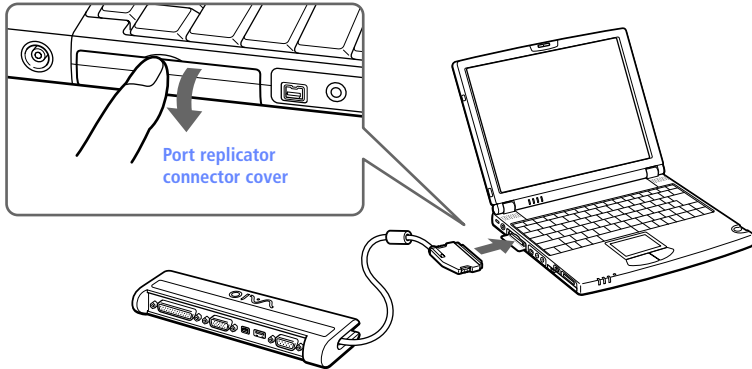

- 3 Plug the port replicator cable into the port replicator connector on the computer.

To Remove the Port Replicator

- 1 Turn off the computer.
- 2 Press both sides of the port replicator cable connector and unplug the cable from the computer.

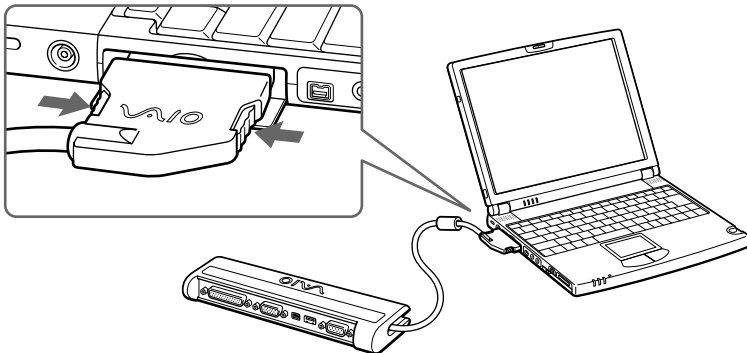

- 3 Fold the port replicator cable into the compartment on the side of the port replicator.

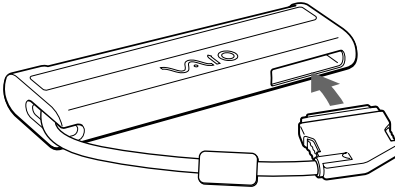

You cannot use the optional PCGA-PR5 port replicator with your computer.

When you use the port replicator, your computer's mini USB connector does not work.

Connecting a Printer

You can use the port replicator to connect a Windows 98 or Windows 2000 compatible printer or other parallel port device to your computer.





Turn off the computer before connecting peripherals. In normal use, you should turn on the peripherals before turning on the computer. You can connect i.LINK devices while the computer is on.

Connect the AC adapter only after connecting all cables.

To Connect a Printer

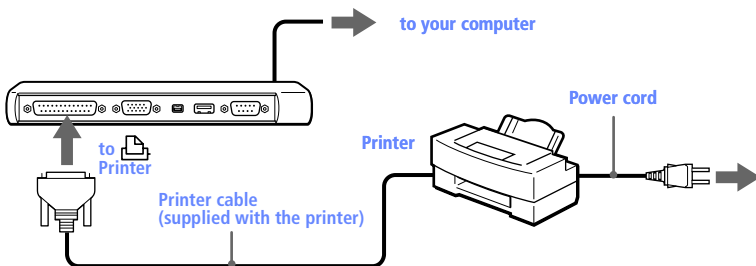
- ❑ Use the  symbol to locate the Printer connector on the port replicator. Plug the printer cable (supplied with the printer) into this connector.



- ❑ You can connect a Windows 98 or Windows 2000 compatible USB printer to your computer. Use the  symbol to locate the USB port on your computer and printer. Plug the USB printer cable (optional) into the USB connector

 See the manual that came with your printer for more information on installation and use.

Before using the printer, you may need to change the Printer setting in the Sony Notebook Setup software. See “Displaying the Sony Notebook Setup Screen” in the online manual Customizing Your VAIO® Z505 SuperSlim Pro™ Notebook.

Connecting an External Display

You can use the port replicator to connect an external display to your notebook computer. For example, you can use the computer with any of the following:

- ❑ Computer display (monitor) (page 50)
- ❑ Projector (page 51)

To Connect a Computer Display (Monitor)

- ❑ Use the  symbol on the port replicator to locate the Monitor connector. Plug the display cable into this connector.
- ❑ If necessary, plug one end of the display power cord into the display, and the other end into an AC outlet.

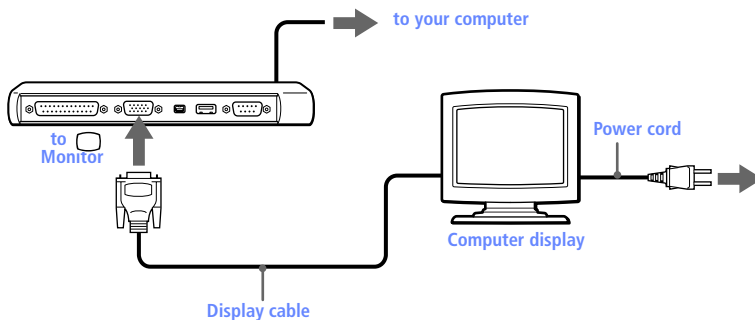

 See the manual that came with your computer (monitor) display for more information on installation and use.

The optional display adapter PCGA-DA5 allows you to connect a display directly to the port replicator connector (see page 59), eliminating the need for the port replicator.

To Connect a Projector

You can use a projector as an external display, such as the Sony LCD Projector.

- 1 Use the □ symbol to locate the Monitor connector. Plug the RGB signal cable into this connector.
- 2 Use the ♫ symbol to locate the Headphone connector. Plug the audio cable into this connector.

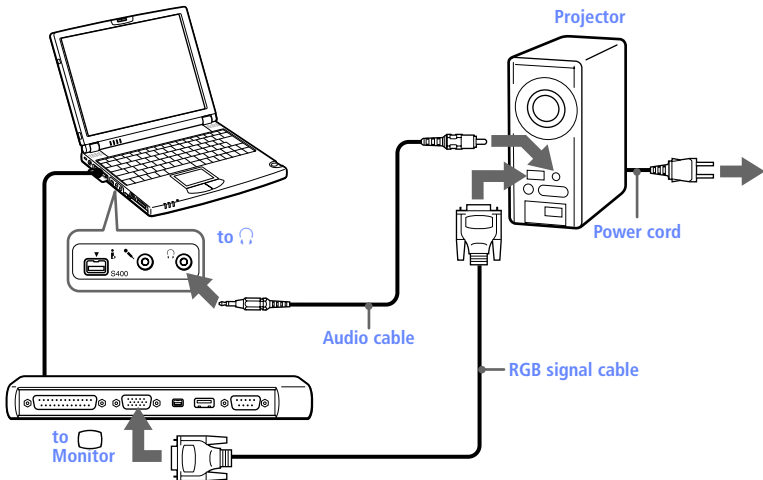

See the manual that came with your projector for more information on installation and use.

To Select a Display

When you connect an external display to the monitor connector, you can press **Fn+F7** to toggle the output between the Liquid Crystal Display (LCD), the external monitor, or both devices. See “Selecting the Display Mode” in the online manual *Customizing Your VAIO® Z505 SuperSlim Pro™ Notebook* for more information.

Connecting the CD/CDRW/DVD Drive

You can use the optional PCGA-CD51 CD-ROM drive, the PCGA-CDRW51 CD-RW drive, or PCGA-DVD51 DVD drive with your notebook. If you use either optional drive when your computer is running on battery power, the battery life will be shorter. The drive draws power from the computer through a PC card.

To Connect the CD Drive



You can connect a PCGA-CD51 CD-ROM drive or PCGA-CDRW51 CD-RW drive while the computer is on, unless you want to use the System and Application Recovery CDs. Turn off your computer before using the System and Application Recovery CDs.

Procedures for connecting the CD drive may vary, depending on the CD drive.

See the manual that came with your CD drive for more information on use.

To play an audio CD in the optional PCGA-CD51 CD-ROM drive with your notebook, your computer's settings must be set properly. You can check the settings as follows:

- 1) Click the Start button, select Settings, and click Control Panel.
- 2) Click the Multimedia icon.
- 3) Click the CD tab and make sure the "Enable digital CD audio for this CD-ROM device" box is checked. When this box is checked, your notebook computer's settings are correct for playing an audio CD in the PCGA-CD51 CD-ROM drive.

- 1 Remove the PC card slot protector from the PC card slot. See "Using PC Cards" on page 32 for details.
- 2 Remove the PC card from the bottom side of the CD drive.

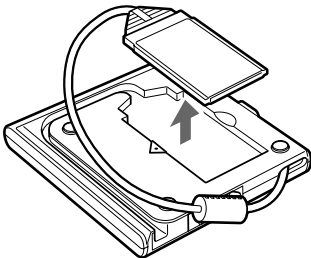

- 3 Insert the PC card into the PC card slot with the SONY logo facing up. See “Using PC Cards” on page 32 for details.

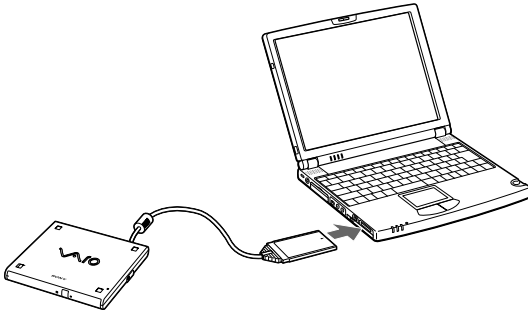

 A protective cover is attached to the lens of the CD-ROM drive at the factory. Before using the CD-ROM drive, remove the protective cover.

To Insert a Disc

- 1 Press the Eject button. The disc tray slides out.

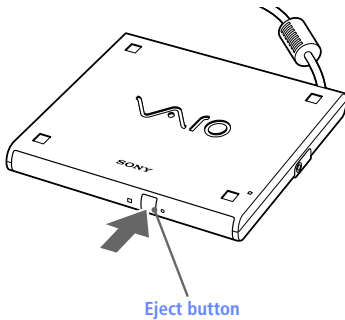

- 2 Place the disc in the tray with the label side facing up. Push the disc onto the hub until the disc clicks into place.

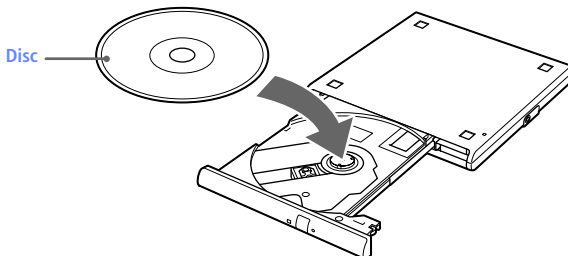

- 3 Close the tray by pushing it gently. The BUSY indicator on the drive flashes while your computer is reading data from the disc.

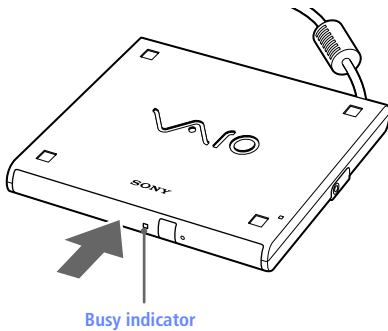

Handling CD or DVD Media

- ❑ Do not touch the surface of the disc.
- ❑ Do not drop or bend the disc.

Cleaning CD or DVD Media

- ❑ Fingerprints and dust on the surface of a disc may cause read errors. Proper care of the disc is essential to maintain its reliability. Do not use solvents such as benzine, thinner, commercially available cleaners or anti-static spray, as they may cause damage to the disc.
- ❑ For normal cleaning, hold the disc by its edge and use a soft cloth to wipe the surface from the center out.
- ❑ If the disc is badly soiled, moisten a soft cloth with water, wring it out well, and use it to wipe the surface of the disc from the center out. Wipe off any remaining moisture with a dry soft cloth.

To Remove the Drive

- ❑ Remove the PC card from the computer. See "Using PC Cards" on page 32 for details.

Connecting an i.LINK® device

Your VAIO Z505 SuperSlim Pro notebook includes an i.LINK (IEEE 1394) connector, which you can use to connect to a compatible i.LINK device such as a digital video camera recorder.

To Connect a Digital Video Camera Recorder

Plug one end of an i.LINK cable into the S400  connector on the left side of the computer and the other end into the DV In/Out connector on the digital video camera recorder. If your digital video camera recorder includes a **Memory Stick®** slot, you can copy images from it to your computer via a **Memory Stick** media. Copy images to the **Memory Stick** media and insert the media into the **Memory Stick** slot on your computer. For details on using **Memory Stick**, see “Using Memory Stick® Media” on page 24.

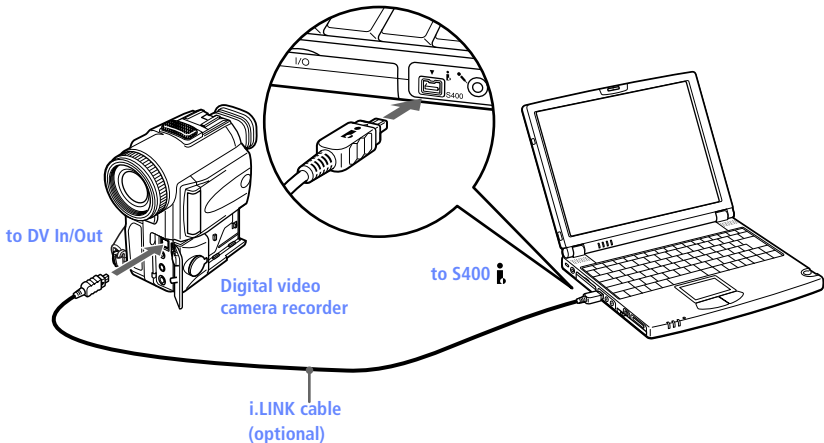



The Sony digital video camera recorder is pictured; your digital video camera recorder may need to be connected differently.

Only Sony digital video cameras, and connectors labeled "DV In/Out" or "i.LINK" are i.LINK-compatible.

See the manual that came with your digital video camera recorder for more information on installation and use.

The i.LINK connector does not supply power to external devices. If the external device requires power from the i.LINK connector, you cannot use the device with your computer.

The VAIO Z505 SuperSlim Pro notebook supports transfer rates up to 400 Mbps; however, the actual transfer rate is the lowest transfer rate of the external device.

The i.LINK features available may vary depending on the software applications you use. See the documentation that came with your software for more information.

See page 40 for a list of i.LINK cables compatible with your VAIO Z505 SuperSlim Pro notebook.

You can connect a digital video camera to the i.LINK connector on your notebook or the i.LINK connector on the optional port replicator. When a camera is connected to the i.LINK connector on the notebook, you should not connect any other devices to the i.LINK connector on the port replicator. When a camera is connected to the i.LINK connector on the port replicator, you should not connect any other devices to the i.LINK connector on the notebook.

Connecting a Universal Serial Bus (USB) Device

You can connect a USB device, such as a USB mouse, to your computer.

To Connect a USB Device

Use the Ψ symbol to locate the USB connector on the right side of the computer. Plug one end of the USB cable into this port and the other end into the USB mouse.

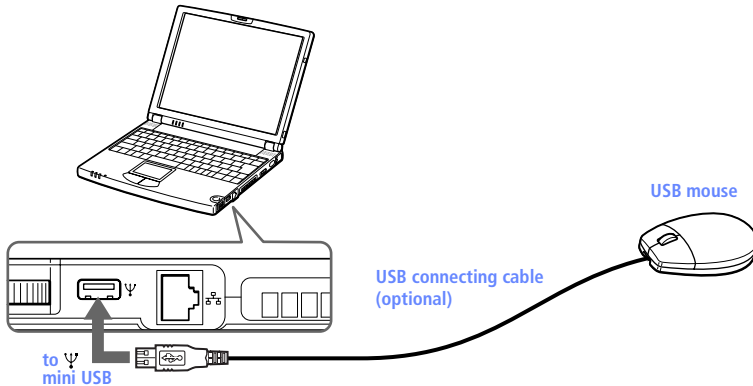

To Connect a Second USB Device.

When you wish to use another USB device, such as a floppy disk drive, at the same time, connect the second USB device to the (mini USB) connector by attaching the supplied conversion adapter.

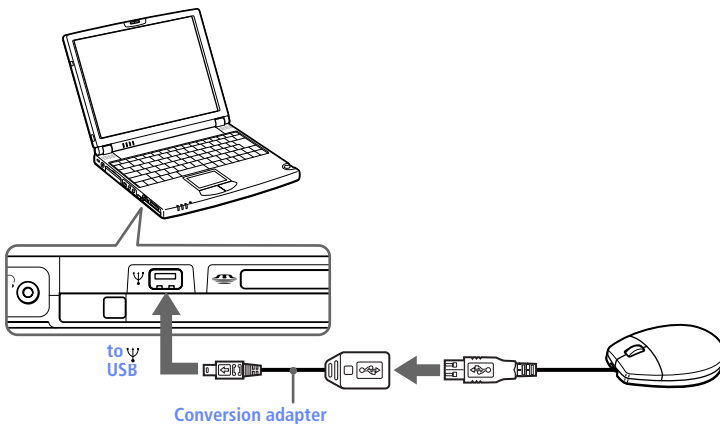



You can use the optional Sony USB mouse (PCGA-UMS1) with this computer. Plug the USB mouse into the USB connector. You do not need to turn off your computer. For more information, connect the mouse, double-click the Mouse tab in the Control Panel, and then click Help in the Mouse Suite tab.

See the manual that came with your USB device for more information on installation and use.

Connecting an External Display

You can connect your notebook to a computer display (monitor) or projector.

To Connect a Computer Display (Monitor)

Use the I/O port replicator connector on the left side of the computer. Plug the display adapter (optional) into this connector. If necessary, plug one end of the display's power cord into the display, and the other end into an AC outlet.

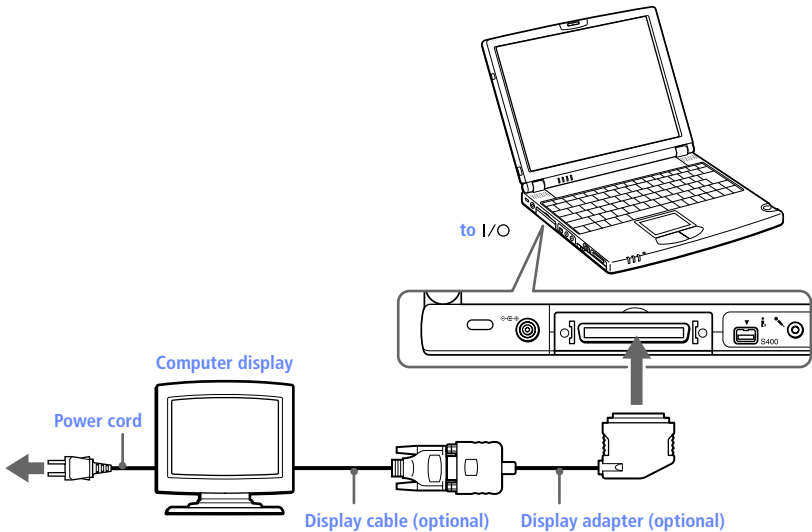

See the manual that came with your computer display (monitor) for more information on installation and use.

To Connect a Projector

You can use a projector, such as the Sony LCD Projector, as an external display.

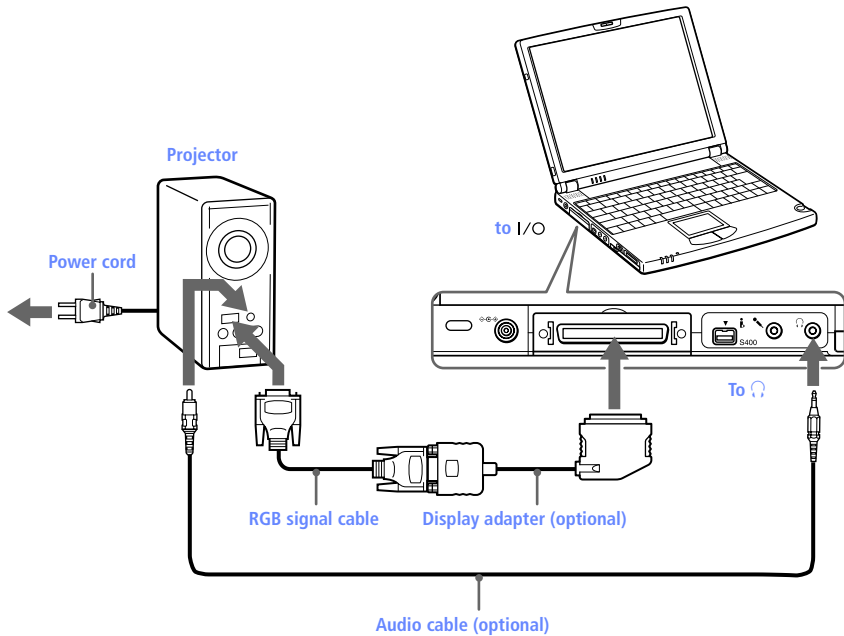

 See the manual that came with your projector for more information on installation and use.

To Remove the Display Adapter

Press both sides of the display adapter connector and unplug it from the computer.

To Select a Display

When you connect an external display to your computer, you can press **Fn+F7** to toggle the output between the Liquid Crystal Display (LCD), the external monitor, or both devices.

 See "Selecting the Display Mode" in the online manual Customizing Your VAIO® Z505 SuperSlim Pro™ Notebook for more information.

Adding Memory

In the future you may want to install memory modules to expand the functionality of your computer. You can increase memory to 192 MB on the PCG-Z505JE and the PCG-Z505JEK and you can increase memory to 256 MB on the PCG-Z505JS and PCG-Z505JSK. The PCG-Z505JE/PCG-Z505JEK has 64 MB of memory and the PCG-Z505JS/PCG-Z505JSK has 128 MB of memory. For memory upgrades, use only PC-100 SDRAM SO-DIMM (gold lead contacts).

! Make sure you observe the proper safety precautions when you install a memory module in your computer. See the bulleted list below. Be careful when adding memory. Mistakes when installing or removing a memory module may cause a malfunction.

- ❑ The procedures described below assume familiarity with the general terminology associated with personal computers and with the safety practices and regulatory compliance required for using and modifying electronic equipment.
- ❑ Disconnect the system from its power source and from any telecommunications links, networks, or modems before you open the system or follow any of the procedures described below. Failure to do so may result in personal injury or equipment damage.
- ❑ Electrostatic discharge (ESD) can damage disk drives and other components. Perform the procedures described below only at an ESD workstation. If such a station is not available, do not work in a carpeted area, and do not handle materials that produce or hold static electricity (cellophane wrappers, for example). Ground yourself by maintaining contact with an unpainted metal portion of the chassis while performing the procedure.
- ❑ Do not open the memory module package until you are ready to install the module. The package protects the module from ESD.
- ❑ Use the special bag for preventing ESD or use aluminum foil when you store the memory module.

To Install a Memory Module

- 1 Shut down your computer and disconnect all peripheral devices, such as your printer.
- 2 Unplug the computer and remove the battery packs.
- 3 Wait until the computer cools down. Then unscrew the six screws with the ● mark on the bottom of your computer.

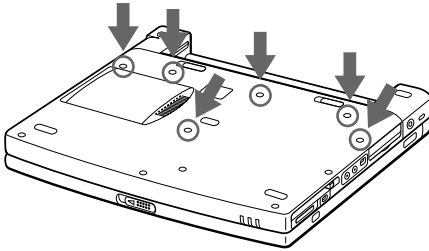

- 4 Slide the LCD lock lever and lift the cover. Slide the keyboard toward the LCD display, then lift it away slightly.

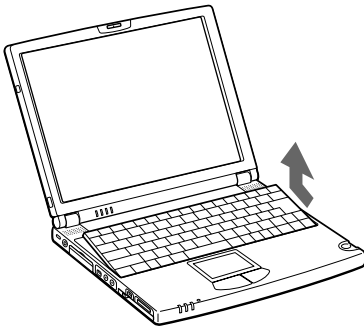

- 5 Lift the keyboard from the LCD display side, then gently turn it over on the touchpad space. Be careful not to detach the cable when lifting the keyboard.
- 6 If you are adding memory to the PCG-Z505JS/PCG-Z505JSK, you must remove the existing memory module. Follow the instructions in "To Remove a Memory Module" on page 63.
- 7 Remove the memory module from its packaging.
- 8 Install the memory module. Be careful not to touch the other components of the motherboard.

- 9 Gently replace the keyboard, then press it into your computer. Be careful not to detach the cable when lifting the keyboard.



If you cannot reset the keyboard correctly, check that the heat sink has not been moved into the area where the keyboard must be placed.

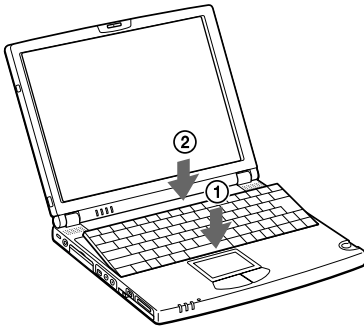

- 10 Close the computer cover, then tighten the screws on the bottom of the computer.
- 11 Turn on the computer.
- 12 Click the Start button, point to VAIO, and click Sony Notebook Setup. The Sony Notebook Setup screen appears.
- 13 Click the About This Computer tab to view the amount of system memory. If the additional memory is not shown, repeat steps 1-12.

To Remove a Memory Module

- 1 Follow steps 1 to 5 of “To install a memory module.”
- 2 Touch a metal object (such as the connector panel on the back of your computer) to discharge static electricity.
- 3 Remove the memory module.
- 4 Follow steps 8 and 9 of “To install a memory module.”

About Your Software

MovieShaker™

This application can be used to create fun and innovative movies without any knowledge of film editing. In a few simple steps, motion pictures can be combined with special effects, still images (pictures), and music files and then saved in a format most computers can play.

Main Window

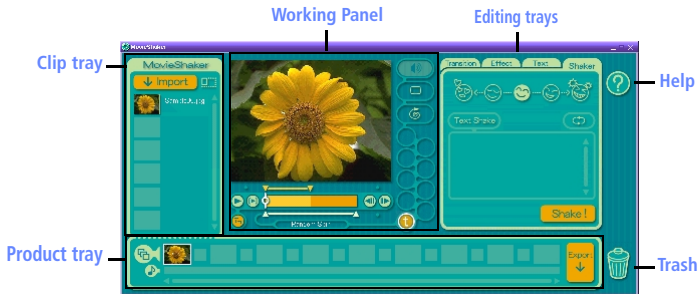

Importing Images and Sound Clips

- 1 Click  .
- 2 Find the file you want to add.
- 3 Select the file.
- 4 Click Open. The file is added to the Clip tray.

Create a Movie using Shaker

After adding clip(s) to the Clip tray, you can create a short movie using the Shaker feature. Shaker randomly select clips from the Clip tray to create a 30-second scene.

- 1 Click the Shake tab.
- 2 Select a mood by clicking a face in the Shaker tray.



- 3 Click **Shake!**. A thirty second scene is automatically generated and saved to the Product tray.
- 4 To preview, switch the Work Panel to Product tray mode and press play.



Scenes created with Shaker begin with black frame and after processing are placed in the first available slot on the Product tray.

Editing Clips and Scenes

You can edit your movie by adding effects and text, adjusting the color and contrast, and modifying the length of clips.

Working Panel



Adding effects to a scene or a clip:

- 1 Double-click the clip or scene to move it to the Working Panel.
- 2 Select the Effects tab from the Editing tray.
- 3 Drag and drop the Effect you want to add from the Effects tray to the Effects palette on the Working Panel.

 To preview an Effect, click on the clip in the Working panel monitor. Your clip displays with the new effect on the Effect tray monitor.

- 4 See help for instructions on adjusting effect duration and replaying clips/scenes.

Saving a Movie

- 1 Verify that the clip(s) you want to save is on the Product tray. See Help for more details on saving movies.
- 2 Click Export.
- 3 Select the format in which you want the document to be saved.
- 4 Click Next.
- 5 Locate the folder to which you want the file saved.
- 6 Name the file.
- 7 Click Save.

! Exporting movies may take a long time to complete—Save movie as DV (Digital Video) takes the longest and Quick-Save is the fastest.

PictureGear™

PictureGear is a digital image management application that allows you to see all the images stored in any directory on your computer. Thumbnail views provide quick reminders of your pictures. Brighten, contrast, enhance, resize, crop, and color-correct your pictures. Create panoramic views, animations, screen savers, wallpaper, still pictures from MPEG, and even html photo albums.

Managing Your Pictures

Use the collection feature to manage your pictures.

- 1 Click the Folder tab and browse to locate your pictures.
- 2 Select the pictures you want to have in a collection.
- 3 From Collection menu, select Create New Collection.
- 4 Enter a name for the collection and then click okay.

Creating a Photo Album

- 1 Select the pictures you want to use to make an album.
- 2 From the Utilities menu, select Album Maker.
- 3 Choose the type of Album you want and click Okay.
- 4 Now add more pictures, frames, text, and effects.
- 5 When you are finished, select Create Album in File menu or click the Create Album icon on the toolbar.
- 6 Designate the folder you where want to save the Album.
- 7 Enter the Target Album name, select Thumbnails and click Okay.
- 8 The new album can be viewed using most internet browsers.

Using Panorama Maker

Panorama Maker stitches a group of still images into a 360 degree panoramic picture. The source images should be the same size and overlap 20%.

How to stitch a panoramic picture:

- 1 Gather the source images into the same folder or collection.
- 2 Select the images you want to use.



We recommend 12 landscaped or 16 portrait pictures.

- 3 From the Utilities menu select Panorama Maker.
- 4 Select the correct lens and click Okay. (If 35mm lens is selected the prompt, does not appear; to select a different lens, click the lens icon.)
- 5 Click the panoramic icon, near the bottom of the window.
- 6 Click Full Stitch.

Making Still Images and Panoramic from MPEG

- 1 Select the MPEG file.
- 2 From the Movie/Sound menu, select Scene break down.
- 3 Then select Movie Stitch, to create a panoramic picture.

Getting Help

Sony provides several support options for your Sony computer. When you have questions about your computer and the preinstalled software, check these sources for answers, in the following sequence:

- 1** *Read Me First* Contains Frequently Asked Questions, the most up-to-date information on using your computer, and software support information.
- 2** *User Guide* Explains how to use your notebook computer and peripheral devices, and solve common problems. Also includes product specifications.
- 3** Electronic Documentation *Read Me First* and the *User Guide* are also available electronically on your hard drive, along with two additional documents: *Customizing Your VAIO Model Name* and *Troubleshooting Help*. You can access this electronic documentation from the Windows Start menu by selecting Programs/VAIO/Documentation.
- 4** Manuals and online help files that may accompany your preinstalled software Most of the manuals for preinstalled software are located on your hard disk drive as online help files. You can access the online help files from the Help menu in the specific application. A printed manual is available for some applications.
- 5** Knowledge Database Provides instant access to information on commonly encountered problems. Enter a description of your problem and the Knowledge Database searches for the corresponding solutions online. You can access the Sony Knowledge Database at <http://www.sony.com/pcsupport>
- 6** Sony Fax-on-Demand This service provides you with answers to commonly asked questions. You can use this automated service to request a list of available topics and then select the topics that you want to receive. To contact the Sony fax-on-demand service, call 1-888-4SONYPC (1-888-476-6972). (Requires a fax machine or your fax software.)
- 7** Software Updates You can download the latest software updates and software patches for your Sony computer by selecting Software Updates on the Sony PC Support web page at <http://www.sony.com/pcsupport>

Troubleshooting

This section describes how to solve common problems you may encounter when using your computer. Many problems have simple solutions, so try these suggestions before you call Sony Customer Support.



When you reconnect devices, be sure to turn off the computer as described in “Shutting Down Your Computer” on page 17. Turning off the computer using other methods may result in data loss.

My computer does not start

- ❑ Check that the computer is plugged into a power source and that it is turned on. Check that the power indicator on the front panel of the computer indicates that the power is on.
- ❑ Check that the battery is inserted properly and that it is charged.
- ❑ Make sure there is no diskette in the floppy disk drive.
- ❑ Confirm that the AC adapter and all cables are connected firmly, as described in “Connecting Peripheral Devices” on page 43.
- ❑ If you plugged the computer into a power strip or UPS, make sure the power strip or UPS is turned on and working.
- ❑ If you are using an external display, check that it is plugged into a power source and turned on. Check that the brightness control is adjusted correctly. See the manual that came with your display for details.
- ❑ Moisture condensation may have occurred. Do not use the computer for at least one hour and then turn on the computer.

When I turn on my computer, the message “Operating system not found” appears and Windows does not start

- ❑ Check the floppy disk drive to see if a non-bootable diskette is in the drive.
- ❑ If a non-bootable diskette is in the drive, turn off the computer, remove the diskette, and then turn on the computer again. Confirm that Windows starts properly. If Windows still does not start, follow the procedure below to initialize the BIOS.
- ❑ If the floppy disk drive is empty or contains a bootable diskette, use the following procedure to initialize the BIOS:
 - 1 Remove the floppy disk drive, port replicator, PC card, and any other peripheral devices from the computer.
 - 2 Turn the computer off and then turn it on again.
 - 3 Turn on the computer and press the F2 key when the Sony logo appears. The BIOS setup menu screen appears.
 - 4 Press the arrow keys to select the Exit menu.
 - 5 Press the arrow keys to select Get Default Values and then press the Enter key. The message “Load default configuration now?” appears.
 - 6 Check that Yes is selected, then press the Enter key.
 - 7 Press the arrow keys to select Exit (Save Changes) and then press the Enter key. The message “Save configuration changes and exit now?” appears.
 - 8 Check that Yes is selected, then press the Enter key. The computer restarts.

When I turn on my computer, the message “C:\WINDOWS” appears and Windows does not start

- ❑ Enter “win,” then press the Enter key. When the message “MS-DOS is activated. Do you want to return to Windows and restart applications?” appears, press the Enter key again. Windows starts.
- ❑ When shutting down your computer, follow the procedure in “Shutting Down Your Computer” on page 17. Windows should start automatically the next time you turn on your computer.

My LCD does not display anything

- ❑ Check that the computer is plugged into a power source and that it is turned on. Check that the power indicator on the front panel of the computer is on.
- ❑ Check that the battery pack is inserted properly and that it is charged.
- ❑ The computer may be in LCD (Video) Standby mode. Press any key to activate the display.
- ❑ The video output may be directed to an external display attached to the port replicator. Press Fn+F7 until video output appears on the LCD.

The screen image on my external display is not centered or sized properly

Use the controls on your external display to adjust the image. See the manual supplied with your display for more information.

My computer "locks up"

- ❑ Try restarting the computer. On the Windows taskbar, click the Start button, click Shut Down, and then click Restart the computer.
- ❑ If you cannot restart as described in the preceding step, you can restart the computer by pressing Ctrl+Alt+Delete.
- ❑ If Ctrl+Alt+Delete does not work, slide the power switch toward the front and hold it for four seconds. This turns off the power.
- ❑ If your computer locks up while playing a CD-ROM, stop the CD-ROM and restart the computer by pressing Ctrl+Alt+Delete.



Pressing Ctrl+Alt+Delete or turning off the computer with the power switch may result in data loss in files that are currently open.

My software program "locks up" or crashes

Contact the software publisher or designated provider for technical support.

I cannot print

Try changing the printer port mode. In Sony Notebook Setup, select the Printer/FDD tab. If the printer port mode is set to ECP, change it to bi-directional. If the printer port mode is set to bidirectional, change it to ECP. See "Displaying the Sony Notebook Setup Screen" in the online manual *Customizing Your VAIO® Z505 SuperSlim Pro™ Notebook* for details on using Sony Notebook Setup.

My printer doesn't function after the computer resumes from a power saving mode

When this occurs, follow the procedures below to reset the printer connection:

- 1 Right-click the My Computer icon on the desktop, and then select Properties.
- 2 Click the Device Manager tab.
- 3 Select Refresh, and then click OK.

The printer should now function properly.

I cannot play a CD

- Make sure the label of the CD is facing up.
- If the CD requires software, make sure the software is installed according to the program's instructions.
- Moisture condensation may have occurred. Disconnect the drive and disconnect the power to the drive for at least one hour.
- Make sure the drive is properly connected. See "Connecting the CD/CDRW/DVD Drive" on page 52.
- Clean the CD.
- Check the speaker volume.

When I click an application icon a message appears, such as "You must insert the application CD into your CD-ROM drive," and the software does not start

- Some titles require specific files that are located on the application's CD-ROM. Insert the disc and try starting the program again.
- Make sure you place the disc in the tray with the label side facing up.

My floppy disk drive cannot write to a diskette

- The diskette is write-protected. Disable the write-protect feature or use a diskette that is not write-protected.
- Check that the diskette is properly inserted into the floppy disk drive.

My speaker has no sound

- ❑ The built-in speaker is turned off. Press Fn+F3 to turn on the speaker.
- ❑ The speaker volume is turned to the minimum. Press Fn+F4, and then press \uparrow or \rightarrow to increase the volume.
- ❑ If your computer is powered by the battery, check that the battery is connected properly and that it is charged.
- ❑ If you are using an application that has its own volume control, check that the volume is turned up.
- ❑ Check the volume controls in Windows.
- ❑ If you have connected a headphone or an audio cable to the Headphone connector, disconnect the cable.

My modem does not work

- ❑ Check that the phone line is plugged into the line jack. See “Connecting a Phone Line” on page 44 for details.
- ❑ Check that the phone line is working. You can check the line by plugging in an ordinary phone and listening for a dial tone.
- ❑ Check that the phone number the program is dialing is correct.
- ❑ Check that the software you are using is compatible with the notebook computer modem. (All preinstalled programs are compatible.) Call the software publisher or Sony Customer Support.

My modem connection is slow

The computer’s modem uses 56K technology/V.90. Many factors influence modem connection speed, including telephone line noise or compatibility with telephone equipment (such as fax machines or other modems). If you think your modem is not connecting properly to other PC-based modems, fax machines, or your Internet Service Provider, check the following:

- ❑ Have your phone company check that your phone line is free from any line noise.
- ❑ If your problem is fax-related, check that there are no problems with the fax machine you are calling and that it is compatible with fax modems.
- ❑ If you are having a problem connecting with your Internet Service Provider, check that the ISP is not experiencing technical problems.
- ❑ If you have a second phone line available, try connecting the modem to that line.

My mouse does not work

If you have connected an external mouse to the mini USB connector, it may cause some problems when you transfer high-speed or high-capacity data. Use the USB connector.

I cannot use DV devices and messages appear on the screen

- ❑ Check that the DV device is turned on and that the cables are properly connected.
- ❑ If you are using multiple i.LINK devices, the combination of the connected devices may cause unstable operation. In this case, turn off the power to all connected devices and disconnect unused devices. Check the connection, then turn on the power again.

My computer does not shut down

It is best to shut down your computer using the Shut Down command on the Windows Start menu. Using other methods, including those listed here, may result in loss of unsaved data. If the Shut Down command does not work properly, follow these steps:

- ❑ Restart the computer by pressing Ctrl+Alt+Delete. If this does not work, slide the power switch forward and hold it for four seconds.
- ❑ Unplug the computer from the AC adapter and remove the battery pack from your computer.

My PC card is not working

- ❑ Make sure the PC card is compatible with Windows.
- ❑ Use the Sony Notebook Setup utility to disable devices you are not currently using.

*When I remove the **Memory Stick** media, an error message appears.*

Insert the media into the slot again and press the Enter key. Wait until the active application finishes, then remove the media. If the message confirms eject of the media, click OK.

Power Management

The operating system may become unstable if a lower power state such as system hibernation is initiated and then changed before the operating system completely enters the lower power state. To restore the computer to its normal operating stability, close all open applications, and slide the power switch forward and hold it there for four seconds or more to completely shut down the computer.

Using the System and Application Recovery CDs

The following sections describe how to use the System Recovery and Application Recovery utilities. You need to connect the optional PCGA-CD51 CD-ROM drive, the PCGA-CDRW51 CD-RW drive, or the PCGA-DVD51 DVD drive to use the System and Application Recovery CDs.

Using the System Recovery CD(s)

You can reinstall software titles that shipped with your computer if they are corrupted or accidentally erased. You may not need to recover the entire contents of your hard drive. If you experience a problem with your computer, reinstalling an individual device driver or software title may correct the problem. Use the Application Recovery CDs to reinstall individual applications or device drivers. See “Using the Application Recovery CD(s)” on page 80.

The System Recovery CD contains a backup copy of all the software originally installed on your hard disk drive. **It can be used only to recover the hard disk of the notebook computer you purchased.**

The System Recovery utility gives you three options:

- ❑ **Full Restore without Format** restores all the software titles that originally came with your computer without formatting the hard disk.



If you recover your operating system using the System Recovery CD, Microsoft Word 2000 will not be recovered. Use the supplied Word 2000 CD-ROM to recover this application.

- ❑ **Full Restore with Format** formats the hard disk drive and then restores all the original software.
- ❑ **Operating System Only** restores the Windows® operating system, the notebook computer utility programs, and the device drivers that shipped with your computer.



If you choose the Full Restore with Format or Operating System Only option, your hard disk will be formatted, which removes all the information on the hard disk drive. You will lose any software you have installed and any other files you have created since you started to use your computer. This means you will have to reinstall any applications that were not included with the computer when you purchased it. If you choose the Full Restore without Format option, you may need to reinstall applications that were not included with the computer when you purchased it. If you have any questions on using the System Recovery CD, contact Sony Customer Support.

To use the System Recovery CD(s)

 The optional PCGA-CD51 CD-ROM drive, the PCGA-CDRW51 CD-RW drive, or the PCGA-DVD51 DVD drive must be connected to the computer to use the System Recovery CD.

You need to complete the Windows registration process when you use the System Recovery CD. Make sure you have the product ID number located on the cover of your Microsoft Windows Getting Started manual. You will need this number to complete the recovery process.

- 1 Insert the Sony System Recovery CD in the CD-ROM drive.
- 2 Shut down your computer as described in “Shutting Down Your Computer” on page 17.
- 3 Wait four seconds and turn on your computer.
- 4 Click OK to signify you have read and accept the Microsoft End-User License Agreement.
- 5 When the System Recovery menu appears, follow the on-screen instructions to complete the recovery process.

 Your system may include one or two System Recovery CDs. If you have two System Recovery CDs, insert the first CD to run the System Recovery program. You are prompted to insert the second CD once the information from the first CD has been installed.

The recovery process takes 30 to 60 minutes to complete.

After recovering your system using the SRCD, you may be prompted to insert your ARCD after restarting Windows. Insert the ARCD to automatically complete recovery of your system.

If your computer does not start from the Recovery CD

- 1 Slide the power switch forward and hold it for more than four seconds to turn off the computer.
- 2 Turn on the computer and press the F2 key when the Sony logo appears. The BIOS setup menu screen appears.
- 3 Press the arrow keys to select the Exit menu.
- 4 Press the arrow keys to select Get Default Values and then press the Enter key. The message “Load default configuration now?” appears.
- 5 Check that Yes is selected, then press the Enter key.

- 6 Press the arrow keys to select Exit (Save Changes) and then press the Enter key. The message “Save configuration changes and exit now?” appears.
- 7 Check that Yes is selected, then press the Enter key. The computer restarts from the Recovery CD.



After recovering your system using the System Recovery CD, you may be prompted to insert your Application Recovery CD at the first boot. Insert the Application Recovery CD to automatically complete full recovery of your system.

Using the Application Recovery CD(s)

The Application Recovery CDs allow you to reinstall individual applications and device drivers if they are corrupted or accidentally erased. Reinstalling an individual device driver or software title may correct a problem you are experiencing with your computer, and you may not need to recover the entire contents of your hard drive. If you do need to reinstall all the software titles that shipped with your computer, use the System Recovery CD. See “Using the System Recovery CD(s)” on page 78.



You must be in Windows to run the Application Recovery CDs. The application will not run from MS-DOS®. If you have any questions on using the Application Recovery CDs, contact Sony Customer Support.

Some applications on the Application Recovery CDs must be decompressed before the installation process begins. Your screen does not change while the files are decompressed. The time to decompress an application varies and may be as long as 30 minutes.

To use the Application Recovery CD(s)

- 1 Turn on your computer. If your computer is already on, close all applications.
- 2 When the Windows desktop appears, insert the first Sony Application Recovery CD in the CD-ROM drive. The Application Recovery utility loads automatically.
- 3 When the Application Recovery menu appears, follow the on-screen instructions to complete the recovery process.



Your system may include one or two Application Recovery CDs. If you have two Application Recovery CDs, insert the first CD to run the Application Recovery program. You may be prompted to insert the second CD, depending on the application you wish to restore.

Hard Drive Partition

In order to improve the performance of your computer's DVgate™ Motion software, the hard disk drive on your computer has been formatted with two partitions, C and D.* DVgate Motion saves files to the D partition. This prevents large video captures from consuming the available space on your C partition. To maintain optimum performance of DVgate Motion, you should defragment your D partition regularly. See the DVgate Motion online help for more information.

* See "Specifications" on page 82.

Specifications

<i>Model</i>	<i>PCG-Z505JE/PCG-Z505JEK</i>	<i>PCG-Z505JS/PCG-Z505JSK</i>
<i>Processor</i>	500 MHz* Intel® Pentium III processor	650 MHz* Intel® Pentium III processor featuring Intel® SpeedStep™ technology
<i>Hard Disk Drive</i>	9 GB [†]	12 GB [†]
<i>C/D Partition (Approx.)</i>	6 GB, 3 GB	8 GB, 4 GB
<i>Standard RAM</i>	64 MB SDRAM expandable to 192 MB	128 MB SDRAM, [‡] expandable to 256 MB**
<i>LCD Screen</i>	12.1" XGA TFT	
<i>L2 Cache Memory</i>	256 KB (on CPU)	256 KB (on CPU)
<i>MPEG</i>	MPEG1 Digital Video supports full-screen playback	
<i>Graphics</i>	128-bit accelerator with 3 MB Video RAM	128-bit accelerator with 6 MB Video RAM
<i>Sound Capabilities</i>	16-bit CD-quality stereo sound	
<i>Diskette Drive</i>	External USB 3.5" 1.44 MB	
<i>Modem</i>	56K and V.90 compatible modem ^{††}	
<i>Infrared</i>	Supports 4 mbps, 1.1 mbps, and 115 kbps IrDA Standard	
<i>Expansion Capabilities</i>	One PCMCIA type II Card Card Bus support	
<i>Built-in Capabilities</i>	Microphone Stereo speakers Touchpad	
<i>Telecommunication Capabilities</i>	Data/fax send/receive	
<i>Connection Capabilities on Z505 SuperSlim Pro</i>	Phone line (RJ-11) i.LINK® port replicator i.LINK (IEEE 1394) 2 USB ports, including 1 mini-USB port 10Base-T/100Base-T Ethernet interface Microphone In DC In Headphone	
<i>Connection Capabilities on i.LINK Port Replicator</i>	i.LINK Printer Serial USB VGA monitor	
<i>Supplied Accessories</i>	USB floppy disk drive Mini-USB converter cable Rechargeable battery AC adapter and power cord i.LINK port replicator	
<i>Power Requirements</i>	49.5 watts maximum (19.5V DC/AC100-240V) The notebook supports 50-60hz and 100-240V ac.	

<i>Model</i>	<i>PCG-Z505JE/PCG-Z505JEK</i>	<i>PCG-Z505JS/PCG-Z505JSK</i>
<i>Power Management</i>	Energy Star Compliant Advanced Configuration and Power Interface (ACPI)	
<i>Battery</i>	Lithium-ion	
<i>Dimensions</i>	10.8" (w) x 0.96" (h) x 8.9" (d) (275mm x 24.5mm x 226mm) ^{‡‡}	
<i>Weight</i>	3.7 lbs. (1.70 kg) (with supplied battery)	
<i>Operating Temperature</i>	41° F to 95° F (5° C to 35° C) (temperature gradient less than 18° F (10° C)/hour)	
<i>Operating Humidity</i>	20% to 80% (not condensed), provided that humidity is less than 65% at 95° F (35° C) (hygrometer reading of less than 84° F (29° C))	
<i>Storage Temperature</i>	-4° F to 140° F (-20° C to 60° C) (temperature gradient less than 18° F (10° C)/hour)	
<i>Storage Humidity</i>	10% to 90% (not condensed) provided that humidity is less than 20% at 140° F (60° C) (hygrometer reading of less than 95° F (35° C))	

* MHz denotes microprocessor internal clock speed; other factors may affect application performance.

† GB means one billion bytes when referring to hard drive capacity. Accessible capacity may vary.

‡ Your system may contain additional memory installed at the time of purchase.

** The PCG-Z505JE/PCG-Z505JEK includes 64 MB memory. The PCG-Z505JS/PCG-Z505JSK includes 128 MB memory.

†† Maximum speed for faxing is 14.4 kbps. Your modem is capable of downloading at 56 kbps. Your online service or Internet Service Provider, however, may not support this technology or operate at this speed.

‡‡ Height measured at the thinnest point. Height at the thickest point is 1.15" (29.3mm).

Specifications are subject to change without notice.

Index

A

- AC Adapter **11**
- AC adapter **11**
- AC power **11**
- adding
 - hardware **43**
 - peripherals **43**
 - printers **49**
- adjusting
 - brightness **23**
- Alt key **20**
- Application Recovery CDs **80**
- Applications key **20**
- attaching port replicator **48**

B

- batteries **15**
 - using **15**
- battery pack **12**
 - charging **13**
 - connector **8**
 - indicator light status **13**
 - indicator lights **7, 13, 22**
 - inserting **12**
 - loading **12**
 - power status **13**
 - rechargeable **11**
 - removing **14**
- battery power **11**
- brightness
 - adjusting **16, 23**
- built-in speaker **7, 23**
 - volume **23**
- buttons
 - left **7**

- right **7**
- Start (Windows 98) **17**

C

- cameras
 - digital video recorder **55**
- canceling commands **20**
- Caps Lock **7**
 - indicator light **22**
- CD Drive **52**
- CD or DVD Media
 - cleaning **54**
 - handling **54**
- CD-ROM discs
 - inserting **53**
- CD-ROM drive
 - closing lid **54**
 - connecting **32, 52**
 - troubleshooting **75**
 - using **52**
- CDRW Drive **52**
- charge status indicator light **13**
- charging battery pack **13**
- choosing
 - power source **11**
- cleaning
 - CD or DVD Media **54**
- coin-operated telephones **45**
- computer
 - handling **6**
 - lithium ion battery **vi**
 - setting up **7**
 - starting **16**
 - troubleshooting **72–77**
 - unpacking **2**

connecting

- CD-ROM drive **32, 52**
- coin-operated telephones **45**
- digital video camera recorder **55**
- floppy disk drive **30**
- monitor **50**
- multiple phone lines **45**
- network **32**
- parallel devices **49**
- party phone lines **45**
- PBX **45**
- phone line **44**
- port replicator **47, 48**
- power source **11**
- printer **49**
- projector **51**

Connecting the CD/CDRW/DVD Drive **52**

connectors

- battery **8**
- DC In **8, 11**
- infrared **9**
- monitor **47**
- parallel **49**
- parallel port **47**
- port replicator **8**
- printer **47, 49**
- Serial port **47**
- USB **9, 30**

correction keys **19, 20**Ctrl key **20**cursor-movement keys **19****D**DC In **8, 11**digital video camera recorder **55**

diskettes

- ejecting **31**
- handling **31**
- inserting into drive **30**
- troubleshooting **75**

display

- connector **47**
- options **51**
- selecting **51**

disposal of lithium ion battery **vi**drives **52**

- CD-ROM **52**
- floppy disk **30**
- DV In/Out **8, 55**
- DVD Drive **52**
- DVgate **27, 81**

E

- Eject button **31**
- ejecting
 - diskettes **31**
- Energy Star **ii**
- ergonomic considerations **4**
- Escape key **19**
- Ethernet network connector **9**
- external devices
 - display **50, 59**
 - See also monitor

F

faxes

- laws governing **v**

floppy disk drive

- connecting **30**
- disconnecting **31**
- troubleshooting **75**

Fn key **20**

- combination commands **23**

function keys **20****G**Getting Help **71**Guide Mode **38****H**handling **6**

- CD or DVD Media **54**
- diskettes **31**

handling the LCD screen **18**Handycam® **27**

hard drive

- indicator light **7, 22**

headphone

- connector **8, 51**

I

- i.LINK **8, 47, 55**
- i.LINK® Interface **27**
- IEEE1394 **8, 47, 55**
- indicator lights **22**
 - battery **7, 13, 22**
 - Caps Lock **7, 22**
 - charge status **13**
 - hard drive **7, 22**
 - Information **7**
 - Num Lock **7, 22**
 - power **7**
 - Scroll Lock **7, 22**
- infrared port **9**
- input devices **iv**
- Insert key **19, 20**
- inserting
 - battery pack **12**
 - diskettes into drive **30**
- installing
 - hardware **43**
 - peripherals **43**
- interference **iv**
- internal speaker
 - See speakers

J

- Jog Dial **36**

K

- keyboard **7, 19–21, 23**

L

- Launcher Mode **37**
- LCD
 - lock lever **16**
 - selecting to display output **51**
 - troubleshooting **74**
- LCD screen
 - handling **18**
- Left **7**
- left button **7**
- lever
 - LCD **16**
- Liquid Crystal Display screen

See LCD

- lithium ion battery
 - disposal **vi**
 - safety precautions **vi**
- loading
 - battery pack **12**

M

- mega-bass switch **23**
- memory
 - adding **61**
- Memory Stick** card slot **8, 24**
- Memory Stick** cards **24, 77**
- microphone **7**
- microphone connector **8**
- modem
 - laws governing **v**
 - troubleshooting **76**
- monitor **47**
 - connecting **50**
 - connector **51**
 - selecting **51**
 - switching among **23**
- mouse
 - troubleshooting **77**
- mouse properties **28**
- MovieShaker instructions **65**
- multiple phone lines **45**

N

- navigation keys **19**
- network
 - connector
 - See Ethernet network connector
- Num Lock **7**
 - indicator light **22**
- numeric keypad area **19**

O

- operator keys **20**
- output devices **iv**
 - adding **49**

P

- parallel port **47, 49**

party phone lines **45**

PBX **45**

PC card

inserting **32**

release button **32**

removing **34**

slot **32**

slot protector **33**

troubleshooting **77**

Type II **32**

phone

connecting line **44**

jack **44**

laws governing **v**

PictureGear **26**

port replicator **8**

connecting **47, 48**

power **22**

indicator light **7**

switch **16**

power saving modes **24, 41**

System Hibernation **23, 42**

System Idle **23, 41**

System Suspend **23, 42**

power sources **11**

connecting **11**

Print Screen key **20**

printer

connecting **49**

connector **47, 49**

port **49**

projector **51**

R

radio interference **iv**

rechargeable battery pack **11, 12**

recharging battery pack **13**

Recovery CDs **3, 80**

removing

battery pack **14**

diskettes **31**

floppy disk drive **31**

restoring data **80**

right button **7**

S

screen

See LCD

Scroll Lock **7**

indicator light **22**

selecting

display **51**

LCD **51**

monitor **51**

power source **11**

Serial connector **47**

setup **5**

Shift key **20**

Shut Down Windows dialog box **17**

Smart Connect **40**

Smart Pad **29**

Software CDs **3**

speakers

built-in **7**

Start button **17**

starting

computer **16**

startup problems **17**

switching

display **23**

monitor **23**

System Hibernation mode **23, 42**

System Idle mode **23, 41**

System Recovery CD(s) **78**

System Suspend mode **23, 42**

T

touchpad **7, 28**

troubleshooting **72–77**

startup **17, 72**

turning on

computer **16**

TV

interference **iv**

U

unpacking the computer **2**

USB connector **9, 30, 57**

USB device **57**

Using the Jog Dial Control **38**

V

VAIO® Action Setup **36**
video camera recorder **55**

W

Windows **98**

- Explorer **21**
- Find window **21**
- Help **21**
- key **20**
- key combinations **21**
- Start button **17**
- taskbar **17, 74**

