

**SONY**

***VAIO® Notebook  
User Guide***

**PCG-XG500/PCG-XG500K/  
PCG-XG700/PCG-XG700K**

© 2001 Sony Electronics Inc.

Reproduction of this manual and the software described herein in whole or in part without written permission is prohibited. All rights reserved. Sony, VAIO, and the VAIO logo are trademarks of Sony.

All other trademarks are trademarks of their respective owners.

## Notice to Users

**Sony Electronics Inc. provides no warranty with regard to this manual, the software, or other information contained herein and information contained herein and hereby expressly disclaims an implied warranties of merchantability or fitness for any particular purpose with regard to this manual, the software, or such other information. In no event shall Sony Electronics Inc. be liable for incidental, consequential, or special damages, whether based on tort, contract, or otherwise, arising out of or in connection with this manual, the software, or other information contained herein or the use thereof.**

Sony Electronics Inc. reserves the right to make any modification to this manual or the information contained herein at any time without notice. The software described herein is governed by the terms of a separate user license agreement.

This product contains software owned by Sony and licensed by third parties. Use of such software is subject to the terms and conditions of license agreements enclosed with this product. Some of the software may not be transported or used outside the United States. Software specifications are subject to change without notice and may not necessarily be identical to current retail versions.

Updates and additions to software may require an additional charge. Subscriptions to online service providers may require a fee and credit

card information. Financial services may require prior arrangements with participating financial institutions.



As an ENERGY STAR Partner, Sony Corporation has determined that this product meets the ENERGY STAR guidelines for energy efficiency.

The International ENERGY STAR Office Equipment Program is an international program that promotes energy saving through the use of computers and other office equipment. The program backs the development and dissemination of products with functions that effectively reduce energy consumption. It is an open system in which business proprietors can participate voluntarily. The targeted products are office equipment such as computers, displays, printers, facsimiles and copiers. Their standards and logos are uniform among participating nations. ENERGY STAR is a U.S. registered mark.

This product incorporates copyright protection technology that is protected by method claims of certain U.S. patents and other intellectual property rights owned by Macrovision Corporation and other rights owners. Use of this copyright protection technology must be authorized by Macrovision Corporation, and is intended for home and other limited viewing uses only unless otherwise authorized by Macrovision Corporation. Reverse engineering or disassembly is prohibited.

Sony, i.LINK, MovieShaker, PictureGear, DVgate, Mavica, Handycam, Jog Dial, Media Bar, VAIO and the VAIO logo are trademarks of Sony Corporation. Microsoft, Windows Me, Windows Media, Windows, Windows NT, and the Windows logo are registered trademarks of Microsoft Corporation. Intel, SpeedStep, and

Pentium are trademarks of Intel Corporation. PS/2 is registered trademark of IBM.

i.LINK is a trademark of Sony used only to designate that a product contains an IEEE 1394 connection. The i.LINK connection may vary, depending on the software applications, operating system and i.LINK-compatible devices. All products with an i.LINK connection may not communicate with each other.

Please refer to the documentation that came with your i.LINK-compatible device for information on operating conditions and proper connection. Before connecting i.LINK-compatible PC peripherals to your system, such as a CD-RW or Hard Disk Drive, confirm their operating system compatibility and required operating conditions.

All other trademarks are trademarks of their respective owners.

## Owner's Record

The model number and serial number are located on the bottom of your Sony VAIO Notebook. Record the serial number in the space provided here. Refer to the model and serial number when you call your Sony Service Center.

Model Number: PCG-861A, PCG-862A, PCG-8612, PCG-8622

Serial Number: \_\_\_\_\_

## Safety Information

### WARNING

- To prevent fire or shock hazard, do not expose your notebook to rain or moisture.
- To avoid electrical shock, do not open the cabinet. Refer servicing to qualified personnel only.
- Never install modem or telephone wiring during a lightning storm.
- Never install telephone jacks in wet locations unless the jack is specifically designed for wet locations.
- Never touch uninsulated telephone wire or terminals unless the telephone line has been disconnected at the network interface.
- Use caution when installing or modifying telephone lines.
- Avoid using the modem during an electrical storm.
- Do not use the modem or a telephone to report a gas leak in the vicinity of the leak.
- A socket outlet should be as close as possible to the unit and easily accessible.



**Caution-** Using optical instruments with this product will increase eye hazard. Do not attempt to disassemble the cabinet because the laser beam used in the product is harmful to the eyes. Refer servicing to qualified personnel only.



To change the backup battery, please contact your nearest Sony Service Center.

For DVD-ROM: Danger - Visible and invisible laser radiation when open. Avoid direct exposure to beam.

For CD-RW: Danger - Drive emits visible and invisible laser radiation when open. Avoid direct exposure to beam.

Caution- Use only No. 26 AWG or larger telecommunication line cord to reduce the risk of fire.

#### AVERTISSEMENT

- ❑ Pour prévenir tout risque d'incendie ou d'électrocution, garder cet appareil à l'abri de la pluie et de l'humidité.
- ❑ Pour prévenir tout risque d'électrocution, ne pas ouvrir le châssis de cet appareil et ne confier son entretien qu'à une personne qualifiée
- ❑ Ne jamais effectuer l'installation de fil modem ou téléphone durant un orage électrique.
- ❑ Ne jamais effectuer l'installation d'une prise téléphonique dans un endroit mouillé à moins que la prise soit conçue à cet effet.
- ❑ Ne jamais toucher un fil téléphonique à découvert ou un terminal à moins que la ligne téléphonique n'ait été débranché de l'interface réseau.

- ❑ Soyez très prudent lorsque vous installez ou modifiez les lignes téléphoniques.
- ❑ Évitez d'utiliser le modem durant un orage électrique.
- ❑ N'utilisez pas le modem ni le téléphone pour prévenir d'une fuite de gaz vous êtes près de la fuite.
- ❑ L'appareil doit être le plus près possible d'une prise murale pour en faciliter l'accès.



Comme le faisceau laser utilisé par cet appareil est dangereux pour les yeux, ne tentez pas de démonter le boîtier. Confiez l'entretien de cet appareil exclusivement au personnel qualifié. Adressez-vous à un agent de service qualifié.

Pour changer la pile de recharge, veuillez contacter votre centre de service Sony le plus près.

Pour les DVD-ROM : DANGER : Radiation laser visible et invisible si ouvert. Évitez l'exposition directe au faisceau.

Pour les CD-RW : Danger : Radiation laser visible et invisible si ouvert. Évitez l'exposition directe au faisceau.

Attention : Afin de réduire les risques d'incendie, n'utilisez qu'un cordon de communication NO. 26 AWG ou plus gros.

If you have questions about this product, you can reach the Sony Customer Information Service Center at 1-888-4SONYPC; or write to the Sony Customer Information Service Center at 12451 Gateway Blvd., Ft. Myers, FL 33913 or find Sony Customer Service on the web at: <http://www.sony.com/pcsupport>.

## Regulatory Information

### Declaration of Conformity

Trade Name:	SONY
Model No.:	PCG-861A PCG-862A PCG-8612 PCG-8622
Responsible Party:	Sony Electronics Inc.
Address:	1 Sony Drive Park Ridge, NJ 07656
Telephone:	201-930-6972
This phone number is for FCC-related matters only.	
This device complies with Part 15 of the FCC rules. Operation is subject to the following two conditions:	
(1) This device may not cause harmful interference, and	
(2) this device must accept any interference received, including interference that may cause undesired operation.	

This equipment has been tested and found to comply with the limits for a Class B digital device, pursuant to Part 15 of the Rules. These limits are designed to provide reasonable protection against harmful interference in a residential installation. This equipment

generates, uses, and can radiate radio frequency energy and, if not installed and used in accordance with the instructions, may cause harmful interference to radio communications. However, there is no guarantee that interference will not occur in a particular installation. If this equipment does cause harmful interference to radio or television reception, which can be determined by turning the equipment off and on, the user is encouraged to try to correct the interference by one or more of the following measures:

- Reorient or relocate the receiving antenna.
- Increase the separation between the equipment and the receiver.
- Connect the equipment into an outlet on a circuit different from that to which the receiver is connected.
- Consult the dealer or an experienced radio/TV technician for help.

You are cautioned that any changes or modifications not expressly approved in this manual could void your authority to operate this equipment.

Only peripherals (computer input/output devices, terminals, printers, etc.) that comply with FCC Class B limits may be attached to this computer product. Operation with non-compliant peripherals is likely to result in interference to radio and television reception.

All cables used to connect peripherals must be shielded and grounded. Operation with cables, connected to peripherals, that are not shielded and grounded, may result in interference to radio and television reception.

### FCC Part 68

This equipment complies with Part 68 of the FCC rules. On the bottom of this equipment is a label that contains, among other information, the FCC equivalence number (REN) for this

equipment. If requested, this information must be provided to the telephone company.

This modem uses the USOC RJ-11 telephone jack.

The REN is used to determine the quantity of devices which may be connected to the telephone line. Excessive RENs on the telephone line may result in the devices not ringing in response to an incoming call. In most, but not all areas, the sum of the RENs should not exceed five (5.0). To be certain of the number of devices that may be connected to the line, as determined by the total RENs, contact the telephone company to determine the maximum REN for the calling area.

If the terminal equipment causes harm to the telephone network, the telephone company will notify you in advance that temporary discontinuance of service may be required. But if advance notice is not practical, the telephone company will notify the customer as soon as possible. Also, you will be advised of your right to file a complaint with the FCC if you believe it is necessary.

The telephone company may make changes in its facilities, equipment, operations, or procedures that could affect the operations of the equipment. If this happens, the telephone company will provide advance notice in order for you to make the necessary modifications in order to maintain uninterrupted service.

If trouble is experienced with this equipment, you can reach the Sony Customer Information Service Center at 1-888-4SONYPC; or write to the Sony Customer Information Service Center at 12451 Gateway Blvd., Ft. Myers, FL 33913 or find Sony Customer Service on the web at: <http://www.sony.com/pcsupport>

Repair of this equipment should be made only by a Sony Service Center or Sony authorized agent. For the Sony Service Center nearest you, call 1-888-4SONYPC (1-888-476-6972).

This equipment cannot be used on public coin service provided by the telephone company. Connection to Party Line Service is subject to state and possible provincial tariffs. (Contact the state or provincial utility service commission, public service commission or corporation commission for information.)

### **Telephone Consumer Protection Act of 1991 (United States)**

The Telephone Consumer Protection Act of 1991 makes it unlawful for any person to use a computer or other electronic device to send any message via a telephone facsimile machine unless such message clearly contains, in a margin at the top or bottom of each transmitted page or on the first page of the transmission, the date and time it is sent and an identification of the business, other entity, or individual sending the message, and the telephone number of the sending machine or such business, other entity, or individual.

In order to program this information into your facsimile machine, see your fax software documentation.

### **Telephone Consumer Guidelines (Canada)**

Please refer to your telephone directory under 'Privacy Issues' and/or 'Terms of Service.' For more detailed information please contact:

CRTC

Terrasses de la Chaudière, Tour centrale 1  
promenade du Portage, 5ième étage Hull PQ  
K1A 0N2.

This Class B digital apparatus complies with Canadian ICES-003.

Cet appareil numérique de la classe B est conforme à la norme NMB-003 du Canada.

## Disposal of Lithium Ion Battery

You can return your unwanted lithium ion batteries to your nearest Sony Service Center or Factory Service Center.



In some areas the disposal of lithium ion batteries in household or business trash may be prohibited.

For the Sony Service Center nearest you call 1-888-476-6972 in the United States or 1-800-961-7669 in Canada.



**Do not handle damaged or leaking lithium ion batteries.**

**Ne pas manipuler les batteries au lithium-ion qui fuient ou sont endommagées.**

**Danger of explosion if battery is incorrectly replaced. Replace only with the same or equivalent type recommended by the manufacturer. Discard used batteries according to the manufacturer's instructions.**

**Une batterie non conforme présente un danger d'explosion. La remplacer seulement par une batterie identique ou de type équivalent recommandé par le fabricant. Évacuer les batteries usées selon les directives du fabricant.**



**The battery pack used in this device may present a fire or chemical burn hazard if mistreated. Do not disassemble, heat above 212°F (100°C) or incinerate. Dispose of used battery promptly. Keep away from children.**

**La manutention incorrecte du module de batterie de cet appareil présente un risque d'incendie ou de brûlures chimiques. Ne pas démonter, incinérer ou exposer à une température de plus de 100°C. Évacuer promptement la batterie usée. Garder hors de portée des enfants.**

## Industry Canada Notice

NOTICE: The Industry Canada label identifies certified equipment. This certification means that the equipment meets certain telecommunications network protective, operational, and safety requirements as prescribed in the appropriate Terminal Equipment Technical Requirements document(s). The Department does not guarantee the equipment will operate to the user's satisfaction.

Before installing this equipment, users should ensure that it is permissible to be connected to the facilities of the local telecommunications company. The equipment must also be installed using an acceptable method of connection.

The customer should be aware that compliance with the above conditions may not prevent degradation of service in some situations.



Repairs to certified equipment should be coordinated by a representative designated by the supplier. Equipment malfunctions or any repairs or alterations made by the user to this equipment may give the telecommunications company cause to request that the user disconnect the equipment.

Users should ensure for their own protection that the electrical ground connections of the power utility, telephone lines, and internal metallic water pipe system, if present, are connected together. This precaution may be particularly important in rural areas.

Caution: Users should not attempt to make such connections themselves, but should contact the appropriate electric inspection authority, or electrician, as appropriate.

NOTICE: The Ringer Equivalence Number (REN) assigned to each terminal device provides an indication of the maximum number of terminals allowed to be connected to a telephone interface. The termination on an interface may consist of any combination of devices subject only to the requirement that the sum of the Ringer Equivalence Numbers of all the devices does not exceed 5. The Ringer Equivalence Number for this equipment is 0.3.

## ***Avis de L'Industrie Canada***

AVIS: L'étiquette d'Industrie Canada identifie le matériel homologué.

Cette étiquette certifie que le matériel est conforme aux normes de protection, d'exploitation et de sécurité des réseaux de télécommunications, comme le prescrivent les documents concernant les exigences techniques relatives au matériel terminal. Le Ministère n'assure toutefois pas que le matériel fonctionnera à la satisfaction de l'utilisateur.

Avant d'installer ce matériel, l'utilisateur doit s'assurer qu'il est permis de le raccorder aux installations de l'entreprise locale de

télécommunication. Le matériel doit également être installé en suivant une méthode acceptée de raccordement.

L'abonné ne doit pas oublier qu'il est possible que la conformité aux conditions énoncées ci-dessus n'empêche pas la dégradation du service dans certaines situations.

Les réparations de matériel homologué doivent être coordonnées par un représentant désigné par le fournisseur. L'entreprise de télécommunications peut demander à l'utilisateur de débrancher un appareil à la suite de réparations ou de modifications effectuées par l'utilisateur ou à cause de mauvais fonctionnement.

Pour sa propre protection, l'utilisateur doit s'assurer que tous les fils de mise à la terre de la source d'énergie électrique, des lignes téléphoniques et des canalisations d'eau métalliques, s'il y en a, sont raccordés ensemble. Cette précaution est particulièrement importante dans les régions rurales.

Avertissement: L'utilisateur ne doit pas tenter de faire ces raccordements lui-même; il doit avoir recours à un service d'inspection des installations électriques, ou à un électricien, selon le cas.

AVIS: L'indice d'équivalence de la sonnerie (IES) assigné à chaque dispositif terminal indique le nombre maximal de terminaux qui peuvent être raccordés à une interface. La terminaison d'une interface téléphonique peut consister en une combinaison de quelques dispositifs, à la seule condition que la somme d'indices d'équivalence de la sonnerie de tous les dispositifs n'excède pas 5. L'indice d'équivalence de la sonnerie de ce matériel est de 0.3.



# Contents

<b>Welcome .....</b>	<b>13</b>
Features .....	13
Unpacking Your VAIO® Notebook .....	14
Ergonomic Considerations .....	17
<b>Setting Up Your VAIO® Notebook .....</b>	<b>23</b>
Locating the Controls and Connectors .....	23
Connecting a Power Source .....	27
Starting Your Notebook .....	34
Shutting Down Your Notebook .....	35
<b>Using Your VAIO® Notebook .....</b>	<b>39</b>
Using the Keyboard .....	39
Replacing a Keycap .....	44
Using the Touchpad .....	46
Using the Floppy Disk Drive .....	48
Using the DVD-ROM or CD-RW Drive .....	53
Using PC cards .....	59
Using Infrared Communication Devices .....	62
Using a Second Battery Pack .....	64
Using the Weight Saver .....	67
Removing the Optional Hard Drive (PCGA-HDX10) .....	68
Using Smart Connect .....	69
Connecting an i.LINK®-compatible Device .....	71

---

\* i.LINK is a trademark of Sony used only to designate that a product contains an IEEE 1394 connection. The i.LINK connection may vary, depending on the software applications, operating system and i.LINK-compatible devices. All products with an i.LINK connection may not communicate with each other.

Please refer to the documentation that came with your i.LINK-compatible device for information on operating conditions and proper connection. Before connecting i.LINK-compatible PC peripherals to your system, such as a CD-RW or Hard Disk Drive, confirm their operating system compatibility and required operating conditions.

VAIO® Action Setup .....	74
Using Power Saving Modes .....	78
<b>Connecting Peripheral Devices .....</b>	<b>81</b>
Connecting a Phone Line .....	82
Using the Mini Docking Station .....	83
Connecting a Printer to Your Computer .....	99
Connecting an External Display .....	100
Connecting External Speakers .....	103
Connecting an External Microphone .....	104
Connecting a Universal Serial Bus (USB) Device (Mouse or Keyboard) .....	105
<b>Adding Memory .....</b>	<b>107</b>
<b>Software Information .....</b>	<b>113</b>
About the Software on Your Notebook .....	113
MovieShaker™ .....	118
PictureGear™ .....	121
For Answers to Your Software Questions .....	123
About Your Recovery CDs .....	125
Using Your Recovery CDs .....	126
<b>Troubleshooting .....</b>	<b>131</b>
Supplemental Information .....	143
Getting Help .....	144
<b>Specifications .....</b>	<b>145</b>
<b>Index .....</b>	<b>149</b>

# Welcome

Congratulations on your purchase of the Sony VAIO® Notebook. Sony has combined leading-edge technology in audio, video, computing, and communications to provide you with state-of-the-art personal computing.

## Features



For a complete description of the specifications of your VAIO® notebook, “Specifications” on page 145.

- ❑ **Exceptional performance** — Your computer includes a Mobile Intel® Pentium® III Processor featuring Intel® SpeedStep™ technology\* and a V.90 compatible K56flex modem.†
- ❑ **Portability** — The rechargeable battery pack provides hours of use without AC power.
- ❑ **Sony audio and video quality** — A high-resolution LCD screen enables you to take advantage of today’s advanced multimedia applications, games, and entertainment software.
- ❑ **Microsoft® Windows® operating system** — Your system includes Windows® Millennium Edition or Windows® 2000 Professional.
- ❑ **Communications** — Access popular online services, send and receive e-mails, browse the Internet, and use the dialing and fax features.
- ❑ **DVD drive** — This new optical storage technology provides increased storage capacity and a rich multimedia computing experience. DVD-ROM drives play both DVD-ROM and CD-ROM discs.
- ❑ **CD-RW drive** — (bundled with select models) This drive is that ideal solution for making backups and archiving data, with the ability to store up to 650 MB‡ of removable, rewritable storage on a single rewritable CD. Save

\* Processor may be reduced to a lower operating speed when operating on battery power.

† Actual upload and download speeds may vary due to line conditions, ISP support, and government regulations.

your movies to CD-R or CD-RW media and share videos and images with family and friends.

## Unpacking Your VAIO® Notebook

Remove the following hardware items from the box:

### Main unit

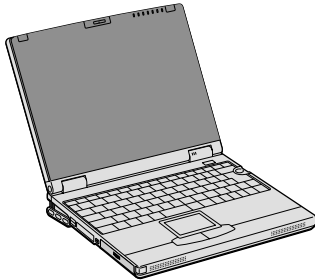

### Power cord

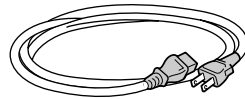

### AC adapter

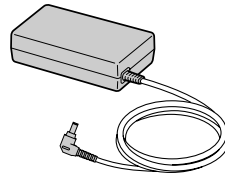

### Floppy disk drive cable

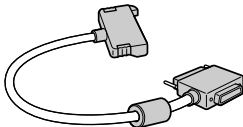

### Rechargeable battery pack

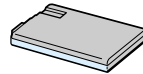

### Weight saver



### Floppy disk drive (FDD)



### DVD-ROM drive or CD-RW drive (CD-RW drive on select models only)

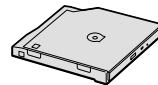

### Mini docking station

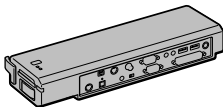

### FDD stand



‡ 530 MB after formatting with Direct CD™

## Manuals

- ❑ **VAIO® User Guide** — Contains information on setting up your notebook, supplementary updates and software information. This manual describes the features and specifications of your notebook, the applications included with your system, how to contact software vendors, and solve common problems.
- ❑ **Microsoft® Windows® Millennium Edition Getting Started manual** or **Microsoft® Windows® 2000 Professional Getting Started manual** — Explains how to use the basic features of this latest Windows operating system.

## Software CDs

- ❑ **Microsoft® Word 2000** — Allows you to reinstall Microsoft Word to the Sony computer you purchased.

## Recovery CDs

- ❑ **System Recovery CD(s)** — Allows you to restore the software titles that shipped with your computer if they become corrupted or are erased. It can be used only to restore the hard disk of the Sony computer you purchased.
- ❑ **Application Recovery CD(s)** — Allows you to reinstall individual applications or device drivers if they are corrupted or erased.
- ❑ **Driver Recovery CD(s)** — Allows you to reinstall individual device drivers. Use it to restore corrupted or erased files.

## Other

- ❑ Setting up your VAIO® Notebook (poster)
- ❑ Packet containing special product offers





## Ergonomic Considerations

You will be using your notebook computer as a portable device in a variety of environments. Whenever possible, you should attempt to apply the following ergonomic considerations to both stationary and portable environments.

### Ergonomic Position

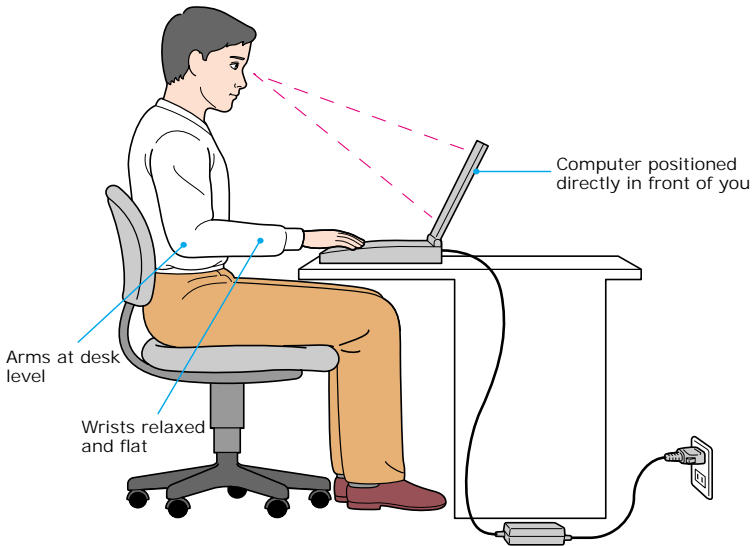

- ❑ **Position of your computer** — Place the computer directly in front of you as you work. Keep your forearms horizontal, with your wrists in a neutral, comfortable position while using the keyboard, touchpad, or external mouse. Let your upper arms hang naturally at your sides. Take breaks during sessions with your computer. Excessive use of the computer may strain muscles or tendons.
- ❑ **Furniture and posture** — Sit in a chair with good back support and armrests. Adjust the level of the chair so your feet are flat on the floor. A footrest may make you more comfortable. Sit in a relaxed, upright posture and avoid slouching forward or leaning far backward.
- ❑ **Viewing angle of the computer's display** — Use the display's tilting feature to find the best position. You can reduce eye strain and muscle

fatigue by adjusting the tilt of the display to the proper position. Adjust the brightness setting of the display also.

- ❑ **Lighting** — Choose a location where windows and lights do not create glare and reflection on the display. Use indirect lighting to avoid bright spots on the display. You can also purchase accessories for your display that help reduce glare. Proper lighting adds to your comfort and work effectiveness.
- ❑ **Placement of an external display** — When using an external display, set the display at a comfortable viewing distance. Make sure the display screen is at eye level or slightly lower when you are sitting in front of the monitor.

### Notes on setup

- ❑ Do not place your computer in a location subject to:
  - ❑ Heat sources, such as radiators or air ducts
  - ❑ Direct sunlight
  - ❑ Excessive dust
  - ❑ Moisture or rain
  - ❑ Mechanical vibration or shock
  - ❑ Strong magnets or speakers that are not magnetically shielded
  - ❑ Ambient temperature of more than 95° F (35° C) or less than 41° F (5° C)
  - ❑ High humidity
- ❑ Do not place electronic equipment near your computer. The computer's electromagnetic field may cause a malfunction.
- ❑ Provide adequate air circulation to prevent internal heat buildup. Do not place your computer on porous surfaces such as rugs or blankets, or near materials such as curtains or draperies that may block its ventilation slots. Leave a space of at least 8 inches (20 cm) behind the back panel of the computer.
- ❑ If the computer is brought directly from a cold location to a warm one, moisture may condense inside your computer. In this case, allow at least an hour before turning on your computer. If any problems occur, unplug your computer, and contact your Sony Service Center.
- ❑ The computer uses high-frequency radio signals and may cause interference to radio or TV reception. Should this occur, relocate the computer a suitable distance away from the set.

- ❑ Use only specified peripheral equipment and interface cables; otherwise, problems may result.
- ❑ Do not use cut or damaged connection cables.
- ❑ If the telephone company makes a service call to your home or office and determines that your computer is responsible for a problem, the telephone company may bill you for the service call. Also, if you do not disconnect your computer when it is adversely affecting the telephone line, the telephone company has the right to disconnect your service until you correct the problem.

### ***Handling your notebook***

- ❑ Clean the cabinet with a soft, dry cloth or a soft cloth lightly moistened with a mild detergent solution. Do not use any type of abrasive pad, scouring powder, or solvent such as alcohol or benzine, as these may damage the finish of your computer.
- ❑ Should any solid object or liquid fall into the computer, shut down your computer and then unplug it. You may want to have the computer checked by qualified personnel before operating it any further.
- ❑ Do not drop the computer or place heavy objects on top of the computer.
- ❑ Make sure to disconnect the power cord before cleaning the computer.
- ❑ Avoid rubbing the LCD screen as this can damage the screen. Use a soft, dry cloth to wipe the LCD screen.

### ***Handling the LCD screen***

- ❑ Do not leave the LCD facing the sun as it can damage the LCD. Be careful when using the computer near a window.
- ❑ Do not scratch the LCD or exert pressure on it. This could cause a malfunction.
- ❑ Using the computer in low temperature conditions may produce a residual image on the screen. This is not a malfunction. When the computer returns to normal temperature, the screen returns to normal.
- ❑ The screen becomes warm during operation. This is normal and does not indicate a malfunction.
- ❑ The LCD is manufactured using high-precision technology. You may, however, see tiny black points and/or bright points (red, blue, or green) that

continuously appear on the LCD. This is a normal result of the manufacturing process and does not indicate a malfunction.

### **Cleaning the display filter**

- 1 Remove the clips on the top of the display before removing the optional display filter as illustrated below.

#### **Display Filter Clips**

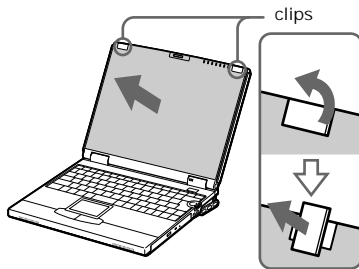

- 2 Hold the display filter by its sides to avoid leaving fingerprints on the display filter.
- 3 Wipe off the fingerprints left on the display filter with the filter cleaner. You can use commercially available cleaners.

 Do not use solvents such as alcohol or thinner, as they may cause damage to the surface of the display filter. When using other chemical solvents, read the instructions thoroughly.

- 4 Insert the bottom of the display filter into the groove at the bottom of the display as illustrated below. Insert the display filter so that the clips' protruding parts face left.
- 5 Turn 90° to lock it in place.

### Installing Display Filter

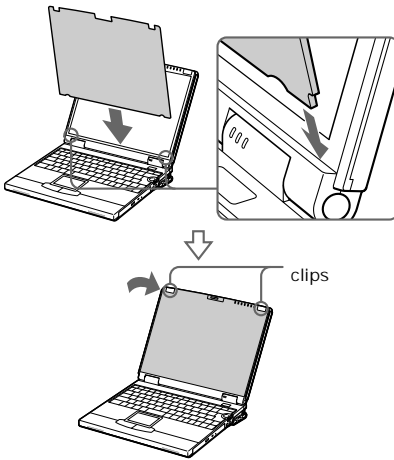

Sony computer supplies, accessories, and peripherals can be purchased from your local retailer or by accessing the Sony VAIO Direct<sup>SM</sup> Website (<http://vaio.sonymstyle.com>), or by calling 1-888-315-7669 (toll free).



# Setting Up Your VAIO® Notebook

This section describes how to start using your computer and how to use your computer's internal and external devices, such as the touchpad, floppy disk drive, and DVD-ROM or CD-RW drive.

## Locating the Controls and Connectors

### Front

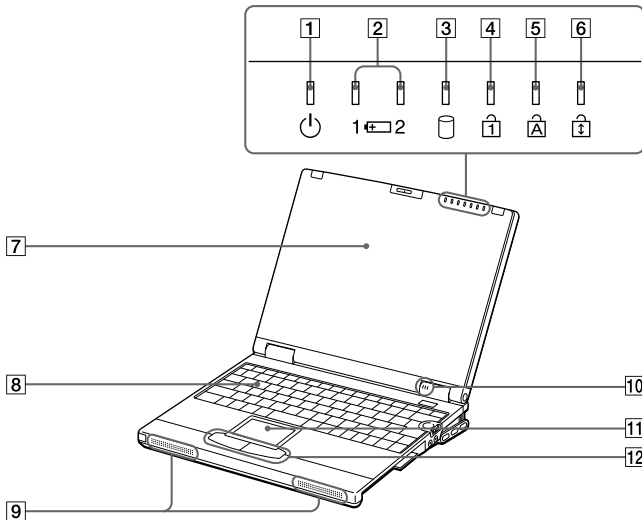

- 
- |          |  |
|----------|--|
| <b>1</b> | <b><i>Power indicator</i></b>            |
| <b>2</b> | <b><i>Battery 1 and 2 indicators</i></b> |
| <b>3</b> | <b><i>Hard disk drive indicator</i></b>  |
| <b>4</b> | <b><i>Num Lock indicator</i></b>         |
| <b>5</b> | <b><i>Caps Lock indicator</i></b>        |
| <b>6</b> | <b><i>Scroll Lock indicator</i></b>      |
-

---

**7**    *LCD (Liquid Crystal Display) screen*

---

**8**    *Keyboard*

---

**9**    *Speakers*

---

**10**   *Internal microphone*

---

**11**   *Touchpad*

---

**12**   *Left and right buttons*

---

**Back**

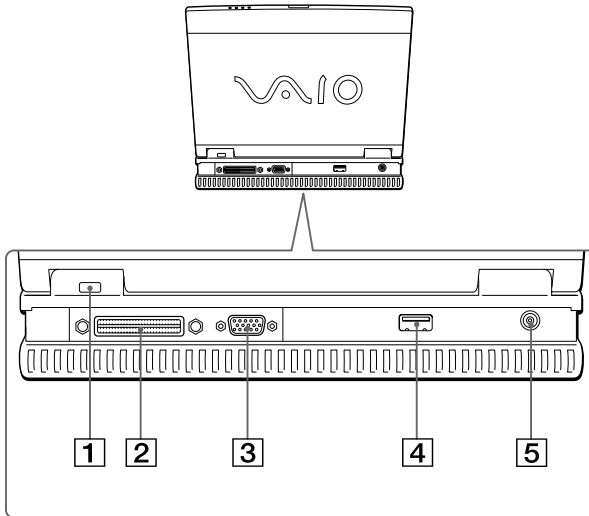

---

**1**    *Infrared port*

---

**2**    *Docking / Floppy disk drive connector*

---

**3**     *Monitor connector*

---

**4**     *USB connector*

---

**5**     *DC In connector*

---



**Left**

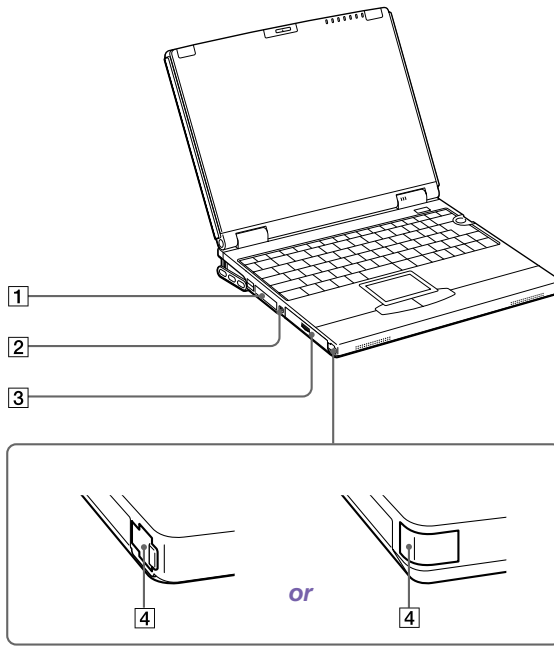

---

**1** *PC card slots*

---

**2** *i.LINK® (IEEE1394) S400 connector\**

---

**3** *Battery bay*

---

**4** *Phone line jack*

---

\* i.LINK is a trademark of Sony used only to designate that a product contains an IEEE 1394 connection. The i.LINK connection may vary, depending on the software applications, operating system and i.LINK-compatible devices. All products with an i.LINK connection may not communicate with each other.

Please refer to the documentation that came with your i.LINK-compatible device for information on operating conditions and proper connection. Before connecting i.LINK-compatible PC peripherals to your system, such as a CD-RW or Hard Disk Drive, confirm their operating system compatibility and required operating conditions.

**Right**

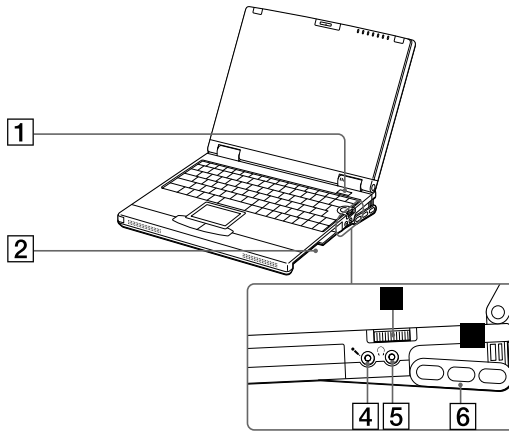

- 1**    *Power button*
- 2**    *Multipurpose bay*
- 3**    *Jog Dial™ control*
- 4**    *Microphone connector*
- 5**    *Headphone connector*
- 6**    *Intercooler flap*

**Bottom**

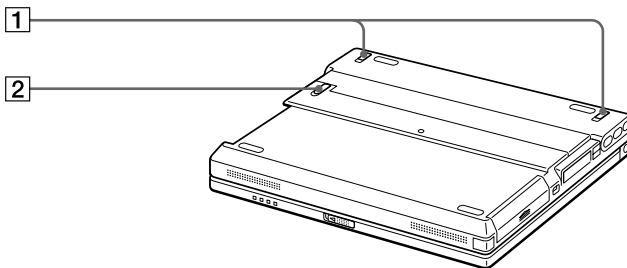

- 1**    *Intercooler flap lever*
- 2**    *Multipurpose bay release lever*

## Connecting a Power Source

You can use either AC power or a rechargeable battery pack as a power source.

### Using the AC Adapter

- 1 Slide the LCD lock lever to your right.
- 2 Open the computer.

### Opening your Computer

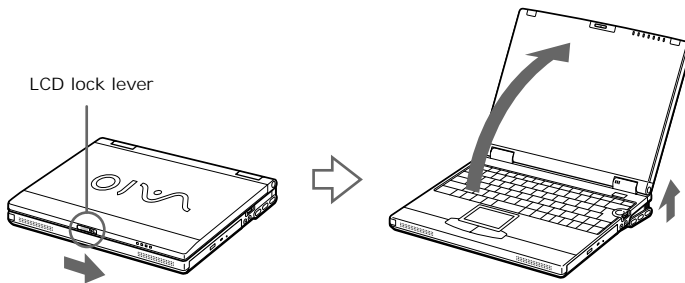

- 3 Plug the cable attached to the AC adapter into the DC In connector on the back of the computer.
- 4 Plug one end of the power cord into the AC adapter.
- 5 Plug the other end of the power cord into an electrical outlet.

## Connecting the AC Adapter

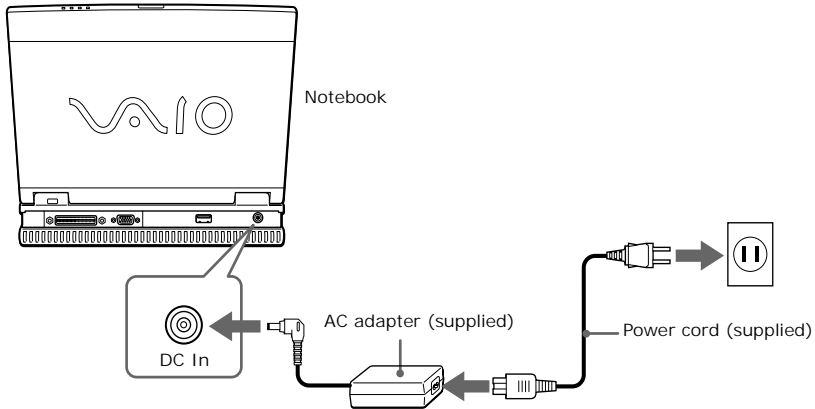

### Notes on the AC Adapter

- ❑ Your computer operates on 100V-240V AC 50/60 Hz.
- ❑ Do not share the AC outlet with other power-consuming equipment, such as a copy machine or shredder.
- ❑ You can purchase a power strip with a surge protector. This device prevents damage to your computer caused by sudden power surges such as those that may occur during an electrical storm.
- ❑ Do not place heavy objects on the power cord.
- ❑ To disconnect the cord, pull it out by the plug. Never pull the cord itself.
- ❑ Unplug your computer from the wall outlet if you will not be using the computer for a long time.
- ❑ When the AC adapter is not used, unplug it from the AC outlet.
- ❑ Use only the AC adapter supplied. Do not use any other AC adapter.

## Using Battery Power

You can use one or two battery packs as a source of power. The second battery pack inserts into the drive bay on the right side of the computer. (See “Using a Second Battery Pack” on page 64.) Additional battery packs are available as a separate option.

The battery pack that comes with your computer is not fully charged at the time of purchase. Follow the steps below to insert and charge the battery pack.

### To insert the battery pack

- 1 Open the cover of the battery bay on the left side of the computer.

#### Battery Bay

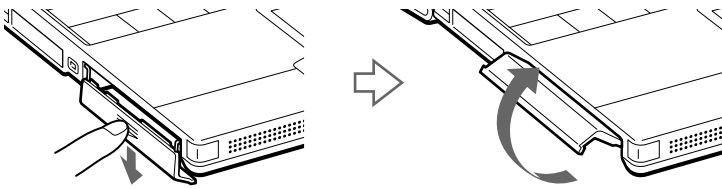

- 2 Insert the battery pack into the battery bay.

#### Inserting Battery Pack

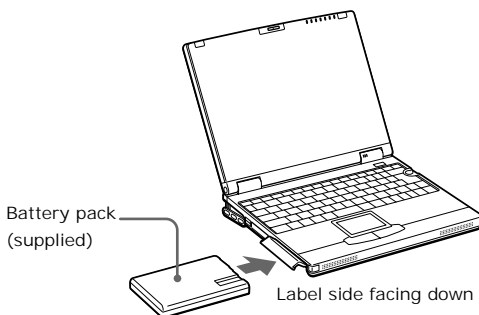

- 3 Close the cover of the battery bay until it clicks.



**If the Mini Docking Station is attached to your computer, do not insert or remove the battery pack. Lifting and turning the computer with the Mini Docking Station attached may cause the Mini Docking Station to disconnect from the computer.**

### To charge the battery pack

- 1 Connect the AC adapter to the computer.
- 2 Insert the battery pack.



The computer automatically charges the battery (the battery indicator light flashes in a double blink pattern as the battery charges).

- 3 When the battery is 85% full, the battery indicator light turns off. This process takes approximately two hours.



To charge the battery completely, continue charging for an additional hour. See “Displaying Detailed Battery Information” on page 152 in the online manual “Customizing Your VAIO® Notebook” .

### Battery Indicators

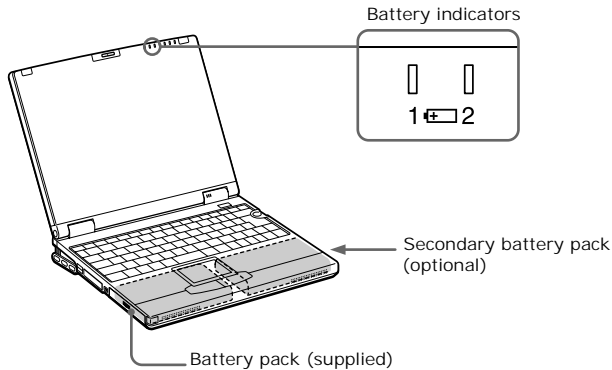

#### Battery Indicator

#### Meaning



Indicates the status of the battery pack in the battery bay on the left side of the computer.



Indicates the status of the battery pack in the drive bay on the right side of the computer.

### Battery Indicator

Light Status	Meaning
On	The computer is using battery power.
Single blink	When BOTH the Battery indicator and Power indicator single-blink, the battery is running out of power.
Double blink	The battery is charging.
Off	The computer is using AC power.

### To remove the battery pack

- 1 Open the cover of the battery bay.
- 2 Pull out the battery pack.

### Removing the Battery Pack

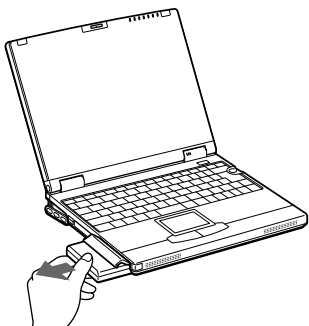

- 3 Close the cover of the battery bay.



**You will lose data if you remove the battery pack while the computer is on and not connected to the AC adapter or if you remove the battery while the computer is in power saving mode.**

### Notes on battery

- To determine the remaining battery charge, see “Displaying Battery Information” in the online manual “*Customizing Your VAIO® Notebook*” .
- When the battery is running out of power, both the battery indicator light and power indicator light blink.



- ❑ When the computer is directly connected to AC power and a battery pack is in the battery bay, it uses power from the AC outlet.
- ❑ Keep the battery pack in the computer while it is directly connected to AC power. The battery pack continues to charge while you are using the computer.
- ❑ If the battery level falls below 10%, you should either attach the AC adapter to recharge the battery or shut down your computer and insert a fully-charged battery.
- ❑ You can extend battery life by changing the power management modes in the Power Management utility. See “Using Power Saving Modes” on page 78.
- ❑ The battery pack supplied with your computer is a lithium-ion battery and can be recharged at any time. Charging a partially discharged battery does not affect battery life.
- ❑ For some software applications and some peripheral devices, your computer may not enter System Hibernation mode when the battery life is low. To avoid loss of data when using battery power, you should save your data frequently and manually activate a power management mode, such as System Suspend or System Hibernation.
- ❑ Never leave the battery pack in temperatures above 140° F (60° C), such as under direct sunlight or in a car parked in the sun.
- ❑ Battery life is shorter in a cold environment. This is due to decreased battery efficiency at low temperatures.
- ❑ Charge the batteries at temperatures between 50° F and 80° F (10° C to 30 °C). Lower temperatures require a longer charging time.
- ❑ While the battery is in use or being discharged, the battery pack heats up. This is normal and is not cause for concern.
- ❑ Keep the battery pack away from all sources of heat.
- ❑ Keep the battery pack dry.
- ❑ Do not open or try to disassemble the battery pack.
- ❑ Do not expose the battery pack to any mechanical shock.
- ❑ If you are not using the computer for an extended period of time, remove the battery pack from the computer to prevent damage to the battery.

- ❑ If, after fully charging the battery pack, the battery power is still low, the battery pack may be reaching the end of its life and should be replaced.
- ❑ If you have not used the battery pack for a considerable amount of time, recharge the battery.

## Starting Your Notebook

- 1 Slide the LCD lock lever in the direction of the arrow, and lift the cover.

### Opening the Computer

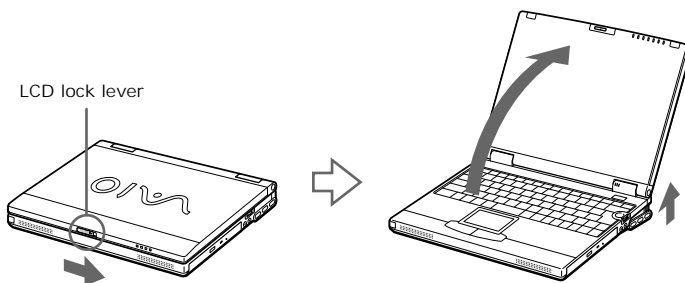

- 2 Press the power button of the computer until the green power indicator light turns on.



#### **Windows® Millennium Edition (Windows Me™) Only**

**When starting your notebook for the first time, the VAIO InitManager dialog box will appear. Please select "OK" to begin initial setup. If you do not execute the initial setup, you cannot use part of VAIO original hardware functions such as Jog Dial, Power Management tool, scroll function of touchpad, and keyboard shortcut key function combined with the Fn key.**

## Power Button

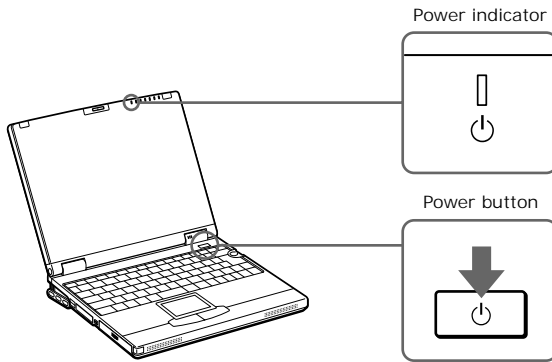

 If you press the power button for more than four seconds, the computer turns off.

- 3 If necessary, adjust the brightness controls for the LCD display:
  - Decrease brightness, press Fn+F5 and then the down or left arrow key.
  - Increase brightness, press Fn+F5 and then the up or right arrow key.



**When connecting the supplied AC adapter to an AC outlet that has more than two outlets, do not plug the AC adapter into an outlet that is obstructed by another adapter. To prevent fire or electrical shock, the adapter must be firmly plugged into the outlet. If necessary, use a separate AC outlet.**

## Shutting Down Your Notebook



**To avoid potential loss of data, follow these steps to shut down your computer.**

- 1 Click the Start button on the Windows taskbar.
- 2 Click Shut Down at the bottom of the Start menu to display the Shut Down Windows dialog box.
- 3 Select Shut down.

4 Click OK.



Respond to all prompts that warn you to save your documents.

5 Wait for your computer to turn off automatically. The power indicator (green) turns off.

6 Turn off any peripherals connected to your computer.



During a period of inactivity, you can conserve battery life by using System Suspend mode. See “System Suspend Mode” on page 78.

***If you are unable to shut down your computer:***

1 Close or end all operations by:

- Closing all applications.
- Removing the PC cards.
- Disconnecting USB devices.
- Ending Infrared Communication.

2 Restart the computer. You can restart your computer by pressing Ctrl+Alt+Delete keys (at the same time).



**If you are still unable to shut down the computer, you can press the power button and hold it for four seconds. This operation may result in data loss.**

## Closing your computer

### Close the front panel

- 1 Hold the clip on the left top of the front panel.



If you touch the LCD screen, you will leave fingerprints on the LCD screen.

- 2 Move the panel in direction of arrow. Completely close the front panel and locked in place.

### Front Panel

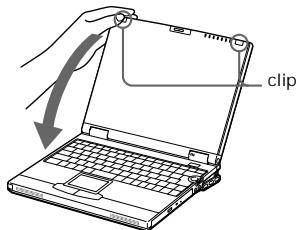

### Close the intercooler flap

 The intercooler flap does not close automatically. You must disconnect all devices, such as the AC adapter or monitor, which are connected to the back of the computer before closing the intercooler flap.

- 1 Grasp both sides of the flap while sliding the levers with your thumbs.

#### Intercooler Flap

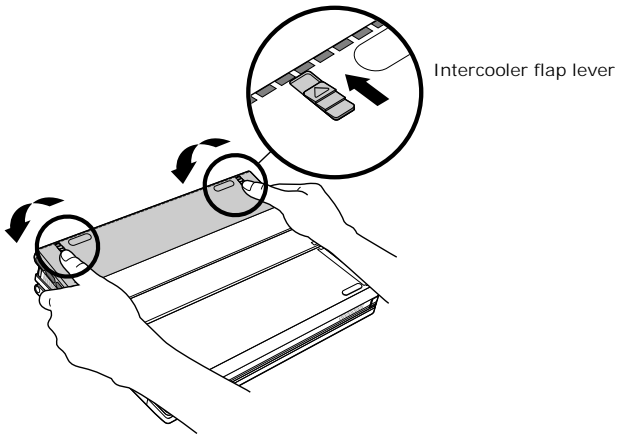

# Using Your VAIO® Notebook



## Using the Keyboard

Your keyboard is very similar to a typewriter's, but the keyboard has additional keys that perform specific computer-related tasks.

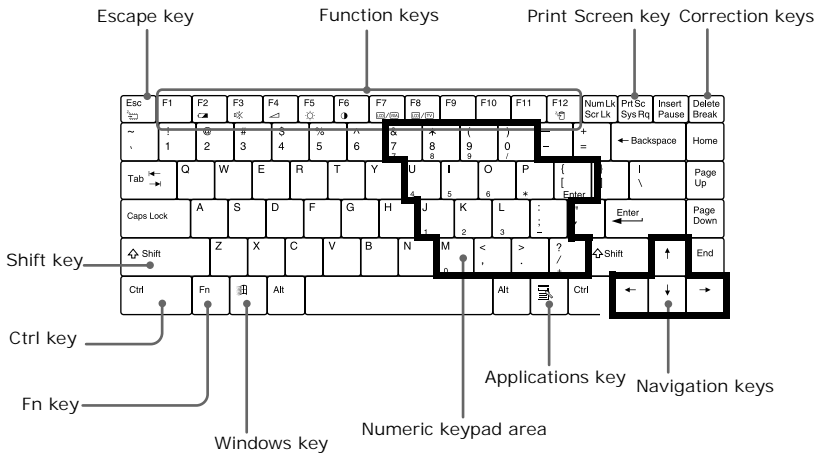
### Keyboard



If the keycap comes off, put it back in its place and push down gently until it clicks into place. If the Enter key, Space key or Shift key comes off, see “Replacing a Keycap” on page 44. Do not take off the keycaps intentionally or push excessively when replacing them, as this may cause the unit to malfunction.





<i>Key</i>	<i>Description</i>
Numeric keypad area	Contains the keys found on a typical calculator. Use the numeric keypad area to type numbers or to perform mathematical calculations such as addition and subtraction. Note: you must press the Num Lock key to activate the numeric keypad. (When you do so, the Num Lock light will be on.)
Navigation keys	Several keys are devoted to moving the cursor on the screen.
Correction keys	The Insert, BackSpace, and Delete keys enable you to make corrections in your documents.
Function keys	The twelve function keys along the top of the keyboard are used to perform designated tasks. For example, in many applications, F1 is the Help key. The task associated with each function key may vary from one application to the next.
Escape key	The Esc (Escape) key is used to cancel commands.
Print Screen key	The Print Screen key takes an electronic snapshot of the screen and places it in the Windows Clipboard. You can then paste the screen shot into a document and print it.
Operator keys	Several keys are always used with at least one other key: Ctrl, Alt, and Shift. When held down with another key, the Ctrl (Control) and Alt (Alternate) keys offer another way to give commands. For example, in many applications, instead of choosing the Save command from a menu, you can hold down Ctrl and press S (referred to as Ctrl+S). The Shift key operates the same way as on a typewriter; it is used to produce capital letters or special symbols such as @ and \$.
Windows key 	The key with the Windows logo displays the Windows Start menu; it is the equivalent of clicking the Start button on the taskbar. See “Combinations and Functions with the Windows Key” on page 41.
Fn key	The Fn key is used in combination with other keys to issue commands. See “Combinations and Functions with the Fn Key” on page 43.
Applications key 	The Applications key displays a shortcut menu of context-sensitive choices. Pressing this key is the equivalent of clicking the right mouse button.





















## Combinations and Functions with the Windows Key

<b>Combination</b>	<b>Function</b>
⊞ + F1	Displays Windows Help.
⊞ + Tab	Switches the selected button on the taskbar.
⊞ + E	Displays Windows Explorer.
⊞ + F	Displays the Windows Find: All Files window to find a file or folder. This is the equivalent of selecting Find and then Files or Folders from the Start menu.
⊞ + Ctrl + F	Displays the Windows Find: Computer window where you can locate other computers. This is the equivalent of selecting Find and then Computer from the Start menu.
⊞ + M	Minimizes all displayed windows.
Shift + ⊞ + M	Returns all minimized windows to their previous size.
⊞ + R	Displays the Run window. This is the equivalent of selecting Run from the Start menu.
Fn + ⊞ + Insert	Displays the Properties window. This is the equivalent of double-clicking the System icon in the Control Panel.

## Indicators

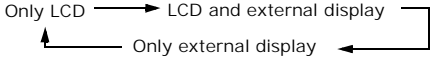
<i>Indicator</i>	<i>Function</i>	
Power 	Light is green when the power to the computer is turned on. Light is amber in System Idle mode, and flashes amber in System Suspend mode. Turns off when the computer is in System Hibernation mode or powered off.	
Battery 1 1 	Indicates the status of the battery inserted in the battery bay on the left side of the computer.	
Battery 2  2	Indicates the status of the battery inserted in the drive bay on the right side of the computer.	
Hard disk 	Lights when data is being read from or written to the hard drive. Do not enter System Suspend mode or turn off the computer when this indicator light is on.	
<i>Light</i>	<i>On</i>	<i>Off</i>
Num Lock	The number keys in the numeric keypad are active.	The alphanumeric character keys in the keypad area are active.
Caps Lock	The letters appear in uppercase as you type. The Shift key lowers the case of typed letters when Caps Lock is on.	Letters appear in lower case as you type (unless you hold down the Shift key).
Scroll Lock	The screen scrolls differently. (Exactly how it scrolls depends on the specific application. It has no effect in many applications.)	Information moves across the display normally.

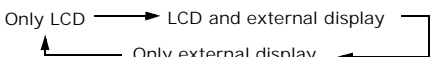
## Combinations and Functions with the Fn Key

Combinations/Feature	Function
Fn+  (ESC) System Suspend	Puts the system into System Suspend mode, a power management state. To return the system to the active state, press any key or press the power switch on your computer.
Fn+  (F3) Mute On/Off	Toggles the built-in speaker off and on.
Fn+  (F4) Speaker volume	Adjusts the built-in speaker volume. To increase volume, press Fn+F4, then  or  . To decrease volume, press Fn+F4, then  or  .
Fn+  (F5) Brightness control	Adjusts the brightness of the LCD. To increase light intensity, press Fn+F5 and then  or  . To decrease light intensity, press Fn+F5 and then  or  .
Fn+  /  (F7) Switch to the external display/LCD	Toggles through the LCD, external display (connected to the  ) and both LCD and external display.
	
Fn+  /  (F8) Switch to the external display/LCD	Toggles through the external display connected to an optional Mini Docking Station (PCGA-PSX1) and the LCD.
	
Fn+  (F12) System Hibernation	Provides for the lowest level of power consumption. When you execute this command, the state of the system and state of the peripheral devices are written to the hard disk and the system power is turned off. To return the system to the original state, use the power button to turn on power.
Fn+D Video Standby	Turns off the LCD to save power. To turn the LCD back on, press any key.
Fn+S System Idle	Puts the system into System Idle mode, a power management state. To return the system to the active state, press any key.



You can carry out these functions using the Jog Dial control. See “Using the Jog Dial Control” on page 75 for more information.

Some functions are not available until Windows launches.

## Replacing a Keycap

Replace the Enter keycap, Shift keycap and Space keycap as described below. For other keys, place the keycaps in their original place and gently push down until they click.

### To replace the enter key

#### Enter Key Back

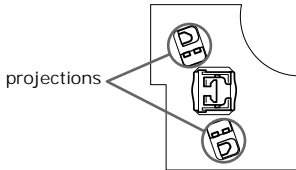

#### Attaching Enter Key

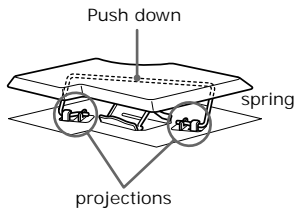

## To replace the shift or space key

### Back

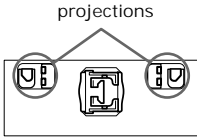

### Attaching the Shift or Space Key

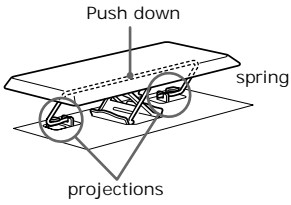

Do not use force to remove the keycaps as this may result in a malfunction.

Do not push too hard on the keycaps when placing them.

## Using the Touchpad

The keyboard contains a cursor-pointing device called a touchpad. You can point to, select, drag, and scroll objects on the screen using the built-in touchpad.

### Using the Touchpad

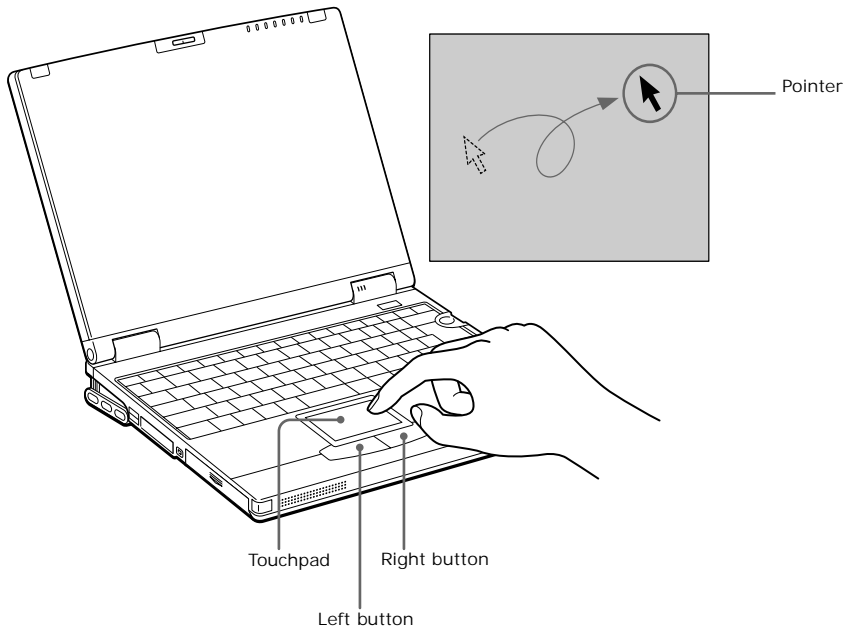

<b>Action</b>	<b>Description</b>
Point	Slide one finger on the touchpad to place the pointer on an item or object.
Click	Press the left button once.
Double-click	Press the left button twice.
Right-click	Press the right button once. In many applications, this action displays a shortcut menu of context-sensitive choices.
Drag	Slide one finger while pressing the left button.
Scroll	Move your finger along the right edge of the touchpad to scroll vertically. Move your finger along the bottom to scroll horizontally. (The scroll function is available only with applications that support a touchpad scroll feature.)



See Mouse Properties for information on touchpad features, such as clicking both buttons simultaneously, adjusting touchpad speed, and Easy Launcher functions. To access Mouse Properties, click the Start button, point to Settings, point to Control Panel, and then click the Mouse icon in the Control Panel.

## Using the Floppy Disk Drive

You can use the supplied floppy disk drive either as an external drive or as an internal drive in the drive bay.

To ensure proper operation, do not insert or remove the disk drive when the computer is in power saving mode.

### To use as an external drive

Connect the floppy disk drive to the computer using the floppy disk drive cable (supplied) with the VAIO logo facing up.

### Connecting Floppy Disk Drive

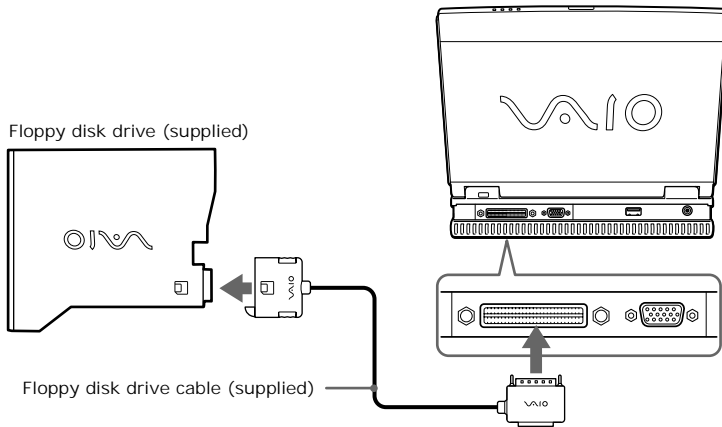

Align the logo on the cable with the slot connection and insert the connector straight into the slot.

 While using the floppy disk drive, do not put the system into power saving mode. Power saving mode may not work properly and unsaved data may be lost.



### To use as an internal drive

- 1 If another device is in the multipurpose bay, remove the device. See “To remove the second battery pack” on page 66.
- 2 Insert the floppy disk drive into the multipurpose bay with the VAIO logo facing up. Continue pushing the drive into the bay until the RELEASE lever locks into place.

### Inserting Floppy Disk Drive

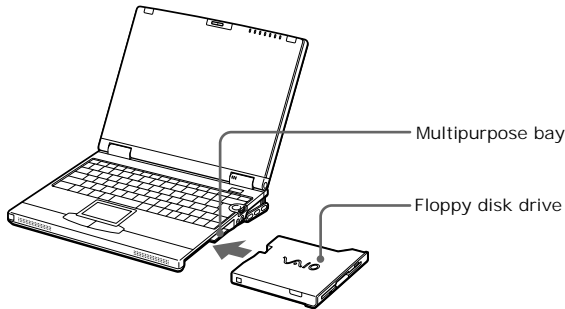

 Do not insert the floppy disk drive while the notebook is in power saving mode.

### To insert a diskette

 You can insert a floppy disk, even if the LED indicator is on.

If there is another drive in the multipurpose bay, click on the power icon in the system task tray and choose “Remove multi-purpose bay device [IDE]”.

- 1 Hold the diskette with the label side facing up.
- 2 Gently push the diskette into the drive until it clicks into place.

### Inserting Diskette

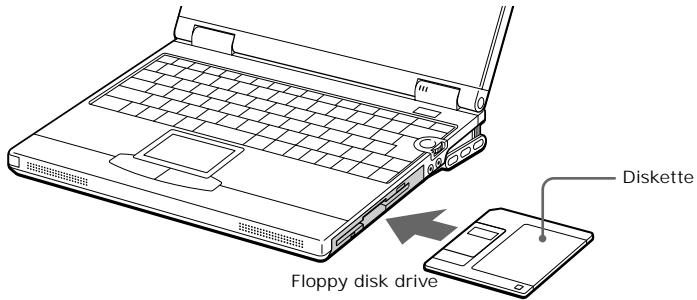

### To remove a diskette

- When you finish using the diskette, wait until the LED indicator turns off and then press the Eject button to remove the diskette.

### Ejecting Diskette

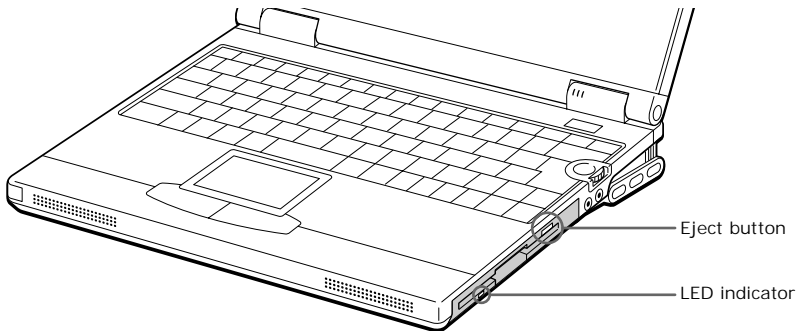

 Do not press the Eject button when the LED indicator is turned on, as data may be lost.

### **Handling Diskettes**

- Do not open the shutter manually and touch the surface of the diskette.
- Keep diskettes away from magnets.
- Keep diskettes away from direct sunlight and other heat sources.

### **To remove the floppy disk drive**

When the computer is off, skip steps 1 and 3.

- 1** Right-click the Power Management icon  in the system task tray and choose “Remove multipurpose bay device [FDD]” when using an internal drive. When using an external drive, choose “Remove external FDD” instead.
- 2** Slide the RELEASE lever on the bottom of the computer in the direction of the arrow and slide the drive out of the multipurpose bay.
- 3** Click OK on the message screen.

### **To remove the floppy disk drive using the Jog Dial™ control (Windows Me models only)**

- 1** Rotate the Jog Dial control to PowerPanel, and then press the Jog Dial control. The PowerPanel window appears.
- 2** Rotate the Jog Dial control to Multipurpose Bay Drive, and then press the Jog Dial control.

To remove an external floppy disk drive, select External floppy disk drive, and then press the Jog Dial control.

The Device Swapping window appears. Remove the drive, and click OK.

 Note: If your computer is turned off, you do not have to follow these instructions.

### Removing Floppy Disk Drive

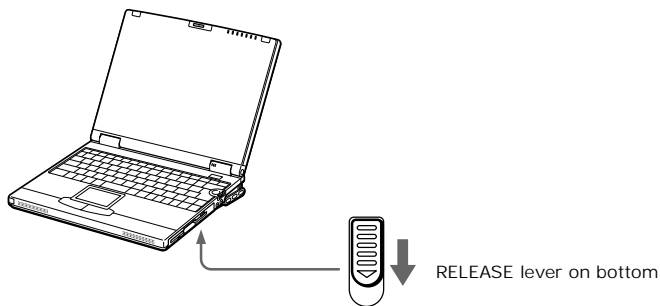

When the multipurpose bay is empty, attach the weight saver to it. See “Using a Second Battery Pack” on page 64 for details on attaching the weight saver.

### To remove the floppy disk drive (Windows 2000 models only)

 If your computer is turned off, you do not have to follow these instructions.

- 1 Double-click the Power Management icon  in the system task tray.
- 2 The “Unplug or Eject” dialog box appears.
- 3 In the Unplug or Eject Hardware dialog box, select the appropriate option, and then click Stop.
- 4 Confirm the device and click OK.
- 5 A message appears informing you that the device can now be safely removed from the system.
- 6 Slide the RELEASE lever on the bottom of the computer in the direction of the arrow, and then unplug the floppy disk drive from the computer.

## Using the DVD-ROM or CD-RW Drive

Your computer comes with a DVD-ROM or CD-RW drive. The CD-RW drive is supplied with select models only.



When the computer is in power saving mode, you cannot insert a disc. See “Controlling Power Management” on page 147 in the online manual “*Customizing Your VAIO® Notebook*” for more information on power saving modes.

### To insert a disc

- 1 Turn on the computer.
- 2 Press the Eject button to open the DVD-ROM or CD-RW drive.  
The tray slides out.

### Opening the DVD-ROM or CD-RW drive

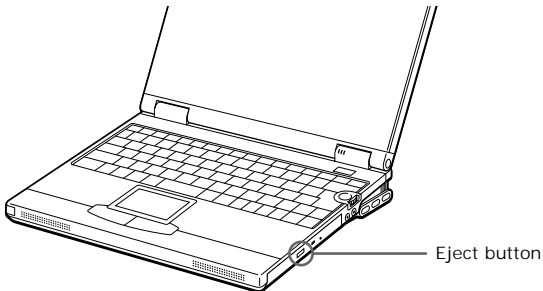

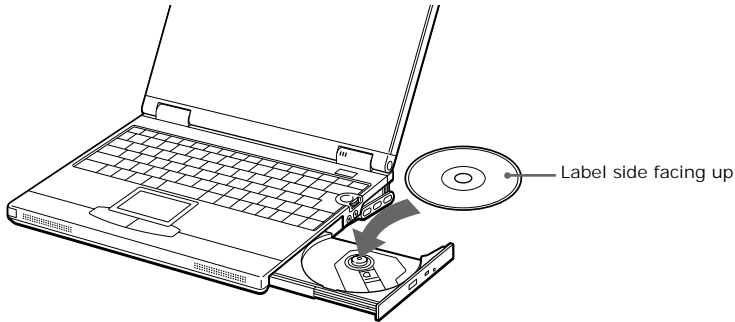

- 3 Place a DVD or CD in the tray with the label side facing up. For DVDs, which can be played on both sides, the side of the disc facing up is the side that plays. Push the disc onto the hub until the disc clicks into place.

### Inserting a DVD or CD



- 4 Close the tray by pushing it gently.

 Do not put the system into power saving mode while using the DVD-ROM or CD-RW drive in the multipurpose bay. When the computer is in this mode, you cannot remove a disc. Also, this mode may not work properly causing unsaved data to be lost. See “Controlling Power Management” on page 147 in the online manual “*Customizing Your VAIO® Notebook*” for more information about power saving modes.

 Be sure to seat the disc firmly over the DVD-ROM or CD-RW drive hub fingers. If you do not seat the disc firmly, you could damage your DVD-ROM or CD-RW drive and you may not be able to open the tray.

When you finish using a disc, wait until the LED indicator light turns off, then press the Eject button to remove the disc.

If the disc does not come out when you press the Eject button, turn the computer off and insert a thin, pointed object into the manual eject hole.

### Manual Eject Hole

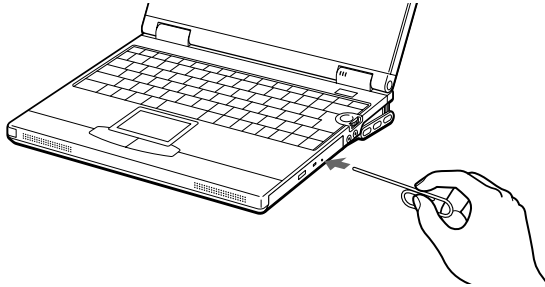

### To play a DVD

When you play DVDs on a television connected to the Mini Docking Station (PCGA-PSX1), a part of the video screen will not appear with the factory setting. Adjust the display resolution to 640 x 480 as described in “Selecting the Display Mode” on page 154 in the online manual “*Customizing Your VAIO® Notebook*” .

 When playing DVD movies on battery power, set the Power Management profile to DVD profile. With other profiles, the movies are choppy. As an alternative, you can set the Power Management profile to Automatic Profile Selection, which will select the DVD profile automatically whenever you insert a DVD. See “Controlling Power Management” on page 147 in the online manual “*Customizing Your VAIO® Notebook*” for information on how to set the Power Management profile.

 Do not switch the Display Mode or the power saving mode while you are playing a DVD.

Before you play the DVD, change the settings to disable the screen saver and the virus checker (if it is active).

Refrain from using any resident utilities to speed up disc access because this may cause the system to malfunction.



**Some discs recorded at 20 or 24 bits may produce noise while playing. If you have audio devices connected, this may cause damage to your hearing and the speakers. Reduce the volume before playing such discs.**

**You cannot switch between LCD and TV if you press Fn+F8 when a DVD or CD is inserted in the DVD-ROM or CD-RW drive.**

### ***To write to a CD-RW or CD-R (For models with a CD-RW drive)***

If you use DirectCD™ to write data, you must first format the disc before writing on a new CD-RW or CD-R. If you do not format the disc, your computer will not recognize it.



If you use Easy CD Creator™ to write data to a CD-RW or CD-R, you do not have to format the disc.

To make a CD-R to which data has been written readable on a CD-ROM drive, you need to complete the disc when you eject it. To complete this process, follow the instructions included with your software.



For optimal writing speed, deactivate the screen saver and exit anti-virus software before writing data to a disc.

For best results, use CD-Rs that are compatible with 4x speed, as DirectCD™ and Easy CD Creator™ are preset to that speed. Your notebook does not support 1x writing speed. If you use CD-RW or CD-R writing software other than DirectCD™, use PowerPanel to select the DVD Profile. Memory-resident disc utilities may cause unstable operation or data loss. Deactivate these utilities before writing data to a disc.

When using Easy Creator™ Standard, be sure to close and exit all other applications.

If your notebook computer has preinstalled Microsoft® Office applications, such as Excel, Word, and Outlook, turn off the FindFast application.

Do not put your notebook into power saving mode while using DirectCD™ to write data, or while using Easy CD Creator™.





Never touch the surface of the disc. Fingerprints and dust on the surface of a disc may cause writing errors.

Do not strike or shake the computer while writing data to a disc.

Always use the AC adapter as the power source for your computer when you are writing data to a CD-RW or CD-R. Using battery power may result in data transfer failure.

### *To remove the DVD-ROM or CD-RW drive*



If your computer is turned off, do not follow these instructions.

- 1 Right-click the Power Management icon  in the system task tray and choose “Remove multipurpose bay device [IDE].” A message appears informing you that the device can now be safely removed from the system.
- 2 Slide the RELEASE lever on the bottom of the computer in the direction of the arrow. Then slide the DVD-ROM or CD-RW drive out of the multipurpose bay.
- 3 Click OK on the message screen.

### *To insert the DVD-ROM or CD-RW drive*



Be sure to insert the weight saver into the multipurpose bay when the bay is empty. See “To insert a second battery pack” on page 64 for details on inserting the weight saver.

You do not need to shut down the computer to insert the DVD-ROM or CD-RW drive into the multipurpose bay.

### Inserting DVD-ROM or CD-RW drive

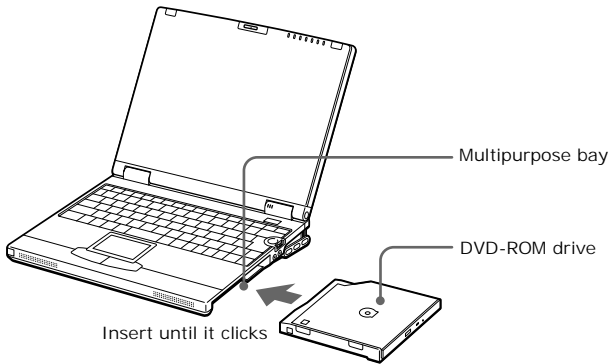

### Notes on CD and DVD media

#### Handling CD and DVD media

- ❑ Do not touch the surface of the disc.
- ❑ Do not drop or bend the disc.

#### Cleaning CD and DVD media

- ❑ Fingerprints and dust on the surface of a disc may cause read errors. Proper care of the disc is essential to maintain its reliability. Do not use solvents such as benzine, thinner, commercially available cleaners or anti-static spray, as they may cause damage to the disc.
- ❑ For normal cleaning, hold the disc by its edge and use a soft cloth to wipe the surface from the center out.
- ❑ If the disc is badly soiled, moisten a soft cloth with water, wring it out well, and use it to wipe the surface of the disc from the center out. Wipe off any remaining moisture with a dry, soft cloth.

## Using PC cards

Your computer includes two PC card slots. PC cards allow you to connect portable external devices, such as another hard disk drive, or to connect a network.



The PC card slots can accommodate two Type II PC cards, or one Type III PC card. These slots are compatible with Card Bus. Use the lower slot for Type III PC cards. You do not need to shut down your notebook before inserting or removing a PC card.

### To insert a PC Card

Use the lower slot for Type III PC cards.

- 1 Pull the PC card RELEASE button away from the computer, and then push it in toward the computer.

### PC Card Release Button

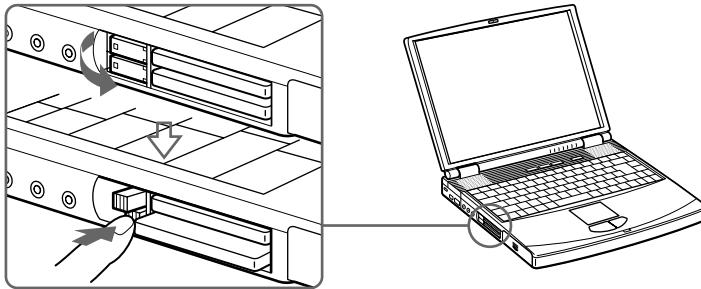

- 2 Remove the PC card slot protector.
- 3 When you use a Type III PC card, you need to remove both the top and bottom PC card slot protectors.

### Removing PC Card Slot Protector

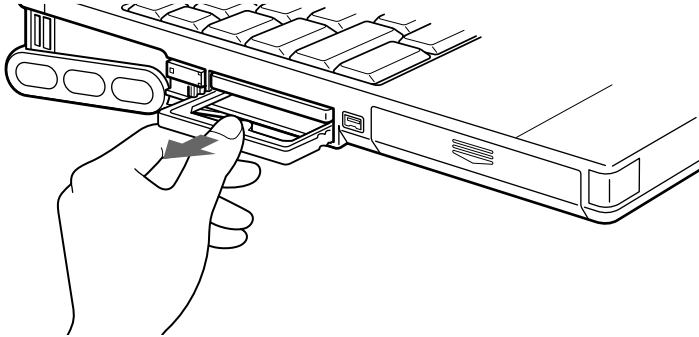

- 4 Insert the PC card into the PC card slot with the front label facing up. Gently push the card into the slot until the card is fixed into the connector. The RELEASE button comes out. Push down the RELEASE button toward the display panel.

### Inserting PC Card

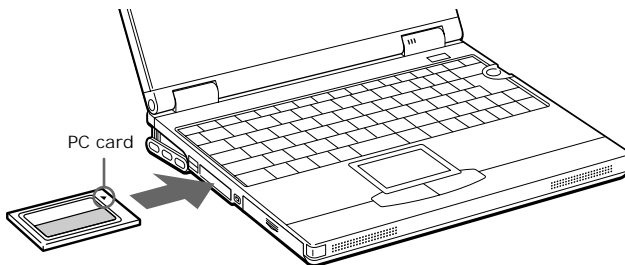

 Do not force a card into the slot, as this may damage the connector pins. If you have difficulty inserting a card, check that you are inserting the card with the correct orientation. See the manual that came with your PC card for more information on use.

For some PC cards, if you alternate between normal power operation and the System Suspend or System Hibernation power management modes while the card is inserted, you may find that a device connected to your system is not recognized. Restart your system to correct the problem.

### To remove a PC card

 If your computer is turned off, you do not have to follow these instructions.

- 1 Double-click  in the system task tray.
- 2 The “Unplug or Eject hardware” dialog box appears.
- 3 In the Unplug or Eject Hardware dialog box, select the appropriate option, and then click Stop.
- 4 Confirm the device and click OK.
- 5 A message appears informing you that the device can now be safely removed from the system.
- 6 Press the PC card RELEASE button to remove the PC card.

### Removing the PC Card

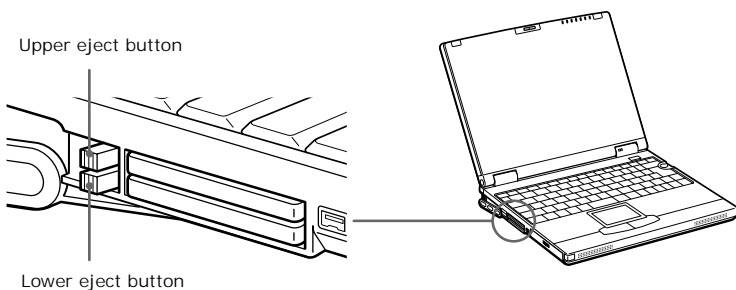

- 7 Insert the PC card slot protector back into the empty slot.

## Using Infrared Communication Devices



**When using longer PC cards (Wireless LAN card, etc.) do not move your computer while a PC card is inserted. If the PC card gets a strong shock, your computer may be damaged.**

**Do not use force to insert your PC card as it may damage your computer.**

Your computer includes an infrared port, located on the left side. You can use this port to communicate with other infrared-equipped devices with compatible protocols, such as a digital still camera or other computers.

### *To use infrared communication with another computer*

Align the infrared ports on the two computers so that they are in a direct line.

#### *Connecting with Infrared*

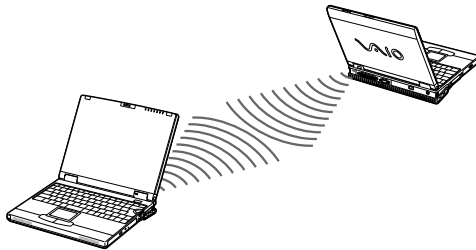

 Infrared communication capability can be turned on and off. By default, it is disabled when your system is shipped. To enable infrared use, click the infrared icon in the Windows Control Panel and select the Enable infrared communication checkbox on the Options tab.

You can disable infrared communication when you are not using it to conserve battery life.

Use the infrared icon in the Windows Control Panel to enable and disable infrared communication. Do not use the icon in the taskbar.

Check the Status tag of the Infrared Monitor in the Windows Control Panel to determine if the infrared device is detected.

If the two devices are too far apart or too close together, data transfer may be interrupted or there may be noise in the transmission.

Do not cover the infrared ports with your hand or any other object.

Avoid direct sunlight, fluorescent light, or flashing incandescent light near the infrared ports.

See the manual that came with your digital still camera or other infrared communication device for more information on installation and use.

The active area of infrared transmission extends about 39 <sup>3</sup>/<sub>8</sub> inches (1 meter) with an approximate radius of 15 degrees.

### Infrared Range

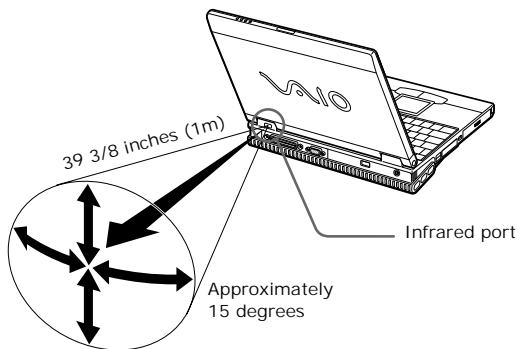

## Using a Second Battery Pack

You can purchase a second rechargeable battery pack. With two battery packs, you can extend the time that you use your computer with battery power. When using two battery packs, the battery pack you insert first charges first. The battery pack you insert second charges when the first battery pack is 85% full. You can monitor which battery pack is charging by observing the battery indicator lights.

### To insert a second battery pack

- 1 If another device is in the multipurpose bay, remove the device. See “To remove the DVD-ROM or CD-RW drive” on page 57.
- 2 Insert the battery pack into the multipurpose bay.  
If the battery is being used, the battery 2 indicator light turns on.

### Inserting Second Battery Pack

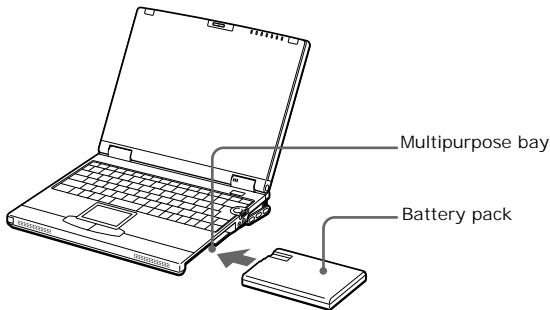

- 3 Attach the weight saver to the computer to stabilize the battery pack.  
Insert the tab of the weight saver into the hollow of the multipurpose bay slot, and then push the weight saver into the multipurpose bay until it clicks.



### Attaching Weight Saver

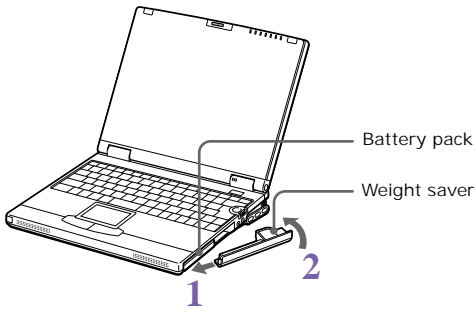

### To charge the second battery pack

Keep the battery pack in the computer while it is connected to AC power. The battery indicator flashes while the battery is charging. See “To charge the battery pack” on page 31 for more information.

### Charging Second Battery Pack

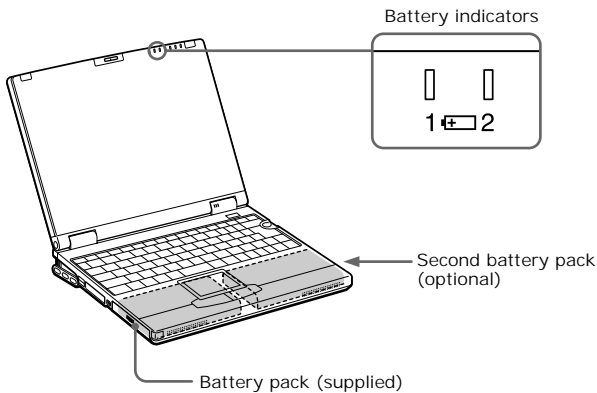

## To remove the second battery pack

- 1 There is a RELEASE lever on the bottom of the weight saver. To remove the battery pack, slide the RELEASE lever on the bottom of the computer in the direction of the arrow. See also “To remove the floppy disk drive” on page 51.

### Removing Second Battery Pack

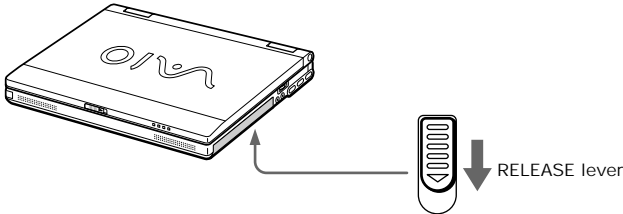

- 2 Remove the weight saver, and then pull out the battery pack.
- 3 Reinsert the weight saver.



If you attach two battery packs, you can remove either of them without shutting down the computer. When removing one battery pack, make sure that the other battery pack indicator is on. If the indicator of the battery pack you are going to remove is on, right-click the Power Management icon  in the system task tray and choose “Select the battery pack in use” window to switch it.

## Using the Weight Saver

The weight saver protects the multipurpose bay when it is empty.

### To attach the Weight Saver

- 1 If another device is in the multipurpose bay, remove the device. See “Notes on CD and DVD media” on page 58 for more information.

### Inserting the Weight Saver

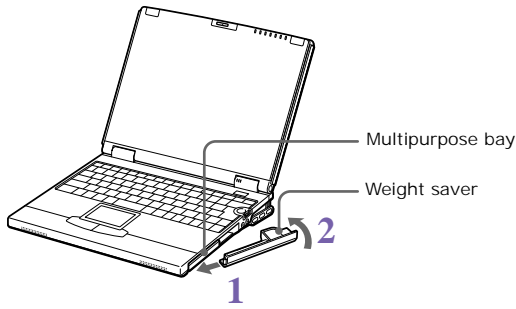

- 2 Slide the weight saver in the direction of the arrow until it clicks.

### To remove the Weight Saver

To remove the weight saver, slide the RELEASE lever on the bottom of the computer in the direction of the arrow.

### Release Lever

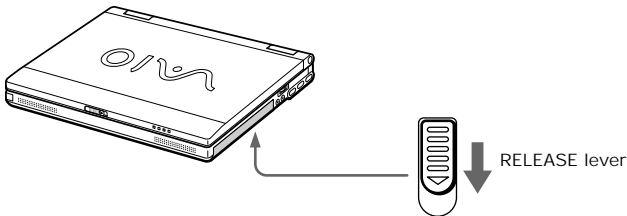

## Removing the Optional Hard Drive (PCGA-HDX10)

### Windows Me models

- 1 Right-click the Power Management icon  in the system task tray and select “Remove multipurpose bay device”. The Device Swapping message appears.
- 2 Slide the Release lever on the bottom of the unit in the direction of the arrow and hold while sliding the device out of the multipurpose bay.
- 3 Click OK.

### Windows 2000 models

- 1 Double-click  in the system task tray. The Unplug or Eject Hardware dialog box appears.
- 2 In the Unplug or Eject Hardware dialog box, select the appropriate device, and then click Stop.
- 3 Confirm the device and click OK.
- 4 A message appears informing you that the device can now be safely removed from the system.
- 5 Slide the RELEASE lever on the bottom of the computer in the direction of the arrow and then unplug the drive from the computer.



When the computer is in power saving mode, you cannot remove the hardware device.



While using the optional hard drive (PCGA-HDX10) in the multipurpose bay, do not put the system into power saving mode. Power saving mode may not work properly and unsaved data may be lost.

## Using Smart Connect

### Windows Me™ models

You can connect your VAIO® notebook to another VAIO computer that has the preinstalled Windows Me operating system or the Sony Smart Connect 3.0 software preinstalled. You may use an i.LINK®\* cable (optional) to connect the two systems and then use one computer to edit, copy, or delete files on the other computer. You can also print from a printer that is attached to either computer. Select the STD mode in Smart Connect 3.0 software to connect with another VAIO computer that has Windows Me preinstalled.

### Connecting with an i.LINK\* Cable

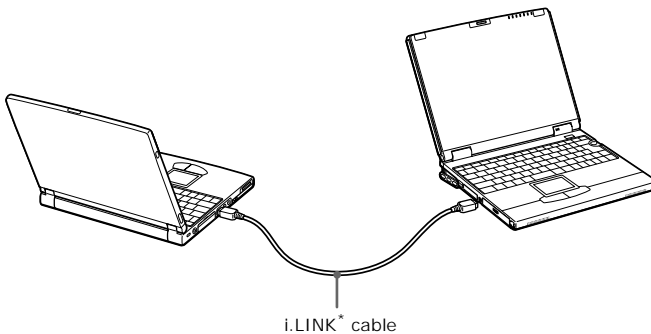

### Windows 2000 models

The preinstalled Smart Connect software allows you to use an i.LINK®\* cable (optional) to connect your VAIO notebook to another VAIO computer that also has Smart Connect or preinstalled Windows Me. You can then use one computer to edit, copy or delete files on the other computer. You can also print from a printer attached to either computer.

---

\* i.LINK is a trademark of Sony used only to designate that a product contains an IEEE 1394 connection. The i.LINK connection may vary, depending on the software applications, operating system and i.LINK-compatible devices. All products with an i.LINK connection may not communicate with each other.

Please refer to the documentation that came with your i.LINK-compatible device for information on operating conditions and proper connection. Before connecting i.LINK-compatible PC peripherals to your system, such as a CD-RW or Hard Disk Drive, confirm their operating system compatibility and required operating conditions.

See Smart Connect online help for more information.



When you connect two VAIO computers, you must assign each computer a unique name. The computers can be identified by this unique name when the two computers are networked together.



If you have previously purchased a VAIO computer or notebook that does not have the Windows Me operating system or Smart Connect 3.0 software preinstalled, consult the Sony website for support options (<http://www.sony.com/pcsupport>).

## Connecting an i.LINK®\*-compatible Device

You can connect an i.LINK®\*-compatible device such as a digital video camera recorder to the **i** S400 connector. You can then download digital pictures from the i.LINK®\*-compatible digital video camera recorder.

 i.LINK®\* cables compatible with your VAIO notebook include cables with the following part numbers: VMC-IL4415 (a 1.5-meter cable with a 4-pin connector at each end), VMC-IL4615 (a 1.5 meter-cable with a 4-pin connector at one end and a 6-pin connector at the other), and VMC-IL4408A (a 0.8-meter cable with a 4-pin connector at each end). You can purchase these cables from your local retailer, through the Sony VAIO® Direct Web site (<http://vaio.sonymstyle.com>), or by calling 1-888-315-7669 (toll free).

### i.LINK® Port

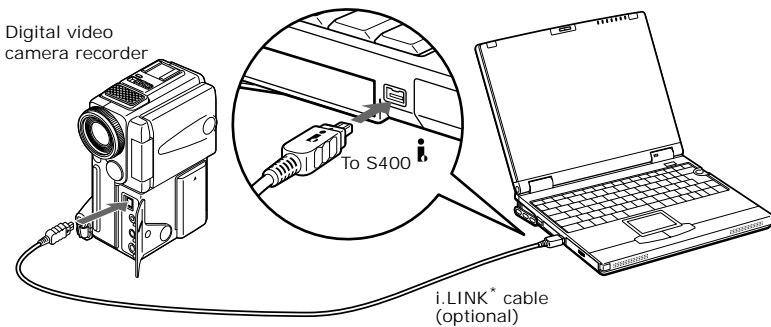

 The i.LINK communication standard that is available in the Windows Me™ operating system is not compatible with the Sony VX1000 camcorder. See the manual that came with your i.LINK-equipped device for more information on installation and use.



The Sony digital video camera recorder is pictured; you may need to connect your camera differently.

On Sony digital video cameras, connectors labeled “DV In/Out” or “i.LINK\*” are i.LINK\*-compatible.

See the manual that came with your i.LINK\*-compatible device for more information on installation and use.

Do not connect more than one digital video camera at a time. The software supplied with your computer will not recognize multiple cameras.

The i.LINK\* connector on the computer does not supply power to external devices. If the external device requires power from the i.LINK\* connector, you cannot use the device with the computer.

The computer supports transfer rates up to 400 Mbps; however, the actual transfer rate depends on the external device.

The i.LINK\* features available may vary depending on the software applications you use. See the documentation that came with your software for more information.

The connections and features may vary depending on the i.LINK\*-compatible devices.

You can connect the digital video camera recorder to your notebook or to the optional i.LINK\* port replicator. While the digital video camera recorder is connected to your notebook or to an i.LINK\* port replicator, do not connect any other device to the other i.LINK\* connector on your notebook.

## DVgate™

### Digital Video Captures

If your system displays the message, “Failed to record to DV deck, please check deck’s power status, cable connection...”, while you are recording images to a digital video device using DVgate software, close all open applications, and restart your computer. Frequent recording of images to a digital video device while using DVgate may cause this situation to occur.

For more information on DVgate software, see the DVgate online help.

### Adjusting Image Resolution

If the images on the LCD do not display smoothly, the resolution may not be set correctly. To check the resolution, click the Setup button in the DVgate Motion-Monitor window. Point to Settings, and then select Low Resolution. The settings



you change in this menu affect the images in the monitor window only. Movie data imported to your hard drive and images recorded to DV devices will not be affected.

### ***Hard Drive Partition***

In order to improve the performance of your computer's DVgate™ Motion software, the hard disk drive on your computer has been formatted with two partitions, C and D. The C partition holds 40% and the D partition holds 60% of the entire drive capacity. DVgate saves files to the D partition. This prevents large video captures from consuming the available space on your C partition. To maintain optimum performance of DVgate, you should defragment or format the D partition regularly.



### ***To defragment a partition***



**Before you begin to defragment a partition, make sure you backup all files that you want to save.**

- 1 Click the Start button in the Windows® taskbar.
- 2 Click Programs>Accessories> System Tools> Disk Defragmenter. The Disk Defragmenter window appears.
- 3 Select the drive you want to defragment from the list, and click the Defragment button. See Windows® Help for more information on defragmenting.

## VAIO® Action Setup

VAIO Action Setup manages the settings for your computer's Jog Dial control, internal timer, and i.LINK<sup>®</sup> interface. An overview of each of these functions is provided in the next few pages. For more information on changing the settings using VAIO Action Setup, right-click the Jog Dial control icon  or , in the task tray and click Help Topics.

### Jog Dial™ Control

Your computer is equipped with a Jog Dial control on the right side of the unit. The Jog Dial control enables you to open an application, folder, or document from a predefined list by rotating and pressing the Jog Dial control. In addition, when you press the Jog Dial control, you can turn on your computer automatically and start the selected application or document. If the document you select is a script file, you can execute a complex task, such as connecting to the Internet and downloading your e-mail to your computer by simply pressing the Jog Dial control.

#### Jog Dial Control

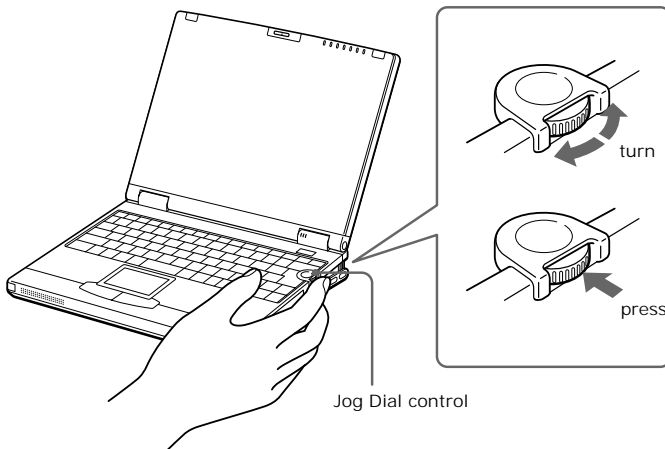

## Using the Jog Dial Control

This section explains how to use the Jog Dial control. For information on how to change the Jog Dial control's settings, right-click the Jog Dial control icon in the task tray and click Help Topics.

### Launcher mode

The Jog Dial control window is in launcher mode until a software application is launched or the Jog Dial control window becomes active. When an arrow is displayed next to an item in the Jog Dial control window, you can display a submenu of that item by selecting it and pressing the Jog Dial control button.

### Using Launcher mode

To use the Jog Dial control, click the Jog Dial control window or the Jog Dial control icon in the task tray. Alternatively, you can press the Jog Dial control while pressing the Ctrl key on the keyboard to switch to the launcher mode.

- 1 Turn the Jog Dial control to select the item you want, then press the Jog Dial control. The window switches to the guide mode and shows the Jog Dial function.

### JOG Guide Dialog Box

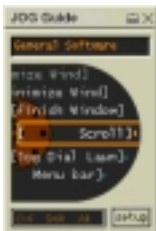

- 2 Turn or press the Jog Dial control to use the desired function.
- 3 To select another item, switch to the launcher mode and repeat from step 1.

### Guide mode

The Jog Dial control window is in the guide mode when software is in use and the software window is active. Depending on the software you are using, you can select items from the displayed list using the Jog Dial control. Some Sony

software applications have two modes in List View: Simple Menu and Full Menu. You can switch the mode by pressing the shift key while turning the Jog Dial control.

### **Guide mode**

The Jog Dial control window displays Jog Dial functions.

### **Software that supports the Jog Dial Control**

If Sony software that supports the Jog Dial control is active, you can use the Jog Dial's functions that are allocated to that software. For more information on functions allocated to software, see the software application's online Help.

### **Software that does not support the Jog Dial Control**

If the software you are using does not support the Jog Dial control, you can scroll the window or adjust the window size as described below:

<b>Action</b>	<b>Description</b>
Maximize Window*	Press the Jog Dial control button to maximize the size of the active window. Press again to return to normal window size.
Minimize Window*	Press the Jog Dial control button to minimize the size of the active window. Press again to return to normal window size.
Finish Window*	Press the Jog Dial control button to close the active application.
Scroll*	Press the Jog Dial control button to begin scrolling within the active window.
Jog Dial Launcher	Press the Jog Dial control button to return the Jog Dial control to Jog Launcher mode.
Menu Bar	Press the Jog Dial control button, then use the Jog Dial control to scroll through the active window's toolbar.

\* Some software does not support these functions.

### ***Dialog box***

When a window such as Screen properties is active, Dialog is displayed in the Jog Dial control window. You can select an item in the window by rotating the Jog Dial control. Pressing the Jog Dial control is equivalent to pressing Enter.

### ***JOG Guide Dialog Box***



### ***Internal Timer***

You can use the internal timer to start an application at a specific time. The timer can start applications even when the computer is in System Hibernation mode.

### ***i.LINK®\* Interface***

Your computer comes equipped with an i.LINK®\* port. The port is a digital interface (IEEE1394) for high-speed communication. By using your computer, a Sony Digital Handycam® Camcorder or other compatible camera that supports the i.LINK®\* interface, you can easily create and edit your own home videos. For more information on connecting an i.LINK®\* device, see “Connecting an i.LINK®\*-compatible Device” on page 71 of this manual.

## Using Power Saving Modes

When you use a battery as the source of power for your computer, you can take advantage of power management settings to conserve battery life. In addition to the normal operating mode, which allows you to turn off specific devices, your computer has three distinct power saving modes: System Idle, System Suspend, and System Hibernation. When using battery power, you should be aware that the computer automatically enters System Hibernation mode when the remaining battery charge drops below 5%, regardless of the power management setting you select.



If the battery level falls below 10%, you should either attach the AC adapter to recharge the battery or shut down your computer and insert a fully charged battery.

### Normal Mode

This is the normal state of your computer when it is in use. The green power indicator light is on in this mode. To save power, you can turn off a specific device such as the LCD.

### System Idle Mode

This mode is convenient if you do not need to use your computer for a brief period. The hard disk and video display enter a low power state, and the CPU clock and processor stop. The power indicator light is amber in this mode.

#### *To activate System Idle mode*

Press Fn+S, the Power Management utility, or the Jog Dial™ control.

#### *To return to normal mode*

Press any key or touch the touchpad.

### System Suspend Mode

The computer saves the current state of the system in RAM and switches off power to the CPU. The amber power indicator light flashes in this mode.

### ***To activate System Suspend mode***

Press Fn+Esc, or press the power button and release it immediately. You can also use the Power Management utility or the Jog Dial control to enter System Suspend mode.

### ***To return to normal mode***

Press any key or the Power button for less than 4 seconds.

### ***System Hibernation Mode***

The state of the system is saved on the hard drive and power is turned off. The power indicator light is off in this mode.

### ***To activate System Hibernation mode***

To activate System Hibernation mode, press the key combination Fn+F12.



(Windows 2000) The “Save to Disk Manager” screen appears, and then the computer enters System Hibernation mode.



Do not move the notebook until its power indicator light turns off.

### ***To return to normal mode***

Turn on the computer by pressing the power button. The computer returns to its previous state.



When returning from System Hibernation mode, the system status stored on the hard disk is erased and the computer starts normally if you press the power button and hold for more than four seconds.

- Time to return to normal mode  
System Idle requires less time than System Suspend, and System Suspend requires less time than System Hibernation.
- Power consumption  
System Idle uses more power than System Suspend, and System Suspend uses more power than System Hibernation.





# Connecting Peripheral Devices

You can add functionality to your computer by connecting any of these peripheral devices:

- Phone line (page 82)
- Mini Docking Station (page 85)
  - External mouse or keyboard (page 89)
  - Printer (page 89)
  - Floppy disk drive (page 90)
  - AV devices (page 94)
- Printer (page 99)
- External display (page 100)
- External speakers (page 103)
- External microphone (page 104)
- Universal Serial Bus (USB) device (page 105)



Connect the power cord only after connecting all cables.

Turn on the computer only after turning on all peripheral devices.

You can select a country mode from the modem property window, but you should only use US mode. Using other country modes is an infringement of the Telecommunications Business Laws.

## Connecting a Phone Line

You need to connect a phone line to take advantage of online services and the Internet.

 In order to register your Sony VAIO notebook, register your software online, and use Sony Customer Support, you must connect to a phone line.

- 1 Plug one end of the phone cable into the phone line jack on the computer.

### Connecting a Phone Line

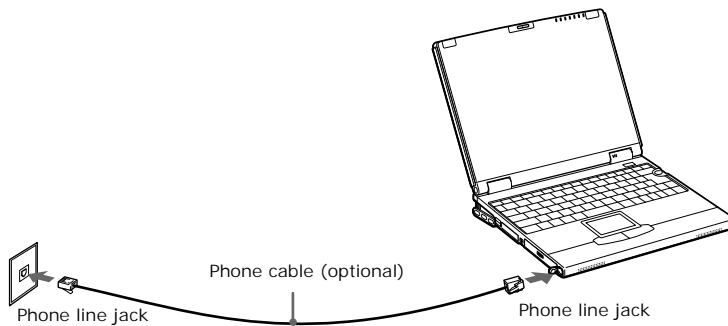

- 2 Plug the other end into the wall jack.

 Your computer does not work with party lines, cannot be connected to a coin-operated telephone, and may not work with multiple phone lines or a private branch exchange (PBX). Some of these connections might result in excess electrical current and could cause a malfunction in the internal modem.

If you connect a phone line coming through a splitter, the modem or connected device may not work properly.

## Using the Mini Docking Station

You can use the PCGA-PSX1 Mini Docking Station to connect peripheral devices such as a printer or external display.

 You must wait for the IN USE indicator to light before using a connected peripheral device.

### Front

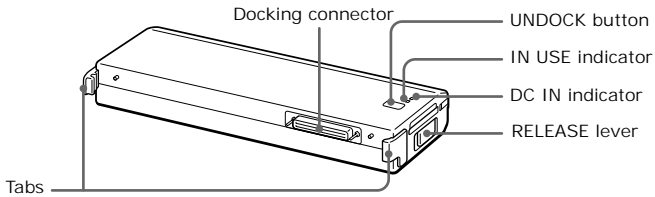

**Back**

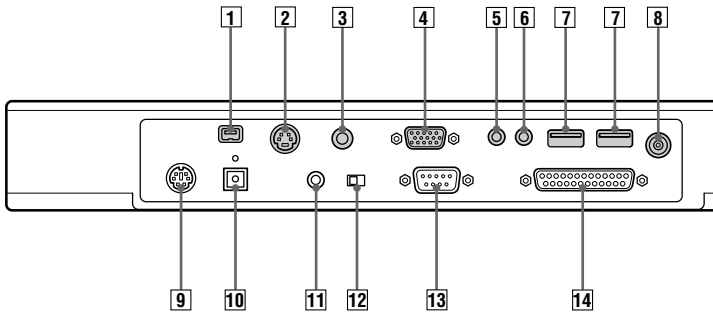

<b>1</b>	<b>i i.LINK (IEEE1394) S400 connector*</b>	<b>8</b>	<b>DC IN connector</b>
<b>2</b>	<b>S VIDEO connector</b>	<b>9</b>	<b>Mouse/Keyboard connectors</b>
<b>3</b>	<b>VIDEO connector</b>	<b>10</b>	<b>OPTICAL OUT connector</b>
<b>4</b>	<b>Monitor connector</b>	<b>11</b>	<b>CONTROL A1 II connector</b>
<b>5</b>	<b>LINE OUT connector</b>	<b>12</b>	<b>SERIAL/CONTROL A1 II switch</b>
<b>6</b>	<b>LINE IN connector</b>	<b>13</b>	<b>Serial</b>
<b>7</b>	<b>USB connector</b>	<b>14</b>	<b>Parallel (printer) connector</b>

\* i.LINK is a trademark of Sony used only to designate that a product contains an IEEE 1394 connection. The i.LINK connection may vary, depending on the software applications, operating system and i.LINK-compatible devices. All products with an i.LINK connections may not communicate with each other.

Please refer to the documentation that came with your i.LINK-compatible device for information on operating conditions and proper connection. Before connecting i.LINK-compatible PC peripherals to your system, such as a CD-RW or Hard Disk Drive, confirm their operating system compatibility and required operating conditions.

**Left/Right**

Floppy disk drive connector

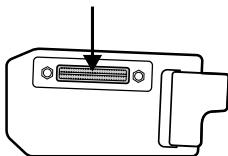

PC card slot

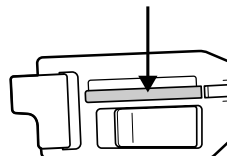

## Connecting the Mini Docking Station

### Before connecting the Mini Docking Station

You must plug the cable attached to the AC adapter into the DC IN connector on the Mini Docking Station. Plug the power cord into the AC adapter and an electrical outlet.

The DC IN indicator lights on.

### Connecting AC Adapter to Docking Station

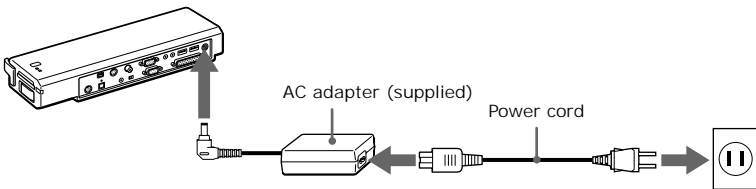

 Use the specified AC adapter for the power rating of the Mini Docking Station.

### To connect the Mini Docking Station to your computer

When a charged battery is inserted in your computer, you can attach and detach the Mini Docking Station without turning off your computer.

 If your notebook is in power saving mode, switch to normal mode before attaching or detaching the Mini Docking Station.

- 1 Open the cover of your computer.

### Docking Station/FDD Connector

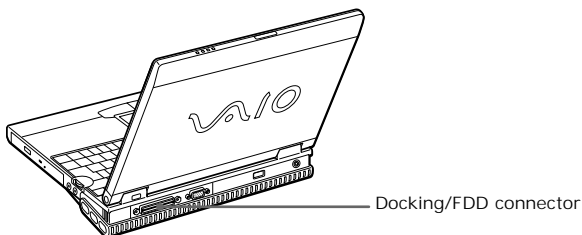

- 2 Attach the left side tab of the Mini Docking Station to the left side hollow of your computer.

Push the tab into the hollow firmly until it clicks.

#### *Left Tab Hollow*

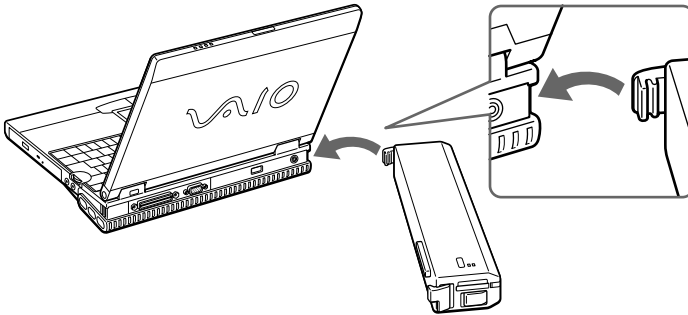

- 3 Align the connector on the Mini Docking Station with the docking/floppy disk drive connector on the back of your computer.
- 4 Firmly press the Mini Docking Station into place.
- 5 Attach the right side tab of the Mini Docking Station to the right side hollow of your computer.

Push the tab into the hollow firmly until it clicks.

#### *Right Tab Hollow*

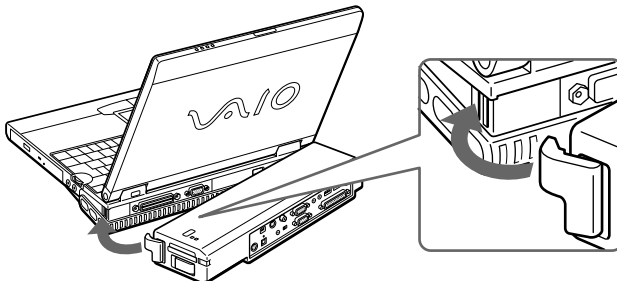

 Do not lift or move the computer by holding only the Mini Docking Station as the Mini Docking Station may separate from the computer.

### **Removing the Mini Docking Station from your notebook**

When the computer is off, skip step 1. When the computer is in power saving mode, switch to Normal mode, and then follow the steps below.

- 1 Press the UNDOCK button on the Mini Docking Station or click REMOVE on the Start menu.

#### **Undocking Button**

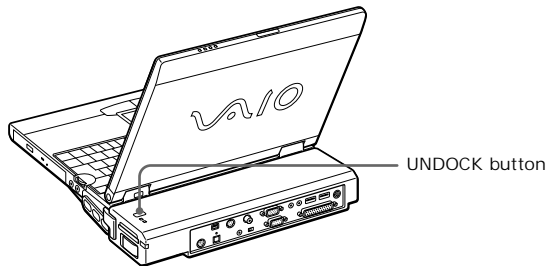

- 2 After the IN USE indicator has turned off, pull the RELEASE lever on the right side of your computer and release the right tab.

#### **Release Lever**

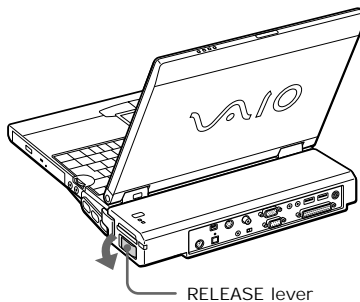

3 Release the left tab.

### Removing Mini Docking Station

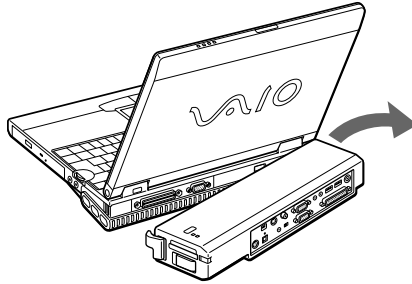

When the Mini Docking Station is attached to your computer, do not insert or remove the battery. The Mini Docking Station may separate from the computer.

Do not remove the Mini Docking Station when the IN USE indicator is lit.





## Connecting an external mouse or keyboard

You can connect a USB or PS/2® style mouse or keyboard.

- 1 Plug the keyboard cable or mouse cable into this connector with  facing up.

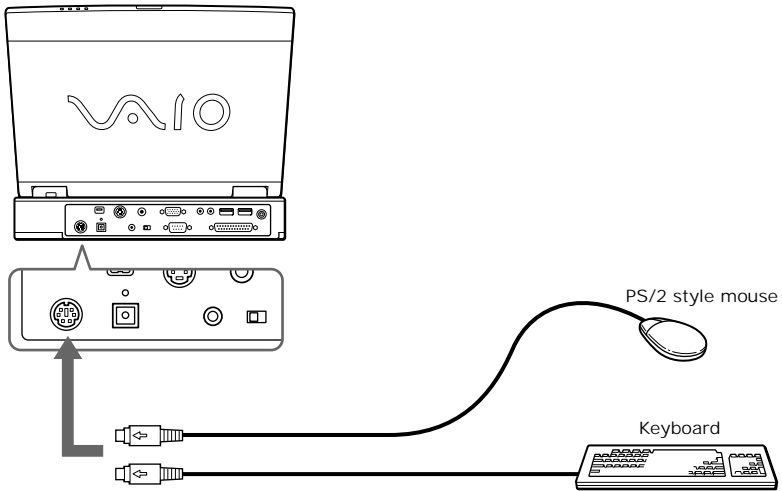
### Connecting a Mouse or External Keyboard



 USB devices can be connected and disconnected while the computer is on.

If the wheel function of the PS/2 style mouse does not operate, connect the mouse to the serial port using a PS/2 serial adapter. You can also use one or both of the USB ports to connect a mouse and keyboard at the same time.

## Connecting a printer to the Mini Docking Station

You can connect the printer to the Mini Docking Station attached to your computer to print documents.

### To connect a printer

Use the  symbol to locate the Printer connector. Plug the printer cable (supplied with the printer) into this port on the computer.

### Connecting a printer

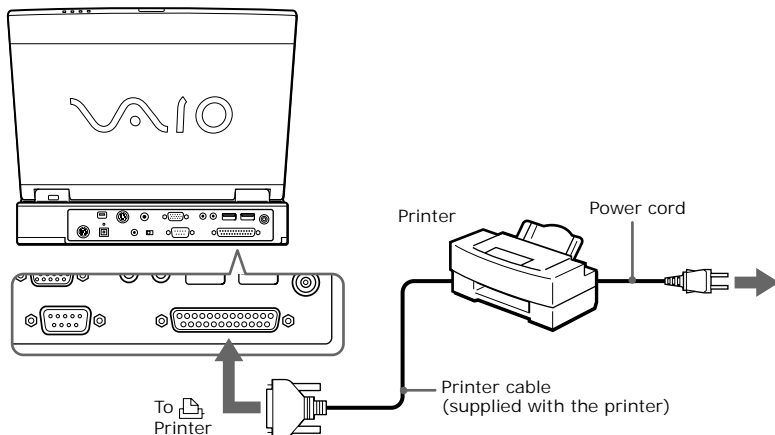

Before you connect the printer, turn off your computer and disconnect the AC adapter and power cord from the electrical outlet.

Plug the power cord into a power outlet after completing all the connections.

Turn on the peripheral devices before turning on your computer.

If you are using a printer that does not support Windows 2000 or Windows Me, it may not function properly.

You can connect a printer while the floppy disk drive is in use.

When using a USB printer, connect it to the USB connector of your computer or the Mini Docking Station.

See the manual that came with your printer for more information on installation and use.

Before using the printer, you may need to change the Printer setting in the Sony Notebook Setup software. See Displaying the Sony Notebook Setup Screen in the online manual, *"Customizing Your VAIO® Notebook"*.

### Connecting a floppy disk drive to the Mini Docking Station

You can use the floppy disk drive as an external drive by connecting it to the floppy disk drive connector on the left side of the Mini Docking Station. You can connect it without turning off your computer.

 If your notebook is in power saving mode, switch to normal mode before connecting a floppy disk drive to the Mini Docking Station.

- 1 With the VAIO logo facing up, plug the cable firmly into the connector and both of the alignment posts in the guide holes.
- 2 With the VAIO logo facing up, plug the FDD into the other end until it locks in place.

### FDD Connecting

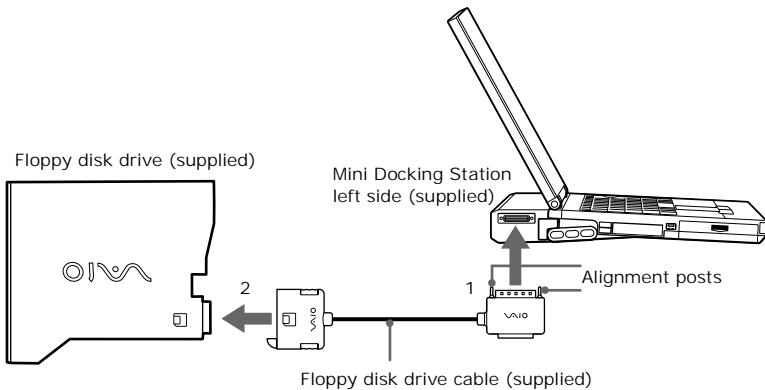

 When you connect the floppy disk drive to the floppy disk drive connector of the Mini Docking Station, you cannot use the PRINTER connector of the floppy disk drive cable. The printer can be connected to the printer port on the Mini Docking Station.

### **Using the floppy disk drive stand (for the Mini Docking Station)**

You can use the floppy disk drive on the Mini Docking Station by attaching it to the floppy disk drive stand (for Mini Docking Station) as illustrated below.

- 1 Place the protrusions on the floppy disk drive stand (for the Mini Docking Station) into the holes in the top face of the Mini Docking Station.

#### **Attaching the floppy disk stand**

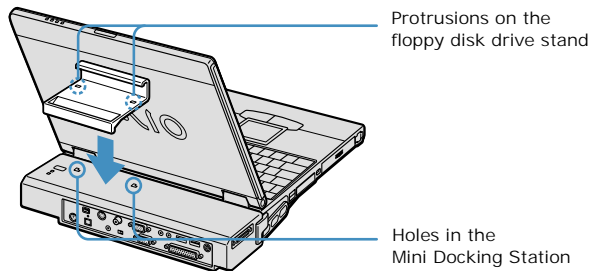

- 2 Slide the floppy disk drive stand in the direction of the arrow.

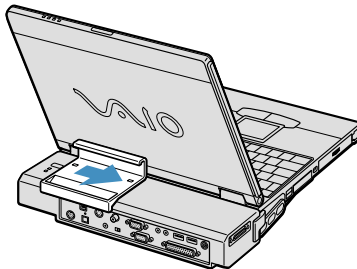

- 3 Slide the floppy disk drive into the floppy disk drive stand.

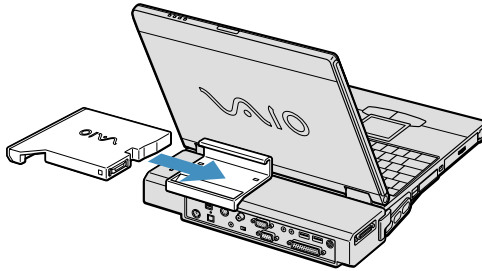

- 4 Attach the floppy disk drive cable from the computer to the floppy disk drive.



**Do not hyperextend the LCD screen when you are using the floppy disk drive stand (for the Mini Docking Station).**

## Connecting audiovideo (AV) devices

You can use audio/video devices by connecting the AV devices to the Mini Docking Station. See the manuals and online help that came with your AV devices for detailed instructions. By connecting an MD deck or a CD player which has a CONTROL A1 or CONTROL A1 II connector, you can play a CD disc, create your own CD database, or edit an MD disc.

### Connecting an MD Deck or CD Player

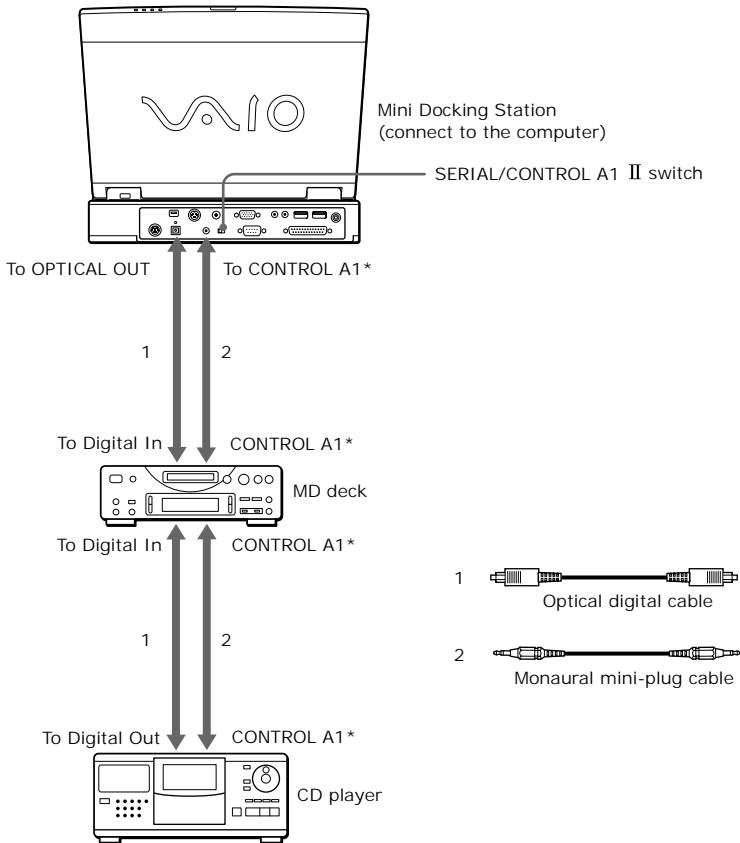

To use the CONTROL A1 II connector on the Mini Docking Station, switch the SERIAL/CONTROL A1 II switch to CONTROL A1 II.



Use monaural mini-plug cables shorter than 2 meters with no resistance.

\*CONTROL A1 or CONTROL A1 II

***To record music to a mini disc from a CD playing on the computer via the OPTICAL OUT, (available by connecting to the Mini Docking Station) follow these steps:***

- 1 Click the Start button, point to Settings, and then click Control Panel.
- 2 Double-click YAMAHA DS-XG Audio Config.
- 3 Select Digital Output and click “ON [All Sources]/Analog out is muted.”
- 4 Click OK.

### Connecting a CD player, an active speaker, or an amplifier

Connect a CD player, an active speaker, or an amplifier to the LINE IN or LINE OUT connector of the Mini Docking Station to play a CD and experience higher quality audio.

#### Connecting Devices

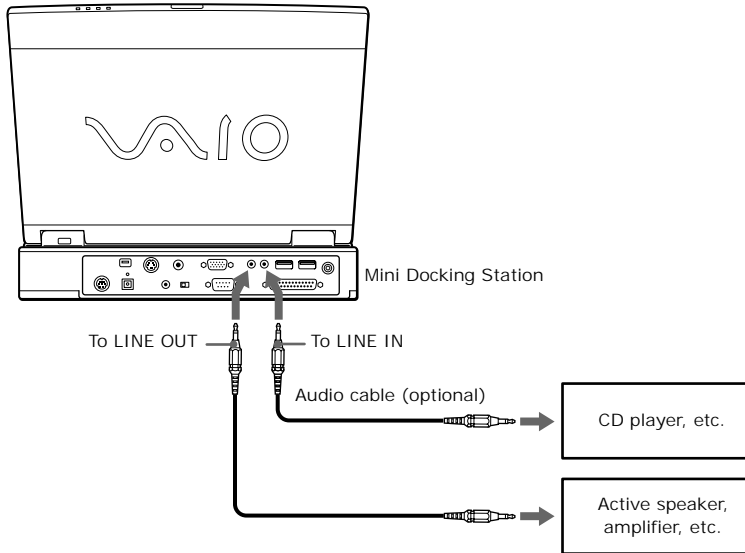



## Connecting a Dolby Digital™ Decoder integrated device

- 1 Insert the DVD-ROM drive into the multipurpose bay
- 2 Connect the OPTICAL OUT connector to a Dolby Digital Decoder integrated device to experience Dolby Digital recorded videos and dynamic sound.

## Connecting Audio and Video Devices

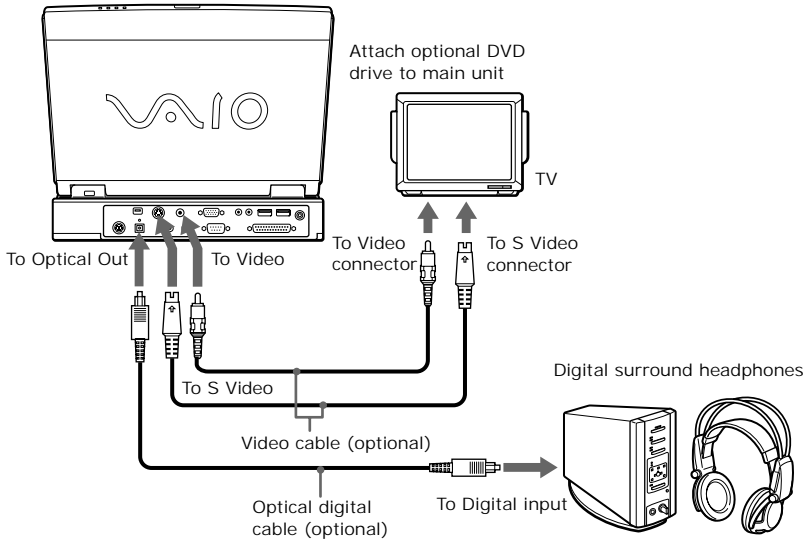

You can experience Dolby Digital or PCM sound from the OPTICAL OUT connector.

- 3 Switch the Digital output to PCM when you connect a device that does not support Dolby Digital; otherwise, the speakers or your hearing may be damaged by the increased volume.
- 4 Switch the Digital output to PCM when you play DVDs that support linear PCM recording on the Mini Docking Station.

## Connecting a TV or a video deck

Connect the computer to a TV or a video deck using audio/video cables. Switch the input channel of the TV to external input. You also need to set up the TV configuration system. See “Selecting the Display Mode” in the “*Customizing Your VAIO® Notebook*” manual for more information.

 Unplug the connecting cable from the MONITOR connector.

### Connecting a TV

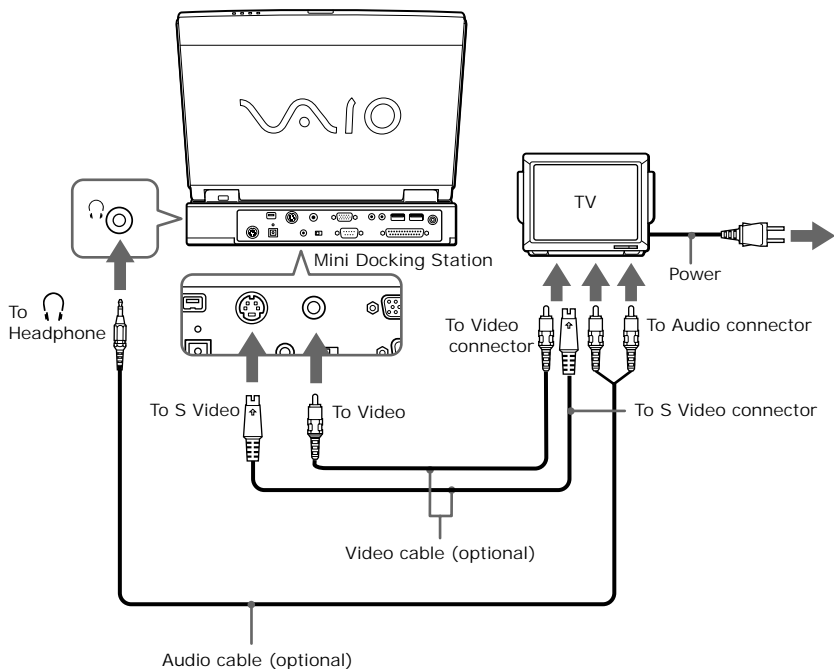

## Connecting a Printer to Your Computer

You can connect the printer to your computer using the printer cable and the supplied floppy disk drive cable to print documents.

### Before using the printer

- ❑ You need to install the software supplied with the printer. See the manual that came with your printer for more information.
- ❑ You need to set up the printer port. See “I cannot print.” on page 142 for more information about setting up the printer port.

### To connect a printer

Plug the floppy disk drive cable to the docking/FDD connector on your computer. Then connect the printer cable (supplied with the printer) to the PRINTER connector of the floppy disk drive cable.

#### Parallel Port

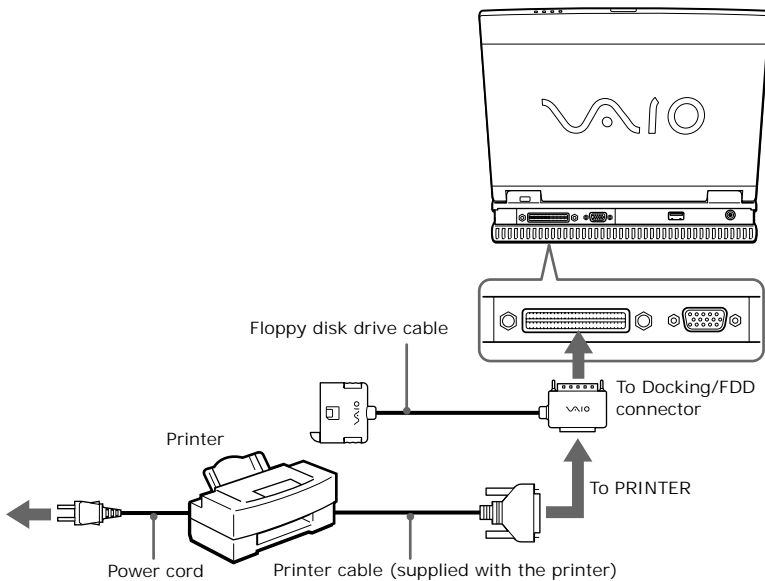

 Before you connect the printer, turn off your computer, and disconnect the AC adapter and power cord from the AC outlet.

Plug the power cord into an AC outlet after finishing all the connections.

Turn on the peripheral devices before turning on your computer.

If you are using a printer that does not support Windows Me or Windows 2000 it may not function properly.

You can connect a printer while the floppy disk drive is in use.

When using a USB printer, connect it to the USB connector of your computer or the USB connector of the Mini Docking Station.

If the Mini Docking Station is connected to your notebook, you may connect the printer directly to it without the floppy drive cable.

## ***Connecting an External Display***

You can connect an external display to your notebook. For example, you can use the computer with any of the following:

- Computer display monitor
- Projector

 Turn off your computer and all peripheral devices, and disconnect the AC adapter and power cord from the AC outlet before making connections.

Connect the power cord after connecting all peripheral devices.

Turn on your computer after turning on the power of all peripheral devices.

When you connect an external display, you may not be able to display both the LCD and external display simultaneously, depending on the external display.

### To connect a computer display

You can enhance the sound quality of your computer by connecting external speakers and an external microphone. See “To connect external speakers” on page 103 and “To connect an external microphone” on page 104 for details on connecting external speakers and an external microphone.

#### Monitor Connector

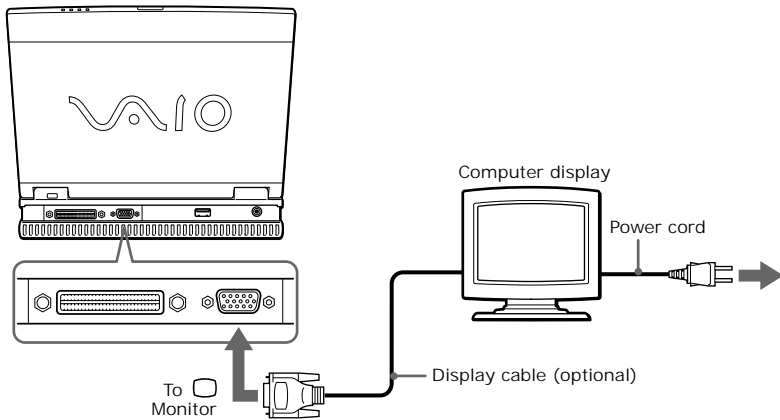

 See the manual that came with your computer display for more information on installation and use.

### To connect a projector

Using a projector connected to your computer can be convenient for presentations and slide shows.

#### Connecting a Projector

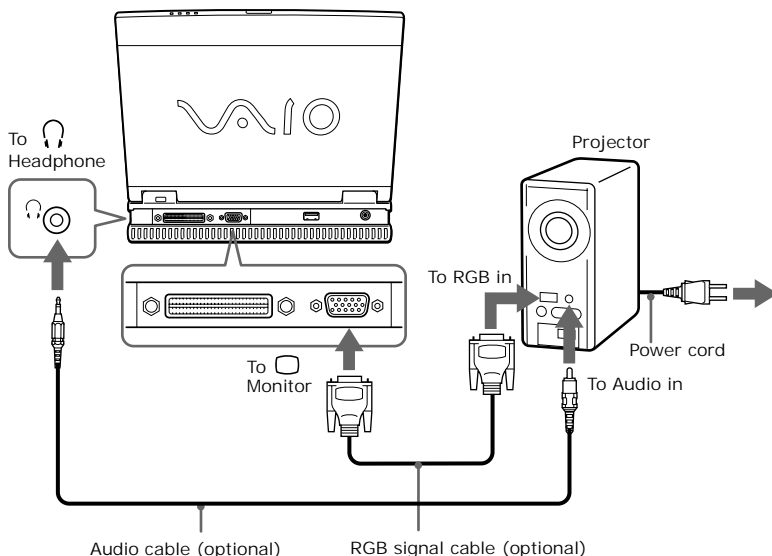

 See the manual that came with your projector for more information on installation and use.

### To select a display

When you connect an external display to the monitor connector, you can toggle the output among the LCD, the external monitor, or both devices.

Use the Fn+F7 keys to select a display. See also “Selecting the Display Mode” in the “*Customizing Your VAIO® Notebook*” manual for more information.

To	Press	Result
Switch to an external display	Fn+F7	Toggles among the LCD, the external display connected to the Monitor connector, and both the LCD and external display.

```

graph LR
    A[Only LCD] --> B[LCD and external display]
    B --> C[Only external display]
    C --> A
    
```

## Connecting External Speakers

You can enhance the sound quality of your computer by connecting external speakers.

Check that your speakers are designed for computer use.

Shut down the computer and all peripheral devices before connecting the cables.

Connect all the cables before plugging in the power cord.

Turn on the peripheral devices' power, then turn on your computer.

Turn down the volume of the speakers before you turn them on.

Do not place diskettes on the speakers as the speakers' magnetic field may damage the data on the diskettes.

### To connect external speakers

- ❑ Use the headphones symbol to locate the Headphone connector. Plug the speaker cable into this connector.

### Connecting Speakers

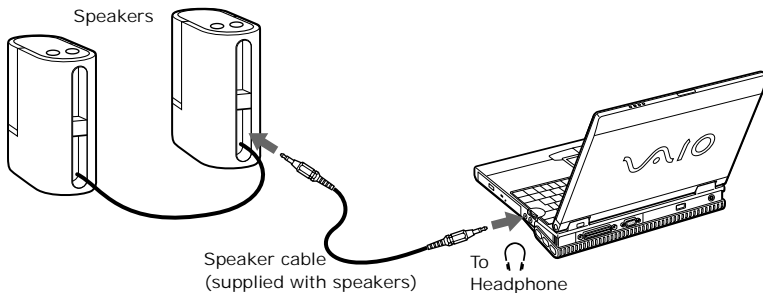

 See the manual that came with your speakers for more information on installation and use.

## Connecting an External Microphone

You can enhance the quality of sound input by using an external microphone.

 Shut down the computer and all peripheral devices before connecting the cables.

Connect all the cables before plugging in the power cord.

Turn on the peripheral devices' power, then turn on your computer.

Make sure your microphone is designed for computer use. The microphone should be compliant with the plug-in power microphone.

The microphone input is MONO.

### To connect an external microphone

- Use the  to locate the Microphone connector. Plug the microphone cable into this connector.

### Connecting Microphone

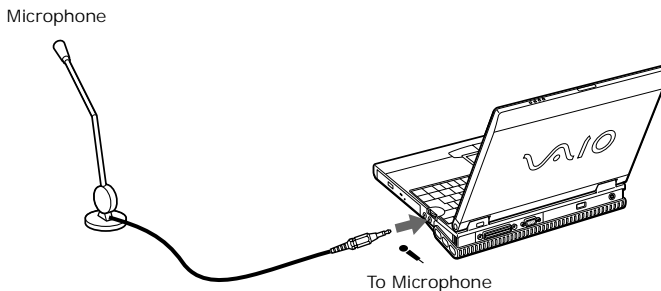

 See the manual that came with your microphone for more information on installation and use.



## Connecting a Universal Serial Bus (USB) Device (Mouse or Keyboard)

You can connect a USB style mouse or keyboard.

Plug the keyboard cable or mouse cable into this connector with the  facing up.

### USB Port

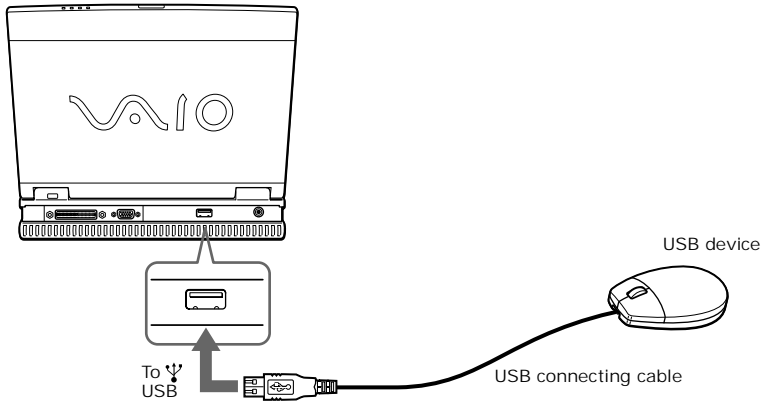

You can use the optional Sony USB mouse PCGA-UMS1/A series with this computer. The USB mouse software driver is preinstalled in the computer.



USB devices can be connected and disconnected while the computer is on.

See “Using the Keyboard” on page 39 for more information on using the keyboard.

See the manual that came with your mouse or keyboard for more information on installation and use.

A Sony USB mouse PCGA-UMS1/A series (optional) is a USB device. You must connect it to the USB connector.



# Adding Memory

You can increase your system's memory by installing optional memory modules. Your system comes with 128 MB of installed memory, which can be increased up to 256 MB (128 MB x 2). You can add an expansion memory module in a slot. Up to 128 MB expansion memory modules are available as optional memory modules.



Make sure you observe the proper safety precautions when you install a memory module in your computer. See the bulleted list below. Be careful when adding memory. Mistakes when installing or removing a memory module may cause malfunction.

If you are using only one memory module, you must use the slot closest to the front of the computer.

- ❑ Electrostatic discharge (ESD) can damage disk drives and other components. Perform the procedures described below only at an ESD workstation. If such a station is not available, do not work in a carpeted area, and do not handle materials that produce or hold static electricity (cellophane wrappers, for example).
- ❑ Ground yourself by maintaining contact with an unpainted metal portion of the chassis while performing the procedure.
- ❑ Do not open the memory module package until you are ready to install the module. The package protects the module from ESD.
- ❑ Use the special bag for preventing ESD or use aluminum foil when you store the memory module.

## *To install a memory module*

- 1 Shut down your computer and disconnect all peripheral devices, such as your printer.
- 2 Unplug the computer and remove the battery packs.
- 3 Wait until the computer cools down. Then remove the screw at the bottom of your computer.

### Removing the Memory Module Cover

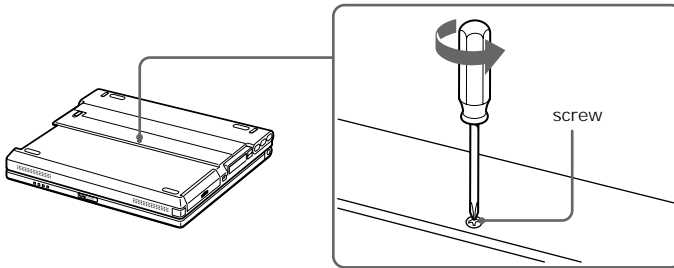

 Remove the screw with a screwdriver of a proper size.

- 4 Lift the two stoppers at the bottom of the keyboard and slide the keyboard toward the LCD display, then lift it away slightly.

### Keyboard Stoppers

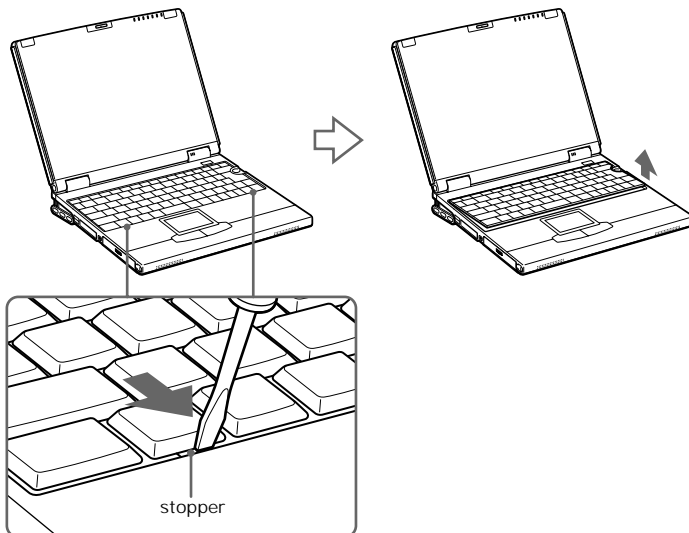

- 5 Lift the keyboard from the LCD display side by releasing the four tabs, then gently lean it over the display. Be careful not to detach the cable when lifting the keyboard.

**Lifting the Keyboard**

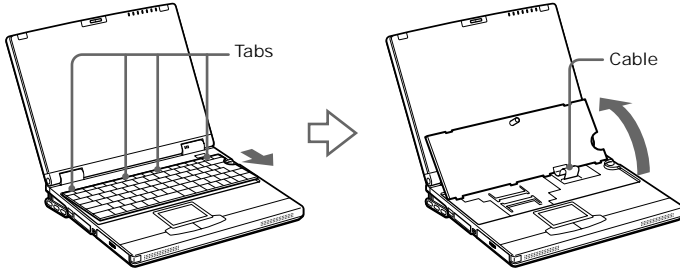

- 6 Remove the new memory module from its packaging.
- 7 Install the memory module as described in the following graphic.

**Installing Memory Module**

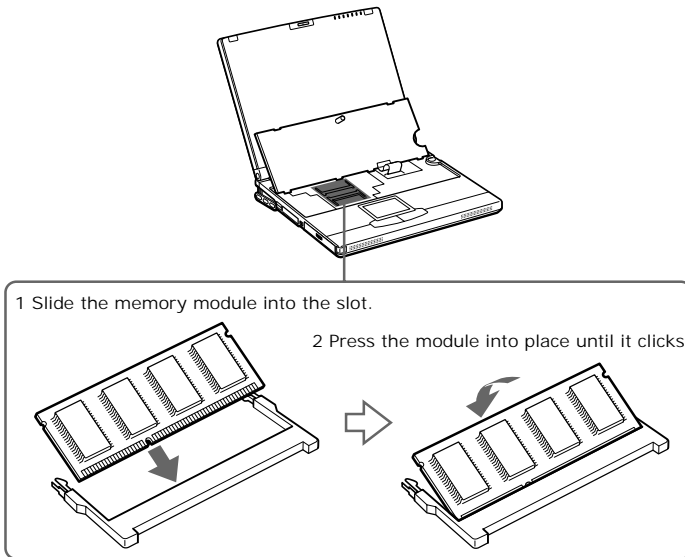

- 8 Gently replace the keyboard, then press it into your computer. Be careful not to detach the cable when replacing the keyboard.

### Replacing the Keyboard

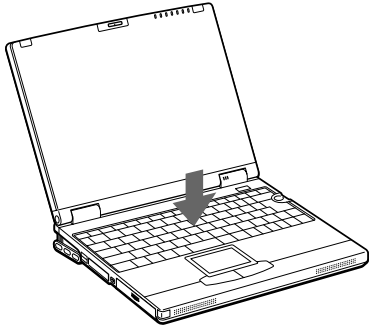

- 9 Close the computer cover, and tighten the screws on the bottom of the computer.

### To remove a memory module

- 1 Follow steps 1 to 5 of “To install a memory module.”
- 2 Touch a metal object (such as the connector panel on the back of your computer) to discharge static electricity.
- 3 Remove the memory module.

### Memory Module

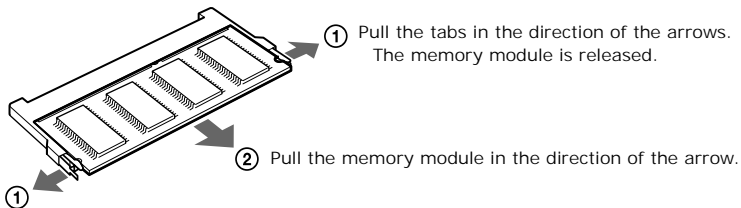

- 4 Follow steps 8 and 9 of “To install a memory module.”

### ***To view the system memory***

- 1** Turn on the computer.
- 2** Click the Start button, point to VAIO, and click “Sony Notebook Setup.”  
The Sony Notebook Setup screen appears.
- 3** Click the “About This Computer” tab to view the system memory. If the additional memory is not shown, repeat steps 1-9 of “To install a memory module” on page 107.





# Software Information

## About the Software on Your Notebook

Your VAIO notebook is ready to help you work, play, learn, and communicate as soon as you turn it on. This section gives you an overview of the activities you can perform with your software titles. For support information, see “For Answers to Your Software Questions” on page 123.

### **Adobe Acrobat Reader®**

*Adobe Systems, Inc.*

Acrobat Reader software allows you to view, navigate, and print electronic documents in Adobe Portable Document Format (PDF), an open file format that is intended to preserve the fidelity of documents created on all major computer platforms.

### **Adobe PhotoDeluxe® Home Edition**

*Adobe Systems, Inc.*

Create amazing photo effects with Adobe PhotoDeluxe. Without learning complex software, you can enhance, restore, and be creative with your photos. Includes built-in guided activities, stock photos, clip art, and templates to assist you.

### **Adobe Premiere® LE**

*Adobe Systems, Inc.*

Adobe Premiere LE offers an interface and editing tool for producing movies for video, multimedia, or the Web. View source clips and edited footage simultaneously on the monitor window. Create video clips up to three hours long with complete audio-video synchronization.

### **America Online® (Windows Me only)**

*America Online, Inc.*

America Online is a popular Internet online service. Stay in touch with family and friends with Easy-to-Use E-mail, manage your personal finances, get the latest news and sports scores, and chat with thousands of others who share your interests.

### **ArcSoft PhotoPrinter™ 2000 Pro**

*ArcSoft, Inc.*

ArcSoft PhotoPrinter 2000 Pro is an easy-to-use, advanced printing program that lets you quickly lay out multiple images in multiple sizes on a single sheet of paper. PhotoPrinter Pro offers a wide selection of templates including landscape, portrait, free style, mixed sizes, custom templates, and more. The application includes enhancement tools and special effects for improving photos while giving you the ability to add text to any image.

### **CompuServe® 2000 (Windows Me only)**

*CompuServe*

The all new CompuServe 2000 delivers a powerful tool for Internet users who want serious and timely information, in-depth research, and professional communities backed by state-of-the-art technologies, including high-speed access and powerful e-mail messaging.

### **Direct CD™ (select models only)**

*Adaptec, Inc.*

DirectCD allows you to drag and drop files directly to your CD-RW drive. You can save, rename, move or delete files right on your CD-RW.

### **DVgate™**

*Sony Electronics Inc.*

Connect a digital video camera recorder to the i.LINK\*® connector and capture your own video clips and still images. You can edit the clips from your video, add others, and combine clips into new movie segments. You can save your images in a variety of popular file formats.

### **EarthLink Network TotalAccess® (Windows Me only)**

*EarthLink, Inc.*

An Internet Service Provider that supplies access, information, and assistance to its customers, introducing them to the Internet. Member benefits include e-mail, a Personal Start Page, a free 6 MB web site, a member newsletter, and 24-hour technical support.

### **Easy CD Creator™ (select models only)**

*Adaptec, Inc.*

Easy CD Creator lets you make your own data, audio and multimedia CDs. You can back up your important files to CD, and read them back on standard CD-ROM drives. Create your own audio CDs right on your desktop, and play them back on your home or car stereo CD player. You can make your own personalized color jewel case inserts with custom text and graphics. You can even make backup copies of your existing CDs. The easy CD Creator Wizard makes creating your own custom CDs a simple process.

### **McAfee® VirusScan®**

*Network Associates, Inc.*

Protect your computer from viruses. VirusScan can detect viruses from floppy disks, Internet downloads, e-mail attachments, intranets, shared files, CD-ROMs, and online services.

### **Media Bar™**

*Sony Electronics Inc.*

Media Bar software is your all-in-one solution for audio/video playback. Media Bar software handles all common computer multimedia formats and controls selected Sony devices. In addition to audio/video library cataloging and playlist

---

\* i.LINK is a trademark of Sony used only to designate that a product contains an IEEE 1394 connection. The i.LINK connection may vary, depending on the software applications, operating system and i.LINK-compatible devices. All products with an i.LINK connection may not communicate with each other.

Please refer to the documentation that came with your i.LINK-compatible device for information on operating conditions and proper connection. Before connecting i.LINK-compatible PC peripherals to your system, such as a CD-RW or Hard Disk Drive, confirm their operating system compatibility and required operating conditions.

management, Media Bar software includes digital video quality control and effects features. Media Bar software seamlessly integrates a variety of new media formats with an easy-to-use software interface.

### **Microsoft® Internet Explorer**

*Microsoft Corporation*

Internet Explorer delivers the web the way you want it. It is safe, easy to use, and you can personalize how you access the web. Outlook Express and other tools in Internet Explorer also help you have a great experience when you are on the web.

### **Microsoft® Word 2000**

*Microsoft Corporation*

Microsoft Word 2000 makes it easy to create shared Web, e-mail, and print documents for use around the world. It embraces HTML as a first-class file format and extends Word's ease-of-use to the Web and e-mail. Word 2000 also extends that ease-of-use to international users, making it simple to create multilingual documents.

### **MovieShaker™**

*Sony Electronics Inc.*

Sony's original MovieShaker software creates personal movies that have transitions, background music, and text. Just import your video clips and "shake" with the click of a mouse. Your personal movies are easy to create and fun to share with family and friends.

### **Netscape Communicator®**

*Netscape Communications Corporation*

Netscape Communicator is an all-in-one Internet tool that makes it easy to browse the web, send Internet e-mail, chat, read newsgroups and compose great web documents.

### **PictureGear™**

*Sony Electronics Inc.*

This image management software displays images from your hard drive, a Sony Digital Still Camera, or a Sony Mavica® Camera. The images appear in a convenient light-table format, so that you can easily view the contents of an entire folder.

### **Prodigy Internet® (Windows Me only)**

*Prodigy Communications Corporation*

An online service that helps you find what you need online faster and smarter. Prodigy delivers powerful online content such as sports scores, stock quotes, news, and easy access to Excite, plus quality customer service, all at a competitive price.

### **Quicken® 2000 Basic**

*Intuit, Inc.*

Quicken is a fast, easy way to organize your finances. Quicken works just like your checkbook, so it is easy to learn and use. Quicken manages all your finances, bank accounts, credit cards, investments, and loans. You can even pay your bills online.

### **Smart Capture**

*Sony Electronics Inc.*

Smart Capture is a fun new way to send multimedia messages via e-mail. Smart Capture manages the i.LINK\* connection between your computer and a Sony Digital Handycam® camcorder that supports the i.LINK\* interface. It allows you to capture compressed video or still images that you can save or share via e-mail. A smart solution to computer, digital audio/video and network convergence.

### **Smart Connect (Windows 2000 only)**

*Sony Electronics Inc.*

Smart Connect allows you to use an i.LINK\* cable (not supplied) to connect your VAIO computer to another VAIO computer that supports Smart Connect. You can then use one computer to copy, delete, and edit files on the other computer. You can also print from a printer attached to either computer.

### **Sound Forge® XP**

*Sonic Foundry, Inc.*

Sound Forge® XP allows you to put powerful audio processing tools and effects to work on your desktop. Simply cut, copy, and paste your way to striking multimedia files for use in everything from web pages to desktop presentations.

## VAIO Action Setup

*Sony Electronics Inc.*

VAIO Action Setup manages the settings for your computer's Shortcut keys and i.LINK\* interface.

## VAIO Support Agent

*Sony Electronics Inc.*

VAIO Support Agent provides immediate, interactive, on-line support.

## MovieShaker™

This application can be used to create fun and innovative movies without any knowledge of film editing. In a few simple steps, motion pictures can be combined with special effects, still images (pictures), and music files and then saved in a format most computers can play.

### Main window

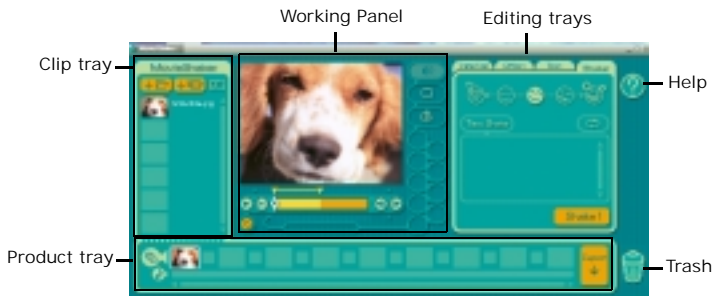

### Importing Images and Sound Clips

- 1 Click  .
- 2 Find the file you want to add.
- 3 Select the file.
- 4 Click Open. The file is added to the Clip tray.



Importing files over 75 seconds in length may cause MovieShaker to stop responding.

## Create a Movie using Shaker

After adding clip(s) to the Clip tray, you can create a short movie using the Shaker feature. Shaker randomly select clips from the Clip tray to create a 30-second scene.

- 1 Click the Shake tab.
- 2 Select a mood by clicking a face in the Shaker tray.

### Shaker Tray



- 3 Click **Shake!**. A thirty second scene is automatically generated and saved to the Product tray.
- 4 To preview, switch the Work Panel to Product tray mode and press play.



Scenes created with Shaker begin with black frame and after processing are placed in the first available slot on the Product tray. Limit the number of scenes placed on the Product tray to 10 or less. MovieShaker may stop responding if too many scenes are placed on the Product tray.

## Editing Clips and Scenes

You can edit your movie by adding effects and text, adjusting the color and contrast, and modifying the length of clips.

### Working Panel

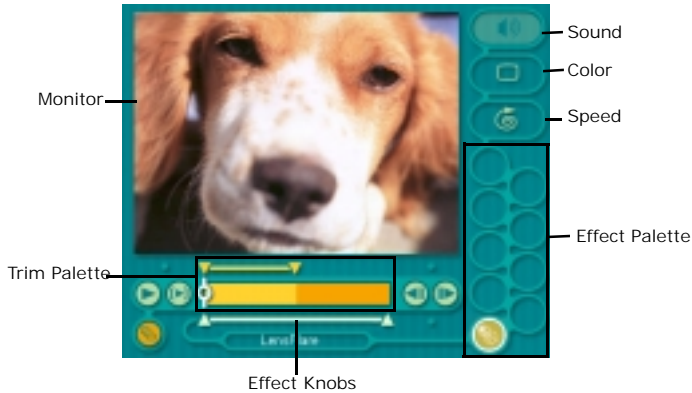

Adding effects to a scene or a clip:

- 1 Double-click the clip or scene to move it to the Working Panel.
- 2 Select the Effects tab from the Editing tray.
- 3 Drag and drop the Effect you want to add from the Effects tray to the Effects palette on the Working Panel.



To preview an Effect, click on the clip in the Working panel monitor. Your clip displays with the new effect on the Effect tray monitor.

- 4 See help for instructions on adjusting effect duration and replaying clips/scenes.

## Saving a Movie

- 1 Verify that the clip(s) you want to save is on the Product tray. See Help for more details on saving movies.
- 2 Click Export.



- 3 Select the format in which you want the document to be saved.
- 4 Click Next.
- 5 Locate the folder to which you want the file saved.
- 6 Name the file.
- 7 Click Save.

**Exporting movies may take a long time to complete—Saving movies as DV (Digital Video) takes the longest and Quick-Save is the fastest. MovieShaker can play video files up to 65 MB in length.**



For DV playback and smooth video playback, we recommend the following resolution/refresh rates: 1024 x 768/75 Hz or lower.

## PictureGear™

PictureGear is a digital image management application that allows you to see all the images stored in any directory on your computer. Thumbnail views provide quick reminders of your pictures. Brighten, contrast, enhance, resize, crop, and color-correct your pictures. Create panoramic views, animations, screen savers, wallpaper, still pictures from MPEG, and even html photo albums.

### *Managing Your Pictures*

Use the collection feature to manage your pictures.

- 1 Click the Folder tab and browse to locate your pictures.
- 2 Select the pictures you want to have in a collection.
- 3 From Collection menu, select Create New Collection.
- 4 Enter a name for the collection and then click OK.

### *Creating a Photo Album*

- 1 Select the pictures you want to use to make an album.
- 2 From the Utilities menu, select Album Maker.
- 3 Choose the type of Album you want and click OK.

- 4 Now add more pictures, frames, text, and effects.
- 5 When you are finished, select Create Album in File menu or click the Create Album icon on the toolbar.
- 6 Designate the folder where you want to save the Album.
- 7 Enter the Target Album name, select Thumbnails and click OK.
- 8 The new album can be viewed using most internet browsers.

### **Using Panorama Maker**

Panorama Maker stitches a group of still images into a 360 degree panoramic picture. The source images should be the same size and overlap 20%.

How to stitch a panoramic picture:

- 1 Gather the source images into the same folder or collection.
- 2 Select the images you want to use.



We recommend 12 landscaped or 16 portrait pictures.

- 3 From the Utilities menu select Panorama Maker.
- 4 Select the correct lens and click OK. (If 35mm lens is selected, the prompt does not appear; to select a different lens, click the lens icon.)
- 5 Click the panoramic icon, near the bottom of the window.
- 6 Click Full Stitch.

### **Making Still Images and Panoramic from MPEG**

- 1 Select the MPEG file.
- 2 From the Movie/Sound menu, select Scene break down.
- 3 Then select Movie Stitch, to create a panoramic picture.

## For Answers to Your Software Questions

*Acrobat Reader®*, *Adobe PhotoDeluxe® Home Edition*, *Adobe Premiere® LE*  
(*Adobe Systems Incorporated*)

---

Web site	<a href="http://www.adobe.com/">http://www.adobe.com/</a>
phone	206-675-6126 (fee-based support)
e-mail	techdocs@adobe.com
hours	M-F, 6 AM-5 PM (Pacific Time)

---

*America Online® (America Online)*

---

Web site	<a href="http://www.aol.com/">http://www.aol.com/</a>
phone	800-827-3338
hours	7 days a week, 24 hours a day

---

*CompuServe® 2000 (CompuServe)*

---

Web site	<a href="http://www.compuserve.com/">http://www.compuserve.com/</a>
phone	800-848-8990

---

*DirectCD, Easy CD Creator™ (Adaptec, Inc.)*

---

Web site	<a href="http://www.adaptec.com/">http://www.adaptec.com/</a>
phone	408-945-8600
hours	M - F, 8AM - 5 PM PT

---

*EarthLink Network TotalAccess® (EarthLink, Inc.)*

---

Web site	<a href="http://help.earthlink.net/techsupport/">http://help.earthlink.net/techsupport/</a>
phone	800-395-8410
e-mail	support@earthlink.net
hours	7 days a week, 24 hours a day

---

*McAfee® VirusScan® (Network Associates, Inc.)*

---

Web site	<a href="http://support.mcafee.com">http://support.mcafee.com</a>
phone	408-988-3832
e-mail	cybr@nai.com
hours	M-F 9AM-5PM Central Time

---

*Netscape Communicator® (Netscape Communications Corporation)*

---

Web site	<a href="http://help.netscape.com/support.html">http://help.netscape.com/support.html</a>
phone	800-411-0707 (fee-based support)
hours	7 days a week, 24 hours a day

---

*PhotoPrinter™ 2000 Pro (ArcSoft, Inc.)*

---

Web site	<a href="http://www.arcsoft.com">http://www.arcsoft.com</a> ; <a href="http://www.photoisland.com">http://www.photoisland.com</a>
phone	510-440-9901
e-mail	<a href="mailto:techsupport@arcsoft.com">techsupport@arcsoft.com</a>
hours	M - F, 8:30 AM - 5:30 PM PT

---

*Prodigy Internet® (Prodigy Communications Corporation)*

---

Web site	<a href="http://www.prodigy.com/">http://www.prodigy.com/</a>
phone	800-213-0992
hours	7 AM - 3 AM (Eastern Time)

---

*Quicken® 2000 Basic (Intuit, Inc.)*

---

Web site	<a href="http://www.intuit.com/support">http://www.intuit.com/support</a>
phone	900-555-4932 (fee-based support)
hours	M - F, 5AM - 5PM (Pacific Time)

---

*Sony Applications (Sony Electronics, Inc.)*

---

Web site	<a href="http://www.sony.com/pcsupport">http://www.sony.com/pcsupport</a>
phone	888-4SONYPC (888-476-6972)*
hours	7 days a week, 24 hours a day

---

*Sound Forge® XP (Sonic Foundry, Inc.)*

---

Web site	<a href="http://www.sonicfoundry.com/">http://www.sonicfoundry.com/</a>
phone	608-256-5555
fax	608-250-1745
e-mail	<a href="http://sonicfoundry.com/support/SupportMail.asp">http://sonicfoundry.com/support/SupportMail.asp</a> (online form)
hours	M-F, 7 AM-10 PM (Central Time)

---

*Windows® Millennium Edition, Windows® 2000 Professional, Word 2000, Internet Explorer (Microsoft Corporation)*

---

Web site	<a href="http://www.microsoft.com/support/">http://www.microsoft.com/support/</a>
phone	888-4SONYPC (888-476-6972)*
hours	7 days a week, 24 hours a day

---

\* Support from 1-888-4SONY PC is free of charge for 90 days after the original date of purchase.

## **Sony Service Center**

For the Sony Service Center nearest you, call 1-888-4SONYPC (1-888-476-6972) or find Sony Customer Service on the Web at <http://www.sony.com/pcsupport>.

## **About Your Recovery CDs**

### **Application Recovery CD(s)**

*Sony Electronics*

This program allows you to reinstall individual applications and device drivers. Use it to restore corrupted or accidentally erased files.

### **System Recovery CD(s)**

*Sony Electronics*

This program allows you to restore the software titles that shipped with your computer if they become corrupted or are erased accidentally. It can be used only to restore the hard disk of this Sony computer.

### **Driver Recovery CD(s)**

*Sony Electronics*

This program allows you to reinstall individual device drivers. Use it to restore corrupted or accidentally erased files.

## Using Your Recovery CDs

The following sections describe how to use the Application Recovery, System Recovery, and Driver Recovery utilities.

### Using the Application Recovery CD(s)

The Application Recovery CD(s) allows you to reinstall individual applications and device drivers if they are corrupted or erased. Reinstalling an individual device driver or software title may correct a problem you are experiencing with your computer, and you may not need to recover the entire contents of your hard drive. If you do need to reinstall all the software titles that shipped with your computer, use the System Recovery CD(s). See “Using the System Recovery CD(s)” on page 127.



You must be in Windows to run the Application Recovery CD. If you have any questions on using the Application Recovery CD, contact Sony Customer Support.

### To use the Application Recovery CD(s)

- 1 Turn on your computer. If your computer is already on, close all applications.
- 2 When the Windows desktop appears, insert the Sony Application Recovery CD in the DVD-ROM drive. The Application Recovery utility loads automatically.
- 3 When the Application Recovery menu appears, select the icon for the application you want to restore and then follow the on-screen instructions to complete the recovery process.



Your system may include one or two Application Recovery CDs. If you have two Application Recovery CDs, insert the first CD to run the Application Recovery program. You may be prompted to insert the second CD, depending on the application you wish to restore.

## Using the System Recovery CD(s)

You can reinstall software titles that shipped with your computer if they are corrupted or erased. You may not need to recover the entire contents of your hard drive. If you experience a problem with your computer, reinstalling an individual device driver or software title may correct the problem. Use the Application Recovery CD(s) to reinstall individual applications or device drivers. See “Using the Application Recovery CD(s)” on page 126.

The System Recovery CD contains a backup copy of all the software originally installed on your hard disk drive. **It can be used only to recover the hard disk of the notebook you purchased.**

The System Recovery utility gives you Full Restore with Format, that is it formats the hard disk drive and then restores all the original software.

**Full Restore with Format removes all the information on the hard disk drive. You will lose any software you have installed and any other files you have created since you started to use your computer. This means you will have to reinstall any applications that were not included with the computer when you purchased it. If you have any questions on using the System Recovery CD, contact Sony Customer Support.**

### To use the System Recovery CD(s)

- 1 Insert the Sony System Recovery CD in the DVD-ROM drive.
- 2 Shut down your computer as described in “Shutting Down Your Notebook” on page 35.
- 3 Wait four seconds and turn on your computer.
- 4 Click OK to signify you have read and accept the Microsoft End-User License Agreement.
- 5 When the System Recovery menu appears, follow the on-screen instructions to complete the recovery process.

### ***If your computer does not start from the Recovery CD***

- 1 Press the power button and hold it for more than four seconds to turn off the computer.
- 2 Turn on the computer. When the Sony logo is displayed, press the F2 key. The BIOS setup menu screen appears.
- 3 Press the arrow keys to select the Exit menu.
- 4 Press the arrow keys to select “Get Default Values” and then press the Enter key. The message “Load default configuration now?” appears.
- 5 Check that “Yes” is selected, then press the Enter key.
- 6 Press the arrow keys to select “Exit” (Save Changes) and then press the Enter key. The message “Save configuration changes and exit now?” appears.
- 7 Check that “Yes” is selected, then press the Enter key. The computer restarts from the Recovery CD.



Your system may include one or two System Recovery CDs. If you have two System Recovery CDs, insert the first CD to run the System Recovery program. You are prompted to insert the second CD once the information from the first CD has been installed.

The recovery process takes from 30 to 60 minutes to complete.

After recovering your system using the SRC D, you may be prompted to insert your ARCD after restarting Windows. Insert the ARCD to automatically complete recovery of your system.

### ***Recovering Microsoft® Word 2000***

If you recover your operating system using the System Recovery CD, Microsoft Word 2000 will not be recovered. Use the supplied Word 2000 CD to recover this application.



## **Using the Driver Recovery CD(s)**

The Driver Recovery CD utility allows you to reinstall individual drivers and repair software applications if they become corrupted or are accidentally erased. You can reinstall an individual driver to correct a problem that you are experiencing with your computer, hardware, or software application. VAIO Support Agent uses a vault feature on the Driver Recovery CD(s) to repair software applications.



You must be in Windows to run the Driver Recovery CD utility.

### **To use the Driver Recovery CD(s)**

- 1** Turn on your computer. If your computer is already on, close all applications.
- 2** When the Windows desktop appears, insert the Driver Recovery CD in the optical drive. The Driver Recovery utility loads automatically.
- 3** When the Driver Recovery menu appears, follow the on-screen instructions to complete the recovery process.

### **To repair software applications using VAIO Support Agent**

The Driver Recovery CD utility has an information vault that contains the original characteristics for the preinstalled software applications that are protected by VAIO Support Agent.



# Troubleshooting

This section describes how to solve common problems you may encounter when using your notebook. Many problems have simple solutions, so try these suggestions before you contact Sony PC Support (<http://www.sony.com/pcsupport>).

## *Troubleshooting your notebook*

(Windows Me only) When starting your notebook for the first time, the VAIO InitManager dialog box will appear. Please select “OK” to begin initial setup. If you do not execute the initial setup, you cannot use some of the VAIO original hardware functions such as Jog Dial, Power Management tool, the scroll function of touchpad, and the keyboard shortcut key function combined with the Fn key.

### *My notebook does not start.*

- ❑ Check that the notebook is plugged into a power source and that it is turned on. Check that the power indicator on the front panel of the notebook indicates that the power is on.
- ❑ Check that the battery packs are inserted properly and that they are charged.
- ❑ Make sure there is no diskette in the floppy disk drive.
- ❑ Confirm that the power cord and all cables are connected firmly, as described in “Connecting Peripheral Devices” on page 81.
- ❑ If you plugged the notebook into a power strip or UPS, make sure the power strip or UPS is turned on and working.
- ❑ If you are using an external display, check that it is plugged into a power source and turned on. Check that the brightness and contrast controls are adjusted correctly. See the manual that came with your display for details.
- ❑ Moisture condensation may have occurred. Do not use the notebook for at least one hour and then turn on the notebook.
- ❑ Take the battery pack off the notebook, unplug the power cord and plug it again, then turn on the power.

***My notebook starts, but my system doesn't start properly.***

- ❑ When the internal backup battery is low on power, it may not start your system properly. The message “Press <F1> to resume, <F2> to setup” appears at the bottom of the screen. Follow these steps:
  - 1 Press F2. The BIOS Setup menu appears.
  - 2 Set the date (month/day/year). Press Enter.
  - 3 Press ↓ to select System Time, then set the time (hour: minute: second). Press Enter.
  - 4 Press → to select Exit, then press ↓ to select Get Default Values. The message “Load default configuration now?” appears.
  - 5 Select Yes and press Enter.
  - 6 Select Exit (Save Changes), and then press Enter. The message “Save Configuration changes and exit now?” appears.
  - 7 Select Yes, and then press Enter. The notebook restarts.

***My notebook starts, but the message “Operating system not found” appears and Windows does not start.***

- ❑ Make sure there is no diskette in the floppy disk drive (nonbootable).
- ❑ If a nonbootable diskette is in the drive, follow these steps:
  - 1 Turn off the notebook, and then remove the diskette.
  - 2 Restart the notebook and confirm that Windows starts properly.
- ❑ If Windows still does not start, follow the steps below to initialize the BIOS:
  - 1 Remove any diskette from the floppy disk drive.
  - 2 Turn off the notebook.
  - 3 Remove any peripheral devices connected to the notebook.
  - 4 Turn on the notebook.
  - 5 Press the F2 key when the Sony logo appears. The BIOS setup menu screen appears.
  - 6 Press the directional arrow keys to select the Exit menu.

- 7 Press the arrow keys to select “Get Default Values” and then press Enter. The message “Load default configuration now?” appears.
- 8 Select Yes, then press Enter.
- 9 Use the directional arrow keys to select “Exit” (Save Changes), and then press Enter. The message “Save configuration changes and exit now?” appears.
- 10 Select Yes, then press Enter. The notebook restarts.

If your notebook continues to display the message “Operating system not found,” and Windows does not start, contact Sony Customer Support.

### ***My notebook stops responding or does not shut down.***

It is best to shut down your notebook using the Shut Down command on the Windows Start menu. Using other methods, including those listed here, may result in loss of unsaved data.

- ❑ Try restarting the notebook. On the Windows taskbar, click the Start button, click Shut Down, and then click Restart.
- ❑ (Windows Me) If you cannot restart as described in the preceding step, you can restart the notebook by pressing Ctrl+Alt+Delete keys (at the same time) twice.  
(Windows 2000) If you cannot restart as described in the preceding step, you can restart the notebook by pressing Ctrl+Alt+Delete keys (at the same time) and clicking Shut Down on Windows® Security screen.
- ❑ If the previous step does not work, press and hold the power button for at least four seconds. This turns off the power.
- ❑ (Windows Me) If your notebook stops responding while playing a CD or DVD, stop the CD or DVD, and restart the notebook by pressing Ctrl+Alt+Delete keys (at the same time) twice.  
(Windows 2000) If your notebook stops responding while playing a CD or DVD, stop the CD or DVD, and restart the notebook by pressing Ctrl+Alt+Delete keys (at the same time) and clicking Shut Down on the Windows® Security screen.
- ❑ Unplug the notebook from the AC adapter and remove the battery pack from your notebook.

 Pressing Ctrl+Alt+Delete keys (at the same time) or turning off the notebook with the power switch may result in data loss in files that are currently open.

***My notebook does not enter the power saving mode I selected. (Windows Me models only)***

- Click Start, point to Program, point to Accessories, point to System Tools, and then click System Information.  
The Help and Support window appears.
- Click System Configuration Utility under the Tools menu.
- Click the Advanced button on the General tab, and confirm the following information:
  - 1 Enable Deep Sleep is selected with a checkmark.
  - 2 The message “Standby function is enabled” is displayed. If the message reads “Standby function is disabled,” click the Enable button.
  - 3 The message “Hibernation feature is enabled” is displayed. If the message reads “Hibernation feature is disabled,” click the Enable button.
  - 4 Click OK and restart your notebook.

 When using an external floppy disk drive, power saving mode may not work properly.

***My system enters System Idle mode when System Suspend mode has been selected.***

- If you are connecting an optical drive with a PC card, disconnect it by stopping the PC card. See “To remove a PC card” on page 61 for more information.
- Make sure the PC Card is compatible with your notebook’s Windows<sup>®</sup> operating system.

 (Windows 2000 only) When the notebook enters and returns from a power saving mode after removing the optical drive, the message “Unsafe Removal of Device” may appear and the device name is shown listed as “Secondary IDE Channel.” Click OK.

***The Power Management setting is not responding.***

Your notebook's operating system may become unstable if a lower power state, such as system hibernation is initiated, and then changed before the notebook completely enters the lower power state. To restore the notebook to its normal operating stability:

- ❑ Close all open applications.
- ❑ Push and hold the power button for four seconds or longer to shut down the notebook.

***The sound of my notebook's fan is too loud.***

Use the PowerPanel utility to change the Thermal Control Strategy setting to Quiet. This setting slows down the CPU speed. See PowerPanel Help for more information.

***The TV screen was blank when I returned from a power saving mode.***

Select the TV display mode, and remove the DVD video disc if it is inserted in the DVD-ROM drive.

***Troubleshooting the LCD screen******My LCD screen is blank.***

- ❑ Check that the notebook is plugged into a power source and that it is turned on.
- ❑ Check that the power indicator on the notebook is on.
- ❑ Check that the battery pack(s) is inserted properly and charged.
- ❑ The notebook may be in LCD (Video) Standby mode. Press any key to activate the screen.
- ❑ The display mode may be set to external display mode. Press and hold the Fn key while pressing F7 several times.

***My LCD screen does not restore.***

Press F5 once to restore the screen.

***The image on my connected external display is not centered or sized properly.***

Use the controls on your external display to adjust the image. See the manual that came with your display for more information.

***I want to change the video resolution of my display.***

You can use independent controls to change the video resolution of your display.

- ❑ Click Start, point to Settings, point to Control Panel, and then click the Display icon.

The Display Properties dialog box appears.

- ❑ Click on the Settings tab.
- ❑ Move the Screen Area slider to change your video resolution.

***I cannot switch the LCD display to TV display and vice versa.***

- ❑ Remove the DVD disc if it is inserted in the DVD-ROM drive.

***Troubleshooting the mouse and touchpad***

***My mouse does not work.***

- ❑ If you are using an external mouse, check that the mouse is plugged into the mouse connector. See “Connecting a Universal Serial Bus (USB) Device (Mouse or Keyboard)” on page 105 or “Connecting an external mouse or keyboard” on page 89 for details.
- ❑ If you are using an optional Sony USB mouse PCGA-UMS1 series, check that the mouse is plugged into the USB connector.

***My touchpad does not work properly.***

- ❑ You may have disabled the touchpad without connecting a mouse to the notebook. To enable the touchpad:
  - 1 Click Start, point to Programs, and click Sony Notebook Setup.
  - 2 Select the Touchpad tab.
  - 3 Click Use touchpad, and click OK.
- ❑ If your touchpad is interpreting a single tap as a double-click, you must adjust the button assignments. Follow these steps:



- 1 Click Start, point to Control Panel, and then click on the Mouse icon.
- 2 Change the button assignments in the Mouse Properties dialog box. (One of the buttons is assigned to the double-click action.)

***The pointer does not move while using the Touchpad or Mouse.***

- ❑ Click the Start button on the Windows taskbar, and select Shut Down to display the Shut Down Windows dialog box, then press Enter.
- ❑ (Windows Me) If you cannot turn off your notebook as described in the step above, press Ctrl+Alt+Delete keys (at the same time) twice to restart the notebook.  
(Windows 2000) If you cannot turn off your notebook as described in the step above, press Ctrl+Alt+Delete keys (at the same time) and click Shut Down on Windows® Security screen to restart the notebook.
- ❑ If you cannot restart your notebook as described in the step above, press and hold the power button for more than four seconds to turn off the notebook.
- ❑ If the pointer does not move while playing a disc, press Ctrl+Alt+Delete keys (at the same time) to stop playback and restart the notebook.

***Troubleshooting drives, PC cards and peripheral devices***

***I inserted a compatible device into the multipurpose drive bay, but the icon does not appear in the My Computer window.***

- ❑ The device has not been recognized. Put the notebook into System Idle mode by pressing the Fn and S keys and then resume.
- ❑ If the device is still not recognized or does not appear in the My Computer window, remove and reinsert it.

***My floppy disk drive can not write to a diskette.***

- ❑ If the diskette is write-protected, disable the write-protect feature or use a diskette that is not write-protected.
- ❑ Check that the diskette is properly inserted into the floppy disk drive.

***My CD or DVD drive is not playing my CD or DVD properly.***

- ❑ Make sure the optical drive is inserted correctly into the multipurpose bay.
- ❑ Make sure the label of the disc is facing up.

- ❑ If the disc requires software, make sure the software is installed according to the manufacturer's instructions.
- ❑ A dirty or damaged disc may cause the notebook to stop responding while it tries to read the disc. If necessary, restart the notebook, remove the disc, and then check it for dirt or damage.
- ❑ If you see video but can not hear audio, check all of the following:
  - ❑ Check that your DVD-ROM drive does not have the mute setting enabled.
  - ❑ Check the volume setting in the audio mixer.
  - ❑ If you are using external speakers, check the volume settings, and then check the connections between your external speakers and the notebook.
  - ❑ Click Start > Control Panel > System > Device Manager. Check that the correct drivers are installed properly.
- ❑ Do not use adhesive labels to identify the CD. The label may come off while the disc is in use in the optical drive and cause the drive to malfunction.
- ❑ If a region code warning appears when you try to use your DVD-ROM drive, it may be that the DVD you are trying to play is incompatible with the DVD-ROM drive. Check the region code listing on the DVD packaging.
- ❑ Moisture condensation may have occurred. Leave the notebook idle for at least 1 hour with the notebook turned on.

***My CD, or DVD drive tray does not open.***

- ❑ Make sure the notebook is turned on.
- ❑ Press the Eject button on the DVD-ROM drive.
- ❑ If the Eject button does not work, you can open the tray by inserting a sharp, pointed object into the hole to the right of the Eject button.

***I cannot use digital video (DV) devices. The message "DV equipment seems to be disconnected or turned off" appears.***

- ❑ Check that the DV device is turned on and that the cables are properly connected.
- ❑ If you are using multiple i.LINK\* devices, the combination of the connected devices may cause unstable operation. In this case, turn off your notebook and all connected devices. Disconnect the devices that are not in use. Check the connections for each device, then restart your notebook.

***The i.LINK\* -compatible devices connected to the Mini Docking Station do not work.***

- ❑ Use the i.LINK\* connector that is located on your notebook.
- ❑ If the message “There are no Digital Video devices connected to this computer, or the power is off” appears, unplug the i.LINK\* cable and try plugging it in again.

***My PC card is not working.***

- ❑ Make sure the PC card is compatible with Microsoft® Windows®.
- ❑ Use the Sony Notebook Setup utility to disable devices you are not currently using.
- ❑ If you are using two PC cards, use the Sony Notebook Setup utility to disable the devices you are not currently using.

***Troubleshooting software***

***My software program stops responding or crashes.***

Contact the software publisher or designated provider for technical support. See the “About Software” section of this manual.

***When I click an application icon, the message “You must insert the application CD into your CD-ROM (DVD-ROM/CD-RW) drive” appears and the software does not start.***

- ❑ Some titles require specific files that are located on the application CD. Insert the disc and try starting the program again.
- ❑ Make sure you place the CD in the tray with the label side facing up.

---

\* i.LINK is a trademark of Sony used only to designate that a product contains an IEEE 1394 connection. The i.LINK connection may vary, depending on the software applications, operating system and i.LINK-compatible devices. All products with an i.LINK connections may not communicate with each other.

Please refer to the documentation that came with your i.LINK-compatible device for information on operating conditions and proper connections. Before connecting i.LINK-compatible PC peripherals to your system, such as a CD-RW or Hard Disk Drive, confirm their operating system compatibility and required operating conditions.

***I hear background “noise” while using Windows Media Player to play my music CDs.***

Sony suggests using the preinstalled Media Bar software to play audio CDs.

***I can not use the DVgate software.***

If your notebook is using the Ultimate Battery Life profile for its power saving mode, you cannot use DVgate or Smart Connect software. Please select another profile.

***My voice-related software does not work properly.***

- ❑ Disable echo function of the microphone by taking the following steps:
  - 1 Click Start, point to Settings, and then point to Control Panel.
  - 2 Click Yamaha DS-XG.
  - 3 Click the Echo tab and remove the checkmark. Click OK.
- ❑ Contact the software publisher or designated provider for technical support

***Troubleshooting the modem***

***My modem does not work.***

- ❑ Check that the phone line is plugged into the line jack. See “Connecting a Phone Line” on page 82 for details.
- ❑ Check that the phone line is working. You can check the line by plugging in an ordinary phone and listening for a dial tone.
- ❑ Check that the phone number the program is dialing is correct.
- ❑ Check that the software you are using is compatible with the notebook’s modem. (All preinstalled Sony programs are compatible.)

***My modem connection is slow.***

Your notebook is equipped with a 56K/V.90 compatible modem. Many factors may influence modem connection speed, including telephone line noise or compatibility with telephone equipment (such as fax machines or other modems). If you think your modem is not connecting properly to other PC-based modems, fax machines, or your Internet Service Provider, check the following:

- ❑ Have your phone company check that your phone line is free from any line noise.
- ❑ If your problem is fax-related, check that there are no problems with the fax machine you are calling and that it is compatible with fax modems.
- ❑ If you are having a problem connecting with your Internet Service Provider, check that the ISP is not experiencing technical problems.
- ❑ If you have a second phone line available, try connecting the modem to that line.

## ***Troubleshooting audio***

### ***My speakers have no sound.***

- ❑ If the built-in speakers are turned off, press Fn+F3 to turn on the speakers. You can also turn on the speakers using the Jog Dial control.
- ❑ If the speaker volume is turned to the minimum, press Fn+F4, and then press **↑** or **→** to increase the volume or you can use the Jog Dial control to adjust the volume.
- ❑ If nothing is displayed when you press Fn+F3 or Fn+F4.
  - 1 Double click System in Control Panel.
  - 2 Set the sound device to enable in Device Manager.
- ❑ If your notebook is powered by batteries, check that the battery packs are inserted properly and that they are charged.
- ❑ If you are using an application that has its own volume control, check that the volume is turned up.
- ❑ Check the volume controls in Windows®.
- ❑ If you connect external speakers, check that the speakers are properly connected and the volume is turned up. If the speakers have a mute button, make sure it is off. If the speakers are powered by batteries, check that the batteries are inserted properly and that they are charged.
- ❑ If you have connected an audio cable to the Headphone connector, disconnect the cable.

### ***My microphone does not work.***

If you are using an external microphone, check that the microphone is plugged into the Microphone connector. See “Connecting an External Microphone” on page 104 for details.

### ***Troubleshooting the printer***

#### ***I cannot print.***

- The default setting for the printer port mode is correct for most printers. If you cannot print, try changing the printer port mode. In Sony Notebook Setup, select the Printer tab. If the printer port mode is set to ECP, change it to bi-directional. If the printer port mode is set to bi-directional, change it to ECP. See “Displaying the Sony Notebook Setup Screen” in the “*Customizing Your VAIO® Notebook*” manual for details on using Sony Notebook Setup.
- Your connected printer may not function after the computer resumes from a power saving mode. If this occurs, follow these steps to reset the printer connection:
  - Right-click the My Computer icon on the desktop, and then select Properties.
  - Click the Device Manager tab.
  - Select Refresh, and then click OK. The printer should function properly.

## Supplemental Information

### *Switching Between NTSC and PAL Standards*

Your computer is designed to allow you to switch between NTSC and PAL standards. For details on switching from one standard to another, go to Ask Sony at <http://www.sony.com/pcsupport>.

### *Selecting the Printer Port Mode for Your Printer*

The default setting for the printer port mode is correct for most printers. If you cannot print, try changing the printer port mode. In Sony Notebook Setup, select the Printer tab. If the printer port mode is set to ECP, change it to bi-directional. If the printer port mode is set to bi-directional, change it to ECP. See “Displaying the Sony Notebook Setup Screen” in “*Customizing Your VAIO® Notebook*” for details on using Sony Notebook Setup.

### *Using the Touchpad*

In addition to using the left and right buttons for mouse clicks, you can tap on the touchpad to indicate mouse clicks. By default, the tapping feature is disabled. If you wish to turn on the tapping feature, click the Mouse icon in the Control Panel, select the Tapping tab, and click the check box to enable tapping.

### *Using Optical Out to Record Onto a MiniDisc*

To ensure proper operation, disable the IrDA feature before using Optical Out (from a Mini Docking Station) to record onto a MiniDisc. To disable this feature, from the Start menu, point to Settings and Control Panel. Select Infrared. Click the Options tab, and uncheck the “Enable infrared communication” checkbox.

### *Hardware Temperature*

The AC adapter or the bottom panel of your computer may become warm. This is the result of CPU operation and does not indicate a malfunction of the computer. The actual temperature varies depending on the peripherals and software you are using and the length of time that the unit is in use. The AC adapter may also become warm when the computer is off and the battery is charging.

## Getting Help

Sony provides several support options for your Sony computer. When you have questions about your computer and the preinstalled software, check these sources for answers, in the following sequence:

---

**1**     ***VAIO® Notebook User Guide***

The User Guide (this manual) contains information on how to get the most from your computer, find help, and solve common problems. It also contains product specifications.

---

**2**     ***Customizing Your VAIO® Notebook***

The electronic document contains additional information on customizing your computer. You can access this guide from the Windows Start menu by selecting Programs and then VAIO User Manual.

---

**3**     ***Manuals and online help files that may accompany your preinstalled software***

Most of the manuals for preinstalled software are located on your hard disk drive as online help files. You can access the online help files from the Help menu in the specific application. A printed manual is available for some applications.

---

**4**     ***VAIO Support Agent***

VAIO Support Agent can be accessed from the Windows desktop. Using advanced diagnostic technology, Sony's VAIO Support Agent runs scheduled protections of your applications, network settings, and other important software settings. When your software is protected, you can use VAIO Support Agent to repair software problems by restoring your software to any of the previously protected states.

---

**5**     ***Sony PC Support***

Provides instant access to information on commonly encountered problems. Enter a description of your problem and the Knowledge Database searches for the corresponding solutions online. You can access the Sony PC Support at: <http://www.sony.com/pcsupport>

---

**6**     ***Sony Fax-on-Demand***

This service provides you with answers to commonly asked questions. You can use this automated service to request a list of available topics and then select the topics that you want to receive. To contact the Sony fax-on-demand service, call 1-888-4SONYPC (1-888-476-6972). (Requires a fax machine or your fax software.)

---

**7**     ***Calling Sony Customer Support***

You can call and speak with a Sony Customer Support Representative without using your computer by calling 1-888-4SONYPC (1-888-476-6972). Software support is available free of charge for 90 days after the original date of purchase.

---



# Specifications

<i>Model</i>	<i>PCG-XG500/ PCG-XG500K</i>	<i>PCG-XG700/ PCG-XG700K</i>
<i>Processor</i>	700 MHz** Intel® Pentium® III with Intel® SpeedStep™ Technology†	750 MHz** Intel® Pentium® III with Intel® SpeedStep™ Technology†
<i>Hard Disk Drive</i>	10 GB‡	20 GB‡
<i>Standard RAM</i>	128 MB PC100 SDRAM (One 128 MB module), expandable to 256 MB	
<i>LCD Screen</i>	13.3" XGA TFT	14.1" XGA TFT
<i>L2 Cache Memory</i>	256 KB (CPU Integrated)	
<i>MPEG</i>	MPEG1 and MPEG2 Digital Video; supports full-screen playback	
<i>Graphics</i>	128-bit accelerator with 8 MB Video SGRAM, AGP, 3D acceleration	
<i>Sound Capabilities</i>	16-bit CD-quality stereo sound	
<i>Diskette Drive</i>	Removable 3.5" 1.44 MB	
<i>DVD-ROM Drive</i>	Reads CD data up to 24X max. variable transfer rate. Reads DVD data up to 8X max. variable transfer rate.	
<i>CD-RW Drive</i>	Reads CD data up to 20X max. variable transfer rate. Writes CD-R data up to 4X max. variable transfer rate. Writes CD-RW data up to 4X max. variable transfer rate. (The CD-RW drive is optional on PCG-XG500K.)	
<i>Laser Diode Properties</i>	DVD-ROM drive wave length 780 nm and 650 nm laser output 30.2 µW. CD-RW drive wave length 785 nm laser output 158 µW.	
<i>Modem</i>	V.90/K56flex compatible data/fax modem‡‡	
<i>Infrared</i>	Supports 4 Mbps, 1.1 Mbps, and 115 Kbps IrDA Standard	
<i>Hot-swappable Multipurpose Bay</i>	Supports: Floppy disk drive (included) Second rechargeable battery (optional) DVD-ROM drive (included) CD-RW drive (supplied with PCG-XG700/XG700K only) 2nd hard disk drive (optional)	
<i>Expansion Capabilities</i>	Two type II PC cards and One type III PC card CardBus support	

<b>Model</b>	<b>PCG-XG500/ PCG-XG500K</b>	<b>PCG-XG700/ PCG-XG700K</b>
<b>Built-in Capabilities</b>	Microphone, Stereo speakers, Touch pad	
<b>Telecommunication Capabilities</b>	Fax send/receive <sup>††</sup>	
<b>Connection Capabilities</b>	USB port S400 i.LINK <sup>®*</sup> AC adapter Headphone Mini Docking Station Infrared Microphone Type II (2) & III PC Cards RJ-11 phone jack	
<b>Additional Connection Capabilities with Mini Docking Station</b>	Optical digital audio output VGA monitor S400 i.LINK <sup>*</sup> Mouse (PS/2 <sup>®</sup> style)/keyboard Control A1 II S Video (output) Video (output) Serial port Line in Line out Two USB ports Parallel (printer) port Floppy disk drive Type II (1) & III PC Cards	
<b>Supplied Accessories</b>	Floppy disk drive Rechargeable battery AC adapter and power cord Weight Saver FDD cable FDD stand for Mini Docking Station DVD-ROM drive CD-RW drive (for PCG-XG700/XG700K only) Mini Docking Station	
<b>Power Requirements</b>	73.2 watts maximum (19.5V DC/AC 100-240V)	
<b>Power Management</b>	Energy Star compliant Advanced Configuration and Power Interface (ACPI)	
<b>Battery</b>	Lithium-ion, supports dual battery operation	

<b>Model</b>	<b>PCG-XG500/ PCG-XG500K</b>	<b>PCG-XG700/ PCG-XG700K</b>
<b>Dimensions</b>	11.9"(w) x 1.8"(h) x 9.9"(d), 12.1" (w) x 1.8" (h) x 10.3" (d) (303x45x 250.7mm)	(308x45x 261.2mm)
<b>Weight</b>	6.0 lbs. (2.7 kg) (with battery and weight saver) 6.4 lbs. (2.9 kg) (with battery and floppy disk drive)	6.2 lbs. (2.8 kg) (with battery and weight saver) 6.5 lbs. (3.0 kg) (with battery and floppy disk drive)
<b>Operating Temperature</b>	41° F to 95° F (+5° C to 35° C), temperature gradient less than 18° F (10° C) per hour	
<b>Operating Humidity</b>	20% to 80% (not condensed) provided that humidity is less than 65% at 95° F (35° C), hygrometer reading of less than 84° F (29° C)	
<b>Storage Temperature</b>	-4° F to 140° F (-20° C to 60° C), temperature gradient less than 18° F (10° C) per hour	
<b>Storage Humidity</b>	10% to 90% (not condensed) provided that humidity is less than 20% at 140° F (60° C), hygrometer reading of less than 95° F (35° C)	

\* i.LINK is a trademark of Sony used to designate that a product contains an IEEE 1394 connection.

The i.LINK connection may vary, depending on the software applications, operating system and i.LINK-compatible devices. All products with an i.LINK connection may not communicate with each other.

Please refer to the documentation that came with your i.LINK-compatible device for information on operating conditions and proper connection. Before connecting i.LINK-compatible PC peripherals to your system, such as a CD-RW or Hard Disk Drive, confirm their operating system compatibility and required operating conditions.

\*\* MHz denotes microprocessor internal clock speed; other factors may affect application performance.

† The processor may be reduced to a lower operating speed when operating on battery power.

‡ The size of your hard disk may differ if you purchased a specially configured system. GB means one billion bytes when referring to hard drive capacity. Accessible capacity may vary.

†† If a region code warning appears when you are using the DVD player, it could be that the DVD you are trying to play is incompatible with the DVD-ROM drive in your VAIO notebook. Region code indicators such as a "1" or "ALL" are labeled on some DVDs to indicate what type of player can play the discs. Unless a "1" or "ALL" is identified on your DVDs or on the packaging, you cannot play the disc on this player.

‡‡ Maximum speed for faxing is 14.4 kbps. Your 56K/V.90 compatible modem is capable of downloading at 53 kbps. Your online service or Internet Service Provider, however, may not support this technology or operate at this speed.

\*\*\*Height measured at thickest point. The thinnest height is 1.5" (39 mm).

Specifications are subject to change without notice.



# Index

## A

- AC adapter 27
- AC power 27
- adding
  - hardware 81
  - peripherals 81
- adjusting
  - brightness 35, 43
- Alt key 40
- Application Recovery CD 126
- Applications key 40

## B

- batteries 33
  - using 33
- battery packs 29
  - charging 31, 65
  - indicator light status 32
  - indicator lights 42, 64
  - inserting 29
  - inserting into battery bay 29
  - loading 29
  - power status 31
  - rechargeable 27
  - removing 32, 64, 66
- brightness
  - adjusting 35, 43
- built-in speakers
  - See also speakers 43
- buttons
  - Eject 53, 54

Start 35

Start (Windows) 35

## C

- cables
  - power cord 27
- canceling commands 40
- Caps Lock
  - indicator light 42
- CD-ROMs
  - cleaning 58
  - handling 58
- charging battery packs 31, 65
- choosing
  - power source 29
- cleaning
  - CD-ROMs and DVD-ROMs 58
- Closing your computer
  - intercooler flap 38
- coin-operated telephones 82
- computer 144
  - handling 19
  - starting 34
  - troubleshooting 131, 139
- connecting
  - coin-operated telephones 82
  - external speakers 103
  - hard drives 59
  - microphone 104
  - Mini Docking Station 85
  - monitor 100
  - multiple phone lines 82

- network 59
- party phone lines 82
- PBX 82
- phone line 82
- power source 27
- connectors
  - DC In 27
  - i.LINK 25
  - infrared 62
  - monitor
  - printer 89
  - USB 24, 26
- correction keys 40
- Ctrl key 40
- cursor-movement keys 40
- customer assistance
  - support options 144
- D
- DC In 27
- digital still camera 62
- diskettes
  - ejecting 50
  - handling 51
  - inserting into drive 50
  - troubleshooting 137
- display
  - options 102
  - See also monitor
  - selecting 102
- display filter
  - handling 20
- disposal of lithium ion battery 8
- Dolby Digital Decoder 97
- Dolby Digital™ Decoder 97
- Driver Recovery CD 129
- drives
  - installing additional hard disk 59
- DVD-ROM discs
  - ejecting 54
  - inserting 53
- DVD-ROM drive
  - closing tray 54
  - opening tray 53
  - using 53
- DVD-ROM drive tray
  - troubleshooting 138
- DVD-ROMs
  - cleaning 58
  - handling 58
- E
- Eject button 50, 53, 54
- ejecting
  - battery packs 66
  - diskettes 50
  - DVD-ROM discs 54
- electronic
  - documentation 144
- Energy Star 3
- ergonomic considerations 17
- Escape key 40
- external devices
  - display 102
    - See also monitor
  - speakers 43, 103
- F
- faxes
  - laws governing 7
- floppy disk drive
  - troubleshooting 137
- Fn key 40
  - combination commands 43
- function keys 40

**H**

- handling 19
  - CD-ROMs and DVD-ROMs 58
  - diskettes 51
- handling the LCD screen 19
- hard drives
  - indicator light 42
  - installing additional 59
- hardware
  - online support 144
- Help
  - Mouseware 47
- help 144

**I**

- i.LINK 25
- indicator lights 42
  - battery 42, 64
  - Caps Lock 42
  - hard drive 42
  - Num Lock 42
  - Scroll Lock 42
- infrared communication devices 62
  - other computers 62
- infrared port 62
- infrared transmission
  - active distance 63
  - troubleshooting 63
- input devices 6
- Insert key 40
- inserting
  - battery pack 29
  - diskettes into drive 50
  - DVD-ROM discs 53
- installation 18
- installing
  - hard drives 59
  - hardware 81

- peripherals 81

- Intercooler flap
  - closing 38
- interference 6

**J**

- Jog Dial control 74
  - using 75

**K**

- keyboard 40

**L**

- LCD
  - lock lever 34
  - selecting to display output 102
  - troubleshooting 135, 136
- LCD screen
  - handling 19
- lever
  - LCD 34
  - weight saver release 66
- lithium ion battery
  - disposal 8
- loading
  - battery pack 29

**M**

- MD 94
- Memory
  - adding 107
- microphone
  - connecting 104
  - troubleshooting 142
- Mini Docking Station 83, 85, 86, 87, 88, 89, 90, 91, 94, 95, 96, 97
  - attaching 85
  - Back 84

- Connecting Audio and Video 97
  - Left/Right 84
  - peripheral device
    - audio/video (AV) 94
      - CD player 94
      - MD player 94
    - floppy disk drive (FDD) 90, 91
    - printer 89, 90
    - TV/VCR 98
  - removing 87
  - Undocking 87
- Mini docking station
  - connecting
    - printer 89
  - Front 83
- modem
  - laws governing 7
  - troubleshooting 140
- monitor 24
  - connecting 100
  - selecting 102
  - switching among 43
- mouse
  - troubleshooting 136
- Mouse Properties screen 47
- Mouseware
  - accessing help 47
  - features 47
- MovieShaker instructions 118
- multiple phone lines 82

N

- navigation keys 40
- network
  - connecting 59
- Num Lock
  - indicator light 42
- numeric keypad area 40

O

- online
  - help 144
- opening
  - DVD-ROM drive tray 53
- operator keys 40
- output devices 6

P

- party phone lines 82
- PBX 82
- PC card
  - inserting 59
  - release button 59
  - removing 61
  - slot protector 60
  - slots 59
  - troubleshooting 139
  - Type III 59
- Peripheral device
  - printer 89
- peripheral devices
  - connecting 81
- phone
  - connecting line 82
  - jack 82
  - laws governing 7
- Ports
  - CONTROL A1 84
  - DC IN 84
  - i.Link 84
  - LINE IN 84
  - LINE OUT 84
  - Monitor 84
  - Mouse/Keyboard 84
  - OPTICAL OUT 84
  - Parallel (printer) 84
  - S VIDEO 84



- Serial 84
- SERIAL/CONTROL A1 switch 84
- USB 84
- VIDEO 84
- power 42
  - cord 27
  - switch 34
- power saving modes 78
  - System Hibernation 43, 79
  - System Idle 78
  - System Suspend 78
  - Video Standby 43
- power source 28
- power sources 29
  - connecting 27
- Print Screen key 40
- printer
  - connector 89
- printer connector 89
- R**
- radio interference 6
- rechargeable battery packs 27, 29
- recharging battery packs 31
- Recovery CD 126
- regulatory information 6
- removing
  - battery packs 32
  - diskettes 50
  - Mini Docking Station 87
- replacing
  - battery packs 64
- restoring data 126
- S**
- Scroll Lock
  - indicator light 42
- second battery pack 29, 64
- selecting
  - display 102
  - LCD 102
  - monitor 102
  - power source 29
- setting up your PC
  - support 144
- Shift key 40
- Shut Down Windows dialog box 35
- Shutting Down 35
- Sony Fax-on-Demand service 144
- Sony Service Center 125
- speakers
  - external 103
  - switching 43
  - troubleshooting 141
  - volume 43
- Specifications 145
- Start button 35
- starting
  - computer 34
- startup problems 36
- switching
  - display 43
  - monitor 43
- System Hibernation mode 43, 79
- System Suspend mode 43, 78
- T**
- technical support
  - support options 144
- touchpad 46
- troubleshooting 131
  - startup 36, 131
- turning on
  - computer 34

TV

interference 6

TV or a video deck 98

U

USB

connector 24, 26

V

VAIO Action Setup 74, 118

Video Standby mode 43

W

weight saver

attaching 64

Windows

Control Panel 63

Explorer 41

Find window 41

help 41

key 40

key combinations 41

Start button 35

taskbar 35, 133