

SONY

User Guide

Personal Computer
VGN-AR600 Series



Contents

- Before Use6
 - Documentation7
 - Ergonomic Considerations10
- Getting Started12
 - Locating Controls and Ports13
 - About the Indicator Lights20
 - Connecting a Power Source22
 - Using the Battery Pack23
 - Shutting Down Your Computer Safely27
- Using Your VAIO Computer28
 - Using the Keyboard29
 - Using the Touch Pad30
 - Using Special-function Buttons31
 - Using the Built-in MOTION EYE Camera.....33
 - Using the Optical Disc Drive34
 - Using the TV Function44
 - Using PC Cards62
 - Using the ExpressCard Module65
 - Using the Memory Stick Media69
 - Using Other Memory Cards75
 - Using the Internet.....78

Using Wireless LAN (WLAN)	79
Using the Bluetooth Functionality	86
Using Peripheral Devices	93
Connecting External Speakers	94
Connecting an External Display	95
Selecting Display Modes	101
Using the Multiple Monitors Function	102
Connecting an External Microphone	104
Connecting a Universal Serial Bus (USB) Device	105
Connecting a Printer	108
Connecting an i.LINK Device	109
Connecting to a Network (LAN)	111
Customizing Your VAIO Computer	112
Setting the Password	113
Setting Up Your Computer with VAIO Control Center	116
Using the Power Saving Modes	117
Managing Power with VAIO Power Management	122
Upgrading Your VAIO Computer	123
Adding and Removing Memory	124

Precautions	129
On Handling the LCD Screen	130
On Using the Power Source	131
On Handling Your Computer	132
On Using the Built-in MOTION EYE Camera.....	134
On Handling Floppy Disks	135
On Handling Discs	136
On Using the Battery Pack.....	137
On Using Headphones.....	139
On Handling Memory Stick Media.....	140
On Handling the Hard Disk	141
On Updating Your Computer	142
Troubleshooting	143
Computer	145
System Security	152
Battery.....	153
Built-in MOTION EYE Camera.....	155
Internet.....	158
Networking	160
Bluetooth Technology	163
Optical Discs	167
Display	171
Printing.....	176
Microphone	177

Mouse	178
Speakers	179
Touch Pad.....	181
Keyboard.....	182
Floppy Disks	183
PC Cards	184
Audio/Video.....	186
Memory Stick Media	189
Peripherals.....	190
Support Options	191
Sony Support Information	191
Program Support Information.....	195

Before Use

Congratulations on your purchase of this Sony VAIO® computer, and welcome to the on-screen User Guide. Sony has combined leading-edge technology in audio, video, computing, and communications to provide state-of-the-art personal computing experience.



External views illustrated in this manual may look slightly different from those of your computer.

Documentation

Your documentation includes printed information and user guides to read on your VAIO computer.

Printed Documentation

- ❑ **Welcome mat** — Contains an overview of components connection, set-up information, etc.
- ❑ **Safety Information** — Contains safety guidelines and owner information.

Non-printed Documentation

- ❑ **User Guide** (this manual) — Explains features of your computer. It also includes information about the software programs included with your computer, as well as information on solving common problems. **User Guide** is provided in the PDF format, which you can easily browse through and print out.



To go to Web sites described in this manual by clicking their respective URLs beginning with http://, your computer must be connected to the Internet.

- ❑ **Specifications** — The online **Specifications** describe the hardware and software configurations of your VAIO computer.

To view the online **Specifications**:

- 1 Connect to the Internet.
- 2 Go to the Sony online support Web site at the following URLs:
 - <http://esupport.sony.com/EN/VAIO/> for customers in USA
 - <http://www.sony.ca/support> for customers in Canada
 - <http://esupport.sony.com/ES/VAIO/> for customers in Spanish speaking Latin American countries or areas
 - <http://esupport.sony.com/ES/VAIO/BR/> for customers in Brazil

- ❑ **VAIO Recovery Center User Guide** — Provides information about restoring individual software programs, software drivers, and drive partition(s) or your entire hard disk drive to the original factory installed settings.

To access this on-screen guide:

- 1 Click **Start**  and **Help and Support**.
- 2 Click **Manuals & Specifications**.
- 3 Click **VAIO Recovery Center User Guide**.

- ❑ **RAID Guide** (Selected models only) — Provides information about using RAID systems.

To access this on-screen guide:

- 1 Click **Start** and **Help and Support**.
- 2 Click **Manuals & Specifications**.
- 3 Click **Other Documents**.

- ❑ **Media Center User Guide** (Selected models only) — Provides information about using **Windows Media Center**.

To access this on-screen guide:

- 1 Click **Start** and **Help and Support**.
- 2 Click **Manuals & Specifications**.
- 3 Click **Media Center User Guide**.

Help and Support

Help and Support is easy to access and provides a single location for information and technical assistance for your VAIO computer. Choose from the following categories to find the answers you need.

To access **Help and Support**, click **Start** and **Help and Support**.

Manuals & Specifications

Here you will find the on-screen **User Guide**, warranty information, other VAIO documents, and system and software information for your computer.

VAIO Support

Access interactive help in the form of VAIO tutorials, an escalation page containing support and contact information, and various links to VAIO online support Web sites.

Backup & Recovery

Find information on how to back up and restore your operating system, system software, and your personal data.

Wireless & Networking

Learn about wireless connections including Bluetooth Wireless technology and Wireless LAN. Run utilities that include **VAIO Media Setup** and **Windows Network and Sharing Center**, and access to wireless tutorials.

Security

Keep your data safe and your computer running efficiently with updates and maintenance programs from Microsoft and Sony.

VAIO Sites

Contains links to other Internet sites you might find interesting and useful.

Ergonomic Considerations

You will be using your computer as a portable device in a variety of environments. Whenever possible, you should attempt to take account of the following ergonomic considerations for both stationary and portable environments:

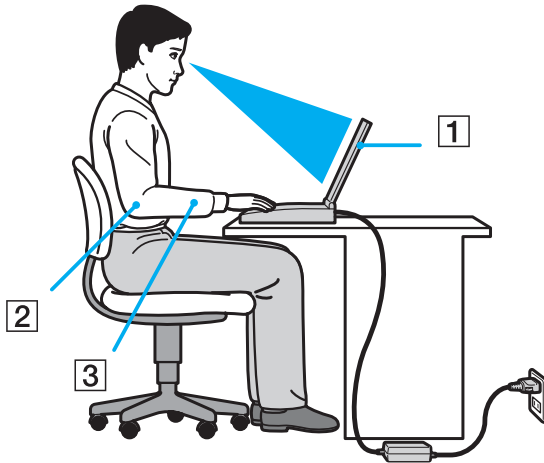

- ❑ **Position of your computer** – Place the computer directly in front of you (1). Keep your forearms horizontal (2), with your wrists in a neutral, comfortable position (3) while using the keyboard, touch pad, or external mouse. Let your upper arms hang naturally at your sides. Have breaks during sessions with your computer. Excessive use of the computer may strain eyes, muscles, or tendons.
- ❑ **Furniture and posture** – Sit in a chair with good back support. Adjust the level of the chair so your feet are flat on the floor. A footrest may make you more comfortable. Sit in a relaxed, upright posture and avoid slouching forward or leaning far backwards.

- ❑ **Viewing angle of the computer's display** – Use the display's tilting feature to find the best position. You can reduce eye strain and muscle fatigue by adjusting the tilt of the display to the proper position. Adjust the brightness level of the display as well.
- ❑ **Lighting** – Choose a location where windows and lights do not cause glare and reflection on the display. Use indirect lighting to avoid bright spots on the display. Proper lighting adds to your comfort and work efficiency.
- ❑ **Positioning an external display** – When using an external display, set the display at a comfortable viewing distance. Make sure the display screen is at eye level or slightly lower when you are sitting in front of the monitor.

Getting Started

This section describes how to get started using your VAIO computer.

! Before starting your computer for the first time, do not connect any other hardware that did not originally come with your computer. Be sure to start up your computer with only the supplied accessories connected and set up your system. Upon completion, connect one device (for example, a printer, an external hard disk drive, a scanner, and so on) at a time, following the manufacturers' instructions.

- ❑ **Locating Controls and Ports** ([page 13](#))
- ❑ **About the Indicator Lights** ([page 20](#))
- ❑ **Connecting a Power Source** ([page 22](#))
- ❑ **Using the Battery Pack** ([page 23](#))
- ❑ **Shutting Down Your Computer Safely** ([page 27](#))

Locating Controls and Ports

Take a moment to identify the controls and ports shown on the following pages.

! The appearance of your computer may be different from those illustrated in this manual due to variations in specifications. It may also vary in some countries or areas.

Front

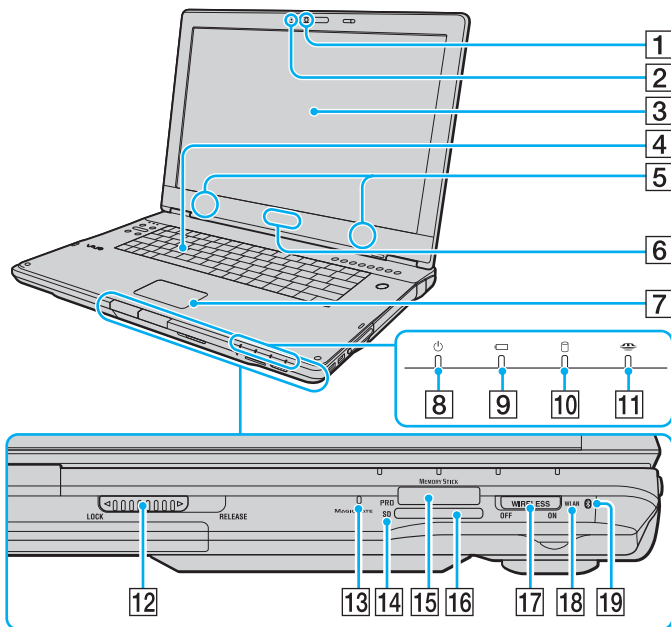

- 1 Built-in **MOTION EYE** camera (page 33)
- 2 Built-in **MOTION EYE** camera indicator (page 20)

- 3 LCD screen (page 130)
- 4 Keyboard (page 29)
- 5 Built-in speakers (stereo)
- 6 **SONY** logo lamp (page 116)
- 7 Touch pad (page 30)
- 8 Power indicator (page 20)
- 9 Battery indicator (page 20)
- 10 Hard disk drive indicator (page 20)
- 11 Memory Stick indicator (page 20)
- 12 LCD screen lid **LOCK/RELEASE** switch
Be sure to slide this switch to the **LOCK** position before moving your computer.
- 13 Built-in microphone (monaural)
- 14 **SD** memory card indicator (page 20)
- 15 Memory Stick slot^{*1} (page 71)
- 16 **SD** memory card slot (page 75)
- 17 **WIRELESS** switch (page 79)
- 18 **WLAN** (Wireless LAN) indicator (page 20)
- 19 Bluetooth indicator^{*2} (page 20)

*1 Your computer supports both standard- and Duo-size Memory Stick media.

*2 On selected models only.

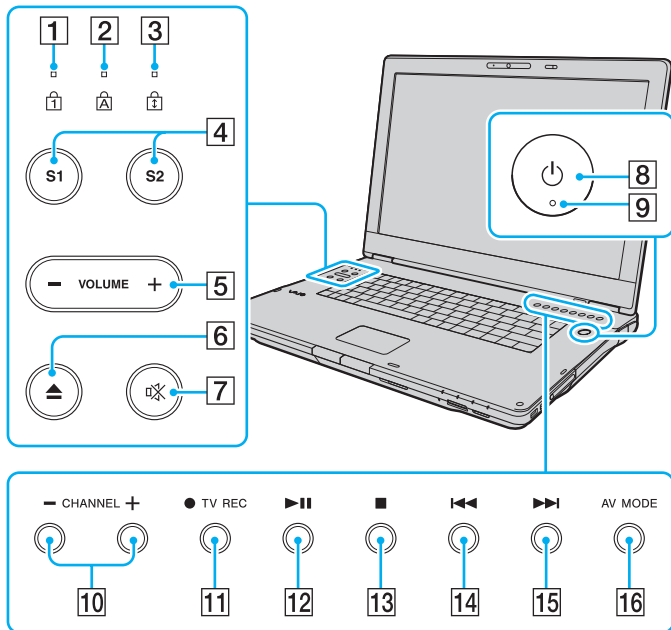

- 1 Num lock indicator (page 20)
- 2 Caps lock indicator (page 20)
- 3 Scroll lock indicator (page 20)
- 4 **S1/S2** buttons (page 31)
- 5 **VOLUME** buttons (page 31)
- 6 Disc drive eject button (page 34)
- 7 Muting button (page 31)
- 8 Power button
- 9 Power indicator (page 20)
- 10 **CHANNEL** buttons* (page 31)
- 11 **TV REC** button* (page 31)
- 12 Play/Pause button (page 31)
- 13 Stop button (page 31)
- 14 Previous track button (page 31)
- 15 Next track button (page 31)
- 16 **AV MODE** button (page 31)

* On selected models only.

Back

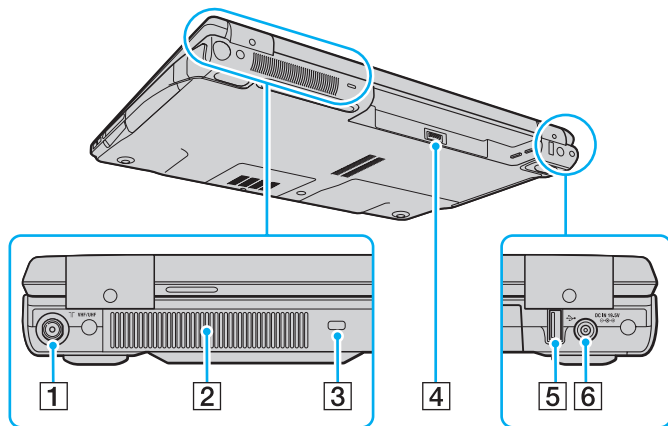

- 1 VHF/UHF input port*¹ (page 44)
- 2 Air vent
- 3 Security slot
- 4 Battery connector (page 23)
- 5 Hi-Speed USB (USB 2.0) port*² (page 105)
- 6 DC IN port (page 22)

*¹ On selected models only.

*² Supports high-/full-/low- speeds.

Right

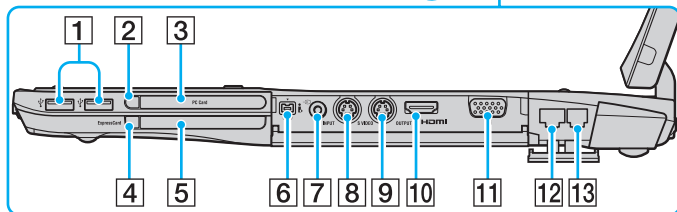
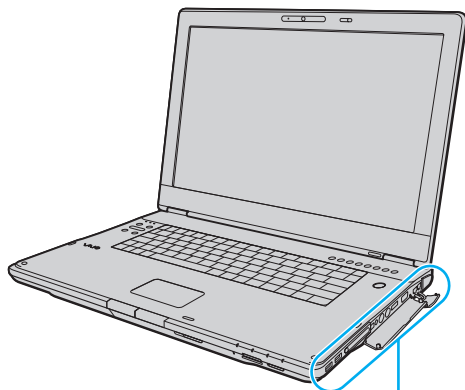

- 1 Hi-Speed USB (USB 2.0) ports*¹ (page 105)
- 2 PC Card release button (page 64)
- 3 **PC Card** slot (page 62)
- 4 ExpressCard module release button (page 68)
- 5 Universal **ExpressCard** slot (page 66)
- 6 i.LINK (IEEE 1394) S400 port (page 109)
- 7 AV In jack*² *³ (page 52)
- 8 **S VIDEO INPUT** port*² *³ (page 52)
- 9 **S VIDEO OUTPUT** port (page 98)
- 10 **HDMI** port (page 98)
- 11 Monitor (VGA) port (page 96)
- 12 Network (Ethernet) port (page 111)
- 13 Modem port (page 78)

*¹ Support high-/full-/low- speeds.

*² On selected models only.

*³ Parallel use of the AV In jack and the **S VIDEO INPUT** port will direct video signals to the **S VIDEO INPUT** port.



! HDMI, the HDMI logo and High-Definition Multimedia Interface are trademarks or registered trademarks of HDMI Licensing LLC.

Left

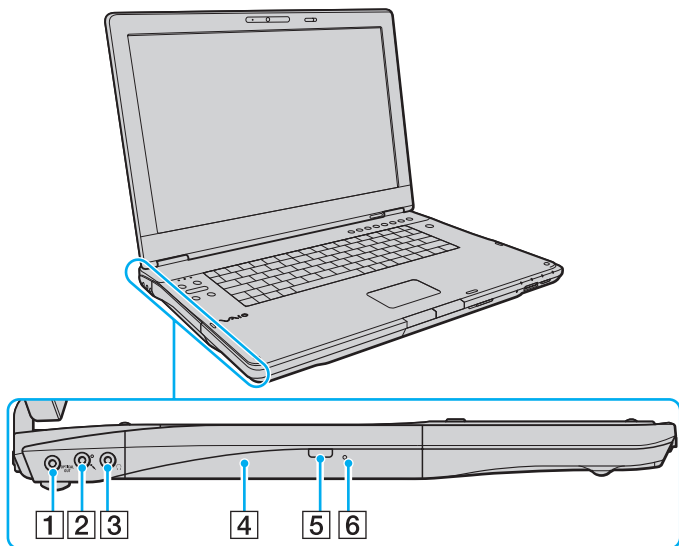

- 1** **OPTICAL OUT** port
(Output Sampling Rate: 44.1 KHz/48.0 KHz/96.0 KHz)
Connect an S/PDIF device such as digital headphones or an AV amplifier.
- 2** Microphone jack ([page 104](#))
- 3** Headphones jack ([page 94](#))
- 4** Optical disc drive ([page 34](#))
- 5** Substitute drive eject button ([page 34](#))/
Optical disc drive indicator ([page 20](#))
- 6** Manual eject hole ([page 167](#))



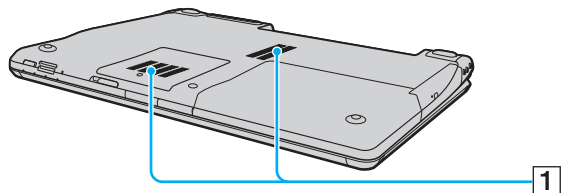



Bottom



1 Air vents

About the Indicator Lights

Your computer is equipped with the following indicator lights.

Indicator	Functions
Power 	Illuminates when the power of the computer is on, blinks when the computer is in Sleep mode, and turns off when the computer is in Hibernate mode or off.
Battery 	Illuminates when the computer is using battery power, blinks when the battery pack is running out of power, and double-blinks when the battery pack is charging.
Memory Stick 	Illuminates when data is read from or written to the Memory Stick media in the Memory Stick slot. (Do not enter Sleep mode or turn off the computer when this indicator is on.) When the indicator is off, the Memory Stick media is not being used.
Built-in MOTION EYE camera	Illuminates while the built-in MOTION EYE camera is in use.
SD memory card	Illuminates when data is read from or written to the media in the SD memory card slot. (Do not enter Sleep mode or turn off the computer when this indicator is on.) When the indicator is off, the memory card is not being used.
Optical disc drive	Illuminates when data is read from or written to the optical disc media. When the indicator is off, the optical disc media is not being used.
Hard disk drive 	Illuminates when data is read from or written to the hard disk drive. Do not enter Sleep mode or turn off the computer when this indicator is on.
Num lock 	Press the Num Lk key to activate the numeric keypad. Press it a second time to deactivate the numeric keypad. The numeric keypad is not active when the indicator is off.
Caps lock 	Press the Caps Lock key to type letters in uppercase. Letters appear in lowercase if you press the Shift key while the indicator is on. Press the key a second time to turn off the indicator. Normal typing resumes when the Caps lock indicator is off.
Scroll lock 	Press the Scr Lk key to change how you scroll the display. Normal scrolling resumes when the Scroll lock indicator is off. The Scr Lk key functions differently depending on the program you are using and does not work with all programs.

Indicator	Functions
Bluetooth technology  *	Illuminates when the WIRELESS switch is set to ON and Bluetooth technology is enabled.
Wireless LAN	Illuminates when the wireless LAN functionality is enabled.

* On selected models only.

Connecting a Power Source

You can use either an AC adapter or a rechargeable battery pack as a power source for your computer.

Using the AC Adapter



Use your computer only with the supplied AC adapter.

To use the AC adapter

- 1 Plug one end of the power cord (1) into the AC adapter (3).
- 2 Plug the other end of the power cord into an AC outlet (2).
- 3 Plug the cable connected to the AC adapter (3) into the **DC IN** port (4) on the computer.

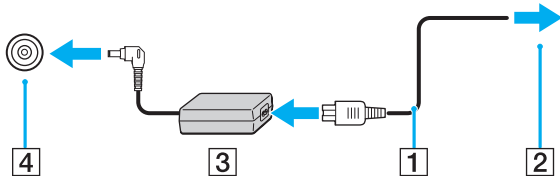

The shape of the DC In plug varies depending on the AC adapter.



To disconnect your computer completely from AC power, unplug the AC adapter.

Make sure that the AC outlet is easily accessible.

If you do not intend to use your computer for a long period of time, place the computer into Hibernate mode. See **Using Hibernate Mode** (page 120). This power saving mode saves the time of shutting down and resuming.

Using the Battery Pack

The battery pack supplied with your computer is not fully charged at the time of delivery.

Installing the Battery Pack

To install the battery pack

- 1 Turn off the computer and close the LCD screen lid.
- 2 Slide the battery lock switch (1) inward.

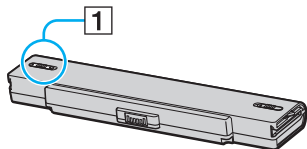

- 3 Slide the battery pack into the battery compartment until it clicks into place.

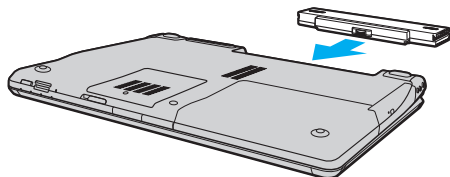

- 4 Slide the battery lock switch (1) to the **LOCK** position to secure the battery pack on the computer.



When your computer is directly connected to AC power and has a battery pack installed, it uses power from the AC outlet.



This computer is designed to operate only with genuine Sony batteries.

Charging the Battery Pack

The battery pack supplied with your computer is not fully charged at the time of delivery.

To charge the battery pack

- 1 Install the battery pack.
- 2 Connect the AC adapter to the computer.
The computer automatically charges the battery pack (the battery indicator light flashes in a double blink pattern as the battery pack charges). When the battery pack is about 85% charged, the battery indicator turns off.

Battery indicator light status	Meaning
On	The computer is using battery power.
Blinks	The battery pack is running out of power.
Double blinks	The battery pack is charging.
Off	The computer is using AC power.



Charge the battery pack as described in this manual from your first battery charge.



When the battery pack is running out of power, both the battery and power indicator lights blink.

Keep the battery pack in your computer while it is directly connected to AC power. The battery pack continues to charge while you are using the computer.

If the battery level falls below 10%, you should either connect the AC adapter to recharge the battery pack or shut down your computer and install a fully charged battery pack.

The battery pack supplied with your computer is a lithium ion battery pack and can be recharged any time. Charging a partially discharged battery pack does not affect the battery life.

The battery indicator light is on while you use the battery pack as a power source. When battery life is nearly depleted, both the battery and power indicator lights start flashing.

For some software applications and some peripheral devices, your computer may not enter Hibernate mode even when battery life is low. To avoid loss of data when using battery power, you should save your data frequently and manually activate a power management mode, such as Sleep or Hibernate.

If the battery pack wears out when the computer enters Sleep mode, you will lose all unsaved data. Going back to the previous work state is impossible. To avoid loss of data, you should save your data frequently.

When your computer is directly connected to AC power and has a battery pack installed, it uses power from the AC outlet.

Removing the Battery Pack

! You may lose data if you remove the battery pack while your computer is on and not connected to the AC adapter or if you remove the battery pack while the computer is in Sleep mode.

To remove the battery pack

- 1 Turn off the computer and close the LCD screen lid.
- 2 Slide the battery lock switch (1) inward.

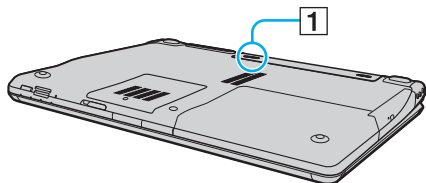

- 3 Slide and hold the battery release latch (2) and slide the battery pack away from the computer.

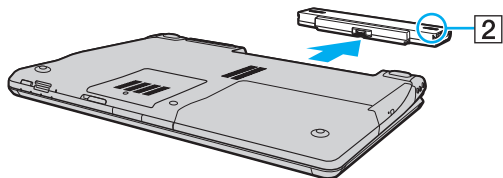

Shutting Down Your Computer Safely

To avoid losing unsaved data, be sure to shut down your computer properly, as described below.

To shut down your computer

- 1 Turn off any peripherals connected to the computer.
- 2 Click **Start**, the arrow  next to the **Lock** button, and **Shut Down**.
- 3 Respond to any prompts warning you to save documents or to consider other users and wait for the computer to turn off automatically.
The power indicator light turns off.

Using Your VAIO Computer

This section describes how to get the most out of using your VAIO computer.

- ❑ **Using the Keyboard** ([page 29](#))
- ❑ **Using the Touch Pad** ([page 30](#))
- ❑ **Using Special-function Buttons** ([page 31](#))
- ❑ **Using the Built-in MOTION EYE Camera** ([page 33](#))
- ❑ **Using the Optical Disc Drive** ([page 34](#))
- ❑ **Using the TV Function** ([page 44](#))
- ❑ **Using PC Cards** ([page 62](#))
- ❑ **Using the ExpressCard Module** ([page 65](#))
- ❑ **Using the Memory Stick Media** ([page 69](#))
- ❑ **Using Other Memory Cards** ([page 75](#))
- ❑ **Using the Internet** ([page 78](#))
- ❑ **Using Wireless LAN (WLAN)** ([page 79](#))
- ❑ **Using the Bluetooth Functionality** ([page 86](#))







Using the Keyboard

Your keyboard is very similar to a desktop computer keyboard, but has additional keys that perform model-specific tasks.

Combinations and Functions with the Fn Key



Some keyboard functions can be used only after the operating system finished launching.

Combinations/Feature	Functions
Fn +  (F5/F6): brightness control	Adjusts the LCD brightness of your computer screen. To increase lighting intensity, press Fn+F6 and then ↑ or → , or keep pressing Fn+F6 . To decrease lighting intensity, press Fn+F5 and then ↓ or ← , or keep pressing Fn+F5 .
Fn +  /  (F7): display output	Toggles among your computer screen, an external display, and simultaneous output to both.
Fn +  (F10): zoom	Changes the screen resolution to magnify/restore your computer's screen view.  The magnified view is not as clear as the standard view, as it is implemented by applying a lower resolution to the computer screen with a higher resolution. This key combination may not work with graphic images as it magnifies the screen view by changing the resolution. The location and size of software windows may change when the screen view is magnified or the standard view is restored because pressing this key combination changes the resolution. When your computer's screen view is magnified, switching the view to the external display disables the function and restores the standard view.
Fn +  (F12): Hibernate	Provides for the lowest level of power consumption. When you execute this command, the states of the system and the connected peripheral devices are written to the hard disk drive and the system power is turned off. To return the system to its original state, use the power button to turn on the power. For details on power management, see Using the Power Saving Modes (page 117).

Using the Touch Pad

You can point to, select, drag, and scroll objects on the screen using the touch pad.

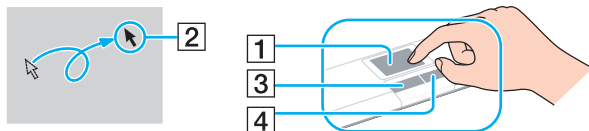

Action	Description
Point	Slide your finger on the touch pad (1) to place the pointer (2) on an item or object.
Click	Press the left button (3) once.
Double-click	Press the left button twice.
Right-click	Press the right button (4) once. In many applications, this action displays a shortcut menu.
Drag	Slide your finger on the touch pad while pressing the left button.
Scroll	Slide your finger along the right edge of the touch pad to scroll vertically. Slide your finger along the bottom edge to scroll horizontally (the scroll function is available only with applications that support a touch pad scroll feature).











You can disable/enable the touch pad to suit your preference for using the mouse. See **Setting Up Your Computer with VAIO Control Center** (page 116) to launch **VAIO Control Center**. Once launched, select the topic on the pointing device and see the help file for detailed instructions.









Be sure to connect a mouse before disabling the touch pad. If you disable the touch pad without connecting a mouse, you will be able to use only the keyboard for pointer operations.

Using Special-function Buttons

Your computer is equipped with special buttons to help you use specific functions of the computer.

Special-function button	Functions
CHANNEL buttons* ¹  	Change TV channels up and down.
TV REC button* ¹ 	Starts TV recording.
Play/Pause button 	Starts or pauses playback of a CD disc, DVD disc, or Blu-ray Disc™* ² media or a music/video file stored on the hard disk drive.
Stop button 	Stops playback of a CD disc, DVD disc, or Blu-ray Disc™* ² media or a music/video file stored on the hard disk drive; or TV recording* ¹ .
Previous track button 	Plays the previous chapter/file during video playback or the previous song/file during audio playback.
Next track button 	Plays the next chapter/file during video playback or the next song/file during audio playback.
AV MODE button 	Launches VAIO Launcher for selecting the desired software. You can change the default software options in VAIO Launcher . To do so, press and hold the AV MODE button to display the setup window.

Special-function button	Functions
S1/S2 buttons  	<p>The default button assignments are as follows:</p> <p>The S1 button toggles the LCD image quality mode between Standard and Vivid on models with the LCD Screen Image Mode feature^{*1}; or displays the Logo Lamp Control window for specifying your preference for the on/off status of the SONY logo lamp on other models.</p> <p>The S2 button activates and deactivates the audio filtering feature of the SonicStage Mastering Studio software.</p> <p> The default button assignments may be different from the above. In such a case, you can change the assignments in the window for changing the S button assignments. To display this window, press and hold either button or launch and navigate through VAIO Control Center.</p> <p>See the help file on VAIO Control Center for the S button assignments.</p>
VOLUME buttons 	Decrease (-) and increase (+) the volume.
Disc drive eject button 	Ejects the optical disc drive tray. If this button does not work, try the substitute drive eject button on the optical disc drive.
Muting button 	Turns the volume on and off.

*1 On models with the TV tuner only.

*2 On models with the Blu-ray Disc drive only. Use the **WinDVD BD** software for playback.

Using the Built-in MOTION EYE Camera

Your computer is equipped with a built-in **MOTION EYE** camera.

The built-in **MOTION EYE** camera adds video functionality to instant messaging software and video editing software.

Turning on the computer activates the built-in **MOTION EYE** camera, so the computer is ready for a video conference using such software.

Note that launching or exiting your instant messaging or video editing software does not activate or deactivate the built-in **MOTION EYE** camera, respectively.



The built-in **MOTION EYE** camera cannot be shared by more than one software application. If another software application is using the camera, exit the application before using the built-in **MOTION EYE** camera.

When capturing an image in a dark place, click **Start, All Programs, VAIO Camera Capture Utility**, and **VAIO Camera Capture Utility** to start **VAIO Camera Capture Utility**. Click the **Camera** button to display the **Properties** window and select the **Low Light** check box. It decreases the frame rate and slows down the shutter speed to allow the camera to capture more light.



The viewer window may show some noise, for example horizontal streaks, if you view a rapid-moving object. This is normal and does not indicate a malfunction.

You cannot operate the built-in **MOTION EYE** camera with the **Microsoft Windows MovieMaker** software.

Using the Optical Disc Drive

Your computer is equipped with an optical disc drive.

To insert a disc

- 1 Turn on the computer.
- 2 Press the drive eject button (1) to open the drive.
The tray slides out.



If the disc drive eject button does not work, try the substitute drive eject button on the optical disc drive.

If power supply to the optical disc drive is disabled by **VAIO Power Management**, it will take a while to eject the drive tray. Note that the substitute drive eject button is disabled when the optical disc drive is not powered.

When recovering your system, turn on your computer and press the substitute drive eject button on the optical disc drive. Insert your Recovery Disc into the optical disc drive, turn off the computer, and then turn on the computer again to start the recovery process.

- 3 Place a disc in the middle of the tray with the label side facing upward and gently push it until the disc clicks into place.

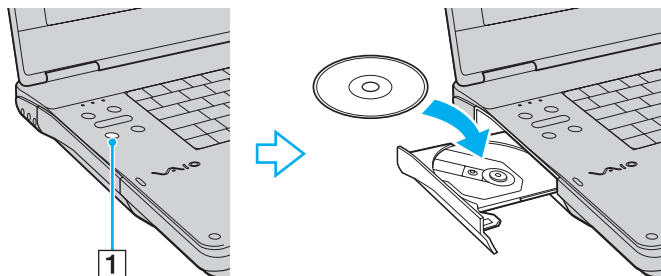

- 4 Close the tray by pushing it in gently.

! Do not remove the optical disc when your computer is in a power saving mode (Sleep or Hibernate). Doing so may cause the computer to malfunction.



If you plan to use an external optical disc drive, connect the drive before you launch any preinstalled disc operation program.

Reading and Writing Optical Discs

Your computer plays and records CDs, DVDs, and Blu-ray Disc media, depending on the model you purchased. Check your specifications for the type of optical disc drive installed on your model. Use the table below to see which types of media your optical disc drive supports.

PR: playable and recordable
 P: playable but not recordable
 –: not playable or recordable

	CD-ROM	Video CD	Music CD	CD Extra	CD-R/RW	DVD-ROM	DVD-Video	BD-ROM	DVD-R/RW	DVD+R/RW	DVD+R DL	DVD-R DL	DVD-RAM	BD-R ^{*9} /RE ^{*10}
DVD±RW/±R DL/RAM	P	P	P	P	PR	P	P	–	PR ^{*1 *2}	PR	PR ^{*5}	PR ^{*6}	PR ^{*3 *4}	–
CD-RW/DVD-ROM	P	P	P	P	PR	P	P	–	P	P	P	P	–	–
DVD-ROM	P	P	P	P	P	P	P	–	P	P	P	P	–	–
Blu-ray Disc	P	P	P	P	PR ^{*8}	P	P	P	PR ^{*1 *2}	PR	PR ^{*5}	PR ^{*6}	PR ^{*3 *4}	PR ^{*7 *11}
Blu-ray Disc Combo	P	P	P	P	PR ^{*8}	P	P	P	PR ^{*1 *2}	PR	PR ^{*5}	PR ^{*6}	PR ^{*3 *4}	P ^{*11}

^{*1} Supports writing data to DVD-R discs compliant with DVD-R for General Version 2.0/2.1.

^{*2} Supports writing data to DVD-RW discs compliant with DVD-RW Version 1.1/1.2.

^{*3} The DVD±RW/RAM disc drive on your computer does not support the DVD-RAM cartridge. Use non-cartridge discs or discs with a removable cartridge.

^{*4} Writing data to single-sided DVD-RAM discs (2.6 GB) compliant with DVD-RAM Version 1.0 is not supported. DVD-RAM Version 2.2/12X-SPEED DVD-RAM Revision 5.0 disc is not supported.

^{*5} Writing data to DVD+R DL (Double Layer) discs is available only on discs supporting DVD+R DL (Double Layer) recording.

^{*6} Writing data to DVD-R DL (Dual Layer) discs is available only on discs supporting DVD-R DL (Dual Layer) recording.

^{*7} Supports writing data to BD-R Version 1.1 discs (single-layer discs with the capacity of 25 GB, dual-layer discs with the capacity of 50 GB) and BD-RE Version 2.1 discs (single-layer discs with the capacity of 25 GB, dual-layer discs with the capacity of 50 GB).

^{*8} Writing data to Ultra Speed CD-RW discs is not supported on models with the Blu-ray Disc drive.

^{*9} BD-R stands for Blu-ray Disc-Recordable in Version 1.1 format.

^{*10} BD-RE stands for Blu-ray Disc-Rewritable in Version 2.1 format.

^{*11} The Blu-ray Disc drive on your computer does not support BD-RE Disc media in Version 1.0 format and Blu-ray Disc media with a cartridge.

! This product is designed to playback discs that conform to the Compact Disc Digital Audio standard specifications (CD Standard). A DualDisc is a two sided disc product which mates DVD recorded material on one side with digital audio material on the other side. Be aware that the audio side (non-DVD side) of a DualDisc may not play on this product because it does not conform to the CD Standard.

Due to the multiple formats of discs now available, when buying pre-recorded or blank discs for use with a VAIO computer, be sure to read the notices on the disc packaging carefully to check both playback and recording compatibility with your computer's optical disc drives. Sony does NOT guarantee the compatibility of VAIO CD drives with discs that are not compliant with the official "CD" format standard (or "DVD" standard in relation to DVD drives, or "Blu-ray Disc" standard in relation to Blu-ray Disc drives). USING NON-COMPLIANT DISCS CAN CAUSE FATAL DAMAGE TO YOUR VAIO PC OR CREATE SOFTWARE CONFLICTS AND CAUSE SYSTEM HANGING.

For inquiries about disc formats, contact the individual publisher of the pre-recorded disc or the manufacturer of the recordable disc.



8cm disc writing is not supported.

! To play copyright protected Blu-ray Disc media continuously, you need to update the AACS key. Note that the AACS key update requires Internet access.

As with other optical media devices, circumstances may limit compatibility or prevent Blu-ray Disc playback. VAIO computers may not support movie playback on packaged media recorded in AVC or VC1 formats at high bit rates.

Region settings are required for some contents on DVDs and BD-ROM Disc media. If the region setting on the optical disc drive does not match the region coding on the disc, playback is not possible.

Unless your external display is compliant with the High-bandwidth Digital Content Protection (HDCP) standard, you cannot play or view the contents of copyright protected Blu-ray Disc media.

Some contents may restrict video output to be standard definition or prohibit analog video output at all. It is strongly recommended that digital HDCP-compliant environment be implemented for optimum compatibility and viewing quality.

Notes on writing data to a disc

- ❑ Use only Sony recommended software, which is preinstalled on your computer, to write data to a disc. Other software programs may not be fully compatible and errors may result.
- ❑ To make data on a disc readable on the optical disc drive, you need to close the session before you eject it. To complete this process, follow the instructions included with your software.
- ❑ Only use circular discs. Do not use discs in any other shape (star, heart, card, etc.), as this may damage the optical disc drive.
- ❑ Do not strike or shake your computer while writing data to a disc.
- ❑ Deactivate the screen saver and exit anti-virus software before writing data to a disc.
- ❑ Do not use memory-resident utility software while writing data to a disc. This may cause your computer to malfunction.
- ❑ Before using your software application to burn discs, make sure you exit and close all other applications.
- ❑ Do not place your computer into either of the power saving modes while using the preinstalled software or any disc burning software.
- ❑ Connect and use the AC adapter to power your computer or make sure your battery pack is at least 50% charged.
- ❑ Make sure you use the same disc burning software to add data to a used disc. Use of different disc burning software for additional data burning may cause a failure. For example, if you have a disc with data that you burned with the **Roxio Easy Media Creator** software, use the **Roxio Easy Media Creator** software to add more data to the same disc.

Notes on playing discs

To achieve optimum performance when playing discs, you should follow these recommendations.

- ❑ Some CD players and computers' optical disc drives may not be able to play audio CDs created with the CD-R or CD-RW disc media.
- ❑ Some DVD players and computers' optical disc drives may not be able to play DVDs created with the DVD+R DL, DVD-R DL, DVD+R, DVD+RW, DVD-R, DVD-RW, or DVD-RAM disc media.
- ❑ Do not use memory-resident utility software to speed up disc access when playing a disc. This may cause your computer to malfunction.
- ❑ Do not place your computer into either of the power saving modes while your computer is playing a disc.
- ❑ Region code indicators are labeled on the DVDs to indicate in which region and on what type of player you can play the disc. If the DVD is labeled "all," this means that you can play this DVD in most regions of the world. If the region code for your residence area is different from the label on the DVD disc or on the packaging, you cannot play the disc on your computer.

Playing CDs

To play an audio CD

- 1 Insert a disc into the optical disc drive.
- 2 If nothing appears on the desktop, then click **Start, All Programs**, and the desired CD software to play the CD.
If the **Audio CD** window appears, click to select an option.

Copying Files to CDs

To copy files to a disc

! Do not strike or shake your computer while writing data to a disc.

- 1 Insert a disc into the optical disc drive.
If the **AutoPlay** window appears, click **Burn files to disc** and follow the on-screen instructions until the empty disc folder appears.
- 2 Open the folder that contains the file(s) you want to copy and drag them to the empty disc folder.
- 3 Close the disc folder.

Playing DVDs

To play a DVD

- 1 Close all running software applications.
- 2 Insert a DVD into the optical disc drive.
- 3 If nothing appears on the desktop, then click **Start, All Programs**, and the desired DVD software to play the DVD.

For instructions on how to use the software, see the help file on your DVD software.

Copying Files to DVDs

To copy files to a disc

- 1 Connect the AC adapter to the computer.
- 2 Insert a disc into the optical disc drive.
- 3 If nothing appears on the desktop, then click **Start, All Programs**, and the desired DVD burning software to copy files to the disc.

For instructions on how to use the software, see the help file on your DVD burning software.

Playing Blu-ray Disc Media

! The Blu-ray Disc playback function is available on selected models only. See the online **Specifications** to find the type of your optical disc drive, and then **Reading and Writing Optical Discs (page 36)** to find about the supported disc media.

To play a Blu-ray Disc media

- 1 Close all running software applications.
- 2 Insert a Blu-ray Disc media into the optical disc drive.
- 3 If nothing appears on the desktop, then click **Start, All Programs**, and the desired Blu-ray Disc software to play the disc.

For instructions on how to use the software, see the help file on your software.

Copying Files to Blu-ray Disc Media

! The Blu-ray Disc writing function is available on selected models only. See the online **Specifications** to find the type of your optical disc drive, and then **Reading and Writing Optical Discs (page 36)** to find about the supported disc media.

To copy files to a Blu-ray Disc media

- 1 Connect the AC adapter to the computer.
- 2 Insert a Blu-ray Disc media into the optical disc drive.
- 3 If nothing appears on the desktop, then click **Start, All Programs**, and the desired Blu-ray Disc burning software to copy files to the disc.

For instructions on how to use the software, see the help file on your Blu-ray Disc burning software.

Using the TV Function

Your computer may have a TV tuner board installed or may be delivered with an external digital cable tuner to enhance your audio and visual experience in conjunction with **Windows Media Center**. See the online **Specifications** to find if your model is equipped with the TV tuner board or delivered with the digital cable tuner.

! For details on the external digital cable tuner, see the manual that came with the tuner.

Media Center provides you with a wide range of TV, DVD, and video viewing, as well as music recording and playback. This section describes how to set up your TV, set-top box, and other equipment. See the on-screen **Media Center User Guide** for more information on Media Center features.

To access this on-screen guide

- 1 Click **Start** and **Help and Support**.
- 2 Click **Manuals & Specifications**.
- 3 Click **Media Center User Guide**.

Setting Up TV Connections

! The following connections may not be available in some countries or areas.

The best method to connect your computer system, TV monitor or display, and cable service access, depends on the type of cable connection available in your home.

TV signal reception strength will vary widely depending on service availability in your area as well as the type of connection available.

One primary cable to connect a computer to a cable service access or a TV antenna is the TV coaxial cable (1) (supplied with selected models only). One end connects to the **VHF/UHF** input port, and the other end connects to the cable service access or to the antenna.



If your computer is not equipped with the **VHF/UHF** input port and is delivered with an external digital cable tuner, see the manual that came with the tuner for the detailed instructions on cable connection. Otherwise, proceed with the following.

Connecting to standard cable access (CATV)

To connect in CATV mode (Option 1)

- 1 Connect one end of a TV coaxial cable (1) to your cable service access (wall outlet) (2).
- 2 Connect the other end to the **VHF/UHF** input port (3) on the computer.

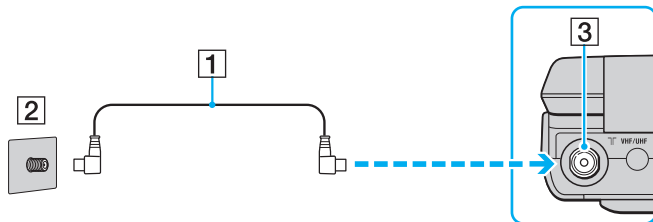

To connect in CATV mode (Option 2)

- 1 Connect the two metal hooks on a 75-ohm/300-ohm RCA transformer cable (1) (not supplied) to the screw-type grips at your cable service access (wall outlet) (2).
- 2 Connect one end of a TV coaxial cable (3) to the transformer end of the RCA transformer cable (1). Connect the other end to the **VHF/UHF** input port (4) on the computer.

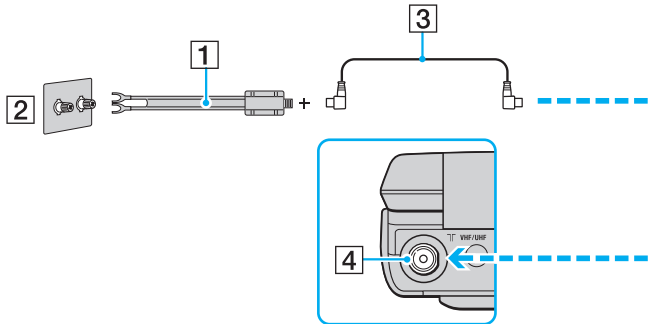

Connecting to a standard antenna

You can connect your computer to an indoor/outdoor antenna system, using Option 1 or Option 2 from the previous section, **Connecting to standard cable access (CATV)** (page 46). Depending on the type of antenna system in your home, your connection may require a VHF/UHF RF combiner/transformer (not supplied) to connect the computer and the indoor/outdoor antenna system.



If you are connecting to an indoor/outdoor antenna, you may need to reorient the antenna for best reception. Move the antenna cable away from other power sources or connectors to reduce signal interference.

To connect in land-based (terrestrial) broadcasting mode (Option 1)

- 1 Connect one end of a TV coaxial cable (1) (not supplied) to your antenna outlet (2). Connect the other end to a VHF/UHF RF combiner/transformer (3) (not supplied).
- 2 Connect a coaxial cable feed connector (4) (not supplied) to the VHF/UHF RF combiner/transformer (3).
- 3 Connect one end of another TV coaxial cable (5) to the feed connector (4). Connect the other end to the **VHF/UHF** input port (6) on the computer.

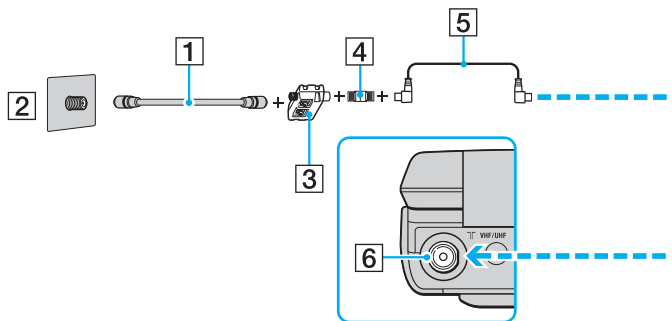

To connect in land-based (terrestrial) broadcasting mode (Option 2)

- 1 Connect one end of a 300-ohm twin lead cable (1) (not supplied) to the screw-type grips at your antenna outlet (2). Connect the other end to the grips on a VHF/UHF RF combiner/transformer (3) (not supplied).
- 2 Connect a coaxial cable feed connector (4) (not supplied) to the VHF/UHF RF combiner/transformer (3).
- 3 Connect one end of a TV coaxial cable (5) to the feed connector (4). Connect the other end to the **VHF/UHF** input port (6) on the computer.

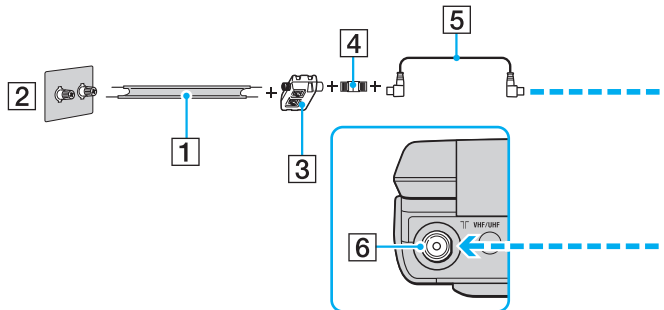

Connecting with a cable or satellite set-top box (STB)

You can connect your computer to cable service access that uses a set-top box (cable or satellite). When using the set-top box (STB) setup, you can change channels only through the STB, using its controls or the supplied remote commander.

When using the STB setup:

- ❑ A standard TV remote control cannot be used to change TV channels. You can use your TV remote control to set the TV to the channel-out number (channel 3, 4, etc.) or direct video input specified by your cable or satellite service provider.
- ❑ You may be able to use a universal remote control or commander to change TV channels, if the device is capable of controlling the STB.

To connect in STB mode (Option 1)

- 1 Connect one end of a TV coaxial cable (1) (not supplied) to your cable service access (wall outlet) (2). Connect the other end to the VHF/UHF IN port on the back panel of your set-top box (STB) (3).
- 2 Connect a second TV coaxial cable (4) (not supplied) to the VHF/UHF OUT port on the set-top box (STB) (3). Connect the other end to the single-connection end of a splitter device (5) (not supplied).
- 3 Connect a third TV coaxial cable (6) to the double-connection end of the splitter device (5). Connect the other end to the **VHF/UHF** input port (7) on the computer.
- 4 Connect a fourth TV coaxial cable (8) (not supplied) to the double-connection end of the splitter device (5). Connect the other end to the VHF/UHF input port (9) on the rear of your TV monitor or display.

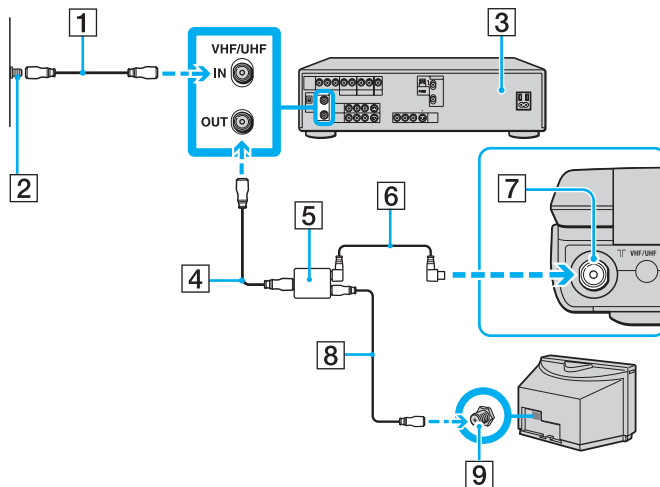

To connect in STB mode (Option 2)

- 1 Connect one end of a TV coaxial cable (1) to your cable service access (wall outlet) (2). Connect the other end to the VHF/UHF IN port on the back panel of your set-top box (STB) (3).
- 2 Connect a second TV coaxial cable (4) (not supplied) to the VHF/UHF OUT port on the set-top box (STB) (3). Connect the other end to the VHF/UHF input port (5) on the rear of your TV monitor or display.
- 3 Connect one end of a stereo A/V cable with triple RCA plugs (6) (not supplied) to the Composite Audio Out (L/R) jacks (7) and the Video Out jack (8) on the back panel of your set-top box (STB) unit (3), matching the plug and jack colors. Connect the other end to the AV In jack (9) on the computer.
- 4 If you prefer better video quality, connect one end of an S Video cable (10) (not supplied) to the S Video Out port (11) on the back panel of the set-top box (STB) (3). Connect the other end to the **S VIDEO INPUT** port (12) on the computer.



Parallel use of the AV In jack (9) and the **S VIDEO INPUT** port (12) will direct video signals to the **S VIDEO INPUT** port.

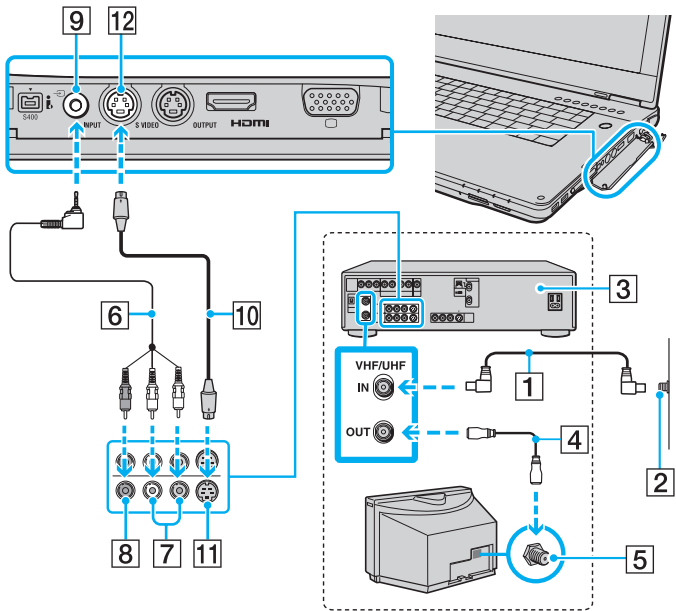

Using the Remote Commander

If your computer supports the TV function, then a remote commander is supplied with the computer for using Media Center features, including TV channel selection.

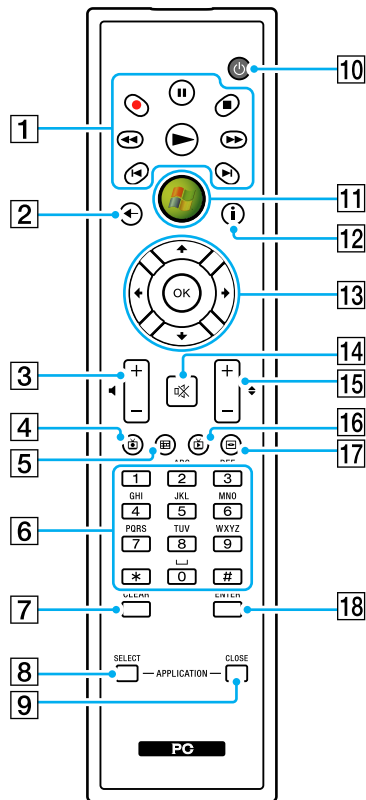

- 1** Pause **||** button
Press to pause media playback. Press again to resume playback.
Stop **■** button
Press to stop media playback or TV recording session.
Forward **▶▶** button
Press to fast-forward media at three speeds.
Skip **▶I** button
Press to move media forward, for example, one audio track, one DVD chapter, and 30 seconds of recorded TV or video.
Replay **I◀** button
Press to move media backward, for example, one audio track, one DVD chapter, and 7 seconds of TV or video.
Rewind **◀◀** button
Press to move media backward at three speeds.
Record **●** button
Press to begin recording.
Play **▶** button
Press to begin media playback.
- 2** Back button
Press to return to the previous window.
- 3** Volume buttons
Press to increase (+) or decrease (-) the volume.
- 4** Recorded TV button
Press to view previously recorded TV programs (In **My TV** window).

- 5** Guide button
Press to view the TV program guide for your area.
- 6** Alphanumeric buttons
Press to select specific channels or enter text. (Press **ENTER** or **OK** to activate the channel selection.)
- 7** **CLEAR** button
Press to backspace and delete entered text.
- 8** **APPLICATION SELECT** button
Press to switch among open applications. This button works the same as the **Alt+Tab** keys.
- 9** **APPLICATION CLOSE** button
Press to close the active application window.
- 10** Sleep button
Press to place the computer into Sleep mode to reduce power consumption.
- 11** Start button
Press to open the **Media Center Start** menu.
- 12** More button
Press to view additional options that are available for Media Center features.
- 13** Directional arrow buttons
Press the **↑**, **↓**, **←**, and **→** buttons to move the pointer on the screen.
OK button
Press to select the desired action or window option. When watching full-screen TV, press to return to the previous channel. Press again to switch between channels.
- 14** Muting button
Press to turn off the sound. Press again to restore the sound.
- 15** Channel/Page buttons
Press to change or page up/down channels (no number input required).
- 16** Live TV button
Press to view TV programs.
- 17** DVD menu button
Press to open the main menu on a DVD.
- 18** **ENTER** button
Press to activate feature or action, such as channel selection or return to previous channel. (This button's actions are similar to using the **OK** button.)

Before you use the remote commander

Before using the remote commander, you need to insert the supplied AA manganese batteries and connect the remote sensor to enable communication between the computer and the remote commander.

To insert batteries

- 1 Turn the remote commander over.
- 2 Slightly push down the dented area (1), slide the battery cover in the direction of the arrow, and remove the cover.

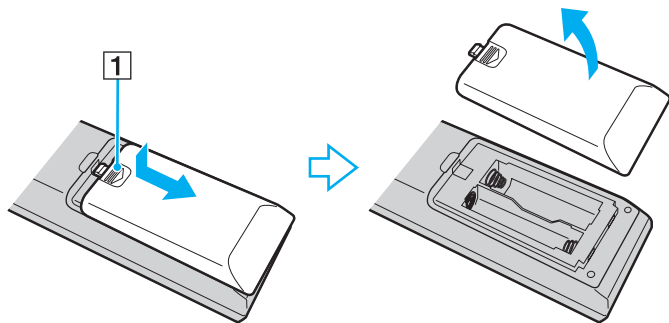

- 3 Insert the supplied two AA batteries into the remote commander.

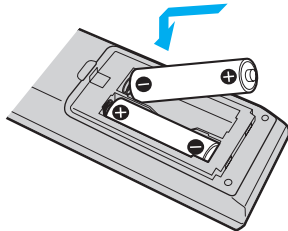

- 4 Put the battery cover back on the remote commander and slide it in the reverse direction of the arrow illustrated above until the cover clicks into place.



If the remote commander does not operate properly, you may need to replace the batteries. When the remote commander is not going to be used for an extended period of time, remove the batteries to avoid possible damage from battery leakage.

To connect the remote sensor

- 1 Choose the USB port (1)  you prefer to use.
- 2 Plug the remote sensor cable (2) into the USB port.

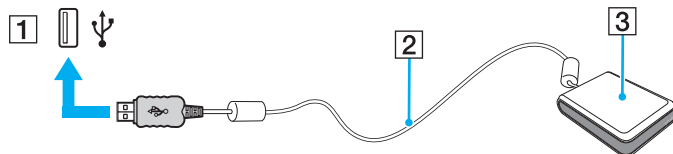

- 3 Position the remote sensor (3) to enable unobstructed communication with the remote commander.

If you are using a cable or satellite set-top box, you can attach the remote sensor control to the set-top box, which enables you to control the set-top box with the remote commander.

To connect the remote sensor control

- 1 Plug the cable from the remote sensor control (1) into either jack (1 or 2) on the back of the remote sensor (2).

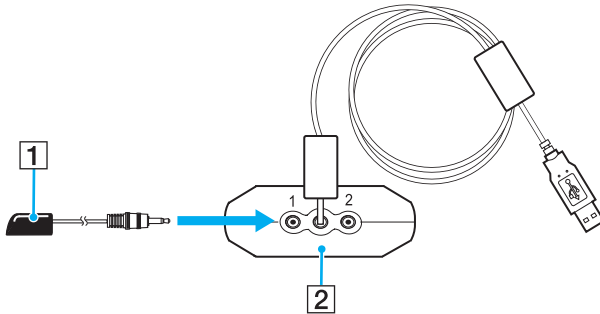

- 2 Remove the adhesive tape cover from the bottom of the remote sensor control (1).
- 3 Attach the remote sensor control (1) onto the set-top box (3) near the infrared sensor (4).

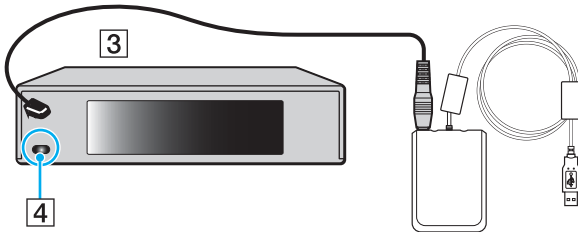

! Do not cover the infrared sensor when attaching the remote sensor control.

The remote sensor must be visible in a line of sight with the remote commander in order to function properly.

Using PC Cards

PC Cards allow you to connect portable external devices to your computer.

Inserting a PC Card

 Your computer is delivered with a slot protector in the **PC Card** slot. Remove the slot protector before you use the slot.

Some PC Cards or their functions may not be compatible with your computer.



You do not need to shut down your computer before inserting or removing a PC Card.

To insert a PC Card

- 1 Push the PC Card release button so that the release button pops out.
- 2 Push the PC Card release button a second time so that the PC Card slot protector pops out.
- 3 Gently take hold of the protector and pull it out of the slot.
- 4 Insert the PC Card into the **PC Card** slot with the front label facing upward.
- 5 Gently push the PC Card into the slot all the way to the end.
The PC Card is automatically detected by your system.
The **Safely Remove Hardware** icon appears on the taskbar.

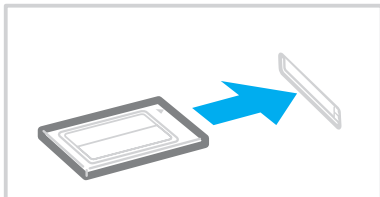

! Insert the PC Card slot protector to protect against debris entering the slot when not using a PC Card. Before moving your computer, make sure to insert the PC Card slot protector into the slot.



Some devices may not function properly if you continuously switch to Normal mode from Sleep or Hibernate mode. For some PC Cards, if you alternate between Normal mode and Sleep or Hibernate mode while the card is inserted, you may find that the device connected to your system through the PC Card is not recognized. Restart your system to correct the problem.

While the card is inserted, your computer may not enter Hibernate mode but Sleep mode. We recommend that you remove the card if you want the computer to enter Hibernate mode.

Make sure you use the latest software driver provided by the PC Card manufacturer.

Do not force a PC Card into the slot. It may damage the connector pins. If you have difficulty inserting a PC Card, check that you are inserting the PC Card in the correct direction. See the manual that came with your PC Card for more information.

Removing a PC Card

Follow the steps below to remove the PC Card while your computer is on. If it is not removed properly, your system may not work properly.

To remove a PC Card



To remove a PC Card when your computer is off, skip steps 1 to 7.

- 1 Double-click the **Safely Remove Hardware** icon on the taskbar.
The **Safely Remove Hardware** window appears.
- 2 Select the hardware you want to unplug.
- 3 Click **Stop**.
The **Stop a Hardware device** window appears.
- 4 Confirm that the device can be safely removed from the system.
- 5 Click **OK**.
A message appears stating it is now safe to remove the hardware device.
- 6 Click **OK**.
- 7 Click **Close** to close the **Safely Remove Hardware** window.
- 8 Push the PC Card release button so that the release button pops out.
- 9 Push the PC Card release button a second time so that the PC Card pops out.
- 10 Gently take hold of the Card and pull it out of the slot.
- 11 If the PC Card release button is still out, push it back in all the way to the end.

Using the ExpressCard Module

Your computer is equipped with either a Universal ExpressCard™ slot* or an ExpressCard™/34 slot* for transferring data among digital cameras, camcorders, music players, and other audio/video devices. The former can accommodate either an ExpressCard™/34 (34mm wide) or ExpressCard™/54 (54mm wide) module* as shown below; and the latter, an ExpressCard™/34 module* only.

- ExpressCard™/34 module*



- ExpressCard™/54 module*



Your computer is equipped with a Universal ExpressCard™ slot*.

* Referred to as the ExpressCard slot and the ExpressCard module in this manual.

Inserting an ExpressCard Module

! Your computer is delivered with a slot protector in the ExpressCard slot. Remove the slot protector before you use the slot.

Use care when inserting or removing the ExpressCard module from the slot. Do not force it in or out of the slot.



You do not need to shut down your computer before inserting or removing the ExpressCard module.

To insert an ExpressCard module

- 1 Locate the ExpressCard slot on the right of the computer.
- 2 Push the ExpressCard module release button so that the release button pops out.
- 3 Push the ExpressCard module release button a second time so that the ExpressCard slot protector pops out.
- 4 Gently take hold of the ExpressCard slot protector and pull it out of the slot.
- 5 Hold the ExpressCard module with the arrow facing upward and pointing toward the ExpressCard slot.
- 6 Carefully slide the ExpressCard module into the slot until it clicks into place.
Do not force it into the slot.

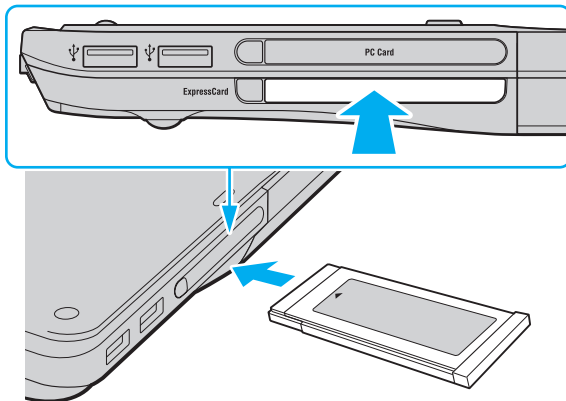

! Insert the ExpressCard slot protector to protect against debris entering the slot when not using an ExpressCard module. Before moving your computer, be sure to insert the ExpressCard slot protector into the slot.



If the module or adapter does not go into the slot easily, remove it gently and verify you are inserting it in the proper direction.

Make sure you use the most recent software driver provided by the ExpressCard module manufacturer.

Removing an ExpressCard Module

Follow the steps below to remove the ExpressCard module while your computer is on. If it is not removed properly, your system may not work properly.

To remove an ExpressCard module



To remove an ExpressCard module when your computer is off, skip steps 1 to 7.

- 1 Double-click the **Safely Remove Hardware** icon on the taskbar.
The **Safely Remove Hardware** window appears.
- 2 Select the hardware you want to unplug.
- 3 Click **Stop**.
The **Stop a Hardware device** window appears.
- 4 Confirm that the device can be safely removed from the system.
- 5 Click **OK**.
A message appears stating it is now safe to remove the device.
- 6 Click **OK**.
- 7 Click **Close** to close the **Safely Remove Hardware** window.
- 8 Push the ExpressCard module release button so that the release button pops out.
- 9 Push the ExpressCard module release button a second time so that the ExpressCard module pops out.
- 10 Gently take hold of the ExpressCard module and pull it out of the slot.
- 11 If the ExpressCard module release button is still out, push it back in all the way to the end.

Using the Memory Stick Media

Memory Stick media is a compact, portable, and versatile IC recording media especially designed for exchanging and sharing digital data with compatible products, such as digital cameras, mobile phones and other devices. Because it is removable, it can be used for external data storage.

Before You Use the Memory Stick Media

The Memory Stick slot on your computer can accommodate both standard- and Duo-size media and support Memory Stick PRO and Memory Stick PRO-HG Duo media with high speed and high capacity capabilities.



You can insert a Duo-size Memory Stick media directly into the Memory Stick slot without using a Memory Stick Duo Adaptor.



Before using a Memory Stick Micro (M2) media, be sure to insert it into an M2 Standard-size or M2 Duo-size Adaptor. If you insert the media directly into the Memory Stick slot without the Adaptor, you may not be able to remove it from the slot.

For the latest information about the Memory Stick media, visit the Memory Stick Web site at <http://www.memorystick.com/en/>.



Your computer has been tested and found compatible with Sony branded Memory Stick media with capacity of up to 8 GB that are available as of May 2007. However, not all Memory Stick media that meet the same specifications as the compatible media are guaranteed of compatibility.

Inserting a Memory Stick media with multiple conversion adapters is not guaranteed of compatibility.

MagicGate is the general name of the copyright protection technology developed by Sony. Use a Memory Stick media with the MagicGate logo to use this feature.

Besides for your personal enjoyment, it is against the copyright law to use any audio and/or image data you recorded without prior consent from the respective copyright holders. Accordingly, Memory Stick media with such copyrighted data can be used only within the law.

The Memory Stick slot on your computer does not support 8-bit parallel data transfer (high speed data transfer).

The Memory Stick Micro media in an M2 Duo-size Adaptor may not operate properly if it is additionally inserted into a Memory Stick Duo Adaptor.

Inserting a Memory Stick Media

To insert a Memory Stick media

- 1 Locate the Memory Stick slot.
- 2 Hold the Memory Stick media with the arrow facing upward and pointing toward the Memory Stick slot.
- 3 Carefully slide the Memory Stick media into the slot until it clicks into place.
The Memory Stick media is automatically detected by your system and the content of the Memory Stick media is displayed. If nothing appears on the desktop, click **Start, Computer**, and double-click the Memory Stick media icon.

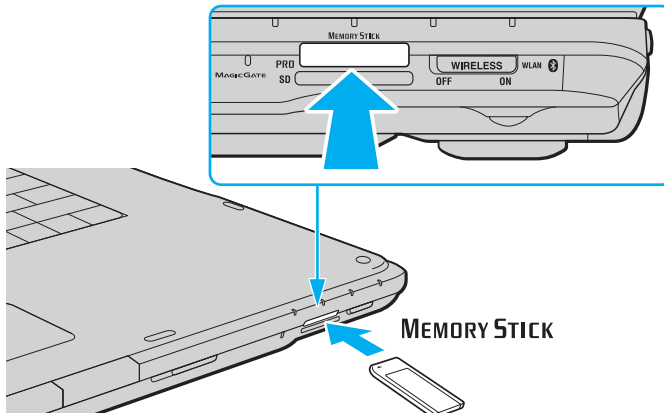

! Be sure to hold the Memory Stick media with the arrow pointing in the correct direction as you insert it into the slot. To avoid damaging your computer or the Memory Stick media, do not force the Memory Stick media into the slot if you cannot insert it smoothly.

Do not insert more than one Memory Stick media into the slot. Improper insertion of the media may damage both your computer and the media.

To view the contents of the Memory Stick media

- 1 Click **Start** and **Computer** to open the **Computer** window.
- 2 Double-click the Memory Stick media icon to view the list of data files saved in the Memory Stick media.

To format a Memory Stick media

The Memory Stick media has been formatted in the factory default setting and is ready for use. If you want to reformat the media with your computer, follow these steps.

! Be sure to use the device that is designed to format the media and supports the Memory Stick media when formatting the media.

Formatting the Memory Stick media erases the entire data on the media. Before formatting the media, make sure that it does not contain your valuable data.

Do not remove the Memory Stick media from the slot while formatting the media. This could cause a malfunction.

- 1 Carefully slide the Memory Stick media into the slot until it clicks into place.
- 2 Click **Start** and **Computer** to open the **Computer** window.
- 3 Right-click the Memory Stick media icon and select **Format**.
- 4 Click **Restore device defaults**.

! The size of the allocation unit and file system may change.

Do not select **NTFS** from the **File system** drop-down list as it may cause a malfunction.



The formatting process will be completed more quickly if you select **Quick Format** in **Format options**.

- 5 Click **Start**.
- 6 At the confirmation prompt, click **OK**.
The formatting process starts.

!

It may take time to format the Memory Stick media depending on the media.

- 7 Once completed, click **OK**.
- 8 Click **Close**.

Removing a Memory Stick Media

To remove a Memory Stick media

- 1 Check that the Memory Stick indicator is off.
- 2 Push the Memory Stick media in toward the computer.
The Memory Stick media ejects.
- 3 Pull the Memory Stick media out of the slot.



Always remove the Memory Stick media gently, or it may pop out unexpectedly.

Do not remove the Memory Stick media while the Memory Stick indicator is on. If you do, you may lose data. Large volumes of data may take time to load, so be sure the indicator is off before removing the Memory Stick media.

Using Other Memory Cards

In addition to the Memory Stick slot and ExpressCard slot, your computer is equipped with an **SD** memory card slot. You can use this slot to transfer data among digital cameras, camcorders, music players, and other audio/video devices.

Before You Use Memory Cards

The **SD** memory card slot on your computer supports the following memory cards:

- SD memory card
- SDHC memory card
- MultiMediaCard (MMC)

For the latest information on compatible memory cards, see **Sony Support Information (page 191)** to visit the appropriate support Web site.



Your computer has been tested and found compatible only with major memory card media available as of May 2007. However, not all memory card media that meet the same specifications as the compatible media are guaranteed of compatibility.

Always insert the correct memory card into the **SD** memory card slot.

SD memory cards with capacity of up to 2 GB and SDHC memory cards with capacity of up to 8 GB have been tested and found compatible with your computer.

The **SD** memory card slot on your computer does not support the copyright protection and high-speed data transfer features of the SD memory card and SDHC memory card.

Do not attempt to insert a memory card or memory card adapter of a different type into the **SD** memory card slot. An incompatible memory card or memory card adapter may cause difficulty in removing from the slot and can cause damage to your computer.

Use care when inserting or removing a memory card from the **SD** memory card slot. Do not force the memory card in or out of the slot.

Inserting a Memory Card

To insert a memory card

- 1 Locate the **SD** memory card slot.
- 2 Hold the memory card with the arrow facing upward and pointing toward the memory card slot.

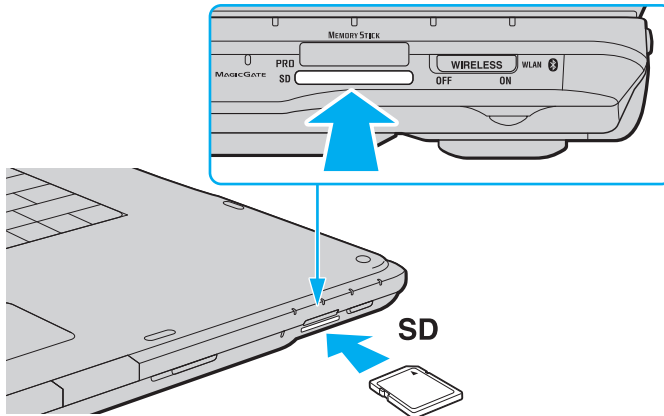

- 3 Carefully slide the memory card into the slot until it clicks into place.
Do not force the card into the slot.



If the memory card does not go into the slot easily, remove it gently and verify you are inserting it in the proper direction.

Removing a Memory Card

! Do not remove a memory card while the **SD** memory card indicator light is on. If you do, the card or its data may become damaged.

To remove a memory card

- 1 Check that the **SD** memory card indicator light is off.
- 2 Press the extended part of the memory card, causing it to extend out from the slot.
- 3 When the card extends, carefully pull it out of the slot.

Using the Internet

Setting Up a Dial-up Internet Connection

Before you can connect to the Internet, you need to connect your computer to a telephone line with a telephone cable (not supplied). Once you have set up your telephone cable connection, you are ready to connect to the Internet.

To connect a telephone cable

- 1 Plug one end of the phone cable (1) into the modem port  on the computer.
- 2 Plug the other end into the wall jack (2).

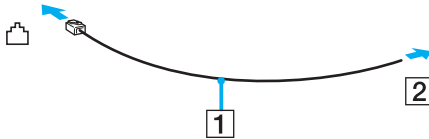

 Your computer does not work with party lines, cannot be connected to a coin-operated telephone, and may not work with multiple telephone lines or a private branch exchange (PBX). Some of these connections may result in excess electrical current and could cause a malfunction in the internal modem.

If you connect a telephone cable coming through a splitter, the modem or connected device may not work properly.

To set up a dial-up connection to the Internet

- 1 Click **Start** and **Control Panel**
- 2 Click **Connect to the Internet** under **Network and Internet**.
The **Connect to the Internet** window appears.
- 3 Click **Dial-up**.
- 4 Follow the on-screen instructions.

Using Wireless LAN (WLAN)

Using the Sony Wireless LAN (WLAN), all your digital devices with built-in WLAN functionality communicate freely with each other through a network. A WLAN is a network in which a user can connect to a Local Area Network (LAN) through a wireless (radio) connection. So there is no need anymore to pull cables or wires through walls and ceilings.

The Sony WLAN supports all normal Ethernet connectivity, but with the added benefits of mobility and roaming. You can still access information, Internet/intranet and network resources, even in the middle of a meeting, or as you move from one place to another.

You can communicate without an access point, which means that you can communicate with a limited number of computers (ad-hoc). Or you can communicate through an access point, which allows you to create a full infrastructure network.



In some countries, using WLAN products may be restricted by the local regulations (e.g. limited number of channels). Therefore, before activating the WLAN functionality, read the **Safety Information** carefully.

WLAN uses the IEEE 802.11a^{*}/b/g standard or the draft form of the IEEE 802.11n^{*} standard, which specifies the used technology. The standard includes the encryption methods: Wired Equivalent Privacy (WEP), which is a security protocol, Wi-Fi Protected Access 2 (WPA2), and Wi-Fi Protected Access (WPA). Proposed jointly by the IEEE and Wi-Fi Alliance, both WPA2 and WPA are specifications of standards based, interoperable security enhancements that increase the level of data protection and access control for existing Wi-Fi networks. WPA has been designed to be forward compatible with the IEEE 802.11i specification. It utilizes the enhanced data encryption TKIP (Temporal Key Integrity Protocol) in addition to user authentication using 802.1X and EAP (Extensible Authentication Protocol). Data encryption protects the vulnerable wireless link between clients and access points. Besides that, there are other typical LAN security mechanisms to ensure privacy, such as: password protection, end-to-end encryption, virtual private networks, and authentication. WPA2, the second generation of WPA, provides stronger data protection and network access control and is also designed to secure all versions of 802.11 devices, including 802.11b, 802.11a, 802.11g, and 802.11n, multi-band and multi-mode. In addition, based on the ratified IEEE 802.11i standard, WPA2 provides government grade security by implementing the National Institute of Standards and Technology (NIST) FIPS 140-2 compliant AES encryption algorithm and 802.1X-based authentication. WPA2 is backward compatible with WPA.

* See the online **Specifications** to see whether your model supports the IEEE 802.11a standard and/or the draft form of the IEEE 802.11n standard.

IEEE 802.11b/g is a wireless LAN standard, using the 2.4 GHz bandwidth. The IEEE 802.11g standard provides high-speed communications, faster than the IEEE 802.11b standard.

IEEE 802.11a is a wireless LAN standard, using the 5 GHz bandwidth, and provides high-speed communications of up to 54 Mbps.

IEEE 802.11n is a wireless LAN standard, using the 2.4 or 5 GHz bandwidth, and provides high-speed communications of up to 300 Mbps*.

* Actual communication speed varies depending on your access point settings and so on.

Your computer may employ the Intel® Next-Gen Wireless-N technology* compliant with the IEEE 802.11a/b/g standard and the draft form of the IEEE 802.11n standard.

* Employed only on models that support the draft form of the IEEE 802.11n standard.

Wireless LAN devices using the 2.4 GHz bandwidth and the ones using the 5 GHz bandwidth cannot communicate with each other because the frequencies are different.

The 2.4 GHz bandwidth used by wireless LAN compatible devices is also used by other various devices. Although technologies to minimize interference from other devices that use the same bandwidth are employed on wireless LAN compatible devices, such interference may cause lower communication speed, narrower communication range, or broken wireless connections.

The communication speed varies depending on the distance between communication devices, existence of obstacles between such devices, the device configuration, the radio conditions, and the software in use. In addition, communications may be cut off depending on the radio conditions.

The communication range varies depending on the actual distance between communication devices, existence of obstacles between such devices, the radio conditions, the ambient environment that includes existence of walls and materials of such walls, and the software in use.

Deploying IEEE 802.11b and IEEE 802.11g products on the same wireless network may reduce the communication speed due to radio interference. Taking this into consideration, the IEEE 802.11g products are designed to reduce the communication speed to ensure communications with IEEE 802.11b products. When the communication speed is not as fast as expected, changing the wireless channel on the access point may increase the communication speed.

Communicating without an Access Point (Ad-hoc)

An ad-hoc network is a network in which a LAN is created only by the wireless devices themselves, with no other central controller or access point. Each device communicates directly with other devices in the network. You can set up an ad-hoc network easily at home.

- If the wireless connection is initiated by the VAIO computer, channel 11 will be selected.
- If the wireless connection is initiated by peer wireless LAN equipment, the wireless LAN communication will make use of the channel selected by the peer wireless LAN equipment.

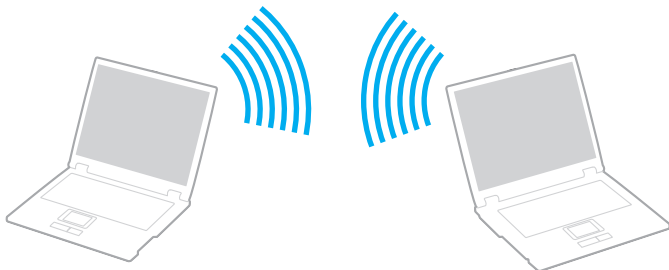



To communicate without an access point (ad-hoc)



You cannot select the 5 GHz bandwidth, which is used for the IEEE 802.11a standard, on ad-hoc networks.

The IEEE 802.11n standard, using the 2.4 or 5 GHz bandwidth, is not available on ad-hoc networks.

- 1 Turn on the **WIRELESS** or **WIRELESS LAN** switch.
The Wireless LAN indicator lights up.
- 2 Double-click  ( / ) on the taskbar to display the **Wireless Device Switch** window.
- 3 Select your desired wireless option(s) and click **OK**.
- 4 Click **Start** and **Control Panel**.
- 5 Click **View network status and tasks** under **Network and Internet**.
- 6 Click **Set up a connection or network** on the left pane.
The **Set up a connection or network** window appears.
- 7 Select an option to specify the ad-hoc network settings and click **Next**.
- 8 Follow the on-screen instructions.



See the online **Specifications** to see whether your model supports the Bluetooth functionality, the IEEE 802.11a/b/g standard, and/or the draft form of the IEEE 802.11n standard.

Communicating with an Access Point (Infrastructure)



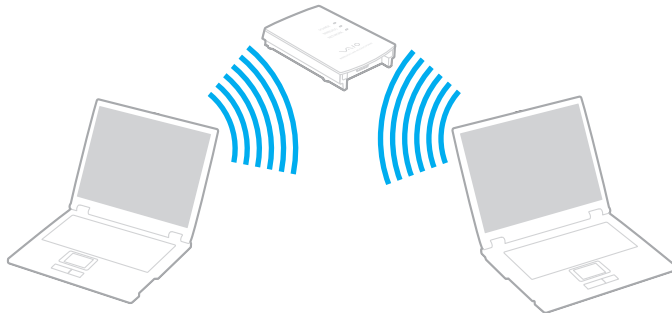

An infrastructure network is a network that extends an existing wired local network to wireless devices by providing an access point (not supplied), for example the Sony Access Point. The access point bridges the wireless and wired LAN and acts as a central controller for the wireless LAN. The access point coordinates transmission and reception from multiple wireless devices within a specific range.

The access point will select which channel to use on an infrastructure network.

! For details on how to select the channel that will be used by the access point, see the manual that came with your access point.



To connect to a wireless network

- 1 Make sure an access point is set up.
See the manual that came with your access point for more information.
- 2 Turn on the **WIRELESS** or **WIRELESS LAN** switch.
The Wireless LAN indicator lights up.
- 3 Double-click  ( / ) on the taskbar to display the **Wireless Device Switch** window.
- 4 Select your desired wireless option(s) and click **OK**.
- 5 Right-click  or  on the taskbar and select **Connect to a network**.
- 6 Select the desired access point and click **Connect**.



See the online **Specifications** to see whether your model supports the Bluetooth functionality, the IEEE 802.11a/b/g standard, and/or the draft form of the IEEE 802.11n standard.

Stopping Wireless LAN Communication

To stop wireless LAN communication

Turn off the **WIRELESS** or **WIRELESS LAN** switch.



Turning off the wireless LAN functionality while accessing remote documents, files, or resources may result in data loss.





For WPA-PSK or WPA2-PSK authentication, you must enter a passphrase. The passphrase is case sensitive and must be between 8 and 63 alphanumeric characters long or up to 64 characters long using numbers from 0 to 9 and letters from A to F.

Using the Bluetooth Functionality

The Bluetooth functionality is available on selected models only. See the online **Specifications** to see whether your model supports the Bluetooth functionality.

You can establish wireless communication between your computer and other Bluetooth devices such as another computer or a mobile phone. You can transfer data between these devices without cables and up to 33 feet (10 meters) range in open space.

To start Bluetooth communications

- 1 Turn on the **WIRELESS** switch.
- 2 Double-click  ( / ) on the taskbar to display the **Wireless Device Switch** window.
- 3 Select the **Enable Bluetooth Device** option.
- 4 Click **OK**.

Notes on using the Bluetooth functionality

- ❑ The data transfer rate varies, depending on the following conditions:
 - ❑ Obstacles, such as walls, located between devices
 - ❑ Distance between devices
 - ❑ Material used in walls
 - ❑ Proximity to microwaves and cordless telephones
 - ❑ Radio frequency interference and other environmental conditions
 - ❑ Device configuration
 - ❑ Type of software application
 - ❑ Type of operating system
 - ❑ Use of both wireless LAN and Bluetooth functionalities at the same time on your computer
 - ❑ Size of file being exchanged
- ❑ Note that due to limitations of the Bluetooth standard, large files may occasionally be corrupted during continuous transfer due to electromagnetic interference from the environment.
- ❑ All Bluetooth devices must be certified to make sure that the applicable standard requirements are maintained. Even if standards are met, individual device performance, specifications, and operation procedures can vary. Data exchange may not be possible in all situations.
- ❑ As general characteristics of Bluetooth technology, video and audio may go out of synchronization if you play videos on your computer with audio output from the connected Bluetooth device.

- ❑ The 2.4 GHz band, with which Bluetooth devices or wireless LAN devices work, is used by various devices. Bluetooth devices use the technology to minimize the interference from other devices that use the same wave length. Simultaneous use of the Bluetooth functionality and wireless communication devices, however, may cause radio interference and result in poorer communication speeds and distances than the standard values.
- ❑ The Bluetooth functionality may not work depending on the third party devices or the software version used by third party companies.
- ❑ As general characteristics of Bluetooth technology, connecting multiple Bluetooth devices to your computer may cause bandwidth congestion, resulting in poor performance of the devices.

Bluetooth Security

The Bluetooth wireless technology has an authentication function, which allows you to determine with whom you choose to communicate. With the authentication function, you can avoid any anonymous Bluetooth device to access your computer.

The first time two Bluetooth devices communicate, a common passkey (a password required for authentication) should be determined for both devices to be registered. Once a device is registered, there is no need to re-enter the passkey.



The passkey can be different each time, but must be the same at both ends.

For certain devices, such as a mouse, no passkey can be entered.

Communicating with Another Bluetooth Device

You can connect your computer to a Bluetooth device such as another computer, a mobile phone, a PDA, a headset, a mouse, or a digital camera without the use of any cables.

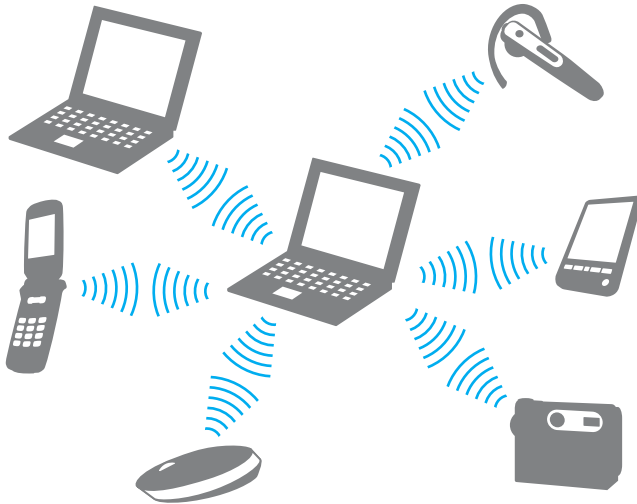

To communicate with another Bluetooth device

To communicate with another Bluetooth device, you need first to set up the Bluetooth functionality. For setting up and using the Bluetooth functionality, search for Bluetooth information using **Windows Help and Support**. To open **Windows Help and Support**, click **Start** and **Help and Support**.

Stopping Bluetooth Communications

To stop Bluetooth communications

Turn off the Bluetooth device that is communicating with your computer.

Using the Bluetooth Headset

The Bluetooth headset (not supplied) will come in handy during a video conference over the Internet using instant messaging software. For details on using the Bluetooth headset, see the manual that came with your Bluetooth headset.

To connect the headset with your computer

- 1 Press and hold the headset power button for at least five seconds to turn on the Bluetooth headset.
- 2 Press and hold the volume buttons for at least five seconds until the indicator light blinks in red and green.
- 3 Click **Start, Control Panel, Hardware and Sound**, and **Bluetooth Devices**.
The **Bluetooth Devices** window appears.
- 4 Click **Add** on the **Devices** tab.
The **Add Bluetooth Device Wizard** window appears.
- 5 Click to select the **My device is set up and ready to be found** check box and click **Next**.
The wizard searches for Bluetooth devices in range and lists available devices, if any.
- 6 Select the device name for your Bluetooth headset and click **Next**.
- 7 Enter "0000" for **Use the passkey found in the documentation** and click **Next**.
- 8 Click **Finish**.
The headset icon appears on the **Devices** tab in the **Bluetooth Devices** window.
- 9 Follow the on-screen instructions when the settings window for the headset appears.

To disconnect the headset from your computer

- 1 Click **Start, Control Panel, Hardware and Sound**, and **Bluetooth Devices**.
The **Bluetooth Devices** window appears.
- 2 Select the headset icon and select **Disconnect**.
- 3 Click **OK**.

Using Peripheral Devices

You can add functionality to your VAIO computer by using the various ports on the computer.

- ❑ **Connecting External Speakers** ([page 94](#))
- ❑ **Connecting an External Display** ([page 95](#))
- ❑ **Selecting Display Modes** ([page 101](#))
- ❑ **Using the Multiple Monitors Function** ([page 102](#))
- ❑ **Connecting an External Microphone** ([page 104](#))
- ❑ **Connecting a Universal Serial Bus (USB) Device** ([page 105](#))
- ❑ **Connecting a Printer** ([page 108](#))
- ❑ **Connecting an i.LINK Device** ([page 109](#))
- ❑ **Connecting to a Network (LAN)** ([page 111](#))

Connecting External Speakers

You can enhance the sound quality of your computer by connecting external speakers.

To connect external speakers

- 1 Plug the speaker cable (1) into the headphones jack (2) 🎧.
- 2 Plug the other end of the speaker cable to the external speaker (3).
- 3 Turn down the volume of the speakers before you turn them on.

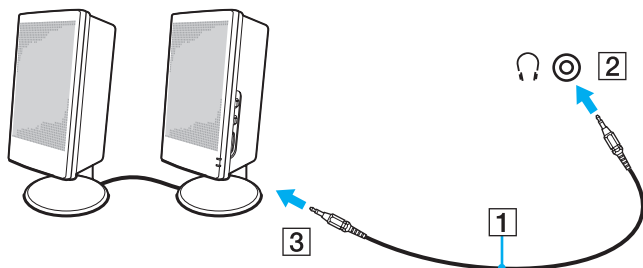

Make sure your speakers are designed for computer use.



Do not place floppy disks on the speakers; their magnetic field may damage the data on the disks.

Connecting an External Display

You can connect an external display (not supplied) to your computer. For example, you can use the computer with a computer display or a projector.



Connect the power cord after connecting all other cables.

Connected external displays are used as secondary screens.

On the Windows operating system, you can also use an external display to set up multiple monitors.

Connecting a Computer Display

You can connect a computer display (monitor) to your computer.

To connect a computer display

- 1 If necessary, plug one end of the display's power cord (1) into your display, and the other end into an AC outlet.
- 2 If you want to connect a VGA monitor, plug the display cable (2) (not supplied) into the monitor (VGA) port (3) □ on the computer.
- 3 If you want to connect a TFT/DVI monitor, use an HDMI cable (supplied with selected models only) and an HDMI to DVI-D adapter (supplied with selected models only) to connect the TFT/DVI monitor to the **HDMI** port on your computer.

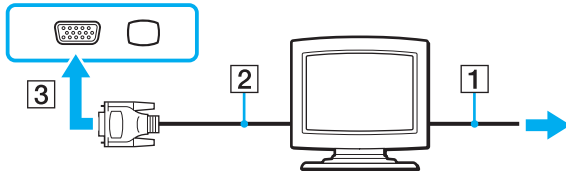

 DVI-D stands for Digital Visual Interface - Digital. It is a type of DVI connector that supports only digital video signals (no analog video signals). It has 24 pins.

A DVI-I (Digital Visual Interface - Integrated) connector supports digital video and analog video signals. It has 29 pins.

Connecting a Multimedia Computer Display

You can connect a multimedia computer display that includes built-in speakers and a microphone to your computer.

To connect a multimedia computer display

- 1 Plug the power cord of your multimedia computer display (1) into an AC outlet.
- 2 Plug the display cable (2) (not supplied) into the monitor (VGA) port (3) □ on the computer.
- 3 Plug the speaker cable (4) into the headphones jack (5) 🎧 on the computer.
- 4 Plug the microphone cable (6) into the microphone jack (7) 🎤 on the computer.

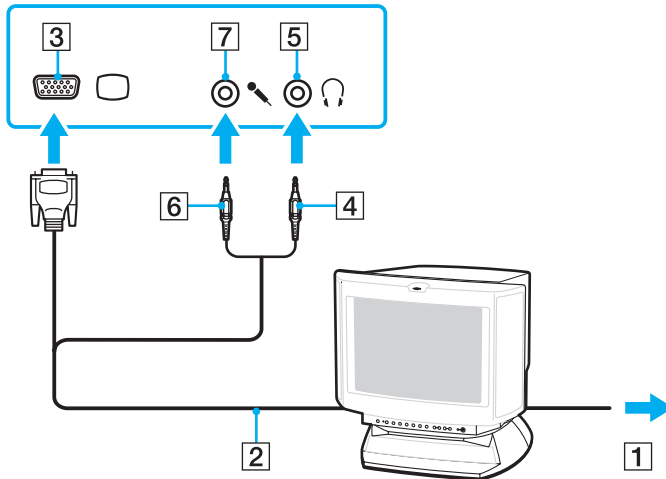

Connecting a TV

You can connect a TV to your computer.

To connect a TV to your computer

- 1 Plug the power cord of your TV into an AC outlet.
- 2 Plug one end of an S Video cable (not supplied) into the **S VIDEO OUTPUT** port on the computer and the other end to the TV.
- 3 Plug one end of an audio cable (not supplied) into the headphones jack on the computer and the other end to the TV.
- 4 Switch the input channel of the TV to external input.
- 5 Set up the TV configuration system.

If your TV is equipped with an HDMI port, you can then use an HDMI cable (supplied with selected models only) to connect the TV to your computer.

To connect an HDMI-compatible TV to your computer

- 1 Plug the power cord of your TV into an AC outlet.
- 2 Plug one end of an HDMI cable to the **HDMI** port on the computer and the other end to the TV.
- 3 Switch the input channel of the TV to external input.
- 4 Set up the TV configuration system.

! If your TV is equipped with an HDMI port and a DVI-D port, we recommend that you use the HDMI port.

The HDMI cable carries both video and audio signals.

If a device driver other than the one provided by Sony is used, the image will not be displayed and the audio will not be heard. Always use the device driver provided by Sony for updates.



See the manual that came with your peripheral for more information on installation and use.

You can connect the HDMI out to an AV amplifier and audio will be heard through the AV amplifier and then another HDMI cable can be connected from the AV amplifier to the TV for the display.

If the display resolution of your computer is more than 1024 x 768 pixels, a part of the image cannot be displayed on your TV. If you want to display the full image, change the display resolution of the computer to 1024 x 768 pixels or lower.

Connecting a Projector

You can connect a projector (for example, the Sony LCD projector) to your computer.

To connect a projector

- 1 Connect the power cord (1) of your projector into an AC outlet.
- 2 Plug an RGB signal cable (2) (not supplied) into the monitor (VGA) port (3) □ on the computer.
- 3 Plug an audio cable (4) (not supplied) into the headphones jack (5) 🎧 on the computer.
- 4 Plug the RGB signal cable and the audio cable into the jack and port on the projector (6).

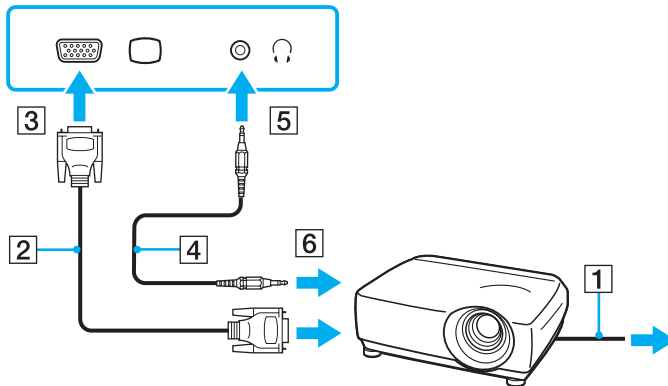

Selecting Display Modes

You can select which display to be used as the primary monitor when an external display (desktop monitor, etc.) is connected to your computer.

If you want to work on your computer screen and the external display at the same time, see **Using the Multiple Monitors Function (page 102)** for more information.

To select a display

- 1 Click **Start** and **Control Panel**.
- 2 Click **Additional Options**.
- 3 Click **NVIDIA Control Panel**.
- 4 Select the display setup option under **Display**.
- 5 Follow the on-screen instructions to change the settings.



You may not be able to display the same contents on your computer screen and the external display or projector at the same time, depending on the type of your external display or projector.

Before turning on your computer, turn on the peripheral devices.

Using the Multiple Monitors Function

The Multiple Monitors function allows you to distribute portions of your desktop across separate displays. For example, if you have an external display connected to the monitor (VGA) port, your computer screen and the external display can function as a single desktop.

You can move the cursor from one display to the other. This allows you to drag objects, such as an open application window or a toolbar, from one display to the other.

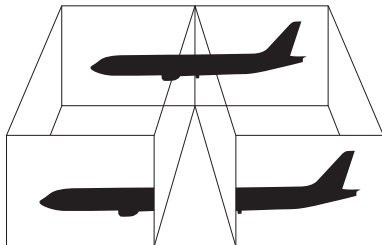

Your external display may not support the Multiple Monitors function.

Certain software applications may not be compatible with Multiple Monitors settings.

Make sure that your computer does not enter Sleep or Hibernate mode while you are using Multiple Monitors mode; otherwise the computer may not return to Normal mode.

If you set different colors on each display, do not expand a single window across two displays; otherwise your software may not work properly.

Set fewer colors or a lower resolution for each display.

To select the Multiple Monitors mode

- 1 Click **Start** and **Control Panel**.
- 2 Click **Adjust screen resolution** under **Appearance and Personalization**.
The **Display Settings** window appears.
- 3 Right-click the number **2** monitor and select **Attached**.
- 4 Click **OK**.
At the confirmation prompt, click **Yes**.



You can also change one of the **S** button assignments to activate the Multiple Monitors mode with the corresponding **S** button. To change the **S** button assignments, press and hold any **S** button to display the window for changing the assignment. For details on the **S** buttons, see **Using Special-function Buttons (page 31)**.

Additionally, you can set the display colors and resolution for each display and customize the Multiple Monitors mode.

Connecting an External Microphone

If you need to use a sound input device (for example, to chat over the Internet), you need to plug in an external microphone (not supplied).

To connect an external microphone

Plug the microphone cable (1) into the microphone jack (2) .

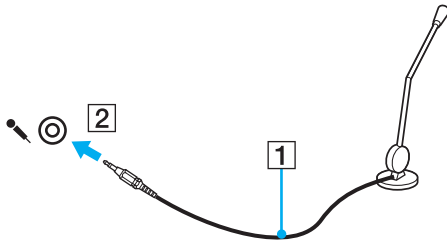

Make sure your microphone is designed for computer use.

Connecting a Universal Serial Bus (USB) Device

To prevent your computer and/or USB devices from damage, observe the following:

- ❑ When moving the computer with USB devices connected, avoid any shock or force to the USB ports.
- ❑ Do not put the computer into a bag or carrying case when it has USB devices connected.

Connecting a USB Mouse

To connect a USB mouse

- 1 Choose the USB port (1)  you prefer to use.
 - 2 Plug the USB mouse cable (2) into the USB port.
- You can now use your USB mouse (not supplied) (3).

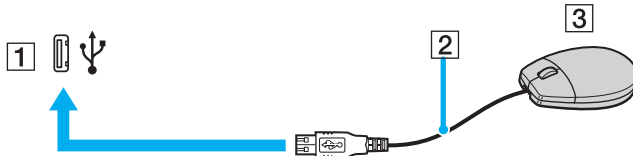

Connecting a USB Floppy Disk Drive

You can purchase a USB floppy disk drive and connect it to your computer.

To connect a USB floppy disk drive

- 1 Choose the USB port (1)  you prefer to use.
 - 2 Plug the USB floppy disk drive cable (2) into the USB port.
- Your USB floppy disk drive (3) is now ready for use.

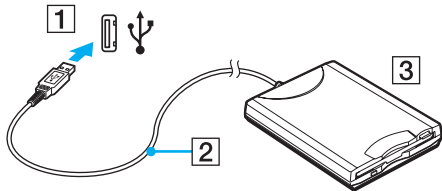

! When using a USB floppy disk drive, do not apply force on the USB port. This may cause a malfunction.

Disconnecting a USB floppy disk drive

You can disconnect a USB floppy disk drive when your computer is on or off. Disconnecting the drive when the computer is in a power saving mode (Sleep or Hibernate) may cause the computer to malfunction.

To disconnect a USB floppy disk drive



To disconnect a USB floppy disk drive when your computer is off, skip steps 1 to 8.

- 1 Close all programs accessing the floppy disk drive.
- 2 Double-click the **Safely Remove Hardware** icon on the taskbar.
The **Safely Remove Hardware** window appears.
- 3 Select the floppy disk drive you want to unplug.
- 4 Click **Stop**.
The **Stop a Hardware device** window appears.
- 5 Confirm that the floppy disk drive can be safely removed from the system.
- 6 Click **OK**.
A message appears stating it is now safe to remove the hardware device.
- 7 Click **OK**.
- 8 Click **Close** to close the **Safely Remove Hardware** window.
- 9 Disconnect the floppy disk drive from the computer.

Connecting a Printer

You can connect a Windows-compatible printer to your computer to print documents.

Connecting a Printer Using the USB Port

You can connect a USB printer compatible with your version of Windows to the computer.

To connect a printer using the USB port

- 1 Plug the power cord (1) of your printer into an AC outlet.
- 2 Choose the USB port (3)  you prefer to use.
- 3 Plug one end of a USB printer cable (2) (not supplied) into the USB port and the other end to your printer.

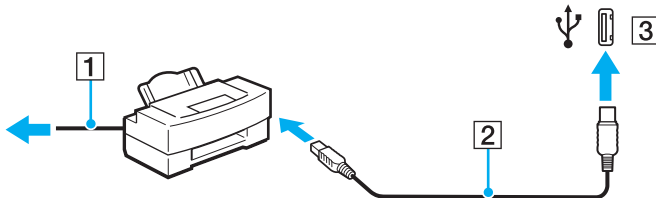

Connecting an i.LINK Device

Notes on connecting i.LINK devices

- ❑ Your computer is equipped with an i.LINK port, which you can use to connect to an i.LINK device such as a digital video camcorder.
- ❑ The i.LINK port on your computer does not supply power to external devices generally powered by i.LINK ports.
- ❑ The i.LINK port supports transfer rates up to 400 Mbps; however, the actual transfer rate depends on the transfer rate of the external device.
- ❑ The optional i.LINK cables may not be available in some countries or areas.
- ❑ An i.LINK connection with other compatible devices is not fully guaranteed.
- ❑ The i.LINK connection varies depending on the software applications, operating system, and i.LINK-compatible devices you use. See the manual that came with your software for more information.
- ❑ Check the working conditions and operating system compatibility of i.LINK-compatible PC peripherals (for example, an HDD or a CD-RW drive) before you connect them to your computer.

Connecting a Digital Video Camcorder

To connect a digital video camcorder

Plug one end of an i.LINK cable (1) (not supplied) into the i.LINK port (2) on the computer and the other end into the DV In/Out port (3) on the digital video camcorder.

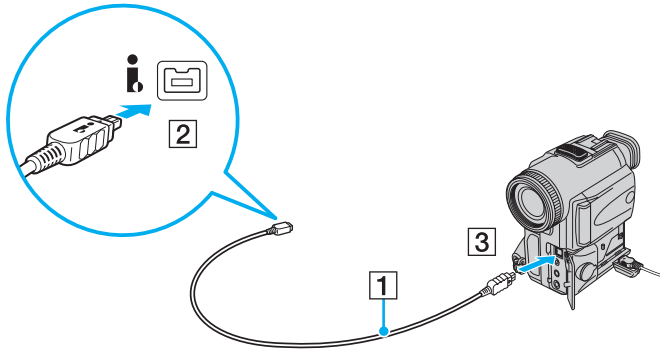

On Sony digital video cameras, ports labeled **DV Out**, **DV In/Out**, or **i.LINK** are i.LINK-compatible.

The Sony digital video camcorder shown here is an example; your digital video camcorder may need to be connected differently.

You cannot access the pictures stored on a Memory Stick media when using an i.LINK connection.

Connecting to a Network (LAN)

You can connect your computer to 1000BASE-T/100BASE-TX/10BASE-T-type networks with an Ethernet network cable. Connect one end of a network cable (not supplied) to the network (Ethernet) port on the computer and the other end to your network. For detailed settings and devices needed to connect to the network, ask your network administrator.

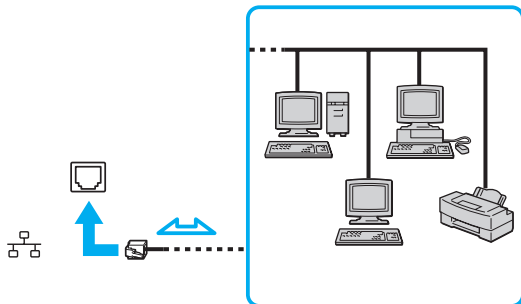

Your computer can be connected to the network with the default settings.

! Telephone lines cannot be connected to the network (LAN) connector on your computer. If the network (LAN) connector is connected to the telephone lines mentioned below, high electric current to the connector may cause damage, overheating, or fire.

- Home (intercom speakerphone) or business-use telephone lines (multi-line business telephone)
- Public telephone subscriber line
- PBX (private branch exchange)

Do not plug a telephone cable into the network port.

Customizing Your VAIO Computer

This section briefly describes how to change the main settings of your VAIO computer. Among other things, you will learn how to use and customize the look of your Sony software and utilities, etc.

- ❑ **Setting the Password** ([page 113](#))
- ❑ **Setting Up Your Computer with VAIO Control Center** ([page 116](#))
- ❑ **Using the Power Saving Modes** ([page 117](#))
- ❑ **Managing Power with VAIO Power Management** ([page 122](#))

Setting the Password

Use one of the BIOS functions to set the password.

Once you have set the password, you will be prompted to enter the password after the VAIO logo appears to start your computer. The power-on password allows you to protect your computer from unauthorized access.

Adding the Power-on Password

The power-on password is provided to protect your computer from unauthorized access.

! Once you have set the power-on password, you cannot start your computer without entering the password. Make sure not to forget the password. Write down your password and keep it safe and private from other people.

If you forget the power-on password and need assistance to reset it, a password reset fee will be charged, and your computer may need to be sent in for depot service for password reset.

To add the power-on password

- 1 Turn on the computer.
- 2 Press the **F2** key when the VAIO logo appears.
The BIOS setup screen appears. If not, restart the computer and press the **F2** key several times when the VAIO logo appears.
- 3 Press the **←** or **→** key to select **Security** to display the **Security** tab, select **Set Machine Password**, and then press the **Enter** key.
- 4 On the password entry screen, enter the password twice and press the **Enter** key.
The password can be up to 32 alphanumeric characters (including spaces) long.
- 5 At the confirmation prompt, press the **Enter** key.



The following is to configure your computer to prompt password entry when you turn it on or display the BIOS setup screen.

- 6 Select **Password when Power On** under **Security**.
Press the space bar to change the setting from **Disabled** to **Enabled**.
- 7 Press the **←** or **→** key to select **Exit**, select **Exit Setup**, and then press the **Enter** key.
At the confirmation prompt, press the **Enter** key.

Changing/Removing the Power-on Password

To change or remove the power-on password

- 1 Turn on the computer.
- 2 Press the **F2** key when the VAIO logo appears.
The BIOS setup screen appears. If not, restart the computer and press the **F2** key several times when the VAIO logo appears.
- 3 Enter the current password and press the **Enter** key.
- 4 Press the **←** or **→** key to select **Security** to display the **Security** tab, select **Set Machine Password**, and then press the **Enter** key.
- 5 On the password entry screen, enter the current password once and a new password twice, and then press the **Enter** key.
To remove the password, leave the **Enter New Password** and **Confirm New Password** fields blank and press the **Enter** key.
When confirmation to save the changes is prompted, press the **Enter** key.
- 6 Press the **←** or **→** key to select **Exit**, select **Exit Setup**, and then press the **Enter** key.
At the confirmation prompt, press the **Enter** key.

Setting Up Your Computer with VAIO Control Center

The **VAIO Control Center** utility allows you to access system information and to specify preferences for system behavior.

To use VAIO Control Center

- 1 Click **Start**, **All Programs**, and **VAIO Control Center**.
The **VAIO Control Center** window appears.
- 2 Select the desired control item and change the settings.
- 3 Once finished, click **OK**.
The setting of the desired item has been changed.



For more information about each option, see the help file on **VAIO Control Center**.

Some of the control items will not be visible if you open **VAIO Control Center** as a standard user.

Changing the default SONY logo lamp activity

The **SONY** logo lamp illuminates when you turn on your computer. You can change this default activity of the lamp to make it stay unlit by following these steps:

- 1 Click **Start**, **All Programs**, and **VAIO Control Center**.
The **VAIO Control Center** window appears.
- 2 Double-click **Display** and **Logo Lamp Control**.
- 3 Follow the on-screen instructions.

Using the Power Saving Modes

When you use a battery pack as the power source for your computer, you can take advantage of the power management settings to conserve battery life. In addition to the normal operating mode, which allows you to turn off specific devices, your computer has two distinct power saving modes: Sleep and Hibernate. When using battery power, you should be aware that the computer will automatically enter Hibernate mode if the remaining battery charge becomes short, regardless of the power management setting you select.

! If the battery level falls below 10%, you should either connect the AC adapter to recharge the battery pack or shut down your computer and install a fully charged battery pack.

Using Normal Mode

This is the normal state of the computer when it is in use. The green power indicator light is on in this mode. To save power while not working, you can turn off a specific device such as the LCD screen or the hard disk drive.

Using Sleep Mode

Sleep mode turns off the LCD screen and places the storage device(s) and the CPU into a low power consumption mode. The amber power light flashes during this mode.

! If you do not intend to use your computer for a long period of time while it is disconnected from AC power, place the computer into Hibernate mode or turn it off.

To activate Sleep mode

Click **Start**, the arrow next to the **Lock** button, and **Sleep**.



When your computer is in Sleep mode, you cannot insert a disc.

Your computer comes out of Sleep mode quicker than out of Hibernate mode.

Sleep mode uses more power than Hibernate mode.

If a remote commander is supplied with your computer, you can alternatively press the sleep button on the remote commander to place the computer into Sleep mode.

! If the battery runs down while your computer is in Sleep mode, you will lose all unsaved data. Going back to the previous work state is impossible. To avoid loss of data, you should save your data frequently.

To return to Normal mode

Press any key.

! If you press and hold the power button for more than four seconds, your computer will turn off automatically. You will lose all unsaved data.

If the computer is not used for a certain period of time, it will enter Sleep mode. To modify this, you can change the Sleep mode settings.

To change the Sleep mode settings

- 1 Right-click the power status icon on the taskbar and select **Power Options**.
- 2 Click **Change plan settings** under the current power plan.
- 3 Change the time to put the computer to sleep and click **Save Changes**.

Using Hibernate Mode

In Hibernate mode, the state of the system is saved on the hard disk drive and power is turned off. Even when the battery runs down, no data will be lost. The power indicator light is off in this mode.



If you do not intend to use your computer for a long period of time, place the computer into Hibernate mode. This power saving mode saves you the time of shutting down and resuming.

To activate Hibernate mode

Press the **Fn+F12** keys.

The computer enters Hibernate mode.

Alternatively, you can click **Start**, the arrow next to the **Lock** button, and **Hibernate** to place the computer into Hibernate mode.



When your computer is in Hibernate mode, you cannot insert a disc.

Hibernate mode requires more time than Sleep mode to be activated.

Hibernate mode uses less power than Sleep mode.



Do not move your computer before its power indicator light turns off.

To return to Normal mode

Press the power button.

The computer returns to its normal state.



If you press and hold the power button for more than four seconds, your computer will turn off automatically.



It takes more time to return to Normal mode from Hibernate mode than from Sleep mode.

Managing Power with VAIO Power Management

Power management helps you set up power schemes for running on AC or battery power to suit your requirements for power consumption.

VAIO Power Management is a software application developed exclusively for VAIO computers. With this software application, you can enhance the Windows power management functions to ensure better operation of your computer and longer battery life. For more information on **VAIO Power Management**, see the help file on the **VAIO Power Management** software.

Selecting a Power Plan

When you start the computer, a power status icon appears on the taskbar. This icon indicates what kind of power source you are using at that time, for example, AC power. Click this icon to display the window that shows your power status.

The **VAIO Power Management** functionality is added to the Windows **Power Options Properties**.

To select a power plan

- 1 Right-click the power status icon on the taskbar and select **Power Options**.
- 2 Select your desired power plan.

To change the power plan settings

- 1 Click **Change plan settings** under your desired power plan in the **Power Options** window.
Change the Sleep mode and display settings as needed.
- 2 If you need to change the advanced settings, click **Change advanced power settings** and go to step 3.
Otherwise, click **Save changes**.
- 3 Click the **VAIO Power Management** tab.
Change the settings for each item.
- 4 Click **OK**.

Upgrading Your VAIO Computer

Your VAIO computer and memory modules use high precision components and electronic connectors technology. To avoid invalidation of the warranty during your product warranty period, we recommend that:

- You should contact your dealer to install a new memory module.
- You should not install it yourself, if you are not familiar with upgrading memory on a computer.
- You should not touch the connectors or open the memory module compartment cover.

For the type of module and the amount of memory installed on your model, see the online **Specifications**.

For assistance, contact an authorized Sony Service Center. To find the nearest center or agent, see **Sony Support Information** ([page 191](#)).

Adding and Removing Memory

If you want to expand the functionality of your computer, you can increase the memory by installing optional memory modules. Before you upgrade your computer's memory, read the notes and procedures in the following pages.

Notes on adding/removing memory modules

- ❑ Be careful when changing memory. Improper installation of memory modules may cause damage to your system. This damage may void your manufacturer's warranty.
- ❑ Only use memory modules that are compatible with your computer. If a memory module is not detected by the computer or the Windows operating system becomes unstable, contact your sales dealer or the manufacturer of your memory module.
- ❑ Electrostatic discharge (ESD) can damage electronic components. Before touching a memory module, ensure the following:
 - ❑ The procedures described in this document assume user familiarity with the general terminology associated with personal computers and with the safety practice and regulatory compliance requirements for using and modifying electronic equipment.
 - ❑ Turn off your computer and disconnect it from its power source (that is, battery pack or AC adapter) and from any telecommunication links, networks, or modems before you remove any cover or panel from the computer. Failure to do so may result in personal injury or equipment damage.
 - ❑ ESD can damage memory modules and other components. Install the memory module only at an ESD workstation. If such a station is not available, do not work in a carpeted area, and do not handle materials that produce or hold static electricity (cellophane wrappers, for example). Ground yourself by maintaining contact with an unpainted metal portion of the chassis while performing the procedure.
 - ❑ Do not open the memory module package before you are ready to change the module. The package protects the module from ESD.

- ❑ Use the special bag delivered with the memory module or wrap the module in aluminum foil to protect it from ESD.
- ❑ Introducing any liquids, foreign substances, or objects into the memory module slots or other internal components of your computer will result in damage to the computer and any repair costs will not be covered by the warranty.
- ❑ Do not place the memory module in a location subject to:
 - ❑ Heat sources such as radiators or air ducts
 - ❑ Direct sunlight
 - ❑ Excessive dust
 - ❑ Mechanical vibration or shock
 - ❑ Strong magnets or speakers that are not magnetically shielded
 - ❑ Ambient temperature of more than 95°F (35°C) or less than 41°F (5°C)
 - ❑ High humidity
- ❑ Handle the memory module with care. To avoid injuries to your hands and fingers, do not touch the edges of the components and circuit boards inside your computer.

Removing and Installing a Memory Module

To change or add a memory module

- 1 Shut down the computer and disconnect all peripheral devices.
- 2 Unplug the computer and remove the battery pack.
- 3 Wait until the computer cools down.
- 4 Unscrew the screw (indicated by the arrow below) on the bottom of the computer and remove the memory module compartment cover.

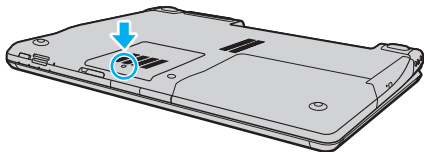

- 5 Touch a metal object to discharge static electricity.
- 6 Remove the currently installed memory module as follows:
 - Pull the latches in the direction of the arrows (1). The memory module is released.
 - Make sure that the memory module tilts up and then pull it out in the direction of the arrow (2).

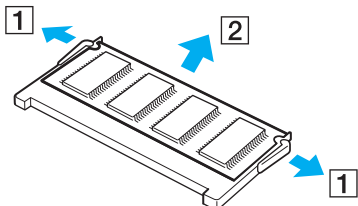

- 7 Remove the new memory module from its packaging.
- 8 Slide the memory module into the memory module slot and push it in until it clicks into place.

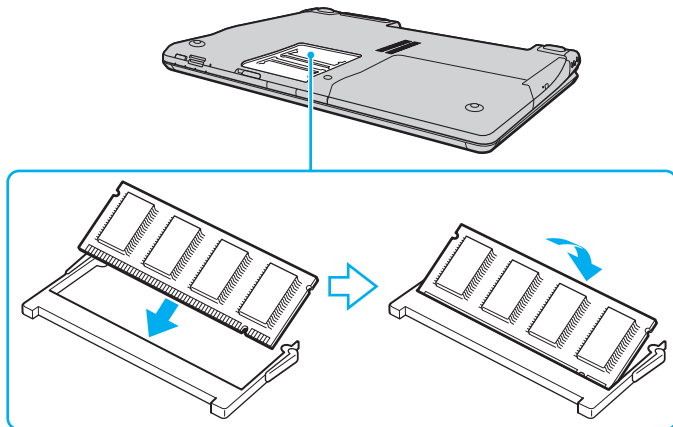

! If you use only one memory module, make sure to insert it to the slot that is closer to the back of your computer.

Do not touch any other components on the motherboard.

Be sure to insert the connector edge of the memory module into the slot while aligning the notch on the module with the small projection in the open slot.

- 9 Replace the memory module compartment cover.
- 10 Tighten the screw on the bottom of the computer.
- 11 Reinstall the battery pack and turn on the computer.

Viewing the Amount of Memory

To view the amount of memory

- 1 Turn on the computer.
- 2 Click **Start, All Programs, and VAIO Control Center**.
The **VAIO Control Center** window appears.
- 3 Double-click the **System Information** icon under the **System Information** folder.
You can view the amount of system memory. If the additional memory does not appear, repeat the whole installation procedure and restart the computer.

Precautions

This section describes safety guidelines and precautions to help you protect your VAIO computer from potential damage.

- ❑ **On Handling the LCD Screen** ([page 130](#))
- ❑ **On Using the Power Source** ([page 131](#))
- ❑ **On Handling Your Computer** ([page 132](#))
- ❑ **On Using the Built-in MOTION EYE Camera** ([page 134](#))
- ❑ **On Handling Floppy Disks** ([page 135](#))
- ❑ **On Handling Discs** ([page 136](#))
- ❑ **On Using the Battery Pack** ([page 137](#))
- ❑ **On Using Headphones** ([page 139](#))
- ❑ **On Handling Memory Stick Media** ([page 140](#))
- ❑ **On Handling the Hard Disk** ([page 141](#))
- ❑ **On Updating Your Computer** ([page 142](#))

On Handling the LCD Screen

- ❑ Do not leave the LCD screen facing the sun. This could damage the LCD screen. Be careful when using your computer near a window.
- ❑ Do not scratch the surface of the LCD screen or exert pressure on it. This could cause a malfunction.
- ❑ Using your computer in low temperature conditions may produce a residual image on the LCD screen. This is not a malfunction. When the computer returns to normal temperature, the screen returns to normal.
- ❑ A residual image may appear on the LCD screen if the same image is displayed for a long period of time. The residual image disappears in a while. You can use a screen saver to prevent residual images.
- ❑ The LCD screen becomes warm during operation. This is normal and does not indicate a malfunction.
- ❑ The LCD screen is manufactured using high-precision technology. You may, however, see tiny black points and/or bright points (red, blue, or green) that continuously appear on the LCD screen. This is a normal result of the manufacturing process and does not indicate a malfunction.
- ❑ Avoid rubbing the LCD screen. This could damage the screen. Use a soft, dry cloth to wipe the surface of the LCD screen.
- ❑ Do not change the LCD screen orientation setting in the **Tablet PC Settings** window even when there are change options available for selection, as it may make your computer unstable. Sony assumes no liabilities for any defects arising out of making the change.

On Using the Power Source

- ❑ See the online **Specifications** to check the power operation of your model.
- ❑ Do not share the AC outlet with other power-consuming equipment, such as a photocopier or a shredder.
- ❑ You can purchase a power strip with a surge protector. This device helps prevent damage to your computer caused by sudden power surges, in an electrical storm, for example.
- ❑ Do not place heavy objects on the power cord.
- ❑ To disconnect the cord, pull it out by holding the plug. Never pull the cord itself.
- ❑ Unplug your computer from the AC outlet if you are not planning to use the computer for a long period of time.
- ❑ Make sure that the AC outlet is easily accessible.
- ❑ When the AC adapter is not used, unplug it from the AC outlet.
- ❑ Use the AC adapter supplied with your computer or genuine Sony products. Do not use any other AC adapter as it may cause a malfunction.

On Handling Your Computer

- ❑ Clean the cabinet with a soft cloth, which is dry or lightly moistened with a mild detergent solution. Do not use any type of abrasive pad, scouring powder, or solvent such as alcohol or benzene, as these may damage the finish of your computer.
- ❑ If you drop a solid object or any liquid onto your computer, shut down the computer and then unplug it. You may want to have the computer checked by qualified personnel before operating it again.
- ❑ Do not drop your computer or place any objects on top of the computer.
- ❑ Do not place your computer in a location subject to:
 - ❑ Heat sources, such as radiators or air ducts
 - ❑ Direct sunlight
 - ❑ Excessive dust
 - ❑ Moisture or rain
 - ❑ Mechanical vibration or shock
 - ❑ Strong magnets or speakers that are not magnetically shielded
 - ❑ Ambient temperature of more than 95°F (35°C) or less than 41°F (5°C)
 - ❑ High humidity
- ❑ Do not place electronic equipment near your computer. The electromagnetic field of the computer may cause a malfunction.
- ❑ Provide adequate air circulation to prevent internal overheating. Do not place your computer on porous surfaces such as rugs or blankets, or near material such as curtains or draperies that may block its air vents.
- ❑ Your computer uses high-frequency radio signals and may cause interference to radio or TV reception. If this occurs, relocate the computer a suitable distance away from the set.

- ❑ Use only specified peripheral equipment and interface cables; otherwise, problems may occur.
- ❑ Do not use cut or damaged connection cables.
- ❑ If your computer is brought directly from a cold location to a warm one, moisture may condense inside the computer. In this case, allow at least one hour before turning on the computer. If any problems occur, unplug the computer and contact an authorized Sony Service Center. To find the nearest center or agent, see **Sony Support Information (page 191)**.
- ❑ Make sure you disconnect the power cord before cleaning your computer.
- ❑ To avoid losing data if your computer is damaged, back up your data regularly.
- ❑ Do not exert pressure on the LCD screen or its edges when opening the LCD screen lid or lifting your computer. The LCD screen may be sensitive to pressure or added stress and exerting pressure may damage the screen or cause it to malfunction. To open the computer, hold the base with one hand and gently lift the LCD screen lid with the other. To carry the computer with the lid open, be sure to hold the computer with both hands.

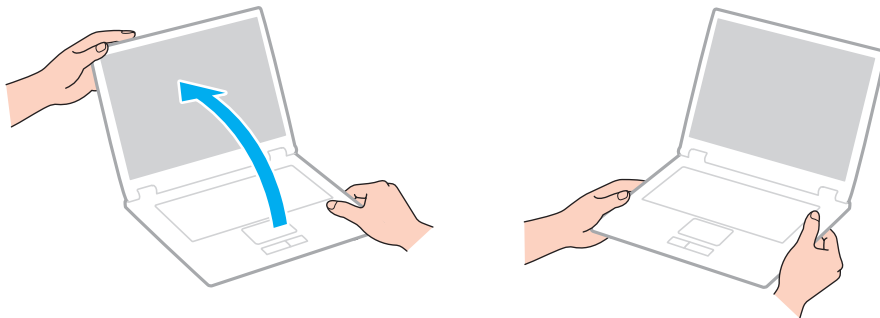

- ❑ Use a carrying case specially designed to carry your computer.

On Using the Built-in MOTION EYE Camera

- ❑ Do not touch the lens protection cover of the built-in **MOTION EYE** camera, as it may cause scratches on the cover and such scratches will appear on the captured images.
- ❑ Do not let the direct sunlight get into the scope of the built-in **MOTION EYE** camera regardless of your computer's power state, as it may cause a malfunction of the camera.
- ❑ The built-in **MOTION EYE** camera is disabled while videos or still images are imported from an i.LINK-compatible device connected to the i.LINK port.
- ❑ Clean the lens protection cover of the built-in **MOTION EYE** camera with a blower brush or a soft brush. If the cover is extremely dirty, wipe it off with a soft dry cloth. Do not rub the cover, as it is force-sensitive.

On Handling Floppy Disks

- ❑ Do not open the shutter manually or touch the surface of the floppy disk.
- ❑ Keep floppy disks away from magnets.
- ❑ Keep floppy disks away from direct sunlight and other sources of heat.
- ❑ Keep floppy disks away from any liquid. Do not let them get wet. When you are not using your floppy disk, always remove it from the floppy disk drive and use a storage case.
- ❑ If the floppy disk comes with an adhesive label, make sure that the label is properly affixed. If the edge of the label is curled up, the label may stick to the inside of the floppy disk drive and cause a malfunction or damage your floppy disk.

On Handling Discs

- ❑ Do not touch the surface of the disc.
- ❑ Do not drop or bend the disc.
- ❑ Fingerprints and dust on the surface of a disc may cause read errors. Always hold the disc by its edges and central hole, as shown below:

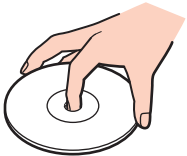

- ❑ Proper care of the disc is essential to its continuous reliability. Do not use solvents (such as benzine, thinner, alcohol, commercially available cleaners, or anti-static spray) which may cause damage to the disc.
- ❑ For normal cleaning, hold the disc by its edge and use a soft cloth to wipe the surface from the center out.
- ❑ If the disc is badly soiled, moisten a soft cloth with water, wring it out well, and use it to wipe the surface of the disc from the center out. Wipe off any remaining moisture with a dry soft cloth.
- ❑ Never affix an adhesive label to a disc. This will affect the use of the disc irreparably.

On Using the Battery Pack

- ❑ Do not leave battery packs in temperatures above 140°F (60°C), such as in a car parked in the sun or under direct sunlight.
- ❑ Battery life is shorter in a cold environment. This is due to decreased battery efficiency at low temperatures.
- ❑ Charge battery packs at temperatures between 50°F to 86°F (10°C to 30°C). Lower temperatures require longer charging time.
- ❑ Do not charge the battery pack in any way other than as described in this user guide or as designated by Sony in writing.
- ❑ For your safety, Sony recommends using the genuine Sony battery pack and AC adapter that are provided with this product. If either of these items need to be replaced during the life of the product, be sure to use a compatible genuine Sony battery pack or AC adapter. Information about compatible models can be found at the following URLs:
<http://www.sony.com/vaio> for customers in USA and Canada
<http://www.sony.net/> for customers in Latin American countries or areas
- ❑ Sony disclaims and shall assume no responsibility in case of any losses and damages arising from:
 - ❑ the use of non-genuine Sony battery packs or AC adapters with your VAIO computer.
 - ❑ the disassembly or alteration of, or tampering with, any Sony battery pack.
- ❑ While the battery pack is in use or being charged, heat builds up in the battery pack. This is normal and is not cause for concern.
- ❑ Keep the battery pack away from all sources of heat.
- ❑ Keep the battery pack dry.
- ❑ Do not open or try to disassemble the battery pack.
- ❑ Do not expose the battery pack to any mechanical shock.
- ❑ If you are not using your computer for a long period of time, remove the battery pack from the computer to prevent damage to the battery pack.

- ❑ If, after fully charging the battery pack, the battery power is still low, the battery pack may be reaching the end of its life and should be replaced.
- ❑ You do not need to discharge the battery pack before recharging.
- ❑ If you have not used the battery pack for a considerable amount of time, recharge the battery pack.

On Using Headphones

- ❑ **Road safety** – Do not use headphones while driving, cycling, or operating any motorized vehicle. It may create a traffic hazard and is illegal in some areas. It can also be potentially dangerous to play loud music while walking, especially at pedestrian crossings.
- ❑ **Preventing hearing damage** – Avoid using headphones at high volume. Hearing experts advise against continuous, loud and extended play. If you experience a ringing in your ears, reduce the volume or discontinue use.

On Handling Memory Stick Media

- ❑ Do not touch the Memory Stick media connector with your finger or metallic objects.
- ❑ Use only the adhesive label supplied with the Memory Stick media as a label.
- ❑ Do not bend, drop, or apply strong shock to the Memory Stick media.
- ❑ Do not disassemble or modify Memory Stick media.
- ❑ Do not let Memory Stick media get wet.
- ❑ Do not use or store Memory Stick media in a location subject to:
 - ❑ Static electricity
 - ❑ Electrical noise
 - ❑ Extremely high temperatures, such as in a car parked in the sun
 - ❑ Direct sunlight
 - ❑ High humidity
 - ❑ Corrosive substances
- ❑ Use the storage case supplied with the Memory Stick media.
- ❑ Be sure to make a backup copy of your valuable data.
- ❑ Keep the Memory Stick media and Memory Stick Adaptors out of reach of children. There is a risk of swallowing them.
- ❑ When using the Memory Stick Duo media, do not use a fine-tipped pen to write on the label adhered to the Memory Stick Duo media. Exerting pressure on the media may damage internal components.

On Handling the Hard Disk

The hard disk drive has a high storage density and reads or writes data in a short time. However, it can be easily damaged by mechanical vibration, shock, or dust.

Although the hard disk drive has the internal safety device to prevent losing data due to mechanical vibration, shock or dust, you should be careful when handling your computer.

To avoid damaging your hard disk drive

- Do not subject your computer to sudden movements.
- Keep your computer away from magnets.
- Do not place your computer in a location subject to mechanical vibration or in an unstable position.
- Do not move your computer while the power is on.
- Do not turn off the power or restart your computer while reading or writing data to the hard disk drive.
- Do not use your computer in a place subject to extreme changes in temperature.



If the hard disk drive is damaged, the data cannot be restored.

On Updating Your Computer

Confirm that the latest updates have been installed on your computer using the following software applications so that the computer can run more efficiently.

To confirm that they have been installed on the computer, follow these steps for each software application:

❑ **Windows Update**

Click **Start**, **All Programs**, and **Windows Update** and then follow the on-screen instructions.

❑ **VAIO Update 3**

Click **Start**, **All Programs**, **VAIO Update 3**, and **VAIO Update Options** and then follow the on-screen instructions.

If you have not yet installed the latest updates, install them with the above software. To download and install the updates on the computer, the computer must be connected to the Internet. For information on how to connect the computer to the Internet, see **Using the Internet** ([page 78](#)).

Troubleshooting

This section describes how to solve common problems you might encounter when using your VAIO computer. Many problems have simple solutions. Try these suggestions before visiting the Sony online support Web site at the following URLs:

<http://esupport.sony.com/EN/VAIO/> for customers in USA

<http://www.sony.ca/support> for customers in Canada

<http://esupport.sony.com/ES/VAIO/> for customers in Spanish speaking Latin American countries or areas

<http://esupport.sony.com/ES/VAIO/BR/> for customers in Brazil

- Computer (page 145)**
- System Security (page 152)**
- Battery (page 153)**
- Built-in MOTION EYE Camera (page 155)**
- Internet (page 158)**
- Networking (page 160)**
- Bluetooth Technology (page 163)**
- Optical Discs (page 167)**
- Display (page 171)**
- Printing (page 176)**
- Microphone (page 177)**
- Mouse (page 178)**
- Speakers (page 179)**
- Touch Pad (page 181)**
- Keyboard (page 182)**

- ❑ **Floppy Disks** ([page 183](#))
- ❑ **PC Cards** ([page 184](#))
- ❑ **Audio/Video** ([page 186](#))
- ❑ **Memory Stick Media** ([page 189](#))
- ❑ **Peripherals** ([page 190](#))

Computer

What should I do if my computer does not start?

- ❑ Make sure your computer is securely plugged into a power source and turned on. Make sure the power indicator shows the power is on.
- ❑ Make sure the battery pack is installed properly and charged.
- ❑ Make sure the floppy disk drive (if applicable) is empty.
- ❑ If your computer is plugged into a power strip or an uninterruptible power supply (UPS), make sure the power strip or UPS is plugged into a power source and turned on.
- ❑ If you are using an external display, make sure it is plugged into a power source and turned on. Make sure the brightness and contrast controls are adjusted correctly. See the manual that came with your display for more information.
- ❑ Disconnect the AC adapter and remove the battery pack. Wait three to five minutes. Reinstall the battery pack, reconnect the AC adapter, and then press the power button to turn on your computer.
- ❑ Condensation may cause your computer to malfunction. If this occurs, do not use the computer for at least one hour.
- ❑ Remove any extra memory modules you may have installed since purchase.
- ❑ Check that you are using the supplied Sony AC adapter. For your safety, use only the genuine Sony rechargeable battery pack and AC adapter, which are supplied by Sony for your VAIO computer.

What should I do if a BIOS error appears when I turn on my computer?

If the message "Press <F1> to resume, <F2> to setup" appears at the bottom of the screen, follow these steps:

- 1 Press the **F2** key.
The BIOS setup screen appears. If not, restart the computer and press the **F2** key several times when the VAIO logo appears.
- 2 Set the date (month/day/year). Press the **Enter** key.
- 3 Press the **↓** key to select **System Time**, and then set the time (hour: minute: second). Press the **Enter** key.
- 4 Press the **→** key to select the **Exit** tab, and then press the **F9** key.
At the confirmation prompt, press the **Enter** key.
- 5 Select **Exit Setup**, and press the **Enter** key.
At the confirmation prompt, press the **Enter** key.
Your computer restarts.

If this occurs frequently, contact an authorized Sony Service Center. To find the nearest center or agent, see **Sony Support Information** (page 191).

What should I do if the power indicator (Green) lights but my screen stays blank?

Follow these steps:

- 1 Press and hold the power button for more than four seconds to check that the power indicator goes out. Then turn on your computer again.
- 2 If your computer screen still stays blank, unplug the AC adapter, remove the battery pack, and leave the computer for about a minute. Then reinstall the battery pack, plug in the AC adapter, and turn on the computer again.

What should I do if my computer or software stops responding?

- ❑ If your computer stops responding while a software application is running, press the **Alt+F4** keys to close the application window.
- ❑ If the **Alt+F4** keys do not work, click **Start**, the arrow next to the **Lock** button, and **Shut Down** to turn off your computer.
- ❑ If your computer does not turn off, press the **Ctrl+Alt+Delete** keys and click the arrow  next to the **Shut down** button and **Shut Down**.
If the **Windows Security** window appears, click **Shut Down**.



Turning off your computer with the **Ctrl+Alt+Delete** keys or the power button may cause loss of unsaved data.

- ❑ If your computer still does not turn off, press and hold the power button until the computer turns off.
- ❑ Remove the AC adapter and battery pack.
- ❑ Try reinstalling the software.
- ❑ Contact the software publisher or designated provider for technical support.

Why doesn't my computer enter Sleep or Hibernate mode?

Your computer may become unstable if the operating mode is changed before the computer completely enters Sleep or Hibernate mode.

To restore your computer to normal operating stability

- 1 Close all open programs.
- 2 Click **Start**, the arrow next to the **Lock** button, and **Restart**.
- 3 If your computer does not restart, press the **Ctrl+Alt+Delete** keys and click the arrow next to the **Shut down** button and **Restart**.
- 4 If this procedure does not work, press and hold the power button until the computer turns off.



Turning off your computer with the power button may cause loss of unsaved data.

What should I do if the battery indicator is flashing and my computer does not start?

- ❑ This symptom could be due to the battery pack not being installed properly. To resolve this symptom, turn off your computer and remove the battery pack. Then install the battery pack to the computer again. For details, see **Installing the Battery Pack (page 23)**.
- ❑ If the symptom persists after performing the above, it means the installed battery pack is not compatible. Remove the battery pack and contact an authorized Sony Service Center. To find the nearest center or agent, see **Sony Support Information (page 191)**.

What should I do if a message window, notifying of incompatibility or improper installation of the battery pack, appears and my computer enters Hibernate mode?

- ❑ This symptom could be due to the battery pack not being installed properly. To resolve this symptom, turn off your computer and remove the battery pack. Then install the battery pack to the computer again. For details, see **Installing the Battery Pack (page 23)**.
- ❑ If the symptom persists after performing the above, it means the installed battery pack is not compatible. Remove the battery pack and contact an authorized Sony Service Center. To find the nearest center or agent, see **Sony Support Information (page 191)**.

Why does the System Properties window display a slower CPU speed than the maximum?

This is normal. Because your computer's CPU utilizes a type of CPU speed controlling technology for power conservation purposes, System Properties may display the CPU's current speed instead of the maximum speed.

What should I do if Windows does not start, showing a message, when I start my computer?

If you enter a wrong power-on password three times consecutively, the **Enter Onetime Password** message appears. If you enter a wrong power-on password three times consecutively again, the **System Disabled** message appears and Windows will not start. Press and hold the power button for more than four seconds to check that the power indicator goes off. Wait for 10 or 15 seconds, then restart your computer and enter the correct password. When entering the password, check that the Num lock indicator and Caps lock indicator are off. If any are lit, press the **Num Lk** key or the **Caps Lock** key to turn off the indicator before entering the password.

What should I do if my game software does not work or it keeps crashing?

- ❑ Check the Web site of the game if there are any patches or updates to download.
- ❑ Make sure you have installed the latest video driver.
- ❑ On some VAIO models, the graphics memory is shared with the system. The optimal graphic performance in this case is not guaranteed.

What should I do if I cannot remember the BIOS password?

If you have forgotten the BIOS password, contact an authorized Sony Service Center to reset it. A reset fee will be charged. To find the nearest center or agent, see **Sony Support Information (page 191)**.

Why does it take time before my computer starts?

If Norton Internet Security's Personal Firewall is active, it may take some time before the desktop screen appears due to network security checkups.

Why doesn't my screen turn off when the time selected for the automatic turn-off action has passed?

The **VAIO Original Screen Saver** disables the timer setting, which you can select using the Windows power options, for your screen to turn off.

Select the screen saver other than the **VAIO Original Screen Saver**.

What should I do if I cannot boot my computer from the USB floppy disk drive connected to the computer?

To boot your computer from the USB floppy disk drive, you need to change the boot device.

Turn on your computer and press the **F11** key several times before the VAIO logo appears.

System Security

How can I protect my computer against security threats, such as viruses?

The Microsoft Windows operating system is preinstalled on your computer. The best way to protect your computer against security threats, such as viruses, is to download and install the latest Windows updates regularly.

You can get important Windows updates by doing the following:



Your computer must be connected to the Internet before you can receive updates.

- 1 Connect to the Internet.
- 2 Double-click the **Windows Security Alerts** icon on the taskbar.
- 3 Follow the on-screen instructions to set up automatic or scheduled updates.

How do I keep my antivirus software updated?

You can keep the **Norton Internet Security** software program current with the latest updates from Symantec Corporation.

To download and install the latest security update

- 1 Click **Start, All Programs, Norton Internet Security, and Norton Internet Security**.
- 2 Click the item to update the software on the left pane.
- 3 Follow the on-screen instructions to select and download updates.

Battery

How do I find the battery charging status?

See **Charging the Battery Pack** ([page 24](#)).

When is my computer using AC power?

When your computer is directly connected to the AC adapter, it uses AC power, even if the battery pack is installed.

When should I recharge the battery pack?

- When the battery level falls below 10%.
- When both the battery and power indicators blink.
- When you have not used the battery pack for a long period of time.

When should I replace the battery pack?

If the battery power is still low after charging it, the battery pack may be reaching the end of its life and should be replaced.

Should I be concerned that the installed battery pack is warm?

No, it is normal for the battery pack to be warm when it is powering your computer.

Can my computer enter Hibernate mode while using battery power?

Your computer can enter Hibernate mode while using battery power, but some software programs and peripheral devices prevent the system from entering Hibernate mode. If you are using a program that prevents the system from entering Hibernate mode, save your data frequently to avoid losing data. See **Using Hibernate Mode (page 120)** for information on how you can manually activate Hibernate mode.

Built-in MOTION EYE Camera

Why does the viewer window show no images or poor-quality images?

- The built-in **MOTION EYE** camera cannot be shared by more than one software application. If another software application is using the camera, exit the application before using the built-in **MOTION EYE** camera.
- The video memory of your computer may have become insufficient for displaying images from the built-in **MOTION EYE** camera. Lowering the resolution or reducing the colors of the LCD screen might help.
- The viewer window may show some noise, for example horizontal streaks, if you view a rapid-moving object. This is normal and does not indicate a malfunction.
- If the problem persists, restart your computer.

Why are captured images poor in quality?

- The images captured under the fluorescent lamp may show reflection of the light.
- A dark portion in captured images may appear as a noise.
- If the lens protection cover is dirty, you cannot take a clear shot. Clean the cover. See **On Using the Built-in MOTION EYE Camera (page 134)**.

Why do captured images contain dropped frames and audio interruptions?

- The effect settings on your software application may have caused dropped frames. See the help file on your software application for more information.
- There may be more software applications running than your computer can handle. Exit the applications that you are not currently using.
- The power management function of your computer may have been activated. Check the CPU performance.

Why does movie playback show dropped frames when my computer is running on the battery?

The battery pack is running out of power. Connect your computer to an AC power source.

Why do the images captured by the built-in MOTION EYE camera flicker?

This problem occurs when you use the camera under fluorescent lights due to the mismatch between lighting output frequency and shutter speed.

To reduce flicker noise, change the pointing direction of the camera or the brightness of camera images. In some software applications, you can set an appropriate value to one of the camera properties (e.g. **LightSource**, **Flickness**, etc.) to eliminate flicker noise.

Why is the video input from the built-in MOTION EYE camera suspended for a few seconds?

The video input may be suspended for a few seconds if:

- a shortcut key with the **Fn** key is used.
- the CPU load increases.

This is normal and does not indicate a malfunction.

Why can't I use the built-in MOTION EYE camera?

- ❑ The built-in **MOTION EYE** camera cannot be shared by more than one software application. If another software application is using the camera, exit the application before using the built-in **MOTION EYE** camera.
- ❑ If the problem persists, you must reinstall the driver software for the camera. Follow these steps:
 - 1 Click **Start, Control Panel, Hardware and Sound**, and **Device Manager**.
 - 2 Double-click **Imaging devices**.
 - 3 Right-click the device name for your camera and click **Update Driver Software**.

What should I do if my computer becomes unstable when it enters a power saving mode while the built-in MOTION EYE camera is in use?

- ❑ Do not place your computer into Sleep or Hibernate mode while you are using the built-in **MOTION EYE** camera.
- ❑ If your computer automatically enters Sleep or Hibernate mode, change the corresponding power saving mode setting. For changing the setting, see **Using the Power Saving Modes (page 117)**.

What should I do if I cannot successfully capture videos in the WMV format with the built-in MOTION EYE camera?

Change the record format to the MPEG-1 format. Alternatively, click **Start, All Programs, VAIO Camera Capture Utility**, and **VAIO Camera Capture Utility** to start **VAIO Camera Capture Utility**. Click the **Camera** button to display the **Properties** window and cancel the **Low Light** check box.

Internet

What should I do if my modem does not work?

- Make sure the telephone cable is securely plugged into the modem port on your computer and the wall jack.
- Make sure the telephone cable is working. Plug the cable into an ordinary telephone and listen for a dial tone.
- Make sure that the telephone number the program is dialing is correct.
- Make sure the software you are using is compatible with your computer's modem. (All preinstalled Sony programs are compatible.)
- Make sure the modem is the only device connected to your telephone line.
- Follow these steps to check the settings:
 - 1 Click **Start** and **Control Panel**.
 - 2 Click **Hardware and Sound**.
 - 3 Click **Phone and Modem Options**.
 - 4 On the **Modems** tab, check that your modem is listed.
 - 5 On the **Dialing Rules** tab, check the location information is correct.

Why is my modem connection slow?

Your computer is equipped with a V.92/ V.90 compatible modem. Many factors may influence modem connection speed, including telephone line noise or compatibility with telephone equipment, such as fax machines or other modems. If you think your modem is not connecting properly to other PC-based modems, fax machines, or your Internet Service Provider (ISP), do any of the following:

- Ask your telephone company to verify your telephone line is free of any line noise.
- If your problem is fax-related, make sure there are no problems with the fax machine you are calling and that it is compatible with fax modems.
- If you are having a problem connecting with your ISP, make sure the ISP is not experiencing technical problems.
- If you have a second telephone line, try connecting the modem to that line.

Networking

What should I do if my computer cannot connect to a wireless LAN access point?

- Connection availability is affected by distance and obstructions. You may need to move your computer away from obstructions or closer to any access point you may be using.
- Make sure the **WIRELESS** or **WIRELESS LAN** switch is on and the Wireless LAN indicator is lit on your computer.
- Make sure power to the access point is on.
- Follow these steps to check the settings:
 - 1 Click **Start** and **Control Panel**.
 - 2 Click **View network status and tasks** under **Network and Internet**.
 - 3 Click **Connect to a network** to confirm that your access point is selected.
- Make sure the encryption key is correct.
- Make sure **Maximum Performance** is selected for **Wireless Adapter Settings** in the **Power Options** window. Selecting any other option may result in a communication failure. To change the settings, follow these steps:
 - 1 Right-click the power status icon on the taskbar and select **Power Options**.
 - 2 Click **Change plan settings** under the current power plan.
 - 3 Click **Change advanced power settings**.
The **Power Options** window appears.
 - 4 Select the **Advanced settings** tab.
 - 5 Double-click **Wireless Adapter Settings** and **Power Saving Mode**.
 - 6 Select **Maximum Performance** from the drop-down list both for **On battery** and **Plugged in**.

What should I do if I cannot access the Internet?

- ❑ Check the access point settings. See the manual that came with your access point for more information.
- ❑ Make sure your computer and the access point are connected to one another.
- ❑ Move your computer away from obstructions or closer to any access point you may be using.
- ❑ Make sure your computer is properly configured for Internet access.
- ❑ Make sure **Maximum Performance** is selected for **Wireless Adapter Settings** in the **Power Options** window. Selecting any other option may result in a communication failure. Follow the steps in **What should I do if my computer cannot connect to a wireless LAN access point? (page 160)** to change the settings.

Why is the data transfer speed slow?

- ❑ The wireless LAN data transfer speed is affected by distance and obstructions between devices and access points. Other factors include device configurations, radio conditions, and software compatibility. To maximize the data transfer speed, move your computer away from obstructions or closer to any access point you may be using.
- ❑ If you are using a wireless LAN access point, the device may be temporarily overloaded depending on how many other devices are communicating via the access point.
- ❑ If your access point interferes with other access points, change the access point channel. See the manual that came with your access point for more information.
- ❑ Make sure **Maximum Performance** is selected for **Wireless Adapter Settings** in the **Power Options** window. Selecting any other option may result in a communication failure. Follow the steps in **What should I do if my computer cannot connect to a wireless LAN access point? (page 160)** to change the settings.

How do I avoid data transfer interruptions?

- ❑ When your computer is connected to an access point, data transfer interruptions may occur when using large files or if the computer is in close proximity to microwaves and cordless telephones.
- ❑ Move your computer closer to the access point.
- ❑ Make sure the access point connection is intact.
- ❑ Change the access point channel. See the manual that came with your access point for more information.
- ❑ Make sure **Maximum Performance** is selected for **Wireless Adapter Settings** in the **Power Options** window. Selecting any other option may result in a communication failure. Follow the steps in **What should I do if my computer cannot connect to a wireless LAN access point? (page 160)** to change the settings.

What are channels?

- ❑ Wireless LAN communication occurs on divided frequency bands known as channels. Third-party wireless LAN access point channels may be preset to different channels from Sony devices.
- ❑ If you are using a wireless LAN access point, see connectivity information contained in the manual that came with your access point.

Why does the network connection stop when I change the encryption key?

Two computers with the wireless LAN functionality may lose a peer-to-peer network connection if the encryption key is changed. You can either change the encryption key back to the original profile or re-enter the key on both computers so the key matches.

Bluetooth Technology

What should I do if other Bluetooth devices cannot discover my computer?

- Make sure both devices have the Bluetooth functionality enabled.
- If the Bluetooth indicator is off, turn on the **WIRELESS** switch.
- You cannot use the Bluetooth functionality when your computer is in a power saving mode. Return to Normal mode, then turn on the **WIRELESS** switch.
- Your computer and the device may be too far apart. Wireless Bluetooth technology works best when the devices are within 33 feet (10 meters) of each other.

Why can't my computer discover other Bluetooth devices?

If the connected device is also connected to other devices, it may not appear on the **Devices** tab in the **Bluetooth Devices** window or you may not be able to communicate with the device.

What should I do if I cannot find the Bluetooth device with which I want to communicate?

- Check that the Bluetooth functionality of the device with which you want to communicate is on. See the other device's manual for more information.
- If the device with which you want to communicate is already communicating with another Bluetooth device, it may not be found or it may not be able to communicate with your computer.
- To allow other Bluetooth devices to communicate with your computer, click **Start, Control Panel, Hardware and Sound, Bluetooth Devices**, and the **Options** tab and select the **Allow Bluetooth devices to connect to this computer** check box.

What should I do if other Bluetooth devices cannot connect to my computer?

- ❑ Make sure the other device is authenticated.
- ❑ To allow other Bluetooth devices to communicate with your computer, click **Start, Control Panel, Hardware and Sound, Bluetooth Devices**, and the **Options** tab and select the **Allow Bluetooth devices to connect to this computer** check box.
- ❑ The data transfer distance can be shorter than 33 feet (10 meters) depending on existing obstacles between the two devices, on radio wave quality, and on the operating system or the software in use. Move your computer and Bluetooth devices closer to each other.
- ❑ If the device with which you want to communicate is already communicating with another Bluetooth device, it may not be found or it may not be able to communicate with your computer.
- ❑ Check that the Bluetooth functionality of the device with which you want to communicate is on. See the other device's manual for more information.

Why is my Bluetooth connection slow?

- ❑ The data transfer speed depends on the obstacles and/or the distance between the two devices, on the radio wave quality, and on the operating system or the software in use. Move your computer and Bluetooth devices closer to each other.
- ❑ The 2.4 GHz radio frequency used by Bluetooth and wireless LAN devices is also used by other devices. Bluetooth devices incorporate technology that minimizes interference from other devices using the same wavelength, however, communication speed and connection range may be reduced. Interference from other devices may also stop communication altogether.
- ❑ Connection availability is affected by distance and obstructions. You may need to move your computer away from obstructions or closer to the device to which it is connected.
- ❑ Identify and remove obstacles between your computer and the device to which it is connected.
- ❑ Note that due to limitations of the Bluetooth standard, large files may occasionally be corrupted during continuous transfer due to electromagnetic interference from the environment.

What should I do if my computer becomes unstable when I use a Bluetooth audio device?

Your computer may become unstable if you change a sound output device to a Bluetooth audio device while audio or video playback software is running.

When you listen to playback audio from your Bluetooth audio device, connect the Bluetooth audio device to the computer first and then launch your audio or video playback software.

See the help file for detailed information on connecting the Bluetooth audio device.

Why can't I connect to service supported by the target Bluetooth device?

Connection is only possible for services also supported by the computer with the Bluetooth functionality. For more details, search for Bluetooth information using **Windows Help and Support**. To open **Windows Help and Support**, click **Start** and **Help and Support**.

Can I use a device with Bluetooth technology on airplanes?

With Bluetooth technology, your computer transmits a radio frequency of 2.4 GHz. Sensitive locations, such as hospitals and airplanes, may have restrictions on use of Bluetooth devices, due to radio interference. Check with facility staff to see if use of the Bluetooth functionality on the computer is permitted.

Why can't I use the Bluetooth functionality when I log onto my computer as a user with a standard user account?

The Bluetooth functionality may not be available to a user with a standard user account on your computer. Log onto the computer as a user with administrator rights.

Why can't I connect to a Bluetooth device in Personal Area Network User mode?

If the device to which you want to connect does not support Bluetooth communication in Personal Area Network User mode, you cannot establish a connection from your computer.

Why can't I use the Bluetooth devices when I switch a user?

If you switch a user without logging off your system, the Bluetooth devices will not work successfully. Be sure to log off before switching a user. To log off your system, click **Start**, the arrow next to the **Lock** button, and **Log Off**.

Why can't I exchange business card data with a cellular phone?

The business card exchange function is not supported.

Optical Discs

Why does my computer freeze when I try to read a disc?

The disc that your computer is trying to read may be dirty or damaged. Follow these steps:

- 1 Press the **Ctrl+Alt+Delete** keys and click the arrow next to the **Shut down** button and **Restart** to restart the computer.
- 2 Remove the disc from the optical disc drive.
- 3 Check the disc for dirt or damage. If you need to clean the disc, see **On Handling Discs (page 136)** for instructions.

What should I do if the drive tray does not open?

- Make sure your computer is on.
- If power supply to the optical disc drive is disabled by **VAIO Power Management**, the substitute drive eject button on the optical disc drive will not work. Use the disc drive eject button located to the upper left of the keyboard. Note that it will take a while to eject the drive tray if the optical disc drive is not powered.
- If the drive eject button does not work, click **Start** and **Computer**. Right-click the optical disc drive icon and select **Eject**.
- If none of the above options work, insert a thin, straight object (such as a paper clip) in the manual eject hole near the substitute drive eject button.
- Try restarting your computer.

What should I do if I cannot play a disc properly on my computer?

- ❑ Make sure the disc is inserted into the optical disc drive with the label facing upward.
- ❑ Make sure the necessary program(s) is installed according to the manufacturer's instructions.
- ❑ If a disc is dirty or damaged, your computer will stop responding. Follow these steps:
 - 1 Press the **Ctrl+Alt+Delete** keys and click the arrow next to the **Shut down** button and **Restart** to restart the computer.
 - 2 Remove the disc from the optical disc drive.
 - 3 Check the disc for dirt or damage. If you need to clean the disc, see **On Handling Discs (page 136)** for instructions.
- ❑ If you are playing a disc and cannot hear sound, do any of the following:
 - ❑ Check if the volume is turned off by the muting button.
 - ❑ Right-click the volume icon on the taskbar and click **Open Volume Mixer** to check the settings.
 - ❑ Check the volume setting in the audio mixer.
 - ❑ If you are using external speakers, check the volume settings on the speakers and the connections between the speakers and your computer.
 - ❑ Make sure the correct driver software is installed. Follow these steps:
 - 1 Click **Start** and **Control Panel**.
 - 2 Click **System and Maintenance**.
 - 3 Click **System**.
 - 4 Click **Device Manager** on the left pane.

The **Device Manager** window appears with a listing of your computer's hardware devices. If an "X" or an exclamation point appears on the listed device, you may need to enable the device or reinstall the drivers.
 - 5 Double-click the optical disc drive device to open a list of the optical disc drives of your computer.

6 Double-click the desired drive.

You can confirm the driver software by selecting the **Driver** tab, and clicking **Driver Details**.

7 Click **OK** to close the window.

- Make sure an adhesive label is not affixed to a disc. Adhesive labels can come off while the disc is in the optical disc drive and damage the drive or cause it to malfunction.
- If a region code warning appears, the disc may be incompatible with the optical disc drive. Check the DVD package to make sure the region code is compatible with the optical disc drive.
- If you notice condensation on your computer, do not use the computer for at least one hour. Condensation can cause the computer to malfunction.
- Make sure your computer is running on AC power supply and try the disc again.

What should I do if I cannot write data to CD media?

- ❑ Make sure you neither launch any software application nor allow any to launch automatically, not even a screen saver.
- ❑ Stop using the keyboard.
- ❑ If you are using a CD-R/RW disc with an adhesive label affixed, replace it with one with no affixed adhesive label. Using a disc with an affixed adhesive label could cause a write error or other damage.

What should I do if I cannot write data to DVD media?

- ❑ Make sure you are using the correct DVD recordable media.
- ❑ Check which DVD recordable format is compatible with your optical disc drive. Note the possibility that some brands of DVD recordable media do not work.
- ❑ The preinstalled software on your computer does not support copying DVD movies. Macrovision or a similar video protection technology prevents users from copying DVD movies. Copying a DVD movie would be a copyright infringement and therefore illegal.

Why can't I write data to Blu-ray Disc media?

! This Q & A entry applies to selected models only. See the online **Specifications** to find the type of your optical disc drive, and then **Reading and Writing Optical Discs (page 36)** to find about the supported disc media.

- ❑ Make sure your optical disc drive supports the Blu-ray Disc writing function. The CD-RW/DVD-ROM, DVD-ROM, and DVD±RW/±R DL/RAM drives do not support it.
- ❑ BD-R Disc media are not rewritable. You cannot add or erase data to or from the BD-R Disc media.

Display

Why did my screen go blank?

- ❑ Your computer screen may go blank if the computer loses power or enters a power saving mode (Sleep or Hibernate). If the computer is in LCD (Video) Sleep mode, press any key to bring the computer back into Normal mode. See **Using the Power Saving Modes (page 117)** for more information.
- ❑ Make sure your computer is securely plugged into a power source and turned on. Make sure the power indicator shows the power is on.
- ❑ If your computer is using battery power, make sure the battery pack is installed properly and is charged. See **Using the Battery Pack (page 23)** for more information.
- ❑ If the display mode is set to the external display, press the **Fn+F7** keys. See **Combinations and Functions with the Fn Key (page 29)** for more information.

Why can't I view the whole screen image of a DVD video on my TV screen?

The screen resolution may not be properly set. We recommend that you adjust the screen resolution to 1024 x 768 or smaller, depending on the size of your external display screen.

How do I adjust the image on my TV screen?

Use the controls on your external display to adjust the image. See the manual that came with your TV for more information.

How do I change the screen resolution on my TV screen?

Your TV screen may not show the whole screen image of a video if the screen resolution is set larger than 1024 x 768. Adjust the screen resolution to 1024 x 768 or smaller.

To change the screen resolution, follow these steps:

- 1 Right-click the desktop and select **Personalize**.
- 2 Click **Display Settings**.
The **Display Settings** window appears.
- 3 Move the slider under **Resolution** to the left to reduce or to the right to increase the screen resolution.

How do I switch the display output from my screen to TV?

See **Selecting Display Modes (page 101)**.

Alternatively, you can press the **Fn+F7** keys to view the image either on your computer screen or on your TV. See **Combinations and Functions with the Fn Key (page 29)** for more information.

Why doesn't my screen display a video?

- ❑ If the external display is selected for the display output and the external display is disconnected, you cannot display a video on your computer screen. Stop video playback, change the display output to the computer screen, and then restart video playback. See **Selecting Display Modes (page 101)**. Alternatively, you can press the **Fn+F7** keys to change the display output. See **Combinations and Functions with the Fn Key (page 29)** for more information.
- ❑ The video memory of your computer may be insufficient for displaying high resolution videos. In this case, lower the resolution of the LCD screen.

To change the screen resolution, follow these steps:

- 1 Right-click the desktop and select **Personalize**.
- 2 Click **Display Settings**.
The **Display Settings** window appears.
- 3 Move the slider under **Resolution** to the left to reduce or to the right to increase the screen resolution.



You can confirm the value of the total available graphics memory and video memory. Right-click on the desktop, select **Personalize**, and click **Display Settings, Advanced Settings**, and the **Adaptor** tab. The value may be displayed differently from the actual memory on your computer.

What should I do if my screen is dark?

Press the **Fn+F6** keys to brighten your computer screen.

What should I do if the LCD brightness of my screen changes?

The LCD brightness setting, adjusted with the **Fn+F5/F6** keys, is temporary and may be restored to the original setting when your computer returns to Normal mode from Sleep or Hibernate mode. To save your preference for the brightness, follow these steps:

- 1 Right-click the power status icon on the taskbar and select **Power Options**.
- 2 Click **Change plan settings** under the current power plan.
- 3 Click **Change advanced power settings**.
The **Power Options** window appears.
- 4 Select the **Advanced settings** tab.
- 5 Double-click **Display**.
- 6 Adjust the LCD brightness setting in the item for brightness adjustment.

What should I do if the external display stays blank?

If you cannot change the display output with the **Fn+F7** keys, you need to change the settings for the external display with **VAIO Control Center**. To change the settings, launch the **VAIO Control Center**, select the control item for the external display, and then click to select the check box for changing the options to detect the external display. Then, try the **Fn+F7** keys to change the display output.

How do I run Windows Aero?

! This Q & A entry applies to selected models only.

To run Windows Aero, follow these steps:

- 1 Click **Start** and **Control Panel**.
- 2 Click **Customize colors** under **Appearance and Personalization**.
- 3 Click **Open classic appearance properties for more color options**.
The **Appearance Settings** window appears.
- 4 Select **Windows Aero** from the **Color scheme** options on the **Appearance** tab.
- 5 Click **OK**.

For information about the Windows Aero features, such as Windows Flip 3D, see **Windows Help and Support**.

Printing

What should I do if I cannot print a document?

- ❑ Make sure your printer is on, and the printer cable is securely connected to the ports on the printer and computer.
- ❑ Make sure your printer is compatible with the Windows operating system installed on your computer.
- ❑ You may need to install the printer driver software before you use your printer. See the manual that came with your printer for more information.
- ❑ If your printer is not functioning after your computer resumes from a power saving mode (Sleep or Hibernate), then restart the computer.
- ❑ If the bidirectional communication functions are provided with your printer, disabling the functions on your computer may enable printing. Follow these steps:
 - 1 Click **Start** and **Control Panel**.
 - 2 Click **Printer** under **Hardware and Sound**.
 - 3 Right-click the printer icon and select **Properties**.
 - 4 Click the **Ports** tab.
 - 5 Click to cancel the **Enable bidirectional support** check box.
 - 6 Click **OK**.

This change to the settings disables the bidirectional communication functions of the printer, such as data transfer, status monitoring, and remote panel.

Microphone

What should I do if my microphone does not work?

- ❑ If you are using an external microphone, make sure the microphone is turned on and is properly plugged into the microphone jack on your computer.
- ❑ Your sound input device may have been incorrectly configured. To configure the sound input device, follow these steps:
 - 1 Close all open programs.
 - 2 Click **Start** and **Control Panel**.
 - 3 Click **Hardware and Sound**.
 - 4 Click **Manage audio devices** under **Sound**.
 - 5 On the **Recording** tab, select the desired device for sound input and click **Set Default**.

How can I prevent microphone feedback?

Microphone feedback occurs when the microphone receives the sound from a sound output device, such as a speaker.

To prevent this problem:

- ❑ Keep the microphone away from a sound output device.
- ❑ Turn down the volume of the speakers and the microphone.

Mouse

What should I do if my computer does not recognize my mouse?

- Make sure your mouse is securely plugged into the port.
- Restart your computer with your mouse connected.

What should I do if the pointer does not move when I use my mouse?

- Make sure another mouse is not connected.
- If the pointer does not move while a software application is running, press the **Alt+F4** keys to close the application window.
- If the **Alt+F4** keys do not work, click **Start**, the arrow next to the **Lock** button, and **Restart** to restart your computer.
- If your computer does not restart, press the **Ctrl+Alt+Delete** keys and click the arrow next to the **Shut down** button and **Restart**.
If the **Windows Security** window appears, click **Restart**.
- If this procedure does not work, press and hold the power button until the computer turns off.



Turning off your computer with the power button may cause loss of unsaved data.

Speakers

What should I do if my external speakers do not work?

- ❑ If you are using a program that has its own volume control, make sure the volume control is properly set. See the program's help file for more information.
- ❑ Make sure your speakers are properly connected and the volume is turned up loud enough to hear sound.
- ❑ Make sure your speakers are designed for computer use.
- ❑ If your speakers have a muting button, set the button to off.
- ❑ The volume may have been turned off by the muting button. Press the button once again.
- ❑ The volume may have been minimized by the volume (-) button. Press the volume (+) button to turn up the volume loud enough to hear sound.
- ❑ If your speakers require external power, make sure the speakers are connected to a power source. See the manual that came with your speakers for more information.
- ❑ Check the Windows volume controls by clicking the volume icon on the taskbar.
- ❑ Your sound output device may have been incorrectly configured. To configure the sound output device, follow these steps:
 - 1 Close all open programs.
 - 2 Click **Start** and **Control Panel**.
 - 3 Click **Hardware and Sound**.
 - 4 Click **Manage audio devices** under **Sound**.
 - 5 On the **Playback** tab, select the desired device for sound output and click **Set Default**.

What should I do if I do not hear sound from the built-in speakers?

- ❑ If you are using a program that has its own volume control, make sure the volume control is properly set. See the program's help file for more information.
- ❑ Make sure the speaker volume is turned up loud enough and the audio option is enabled.
- ❑ The volume may have been turned off by the muting button. Press the button once again.
- ❑ The volume may have been minimized by the volume (-) button. Press the volume (+) button to turn up the volume loud enough to hear sound.
- ❑ Check the Windows volume controls by clicking the volume icon on the taskbar.
- ❑ Your sound output device may have been incorrectly configured. To configure the sound output device, follow the steps in **What should I do if my external speakers do not work?** ([page 179](#)).

What should I do if I do not hear microphone sound from my HDMI-compatible TV?

Your computer is not capable of outputting audio signals from the microphone jack directly through the **HDMI** port. Save the audio data first to an audio file, and then play it back to output through the **HDMI** port.

Touch Pad

What should I do if the touch pad does not work?

- ❑ You may have disabled the touch pad without connecting a mouse to your computer.
- ❑ Make sure that a mouse is not connected to your computer.
- ❑ If the pointer does not move while a software application is running, press the **Alt+F4** keys to close the application window.
- ❑ If the **Alt+F4** keys do not work, click **Start**, the arrow next to the **Lock** button, and **Restart** to restart your computer.
- ❑ If your computer does not restart, press the **Ctrl+Alt+Delete** keys and click the arrow next to the **Shut down** button and **Restart**.
If the **Windows Security** window appears, click **Restart**.
- ❑ If this procedure does not work, press and hold the power button until the computer turns off.

!
Turning off your computer with the power button may cause loss of unsaved data.

Keyboard

What should I do if the keyboard configuration is wrong?

The language layout of your computer's keyboard is labeled on the packaging box. If you choose a different regional keyboard when you complete the Windows setup, the key configuration will be mismatched.

To change the keyboard configuration, follow these steps:

- 1 Click **Start** and **Control Panel**
- 2 Click **Clock, Language, and Region**, and click **Regional and Language Options**.
- 3 Change the settings as desired.

What should I do if I cannot enter certain characters with the keyboard?

If you cannot enter **U, I, O, P, J, K, L, M**, and so on, the **Num Lk** key may be activated. Check that the Num lock indicator is off. If the Num lock indicator is on, press the **Num Lk** key to turn it off before entering these characters.

Floppy Disks

Why doesn't the Safely Remove Hardware icon appear on the taskbar when the drive is connected?

Your computer does not recognize the floppy disk drive. First, make sure the USB cable is properly connected to the USB port. If you need to secure the connection, wait a few moments for the computer to recognize the drive. If the icon still does not appear, follow these steps:

- 1 Close all programs that are accessing the floppy disk drive.
- 2 Wait for the LED indicator on the floppy disk drive to turn off.
- 3 Push the eject button to remove the disk, and disconnect the USB floppy disk drive from your computer.
- 4 Reconnect the floppy disk drive by inserting the USB connector into the USB port.
- 5 Restart the computer by clicking **Start**, the arrow next to the **Lock** button, and **Restart**.

What should I do if I cannot write data to a floppy disk?

- Make sure the floppy disk is properly inserted in the drive.
- If the disk is inserted properly and you are still unable to write data to it, the disk may be full or write-protected. You can either use a floppy disk that is not write-protected or disable the write-protect feature.

PC Cards

What should I do if my PC Card does not work?

- ❑ Make sure the PC Card is inserted properly. See **Inserting a PC Card (page 62)** for more information.
- ❑ Make sure the PC Card is compatible with the Microsoft Windows operating system installed on your computer.
- ❑ See the manual that came with your PC Card for more information. You may need to install driver software if you are not using a Sony PC Card.
- ❑ If your PC Card, which worked normally before, does not work, you may need to install the most recent driver software. Follow these steps:
 - 1 Click **Start** and **Control Panel**.
 - 2 Click **System and Maintenance**.
 - 3 Click **System**.
 - 4 Click **Device Manager** on the left pane.
The **Device Manager** window appears.
 - 5 Double-click the device name for the PC Card to display the properties window.
 - 6 Select the **Driver** tab and click **Update Driver**.

Why doesn't my computer recognize attached devices?

For some PC Cards, if you alternate between Normal mode and Sleep or Hibernate mode while the card is inserted into the **PC Card** slot, your computer may not recognize the PC Card or the connected device. Restart the computer.

Why can't I insert my PC Card?

- Make sure you are inserting the card correctly. See **Inserting a PC Card (page 62)** for more information.
- You may not be able to use some PC Cards or some functions of the PC Card on your computer. See the manual that came with your PC Card for more information.

Audio/Video

What should I do if I cannot use my DV camcorder?

If it is prompted that the i.LINK device seems to be disconnected or turned off, the i.LINK cable may not be securely plugged into the port on your computer or camcorder. Unplug the cable, and plug it in once again. See **Connecting an i.LINK Device (page 109)** for more information.



i.LINK is a trademark of Sony used only to designate that a product contains an IEEE 1394 connection. The procedure to establish an i.LINK connection may vary, depending on a software application, an operating system, and a compatible i.LINK device. Not all products with an i.LINK connection can communicate with each other. See the manual that came with your compatible i.LINK device for more information on operating conditions and proper connection. Before connecting compatible i.LINK PC peripherals to your system, such as a CD-RW or hard disk drive, confirm their operating system compatibility and required operating conditions.

How do I turn off the Windows startup sound?

To turn off the Windows startup sound, follow these steps:

- 1 Click **Start** and **Control Panel**.
- 2 Click **Hardware and Sound**.
- 3 Click **Manage audio devices** under **Sound**.
- 4 On the **Sounds** tab, click to cancel the **Play Windows Startup sound** check box.
- 5 Click **OK**.

What should I do if I do not hear the sound from the sound output device connected to the HDMI port?

- ❑ Once you have connected a device to the **HDMI** port, you need to change the device for sound output if you want to hear sound from the device.

To change the sound output device, follow these steps:

- 1 Close all open programs.
 - 2 Click **Start** and **Control Panel**.
 - 3 Click **Hardware and Sound**.
 - 4 Click **Manage audio devices** under **Sound**.
 - 5 On the **Playback** tab, select the desired device for sound output and click **Set Default**.
- ❑ If you still hear no sound from the sound output device, follow these steps:
 - 1 Follow steps 1 to 4 above.
 - 2 On the **Playback** tab, select the HDMI icon and click **Properties**.
 - 3 Click the **Advanced** tab.
 - 4 Select the sample rate and bit depth (for example, 48000 Hz, 16 bit) which the device supports.
 - 5 Click **OK**.

How do I output the Dolby Digital or DTS sound through an S/PDIF or HDMI-compatible device?

To output the Dolby Digital or DTS sound from a disc through an S/PDIF or HDMI-compatible device connected to your computer, follow these steps:

- 1 Click **Start** and **Control Panel**.
- 2 Click **Hardware and Sound**.
- 3 Click **Manage audio devices** under **Sound**.
- 4 On the **Playback** tab, select the optical out or HDMI icon and click **Properties**.
- 5 Click the **Supported Formats** tab.
- 6 Click to select the **DTS audio** and **Dolby Digital** check boxes.
- 7 Click **OK**.

! If the Dolby Digital or DTS sound is output to a device that does not support it, the device will not play any sound. In such a case, cancel the **DTS audio** and **Dolby Digital** check boxes.

Memory Stick Media

What should I do if I cannot use Memory Stick media, which were formatted on a VAIO computer, on other devices?

You may need to reformat your Memory Stick media.

Formatting Memory Stick media erases all data, including music data previously saved on it. Before you reformat Memory Stick media, back up important data and confirm that the media does not contain files you want to keep.

- 1 Copy the data from the Memory Stick media onto your hard disk drive to save data or images.
- 2 Format the Memory Stick media by following the steps in **To format a Memory Stick media (page 72)**.

Why can't I save music files onto my Memory Stick media?

Copyright protected music cannot be checked out to any Memory Stick media other than those with the MagicGate logo.

! Use of recorded music requires permission from the copyright holders.

Sony is not responsible for music files that cannot be recorded from a CD or downloaded from other sources.

Can I copy images from a digital camera using Memory Stick media?

Yes, and you can view video clips that you have recorded with Memory Stick media-compatible digital cameras.

Why can't I write data to Memory Stick media?

Some versions of Memory Stick media are equipped with an erasure prevention switch to protect data from accidental erasure or overwriting. Make sure the erasure prevention switch is off.

Peripherals

What should I do if I cannot connect a USB device?

- ❑ If applicable, check the USB device is turned on and using its own power supply. For example, if you are using a digital camera, check if the battery is charged. If you are using a printer, check if the power cable is connected properly to the AC outlet.
- ❑ Try using another USB port on your computer. The driver could be installed to the specific port you used the first time you connected the device.
- ❑ See the manual that came with your USB device for more information. You may need to install software before you connect the device.
- ❑ Try connecting a simple, low-powered device such as a mouse to test if the port is working at all.
- ❑ USB hubs may prevent a device from working because of the distribution of power. We recommend you connect the device directly to your computer without a hub.

Support Options

This section contains information on where to go for answers to questions about your VAIO computer and the preinstalled software.

Sony Support Information

See the following sources for answers in the sequence listed below.

1 VAIO Computer Documentation

This on-screen **User Guide** (this manual) and the printed **Welcome mat** provide information on how to maximize your computer's capabilities and solve common problems.

2 Program Guides and Help Files

The preinstalled programs on your computer may be supplied with individual help guides. These guides are stored on the hard disk drive as on-screen help files. You can find the help files from the help menu under the specific program.

3 Operating System Online Support

Your computer comes preinstalled with a Microsoft Windows operating system. For operating system support, you can visit Microsoft customer support at: <http://support.microsoft.com/directory/>.

4 Sony Computing Support

This service provides instant access to information on commonly encountered problems. Type a description of the problem and the Knowledge Database searches for the corresponding solutions online.

You can visit the Sony online support Web site at the following URLs:

<http://esupport.sony.com/EN/VAIO/> for customers in USA

<http://www.sony.ca/support> for customers in Canada

<http://esupport.sony.com/ES/VAIO/> for customers in Spanish speaking Latin American countries or areas

<http://esupport.sony.com/ES/VAIO/BR/> for customers in Brazil

5 VAIO Update

When your computer is connected to the Internet, **VAIO Update** automatically notifies you when critical software and security information is posted on the support Web site. Click the **VAIO Update** notice to open the VAIO Support Web site and view the information.

For customers in Latin American countries or areas

Customer Information Center

If you do not find the information you are looking for at our site, you may call Sony directly. In order to receive the fastest and most efficient services, have the following information readily available:

1 Your VAIO computer model

You can find it at the lower right corner of the display on the notebook, and in the same place on the front panel of the CPU on the desktop.

2 Your computer's serial number

You can find it on the back or bottom of the notebook or on the back of the desktop; the serial number is the last 7 digits of the number below the barcode.

3 The operating system on your computer

4 The hardware component or the software program that is causing you the problem

5 A brief description of the problem

In order to contact a Sony technical support representative, call the following numbers:

In Argentina:

(011) 6770-SONY (7669)

In Mexico:

In Mexico City: 5002-9819

In the Mexican Republic: 01-800-759-7669

In Colombia:

01-800-550-7000

In Peru:

0-801-1-7000 or 511-6100

In Chile:

800-261-800

From cellular phones: 02-754-6333

In Venezuela:

0-800-1-SONY-00 (0-800-1-7669-00)

In Panama:

800-2050

In Brazil:

(11) 3677-1080

Program Support Information

Depending on the computer model and particular configuration you purchased, your computer may not include all of the software programs listed below.

Contacts for Sony software products are listed below:

- For customers in USA
Web site <http://esupport.sony.com/EN/VAIO/>
Telephone 888-4-SONY-PC (888-476-6972)
- For customers in Canada
Web site <http://www.sony.ca/support>
Telephone 888-4-SONY-PC (888-476-6972)
- For customers in Spanish speaking Latin American countries or areas
Web site <http://esupport.sony.com/ES/VAIO/>
- For customers in Brazil
Web site <http://esupport.sony.com/ES/VAIO/BR/>

For contacts about third-party software products, see the following.

Adobe® Photoshop® Elements, Premiere® Elements, Reader®

Adobe Systems Inc.

- For customers in USA and Canada
Web site <http://www.adobe.com/support>
Telephone 800-685-3652

America Online® (Dial-Up)

America Online, Inc.

- For customers in USA and Canada
Web site <http://www.aol.com>

AOL® Toolbar

America Online, Inc.

- For customers in USA and Canada
Web site <http://help.aol.com/help>

AOL® Instant Messenger™

America Online, Inc.

- For customers in USA and Canada
Web site <http://www.aim.com>

Bluetooth™ Utility

TOSHIBA Corporation

For contacts about the software, see **Program Support Information** ([page 195](#)).

Bluetooth™ Utility

Broadcom Corporation

For contacts about the software, see **Program Support Information** ([page 195](#)).

Click to DVD® software

Sony Electronics Inc.

At the touch of a button, Click to DVD software allows you to automatically burn DVDs from a digital video (DV) device. Create DVDs by capturing video content straight from a DV device or by importing video from stored files — and you can also edit the video. Create DVD photo albums and slide shows with picture files or by importing pictures from a digital still camera. You can give a professional look to your DVDs by adding chapter menus, backgrounds, and menu screens. You are only a few clicks away from creating your own DVDs!

For contacts about the software, see **Program Support Information** ([page 195](#)).

DVgate Plus™ software

Sony Electronics Inc.

Connect a compatible digital video camera to your computer's i.LINK port and capture video clips and still images. Edit clips from your video, add new clips, and combine clips into new movie segments. Save your movies back to your digital video camera or in a variety of popular file formats.

For contacts about the software, see **Program Support Information** ([page 195](#)).

InstantOn

InterVideo, Inc.

- ❑ For customers in USA and Canada
Web site <http://www.intervideo.com/jsp/Support.jsp>

Intel® PROSet/Wireless Software

Intel Corporation

- ❑ For customers in USA and Canada
Web site <http://support.intel.com>

LocationFree

Sony Electronics Inc.

For contacts about the software, see **Program Support Information (page 195)**.

Microsoft® Office Basic Edition, Office Professional Edition, Office Small Business Edition, Office Ready, Office Ultimate

Microsoft Corp.

- ❑ For customers in USA and Canada
Web site <http://support.microsoft.com>

60-Day Trial Version of Microsoft® Office

!

The Microsoft Office 60-Day Trial software included with this computer system is intended for evaluation purposes only. The software has been installed and you must activate the software before you can use it. Product activation procedures will be detailed during initial launch of the software; activation requires Internet access. This software has an expiration date of 60 days from the date of first use, at which time the software will operate under reduced-functionality mode, limiting end-user options and operations.

Microsoft Corp.

- For customers in USA and Canada
Web site <http://support.microsoft.com>

Microsoft® Internet Explorer, Movie Maker, Media Player, Works

Microsoft Corp.

- For customers in USA and Canada
Web site <http://support.microsoft.com>

Microsoft® Streets & Trips

Microsoft Corp.

A comprehensive trip planning software.

- For customers in USA and Canada
Web site <http://support.microsoft.com>

14-Day Trial Version of Napster®

Napster, Inc.

- For customers in USA and Canada
Web site <http://www.napster.com>

Norton Internet Security™

Symantec Corporation

- For customers in USA and Canada
Web site <http://www.symantec.com/techsupp>

Protector Suite QL

Sony Electronics Inc.

Protector Suite QL Edition allows you to easily setup your fingerprint sensor equipped on your computer. Protector Suite QL supports fingerprint logon, fast user switching, file encryption, registering forms and more. For contacts about the software, see **Program Support Information (page 195)**.

QuickBooks Free Starter Edition

Intuit Inc.

- For customers in USA and Canada
Web site <http://www.intuit.com/support/>

QuickBooks Deluxe

Intuit Inc.

- ❑ For customers in USA and Canada
Web site <http://www.intuit.com/support/>

Roxio® Easy Media Creator® 9 Suite

Sonic Solutions

- ❑ For customers in USA and Canada
Web site <http://support.sonic.com/>

SafeIT-Digital Document Shredder

SafeIT Security Ltd.

- ❑ For customers in USA and Canada
Web site <http://www.safeit.com/support>

SmartWi™ Connection Utility

Sony Electronics Inc.

SmartWi Connection Utility allows you to easily switch between the various wireless components (Wireless LAN, Wireless WAN, and Bluetooth™ technology connectivity) that came with your computer.

For contacts about the software, see **Program Support Information (page 195)**.

SonicStage Mastering Studio™ software

Sony Electronics Inc.

Use SonicStage Mastering Studio software to record songs from analog records or cassette tapes into your computer and output them to CDs, DVDs, or audio files in WAV format.

For contacts about the software, see **Program Support Information** ([page 195](#)).

VAIO® Camera Capture Utility

Sony Electronics Inc.

VAIO Camera Capture Utility is provided for capturing still images and movies with the external camera connected to a USB port or an i.LINK® port on your computer or with the built-in **MOTION EYE®** camera on your computer.

For contacts about the software, see **Program Support Information** ([page 195](#)).

VAIO® Camera Utility

Sony Electronics Inc.

VAIO Camera Utility provides you with various video quality settings when using the internal camera.

For contacts about the software, see **Program Support Information** ([page 195](#)).

VAIO® Hardware Diagnostic

Sony Electronics Inc.

For contacts about the software, see **Program Support Information** ([page 195](#)).

VAIO® Edit Component

Sony Electronics Inc.

VAIO Edit Component provides enhanced editing functionality when using Adobe Premiere Pro or Adobe Premiere Elements on your VAIO computer.

For contacts about the software, see **Program Support Information** ([page 195](#)).

VAIO® HDD Protection

Sony Electronics Inc.

VAIO HDD Protection allows you to customize your settings for protecting your hard disk drive against shock hazards.

For contacts about the software, see **Program Support Information** ([page 195](#)).

VAIO® LAN Setting Utility

Sony Electronics Inc.

For contacts about the software, see **Program Support Information** ([page 195](#)).

VAIO Launcher

Sony Electronics Inc.

For contacts about the software, see **Program Support Information** ([page 195](#)).

VAIO Media™ software

Sony Electronics Inc.

VAIO Media™ software brings multimedia to your network, enabling you to share music, video, and still image files between your VAIO® computers. You can set up one or more VAIO computers as "media servers," which store your multimedia files and make them available to other compatible VAIO computers on your wired or wireless network. For contacts about the software, see **Program Support Information (page 195)**.

VAIO® Security Center

Sony Electronics Inc.

Sony cares about your VAIO personal computer. The VAIO Security Center highlights some of the security features your machine includes.

For contacts about the software, see **Program Support Information (page 195)**.

VAIO Smart Network

Sony Electronics Inc.

For contacts about the software, see **Program Support Information (page 195)**.

VAIO® Touch Launcher

Sony Electronics Inc.

VAIO Touch Launcher allows you to run an application program or change the sound/display settings with the buttons on the launcher window.

For contacts about the software, see **Program Support Information (page 195)**.

VAIO Update 3

Sony Electronics Inc.

The VAIO Update utility helps you keep your VAIO® computer up to date by regularly checking the Sony online support Web site for important software updates and information for your specific VAIO computer model.

For contacts about the software, see **Program Support Information (page 195)**.

VAIO Video & Photo Suite

Sony Electronics Inc.

VAIO Content Importer and VAIO Content Exporter are included in this utility software. This software enables you to import and export your media files to or from a DVD, digital still camera, or camcorder.

For contacts about the software, see **Program Support Information (page 195)**.

VAIO® Wireless Switch Setting Utility

Sony Electronics Inc.

For contacts about the software, see **Program Support Information (page 195)**.

WinDVD® software for VAIO® computers

InterVideo, Inc.

- ❑ For customers in USA and Canada
Web site <http://www.intervideo.com/jsp/Support.jsp>
Telephone 510-651-0888

Xdrive™

America Online, Inc.

- For customers in USA and Canada
Web site <http://www.xdrive.com/support>

Zoom Utility

Sony Electronics Inc.

The Zoom Utility will allow you to magnify a portion of the screen.

For contacts about the software, see **Program Support Information (page 195)**.

