

SONY

***VAIO® Computer
Quick Start***

PCG-GRX600 Series

Contents

Notice to Users	5
Setting Up	15
Unpacking Your Computer	16
Applying Ergonomics	18
Locating Controls and Ports	19
Getting Started	25
Turning On Your Computer	26
Using the Touch Pad	29
Registering Your Computer	30
Locating Your VAIO Computer User Guide	31
Setting Up A Dial-Up Connection	33
Turning Off Your Computer	35
Expanding Your Computing Power	37
Upgrading Memory	38
Locating Preinstalled Programs	38
Using the Recovery CDs.....	39
Application and System Recovery CDs	40
Using Your Recovery CDs.....	40

Troubleshooting.....45
 Troubleshooting Your Computer 46
 Troubleshooting the LCD Screen 49
 Troubleshooting the Mouse and Touch Pad 50
 Support Options 53
 Program Support Information..... 54

Caring for Your Computer.....57
 Storing Your Computer 58
 Using Cables and Connections 58
 Cleaning Your Computer 59
 Handling the LCD Screen..... 59

Index.....61

Notice to Users

© 2002 Sony Electronics Inc. All rights reserved. This manual and the software described herein, in whole or in part, may not be reproduced, translated, or reduced to any machine-readable form without prior written approval.

SONY ELECTRONICS INC. PROVIDES NO WARRANTY WITH REGARD TO THIS MANUAL, THE SOFTWARE, OR OTHER INFORMATION CONTAINED HEREIN AND HEREBY EXPRESSLY DISCLAIMS ANY IMPLIED WARRANTIES OF MERCHANTABILITY OR FITNESS FOR ANY PARTICULAR PURPOSE WITH REGARD TO THIS MANUAL, THE SOFTWARE, OR SUCH OTHER INFORMATION. IN NO EVENT SHALL SONY ELECTRONICS INC. BE LIABLE FOR ANY INCIDENTAL, CONSEQUENTIAL, OR SPECIAL DAMAGES, WHETHER BASED ON TORT, CONTRACT, OR OTHERWISE, ARISING OUT OF OR IN CONNECTION WITH THIS MANUAL, THE SOFTWARE, OR OTHER INFORMATION CONTAINED HEREIN OR THE USE THEREOF.

Sony Electronics Inc. reserves the right to make any modification to this manual or the information contained herein at any time without notice. The software described herein is governed by the terms of a separate user license agreement.

This product contains software owned by Sony and licensed by third parties. Use of such software is subject to the terms and conditions of license agreements enclosed with this product. Some of the software may not be

transported or used outside the United States. Software specifications are subject to change without notice and may not necessarily be identical to current retail versions.

Updates and additions to software may require an additional charge. Subscriptions to online service providers may require a fee and credit card information. Financial services may require prior arrangements with participating financial institutions.

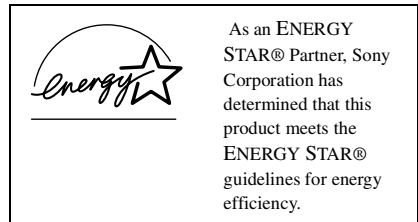



The International ENERGY STAR® Office Equipment Program is an international program that promotes energy saving through the use of computers and other office equipment. The program backs the development and dissemination of products with functions that effectively reduce energy consumption. It is an open system in which business proprietors can participate voluntarily. The targeted products are office equipment such as computers, displays, printers, facsimiles and copiers. Their standards and logos are uniform among

participating nations. ENERGY STAR is a U.S. registered mark.



The Wireless LAN functionality*, which is incorporated into selected models only, has passed Wi-Fi certification and complies with the interoperability specifications established by WECA (Wireless Ethernet Compatibility Alliance).

* Selected models may come with a PC Card.

Sony, DVgate, Handycam, i.LINK, Mavica, MagicGate™ Memory Stick , Memory Stick , MovieShaker, VAIO, and the VAIO logo are trademarks of Sony Corporation. Microsoft, Windows Media, Windows, Windows NT, and the Windows logo are registered trademarks of Microsoft Corporation. Intel, SpeedStep, and Pentium are trademarks or registered trademarks of Intel Corporation. PS/2 is a registered trademark of IBM. Acrobat Reader, Photoshop, Photoshop Elements, and Premiere are trademarks of Adobe Systems Incorporated. PowerPanel is a trademark of Phoenix Technologies Ltd.

This product incorporates copyright protection technology that is protected by method claims of certain U.S. patents and other intellectual property rights owned by Macrovision Corporation and other rights owners. Use of this copyright protection technology must be authorized by Macrovision Corporation, and is

intended for home and other limited viewing uses only unless otherwise authorized by Macrovision Corporation. Reverse engineering or disassembly is prohibited. i.LINK is a trademark of Sony used only to designate that a product contains an IEEE 1394 connection. The i.LINK connection may vary, depending on the software applications, operating system, and compatible i.LINK devices. All products with an i.LINK connection may not communicate with each other. Please refer to the documentation that came with your compatible i.LINK device for information on operating conditions and proper connection. Before connecting compatible i.LINK PC peripherals to your system, such as a CD-RW or hard disk drive, confirm their operating system compatibility and required operating conditions. All other trademarks are trademarks of their respective owners.

Microsoft note

Certain software product(s) included with this computer may include features such as copy protection and content management technology. Use of the software product(s) requires agreement to applicable end user agreements and full compliance with applicable product activation procedures. Product activation procedures and privacy policies will be detailed during initial launch of the software product(s), or upon certain reinstallations of the software product(s) or reconfiguration of the computer, and may be completed by Internet or telephone (toll charges may apply).

Owner's Record

The model number and serial number are located on the bottom of your Sony VAIO computer. Refer to the model and serial number when you call your Sony Service Center.
Model Number: PCG-8D1R, PCG-8D1L, PCG-8D2L
Serial Number: _____

Safety Information

WARNING

- To prevent fire or shock hazard, do not expose your computer to rain or moisture.
- To avoid electrical shock, do not open the cabinet. Refer servicing to qualified personnel only.
- Never install modem or telephone wiring during a lightning storm.
- Never install telephone jacks in wet locations unless the jack is specifically designed for wet locations.
- Never touch uninsulated telephone wire or terminals unless the telephone line has been disconnected at the network interface.
- Use caution when installing or modifying telephone lines.
- Avoid using the modem during an electrical storm.
- Do not use the modem or a telephone to report a gas leak in the vicinity of the leak.
- A socket outlet should be as close as possible to the unit and easily accessible.
- i.LINK, PC Card, and USB connectors are not supplied with Limited Power Sources.



To change the backup battery, please contact your nearest Sony Service Center.

Caution: The use of optical instruments with this product will increase eye hazard. As the laser beam used in this product is harmful to the eyes, do not attempt to disassemble the cabinet. Refer servicing to qualified personnel only.

(For CD-RW/DVD drive, DVD-RW drive) Danger: Visible and invisible laser radiation when open. Avoid direct exposure to beam.

Caution: To reduce the risk of fire, use only No. 26 AWG or larger telecommunication line cord.

AVERTISSEMENT

- Pour prévenir tout risque d'incendie ou d'électrocution, garder cet appareil à l'abri de la pluie et de l'humidité.
- Pour prévenir tout risque d'électrocution, ne pas ouvrir le châssis de cet appareil et ne confier son entretien qu'à une personne qualifiée.
- Ne jamais effectuer l'installation de fil modem ou téléphone durant un orage électrique.
- Ne jamais effectuer l'installation d'une prise téléphonique dans un endroit mouillé à moins que la prise soit conçue à cet effet.
- Ne jamais toucher un fil téléphonique à découvert ou un terminal à moins que la ligne téléphonique n'ait été débranchée de l'interface réseau.

- ❑ Soyez très prudent lorsque vous installez ou modifiez les lignes téléphoniques.
- ❑ Évitez d'utiliser le modem durant un orage électrique.
- ❑ N'utilisez pas le modem ni le téléphone pour prévenir d'une fuite de gaz quand vous êtes près de la fuite.
- ❑ L'appareil doit être le plus près possible d'une prise murale pour en faciliter l'accès.
- ❑ Des connecteurs i.LINK, PC Card, et USB ne sont pas fournis avec des Sources d'Énergie Limitées.



Pour changer la pile de recharge, veuillez contacter votre centre de service Sony le plus près.

Avertissement: L'utilisation d'instruments optiques avec ce produit augmente les risques pour les yeux. Puisque le faisceau laser utilisé dans ce produit est dommageable pour les yeux, ne tentez pas de désassembler le boîtier. Adressez-vous à un agent de service qualifié.

(Pour le lecteur CD-RW/DVD, le lecteur DVD-RW) Danger: Radiation laser visible et invisible si ouvert. Évitez l'exposition directe au faisceau.

Attention : Afin de réduire les risques d'incendie, n'utilisez qu'un cordon de communication NO. 26 AWG ou plus gros.

If you have questions about this product, you can reach the Sony Customer Information Service Center at 1-888-4-SONY-PC; or write to the Sony Customer Information Service Center at 12451 Gateway Blvd., Ft. Myers, FL

33913 or find Sony Customer Service on the Web at: <http://www.sony.com/pcsupport>.

Regulatory Information

Declaration of Conformity

Trade Name:	Sony
Model No.:	PCG-8D1R PCG-8D1L PCG-8D2L
Responsible Party:	Sony Electronics Inc.
Address:	680 Kinderkamack Road Oradell, NJ 07649
Telephone:	201-930-6972 (For FCC-related matters only.)

This device complies with Part 15 of the FCC rules. Operation is subject to the following two conditions:

- (1) This device may not cause harmful interference, and
- (2) this device must accept any interference received, including interference that may cause undesired operation.

This equipment has been tested and found to comply with the limits for a Class B digital device, pursuant to Part 15 of the Rules. These limits are designed to provide reasonable protection against harmful interference in a residential installation. This equipment generates, uses, and can radiate radio frequency energy and, if not installed and used in accordance with the instructions, may cause harmful interference to radio communications. However, there is no guarantee that interference will not occur in a particular installation. If this

equipment does cause harmful interference to radio or television reception, which can be determined by turning the equipment off and on, the user is encouraged to try to correct the interference by one or more of the following measures:

- Reorient or relocate the receiving antenna.
- Increase the separation between the equipment and the receiver.
- Connect the equipment into an outlet on a circuit different from that to which the receiver is connected.
- Consult the dealer or an experienced radio/TV technician for help.

You are cautioned that any changes or modifications not expressly approved in this manual could void your authority to operate this equipment.

Only peripherals (computer input/output devices, terminals, printers, etc.) that comply with FCC Class B limits may be attached to this computer product. Operation with non-compliant peripherals is likely to result in interference to radio and television reception.

All cables used to connect peripherals must be shielded and grounded. Operation with cables, connected to peripherals, that are not shielded and grounded, may result in interference to radio and television reception.

FCC Part 68

This equipment complies with Part 68 of the FCC rules. On the bottom of this equipment is a label that contains, among other information, the FCC Ringer Equivalency Number (REN) for this equipment. If requested, this information must be provided to the telephone company.

This modem uses the USOC RJ-11 telephone jack.

The REN is used to determine the quantity of devices which may be connected to the telephone line. Excessive RENs on the telephone line may result in the devices not ringing in response to an incoming call. In most, but not all areas, the sum of the RENs should not exceed five (5.0). To be certain of the number of devices that may be connected to the line, as determined by the total RENs, contact the telephone company to determine the maximum REN for the calling area.

If the terminal equipment causes harm to the telephone network, the telephone company will notify you in advance that temporary discontinuance of service may be required. But if advance notice is not practical, the telephone company will notify the customer as soon as possible. Also, you will be advised of your right to file a complaint with the FCC if you believe it is necessary.

The telephone company may make changes in its facilities, equipment, operations or procedures that could affect the operations of the equipment. If this happens, the telephone company will provide advance notice in order for you to make the necessary modifications in order to maintain uninterrupted service.

If trouble is experienced with this equipment, you can reach the Sony Customer Information Service Center at 1-888-4-SONY-PC; or write to the Sony Customer Information Service Center at 12451 Gateway Blvd., Ft. Myers, FL 33913 or find Sony Customer Service on the Web at: <http://www.sony.com/pcsupport>.

Repair of this equipment should be made only by a Sony Service Center or Sony authorized agent. For the Sony Service Center nearest you, call 1-888-4-SONY-PC (1-888-476-6972).

This equipment cannot be used on public coin service provided by the telephone company. Connection to Party Line Service is subject to state and possible provincial tariffs. (Contact the state or provincial utility service

commission, public service commission, or corporation commission, for information.)

FCC Radio Frequency Exposure (United States)

This equipment complies with FCC radiation exposure limits set forth for an uncontrolled environment. This equipment should be installed and operated with minimum distance of 8 inches (20 cm) between the radiator and body (excluding extremities: hands, wrists, and feet).

Users are not permitted to make changes or modify the system in any way.

IC RSS-210 (Canada)

Operation is subject to the following two conditions: (1) this device may not cause interference, and (2) this device must accept any interference, including interference that may cause undesired operation of the device.

To prevent radio interference to the licensed service, this device is intended to be operated indoors and away from windows to provide maximum shielding. Equipment (or its transmit antenna) that is installed outdoors is subject to licensing.

The term "IC:" before the certification/registration number only signifies that the Industry Canada technical specifications were met.

L'utilisation de ce dispositif est autorisée seulement aux conditions suivantes: (1) il ne doit pas produire de brouillage et (2) l'utilisateur du dispositif doit être prêt à accepter tout brouillage radioélectrique reçu, même si ce brouillage est susceptible de compromettre le fonctionnement du dispositif.

Pour empêcher que cet appareil cause du brouillage au service faisant l'objet d'une licence, il doit être utilisé à l'intérieur et devrait

être placé loin des fenêtres afin de fournir un écran de blindage maximal. Si le matériel (ou son antenne d'émission) est installé à l'extérieur, il doit faire l'objet d'une licence.

L'expression "IC:" avant le numéro d'homologation/enregistrement signifie seulement que les spécifications techniques d'Industrie Canada ont été respectées.

Telephone Consumer Protection Act of 1991 (United States)

The Telephone Consumer Protection Act of 1991 makes it unlawful for any person to use a computer or other electronic device to send any message via a telephone facsimile machine unless such message clearly contains, in a margin at the top or bottom of each transmitted page or on the first page of the transmission, the date and time it is sent and an identification of the business, other entity, or individual sending the message, and the telephone number of the sending machine or such business, other entity, or individual.

In order to program this information into your facsimile machine, see your fax software documentation.

Telephone Consumer Guidelines (Canada)

Please refer to your telephone directory under 'Privacy Issues' and/or 'Terms of Service.' For more detailed information, please contact:

CRTC

Terrasses de la Chaudière, Tour centrale
1 promenade du Portage, 5 étage Hull
PQ K1A 0N2.

This Class B digital apparatus complies with Canadian ICES-003.

Cet appareil numérique de la classe B est conforme à la norme NMB-003 du Canada.

RECYCLING LITHIUM ION BATTERIES

RECYCLING
LITHIUM-ION
BATTERIES

Lithium-Ion
batteries are
recyclable.

You can help
preserve our
environment by
returning your used
rechargeable
batteries to the
collection and
recycling location
nearest you.

For more information regarding recycling of
rechargeable batteries, call toll free 1-800-
822-8837, or visit <http://www.rbrc.org/>.

Caution: Do not handle damaged or leaking
Lithium-Ion batteries.



RECYCLAGE DES ACCUMULATEURS AUX IONS DE LITHIUM

RECYCLAGE DES
ACCUMULATEU
RS AUX IONS DE
LITHIUM

Les accumulateurs
aux ions de lithium
sont recyclables.

Vous pouvez
contribuer à
préserver
l'environnement en
rapportant les piles
usées dans un point
de collection et
recyclage le plus
proche.

Pour plus d'informations sur le recyclage
des accumulateurs, téléphonez le numéro
gratuit 1-800-822-8837 (Etats-Unis et
Canada uniquement), ou visitez
<http://www.rbrc.org/>.

Avertissement: Ne pas utiliser des
accumulateurs aux ions de lithium qui sont
endommagés ou qui fuient.





Do not handle damaged or leaking lithium ion batteries.

Danger of explosion if battery is incorrectly replaced. Replace only with the same or equivalent type recommended by the manufacturer. Discard used batteries according to the manufacturer's instructions.

The battery pack used in this device may present a fire or chemical burn hazard if mistreated. Do not disassemble, heat above 140°F (60°C) or incinerate. Dispose of used battery promptly. Keep away from children.

Ne pas utiliser des batteries au lithium ionisé qui sont endommagées ou qui fuient.

Une batterie non conforme présente un danger d'explosion. La remplacer seulement par une batterie identique ou de type équivalent recommandé par le fabricant. Évacuer les batteries usées selon les directives du fabricant.

La manutention incorrecte du module de batterie de cet appareil présente un risque d'incendie ou de brûlures chimiques. Ne pas démonter, incinérer ou exposer à une température de plus de 60°C. Évacuer promptement la batterie usée. Garder hors de portée des enfants.

INDUSTRY CANADA NOTICE

NOTICE: The Industry Canada label identifies certified equipment. This certification means that the equipment meets certain telecommunications network protective, operational and safety requirements as prescribed in the appropriate Terminal Equipment Technical Requirements document(s). The Department does not guarantee the equipment will operate to the user's satisfaction.

Before installing this equipment, users should ensure that it is permissible to be connected to the facilities of the local telecommunications company. The equipment must also be installed using an acceptable method of connection.

The customer should be aware that compliance with the above conditions may not prevent degradation of service in some situations.

Repairs to certified equipment should be coordinated by a representative designated by the supplier. Equipment malfunctions or any repairs or alterations made by the user to this equipment may give the telecommunications company cause to request that the user disconnect the equipment.

Users should ensure for their own protection that the electrical ground connections of the power utility, telephone lines and internal metallic water pipe system, if present, are connected together. This precaution may be particularly important in rural areas.

Caution: Users should not attempt to make such connections themselves, but should contact the appropriate electric inspection authority, or electrician, as appropriate.

NOTICE: The Ringer Equivalency Number (REN) assigned to each terminal device provides an indication of the maximum number of terminals allowed to be connected to a telephone interface. The termination on an interface may consist of any combination of

devices subject only to the requirement that the sum of the RENs of all the devices does not exceed 5. The REN for this equipment is 0.2.

AVIS DE L'INDUSTRIE CANADA

AVIS: L'étiquette d'Industrie Canada identifie le matériel homologué.

Cette étiquette certifie que le matériel est conforme aux normes de protection, d'exploitation et de sécurité des réseaux de télécommunications, comme le prescrivent les documents concernant les exigences techniques relatives au matériel terminal. Le Ministère n'assure toutefois pas que le matériel fonctionnera à la satisfaction de l'utilisateur.

Avant d'installer ce matériel, l'utilisateur doit s'assurer qu'il est permis de le raccorder aux installations de l'entreprise locale de télécommunication. Le matériel doit également être installé en suivant une méthode acceptée de raccordement. L'abonné ne doit pas oublier qu'il est possible que la conformité aux conditions énoncées ci-dessus n'empêche pas la dégradation du service dans certaines situations.

Les réparations de matériel homologué doivent être coordonnées par un représentant désigné par le fournisseur. L'entreprise de télécommunications peut demander à l'utilisateur de débrancher un appareil à la suite de réparations ou de modifications effectuées par l'utilisateur ou à cause de mauvais fonctionnement.

Pour sa propre protection, l'utilisateur doit s'assurer que tous les fils de mise à la terre de la source d'énergie électrique, des lignes téléphoniques et des canalisations d'eau métalliques, s'il y en a, sont raccordés ensemble. Cette précaution est particulièrement importante dans les régions rurales.

Avertissement: L'utilisateur ne doit pas tenter de faire ces raccordements lui-même; il doit avoir recours à un service d'inspection des installations électriques, ou à un électricien, selon le cas.

AVIS: L'indice d'équivalence de la sonnerie (IES) assigné à chaque dispositif terminal indique le nombre maximal de terminaux qui peuvent être raccordés à une interface.

La terminaison d'une interface téléphonique peut consister en une combinaison de quelques dispositifs, à la seule condition que la somme d'indices d'équivalence de la sonnerie de tous les dispositifs n'excède pas 5. L'indice d'équivalence de la sonnerie de ce matériel est de 0.2.

CD-RW/DVD Drive Laser Diode Properties

Laser Output:	151.50 μ W (CD)
	3.352 μ W (DVD)
Wave Length:	785 nm (CD)
	660 nm (DVD)

DVD-RW Drive Laser Diode Properties

Laser Output:	330 μ W (CD)
	82.7 μ W (DVD)
Wave Length:	785 nm (CD)
	655 nm (DVD)



The use of optical instruments with this product will increase eye hazard. As the laser beam used in this product is harmful to the eyes, do not attempt to disassemble the drive cabinet. Refer servicing to qualified personnel only.



Visible and invisible laser radiation when open. Avoid direct exposure to beam.

Setting Up

Congratulations on your purchase of the Sony VAIO® computer. Sony has combined leading-edge technology in audio, video, computing, and communications to provide you with state-of-the-art personal computing.

- ❑ Unpacking Your Computer
- ❑ Applying Ergonomics
- ❑ Locating Controls and Ports

Unpacking Your Computer

Main Unit

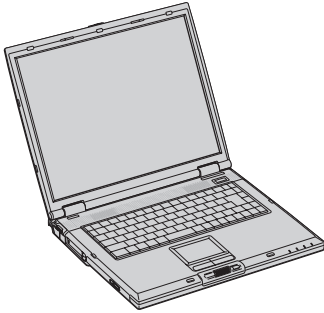

Power Cord

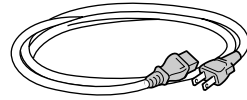

Weight Saver

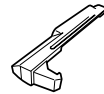

AC Adapter

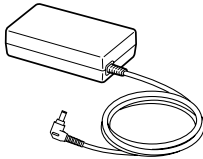

Rechargeable Battery

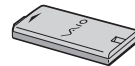

 A Wireless LAN PC Card may also come with your computer, depending on the model you purchased.

Documents

- ❑ **VAIO® Computer User Guide** — A searchable online help file that contains detailed information on how to use your new computer. See “Locating Your VAIO Computer User Guide” on page 31 for more information.
- ❑ **VAIO® Computer Quick Start** — Contains information on unpacking and setting up your computer for immediate use.
- ❑ **VAIO® Computer Specifications (Windows® XP)** — An online file that details the hardware specifications and lists the installed software programs on your computer. See “Locating Your VAIO Computer User Guide” on page 31 for more information.

- ❑ **VAIO® Computer Specifications (Windows® 2000)** — A printed sheet that details your computer's hardware specifications.
- ❑ **Microsoft® Windows® guide** — Explains how to use the basic features of the Microsoft® Windows® operating system installed on your computer.

Software CDs

- ❑ **Microsoft® Word** — Enables you to reinstall Microsoft Word to your VAIO® computer if the application becomes corrupted or is erased.

Recovery CDs

- ❑ **Application Recovery CD(s)** — Enables you to reinstall individual software programs and device drivers if they become corrupted or are erased.
- ❑ **System Recovery CD(s)** — Enables you to restore the operating system and software that shipped with your computer if they become corrupted or are erased. This CD restores your computer to its original factory settings, so user data and programs installed since you started using your computer will be lost.

 To use these recovery CDs, see “Using Your Recovery CDs” on page 40.

Applying Ergonomics

Your computer is a portable device and can be used in a variety of environments. Whenever possible, you should apply the following ergonomic considerations for both stationary and portable environments.

- ❑ **Position of your computer** — Place the computer directly in front of you as you work. Keep your forearms horizontal, with your wrists in a neutral, comfortable position while using the keyboard, touch pad, or external mouse. Let your upper arms hang naturally at your sides. Take breaks during sessions with your computer. Excessive use of the computer may strain muscles or tendons.
- ❑ **Furniture and posture** — Sit in a chair with good back support and armrests. Adjust the level of the chair so your feet are flat on the floor. A footrest may make you more comfortable. Sit in a relaxed, upright posture and avoid slouching forward or leaning far backward.
- ❑ **Viewing angle of the computer's display** — Use the display's tilting feature to find the best viewing angle. Also try adjusting the brightness setting of the display. Following these suggestions can reduce eye strain and muscle fatigue.
- ❑ **Lighting** — Choose a location where windows and lights do not create glare and reflection on the display. Use indirect lighting to avoid bright spots on the display. You can also purchase accessories for your display that help reduce glare. Proper lighting adds to your comfort and work effectiveness.
- ❑ **Placement of an external display** — When using an external display, set the display at a comfortable viewing distance. Make sure the display screen is at eye level or slightly lower when you are sitting in front of the monitor.

Locating Controls and Ports

Front

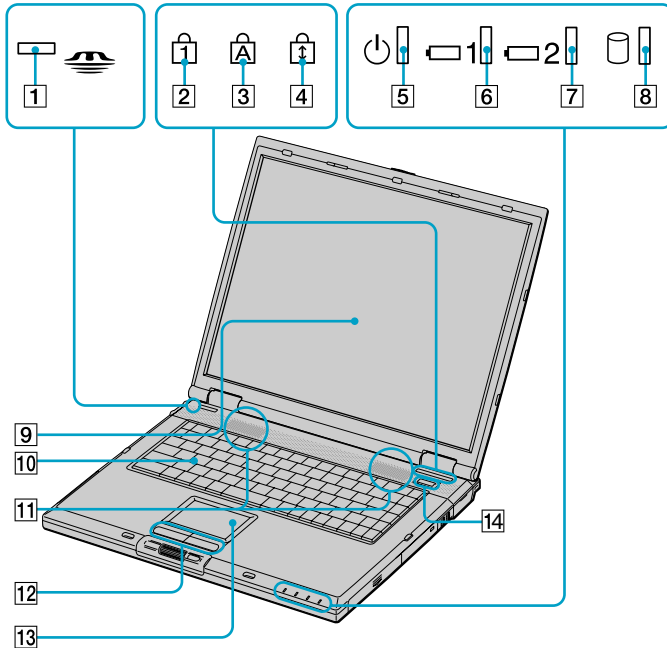

1	Memory Stick® media indicator	8	Hard disk drive indicator
2	Num lock indicator	9	LCD screen
3	Caps lock indicator	10	Keyboard
4	Scroll lock indicator	11	Speakers
5	Power indicator	12	Left and right buttons
6	Battery indicator 1	13	Touch pad
7	Battery indicator 2	14	Power button

Back

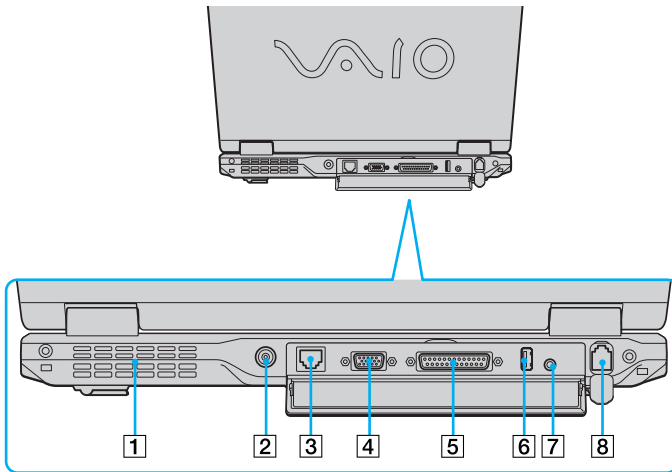

1	Air vent*	5	Printer port
2	⚡ DC IN port	6	🔌 USB port
3	🌐 Network (Ethernet) port	7	🔊 A/V OUT jack
4	📺 Monitor (VGA) port	8	📞 Telephone line jack

* Do not cover the air vent when your computer is on.



Only connect 10BASE-T and 100BASE-TX cables to the 🌐 Network (Ethernet) port. Do not connect any other type of network cable or any telephone line. Connecting cables other than those listed above may result in an electric current overload and could cause a malfunction, excessive heat, or fire in the port. To connect the unit to the network, contact your network administrator.

Left

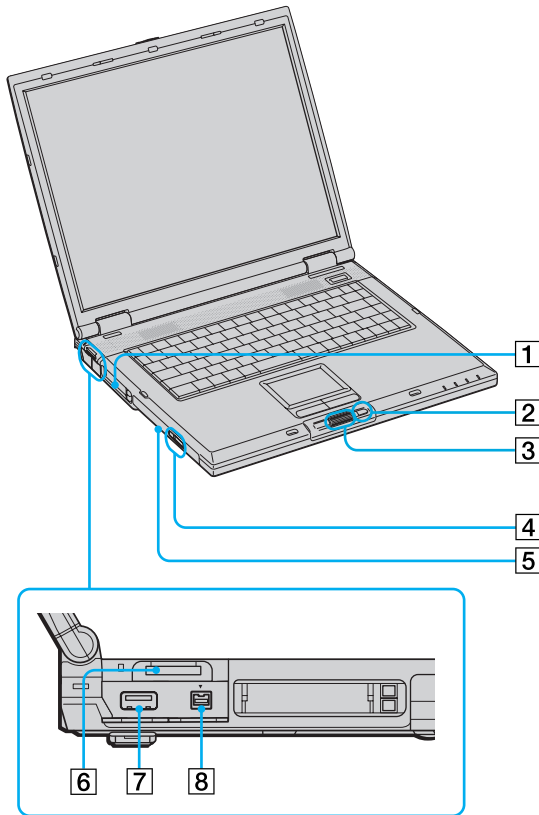

1	PC Card slot	5	Optical drive*
2	BACK button	6	Memory Stick® media slot
3	Jog Dial™ Control	7	USB port
4	Eject button	8	i.LINK® (IEEE 1394) S400 port

* Your computer may come with a CD-RW/DVD drive or a DVD-RW drive, depending on the model you purchased.

Right

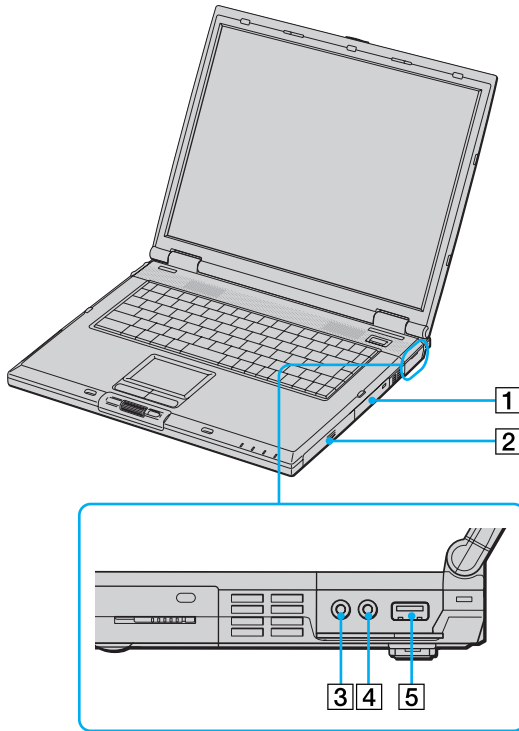

1	Hard disk drive bay	4	Microphone jack
2	Battery bay	5	USB port
3	Headphone jack		

Bottom

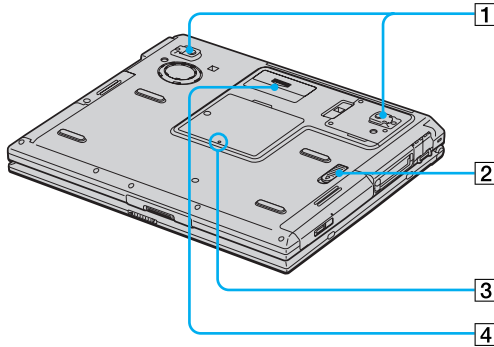

1	Tilt stands	3	Reset button
2	Multipurpose bay RELEASE switch	4	Port replicator connector

Getting Started

This section helps you get your computer running and registered, so you can take advantage of Sony's many support options. You'll also learn how to locate your online VAIO® Computer User Guide, which contains step-by-step instructions for operating your computer.

- ❑ Turning On Your Computer
- ❑ Using the Touch Pad
- ❑ Registering Your Computer
- ❑ Locating Your VAIO Computer User Guide
- ❑ Setting Up A Dial-Up Connection
- ❑ Turning Off Your Computer

Turning On Your Computer

To use your computer immediately, use the supplied AC adapter as a power source. Your supplied battery is not charged when you unpack it, however, you can begin charging it when you use your AC adapter. See “Powering Your Computer” in your online VAIO® Computer User Guide for more information about using batteries. See also “Locating Your VAIO Computer User Guide” on page 31.

To charge your battery

- 1 Push the battery bay cover down to open it. The battery bay cover swings out but does not detach from the computer.

Opening the Battery Bay

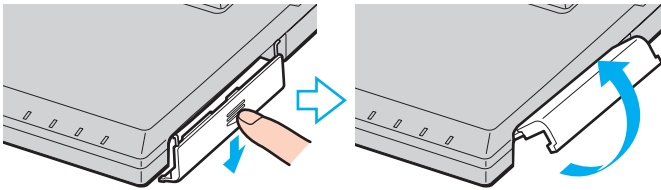

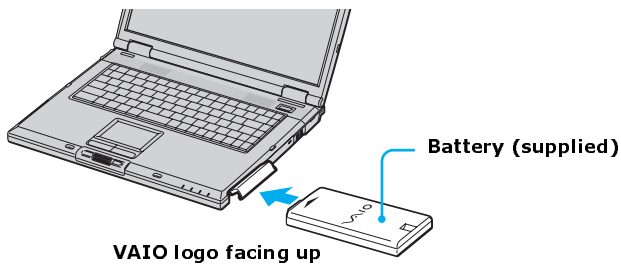

- 2 Slide the battery into the battery bay. If the computer is on, it automatically detects the battery.

Inserting a Battery



- 3 Push the battery bay cover up until it clicks into place.

 If the port replicator is attached to your computer, do not insert or remove the battery. Lifting and turning the computer with the port replicator attached could cause a temporary loss of power.

Once you connect the AC adapter to the computer, the battery begins to charge whether or not the computer is on or off. The battery indicator  shows the battery status. The indicator blinks as the battery charges. See “Powering Your Computer” in your online VAIO® Computer User Guide for more information.

To connect the AC adapter

- 1 Plug the cable attached to the AC adapter into the DC IN port on your computer or port replicator.

Connecting the AC adapter to the Computer

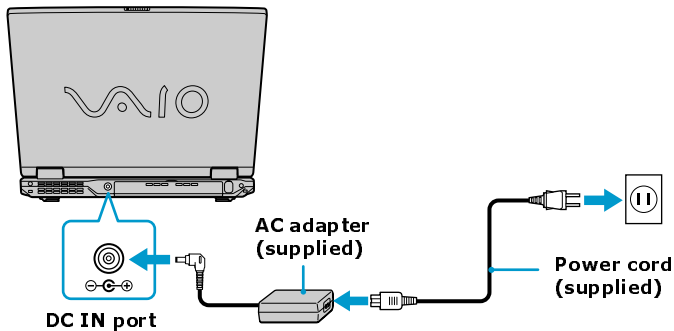

- 2 Plug one end of the power cord into the AC adapter, and plug the other end into an AC outlet

 Use only the supplied AC adapter with your computer.

- 3 Slide the release lever to the right and lift the cover while holding the bottom of the computer firmly.

Opening the Computer

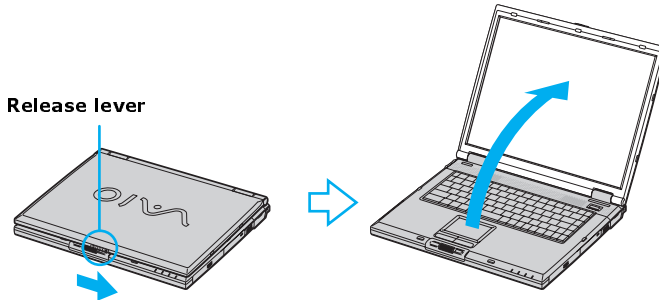

- 4 Press the power button until the power indicator turns on.

Turning on the Computer

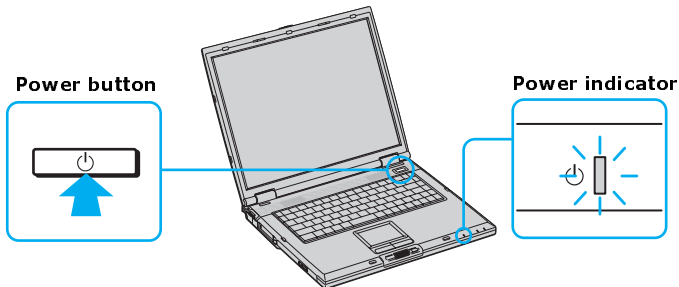

 If you hold down the power button, the computer turns off.

- 5 If necessary, adjust the brightness controls for the LCD display as follows:
 - ❑ To increase brightness, press and release the **Fn+F5** keys. Press the **Up Arrow** key **↑** or **Right Arrow** key **→**.
 - ❑ To decrease brightness, press and release the **Fn+F5** keys. Press the **Down Arrow** key **↓** or **Left Arrow** key **←**.

Using the Touch Pad

The keyboard contains a pointing device called a touch pad. You can point to, select, drag, and scroll objects on the screen using the built-in touch pad.

Describing touch pad actions

Touch pad

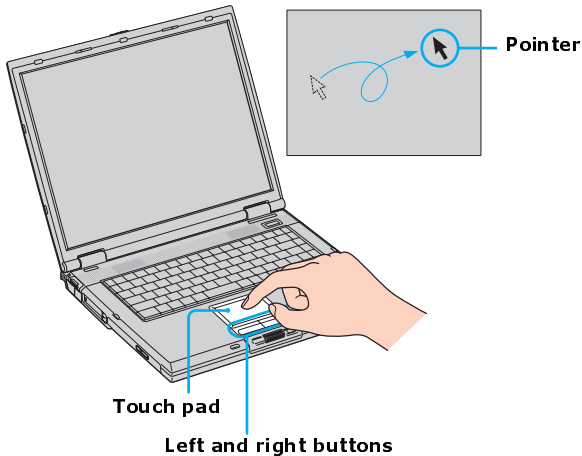

Action	Description
Point	Slide one finger on the touch pad to place the pointer on an item or object.
Click	Press the left button once.
Double-click	Press the left button twice.

Action	Description
Right-click	Press the right button once. In many programs, this action displays a shortcut menu of context-sensitive choices.
Drag	Slide one finger while pressing the left button.
Scroll	Move your finger along the right edge of the touch pad to scroll vertically. Move your finger along the bottom to scroll horizontally. (The scroll function is available only with programs that support a touch pad scroll feature.)

Registering Your Computer

Take advantage of Sony's commitment to quality customer support and receive these benefits by registering your computer:

- ❑ Sony Customer Support — Talk to a Support Representative to troubleshoot problems you may have with your computer.
- ❑ Limited Warranty Extension — Protect your investment. See the Warranty Card for more details.
- ❑ Product Information Notification — By giving Sony your contact information, you will enable Sony to reach you regarding performance updates and upgrades.

 You are prompted to register your computer the first time you turn on the unit. Follow the on-screen instructions to complete the registration process. If you are not able to register your computer during the first session, you are provided with additional registration opportunities later.

Locating Your VAIO Computer User Guide

The VAIO® Computer User Guide is a searchable online help file that contains detailed information on how to use your new computer.

To open the user guide (Windows XP)

- 1 Click **Start** on the Windows® taskbar, and then click **Help and Support**. The **Help and Support Center** window appears.

Locating the VAIO User Guide

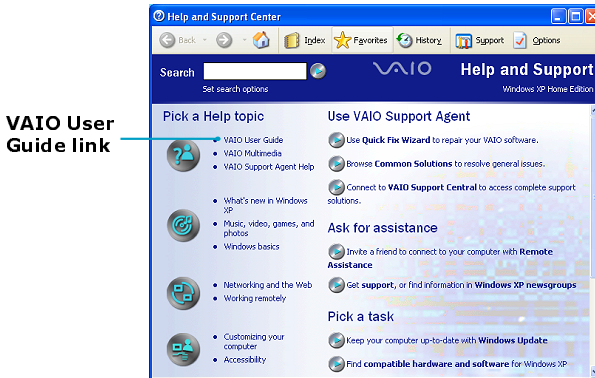

- 2 Click **VAIO User Guide** in the **Pick a Help topic** column. A second **Help and Support Center** window appears, which offers detailed information about your computer.

VAIO User Guide Window

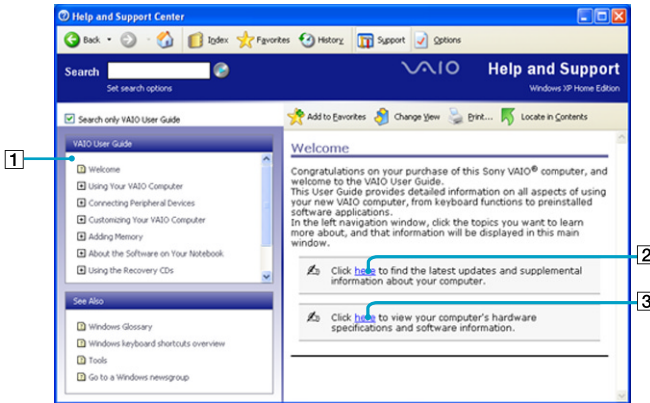

1	User guide table of contents	List of computer help topics
2	Electronic Flyer	List of updates and supplemental information
3	VAIO Computer Specifications	List of specifications and software

To open the user guide (Windows 2000)

- ❑ Click **Start** on the Windows® taskbar, point to **VAIO Help Center** and click **VAIO User Guide**. The **VAIO User Guide** appears.

VAIO User Guide Window

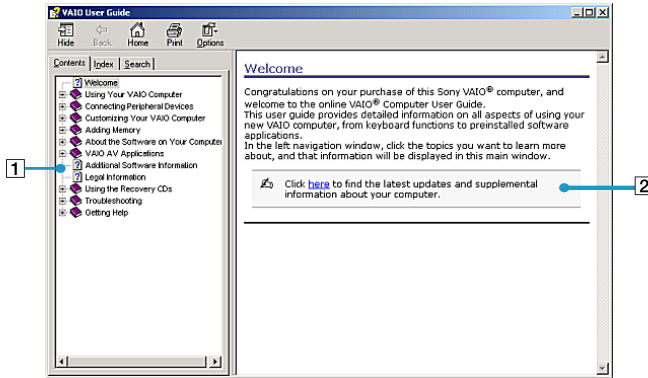

- | | | |
|---|------------------------------|--|
| 1 | User guide table of contents | List of computer help topics |
| 2 | Electronic Flyer | List of updates and supplemental information |

Setting Up A Dial-Up Connection

This section describes the basic steps for setting up your dial-up connection. The Connection Wizard guides you through the process of connecting to the Internet and choosing an Internet Service Provider (ISP) or setting up an existing account.

To set up a dial-up connection (Microsoft® Windows® XP operating system)

- 1 Connect a telephone cable to your computer. See “To connect a telephone cable” in the Internet and Network Connections chapter of your online VAIO® Computer User Guide.
- 2 Click **Start**, point to **All Programs, Accessories, Communications**, and then click **New Connection Wizard**. The **New Connection Wizard** appears.

New Connection Wizard



- 3 Click **Next**.
- 4 If it is not already selected, click **Connect to the Internet**.
- 5 Click **Next**.
- 6 Follow the on-screen instructions.

To set up a dial-up connection (Microsoft® Windows® 2000 operating system)

- 1 Click **Start**, point to **Programs, Accessories, Communications**, and then click **Internet Connection Wizard**. The **Internet Connection Wizard** window appears.

Internet Connection Wizard

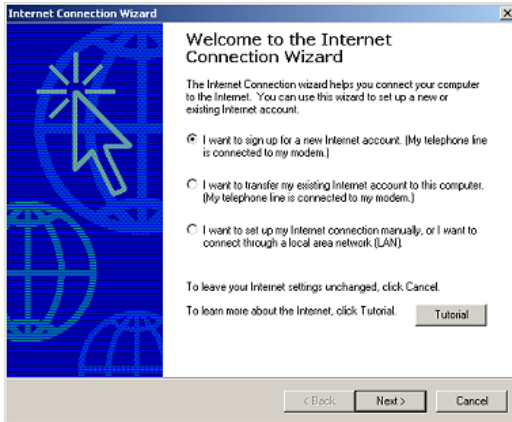

- 2 Follow the on-screen instructions to finish setting up your Internet connection.

Turning Off Your Computer

Using the power button to turn off your computer may result in loss of data. Follow the steps below to properly turn off your computer and avoid losing data.

To turn off your computer

- 1 Close or end all operations.
 - Close all programs.
 - Remove the PC Cards.
 - Disconnect USB devices.
- 2 Click **Start** on the Windows® taskbar.

3 Select the **Turn Off Computer** or **Shut Down** command at the bottom of the menu.

- ❑ (Windows XP) Click **Turn Off Computer** at the bottom of the **Start** menu to display the **Turn off computer** window, and click **Turn Off**.
- ❑ (Windows 2000) Click **Shut Down** at the bottom of the **Start** menu to display the **Shut Down Windows** window, and click **Shut Down**.

 Respond to any prompts warning you to save documents.

4 Wait for your computer to turn off automatically. The computer is off when the power indicator turns off.

 During a period of inactivity, you can conserve battery life by using the power saving modes. See “Controlling Power Management” in the online VAIO® Computer User Guide for more information.

5 If you are unable to turn off your computer, then restart the computer.

- ❑ (Windows XP) Press the key combination **Ctrl+Alt+Delete**. The **Windows Task Manager** dialog box appears. Select **Restart** from the **Shut Down** menu.
- ❑ (Windows 2000) Press the key combination **Ctrl+Alt+Delete**. The **Windows Security** screen appears. Select **Restart** from the **Shut Down** menu.

 If you are still unable to shut down the computer, you can press the power button and hold it for more than four seconds. This operation may result in data loss.

Expanding Your Computing Power

This section helps you get started upgrading computer memory and locating information about preinstalled software programs.

- ❑ Upgrading Memory
- ❑ Locating Preinstalled Programs

Upgrading Memory

Depending on the configuration you purchased, your computer may accept additional memory modules. For information about installation procedures, refer to the online VAIO® Computer User Guide and print those relevant steps. See “Locating Your VAIO Computer User Guide” on page 31.

The specifications supplied with your computer (either online for Windows XP or printed for Windows 2000, depending on your computer's operating system) lists the amount of installed memory and required memory modules for upgrades.

Locating Preinstalled Programs

Your computer comes with a variety of preinstalled audio/video programs. The following sources offer a list of preinstalled programs, descriptions, and information:

- ❑ **VAIO® Computer User Guide** — The Preinstalled Programs chapter of your online VAIO® Computer User Guide contains a list of programs, descriptions, and support information. See “Locating Your VAIO Computer User Guide” on page 31 for more information.
- ❑ **VAIO® Computer Specifications (Windows XP)** — The online file details your computer’s hardware specifications and lists preinstalled programs, descriptions, and support information. See “Locating Your VAIO Computer User Guide” on page 31 for more information.
- ❑ **All Programs** — The All Programs file on the Start menu contains a list of all the preinstalled programs on your computer.

Using the Recovery CDs

- ❑ Application and System Recovery CDs
- ❑ Using Your Recovery CDs

Application and System Recovery CDs

Your computer comes with the following Application Recovery and System Recovery CDs. You will need an optical drive to use these recovery CDs. If your computer does not come with an optical drive, use an external optical drive.

Application Recovery CD(s)

Sony Electronics Inc.

This CD enables you to reinstall individual software programs and device drivers if they become corrupted or are erased.

System Recovery CD(s)

Sony Electronics Inc.

This CD enables you to restore the operating system and software that shipped with your computer if they become corrupted or are erased. This CD restores your computer to its original factory settings, so user data and software programs installed since you started using your computer will be lost.

Using Your Recovery CDs

The following sections describe how to use the Application Recovery and System Recovery utilities.

- Using the Application Recovery CD(s)
- Using the System Recovery CD(s)

Using the Application Recovery CD(s)

The Application Recovery CD(s) utility enables you to reinstall individual software programs, device drivers, and repair software programs if they become corrupted or are erased. Reinstalling an individual program or device driver may correct a problem you are experiencing with your computer, peripheral hardware, or software. You may not need to reinstall the entire contents of your hard disk. To reinstall all the software titles that shipped with your computer, use the System Recovery CD(s). See “Using the System Recovery CD(s)” on page 42 for more information.

 You must be using a Windows® operating system to run the Application Recovery CD utility.

To reinstall programs with the Application Recovery CD(s)

- 1 Turn on your computer. If your computer is already on, close all open programs.
- 2 Logon to the Microsoft® Windows® desktop.
- 3 Insert Sony Application Recovery CD No. 1 into your computer's optical drive. The Application Recovery utility starts automatically.
- 4 Click **OK** in the VAIO welcome window. The **Sony Application Recovery Program** window appears.
- 5 Double-click the **Software** folder icon.
- 6 Double-click the application you want to restore, and then follow the on-screen instructions to complete the recovery process.

 Your system may include one or more Application Recovery CDs. If you have more than one Application Recovery CD, insert the first CD to run the Application Recovery program. You may be prompted to insert the next CD, depending on the application you wish to restore.

To reinstall device drivers with the Application Recovery CD(s)

- 1 Logon to the Microsoft® Windows® desktop.
- 2 Insert Application Recovery CD No. 1 into your computer's optical drive.
- 3 Click **Start** on the Windows® taskbar, and right-click **My Computer**.
- 4 Click **Properties**. The **System Properties** dialog box appears.
- 5 Click the **Hardware** tab, and click **Device Manager**.
- 6 Right-click the unknown device or the device that requires the driver installation, and click **Update Driver** from the shortcut menu.

 Unknown devices are identified by a yellow question mark. A device with a driver problem is identified by a yellow exclamation point.

- 7 In the **Hardware Update Wizard**, click to select **Install from a list or specific location (Advanced)**.
- 8 Click **Next**.

- 9 Click to cancel the **Search removable media (floppy, CD-ROM...)** option.
- 10 Click to select the **Include this location in the search** check box.
- 11 Click **Browse**. The **Browse For Folder** dialog box appears.
- 12 Navigate to the optical drive, and click to select the Application Recovery CD. The CD contents are displayed.
- 13 Click the folder name of the device in which you want to reinstall, and click **OK**. The **Hardware Update Wizard** appears.
- 14 Click **Next**, and select the device folder. The Microsoft® Windows® operating system automatically reinstalls the device driver(s) from the Application Recovery CD.
- 15 Click **Finish**, and remove the Application Recovery CD from the optical drive.
- 16 Turn off your computer by clicking **Start**, and then **Turn off computer**.
- 17 Wait 30 seconds, and turn on your computer.

 Your system includes one or more Application Recovery CDs. Insert Application Recovery CD No. 1 to start the application or driver recovery process. You are prompted to insert the next CD(s), depending on the application or driver you want to restore.

If you have any questions about using the Application Recovery CD(s), visit <http://www.sony.com/pcsupport>, or contact Sony Customer Support at 1-888-4-SONY-PC.

Using the System Recovery CD(s)

The System Recovery CD(s) enables you to format your hard disk and restore all original software programs. Your computer is returned to the original factory settings.



The System Recovery process removes all software that you may have installed since you started using your computer. Reinstall any software programs that were not included with the computer when you purchased it.

You can use the System Recovery CD(s) to reinstall the operating system and software titles that shipped with your computer if they become corrupted or are erased. You may not need to reinstall the entire contents of your hard drive. If you experience a problem with your computer, reinstalling an individual device driver or software title may correct the problem. Use the Application Recovery CD(s) to reinstall individual programs and device drivers. See “Using the Application Recovery CD(s)” on page 40 for more information.

The System Recovery CD(s) contains a backup copy of all the software originally installed on your hard disk. It can be used only to recover the hard disk of the computer you purchased.

System Recovery options

- ❑ **Default System Drive Recovery** — All data on Drive C is deleted. The factory default settings and software programs are restored on this drive only.
- ❑ **Change Partition Size** — All partitions, custom installations, and changes are removed from the hard drive. You can set the partition sizes for both Drive C and Drive D. The original, preinstalled operating system and software programs are restored.
- ❑ **Recovery to Original Factory Defaults** — All data and partitions are removed from the hard drive. All original factory settings, the operating system, and preinstalled software are restored.



The System Recovery utility does not back up your system's data. If you wish to retain your system data, perform a backup to an external media.

To use the System Recovery CD(s)

Your system may take a few minutes to load necessary files. A blue screen may appear during the downloading process.

- 1 Insert the Sony System Recovery CD into the optical drive. The first CD must be in the drive before you restart your computer.
- 2 Turn off your computer by clicking **Start**, and then **Turn off computer**.
- 3 Wait 30 seconds, and turn on your computer. The System Recovery utility restarts from the optical drive.
- 4 When the **VAIO System Recovery Utility** wizard appears, click **Next**.

- 5 Follow the on-screen instructions to complete the recovery process.

If your computer does not start from the Recovery CD

- 1 Press the power button and hold it for more than four seconds to turn off the computer.
- 2 Turn on the computer. When the Sony logo is displayed, press the **F2** key. The **BIOS Setup Utility** appears.
- 3 Press the right arrow key **→** to select the **Exit** menu.
- 4 Press the down arrow key **↓** to select **Get Default Values**, and press **Enter**. The **Setup Confirmation** window appears.
- 5 Press **Enter** again to select **Yes**.
- 6 Make sure **Exit (Save Changes)** is selected, and then press **Enter**. The **Setup Confirmation** window appears again.
- 7 Make sure **Yes** is selected, and press **Enter**. The computer restarts from the Recovery CD.

 Your system may include one or more System Recovery CDs. If you have more than one System Recovery CD, insert the first CD to run the System Recovery program. You are prompted to insert the second CD once the information from the first CD has been installed.

The recovery process takes 30 to 60 minutes to complete.

After recovering your system using the System Recovery CD(s), you may be prompted to insert your Application Recovery CD(s) after restarting the Windows operating system. Insert the Application Recovery CD to automatically complete recovery of your system.

Troubleshooting

This section describes how to solve some basic problems you may encounter when using your computer. For more troubleshooting topics refer to the online VAIO® Computer User Guide. Many problems have simple solutions, so refer to these sources before you contact Sony Computing Support (<http://www.sony.com/pcsupport>).

- ❑ Troubleshooting Your Computer
- ❑ Troubleshooting the LCD Screen
- ❑ Troubleshooting the Mouse and Touch Pad
- ❑ Support Options
- ❑ Program Support Information

Troubleshooting Your Computer

Why doesn't my computer start?

- ❑ Make sure the computer is securely plugged into a power source and is turned on. Make sure the power indicator shows the power is on. See “Turning On Your Computer” on page 26 for more information.
- ❑ Make sure the battery is inserted properly and is charged.
- ❑ Make sure the floppy disk drive is empty.
- ❑ If the computer is plugged into a power strip or Uninterruptible Power Supply (UPS), make sure the power strip or UPS is turned on and working.
- ❑ If you are using an external display, make sure it is plugged into a power source and turned on. Make sure the brightness and contrast controls are adjusted correctly. See the manual that came with your display for details.
- ❑ Remove the AC adapter and battery. Wait one minute. Reattach the AC adapter and reinsert the battery, and turn on the power.
- ❑ Condensation may cause the computer to malfunction. If this occurs, do not use the computer for at least one hour.
- ❑ If the computer still does not turn on, follow these steps:
 - 1 Unplug the power cord and remove the battery.
 - 2 Use a thin, straight object (such as a paper clip) to press the reset button. See “Locating Controls and Ports” on page 19 to locate the reset button.
 - 3 Reinsert the power cord and the battery.
 - 4 Turn on the computer.

Why does a BIOS error appear when my computer starts?

If the message “Press <F1> to resume, <F2> to setup” appears at the bottom of the screen. Follow these steps:

- 1 Press **F2**. The **BIOS Setup** menu appears.
- 2 Set the date (month/day/year). Press **Enter**.
- 3 Press the **Down Arrow** key ↓ to select **System Time**, and then set the time (hour: minute: second). Press **Enter**.

- 4 Press the **Right Arrow** key → to select the **Exit** tab, and then press the **Down Arrow** key ↓ to select **Get Default Values**. The message **Load default values for all SETUP items** appears.
- 5 Press **Enter**. The **Setup Confirmation** window appears.
- 6 Select **Yes**, and press **Enter**.
- 7 Select **Exit (Save Changes)**, and press **Enter**. The **Setup Confirmation** window appears again.
- 8 Select **Yes**, and press **Enter**. The computer restarts.

 If this occurs on a regular basis, contact Sony Computing Support (<http://www.sony.com/pcsupport>).

Why does the message “Operating system not found” appear when my computer starts, and why won’t Windows start?

- Make sure there is no disk in the floppy disk drive (non-bootable).
- If a non-bootable floppy disk is in the drive, proceed as follows:
 - 1 Turn off the computer, and remove the floppy disk.
 - 2 Restart the computer and confirm that the Windows® operating system starts properly.
- If Windows still does not start, follow these steps to initialize the BIOS:
 - 1 Remove any floppy disk from the floppy disk drive.
 - 2 Turn off the computer.
 - 3 Remove any peripheral devices connected to the computer.
 - 4 Restart the computer.
 - 5 Press **F2** when the Sony logo appears. The **BIOS Setup** window appears.
 - 6 Press the **Right Arrow** key → to select the **Exit** menu.
 - 7 Press the **Down Arrow** key ↓ to select **Get Default Values**. The message **Load default values for all SETUP items** appears.
 - 8 Press **Enter**. The **Setup Confirmation** window appears.
 - 9 Select **Yes**, and press **Enter**.

- 10 Select **Exit (Save Changes)**, and press **Enter**. The **Setup Confirmation** window appears again.
- 11 Select **Yes**, and press **Enter**. The computer restarts.

If your computer continues to display the message “Operating system not found,” and Windows does not start, use your supplied System Recovery CD(s) to restore the software titles shipped with your computer. See “Using the System Recovery CD(s)” on page 42 for more information.



The System Recovery CD restores your computer to its original state, so user data and applications will be lost.

Why does my computer stop responding or won't turn off?

It is best to turn off your computer using the Turn Off Computer command on the Windows Start menu. Using other methods, including those listed below, may result in loss of unsaved data.

- ❑ (Windows XP) Click **Start** on the Windows® taskbar, select **Turn Off Computer**, and then click **Turn Off**.
(Windows 2000) Click **Start** on the Windows® taskbar, and select **Shut Down**. When the **Shut Down Windows** window appears, make sure **Shut down** is selected, and click **OK**.
- ❑ If your computer does not turn off, press **Ctrl+Alt+Delete** simultaneously.
(Windows XP) When the **Windows Task Manager** dialog box appears, click **Turn Off** from the **Shut Down** menu.
(Windows 2000) When the **Windows Security** dialog box appears, click **Shut Down**, and select Shut down again from the **Shut Down Windows** window.
- ❑ If your computer still does not turn off, press and hold the power button for at least four seconds to turn off the power.
- ❑ Unplug the computer from the AC adapter, and remove the battery from your computer.
- ❑ If your computer stops responding while playing a CD or DVD, press **Ctrl+Alt+Delete** simultaneously. You can turn off the computer from the **Shut Down** menu.



Pressing the **Ctrl+Alt+Delete** keys simultaneously or turning off the computer with the power button may result in data loss in files that are currently open.

Why won't the power management respond?

Your computer's operating system may become unstable if a lower power state, such as Hibernate, is initiated and changed before the computer completely enters the lower power state.

To restore the computer to its normal operating stability

- 1 Close all open programs.
- 2 Restart the computer. Follow these steps:
 - 1 Press the **Windows** key .
 - 2 Press **U**. The Turn off computer window opens.
 - 3 Press **R** to select restart.
 - 4 (Windows 2000) Press **Enter**.
- 3 If the computer does not restart,
 - 1 (Windows XP) Press **Ctrl+Alt+Delete** simultaneously. The **Windows Task Manager** window appears.
(Windows 2000) Press **Ctrl+Alt+Delete** simultaneously. The **Windows Security** dialog box appears.
 - 2 (Windows XP) Press **Alt** to highlight the menu bar, and press the **Right Arrow →** key to select **Shut Down**.
(Windows 2000) Press the **Right Arrow →** key to select **Shut Down**.
 - 3 Press **Enter**.
 - 4 Press **R** to select restart.
 - 5 (Windows 2000) Press **Enter**.
- 4 If this procedure does not work, press and hold the power button for four seconds or longer to turn off the computer.

Troubleshooting the LCD Screen

Why did the computer (LCD) screen go blank?

- Your computer screen may go blank if the computer has lost power or is in a power saving mode (Standby or Hibernate).





- ❑ Make sure the computer is plugged into a power source and is turned on. The power indicator on the computer will be on if the computer is on.
- ❑ Make sure the battery is inserted properly and is charged.
- ❑ If the computer is in LCD (Video) Standby mode, press any key to activate the computer screen.
- ❑ If the display mode is set to external display (such as TV), press and hold the **Fn** key while you press **F7** several times.

Troubleshooting the Mouse and Touch Pad

Why doesn't the mouse work properly?

- ❑ If you are using a Sony USB mouse, make sure the mouse is securely plugged into the USB port.
- ❑ If you are using an external mouse, make sure the mouse is securely plugged into the USB port or the PS/2 port if you are connecting it to the port replicator.
- ❑ If you are still experiencing problems, use your supplied Application Recovery CD to reinstall the mouse drivers. See “Using the Application Recovery CD(s)” on page 40 for more information.

Why doesn't the touch pad work properly?

- ❑ You may have disabled the touch pad without connecting a mouse to the computer. To enable the touch pad:
 - 1 (Windows XP) Press the **Windows** key , and then press **P** to open the **All Programs** menu.
(Windows 2000) Press the **Windows** key , and then press **P** to open the **Programs** menu.
 - 2 Press **Enter**.
 - 3 Press the **Down Arrow**  key to select **Sony Notebook Setup**, and press **Enter**.
 - 4 Select **Sony Notebook Setup** again, and press **Enter**.
 - 5 Press the **Right Arrow** key  to select the **Device** tab.

- 6 Press the **Tab** key to select the left panel, and then press the **Down Arrow** key ↓ to select **Pointing Device**.
 - 7 Press **Alt+S** simultaneously. The **Mouse Properties** dialog box appears.
 - 8 Make sure the **Buttons** tab is selected, and press the **Up Arrow** key ↑ and **Down Arrow** key ↓ to change the button assignments. Press the **Tab** key to move between shortcut menus.
 - 9 Press **Enter** to save your changes and close the dialog box.
- ❑ Restart the computer to activate the touch pad again.
 - ❑ If your touch pad is interpreting a single tap as a double-click, adjust the button assignments. Follow these steps:
 - 1 Press the **Windows**  and the **E** keys. The **My Computer** window appears.
 - 2 Click the **Tools** menu, and select **Folder Options**. The **Folder Options** dialog box appears with the **General** tab open.
 - 3 In the **Click items as follows** box, click to select **Single-click to open an item (point to select)**.
 - 4 Click **Apply**.
 - ❑ If you are still experiencing problems, make sure another mouse was not installed.
 - ❑ You may need to use your Application Recovery CD(s) to reinstall the mouse drivers. See “Using the Application Recovery CD(s)” on page 40 for more information.

Why doesn't the pointer move when I use the touch pad or mouse?

- ❑ You should restart your computer. Follow these steps:
 - 1 Press the **Windows** key .
 - 2 Press **U**. The Turn off computer window opens.
 - 3 Press **R** to select restart.
 - 4 (Windows 2000) Press **Enter**.
- ❑ If the computer does not restart,

- 1 (Windows XP) Press **Ctrl+Alt+Delete** simultaneously. The **Windows Task Manager** window appears.
(Windows 2000) Press **Ctrl+Alt+Delete** simultaneously. The **Windows Security** dialog box appears.
 - 2 (Windows XP) Press **Alt** to highlight the menu bar, and press the **Right Arrow →** key to select **Shut Down**.
(Windows 2000) Press the **Right Arrow →** key to select **Shut Down**.
 - 3 Press **Enter**.
 - 4 Press **R** to select restart.
- ❑ If you still cannot restart your computer, press and hold the power button for more than four seconds to turn off the computer.
 - ❑ If the pointer does not move while playing a disc, press **Ctrl+Alt+Delete** simultaneously to stop playback and restart the computer.
 - ❑ If you are still experiencing problems, make sure another mouse was not installed.
 - ❑ You may need to use your supplied Application Recovery CD(s) to reinstall the touch pad or mouse drivers. See “Using the Application Recovery CD(s)” on page 40 for more information.

Support Options

If you have questions about your computer or the preinstalled programs, refer to the following sources for answers in the sequence listed below.

1 VAIO® Computer User Guide

The online VAIO® Computer User Guide and the printed VAIO® Computer Quick Start provide information on how to maximize your computer capabilities and solve common problems.

2 Software Manuals and Online Help Files

The software preinstalled on your computer may come with an online manual. These manuals are stored on the hard disk drive as online Help files. You can find the Help files from the Help menu under the specific software application. Some software programs may come with a printed manual.

3 Operating System Online Support

Your computer comes preinstalled with Microsoft® Windows®. For operating system support, you can access Microsoft® customer support at: <http://support.microsoft.com/directory/>.

4 VAIO Support Agent

You can find VAIO Support Agent by clicking Start and selecting Help and Support. Using advanced diagnostic technology, Sony's VAIO Support Agent runs scheduled protections of your programs, network settings, and other important software settings. When your software is protected, you can use VAIO Support Agent to repair software problems by restoring your software to any of the previously protected states.

5 Sony Computing Support

This service provides instant access to information on commonly encountered problems. Enter a description of your problem and the Knowledge Database searches for the corresponding solutions online. You can access Sony Computing Support at: <http://www.sony.com/pcsupport>.

Program Support Information

- Sony Service Center

Adobe® Acrobat® Reader®, Photoshop® Elements, Premiere® LE (Adobe Systems Inc.)

Web site	http://www.adobe.com/
e-mail	techdocs@adobe.com
telephone	206-675-6126 (fee-based support)
fax	206-628-5737
hours	M-F, 6 A.M.-5 P.M. (Pacific time)

America Online® (America Online, Inc.)

Web site	http://www.aol.com/
telephone	800-827-6364
hours	7 days a week, 24 hours a day

AT&T WorldNet® Service (AT&T Corp.)

Web site	http://help.att.net
----------	---

Drag'n Drop CD/DVD (DigiOn, Inc., and Easy Systems Japan Ltd.)

Web site	http://www.easy.co.jp/dde/sony/tosupportne.html
----------	---

EarthLinkSM Total Access® (EarthLink, Inc.)

Web site	http://support.earthlink.net/
e-mail	support@earthlink.net
telephone	800-890-5128 or 800-890-6356
hours	7 days a week, 24 hours a day

PC-cillin® (Trend Micro, Inc.)

Web site	http://www.antivirus.com/pc-cillin/support/
telephone	510-859-0308; 900-820-8324 ¹
hours	M-F, 8 A.M.-5 P.M. (Pacific time)

1 Support from 510-859-0308 is free of charge, but subject to delays. Support from 900-820-8324 is fee-based, but offers immediate response.

Quicken® 2002 New User Edition (Intuit Inc.)

Web site	http://www.intuit.com/support
telephone	900-555-4932; 800-644-3193 ¹
hours	M-F, 5 A.M.-5 P.M. (Pacific time)

1 Support from 900-555-4932 is fee-based. Support from 800-644-3193 is automated and free of charge.

QuickTime® (Apple Computer, Inc.)

Web site	http://www.apple.com
telephone	800-275-2273
hours	M-F, 6 A.M.-6 P.M. (Pacific time)

RealOne™ Player (RealNetworks, Inc.)

Web site	http://service.real.com/rjoptions.html
e-mail	http://service.real.com/help/call.html (online email form)

Sony Applications (Sony Electronics Inc.)

Web site	http://www.sony.com/pcsupport
telephone	888-4-SONY-PC (888-476-6972) ¹
hours	7 days a week, 24 hours a day

1 Support from 1-888-4-SONY-PC is free of charge for 90 days after the original date of purchase.

**Windows® Operating System, Word, XP Professional, XP Small Business
(Microsoft Corp.)**

Web site	http://www.sony.com/pcsupport
telephone	888-4SONYPC (888-476-6972) ¹
hours	7 days a week, 24 hours a day

1 Support from 1-888-4-SONY-PC is free of charge for 90 days after the original date of purchase.

WinDVD® (InterVideo, Inc.)

Web site	http://www.intervideo.com
telephone	510-651-0888

Yahoo! (Yahoo! Inc.)

Web site	http://help.yahoo.com/
----------	---

Sony Service Center

For the Sony Service Center nearest you, call 1-888-4-SONY-PC (1-888-476-6972) or find Sony Customer Service on the Web at <http://www.ita.sel.sony.com/support>.

Caring for Your Computer

This section provides information on how to safely use your Sony computer.

- ❑ Storing Your Computer
- ❑ Using Cables and Connections
- ❑ Cleaning Your Computer
- ❑ Handling the LCD Screen

Storing Your Computer

- ❑ Do not place your computer in a location subject to:
 - ❑ Heat sources, such as radiators or air ducts
 - ❑ Direct sunlight
 - ❑ Excessive dust
 - ❑ Moisture or rain
 - ❑ Mechanical vibration or shock
 - ❑ Strong magnets or speakers that are not magnetically shielded
 - ❑ Ambient temperature of more than 95° F (35° C) or less than 40° F (5° C)
 - ❑ High humidity
- ❑ Do not place electronic equipment near your computer. The computer's electromagnetic field may cause a malfunction.
- ❑ Provide adequate air circulation to prevent internal heat buildup. Do not place your computer on porous surfaces such as rugs or blankets, or near materials such as curtains or draperies that may block its ventilation slots. Leave a space of at least 8 inches (20 cm) behind the back panel of the computer.
- ❑ If the computer is brought directly from a cold location to a warm one, moisture may condense inside your computer. In this case, allow at least one hour before turning on your computer. If any problems occur, unplug your computer, and contact your Sony Service Center.
- ❑ The computer uses high-frequency radio signals and may cause interference to radio or TV reception. Should this occur, move the computer a suitable distance away from the radio or TV.
- ❑ Do not drop the computer or place heavy objects on top of the computer.

Using Cables and Connections

- ❑ Use only specified peripheral equipment and interface cables; otherwise, problems may result.
- ❑ Do not use cut or damaged connection cables.
- ❑ If the telephone company makes a service call to your home or office and determines that your computer is responsible for a problem, the telephone

company may bill you for the service call. Also, if you do not disconnect your computer when it is adversely affecting the telephone line, the telephone company has the right to disconnect your service until you correct the problem.

Cleaning Your Computer

- ❑ Clean the computer with a soft, dry cloth or a soft cloth lightly moistened with a mild detergent solution. Do not use any type of abrasive pad, scouring powder, or solvent such as alcohol or benzine, as these may damage the finish of your computer.
- ❑ If a solid object falls onto the computer or a liquid leaks into the computer, immediately turn off and unplug the computer. It is best to have the computer checked by qualified personnel before you use it again.
- ❑ Avoid rubbing the LCD screen as this can damage the screen. Use a soft, dry cloth to wipe the LCD screen.
- ❑ Always disconnect the power cord before cleaning the computer.

Handling the LCD Screen

- ❑ Do not leave the LCD facing the sun as it can damage the LCD. Be careful when using the computer near a window.
- ❑ Do not scratch the LCD or exert pressure on it. This could cause a malfunction.
- ❑ Using the computer in low temperature conditions may produce a residual image on the screen. This is not a malfunction. When the computer returns to normal temperature, the screen returns to normal.
- ❑ The screen becomes warm during operation. This is normal and does not indicate a malfunction.
- ❑ The LCD is manufactured using high-precision technology. You may, however, see tiny black points and/or bright points (red, blue, or green) that continuously appear on the LCD. This is a normal result of the manufacturing process and does not indicate a malfunction.

Index

A

- AC adapter 26
 - connecting 27
- Application Recovery CD 40

B

- battery
 - charging 26
 - indicator 19
- brightness
 - adjusting 28
- brightness control 28
- buttons
 - left 19
 - power 19
 - right 19

C

- caps lock 19
- computer
 - controls and connectors 19
 - online support 53
 - specifications 16
 - specifications (online) 32
 - troubleshooting 46
 - turning off 35
 - turning on 26
 - unpacking 16
 - updates 32, 33
- connecting
 - dial-up 33
- controls 19
 - brightness 28

D

- DC IN port 20
- dial-up connection 33

E

- Electronic Flyer 32, 33
- Energy Star 5

F

- faxes
 - laws governing 10

H

- handling the LCD screen 59
- hard disk drive
 - indicator 19
- headphone jack 22
- help 31, 45

I

- i.LINK port 21
- indicators
 - battery 19
 - caps lock 19
 - hard disk drive 19
 - Memory Stick media 19
 - num lock 19
 - power 19
 - scroll lock 19
- input devices 9
- installation 58
- interference 9
- internal speaker 19
- Internet connection 33

J

jacks

- headphone 22
- microphone 22

K

keyboard 19

L

LCD screen

- handling 59
- locating 19
- troubleshooting 49

M

maintenance 59

manual 31

Memory Stick media

- indicator 19
- slot 21

microphone jack 22

modem

- laws governing 10

monitor (VGA) port 20

mouse

- troubleshooting 50

N

Network (Ethernet) port 20

network connector 20

num lock 19

O

online support 53

online user guide 31

output devices 9

P

PC Card slot 21

phone

- laws governing 10

ports

- DC IN 20
- i.LINK 21

USB 20, 21, 22

VGA (monitor) 20

power

- indicator light 19

power button 28

power source 26

programs

- locating 38

R

radio interference 9

Recovery CDs 40

regulatory information 8

restoring data 40

S

scroll lock indicator 19

shutting down computer 35

software

- locating 38
- support information 54

Sony Service Center 56

specifications 16

specifications (online) 32

starting computer 26

startup problems 36

support

- software 54
- Sony 45

System Recovery CD 42

T

technical support 45

touch pad 19

- troubleshooting 50
- using 29

troubleshooting 46

- LCD screen 49

- mouse and touch pad 50

- startup 36

turning off computer 35

turning on computer 26

TV

interference 9

U

unpacking the computer 16

updates 32, 33

USB port 20, 21, 22

user guide 31

V

VGA (monitor) port 20

<http://www.sony.com/vaio>