

Charging the Battery Pack

- 1) Close the LCD monitor to turn off the camera.
- 2) Attach the battery pack by sliding it down until it locks in place.

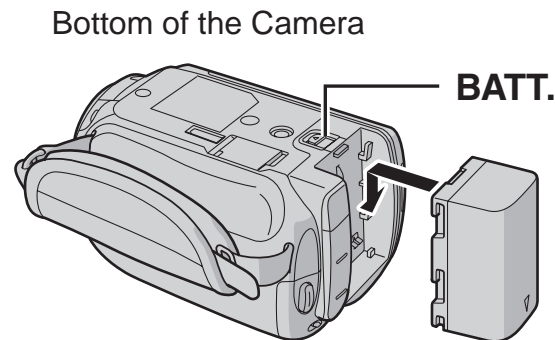

- 3) Connect the AC adapter.

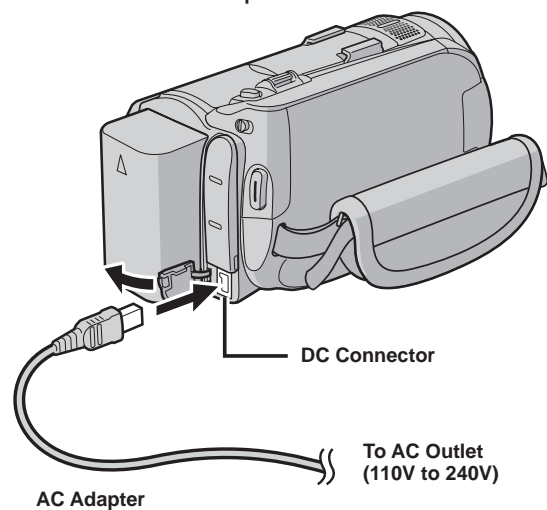

GZ-HD40/HD30: The battery will take 160 minutes to completely charge.

GZ-HD10: The battery will take 90 minutes to completely charge.

The lamp will blink indicating the battery is in the charging process. The lamp will turn off when the battery is completely charged.

Using Set Lever

• How to change settings using Set Lever

Select an item from the menu list on the menu screen.

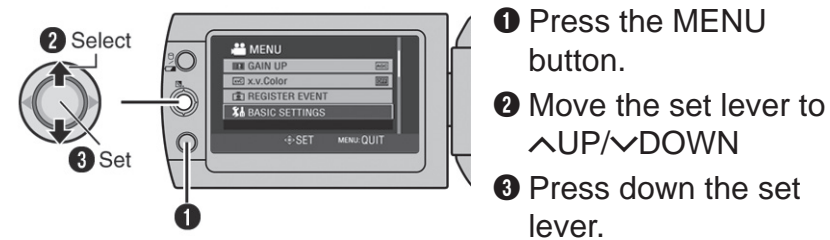

• How to playback your videos using Set Lever.



- 1) Press the PLAY/ REC button to display thumbnails on the screen.
- 2) Highlight thumbnail using set lever and press down the set lever to play.

• Operations during Playback

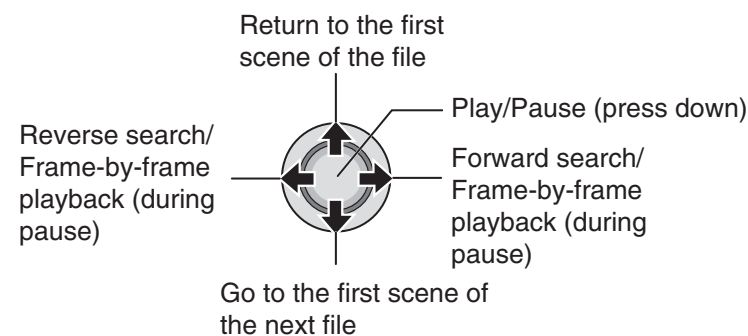

During forward/reverse search, moving the set lever to </> alters the search speed (maximum 60x).

Recording Your Memories

Preparation:

- 1 Open the LCD monitor to turn on the Camera.
- 2 Slide the mode switch to select (video or still image) mode.
- 3 Press the PLAY/REC button to set on recording mode.

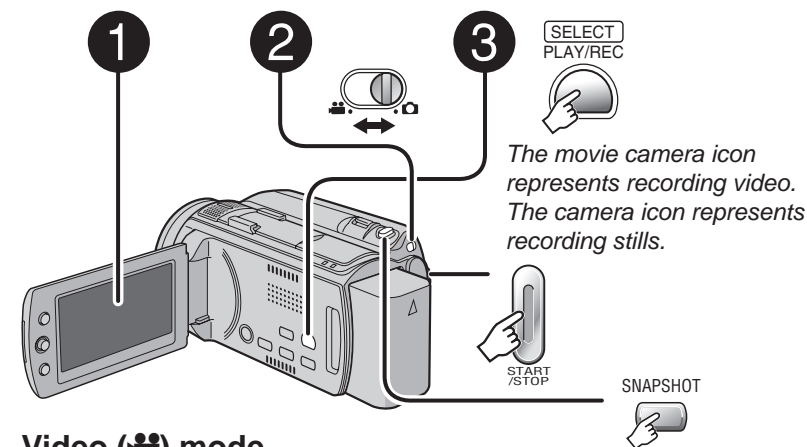

Video (🎥) mode

Press the START/STOP button to start or stop recording.

- You can take pictures during video recording only by pressing SNAPSHOT button. (Up to 3 times in a row)

Still image (📷) mode

Press the SNAPSHOT button to take pictures.

To view the video or image you just recorded, press QUICK REVIEW button.

- During the preview you can delete the video or image by pressing DELETE button.

Video features to set in menu are:
Quality [AVCHD format (MP, SP, LP), MPEG-2 TS format (MP, SP)*], Zoom, DIS, x.v.Color.

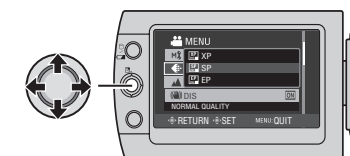

Digital Still features to set are:
Quality and image size.

* MPEG-2 TS format: GZ-HD40/30 only

How to Install the Included Software

- 1) Load the supplied CD-ROM into the computer's CD/DVD drive. The set up screen should appear to guide you through the process. If not, double click the CD-ROM icon (in My Computer).

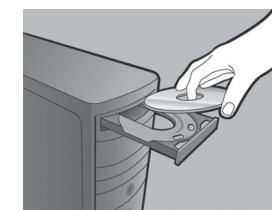

- 2) Click Easy Installation to start.

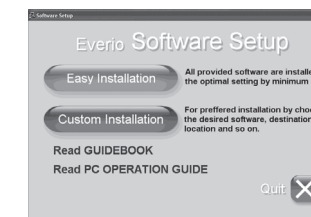

- 3) Now click yes to start InstallShield Wizard.

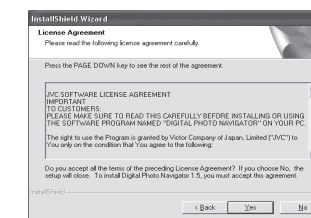

- 4) Choose your desired language.



- 5) Click yes to start software installation.

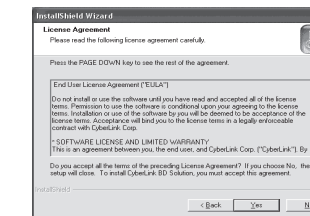

- 6) Click Finish.



- 7) Connect the USB Cable to both PC and Everio Camcorder.

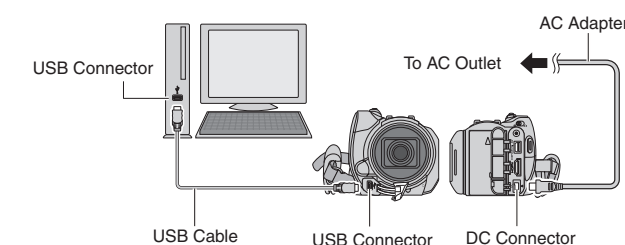

JVC

The Perfect Experience

Customer Service
TOLL FREE: 1-800-252-5722

For our online tutorials please visit:
<http://camcorder.jvc.com/tutorials.jsp>

Register your EVERIO online at:
REGISTER.JVC.COM
and receive a special offer.

JVC Company of America
A Division of JVC Americas Corp.
1700 Valley Road, Wayne, NJ 07470
www.jvc.com

LYT1962-001A
0608MKH-AL-OT

File Backup

Direct Backup

- 1) After connecting USB to and AC adapter to camera and PC open LCD to turn camera on.
- 2) On the camera: press DIRECT BACK UP and PowerCinema will start.
- 3) On the PC: file copy starts. When the progress bar disappears, the process is complete.



File Backup (PC and Mac) without using software

- 1) Connect camera to PC using the USB cable.
- 2) Open the LCD monitor to turn on the camera.
- 3) Create a folder to backup up files into.
- 4) On the camera: move the set lever to select Playback on PC then press down the set lever.

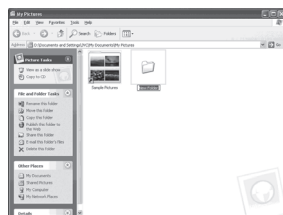

- 5) On the PC: double click EVERIO_HDD or EVERIO_SD
- 6) Select the folder that you want to backup. Drag and drop it in to the folder you created in (step 3).

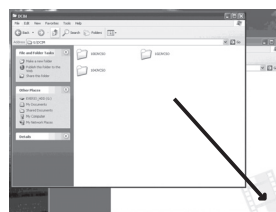
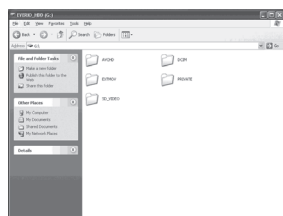

AVCHD: This folder contains all your video files in AVCHD format.

SD_VIDEO: This folder contains all your video files in MPEG-2 TS format. (GZ-HD40/30 only).

DCIM: This folder contains all your still images.

Playing Your Memories on a TV

Preparation:

Turn off both camera and TV.

- 1) Plug in the optional HDMI cable to the camera and the TV.
- 2) Turn on the camera and the TV.
- 3) Slide the mode switch to select Video or Still Image Mode
- 4) Press the PLAY/REC button to put the camera in playback mode.
- 5) Move the set lever to select the desired thumbnail for video or still image playback. Then press down the set lever.

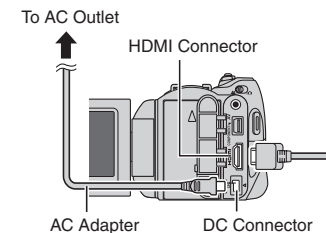

HDMI Cable (optional)

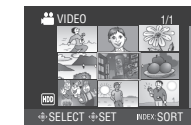
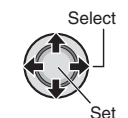
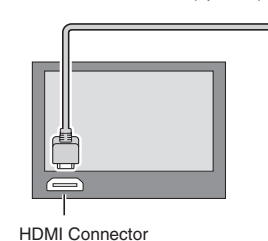

<NOTE>

- When connecting to a 1080p compatible TV, set [HDMI OUTPUT] to [AUTO1]. When this is set, 1080p appears at the top of the display.
- When the video was recorded with x.v.Color™ set to [ON], change the x.v.Color™ setting on TV. For details, refer to the TV's instruction manual.

JVC
The Perfect Experience

Everio

Easy Start up Guide

This easy start up guide is designed to navigate you to using your new Everio quickly. Please refer to the owner's manual for a detailed listing of features.

For our online tutorials please visit:
<http://camcorder.jvc.com/tutorials.jsp>