

SAFETY IS EVERYONE'S RESPONSIBILITY. ALL DACOR APPLIANCES ARE DESIGNED AND CONSTRUCTED TO GIVE YOU MANY YEARS OF SAFE OPERATION. THE OPERATION WILL BE FURTHER ENHANCED IF PROPER CARE AND JUDGEMENT ARE EXERCISED IN THE USE AND MAINTENANCE OF THIS APPLIANCE.

IMPORTANT INFORMATION

- Operating Instructions
- Care and Cleaning Instructions
- Safety Tips



WARNINGS:

Must be followed carefully to avoid personal injury or damage.



NOTES:

Contains helpful hints and tips.

Please Read and Save Before Using Your DKEC

Place Serial Number Label Here



Dear DACOR Consumer,

Congratulations! You have purchased the very latest in kitchen appliances. Your new DACOR product offers features, styling and performance not found in any other appliance.

Please read this manual before operating your new appliance. It is imperative that you read the IMPORTANT INSTRUCTIONS section and become familiar with the controls and procedures to understand the full potential of this product.

All DACOR appliances are designed and manufactured to meet the highest quality standards. Each unit is thoroughly tested. Should you have a problem, however, please first check the PROBLEM SOLVING section in this manual. This section contains a checklist of possible problems and solutions that may save you the time and expense of an unnecessary service call.

If you cannot readily find the solution to the problem, please contact your nearest DACOR Authorized Service Representative. In the unlikely event they are unable to solve your problem to your satisfaction, please contact DACOR Customer Service.

Web site: www.dacor.com

Phone: (800) 793-0093

Fax: (626) 441-9632

Business Hours: 7:30 A.M. to 4:00 P.M. Pacific Time

DACOR Customer Service
1440 Bridge Gate Dr.
Diamond Bar, CA 91765

Thank you for selecting DACOR for your home. We are committed to developing products that provide years of excellent performance and enjoyment to our customers.

Sincerely,

S. Michael Joseph
Chairman/CEO

TABLE OF CONTENTS	1
Purpose of this Manual	1
Product Registration.....	1
IMPORTANT SAFETY INSTRUCTIONS	1-2
General Warnings and Cautions	2
Protection Against Electrical Shock.....	2
Information About Repair Service	2
GETTING STARTED	3-5
Setting Up Your DKEC	3
Installing the Batteries.....	3
Connecting a TV Cable or Antenna.....	3-4
Connecting an S-Video Source.....	4
Connecting a Camera, VCR, or Video Game	4
Connecting the FM Radio Antenna	4
Connecting to the Internet.....	4
Wired Broadband Connectivity.....	4
Wireless Broadband Connectivity	4
Dial-Up Connectivity.....	4
Connecting Other Devices	5
Printer.....	5
External Speakers.....	5
Connecting the power	5
USING THE DKEC CONTROLS	5-7
Front Panel.....	5
LED Indicator	5
Remote and Keyboard	5-6
Mode and Power Buttons.....	5-6
Options Button	6
Television Mode Buttons	6
Internet Mode Buttons.....	6
DVD & CD Mode Buttons.....	6
Adjusting the Image and Sound	7
Stylus & Touch Screen	7

USING THE DKEC MODES	7-11
Television Mode	7
Choosing the Television Signal Source... 7	
Programming the Television Channels... 7	
Changing Channels.....	7
DVD & CD Mode	8
Playing DVD and CDs.....	8
Internet Mode	8-10
Configuring Connection Settings.....	9
Configuring Browser Settings.....	9
Browsing the Internet	9-10
Radio Mode.....	10
Finding Radio Stations	10
Managing Radio Stations	10
Video Mode	10
CARING FOR YOUR DKEC	10-12
Cleaning the DKEC	10
Getting Help	10
Troubleshooting	11
F.A.Q.'s.....	12
ADDITIONAL INFORMATION	13-14
Accessories.....	13
Privacy Policy.....	13
Personal Identification Policy	13
Privacy of Children	13
Other Web Sites.....	13
Security Information	13
Specifications	13
FCC Statement	14
PRODUCT WARRANTY	14
INDEX	15-17
END USER LICENSE AGREEMENT	18-19

Purpose of This Manual

This **Use & Care Manual** is designed to enable you to properly operate and maintain your new kitchen entertainment center. Please keep this manual handy for easy access and quick reference.

Additional information may be requested by e-mailing, writing or phoning the DACOR Customer Service Department. The address and phone number of this department are listed on the inside front cover of this manual.

Important Safety Instructions

When using the DKEC, observe these basic precautions to reduce the risk of personal injury or equipment damage.

Before using the DKEC:

1. Read and understand all DKEC instructions.
2. Follow all warnings and cautions on the product and in these operating instructions.
3. Do not use the DKEC for anything other than its intended use.

Warnings and Cautions

The following examples demonstrate warning and caution statements found within this document. Read and follow all warnings and cautions.

 **WARNING:**

Warning statements warn of hazards or unsafe practices that could result in serious personal injury or death.

 **CAUTION:**

Caution statements warn of hazards or unsafe practices that could result in minor personal injury or damage to the product.

If you received a damaged product, immediately contact your dealer or builder. Do not install or use a damaged appliance.

Product Registration

 Please enter the information requested in the spaces provided below. This information will be required in the unlikely event that a service call becomes necessary:

Model No. _____ Serial No. _____

Date Purchased _____ Date Installed _____

Purchased From _____

Address _____

Phone _____

General Warnings and Cautions

The following general hazards could result in personal injury or product damage. Specific warnings and cautions are found in relevant sections of the operating instructions.

1. **Read the instructions.** All safety and operating instructions should be read before operating the DKEC.
2. **Retain the instructions.** The safety and operating instructions should be retained for future reference.
3. **Heed warnings.** All warnings on the product and in the operating instructions should be adhered to.
4. **Follow instructions.** All operating instructions should be followed.
5. **Cleaning.** Unplug the DKEC from the wall before cleaning it. Do not use liquid cleaners or aerosol cleaners. Clean the unit with a damp cloth.
6. **Attachments.** Do not use attachments which are not recommended by the manufacturer.
7. **Do not use the unit near water.** For example, near a bath tub, wash bowl, kitchen sink, or laundry tub; in a wet basement; or near a swimming pool; and the like.
8. **Carts and Stands.** The DKEC should be placed on a cart or stand designed to securely support the weight of the unit. When mounted on a cart or stand, the DKEC should be moved carefully. Sudden stops, excessive force, or uneven surfaces may cause the cart to overturn.



Cart Mounting

9. **Accessories.** Do not place this product on an unstable cart, stand, tripod, bracket, or table. The product may fall causing serious injury to a child or an adult and serious damage to the product.

Protection Against Electric Shock

1. **Power sources.** This product should only be operated from the type of power source indicated on the marking label. If you are not sure of the power supply to your home, consult your product dealer or local power company.
2. **Grounding or polarization.** This product is equipped with a three-wire grounding-type plug, a plug having a third grounding pin. This plug will only fit into a grounding type power outlet. This is a safety feature. If you are unable to insert the plug into the outlet, contact your electrician to replace the obsolete outlet. Do not defeat the safety purpose of the grounding-type plug.
3. **Power-cord protection.** Power-supply cords should be routed so that they are not likely to be walked on or pinched by items placed upon or against them, paying particular attention to cords at plugs, convenience receptacles, and the point where they exit from the product.
4. **Outdoor antenna grounding.** If an outside antenna or cable system is connected to the product, be sure the antenna or cable system is grounded so as to provide some protection against voltage surges and built-up static charges. Article 810 of the National Electrical Code, ANSI/NFPA 70, provides information with regard to proper grounding of the mast and supporting structure, grounding of the lead-in wire to an antenna discharge unit, size of grounding conductors, location of antenna-discharge unit, connection to grounding electrodes, and requirements for the grounding electrode.
5. **Lightning.** For added protection for this product during a lightning storm, or when it is left unattended and unused for long periods of time, unplug it from the wall outlet and disconnect the antenna or cable system. This will prevent damage to the product due to lightning and power-line surges.
6. **Power lines.** An outside antenna system should not be located in the vicinity of overhead power lines or other electric light or power circuits, or where it can fall into such power lines or circuits. When installing an outside antenna system extreme care should be taken to keep from touching such power lines or circuits as contact with them might be fatal.
7. **Overloading.** Do not overload wall outlets, extension cords, or integral convenience receptacles as this can result in a risk of fire or electric shock.
8. **Object and liquid entry.** Never push objects of any kind into this product through openings as they may touch dangerous voltage points or short-out parts that could result in a fire or electric shock. Never spill liquid of any kind on the product.

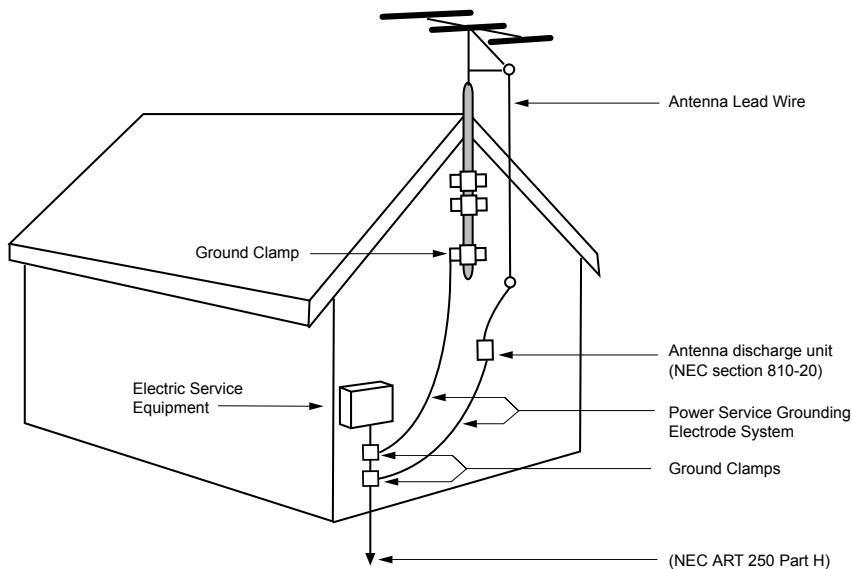

Example of Antenna Grounding

Information about Repair Service

1. **Servicing.** Do not attempt to service this product yourself as opening or removing covers may expose you to dangerous voltage or other hazards. Refer all servicing to qualified service personnel.
2. **Damage requiring service.** Unplug this product from the wall outlet and refer servicing to qualified service personnel under the following conditions:
 - a. When the power-supply cord or plug is damaged.
 - b. If liquid has been spilled, or objects have fallen into the product.
 - c. If the product has been exposed to rain or water.
 - d. If the product does not operate normally by following the operating instructions. Adjust only those controls that are covered by the operating instructions as an improper adjustment of other controls may result in damage and will often require extensive work by a qualified technician to restore the product to its normal operation.
 - e. If the product has been dropped or damaged in any way.
 - f. When the product exhibits a distinct change in performance, this indicates a need for service.
3. **Replacement parts.** When replacement parts are required, be sure the service technician has used replacement parts specified by the manufacturer or have the same characteristics as the original part. Unauthorized substitutions may result in fire, electric shock, or other hazards.
4. **Safety check.** Upon completion of any service or repairs to this product, ask the service technician to perform safety checks to determine that the product is in proper operating condition.
5. **Heat.** The product should be situated away from heat sources such as radiators, heat registers, ranges, or other products (including amplifiers) that produce heat.

Getting Started

Welcome to the DKEC system designed specifically for the kitchen. With the DKEC, you can watch television, browse the Internet, play DVDs or CDs, check your Email, and monitor other areas of your home, all from the convenience of your kitchen.

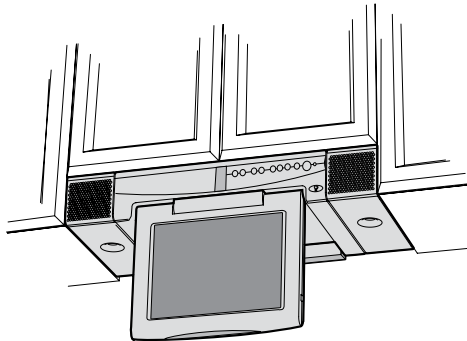

Installed Under Kitchen Cabinets

Setting Up Your DKEC

Before you turn on your DKEC, you will need to install the batteries in the remote and keyboard and set up the connections to support the many features of the DKEC. These connections may include:

- Your television cable or antenna
- Any additional video sources (such as a camera and/or satellite cable)
- The included FM Radio antenna
- A PCMCIA Network card and an Ethernet cable or phone line.

The final thing you should do is plug in the power cord before turning on the device.

Installing the Batteries

The remote requires two AAA batteries (supplied), and the keyboard requires two AA batteries (supplied). Alkaline batteries are recommended.

To install the batteries for your remote:

1. On the back of the remote, remove the battery cover by loosening the small screw in the center of the panel. Keep the attached washer with the screw.
2. Install two AAA batteries, ensuring that the polarity (+ and -) on the batteries matches the + and - markings in the battery compartment.
3. Reattach the battery cover, making sure that the cover is seated.
4. Insert the screw, with the washer still attached, and tighten the screw until it is snug.

CAUTION:

Do not overtighten the screw. You may damage the washer and the remote will no longer be washable.

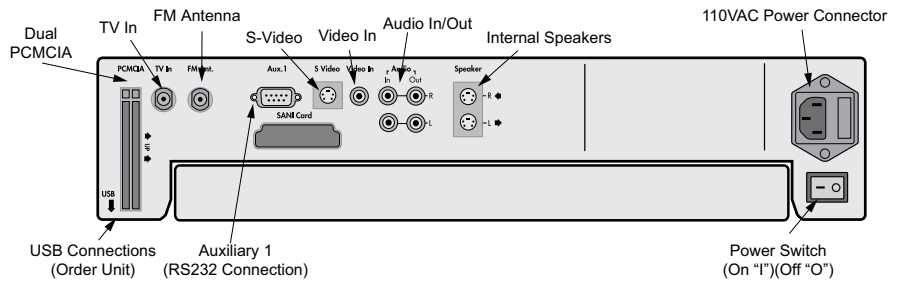

Rear Panel of the DKEC

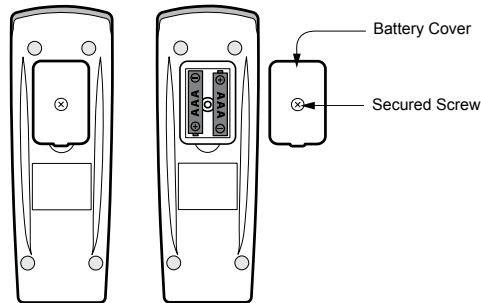

Remote Battery Installation

To install the batteries for your keyboard:

1. On the back of the keyboard, remove the battery cover by loosening both large screws on either end of the battery panel. Keep the attached washers with each screw.
2. Remove the rubber gasket.
3. Install two AA batteries, ensuring that the polarity (+ and -) on the batteries matches the + and - markings in the battery compartment.
4. Reattach the rubber gasket, ensuring that the four nubs on the underside of the gasket are pressed firmly into the holes in the battery compartment. This is important to keep the keyboard washable.
5. Reattach the battery cover, ensuring that it is seated properly.
6. Insert the screws, with the washers still attached, and tighten the screws until they are snug.

NOTE:

If the screws won't tighten all the way, or the battery cover isn't flush with the keyboard bottom, make sure the rubber gasket is firmly inserted into the battery compartment.

CAUTION:

Do not overtighten the screws. You may damage the washers and the keyboard will no longer be washable.

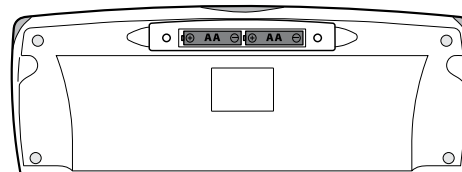
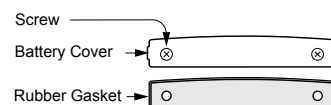

Keyboard Battery Installation

Connecting a TV Cable/Antenna

The DKEC is a 125-channel, cable-ready, stereo television. To use your DKEC as a television, you must first connect it to a TV signal source.

To connect the TV cable:

- Screw the existing television cable into the **TV In** connection on the back of the DKEC. If space is limited, use the supplied right angle F-connector.

To connect a TV antenna:

- Use an antenna with a connector designed to fit on to a coaxial cable connection like the one for the **TV In** connection at the back of the DKEC.

Satellite or Digital Cable Television Service

The DKEC supports satellite and digital cable television service; however, when using satellite service, the DKEC remote or keyboard cannot be used to change channels. Continue to use your existing remote control with the set-top box.

Your satellite signal may come in through the standard TV-In coaxial connection. See To connect the TV cable in the previous section.

Alternately, you may wish to take advantage of the higher quality of Satellite or Digital Cable by using the S-video connection. You can connect digital cable or a Direct Broadcast Satellite (DBS) system, such as DirectTV or DISH, to your DKEC. See To connect an S-Video source in the next section.

NOTE:

If you use an S-Video connection from your Satellite or Digital cable, you will need to use Video Mode to watch television. See Video Mode on page 10. The DKEC remote or keyboard cannot be used to change channels in Video Mode. Continue to use your existing remote control with the set-top box.

Connecting an S-Video Source

S-Video (Super-Video) divides video information into two separate signals for a sharper, higher-quality image. Most new video cameras, camcorders, VCRs, and game machines include an S-Video jack.

The DKEC can support one S-Video signal that can be viewed in Video Mode. Press the Video mode button repeatedly to toggle between the S-Video signal and a composite signal.

You can also use the S-Video jack for Satellite or Digital Cable. For more information see Video Mode on page 10.

To connect an S-Video source:

- Plug an S-Video cable from the camera, VCR, game machine or satellite/cable receiver into the S-Video connection on the back of the DKEC.
- Insert audio cables from the S-Video device into the Audio In connections in the back of the DKEC.

Connect Camera/VCR/Video Game

Using the DKEC Video Mode, you can monitor another area of your home where a video camera is installed, play a video game or view a video tape in a VCR using a composite signal. Since Video Mode supports both composite and S-Video sources, you can toggle between the two signals by repeatedly pressing the Video mode button. For more information see Video Mode on page 10.

NOTE:

At this time, Video Mode supports only one Audio source which will continue to play when you toggle between Video signals.

To connect a composite source:

- Plug an RCA cable from a camera, VCR or game machine into the Video In connection on the back of the DKEC.
- Insert audio cables from the device into the Audio In connections on the back of the DKEC.

Connecting the FM Radio Antenna

You can use the DKEC to listen to your favorite local FM radio stations in FM Radio Mode. Enclosed with your DKEC FlipScreen is an FM radio antenna.

To connect the FM Antenna:

1. Make sure the DKEC unit is powered off by checking the LED on the front of the unit – it should be black and unlit. The power can be turned off using the red rocker switch on the back of the unit.
2. Remove the antenna from the DKEC packaging
3. Attach the antenna by screwing it onto the **FM Antenna** coaxial socket on the back of the screen.

Connecting to the Internet

The DKEC supports three types of Internet connectivity using a PCMCIA Network card. Depending upon which type of card is used, you can connect using:

- **Wired (Ethernet) Broadband.** Your broadband service may be provided over DSL or cable modem.
- **Wireless (802.11b) Broadband.** This requires a wireless network.
- **Dial-Up Internet Access.** The dial-up Internet services must not require the installation of additional software.

Wired Broadband Connectivity

Your DKEC accessories box includes a PCMCIA Network card which supports an Ethernet connection to a DSL or cable modem. Because the DKEC uses the Windows CE .NET platform, we cannot ensure that an alternate network card will work. Please contact customer support for a current list of alternate supported cards.

The following instructions assume that your DSL/cable modem and home network are already installed and configured. For more detailed Internet Connection information, refer to the Installation Manual.

To connect using a Wired Broadband (DSL or cable modem) connection:

1. Insert the networking card, with the card's label facing toward the center of the device, into the PCMCIA slot on the back of the DKEC.
2. Insert an Ethernet cable from your home network into the Ethernet jack on the PCMCIA card.
 - In most cases, no further connection settings are required. If no connection is established when you first go to Internet Mode, see Configuring a Wired Broadband Connection on page 8 for more information.

Wireless Broadband Connectivity

There are two ways to connect the DKEC to your wireless network:

- Using an approved wireless PCMCIA Network card; or,
- Using a wireless bridge connected to the ethernet PCMCIA card.

Because the DKEC uses the Windows CE .NET platform, we cannot ensure the compatibility of all wireless network cards. Please contact customer support for a current list of supported wireless PCMCIA networking cards.

To connect using a wireless PCMCIA card:

1. Insert a wireless networking card, with the label facing the center of the device, into the PCMCIA slot on the back of the DKEC.
 - Further configuration settings are required to connect to your wireless network. See Configuring a Wireless Connection on page 8.

To connect using a wireless bridge:

1. Insert the included networking card into the PCMCIA slot on the back of the DKEC.
2. Connect the wireless bridge to your home PC and configure it following the directions provided by the manufacturer of the bridge.
3. When the wireless bridge is properly configured for your wireless network, disconnect it from your home PC.
4. Insert one end of an Ethernet cable into the bridge, and one end into the Ethernet jack on the PCMCIA card.
 - In most cases, no further connection settings are required. If no connection is established when you first go to Internet Mode, see Configuring a Wired Broadband Connection on page 9 for more information.

Dial-Up Connectivity:

To connect to a dial-up Internet provider, you will need to use a PCMCIA modem card equipped with an RJ-11 phone jack.

NOTE:

The DKEC does not currently support any ISPs that require downloading or installing software. At the time of the printing of this manual, AOL is an example of an ISP that will not work with the DKEC because of their download requirements, although you can still retrieve AOL mail using the DKEC Internet browser.

To connect using a Dial-Up connection:

1. Insert the modem card, with the card's label facing toward the center of the device, into the PCMCIA slot on the back of the DKEC.
2. Plug the analog telephone line into RJ-11 jack on the modem card.
 - Further configuration is required. See Configuring a Dial-Up Connection on page 9.

CAUTION:

Do not connect the DKEC to a digital phone line. Severe damage can occur to the DKEC.

Digital Versus Analog Phone Lines

Two types of phone lines are commonly available: analog and digital. Most homes are wired with analog phone lines. Digital lines are usually found in commercial and industrial sites. However, newer homes, apartments, and condominiums may be prewired with high-speed digital phone lines.

All modems, including that in a PCMCIA networking card, require an analog phone line. Connecting a modem to a digital line will cause permanent damage to the modem.

To determine which type of line you have, look at the phone line connector. An analog phone connector is terminated with 2 or 4 copper wires. A digital connector is terminated with 6 or 8 copper wires. If you cannot determine for certain which type of phone line you have, contact your phone service provider.

If You Have a Digital Phone Line

In commercial buildings, apartment buildings, and condominiums, digital phone lines usually come from a telephone switch or PBX located in the building. These telephone switches will also support analog phone lines. The telephone system administrator may be able to arrange for an analog phone line to be brought to your location from the local telephone switch.

If you live in a house wired with a digital line, you can arrange with your phone company to have an analog line brought into your home. In addition, many digital phone manufacturers offer inexpensive adapters that plug into the digital phone line and convert it to an analog line. These adapters usually work best at lower modem speeds.

Connecting Other Devices

Printer

You can print Web pages with a compatible printer. Connect a printer to one of the USB ports on the bottom of your DKEC. For more information on using printers with your DKEC, visit www.dacor.com.

External Speakers

You can route sound through a home stereo or other amplified audio system. Connect your system to the Audio Out connections on the rear panel of the unit. For more information, refer to the instructions that were provided with your audio system.

Connecting the Power

The DKEC operates with a current of 110 V AC, 60Hz. A 110 V AC power cord is supplied with your DKEC.

To connect the power:

1. Ensure that the power switch on the back panel is in the off position ("O" is depressed).
2. Plug the supplied AC power cord into the AC connector on the rear panel of the DKEC.
3. Plug the other end into a 110 V AC wall socket.
4. Turn the power switch to the on position ("I" is depressed). The LED indicator on front panel shines red.







Using the DKEC Controls

Before turning on your DKEC for the first time, take a moment to familiarize yourself with the controls. When you turn your DKEC on for the first time, it will be in Television Mode. See Television Mode on page 7 for information on programming the television channels.

Front Panel

The front panel of the DKEC has controls and indicators that are attractively integrated into the design.

The buttons on the front panel do the following:

-  **Eject.** Ejects the disc tray. Press again to retract tray.
-  **Play/Pause.** Begins, pauses, or resumes the playing of a disc.
-  **Channel +/-.** Press - to select the next lowest channel. Press + to select the next highest channel.
-  **Volume +/-.** Press - or + to decrease or increase the volume.
-  **Mute.** Turns off all sound from the screen. To restore sound, press again or press Volume +/-.
-  **Options.** Displays onscreen menus for your current mode.
-  **Power On/Off.** Turns your DKEC on. Press again to put DKEC in Sleep Mode.

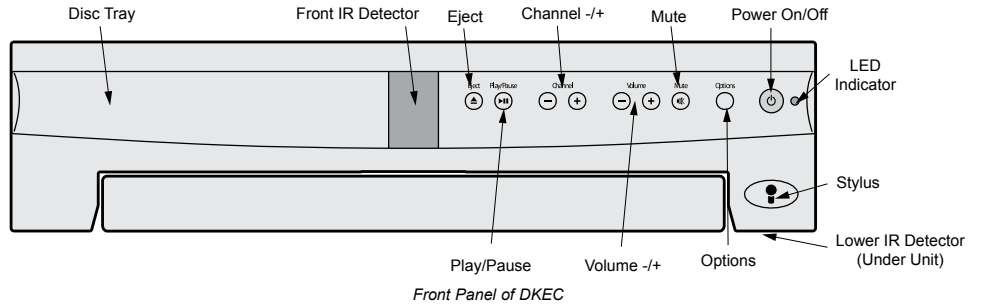

LED Indicator

The LED indicator on the front panel of the DKEC tells you what the current power status is for your DKEC.

When the LED is...	The DKEC is...
Unlighted	Turned off at the main power switch on the rear panel of the unit.
Red	In Sleep Mode. Sleep Mode occurs when the main power switch is on, but the DKEC is turned off at the remote, keyboard, or front panel Power On/Off button.
Flashing	Turning on or resetting.
Green	On.

Remote and Keyboard

The remote and keyboard have similar controls—what works on one will work on the other. The image below shows the layout of the remote buttons. The layout for the keyboard is similar unless otherwise noted.

The buttons on the remote and keyboard are laid out in sections and are color coded. The following table shows which colors are associated with the various modes.

Mode	Color of Buttons
Television Mode	Purple
Internet Mode	Orange
DVD & CD Mode	Green

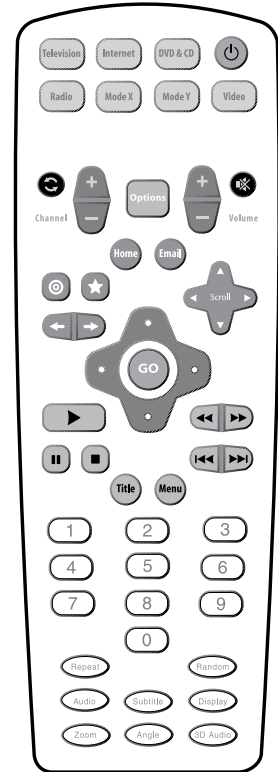

The DKEC Remote

Mode and Power Buttons

The mode buttons and power button are located at the top of the remote and along the top of the keyboard.

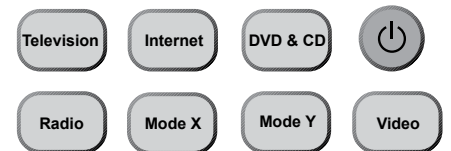

Mode and Power Buttons

The mode and power buttons do the following:

-  **Power** Turns the DKEC on. Press again to put DKEC in Sleep Mode. (See LED Indicator.)
- Television Mode** Puts the DKEC into Television Mode so that you can watch your favorite shows.
- Internet Mode** Puts the DKEC into Internet Mode so that you can connect to the Internet.
- DVD & CD Mode** Puts the DKEC into DVD & CD Mode so that you can watch a DVD or play a CD.

Radio Mode Puts the DKEC into Radio Mode so that you can listen to your favorite FM Radio stations.

Video Mode Puts the DKEC into Video Mode so that you can monitor another place in your home or access an s-video signal. Press the Video button repeatedly to switch between the S-Video and composite signals.

Mode X This key is intentionally unassigned so that it can be available for future updates.

Mode Y This key is intentionally unassigned so that it can be available for future updates.

Options Button

You can use the Options button in all modes to display the Options menu for the current mode.

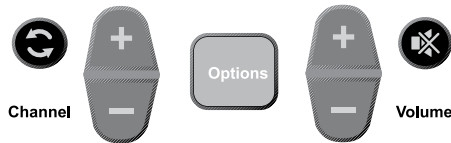

Options, Channel, and Volume Buttons

The television and volume buttons do the following:

Channel +/- Press to select the next highest channel. Press to select the next lowest channel.

Volume +/- Press to increase the volume. Press to decrease the volume.

Last Channel Press to jump to the last viewed channel.

Mute Press to turn off all sound from the DKEC. To resume sound, press again or press Volume +/-.

Internet Mode Buttons

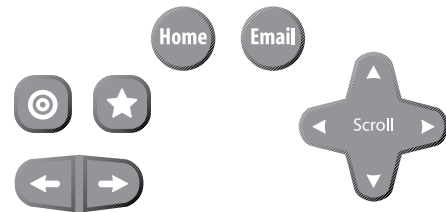

Internet Mode Buttons

The Internet Mode buttons do the following:

Jump to Target Press to move the selection indicator to the target area and back again.

Jump to Favorites Press to display your list of favorite Web sites.

Back Press to return to the previously viewed Web page.

Next Press to advance to the next viewable Web page.

Home Press to return to your home page from anywhere on the Internet. See Configuring Browser Settings on page 9.

Email Press to go to your Web-based Email account. See Configuring Browser Settings on page 9.

Scroll Press to scroll the page up, down, left, or right on the screen.

The directional buttons and the GO button are shown below.



Directional Buttons and GO Button

In Internet Mode, use the directional buttons around the **GO** button to move the colored selection box around the screen to select a link. To follow the link, press **GO**.

In DVD & CD Mode, use the directional buttons to navigate through DVD menus. To select a menu item, press **GO**.

DVD & CD Mode Buttons

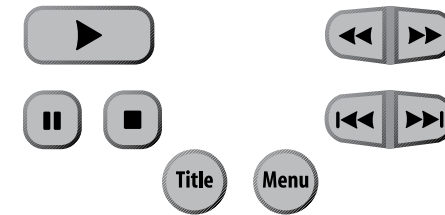

DVD & CD Mode Buttons

The DVD & CD Mode buttons do the following:

Play Press to begin or resume playing a disc.

Pause Press to pause the DVD or CD in its present track. To resume, press .

Stop Press to stop disc play.

Reverse Press once and the disc moves in reverse. Press multiple times to increase the speed. Press to resume normal speed.

Forward Press once and the disc advances. Press multiple times to increase the speed. Press to resume normal speed.

Skip Reverse Press to return to the previous chapter or CD track. Skips to the beginning of the current CD track if partway through it.

Skip Forward Press to advance to the next viewable chapter or CD track.

Title Press to view the title on DVDs (when available).

Menu Press to view the menu on DVDs (when available).

Keyboard Keys

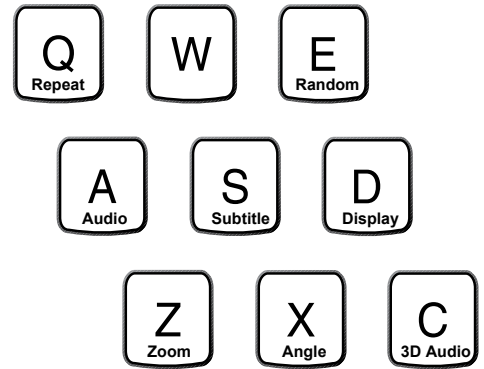

Additional DVD & CD Mode Buttons

Remote Buttons

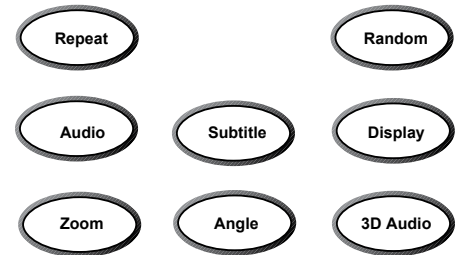

Additional DVD & CD Mode Buttons

These additional DVD & CD Mode buttons do the following:

- **Repeat.** Press to toggle between different repeat modes, such as track (CD Only) or disc (CD & DVD).
- **Random.** Press to have chapters or tracks play in a random order. Press again to cancel random play.
- **Audio.** Press to toggle among available audio tracks on DVDs, such as dubbed languages or director commentary. (Not available on all DVDs.)
- **Subtitle.** Press to display subtitles on a DVD. Press again to toggle among available subtitles and clear from the screen. (Not available on all DVDs.)
- **Display.** Press to toggle between DVD information displays such as time elapsed and time remaining. Press repeatedly to cycle through all functions and clear from the screen.
- **Zoom.** Press to zoom in on scenes. Press again to cancel.
- **Angle.** Press to toggle scenes from different camera angles. (Not available on all DVDs.)
- **3D Audio.** Press to toggle an optional audio mode that can enhance the listening quality of some DVDs and CDs.

Adjusting the Image and Sound

In any mode (see Using the DKEC Modes), you can adjust aspects of the image and the sound that your DKEC produces. Once made, these adjustments are in effect for all modes.

The following table shows which image adjustments are available in each mode:
To adjust the image:

Mode	Brightness	Contrast	Color	Tint (Hue)
TV	•	•	•	•
DVD/CD	•	•	•	
Internet	•			
Video	•	•	•	•

1. With the DKEC turned on, press **Options**.
2. Select **Adjust Image**.
3. Select the image adjustment that you want to make. (See the table above to see which adjustments are available in each mode.)
4. Use the navigation buttons to move the slider, or use the stylus to tap the desired setting.
5. Repeat for other image adjustments.
6. Choose **OK**.

To adjust the sound:

1. With the DKEC turned on, press **Options**.
2. Select **Adjust Sound**.
3. Select the sound attribute that you want to adjust.
4. Use the navigation buttons to move the slider, or use the stylus to tap the desired setting.
5. Repeat for other sound attributes.
6. Choose **OK**.

Stylus & Touch Screen

While in Internet Mode, you can use the stylus to tap links, select items, and scroll pages.

Always use the stylus rather than a finger, fingernail or other implement. The stylus is specially weighted for best results, makes it easier to select smaller links on Web pages, and helps keep the touch screen clean.

To navigate using the stylus:

- Tap a link or button to go to that Web page.
- Tap a check box to mark or clear it.
- Tap a text box to select it.
- Tap the arrow of a drop-down list to display the options, then tap an item in the list.
- Drag a scroll bar to scroll the Web page.

Using the DKEC Modes

The DKEC is a television, DVD & CD player, Internet browser, home video monitor and FM Radio—all in one device. These separate “modes” are explained below.

Television Mode

The DKEC is a 125-channel, cable-ready television. Before you view television channels on your DKEC, you must select the signal source. Also, you can program the television channels that are available in your area.

Choosing the Television Signal Source

For your DKEC to work properly in Television Mode, you need to select the signal source that is plugged into the DKEC.

To select the television signal source:

1. If not already in Television Mode, press **Television**.
2. Press **Options**. The Television Options menu is displayed.

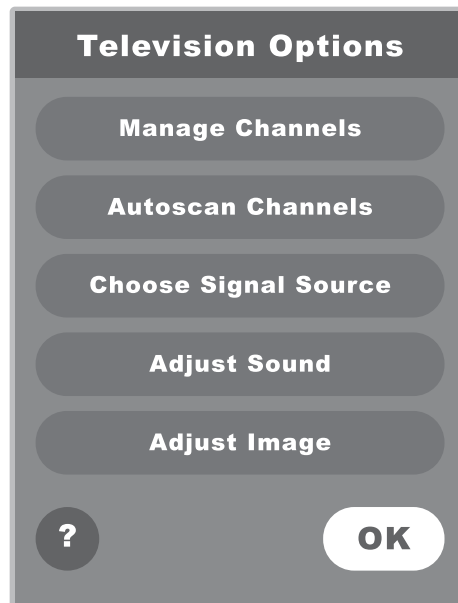

Television Options Menu

3. From the Television Options menu, select **Choose Signal Source**.
4. Select **Cable** or **Antenna** to match the source of the TV signal that you have connected to the DKEC.
5. Choose **OK**.

Satellite Television Service

The DKEC supports satellite television service; however, when using satellite service, the DKEC remote or keyboard cannot be used to change channels. Continue to use your existing remote control with the set-top box.

Your satellite signal may come in through the **TV In** coaxial connection or the **S-Video** jack in the back of the DKEC.

To access a signal from the TV In connection:

- To set a satellite signal source coming in through the TV In coaxial connection, select the **Cable** option when choosing the Signal Source.
- You may also want to remove all the DKEC channels except 3 or 4 (if needed) to prevent the Channel +/- buttons from having any effect.
- Use your existing remote control with the set-top box to change channels.

To access a signal from the S-Video connection:

- To access a satellite (or Digital Cable) signal coming through the S-Video jacks, switch to Video mode to watch television.
- Press the Video mode button repeatedly to toggle between the composite and S-Video video signals.
- Use your existing remote control with the set-top box to change channels.

Programming the Television Channels

The Autoscan Channels feature allows you to easily configure the DKEC to show only the television channels that are available in your area.

To Autoscan for Television Channels:

 **NOTE:**

Do not perform Autoscan if your DKEC is not connected to a television signal source.

1. If not already in Television Mode, press **Television**.
2. Press **Options**. The Television Options menu is displayed.
3. Select **Autoscan Channels**.
4. Choose **OK**.
The DKEC automatically scans for television channels available in your area. This may take a few moments. When the scan is complete, the TV tunes to the first available channel.

Changing Channels

You can change television channels on your DKEC using either of the following methods.

To change channels:

- Using the number keys, enter the channel number that you want to view. After a few seconds, the new channel appears.
–Or–
- Press **Channel +/-** to switch to the desired channel.

 **NOTE:**

Program the channels before using the Channel +/- keys to avoid changing to channels without any content (static). See Programming the Television Channels.

DVD & CD Mode

Playing DVD and CDs

In DVD & CD Mode, the DKEC can play DVDs and music CDs.

To play a DVD or CD:

1. Press **▲** on the front panel of the DKEC to open the disc tray.
2. Place the disc with its label side up onto the tray.
3. Press **▲** to close the tray.
4. The disc will play automatically. DVDs will typically display a menu.

General Commands

The following table lists additional tasks and commands:

To...	Do this...
Stop the disc.	On the remote or keyboard, press ■ .
Pause the disc.	On the remote or keyboard, press .
Resume a paused disc.	On the remote or keyboard, press ▶ .
Move forward or backwards in the disc.	On the remote or keyboard, press ▶▶ or ◀◀ . Press again to increase or decrease the speed backwards or forward. Press ▶ to resume playing the disc.
Automatically repeat the disc.	On the remote or keyboard, press Repeat . Press again to turn off repeat function.
Play the next or previous DVD or chapter.	On the remote or keyboard, press ▶▶ or ◀◀ .
Display DVD menu.	On the remote or keyboard, press Menu .
Watch DVD with subtitles.	On the remote or keyboard, press Subtitle . Press again to turn off subtitles.
Change angle on DVDs that feature different camera angles.	On the remote or keyboard, press Angle . Press again to see other camera angles.
Change zoom level on DVDs.	On the remote or keyboard, press Zoom . Press again to see other zoom options.
Change DVD audio track options.	On the remote or keyboard, press Audio . Press again to see other audio track options.
Go to a specific CD track.	On the remote or keyboard, enter the number of the track, then press GO .
Play the next or previous CD track.	On the remote or keyboard, press ▶▶ or ◀◀ .

Randomize CD tracks

On the remote or keyboard, press **Random**. Press again to turn off random function.

3D Audio

3D Audio is an optional audio setting that may enhance the listening quality of some DVD and CDs.

To listen with 3D Audio:

1. Press **3D Audio**.
2. Press again to turn 3D Audio off.

Internet Mode

You can browse the Internet on your DKEC using Internet Mode. Using the remote, keyboard and touch screen, you can browse web sites, check email and look up useful information in the kitchen. You can specify a default home and email web page for quick access.

Before browsing you may need to configure your Internet connection. If your DKEC was professionally installed, it is most likely already configured for Internet Mode. If it was not, you will need to contact your Internet service provider (ISP) for information needed to configure the DKEC.



NOTE:

You can find more information about configuring an Internet connection in the **DKEC Help**. Press **Help** in **Internet Mode** and select **Connecting to the Internet**.

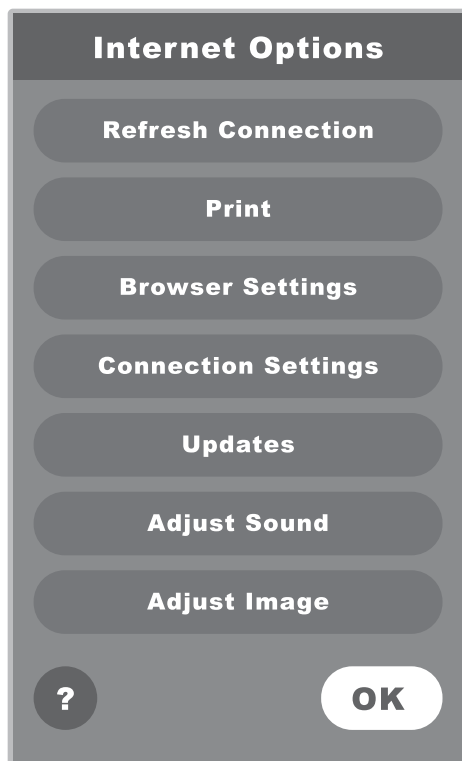

Internet Options Menu

Configuring Connection Settings

The DKEC can connect to the Internet in three different ways:

- Wired (Ethernet) Broadband
- Wireless (802.11b) Broadband
- Dial-Up

Configuring a Wired Broadband Connection

If you've installed the included PCMCIA Network card for a wired (ethernet) Broadband connection, further configuration may not be needed. The DKEC is set by default to support DHCP (Dynamic Host Configuration Protocol), which is suitable for most households. If your Internet Service Provider (ISP) support DHCP, the DKEC should connect automatically when you go to Internet Mode.

However, if you use a Static IP address further information is required to connect. Your ISP will need to provide you with a static IP address, subnet mask, gateway router and DNS servers.

To configure a Broadband connection:

1. Press **Internet** to switch to Internet Mode, then press **Options**.
2. From the Internet Options menu, select **Connection Settings**.
3. Select the **Broadband Settings** button.
4. Select the **Ethernet Type**.
 - Select the **Use DHCP (Auto)** if your ISP supports dynamic host configuration protocol (DHCP).
 - Clear the **Use DHCP (Auto)** checkbox if your ISP does not support DHCP.
5. If needed, enter static IP address, subnet mask, gateway router and DNS servers.
6. Choose **OK**.

Configuring a Wireless Connection

If you are using a wireless network card, you'll need to configure the connection settings the first time you go to Internet Mode. This may include a WEP (Wired Equivalent Privacy) key and other security settings. This may also include additional IP information if you use a Static IP address.

To configure a Wireless connection:

1. In Internet Mode, press **Options**.
2. From the Internet Options menu, select **Connection Settings**.
3. Select the **Wireless Settings** button.
4. Select your home network.
5. If your network requires a WEP key, select the **Security** button, then:
 - a. Select the appropriate security options.
 - b. Enter the WEP key.
 - c. Choose **OK**.
6. If you use a static IP address, select the **IP** button, then:
 - a. Clear the **Use DHCP (Auto)** checkbox.
 - b. Enter static IP address, subnet mask, gateway router and DNS servers.
 - c. Choose **OK**.
7. Choose the **Connect** button.
 - a. If the connection is successful, the Options dialog closes.
 - b. If the connection is not successful, the Options dialog remains open so you can resolve the issue.

Some networks are set up to allow only specific devices to connect based on the device's MAC (Media Access Control) address. You can quickly find the MAC (Media Access Control) address (also known as the physical address) of your wireless card.

To find a card's MAC address:

1. From the Internet Options menu, select **Connection Settings**.
2. Select the **Wireless Settings** button.
3. Select the **IP** button.
The MAC Address of the wireless card is displayed. Write it down so you can enter it when configuring your router for the DKEC.

Configuring a Dial-Up Connection

If you have inserted a modem card, you can enter the information required to dial up to your ISP and log in.

 **NOTE:**

The DKEC does not currently support any ISPs that require downloading or installing software. At the time of the printing of this manual, AOL is an example of an ISP that will not work with the DKEC because of their download requirements, although you can still retrieve AOL mail using the DKEC Internet browser.

To configure a Dial-Up connection:

1. In Internet Mode, press **Options**.
2. From the Internet Options menu, select the **Connection Settings** button.
3. Enter the appropriate information in the **User Name**, **Password**, **Dialing Prefix** (if any), and **ISP Phone #** fields.
4. Select whether you want an audible **Dialing Sound**.
5. Enter a **Disconnect** time limit.
6. Choose **OK**.

Entering Proxy Settings

In rare cases, you may be using a proxy server. Proxy servers are typically found in an office environment. If you know that you are using a proxy server, you'll need to enter proxy settings.

To configure proxy settings:

1. In Internet Mode, press **Options**.
2. From the Internet Options menu, select **Connection Settings**.
3. Choose the **Proxy Settings** button.
4. Select the **Ethernet Type**.

Configuring Browser Settings

Browser Settings are best configured before you start using Internet Mode, so you can use the Email and Home keys on the keyboard or remote.

You can choose what Web page that you want to have as your Home page. You can also select a Web-based Email service, such as AOL Anywhere® or MSN Hotmail® to have as your default Email page.

You can also set the system time and choose your preferred font size.

To configure the browser settings:

1. Press **Internet** to switch to Internet Mode.
2. Press **Options**.
3. From the Internet Options menu, select **Browser Settings**.
4. Select the **Font Size** that you want.
5. Select the **Home Page URL** field.
6. Enter the address of the Web page that you want as your home page.
For example: www.yahoo.com
7. Select the **Email URL** field.
8. Enter the address of the Web page you want as your Email service.
For example: www.hotmail.com
9. Set the current Date and Time.
10. Choose **OK**.

Browsing the Internet

Once you have configured your DKEC for the Internet, you can explore the Internet.

The Selection Box

Unlike a desktop or laptop computer, the DKEC does not have a cursor. Instead, a colored outline or highlight, also known as the selection box, indicates the active element of the screen. Buttons, links to other pages, boxes in forms, and other interactive elements on Web pages are selected when highlighted.

When you select an element on a Web page such as a link, it can be activated by pressing **GO**. When a form box is selected, you can enter text into it.

Using the Stylus

In Internet Mode, you can use the stylus to tap links, select items, and scroll pages.

 **CAUTION:**

Only use the stylus provided with your DKEC to touch the screen. Using any other object could permanently scratch the touch screen.

Using the Remote or Keyboard

You can use either the remote or the keyboard to move the selection box around the screen. Press the navigation buttons that surround the GO button to move the selection box in the direction of the button.



Navigation Buttons

To go to a specific Web site:

1. On the browser toolbar, tap the **Web Target** box with the stylus.
-Or-
On the keyboard or remote, press .

2. Type the address of the Web site. It is not necessary to type "http://".
For example: To go to http://www.dacor.com, you can type: www.dacor.com.
3. Choose **GO** or press **Enter**.



 **NOTE:**

Repeatedly pressing the switches the focus between the Web Target box and the Web page.



Saving Favorite Web Sites

You can save Web sites that you want to visit frequently in a Favorites list.



To save a Web page to your Favorites list:

1. With the stylus, tap the  on the touch screen.
-Or-
On the remote or keyboard, press .
2. Choose the **Add** button next to "Add current page to my favorites list".
The Web page is added to the favorites list.

To change or rename a Web page in your Favorites list:





1. With the stylus, tap the  on the touch screen.
-Or-
On the remote or keyboard, press .
2. Select the Favorite that you want to edit.
3. Choose the **Edit** button.
4. Type the new name or URL.
5. Choose **OK**.







To delete a Web page from your Favorites list:

1. With the stylus, tap the  on the touch screen.
-Or-
On the remote or keyboard, press .
2. Select the Favorite that you want to delete.
3. Choose the **Delete** button.
4. Choose **OK**.

Other Internet Mode Commands

The following table lists additional tasks and commands:

To...	Do This...
Disconnect a Dial-Up connection to the Internet	1. Press Options . 2. Choose Disconnect .
Go back to the previous viewable Web page	On the remote or keyboard, press  . -Or- On the touch screen, tap  .
Go forward to the next viewable Web page (works after you have gone back to a previous page)	On the remote or keyboard, press  . -Or- On the touch screen, tap  .
Go to your home page	On the remote or keyboard, press Home . -Or- On the touch screen, tap  .

Go to your Email page	On the remote or keyboard, press Email . –Or– On the touch screen, tap  .
Stop a Web page from loading	On the touch screen, tap  .
Refresh a Web page	On the touch screen, tap  .
Scroll a Web page	On the remote or keyboard, press  in the direction that you want to scroll the page.
Open a new window	On the touch screen, tap  –Or– On the keyboard, press CTRL+N .
Close the current window	On the touch screen, tap  –Or– On the keyboard, press CTRL+E .

Radio Mode

With the DKEC, you can listen to your favorite FM Radio stations. The DKEC can receive radio signals from either the included FM Antenna or your cable service, if it is offered.

If you want to listen to your local radio stations, we recommend using the FM Antenna.

To switch to FM Radio Mode:

- On the remote or keyboard, press **Radio**.

Finding Radio Stations

Locating radio stations on the DKEC is the virtually the same as using your car or home radio. Use the Tune buttons to manually move up or down the spectrum to locate stations.

To stop only at stations with a strong signal, use the Seek buttons on the screen, or the channel +/- buttons on the keyboard or remote.

To choose a saved station:

- Tap its name on the touchscreen.
–Or–
- On the keyboard or remote, use the navigation controls to highlight the station, then press **GO**.
–Or–
- Using the keyboard or remote, enter the channel number.

NOTE:

Saved stations are listed in order of their Station Frequency.

Managing Radio Stations

Most people listen to a regular set of radio stations. To avoid having to tune to your favorite stations, you can save up to 21 stations.

You can give saved stations any name you want (the default is the Station Frequency). If you are using Cable TV to pick up FM Radio the station frequencies may not be accurate. In this circumstance, naming saved stations can help avoid confusion.

To save a favorite station:

- Press **Radio** to switch to FM Radio Mode.
- Use the **Tune** or **Seek** buttons to locate a favorite radio station.
- Choose **Save Station**.
The station appears on the Radio as a Saved Station.

To name a saved station:

- With the DKEC in Radio Mode, choose **Manage Stations**.
- In the **Saved Stations** list, select the station you want to name.
- Select the Station Name box.
- Type a name (up to 25 characters) for the selected station.
- Choose the **Apply** button.
- Repeat steps 2-5 to name additional stations.
- Choose **OK**.
The new station names appear in your list of Saved Stations.

To remove stations:

- With the DKEC in Radio Mode, choose **Manage Stations**.
- In the **Favorite Stations** list, select the station you want to remove.
- Choose the << button.
- Repeat steps 2-3 to remove additional stations.
- Choose **OK**.
The removed stations no longer appear in your list of Saved Stations on the FM Radio.

Video Mode

The DKEC can be connected to a video camera which you can use to monitor another part of the house. For example, you can monitor the activity in a child's room or see who is at the front door.

You can also use Video Mode to view video tapes on a VCR or play video games on a game system.

Additionally, you may wish to take advantage of the higher quality of Satellite or Digital Cable by using the S-video connection, which can also be viewed in Video Mode.

NOTE:

If you send your Satellite or Digital cable to the DKEC using S-Video, the DKEC remote or keyboard cannot be used to change channels in Video Mode. Continue to use your existing remote control with the set-top box.

If you've connected both an S-Video and composite signal, both are accessible from Video mode.

To view video sources:

- Press the **Video** mode button.
The last viewed video signal appears.
- Press the **Video** mode button again.
The alternate video signal (if any) appears.

Caring for Your DKEC

WARNING:

Risk of electric shock! Do not disassemble the DKEC unit, remote, or keyboard - the only user serviceable parts of the remote and keyboard are the batteries. There are no user-serviceable components and dangerous voltages may be present. All service must be performed by an authorized service technician. For more information, please refer to your warranty service card.

To clean the DKEC:

- Unplug the DKEC from the wall.
- Clean the exterior of the DKEC using a slightly damp, lint-free cloth.
- Gently clean the LCD screen with a slightly damp, lint-free cloth.
- Using a soft, nonabrasive sponge and mild detergent or dish soap, wash the remote and keyboard and rinse under the faucet in the sink.

CAUTION:

Do not wash the remote or keyboard in the dishwasher. Doing so can result in damage to the remote or keyboard.

Getting Help

If you have questions while using the DKEC, access the built-in Help to find answers. This comprehensive Help contains information that you can use to solve most problems that you may encounter.

NOTE:

A limited amount of information is available in Help without being connected to the Internet. To access all available information, you must configure your DKEC for access to the Internet and have an Internet connection. See Internet Mode on page 8.

To get help:

- On the keyboard, press **Help**.
–Or–
- On any menu, choose **Help**.

If you are unable to find the solution to your problem in Help, contact Dacor Customer Service for answers. Dacor Customer Service is available 24 hours per day, 7 days per week.

To get help from Dacor Customer Service:

- Have the following information and items ready when you call:
 - The serial number for your DKEC.
 - The date you purchased your unit.
 - A notepad and pen.
- Call 1-866-497-3888.

See also Troubleshooting below and F.A.Q.'s on the next page for more information.

Troubleshooting

Unnecessary service calls may be expensive, frustrating and time consuming. Before you call for service, please review the potential problems, possible causes and remedies shown in the table below.

Problem	Possible Causes/Solutions
The screen and LED are blank.	<ul style="list-style-type: none"> • The power cord is not plugged in. • The power button on the back panel is turned off. • The power outlet is not working properly.
No dial tone is present when attempting to connect to the Internet.	<ul style="list-style-type: none"> • The phone line is not connected firmly into the Phone In connection on back of the unit. • The phone line does not have a dial tone. To test, connect a different phone to the line. If there is no dial tone, contact your local telephone company.
Disc tray will not open when  is pressed.	<ul style="list-style-type: none"> • The power is not on and the LED is not green. • Try turning the power off and back on from the back panel. • The disc is not in the tray correctly. Contact Customer Care for help in manually opening the disc tray. Do not try to force the disc tray open, as damage may occur.
∅ icon appears on screen.	<ul style="list-style-type: none"> • The selected function is not supported on the disc being played.
Disc ejects automatically or will not play.	<ul style="list-style-type: none"> • The disc is damaged or dirty. • The disc is not placed on the tray correctly, with the label side up. • The disc is not in a compatible format, such as the software discs provided by AOL® or Earthlink®.
The unit does not respond to remote input.	<ul style="list-style-type: none"> • The IR signal from the remote is reaching neither of the IR detectors – try standing a little farther back from the unit. • The batteries for the remote need replacement.
The unit does not respond to keyboard input.	<ul style="list-style-type: none"> • The IR signal from the keyboard or remote is reaching neither of the IR detectors trying placing the keyboard on the counter just in front of the unit or try stepping back from the unit. • The batteries for the keyboard need replacement.
Unit stops responding to remote, keyboard, or stylus input.	<ul style="list-style-type: none"> • The unit has stopped responding. Turn the unit off at the power switch on the back panel and unplug the unit for five seconds. Plug the it back in and turn it on.

Troubleshooting Guide



NOTE:

More Troubleshooting tips are available in the DKEC Help.

F.A.Q.'s

The following are frequently asked questions (F.A.Q.) about the DKEC.



NOTE:

More F.A.Q.'s are available in the DKEC Help.

General Questions

Q: Is the DKEC a computer?

A: No. While the product has many powerful features, it was not designed to be a computer. It does not have a hard drive and it will not play or read CD-ROMs designed for PCs. The current version of the product does not support file transfer, file sharing, print sharing, and other LAN/WAN functions. Updates to enable this functionality may be available in the future.

Q: What operating system does the DKEC use?

A: The DKEC uses the Microsoft® Windows® CE.NET operating system.

Q: How much memory is in the DKEC?

A: The FlipScreen has 128 MB of SDRAM.

Q: Can I add more memory to the DKEC?

A: No, you cannot add more memory to your DKEC. However, the amount of RAM currently installed in the DKEC is more than adequate to handle all of its functions.

Q: Can you print from the DKEC?

A: Printing is currently available with a variety of printers.

Q: Do the remote and keyboard use infrared (IR) or radio frequency (RF) to communicate with the DKEC?

A: Infrared.

Q: Can I hook up external speakers to the screen?

A: Yes. In addition to the two speakers that come standard with the unit, it comes equipped with audio connections on the back panel for additional speakers. These additional speakers would need to have their own dedicated amplifiers.

Service and Cleaning Questions

Q: Are the remote and keyboard covered by the warranty?

A: Yes.

Q: What happens if I accidentally spill water or food on the keyboard and/or remote?

A: Both items are water resistant. They can be washed with a mild detergent and water and then rinsed under the kitchen faucet.

Q: How do I clean the touch screen display of my DKEC?

A: Any household cleaner that does not contain vinegar is appropriate. Do not spray the cleaner directly on the screen. Spray the cleaner on a nonabrasive cloth and rub the surface of the display to clean it.

Television Questions

Q: Does the DKEC support picture in picture?

A: No, because picture in picture does not present well on a small screen.

Q: Does the DKEC support video out?

A: No, the product is strictly video in and can act as a video monitor.

Internet Questions

Q: What are the requirements for which Broadband carriers I can use?

A: At this time, any Broadband service provider's technology should work with the DKEC. No additional software needs to be installed onto the DKEC.

Q: What are the requirements for which Dial-Up ISPs I can use?

A: As of the publishing of this document, the DKEC cannot support downloaded ISP software, such as that provided by AOL®. However, you can still access your Email at the AOL Anywhere® or MSN Hotmail® sites. All other major ISPs, such as Earthlink™, will work with the DKEC. More information about Web-Based Email is available in the DKEC Help.

Q: What does it mean when the same Web site viewed on my DKEC looks slightly different from how it looks on my PC?

A: If this occurs, it will occur very rarely. It is a result of very minor differences between your DKEC browser and the browser on your PC. The DKEC browser is built on Microsoft Internet Explorer 5.5.

Q: Can I use Internet Connection Sharing (ICS) to connect my DKEC through my existing PC running the Windows operating system?

A: If your existing PC is running Windows 98 Second Edition, Windows 2000, Windows Millennium Edition (Me), or Windows XP with Internet Connection Sharing installed, your DKEC, as well as other computers on your LAN, can then gain access to the Internet through the connection on the computer that has Internet Connection Sharing installed. For more information about ICS, visit <http://www.microsoft.com>

DVD and CD Questions

Q: Why don't some DVD buttons on the remote and keyboard work with all DVDs?

A: Not all DVDs are published with all of the features that the DKEC is capable of supporting. In some cases, DVD manufacturers have certain features available only at specific times. In addition, certain content will not respond to all commands. For example, the Stop button will not affect the "FBI Warning" screen.

FM Radio Questions

Q: Why does the product have FM only (and not AM as well)?

A: Based on our research, the vast majority of our customer demographic listens exclusively to FM radio.

Q: How many radio channels can I store with the product?

A: The product will store as many as 21 channels.

Q: Can I install my own FM antenna on the back of the appliance?

A: Yes. The antenna supplied with your unit has been tested and will typically provide good FM radio reception. You may be able to improve reception by using a more powerful antenna.

Q: Does touch screen work with the FM radio mode?

A: Yes. The touch screen works with all the functionality of the Radio mode.

Additional Information

Accessories

Your DKEC can connect to a variety of accessories. For information on which devices and accessories are compatible with your DKEC, visit www.dacor.com.

Privacy Policy

DKEC is committed to protecting the privacy and security of DKEC users. This privacy policy will advise you about how we protect your personal information and address your potential concerns over the use of this information. We may need to change this policy from time to time to address new issues and changes in our product.

Personal Identification Policy

Dacor will not disclose any personal identification information about you as an individual user, such as your address, name, or telephone number. We may request personal identification information for the use of our services.

Privacy of Children

We urge all parents to participate in their children's Internet and online experience. Please teach children about protecting their personal information while online.

Other Web Sites

If you should give out personal information online, through bulletin boards or other Web sites, that information can be used by third parties. You disclose information in these areas at your own risk. We encourage you to investigate and ask questions before disclosing information to third parties.

Security Information

Protecting your privacy and information is a priority of DKEC. We have taken careful measures to secure both our information and our physical premises. We exercise great care in providing secure transmissions of your personal information from your unit to our servers. Our server software encrypts information, which is intended to ensure that all DKEC transactions remain private (unless sent by an unsecured means, such as Email). We also make use of firewalls and secure socket layers where appropriate.

Please contact your own Internet Service Provider for information on their privacy policies. DKEC is not responsible for the policies of private Internet service providers.

Notwithstanding our use of technology to provide appropriate security, in this time of rapidly changing technology, any responsible Internet-related business must recognize and acknowledge that there are individuals and businesses that may attempt to use unethical or illegal means to access information or disrupt communications.

Therefore, we must advise you that no security system is perfect and that your use of the DKEC product constitutes a waiver of any claim against DKEC, or direct, consequential, and all other damages arising from the unauthorized access, use, or disclosure of information maintained on our systems, unless such damages are due to our intentional wrongdoing or gross negligence.

Specifications

Size - with Speakers	23 5/8" (600mm) x 10 13/16" (275mm) x 3 7/8" (97mm)
Weight	24 lb. (10.9 kg)
Power Source	110 VAC, 60 Hz
Display	800 x 600 pixels 12.1 TFT-LCD with backlight
Touch Screen	E-Fast Resistive touch screen Activation force <130 g
Speakers	Speaker channel – L/R bass, midrange, and treble Power 10 W per channel Resistance 4 Ω
Switch Controls	On/Off, Options, Mute, Volume +/-, Channel +/-, Pause/Play, Eject
Audio and Video inputs/Outputs	Coaxial CATV antenna in (F-type jack), stereo audio in/out (RCA type), composite video in (CVBS), DVD, Video CD 2.0 and S-Video In
Radio Input	FM band coaxial connection, F-type
Other Connections	Dual USB ports Dual PCMCIA slots RS-232, 9 pin connection SANI Cartridge
Keyboard Housing	Washable design, wireless IR technology, injection molded, high-impact, ABS plastic
Remote Housing	Washable design, wireless IR technology, injection-molded, high-impact, ABS plastic
Keyboard Keys	On/Off, Television, Internet, DVD & CD, Video, Radio, Mode X, Mode Y, Tab, Caps Lock, Enter, Shift, Help, Ctrl, Alt, Escape, Delete, Backspace, Full Alpha/Numeric keyboard with punctuation, Back/Previous Channel, +/- Channel, Options, +/- Volume, Channel direct select 1–9, Mute, Home, Email, Type in URL, Favorites, Scroll, Next/Previous Web page, Multidirectional Navigation, Play, Pause, Stop, Fast Forward/Backward, Skip to a Scene, Go to DVD Title page, Jump to Target, Go to Menu page, Audio, Zoom, Subtitle, Angle, Random, Display, 3D Audio
Remote Keys	On/Off, Television, Internet, DVD & CD, Video, Radio, Mode X, Mode Y, Back/Previous Channel, +/- Channel, Options, +/- Volume, Channel direct select 1–9, Mute, Home, Email, Favorites, Scroll, Next/Previous Web page, Multidirectional Navigation, Play, Pause, Stop, Fast Forward/Backward, Skip to a Scene, Jump to Target, Go to DVD Title page, Go to Menu page, Repeat, Audio, Zoom, Subtitle, Angle, Random, Display, 3D Audio
Disc Player	Works with the following formats: DVD, CDDA (Audio CD), MP3
Television Channels	125 channels, cable ready

DKEC Specifications

FCC Statement

The United States Federal Communications Commission (in 47 CFR 15.105) has specified that the following notice be brought to the attention of users of this product:

This equipment has been tested and found to comply with the limits for a Class B digital device, pursuant to part 15 of the FCC rules. These limits are designed to provide reasonable protection against harmful interference in a residential installation. This equipment generates, uses, and can radiate radio frequency energy and, if not installed and used in accordance with the instructions, may cause harmful interference to radio communications. However, there is no guarantee that interference will not occur in a particular installation. If this equipment does cause harmful interference to radio or TV reception, which can be determined by turning the equipment off and on, the user is encouraged to try to correct the interference by one of the following measures:

- Reorient or relocate the receiving antenna.
- Increase the separation between the equipment and the receiver.
- Connect the equipment into an outlet on a circuit different from that to which the receiver is connected.
- Consult the dealer or an experienced radio/TV technician for help.

Product Warranty

If for any reason you are not able to resolve difficulties with your DKEC using the Troubleshooting section of the Owners Manual, please contact Customer Service for assistance at 1-866-497-3888.

Customer Service will make every effort to assist you in resolving any difficulties you may be having. If the problem is deemed to be hardware related, you may be transferred to the Technical Support Center. The hardware warranty is listed below for your reference. This limited warranty is the only warranty provided with respect to the hardware, and Dacor offers no other warranty terms.

DACOR HARDWARE

This DKEC model product, as configured and supplied by Dacor and delivered new, in the original carton to the original consumer purchaser, is warranted by Dacor, against manufacturing defects in materials and workmanship for a limited warranty period of:

One (1) Year Parts and Labor

This limited warranty begins on the original date of purchase * and is valid only on products purchased and used in the United States and Canada. To receive warranty service, the purchaser must contact Dacor. Warranty service can only be performed by an authorized service center. The original dated bill of sale must be presented upon request as proof of purchase. An authorized technician will provide removal and re-installation of the product or a replacement product of the same model if the repair cannot be completed in the purchaser's home.

Dacor will repair or replace this product, at our option and at no charge as stipulated herein, with new or reconditioned parts or products if found to be defective during the limited warranty period specified above. In the event that a problem with the unit cannot be resolved via telephone support, a service technician will be dispatched to affect a repair. Replacement parts and products will be covered by the remaining original warranty, or ninety (90) days, whichever is longer.

Dacor's obligations with respect to software products distributed by Dacor under the DKEC brand name are set forth in the applicable end user license agreement. Non-Dacor hardware and software products are not covered by any Dacor warranty.

This limited warranty solely covers product repair or replacement due to manufacturing defects in materials and workmanship encountered in normal use of this product by end users. This limited warranty does not apply to other defects, damages, or injury of any kind or nature, including without limitation: product damage which occurs in shipment, delivery and installation; applications and uses for which this product was not intended; products with altered product or serial numbers; cosmetic damage or exterior finish; accidents, abuse, neglect, fire, water, lightning or other acts of nature; use of products, equipment, systems, utilities, services, parts, supplies, accessories, applications, installations, repairs, external wiring or connectors not supplied or authorized by Dacor, which damage this product or result in service problems; incorrect electrical line voltage, fluctuations and surges; customer adjustments and failure to follow operating instructions, cleaning, maintenance and environmental instructions that are covered and prescribed in the instruction book; product removal or reinstallation by the consumer; reception problems and distortion related to noise, echo, interference or other signal transmission and delivery problems; LCD Panel brightness related to normal aging, or burned-in images. Dacor does not warrant uninterrupted or error-free operation of the product.

THERE ARE NO EXPRESS WARRANTIES OTHER THAN THOSE LISTED AND DESCRIBED ABOVE. DACOR EXPRESSLY DISCLAIMS ANY AND ALL OTHER WARRANTIES, EXPRESS AND IMPLIED, INCLUDING WITHOUT LIMITATION ANY IMPLIED WARRANTIES OF MERCHANTABILITY OR FITNESS FOR A PARTICULAR PURPOSE. IF ANY WARRANTY SHALL BE IMPLIED AT LAW REGARDLESS OF THIS DISCLAIMER, THE LENGTH OF SUCH IMPLIED WARRANTY SHALL BE LIMITED TO ONE YEAR. NO OTHER WARRANTY OR GUARANTY GIVEN BY ANY PERSON, FIRM OR CORPORATION WITH RESPECT TO THIS PRODUCT SHALL BE BINDING ON DACOR. DACOR SHALL NOT BE LIABLE FOR LOSS OF REVENUE OR PROFITS, FAILURE TO REALIZE SAVINGS OR OTHER BENEFITS, OR ANY OTHER SPECIAL, INCIDENTAL OR CONSEQUENTIAL DAMAGES CAUSED BY THE USE, MISUSE OR INABILITY TO USE THIS PRODUCT, REGARDLESS OF THE LEGAL THEORY ON WHICH THE CLAIM

IS BASED, EVEN IF DACOR HAS BEEN ADVISED OF THE POSSIBILITY OF SUCH DAMAGES. NOR SHALL RECOVERY OF ANY KIND AGAINST DACOR BE GREATER IN AMOUNT THAN THE PURCHASE PRICE OF THE PRODUCT SOLD BY DACOR AND CAUSING THE ALLEGED DAMAGE. WITHOUT LIMITING THE FOREGOING, PURCHASER ASSUMES ALL RISK AND LIABILITY FOR LOSS, DAMAGE OR INJURY TO PURCHASER AND PURCHASER'S PROPERTY AND TO OTHERS AND THEIR PROPERTY ARISING OUT OF THE USE, MISUSE OR INABILITY TO USE THIS PRODUCT SOLD BY DACOR. THIS LIMITED WARRANTY SHALL NOT EXTEND TO ANYONE OTHER THAN THE ORIGINAL PURCHASER OF THIS PRODUCT, IS NONTRANSFERABLE AND STATES YOUR EXCLUSIVE REMEDY.

Some states do not allow limitations on or exclusions of an implied warranty, or the exclusion or limitation of incidental or consequential damages, so the above limitations or exclusions may not apply to you. This warranty gives you specific legal rights, and you may also have other rights that vary from state to state.

* For DKEC models that are built into homes and provided to end-users as part of the homebuilder's offering, the warranty period begins when the end-user/owner takes possession of the property. In all other cases, the date of purchase will be the invoice date.

To obtain warranty hardware service, please contact Dacor Customer Service at 1-866-497-3888.

Index

Numerics

3D Audio 6, 8

A

accessories 2, 13
Adjust 7
adjusting image & sound 7
analog phone line 4
Angle 6, 8
antenna 7
antenna grounding 2
attachments 2
Audio 6, 8
Audio Out 5
Autoscan Channels 7

B

Back 6, 9
batteries
 installing in keyboard 3
 installing in remote 3
brightness 7
Broadband
 configuring connection 9
broadband
 connecting 5
 wireless 5
Broadband Settings 9
Browser Settings 9
button
 3D Audio 6
 Angle 6, 8
 Audio 6, 8
 Back 6, 9
 Channel +/- 6
 Display 7
 DVD & CD 5
 Eject 5, 8
 Email 5, 10
 Forward 6, 8
 GO 6, 9
 Help 10
 Home 6, 10
 Internet 6
 Jump to Favorites 6
 Jump to Target 6
 Last Channel 6
 Menu 7, 8
 Mode X 6
 Mode Y 6
 Mute 5, 6
 Next 6
 Options 5, 6
 Pause 6, 8
 Play 6, 8
 Play/Pause 5
 Power 5
 Power On/Off 5
 Radio 5
 Random 6, 8
 Repeat 6, 8
 Reverse 6, 8
 Scroll 6
 Skip Forward 6, 8
 Skip Reverse 6, 8
 Stop 6, 8
 Subtitle 6, 8
 Television 5
 Title 6
 Volume +/- 5, 6
 Zoom 6, 8

buttons

directional 6
DVD & CD Mode 6
front panel 5
Internet Mode 8, 9
mode 6
remote and keyboard 5-6
Television Mode 7

C

cable 7
cable modem
 connecting 3
cable TV 7
camera angles 8
Cautions and Warnings 2
CD
 changing tracks 6
 Forward button 6
 Pause button 6
 pausing 8
 Play button 6
 playing 8
 Random button 6
 random play 8
 Repeat button 6
 repeat play 8
 resuming paused 8
 Reverse button 6
 Skip Forward button 6
 Skip Reverse button 6
 specific track 8
 Stop button 6
 stopping play 8
changing channels 8
changing favorites 10
Channel +/- 5, 6, 8
channels
 changing 8
 programming 8
cleaning 2, 10
close window 10
color 7
composite video
 connecting 3
connecting
 antenna 5
 cable modem 4
 camera 4
 composite video 4
 DSL 4
 FM antenna 4
 power 5
 RCA cable 4
 speakers 5
 to the Internet 4
 TV cable 3
 VCR 4
 video games 4
 wired broadband 4
 wireless broadband 4
connection
 Broadband 9
 Dial-Up 9
 wireless 9
Connection Settings 9
contrast 7
controls 5-6
 front panel 5
 remote and keyboard 5-6
Customer Care 10

D

deleting favorites 9
dial tone 11
Dialing Prefix 9
Dialing Sound 9
Dial-Up
 configuring connection 9
 connecting 4
 disconnecting 10
digital phone line 4
directional buttons 6, 9
disc tray 5
Disconnect 10
Display 6
display DVD menu 8
drawer, disc 5
DSL
 connecting 3
DVD
 audio options 6
 camera angles 6, 8
 Forward button 6
 languages 6
 menu 6, 8
 Pause button 6
 pausing 8
 Play button 6
 playing 8
 random play 8
 Repeat button 6
 repeat play 8
 resuming paused 8
 Reverse button 6
 Skip Forward button 6
 Skip Reverse button 6
 Stop button 6
 stopping play 6
 subtitles 6, 8
 time remaining 6
 title 6
 zoom 6, 8
DVD & CD Mode 8
 button 6
 buttons 6
DVD & CD Options 8

E

Eject 5, 8
electric shock 2
electrical grounding 2
Email 6, 10
Email URL 9
Ethernet Type 9
external speakers 5

F

F.A.Q.'s 12
fast forward 8
favorites 10
 changing 10
 deleting 10
 jump to 6
 renaming 10
 saving 10
FCC statement 18-19
FM Antenna
 connecting 3
FM Radio
 connecting the antenna 3
Font Size 9
Forward 6, 8

Index (Continued)

Forward, Skip 6
front panel controls 5

G

getting help 12
GO 6, 8, 9
grounding, electrical 2

H

Help 12
Home 10
home page 6, 10
Home Page URL 9
hue 7

I

image, adjusting 7
indicator
 LED 5
information displays 7
Internet 6
 configuring connections 9
 connecting to 4
Internet Mode 8-10
 button 5
 Email 10
 home page 10
 refresh page 10
 scroll page 10
 Stop 10
 using stylus 9
Internet Mode buttons 6
Internet Options 9
ISP Phone # 9

J

Jump to Favorites 6
Jump to Target 6, 9

K

key
 3D Audio 6
 Angle 6
 Audio 6
 Display 6
 Random 6
 Repeat 6
 Subtitle 6
 Zoom 6
keyboard 5-6
 battery installation 3
 buttons 5-6
 cleaning 10

L

languages 7
Last Channel 6
LED indicator 5
link
 selecting 7

M

MAC address
 finding 9
Menu 6, 8
 menu 12
Microwave Oven 5
mode buttons 5-6
Mode X 6
 button 6
Mode Y 6
 button 6

Modes

DVD & CD 6
Internet 8-9
Radio 10
Television 7
Video 10

Mute 5-6

N

navigation buttons 6, 9
new window 10
Next button 5
next Web page 6, 10

O

open disc tray 5
open new window 10
Options 5, 6, 7, 8, 9
Options button 6

P

parts 2
Password 9
Pause 7, 8
PCMCIA
 finding MAC address 9
 wireless 4
PCMCIA network card 4
personal identification policy 13
phone line
 digital & analog 4

picture, adjust 7

Play 6

play disc 6

play next 8

play previous 8

play, random 6

Play/Pause 5

playing DVD/CD 6

Power 5

power

 connecting 5

Power On/Off 5

power status 5

previous Web page 6, 10

printer

 connecting 5

printer, connecting 5

privacy of children 13

privacy policy 13

programming television channels 8

R

Radio 10

radio

 connecting the antenna 3

Radio Mode 10

 button 5

Radio Mode button 5

Random 6, 8

random play 8

RCA cable

 connecting 3

Refresh 10

remote 5, 7

 batteries 3

 buttons 5, 7

 cleaning 10

renaming favorites 9

repair service 10

Repeat 6, 8

replacement parts 2

resume play 8
Reverse 6, 8
Reverse, Skip 6
rewind 8
rubber gasket 3

S

safety instructions 2
satellite 3
saturation 7
saving favorites 9
screen
 front panel 5
Scroll 6, 10
selecting
 link 9
Selection Box 9
selection frame
 moving 9
serial number 10
servicing 2, 10
signal source 7
 choosing 7
Skip Forward 6, 8
Skip Reverse 6, 8
sleep mode 6
sound
 adjusting 7
speakers
 external 5
specifications 14
static IP 9
Stop 6, 7, 10
stop disc 6
Stylus
 using 9
stylus
 using 9
Subtitle 6, 7
S-Video
 connecting 3-4
 definition 3-4

T

tapping 9

Television 7

television

 options menu 7

 satellite 3

 signal source 3, 7

television channels

 changing 8

 programming 7

Television Mode 7-8

 button 5

Television Mode buttons 5

Television Options 7

tint 7

Title 6

Touch Screen 7

touchscreen

 cleaning 12

 using 7

track, go to specific 8

troubleshooting 11

TV channels

 changing 8

TV In 3

TV, cable 8

Index (Continued)

U

URL
 Email 9
 Home Page 9
USB ports 3
User Name 9

V

VCR 10
video games 10
Video Mode 10
Volume +/- 5, 6

W

Warnings and Cautions 2
Web page 10
 go to 10
 home page 6
 scroll 6, 10
 stop loading 10
 view favorites 6
 view next 6, 10
 view previous 6, 10
Web sites
 favorite 9
Web-based email 6
WEP key 9
window
 close current 10
 open new 10
wired broadband 4
wireless
 configuring connection 9
 connecting a bridge 4
 networking card 4
 PCMCIA 4
 security 9
 static IP 9
 WEP key 9
Wireless Settings 9

Z

Zoom 7, 8

End User License Agreement

Dacor/Microsoft Windows CE .NET End User License Agreement

You have acquired a device ("DEVICE") that includes software licensed by Dacor from Microsoft Licensing, GP or its affiliates ("MS"). Those installed software products of MS origin, as well as associated media, printed materials, and "online" or electronic documentation ("SOFTWARE") are protected by international intellectual property laws and treaties. The SOFTWARE is licensed, not sold. All rights reserved.

IF YOU DO NOT AGREE TO THIS END USER LICENSE AGREEMENT ("EULA"), DO NOT USE THE DEVICE OR COPY THE SOFTWARE. INSTEAD, PROMPTLY CONTACT DACOR FOR INSTRUCTIONS ON RETURN OF THE UNUSED DEVICE(S) FOR A REFUND. ANY USE OF THE SOFTWARE, INCLUDING BUT NOT LIMITED TO USE ON THE DEVICE, WILL CONSTITUTE YOUR AGREEMENT TO THIS EULA (OR RATIFICATION OF ANY PREVIOUS CONSENT).

GRANT OF SOFTWARE LICENSE. This EULA grants you the following license:

- You may use the SOFTWARE only on the DEVICE.
- NOT FAULT TOLERANT. THE SOFTWARE IS NOT FAULT TOLERANT. DACOR HAS INDEPENDENTLY DETERMINED HOW TO USE THE SOFTWARE IN THE DEVICE, AND MS HAS RELIED UPON DACOR TO CONDUCT SUFFICIENT TESTING TO DETERMINE THAT THE SOFTWARE IS SUITABLE FOR SUCH USE.
- NO WARRANTIES FOR THE SOFTWARE. THE SOFTWARE is provided "AS IS" and with all faults. THE ENTIRE RISK AS TO SATISFACTORY QUALITY, PERFORMANCE, ACCURACY, AND EFFORT (INCLUDING LACK OF NEGLIGENCE) IS WITH YOU. ALSO, THERE IS NO WARRANTY AGAINST INTERFERENCE WITH YOUR ENJOYMENT OF THE SOFTWARE OR AGAINST INFRINGEMENT. IF YOU HAVE RECEIVED ANY WARRANTIES REGARDING THE DEVICE OR THE SOFTWARE, THOSE WARRANTIES DO NOT ORIGINATE FROM, AND ARE NOT BINDING ON, MS.
- Note on Java Support. The SOFTWARE may contain support for programs written in Java. Java technology is not fault tolerant and is not designed, manufactured, or intended for use or resale as online control equipment in hazardous environments requiring fail-safe performance, such as in the operation of nuclear facilities, aircraft navigation or communication systems, air traffic control, direct life support machines, or weapons systems, in which the failure of Java technology could lead directly to death, personal injury, or severe physical or environmental damage. Sun Microsystems, Inc. has contractually obligated MS to make this disclaimer.

- No Liability for Certain Damages. EXCEPT AS PROHIBITED BY LAW, MS SHALL HAVE NO LIABILITY FOR ANY INDIRECT, SPECIAL, CONSEQUENTIAL OR INCIDENTAL DAMAGES ARISING FROM OR IN CONNECTION WITH THE USE OR PERFORMANCE OF THE SOFTWARE. THIS LIMITATION SHALL APPLY EVEN IF ANY REMEDY FAILS OF ITS ESSENTIAL PURPOSE. IN NO EVENT SHALL MS BE LIABLE FOR ANY AMOUNT IN EXCESS OF U.S. TWO HUNDRED FIFTY DOLLARS (U.S.\$250.00).
- Limitations on Reverse Engineering, Decompilation, and Disassembly. You may not reverse engineer, decompile, or disassemble the SOFTWARE, except and only to the extent that such activity is expressly permitted by applicable law notwithstanding this limitation.
- SOFTWARE TRANSFER ALLOWED BUT WITH RESTRICTIONS. You may permanently transfer rights under this EULA only as part of a permanent sale or transfer of the Device, and only if the recipient agrees to this EULA. If the SOFTWARE is an upgrade, any transfer must also include all prior versions of the SOFTWARE.
- EXPORT RESTRICTIONS. You acknowledge that SOFTWARE is subject to U.S. export jurisdiction. You agree to comply with all applicable international and national laws that apply to the SOFTWARE, including the U.S. Export Administration Regulations, as well as end-user, end-use and country destination restrictions issued by U.S. and other governments. For additional information see <http://www.microsoft.com/exporting/>.
- You may not make or distribute copies of the SOFTWARE, or electronically transfer the Software from one computer to another or over a network.
- Your license rights under this EULA are non-exclusive.
- You agree that Dacor and/or Macromedia may audit your use of the Software for compliance with these terms at any time, upon reasonable notice.
- NOT FAULT TOLERANT. THE SOFTWARE IS NOT FAULT TOLERANT. DACOR HAS INDEPENDENTLY DETERMINED HOW TO USE THE SOFTWARE IN THE DEVICE, AND MACROMEDIA HAS RELIED UPON DACOR TO CONDUCT SUFFICIENT TESTING TO DETERMINE THAT THE SOFTWARE IS SUITABLE FOR SUCH USE.
- NO WARRANTIES FOR THE SOFTWARE. THE SOFTWARE is provided "AS IS" and with all faults. THE ENTIRE RISK AS TO SATISFACTORY QUALITY, PERFORMANCE, ACCURACY, AND EFFORT (INCLUDING LACK OF NEGLIGENCE) IS WITH YOU. ALSO, THERE IS NO WARRANTY AGAINST INTERFERENCE WITH YOUR QUIET ENJOYMENT OF THE SOFTWARE OR AGAINST INFRINGEMENT. THERE ARE NO WARRANTIES OF MERCHANTABILITY OR FITNESS FOR A PARTICULAR PURPOSE. THERE IS NO WARRANTY THAT THE SOFTWARE IS ERROR-FREE OR WILL OPERATE WITHOUT INTERRUPTION. NO RIGHTS OR REMEDIES REFERRED TO IN ARTICLE 2A OF THE UCC WILL BE CONFERRED ON YOU UNLESS EXPRESSLY GRANTED HEREIN. THE SOFTWARE IS NOT DESIGNED, INTENDED OR LICENSED FOR USE IN HAZARDOUS ENVIRONMENTS REQUIRING FAIL-SAFE CONTROLS, INCLUDING WITHOUT LIMITATION, THE DESIGN, CONSTRUCTION, MAINTENANCE OR OPERATION OF NUCLEAR FACILITIES, AIRCRAFT NAVIGATION OR COMMUNICATION SYSTEMS, AIR TRAFFIC CONTROL, AND LIFE SUPPORT OR WEAPONS.

Dacor/Macromedia End User License Agreement

- You have acquired a device (DEVICE) that includes software licensed by Dacor from Macromedia Inc. (MACROMEDIA). Those installed software products of MACROMEDIA origin, as well as associated media, printed materials, and "online" or electronic documentation (SOFTWARE) are protected by international intellectual property laws and treaties. The SOFTWARE is licensed, not sold. All rights reserved.
- IF YOU DO NOT AGREE TO THIS END USER LICENSE AGREEMENT (EULA), DO NOT USE THE DEVICE OR USE THE SOFTWARE. INSTEAD, PROMPTLY CONTACT DACOR FOR INSTRUCTIONS ON RETURN OF THE UNUSED DEVICE(S) FOR A REFUND. ANY USE OF THE SOFTWARE, INCLUDING BUT NOT LIMITED TO USE ON THE DEVICE, WILL CONSTITUTE YOUR AGREEMENT TO THIS EULA (OR RATIFICATION OF ANY PREVIOUS CONSENT).
- GRANT OF SOFTWARE LICENSE. The license rights under this EULA are subject to the terms and conditions of this EULA. This EULA grants you the following license:
 - You may use the SOFTWARE only on the DEVICE.
- IF YOU HAVE RECEIVED ANY WARRANTIES REGARDING THE DEVICE OR THE SOFTWARE, THOSE WARRANTIES DO NOT ORIGINATE FROM, AND ARE NOT BINDING ON, MACROMEDIA.

- No Liability for Certain Damages. EXCEPT AS PROHIBITED BY LAW, MACROMEDIA SHALL HAVE NO LIABILITY FOR ANY INDIRECT, SPECIAL, CONSEQUENTIAL OR INCIDENTAL DAMAGES ARISING FROM OR IN CONNECTION WITH THE USE OR PERFORMANCE OF THE SOFTWARE. THIS LIMITATION SHALL APPLY EVEN IF ANY REMEDY FAILS OF ITS ESSENTIAL PURPOSE. IN NO EVENT SHALL MACROMEDIA BE LIABLE FOR ANY AMOUNT IN EXCESS OF U.S. TWO HUNDRED FIFTY DOLLARS (U.S.\$250.00). (USA only) SOME STATES DO NOT ALLOW THE LIMITATION OR EXCLUSION OF LIABILITY FOR INCIDENTAL OF CONSEQUENTIAL DAMAGES, SO THE ABOVE LIMITATION OR EXCLUSION MAY NOT APPLY TO YOU AND YOU MAY ALSO HAVE OTHER LEGAL RIGHTS THAT VARY FROM STATE TO STATE. THE FOREGOING LIMITATIONS ON LIABILITY ARE INTENDED TO APPLY TO THE WARRANTIES AND DISCLAIMERS ABOVE AND ALL OTHER ASPECTS OF THIS EULA.
- Limitations on Reverse Engineering, Decompilation, and Disassembly. You may not reverse engineer, decompile, disassemble or otherwise reduce the SOFTWARE to human-perceivable form, except and only to the extent that such activity is expressly permitted by applicable law notwithstanding this limitation. You may not alter, merge, modify, adapt or translate the SOFTWARE, or create derivative works based upon the SOFTWARE.
- The foregoing license gives you limited license to use the Software. MACROMEDIA and its suppliers retain all right, title and interest, including all copyright and intellectual property rights, in and to, the Software and all copies thereof. All rights not specifically granted in this EULA, including Federal and International Copyrights, are reserved by Licensor and its suppliers.
- SOFTWARE TRANSFER ALLOWED BUT WITH RESTRICTIONS. You may permanently transfer rights under this EULA only as part of a permanent sale or transfer of the Device, and only if the recipient agrees to this EULA. If the SOFTWARE is an upgrade, any transfer must also include all prior versions of the SOFTWARE. You may not retain any copies of the SOFTWARE. You may not rent, lease or sublicense the software.
- EXPORT RESTRICTIONS. You acknowledge that SOFTWARE is of US-origin. You agree to comply with all applicable international and national laws that apply to the SOFTWARE, including the U.S. Export Administration Regulations, as well as end-user, end-use and country destination restrictions issued by U.S. and other governments.
- In the event that you fail to comply with this EULA, Licensor may terminate the license and you must destroy all copies of the Software (with all other rights of both parties and all other provisions of this EULA surviving any such termination). The Software and the documentation are provided with "RESTRICTED RIGHTS" applicable to private and public licenses alike. Without limiting the foregoing, use, duplication, or disclosure by the U.S. Government is subject to restrictions as set forth in this EULA and as provided in DFARS 227.7202-1(a) and 227.7202-3(a) (1995), DFARS 252.227- 7013 (c)(1)(ii)(OCT 1988), FAR 12.212(a)(1995), FAR 52.227-19, or FAR 52.227-14, as applicable.
- The limitations or exclusions of warranties and liability contained in this EULA do not affect or prejudice the statutory rights of a consumer, i.e., a person acquiring goods otherwise than in the course of a business. The limitations or exclusions of warranties, remedies or liability contained in this EULA shall apply to you only to the extent such limitations or exclusions are permitted under the laws of the jurisdiction where you are located.
- Third-party software MPEG-Layer 3 audio compression technology licensed by Fraunhofer IIS and Thomson multimedia. (<http://www.iis.fhg.de/amm/>). You cannot use the MP3 compressed audio within the Software for real time or live broadcasts. If you require an MP3 decoder for real time or live broadcasts, you are responsible for obtaining this MP3 technology license.
- This EULA with respect to the Software shall be governed by the internal laws of the State of California, without giving effect to principles of conflict of laws.

Notes

fold here

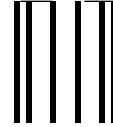

NO POSTAGE
NECESSARY
IF MAILED
IN THE
UNITED STATES

BUSINESS REPLY MAIL
FIRST-CLASS MAIL PERMIT NO. 4507 DIAMOND BAR CA

POSTAGE WILL BE PAID BY ADDRESSEE

ATTN: WARRANTY PROCESSING DEPT
DACOR
1440 BRIDGEGATE DR STE 200
PO BOX 6532
DIAMOND BAR CA 91765-9861

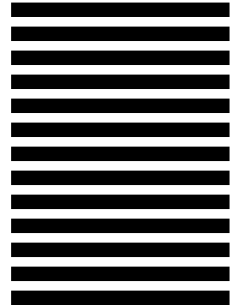



Please visit www.dacor.com to activate your warranty online.

WARRANTY INFORMATION



IMPORTANT:

Your warranty for this product **CANNOT BE ACTIVATED** until this form has been returned to Dacor. If you have purchased more than one Dacor product, Please return all forms in one envelope.

Please rest assured that under no conditions will Dacor sell your name or any of the information on this form for mailing list purposes. We are very grateful that you have chosen Dacor products for your home and do not consider the sale of such information to be a proper way of expressing our gratitude!

(Please Print or Type)

Owner's Name: _____
Last First Middle

Street: _____

City: _____ State: _____ Zip: _____

Purchase Date: _____ Email: _____ Telephone: _____

Dealer: _____

City: _____ State: _____ Zip: _____

Your willingness to take a few seconds to fill in the section below will be sincerely appreciated. Thank you.

1. How were you **first** exposed to Dacor products? (Please check one only.)

- A. T.V. Cooking Show
- B. Magazine
- C. Appliance Dealer Showroom
- D. Kitchen Dealer Showroom
- E. Home Show
- F. Builder
- G. Architect/Designer
- H. Another Dacor Owner
- I. Model Home
- J. Other _____

2. Where did you buy your Dacor appliances?

- A. Appliance Dealer
- B. Kitchen Dealer
- C. Builder Supplier
- D. Builder
- E. Other _____

3. For what purpose was the product purchased?

- A. Replacement **only**
- B. Part of a Remodeled
- C. New Home
- D. Other _____

4. What is your household income?

- A. Under \$75,000
- B. \$75,000 – \$100,000
- C. \$100,000 – \$150,000
- D. \$150,000 – \$200,000
- E. \$200,000 – \$250,000
- F. Over \$250,000

5. What other brands of appliances do you have in your kitchen?

- A. Cooktop _____
- B. Oven _____
- C. Dishwasher _____
- D. Refrigerator _____

6. Would you buy or recommend another Dacor product?

- Yes
- No

Comments: _____

Thank you very much for your assistance. The information you have provided will be extremely valuable in helping us plan for the future and giving you the support you deserve.

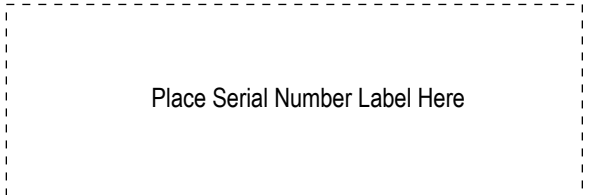

cut here

cut here