



Innovative Foodservice Equipment Custom
Designed for Performance, Service and Value.

Convection Heated Holding Cabinets

OPERATION & MAINTENANCE MANUAL

MODELS:

CA34-CV9
CA43-CV7 or CV13
CA70-CV16 or CV32

CA34-CVMP4
CA43-CVMP6
CA70-CVMP12

CS34-CH9
CS43-CH7 or CH13
CS72-CH16 or CH32

CS34-CHUS4
CS43-CHUS6
CS70-CHUS15

CS43-CVMP6-SB
CS61-CVMP12-SB
CS71-CVMP15-SB

Phone: +1 (214) 421-7366
Fax: +1 (214) 565-0976
Toll Free: +1 (800) 441-1601
Website: www.BevLes.com
E-mail: sales@BevLes.com

P/N 780085 1/06

BevLes
729 Third Avenue
Dallas, TX 75226

TABLE OF CONTENTS

1	WARRANTY	3
2	GETTING STARTED	4
	2-1 INTRODUCTION	4
	2-2 MODELS	4
	2-3 UNPACKING	4
	2-4 SETTING-UP	5
	2-5 CLEANING	5
3	OPERATION	6
	3-1 OPERATING CONTROLS AND COMPONENTS	6
	3-2 OPERATIONAL PROCEDURES	6
4	CARE OF YOUR UNIT	7
	4-1 ASSISTANCE	7
	4-2 SAFETY AND HEALTH	7
	4-3 CLEANING	7
	4-4 MODEL SPECIFICATIONS	7
5	TROUBLESHOOTING	7
	5-1 TROUBLESHOOTING	7
	5-2 TROUBLESHOOTING TABLE	8
6	MAINTENANCE	9
	6-1 REPLACING PARTS	9
	6-1a REMOVING THE TOP MOUNTED HEATING MODULE	9
	6-1b REMOVING THE FRONT PANEL	9
	6-1c POWER INDICATOR LAMP MODULE	9
	6-1d THERMOSTAT INDICATOR LAMP MODULE	10
	6-1e POWER SWITCH	10
	6-1f THERMOMETER	11
	6-1g POWER CORD FOR CA70	11
	6-1h POWER CORD FOR CA43	12
	6-1i THERMOSTAT FOR CA70	13
	6-1j THERMOSTAT FOR CA43	14
	6-1k FAN BLOWER MOTOR ASSEMBLY	16
	6-1l HEATING ELEMENT	17
	6-1m HIGH-TEMPERATURE SAFETY THERMOSTAT	18
	6-1n TOP MOUNTED HEATING MODULE SEAL (GASKET)	18
	6-1o FAN BLOWER COOLING FAN FOR CA43	18
7	REPLACEMENT PARTS	19
	7-1 HOW TO ORDER	19
	7-2 PRICES	19
	7-3 SHIPPING	19
	7-4 WARRANTY	19
	7-5 PARTS DRAWINGS	19
	7-6 PARTS LISTS w/EXPLODED VIEWS	20
8	WIRING DIAGRAMS	29
	8-1a CA70 MODELS	29
	8-1b CA43 MODELS	29

1. WARRANTY



BEVLES COMPANY LIMITED WARRANTY

729 Third Avenue * Dallas, TX 75226

Phone: +1 (214) 421-7366 Fax: +1 (214) 565-0976

1. Bevles warrants to the original purchaser that on the date the equipment is shipped (sold), it will be free of defects in materials or workmanship. Bevles will, at its discretion, repair or replace, during the warranty period printed below, any part that has a defect in material or workmanship that was present when the product shipped from Bevles, and which manifests itself during the warranty period under normal use and service.
 - Parts: Two* years from date of original shipment from the Bevles factory.
 - Labor: One** year from date of original shipment from the Bevles factory.

* Air Circulation Blower Assemblies (motors) and Power Switches shall be one year from date of original shipment.

Calrod "Air" Heating Elements shall be three years from date of original shipment.

** All electrical components 120 days from date of original shipment.
2. Bevles must be contacted, and pre-approval must be issued by the Bevles factory prior to any type of service being performed. Bevles assumes no responsibility for any charges that were not expressly authorized by the Bevles factory, or for any charges that exceed, in Bevles' sole judgement, normal and customary amounts.
3. Bevles will pay UPS Ground charges for any part that has a defect in material or workmanship that was present when the product shipped from Bevles, and which manifests itself during the **first year** of the warranty period under normal use and service. All warranty replacement parts will ship F.O.B. Bevles factory, Cheyenne, WY 82003.
4. This warranty shall be void in its entirety if any abuse of, misuse of, alteration/modification of or improper maintenance of original product occurs. If, at any time a claim is reported to Bevles, the purchaser is delinquent in payment for the product, warranty will not apply.
5. Buyer's Remedies-If a Bevles product fails due to a defect in material or workmanship in conformity with the warranties in paragraph one, buyer shall notify Bevles of such failure within a reasonable time, but in no event beyond fifteen (15) days of such discovery of defect in material or workmanship. Bevles shall provide, in its sole discretion, either the repair or replacement of any defective or any non-conforming part. Bevles specifically disavows any other representation, warranty or liability relating to the continued use of the product.
6. Exclusion of consequential and incidental damages-In no event shall Bevles be liable for any incidental, special, indirect, or consequential damages, whether resulting from non-delivery or from the use, misuse, or inability to use the product, or from defects in the product, or from Bevles' own negligence or other tort. This exclusion applies regardless of whether such damages are sought for breach of warranty, breach of contract, negligence, or strict liability in tort or under any other legal theory.
7. Disclaimer of warranties-The warranties contained in paragraph one above are the exclusive warranties given by Bevles and supersede any prior, contrary, or additional representations, whether oral or written. Bevles hereby disclaims and excludes all other warranties-whether expressed, implied, or statutory-including any warranty of merchantability, any warranty of fitness for a particular purpose, and any implied warranties otherwise arising from course of dealing or usage of trade.

1/05

2. GETTING STARTED

2-1 INTRODUCTION

BEVLES Heated Holding Cabinets are quality built equipment designed to hold prepared foods at a safe temperature (no less than 140°), with or without humidity. These cabinets have a wide range of applications for both institutional and commercial foodservice operations

This manual has been prepared so that all personnel responsible for the operation and maintenance of this equipment will have a thorough understanding of its operation and use. We recommend that any personnel using the cabinet read this manual thoroughly before operating the equipment.

****NOTE:** Certain items of information and procedures will be highlighted with the words "**NOTE**" or "**WARNING**". Please make special note of these items as they will communicate important information for the safety of your personnel, and the continued quality of service provided by the equipment.

2-2 MODELS

All BEVLES Heated Holding Cabinets are designed to hold hot products at the desired holding temperature. They accomplish this through patented air and humidity systems that force heated, moist air laterally across each level of the cabinet from side mounted air-flow ducts. Each cabinet also offers certain features that make them extremely easy to use, clean and service:

- The easily removable top mounted heating module contains all of the cabinet's electrical components.
- Dutch doors are mounted on the front with a full-length door on the back (for 70 inch models). All doors are removable and equipped with patented positive extruded latches.
- Standard models offer right-hand swing doors, but all cabinet doors can be hinged either left or right.
- Heavy-duty ball bearing casters provide easy and reliable mobility (for 70 inch and 43 inch models).

This manual applies to the following models:

CA70-CV16	CA 70-CV16HW	CA 70-CV32	CA 70-CV32HW	CA70-CVMP12
CA70-CVMP15	CA43-CV7	CA43-CV7HW	CA43-CV13	CA43-CV13HW
CA43-CVMP6	CA43-CVMP7			

2-3 UNPACKING

****NOTE:** All BEVLES cabinets are tested, inspected and expertly packed to insure arrival in a ready-to-use condition. If damage or loss is discovered when unpacking, ask the carrier's agent (in writing) to inspect the goods. This should be done within 15 days of delivery. You can then file a formal claim with the carrier. If we can help in any way, please call us.

This product has been shipped on a wooden base, packed with secure padding and covered with a plastic bag and corrugated shipping container.

To open:

1. Carefully cut the metal banding.
2. Lift the shipping container off of the unit.
3. Lift the unit off of the wooden base. **WARNING:** Use extreme care in lifting to prevent personal injury.
4. Remove the plastic bag and properly dispose of it.
5. Check model number on the serial number label (located on the top right front corner of the right side of the unit) against the packing slip.
6. Open doors and remove packing materials.
7. **NOTE:** Before using, the cabinet should be thoroughly cleaned as instructed in section 2-5 of this manual.

2-4 SETTING-UP

Locate your holding cabinet in an area where the doors can be opened without impeding your operation and where loading and unloading product will be easy.

****WARNING:** A clearance of at least four (4) inches is required between the top of full size units (models beginning with CA70) and any other equipment or surfaces to allow air to circulate to the motor air vents. Do not set anything on top of these units.

Proper operation of the unit requires that it be level and that it be plugged into a separate electrical line protected by a fuse or circuit breaker of the proper rating.

CA70-CV16	120V/1500W/14.3A	CA43-CV7	120V/1500W/14.3A
CA70-CV16HW	120V/2000W/18.5A	CA43-CV7HW	120V/2000W/17.0A
CA70-CV32	120V/1500W/14.3A	CA43-CV13	120V/1500W/14.3A
CA70-CV32HW	120V/2000W/18.5A	CA43-CV13HW	120V/2000W/17.0A
CA70-CVMP12	120V/2000W/18.5A	CA43-CVMP6	120V/2000W/17.0A
CA70-CVMP15	120V/2000W/18.5A	CA43-CVMP7	120V/2000W/17.0A

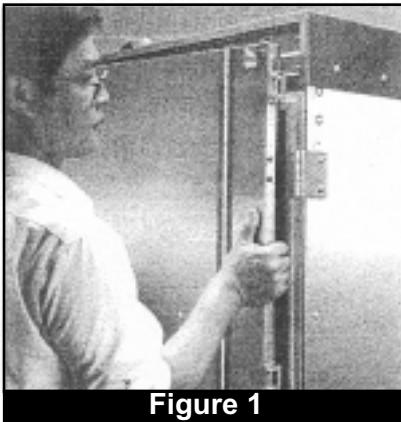

Figure 1

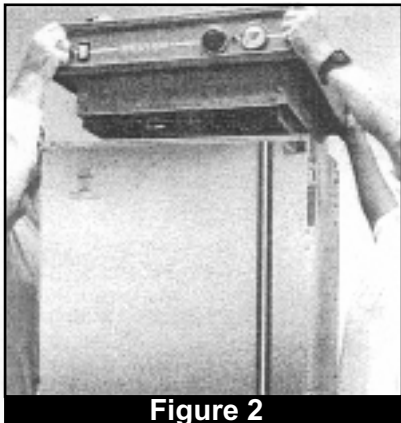

Figure 2

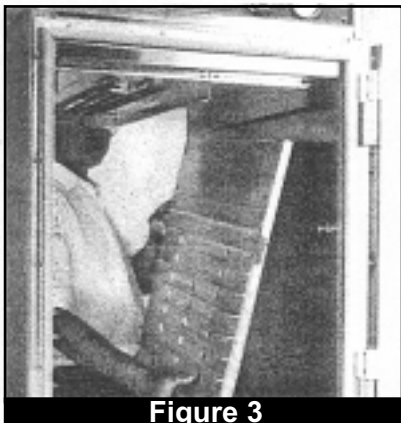

Figure 3

WARNING: Plug your unit only into a grounded receptacle of the correct voltage. Check the serial number label located in the top right front corner on the right side of the cabinet to determine your unit's electrical rating.

2-5 CLEANING

****NOTE:** Never use steel wool or caustic cleaning compounds on your BEVLES holding cabinet.

Cleaning Steps:

1. Push power switch to the OFF position.
2. Unplug power cord from wall.
CAUTION: Always unplug the unit before dismantling or cleaning.
3. Remove front and back doors by lifting entire door and sliding hinge off of hinge pins. (Fig. 1)
****NOTE:** Avoid motions other than straight up or down when removing and replacing doors so as not to damage hinges.
4. Slide out stainless steel water pan containing the three "U" shaped baffles.
5. Lift off the heating module from the top of the cabinet. (Fig. 2)
****NOTE:** At least two people should do the lifting to avoid possible injury.
6. Remove all trays.
7. Remove tray supports by carefully lifting each panel and tilting the bottom toward the center of the cabinet. (Fig. 3)
****NOTE:** Handle the support panels carefully as any damage or bending will make reinstallation very difficult
8. Remove positive door latches (Fig. 4):
 - 8a. Firmly hold the latch plate against the edge of the door and pull the black capped pin up and out.
 - 8b. Slowly pull the latch plate away from the door, ready to catch the flat metal spring as it releases.
9. Models equipped with dutch doors will also have a removable wiper blade attached to the top of the bottom door. To remove this, loosen the two black knurled knobs at either end of the wiper blade retainer. Lift off the stainless steel retainer and the wiper blade.

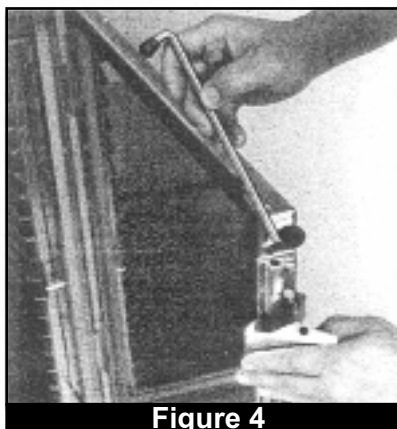

Figure 4

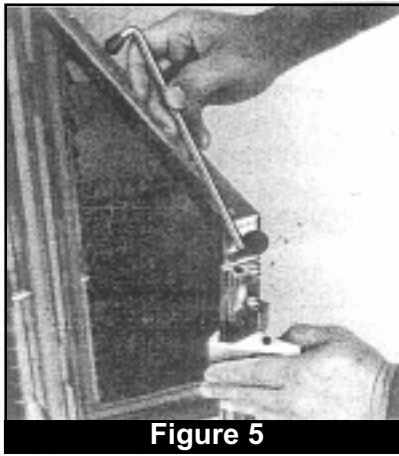

Figure 5

10. Clean all pieces thoroughly and carefully with soapy water and soft cloths.
****NOTE:** Never use steel wool or caustic cleaning compounds.
****CAUTION:** Avoid splashing water or any other liquid into the heating module to prevent possible damage to electrical components.

Reassembly Steps:

1. Replace door latches (Fig.5):
 - 1a. Wrap the flat metal latch spring lip around the front edge of the door between the two latch butts.
 - 1b. Place the latch plate with the flat side out over the flat metal latch spring and press firmly in place.
 - 1c. Guide the black capped pin down through the top latch butt, the latch plate and bottom latch butt. This will require positive pressure on the latch plate to compress the spring.
2. Replace dutch door wiper blade if your model is equipped with one. Simply slide the gasket and retainer onto the top edge of the bottom door and re-tighten the two black knurled knobs.
3. Carefully replace top mounted heating module and align with top tray supports.
4. Replace tray support panels.
5. Replace doors by sliding door hinges back down onto the hinge pins.
6. You are now ready to operate your unit in accordance with the procedures outlined in section 3-2.

3. OPERATION

BEVLES Heated Holding Cabinets are not intended for any use other than as foodservice equipment. Always operate your unit in accordance with the Operational Procedures listed in section 3-2 of this manual.

3.1 OPERATING CONTROLS AND COMPONENTS (Fig. 6)

1. Power Switch
2. Power Switch Indicator lamp
3. Thermostat
4. Thermostat Indicator Lamp
5. Thermometer

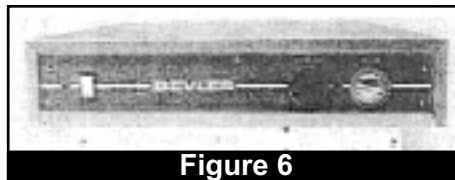

Figure 6

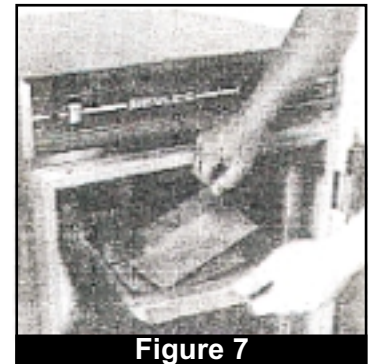

Figure 7

3-2 OPERATIONAL PROCEDURES

1. Plug unit into wall.
CAUTION: Check the serial number label located on the right side of the cabinet (as you are facing the front of the unit) at the top to be sure that your unit is compatible with your electrical supply. See section 4-4 for more information.
2. If humidity is desired, fill water pan % full of water and adjust baffles. (Fig. 7)
 - 2a. For maximum humidity, all three baffles should be inserted into the water pan as though they were the letter "U" (open side up).
 - 2b. For minimum humidity, all three baffles should be inserted in the water pan as though they were the letter "n" (open side down).
 - 2c. Intermediate levels of humidity may be achieved by mixing the arrangement of the baffles.
3. Slide the water pan into its receptacle at the top of the cabinet, just under the heating module. Carefully push the pan to assure that it is seated against the water pan back stop.
4. Push on the power switch. The power indicator light should come on. You should also hear the blower fan(s) operating.
5. Set the thermostat to the desired holding temperature (140° to 200°F). The red thermostat indicator light should come on.
6. Check your cabinet after 5 minutes to be sure that the heating element(s) is functioning.
7. When the cabinet reaches your desired temperature, the thermostat indicator light will go out (though the power indicator light will remain illuminated).
8. Check and add water to the water pan from time to time during long periods of operation (if needed).
****CAUTION:** The water pan is located directly under the heating element(s). Always use extreme caution when removing or replacing the water pan to prevent injury (burn).

4. CARE OF YOUR UNIT

As with any piece of quality equipment, your BEVLES Heated Holding Cabinet requires regular care and maintenance. The most vital procedure is the regular and thorough cleaning of the entire unit.

For your assistance, we have included the following sections in this manual:

2-4 Setting Up	5 Troubleshooting	7-6 Parts List
2-5 Cleaning	6-1 Replacing Parts	8-1 Wiring Diagrams

4-1 ASSISTANCE

BEVLES is proud of each quality-built cabinet. Should you ever need assistance, parts or additional equipment just call the BEVLES Manufacturing Facilities at (800) 441-1601.

In addition, refer to the Troubleshooting (5) and Replacement Steps (6-1) sections of this manual for assistance if occasional maintenance questions should arise.

4-2 SAFETY AND HEALTH

BEVLES Heated Holding Cabinets carry both UL and NSF listings. Always operate your unit in accordance with the operational procedures found in section 3-2.

****CAUTION:** Never remove the top mounted heating module without first unplugging your cabinet from its power source.

4-3 CLEANING

Refer to section 2-5 for complete cleaning steps and procedures.

4-4 MODEL SPECIFICATIONS

Model	Vertical Pan Spacing	Capacity		Dimensions			Watts	Electrical	
		(18" x 26" Pans)	(12" x 20" Pans)	Height	Width	Depth		Volts	Amps
CA 70-CV16	3 1/4"	16		70"	24 1/2"	31"	1500	120/240	14.3/7.2
CA70-CV16HW*	3 1/4"	16		70"	24 1/2"	31"	2000	120/240	18.5/9.3
CA 70-CV32	1 1/2"	32		70"	24 1/2"	31"	1500	120/240	14.3/7.2
CA 70-CV32HW*	1 1/2"	32		70"	24 1/2"	31"	2000	120/240	18.5/9.3
CA70-CVMP12*	4"	12	24	70"	29	31"	2000	120/240	18.5/9.3
CA70-CVMP15*	3 1/4"	15	30	70"	29	31"	2000	120/240	18.5/9.3
CA43-CV7	3 1/4"	7		42"	24 1/2"	31"	1500	120/240	14.3/7.2
CA43-CV7HW*	3 1/4"	7		42"	24 1/2"	31"	2000	120/240	17.0/8.5
CA43-CV13	1 1/2"	13		42"	24 1/2"	31"	1500	120/240	14.3/7.2
CA43-CV13HW*	1 1/2"	13		42"	24 1/2"	31"	2000	120/240	17.0/8.5
CA43-CVMP6*	4"	6	12	42"	29"	31"	2000	120/240	17.0/8.5
CA43-CVMP7*	3 1/4"	7	14	42"	29"	31"	2000	120/240	17.0/8.5

*Units furnished with 20 AMP plug and cord, NEMA #5-20R

5. TROUBLESHOOTING

If you find that your unit is failing to operate properly refer first to the Operational Procedures in section 3-2 of this manual. Then, if necessary, use the Troubleshooting guide in section 5 to determine the cause of the problem.

****CAUTION:** All maintenance on BEVLES Heating Holding Cabinets should be performed by trained personnel using only quality BEVLES parts.

5-1 TROUBLESHOOTING

To determine the cause of any malfunction:

1. Determine the problem (e.g., the food isn't staying hot).
2. Locate the problem in the Troubleshooting table.
3. Read through the possible causes, then try each solution listed until the problem is resolved.

4. If you are unable to locate the problem in the table or if the solutions listed don't work, please call the BEVLES manufacturing facilities for assistance at (800) 441-1601. You will need to provide the factory personnel with the following information:
 1. The product model and serial numbers.
 2. The specific nature of the problem.

In some cases it will be beneficial to also have the actual operator of the equipment available to answer questions.

5-2 TROUBLESHOOTING TABLE

Problem	Possible Cause	Solution
1. Unit will not heat.	Power switch not in on position.	Place the power switch in the ON position.
	Loose or unplugged power cord.	Plug power cord into proper electrical outlet.
	Thermostat on wrong setting.	Set thermostat to correct temperature.
	Faulty thermostat (not switching heating element on when below set temperature).	Replace thermostat per section 6-1i or j.
	Faulty internal wiring.	Check connections for heating module components per sections 6-11.
	Faulty heating element (not getting hot).	Replace heating element per section 6-11.
	Hi-temperature safety thermostat on.	Check for failure of heating element and/or thermostat not shutting down.
2. Unit not reaching or holding desired Temperature uniformly.	Doors left open or ajar.	Close doors firmly and keep closed except. when loading or unloading product.
	Thermostat on wrong setting.	Set thermostat to correct temperature.
	Faulty thermostat (not switching heating element on when below set temperature).	Replace thermostat per section 6-1i or j.
	Faulty internal wiring.	Check connections for heating module components per section 6-11
	Top mounted heating module seal (gasket) torn or worn.	Replace gasket per section 6-1 m.
	Faulty heater fan blower (no air circulating).	Replace fan blower motor per section 6-1k.
3. Unit overheating.	Faulty thermostat (not switching heating element off when above set temperature).	Replace thermostat per section 6-1i or j.
4. Fan blowers not operating.	Power switch not in on position.	Place the power switch in the on position.
	Loose or unplugged power cord.	Plug power cord into proper electrical outlet.
	Faulty heater fan blower.	Replace fan blower motor per section 6-1k.
	Faulty internal wiring.	Check connections for heating module components per sections 6-11.
5. Cabinet steamy and too humid.	Too much humidity in air flow.	Adjust baffles per section 3-2.
	Holding temperature not high enough.	Adjust thermostat to a higher temperature level.
	Holding product too long in cabinet.	Minimize holding time.
6. Cabinet too dry.	Water pan dry.	Fill 3/4 full with water.
	Not enough humidity in air flow.	Adjust baffles per section 3-2.
	Holding temperature too high.	Adjust thermostat to a lower temperature (never below 140°F).

6. MAINTENANCE

****CAUTION:** All maintenance on BEVLES Heating Holding Cabinets should be performed by trained personnel using only quality BEVLES parts.

6-1 REPLACING PARTS

After using the Troubleshooting table (section 5-2) to determine the solution, refer to the appropriate section below. The tools and equipment needed for each replacement procedure are listed at the beginning of that procedure.

6-1a. Removing the top mounted heating module.

Required: No tools required

1. Unplug unit from power source.
2. Open top front door and remove water pan and baffles.
3. Using two people, lift the top mounted heating module straight up and off of the cabinet (Fig. 8)
4. Set module upside down on a heat resistant surface.

6-1b. Removing the front panel from the heating module.

Required: Medium (6") phillips screwdriver, Medium (6") flathead screwdriver

1. Remove all five screws from the face of the front panel (at the four corners and center top).
2. Gently lift off the front panel while guiding attached wires and thermometer probe to prevent damage. (Fig. 9)
3. Leaving wires attached, gently place front panel face down on a clean work space. (Fig. 10)
4. To replace front cover, reinsert thermometer probe into receptacle, guide wires back into place and reattach panel with the five phillips head screws.

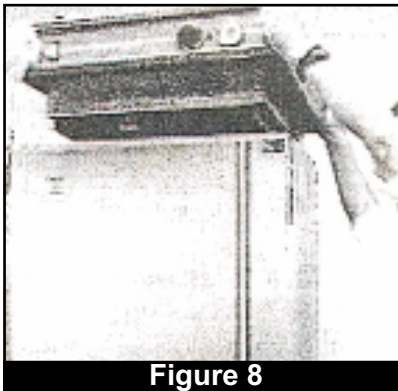

Figure 8

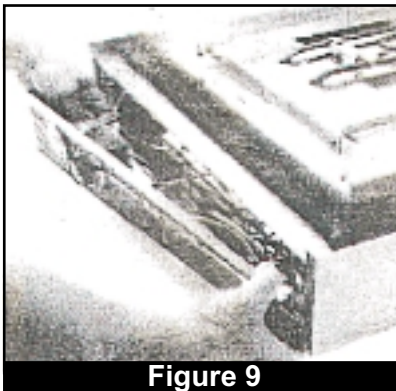

Figure 9

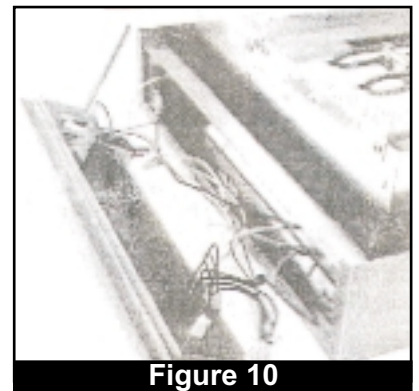

Figure 10

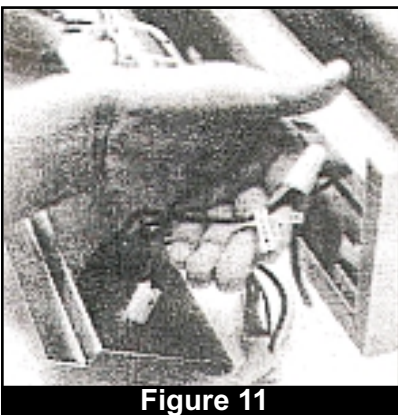

Figure 11

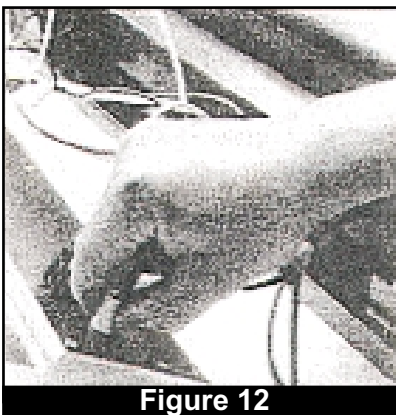

Figure 12

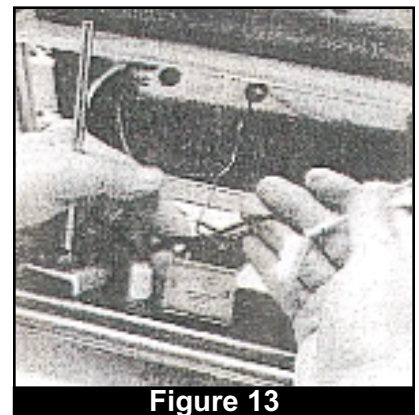

Figure 13

6-1c. Replacing the power indicator lamp module.

Required: Wiring markers (color or number codes), Electrical tape

1. Remove front panel as found in section 6-1b.
2. Mark all the wires connected to the power indicator lamp module with a color code or number to make proper re-connection easy (Fig. 11)
3. Remove the wire nuts and free the power indicator lamp module wires.
4. From the back side of the front panel, depress the plastic tabs on the base of the indicator lamp module and push it out the front of the panel. (Fig. 12)

5. Feed the wires of the replacement indicator lamp module through the opening and snap the new indicator lamp module into place.
6. Reconnect wiring with each of the two new wires going to a different wire nut (it doesn't matter how you match the new module wires). Re-tape over wire nuts and wires.
****WARNING:** Be sure to correctly match the other wires that were connected at the two wire nuts.
7. Replace the front panel (section 6-1b).

6-1d. Replacing the thermostat indicator lamp module.

Required: Medium (6") flathead screwdriver, Medium (6") phillips screwdriver, Wiring markers (color or number codes), Electrical tape

1. Remove front panel as found in section 6-1 b.
2. Mark all the wires connected to the thermostat indicator lamp module and thermostat with a color code or number to make proper re-connection easy. (Fig. 11)
3. Locate the thermostat indicator lamp module wire that connects to a wire nut and remove that wire nut, freeing all wires. (Fig. 13)
4. Remove the indicator lamp module wire from the terminal on the back of the thermostat by removing the electrical tape and reversing the screw.
5. From the back side of the front panel, depress the plastic tabs on the base of the indicator lamp module and push it out the front of the panel. (Fig. 12)
6. Feed the wires of the replacement indicator lamp module through the opening and snap the new indicator lamp module into place.
7. Reconnect wiring with one of the two new wires going to the wire nut and the other to the back of the thermostat (it doesn't matter how you match the new module wires). Re-tape over wire nuts and wires.
****WARNING:** Be sure to correctly match the the other wires that were connected at the wire nut
8. Replace the front panel (section 6-1 b).

6-1e. Replacing the power switch.

Required: Wiring markers (color or number codes), Electrical tape, Wiring diagram for CA43 and CA70 (see step 7 below)

1. Remove front panel as found in section 6-1b.
2. Trace the four wires from the power switch to the wire nuts. Code all wires connected by the four wire nuts to insure proper re-connection. (Fig. 14)
3. Remove the wire nuts and free the power switch wires.
4. From the back side of the front panel, depress the plastic tabs on the base of the power switch and push it out the front of the panel. (Fig. 15)
5. Feed the wires of the replacement switch through the opening and snap the new power switch into place.
6. Reconnect wires using the four wire nuts and the wiring diagram. Re-tape over wire nuts and wires. (Diagram 1)
****WARNING:** Severe damage can be caused to your unit by improperly connecting wiring.
7. Replace the front panel (section 6-1b).

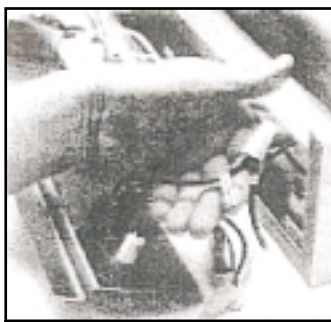

Figure 14

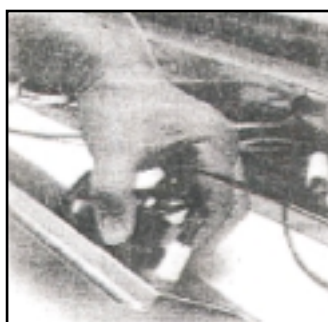

Figure 15

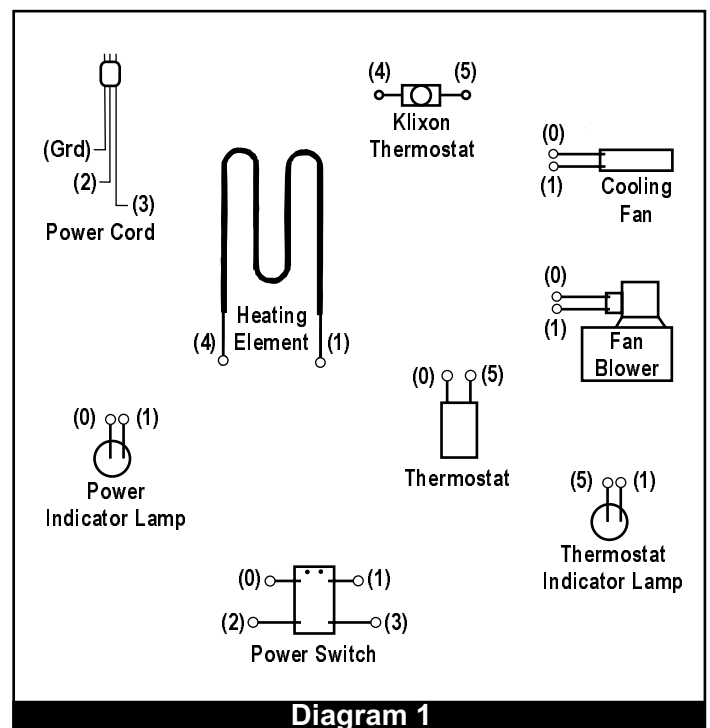

Diagram 1

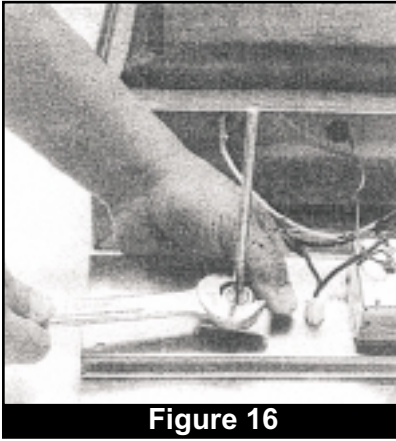

Figure 16

6.1f. Replacing the thermometer.

Required: Crescent or standard 3/4" wrench

1. Remove front panel as found in section 6-1b.
2. Use a crescent or standard 3/4" wrench to loosen the thermometer mounting nut that holds the thermometer in place on the back of the front panel. (Fig. 16)
3. Remove the nut, washer and retaining bracket and pull thermometer out the front of the panel.
4. Replace retaining bracket and insert new thermometer into opening.
****NOTE:** Align thermometer so that the 150° reading will be straight up when the front panel is replaced and the heating module is flipped over. (Fig. 17)
5. Replace and tighten washer and nut on rear of front panel. **DO NOT OVER TIGHTEN!**
6. Replace the front panel (section 6-1b).

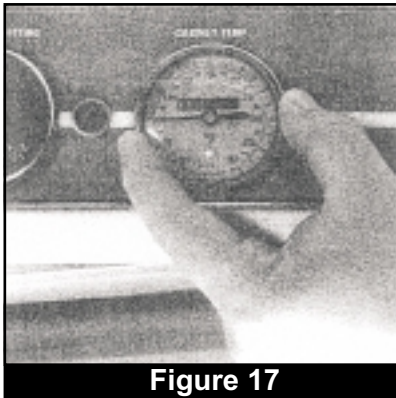

Figure 17

6-1g. Replacing the power cord for a CA70 unit.

Required: Medium (6") phillips screwdriver, Medium (6") flathead screwdriver, Wiring markers (color or number codes), Electrical tape, Wiring diagram for CA70 (see step 10)

1. Remove top mounted heating module and front panel as found in sections 6-1a and 6-1b.
2. Mark all the wires connected to the power cord with a color code or number to make proper re-connection easy. (Fig. 18).
3. Turn the top mounted heating unit over so that the elbow connector for the power cord is up. Free the green ground wire by grasping the nut with fingers or pliers (under front overhang of the heating module) and remove the screw from the exposed surface of the module with a medium (6") phillips screwdriver. (Fig. 19).
4. Free the other two power cord wires by removing the two wire nuts that connect them.
5. Remove elbow connector that secures power cord into the heating module by grasping the nut holding the connector (under the overhang of the heating module). Rotate the nut to loosen and remove the elbow from the module. (Fig. 20)
6. Remove the two screws that secure the power cord into the compression end of the elbow connector with a medium (6") flathead screwdriver. Pull gently to free power cord from the elbow connector. (Fig. 21)
7. Insert new power cord into elbow connector and replace compression screws. Tighten screws to secure power cord into connector.
****WARNING:** Replace only with a BEVLES power cord properly rated for your unit.
8. Insert new wires through opening in the heating module and reattach elbow connector.
9. Reattach green ground wire to module.
10. Reconnect power cord wires using wire nuts and wiring diagram. Re-tape over wire nuts and wires. (Diagram 2)
****WARNING:** Severe damage can be caused to your unit by improperly connecting wiring.
11. Replace the front panel and top mounted heating module (sections 6-1a. and 6-1 b).

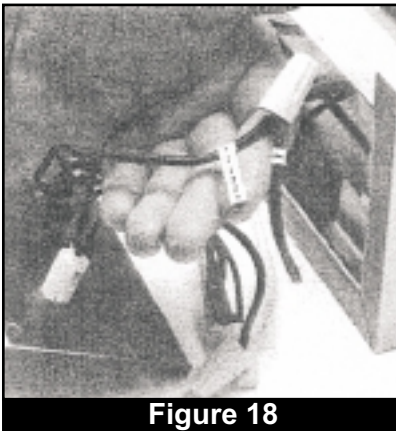

Figure 18

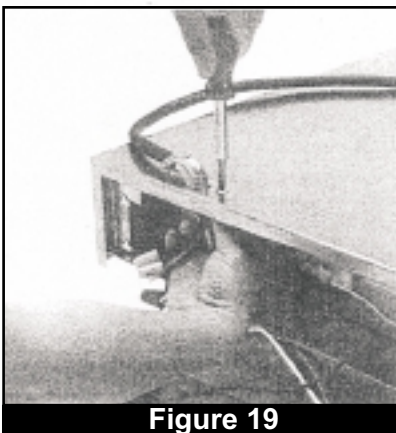

Figure 19

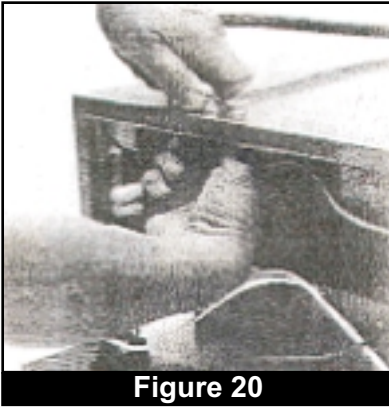

Figure 20

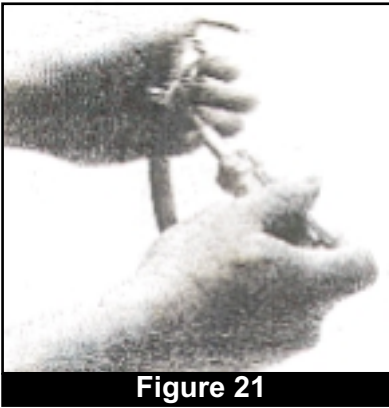

Figure 21

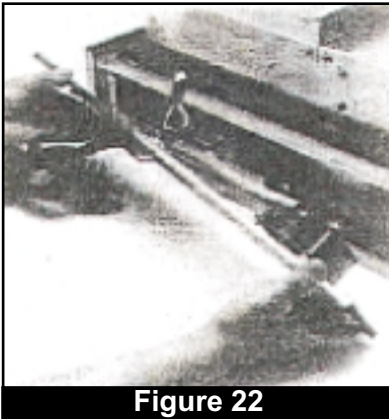

Figure 22

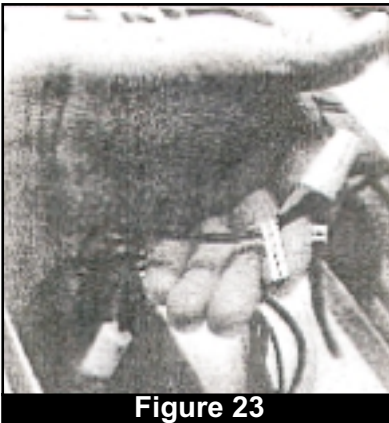

Figure 23

6-1h. Replacing the power cord for a CA43.

Required: Medium (6") phillips screwdriver, Medium (6") flathead screwdriver, Wiring markers (color or number codes), Electrical tape, Wiring diagram for CA43(see step 10)

1. Remove the back panel of the module by removing the five phillips head screws and gently lifting out the back panel. Lay the panel on a clean work surface. (Fig. 22)

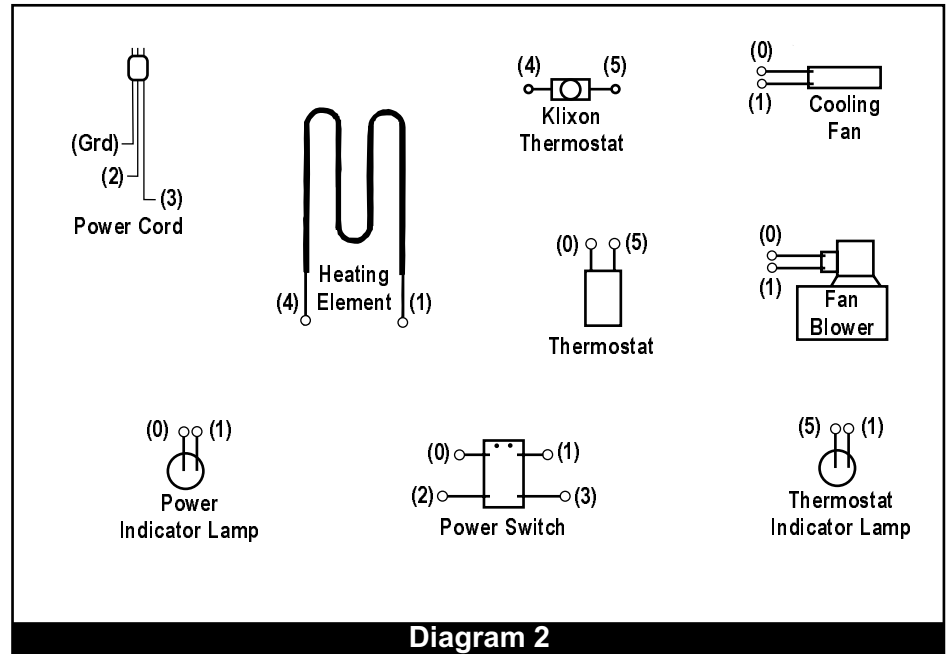

Diagram 2

2. Mark all the wires connected to the power cord with a color code or number to make proper re-connection easy. (Fig. 23)
3. Free the green ground wire by grasping the nut with fingers or pliers (inside the back panel of module) and remove screw from the outside surface of the panel with a medium (6") phillips screwdriver. (Fig. 24)
4. Free the other two power cord wires by removing the two wire nuts they are attached to.
5. Remove elbow connector that secures power cord onto the back panel. While grasping the nut (on the inside surface of the panel) and holding the connector (on the outside surface of the panel), rotate the nut to loosen and remove the elbow from the panel. (Fig. 25).
6. Remove the two screws that secure the power cord into the compression end of the elbow connector with a medium (6") flathead screwdriver. Pull gently to free power cord from the elbow connector. (Fig. 26)
7. Insert new power cord into elbow connector and replace compression screws. Tighten screws to secure power cord into connector.
****WARNING:** Replace only with a BEVLES power cord properly rated for your unit.
8. Insert new wires through opening in back panel and reattach elbow connector.
9. Reattach green ground wire to back panel.
10. Reconnect power cord wires using wire nuts and wiring diagram. Retape over wire nuts and wires. (Diagram 3)
****WARNING:** Severe damage can be caused to your unit by improperly connecting wires.
11. Replace the back panel using the five phillips head screws.

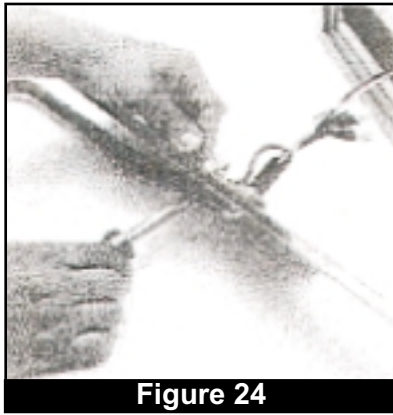

Figure 24

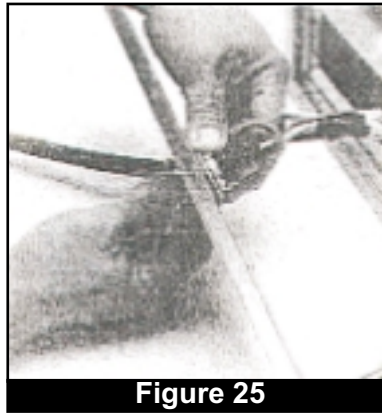

Figure 25

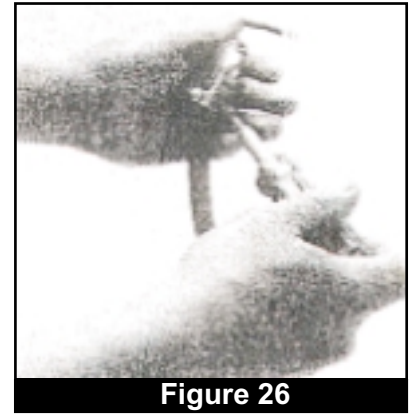

Figure 26

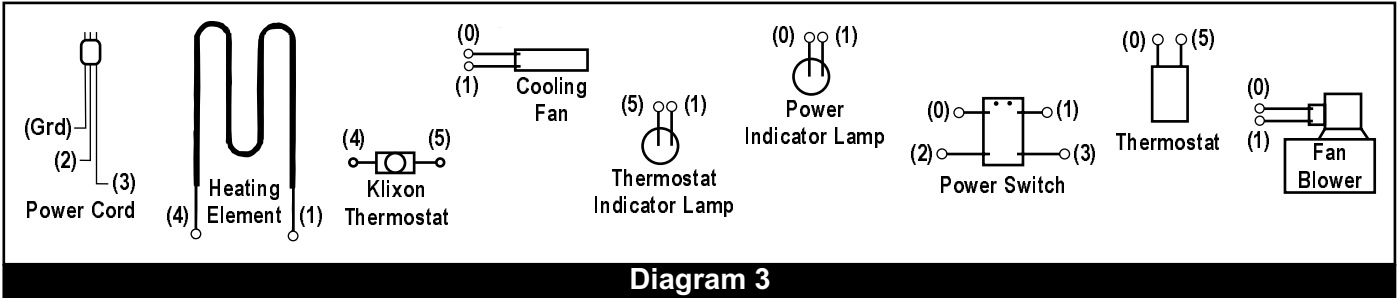

Diagram 3

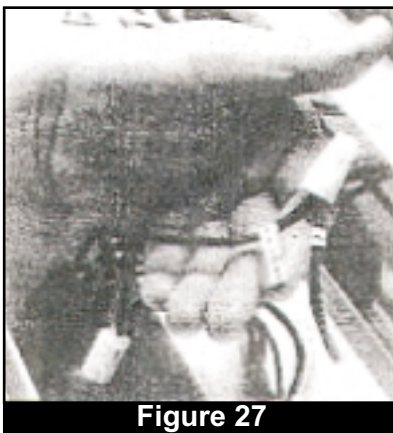

Figure 27

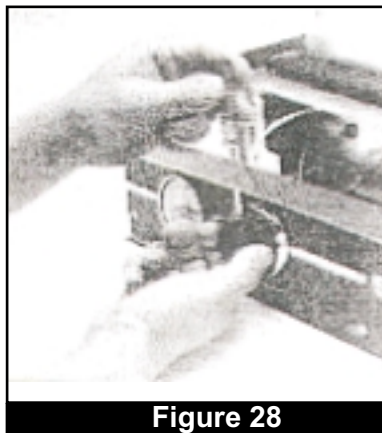

Figure 28

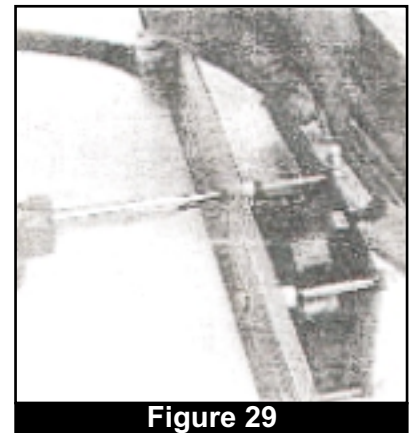

Figure 29

6-1i. Replacing the thermostat for a CA70.

Required: Small flathead screwdriver, Medium (6") flathead screwdriver, Medium (6") phillips screwdriver, Wiring markers (color or number codes), Electrical tape, Wiring diagram for thermostat (see step 9)

1. Remove top mounted heating module and front panel as found in sections 6-1a and 6-1b.
2. Mark all the wires connected to the thermostat with a color code or number to make proper re-connection easy. (Fig. 27)
3. Remove thermostat dial from front panel by rotating the dial to expose the set screw and reversing the set screw with a small flathead screwdriver. (Fig. 28)
4. Remove the two screws holding the bezel (chrome ring) behind the thermostat dial with a medium (6") phillips screwdriver.

Carefully pull thermostat away from the rear of the front cover.

5. Remove the fan blower motor assembly cover (on the left side of module as you are facing the front panel) by removing the two front and two rear screws with a medium (6") flathead screwdriver. (Fig. 29)
6. Remove the two screws securing the clips that attach the copper thermostat probe to the fan blower. Use a medium flathead screwdriver. (Fig. 30)

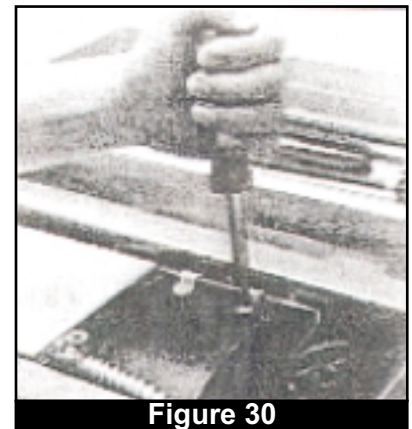

Figure 30

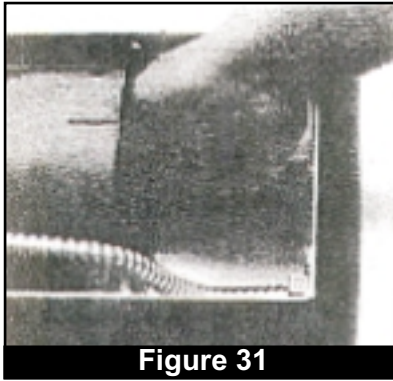

Figure 31

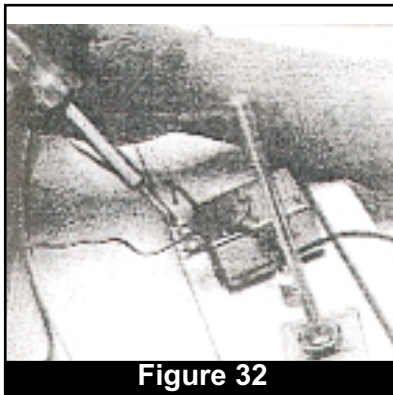

Figure 32

7. Pull the copper thermostat probe and tubing from the fan blower motor assembly area through the opening to the front cover (it may be necessary to feed the probe, into the bottom of the assembly area under the fan blower to achieve the correct angle). (Fig. 31)
****NOTE: DO NOT bend or kink the copper tubing when replacing the thermostat probe.**
8. Disconnect wires from rear of thermostat by reversing screw terminals with a flathead screwdriver.
9. Connect wires to the rear of a new thermostat unit using the thermostat wiring diagram for CA70 units. Re-tape over wire nuts and wires. (Diagram 4)
10. Attach new thermostat to rear of front panel and bezel to the front of panel with the two phillips screws.
****NOTE: The tops of the terminals should face down (toward the actual top of the heating module). (Fig. 32)**
11. Carefully guide new copper probe and tubing through the opening to fan blower motor housing and reattach probe clips with two flathead screws. (Fig. 31)
****NOTE: DO NOT kink or bend the copper probe or tubing.**
12. Replace fan blower motor assembly cover with two front and two rear flathead screws. Do not over tighten.
13. Replace thermostat dial, tightening set screw securely.
14. Replace top mounted heating module and front panel (sections 6-1a and 6-1 b).

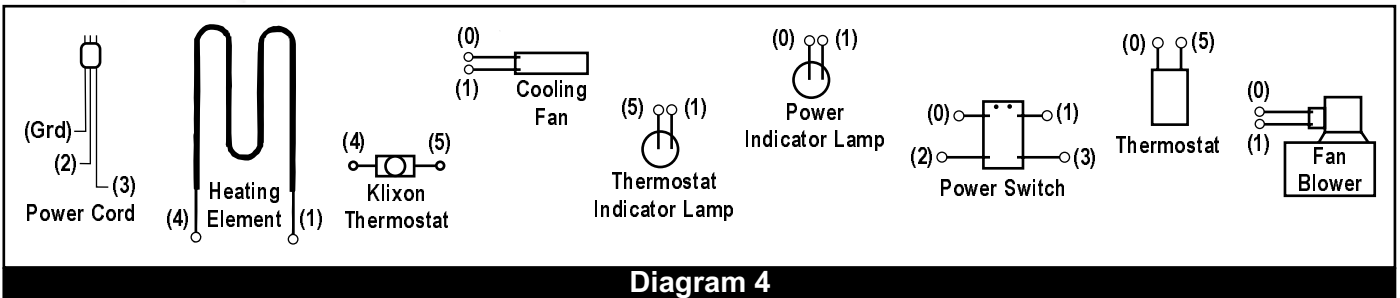

Diagram 4

6-1j Replacing the thermostat for CA43 units.

Required: Small flathead screwdriver, Medium (6") flathead screwdriver, Medium (6") phillips screwdriver, Wiring markers (color or number codes), Electrical tape, Wiring diagram for thermostat (see step 11)

1. Remove top mounted heating module and front panel as found in sections 6-1a and 6-1b.
2. Mark all the wires connected to the power cord with a color code or number to make proper re-connection easy. (Fig. 33)
3. Remove thermostat dial from front panel by rotating the dial to expose the set screw and reversing the set screw with a small flathead screwdriver. (Fig. 34)
4. Remove the two screws holding the bezel (chrome ring) behind the thermostat dial with a medium (6") phillips screwdriver. Carefully pull thermostat away from the rear of the front cover.
5. Remove the fan blower motor assembly cover (on the left side of module as you are facing the front panel) by removing the two front and two rear screws with a medium (6") flathead screwdriver. (Fig. 35)
6. Pry off fan blower housing cover (with a flathead screwdriver, if necessary). Without disconnecting wires, set cover on a clean work area. (Fig. 36)
7. Remove four screws (two at each end) holding fan blower motor bracket in place with a medium flathead screwdriver and gently lift bracket to expose mounting clips for the copper thermostat probe. (Fig. 37)

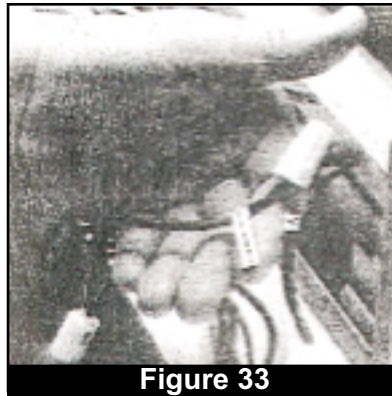

Figure 33

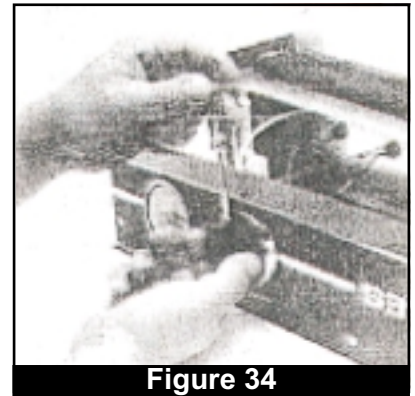

Figure 34

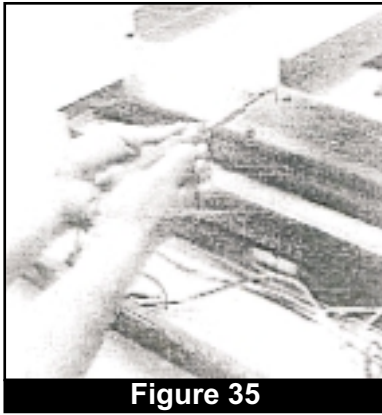

Figure 35

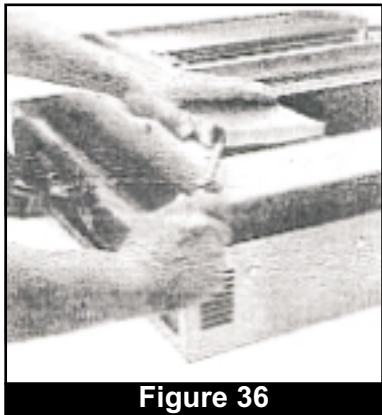

Figure 36

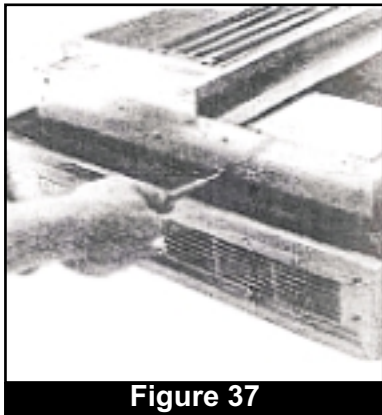

Figure 37

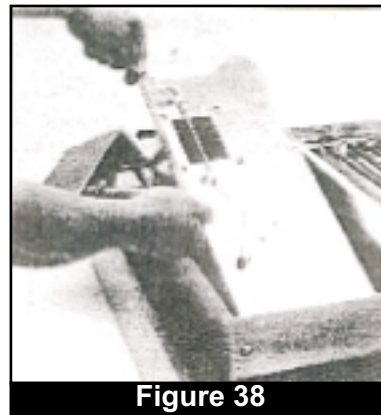

Figure 38

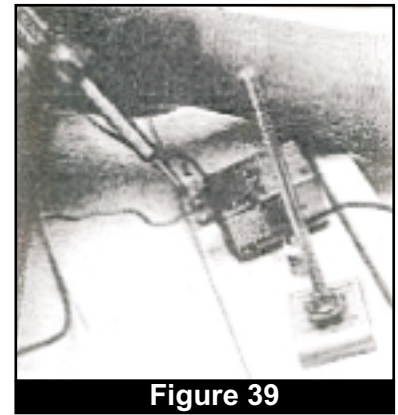

Figure 39

8. Remove the two screws and nuts securing the clips that attach the copper thermostat probe to the motor bracket. Use a medium flathead screwdriver. (Fig. 38)
9. Pull copper probe and tubing from fan blower motor area through the opening to the front panel.
****NOTE: DO NOT bend or kink the copper tubing when replacing the thermostat probe.**
10. Disconnect wires from rear of thermostat by reversing screw terminals with a flathead screwdriver.
11. Connect wires to the rear of a new thermostat unit using the thermostat wiring diagram for CA43 units. Re-tape over wire nuts and wires. (Diagram 5)
12. Attach new thermostat to rear of front panel and bezel to the front of panel with the two phillips screws.
****NOTE: The tops of the terminals should face down (toward actual top of the heating module). (Fig. 39)**
13. Carefully guide new copper probe and tubing through opening to fan blower motor area and reattach probe clips to motor bracket with two flathead screws.
****NOTE: DO NOT kink or bend the copper probe or tubing.**
14. Replace fan blower motor bracket with two phillips screws front and two rear.
15. Replace fan blower motor housing cover, carefully guiding the wires to prevent damage.
16. Replace fan blower motor assembly cover with two front and two rear flathead screws.
17. Replace thermostat dial, tightening set screw securely.
18. Replace top mounted heating module and front panel (sections 6-1 a. and 6-1 b).

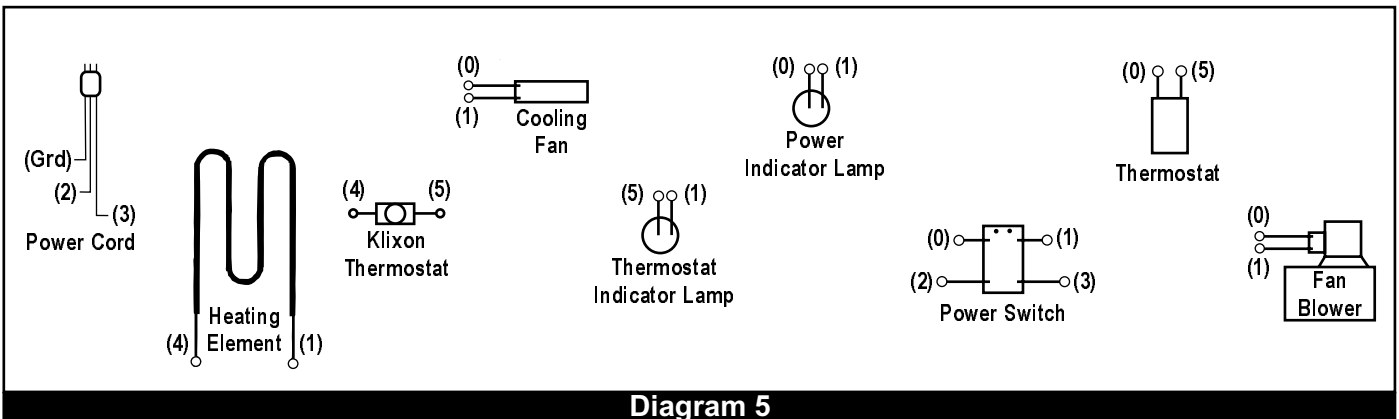

Diagram 5

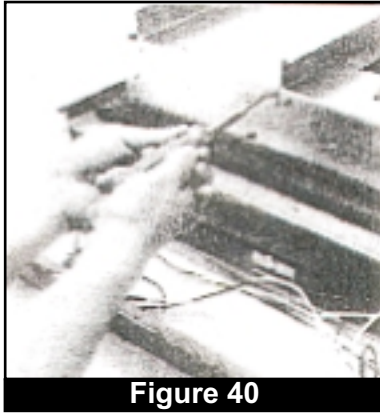

Figure 40

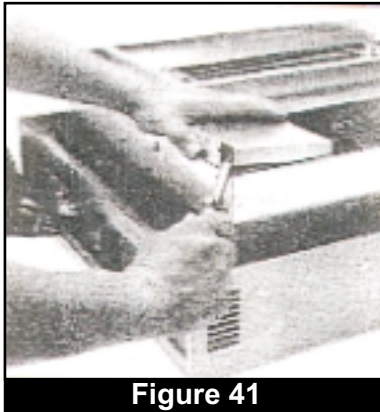

Figure 41

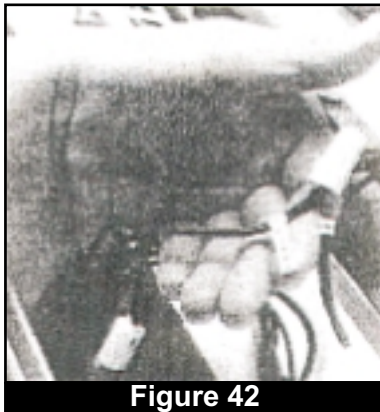

Figure 42

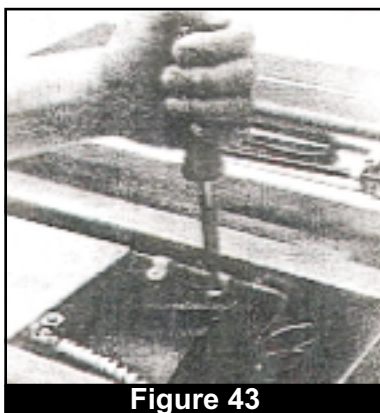

Figure 43

6-1k. Replacing the fan blower motor assembly.

Required: Medium (6") flathead screwdriver, Medium (6") phillips screwdriver, Crescent or standard wrench, Wiring markers (color or number codes), Electrical tape

1. Remove top mounted heating module as found in section 6-1a.
2. Remove the fan blower motor assembly cover (on the left side of module as you are facing the front panel) by removing the two front and two rear screws with a medium (6") flathead screwdriver. (Fig. 40)
3. Pry off fan blower housing cover (with a flathead screwdriver, if necessary). Without disconnecting wires, set cover on a clean work area. (Fig. 41)
4. Mark all the wires connected to the fan blower motor(s) with a color code or number to make proper re-connection easy. (Fig. 42)
5. Remove wire nuts and set cover aside.
6. For CA70 units, remove the two screws securing the clips that attach the copper thermostat probe to the fan blower. Use a medium flathead screwdriver. Free the copper probe and carefully set out of the way. (Fig. 43)
****NOTE:** DO NOT kink or bend copper tubing or probe. Remove four screws (two at each end) that hold the fan blower motor bracket in place. Use a medium flathead screwdriver.
7. For CA43 units, remove four screws (two at each end) that hold the fan blower motor bracket in place. Use a medium flathead screwdriver. Gently lift bracket to expose mounting clips for the copper thermostat probe. Remove the two screws securing the clips holding the copper thermostat probe with medium flathead screwdriver. Free copper probe and carefully set out of the way. (Figs. 44 & 45)
****NOTE:** DO NOT kink or bend copper tubing or probe.
8. Remove fan blower motor bracket with fan blower motor(s) still attached and place entire assembly on a clean work space. (Fig. 46)
9. Remove fan blower motor(s) from mounting bracket by removing four securing screws with a medium (6") flathead screwdriver.
10. Mount new motor(s) in same position with the four phillips screws.
****NOTE:** All replacement motors will have two drilled holes in the blower portion - these are irrelevant unless you are replacing the front motor on a CA70 and will not affect performance in any application.
11. Replace the fan blower motor bracket in heating module with large flange up. (Fig. 46).

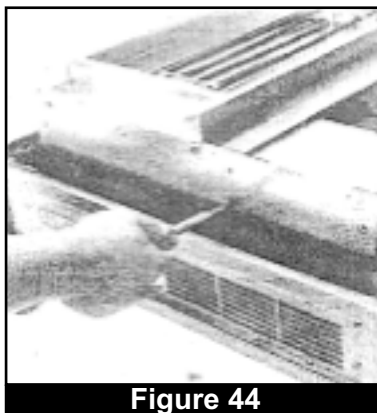

Figure 44

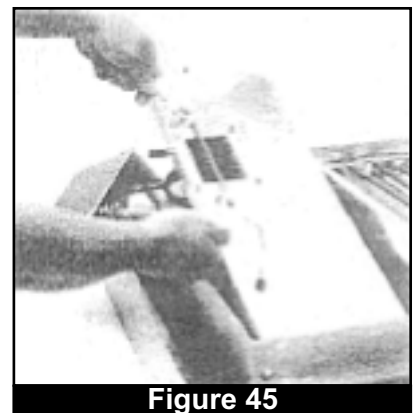

Figure 45

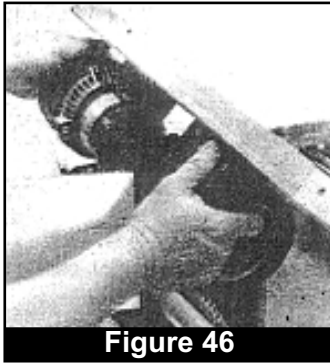

Figure 46

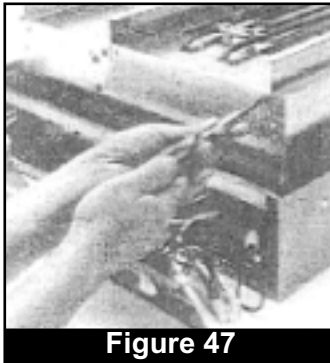

Figure 47

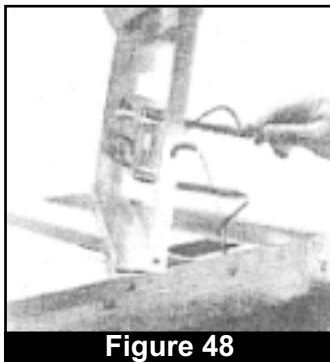

Figure 48

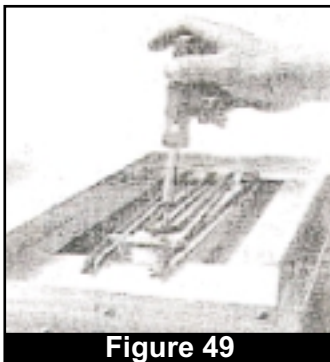

Figure 49

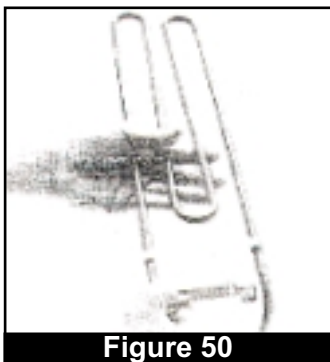

Figure 50

12. For CA70 units, secure fan blower motor bracket with the four phillips screws. Reattach thermostat probe clips with two flathead screws.
****NOTE: DO NOT kink or bend the copper probe or tubing.**
13. For CA43 units, reattach thermostat probe clips with two flathead screws.
****NOTE: DO NOT kink or bend the copper probe or tubing.**
 Secure fan blower motor bracket with the four flathead screws.
14. Reconnect existing wires to new motor wires. It is not important which new wire is matched with which existing wire group. Re-tape over wire nuts and wires.
15. Replace fan blower motor housing cover, carefully guiding the wires to prevent damage.
16. Replace fan blower motor assembly cover with two front and two rear flathead screws.
17. Replace top mounted heating module (section 6-1 a).

6-11. Replacing heating element.

Required: Medium (6") flathead screwdriver, Medium (6") phillips screwdriver, Crescent wrench, General Electric 1209 caulking

1. Remove top mounted heating module as found in section 6-1a.
2. Remove four screws that secure the air deflector housing (on your right as you are facing the front of heating module) to the module with a medium (6") flathead screwdriver.(Fig. 47)
3. Gently lift the air deflector housing to access the nuts connecting wires to the heating element. Remove those nuts and washers to free the wires. (Fig. 48)
4. Remove air deflector housing" and place on a clean work area.
5. Remove four screws securing the heating element brackets to the ceramic insulators with a medium (6") flathead screwdriver. (Fig. 49)
6. Slide brackets off the old element and discard the old element.
7. Slide brackets (large one first) over the connector end of the new heating element. (Fig. 50)
8. Reconnect heating element brackets to the ceramic insulators with the four phillips screws. Do not over tighten.
9. Return air deflector housing to the heating module and reconnect wiring (it is not important which way you match the wires to the new element). (Fig. 51)
10. Caulk openings where the heating element enters the air deflector housing with GE 1209 caulking. (Fig. 52)
11. Reconnect air deflector housing to heating module with the four flathead screws.
12. Replace top mounted heating module (section 6-1a).



Figure 51

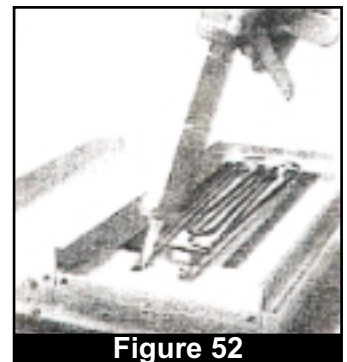

Figure 52

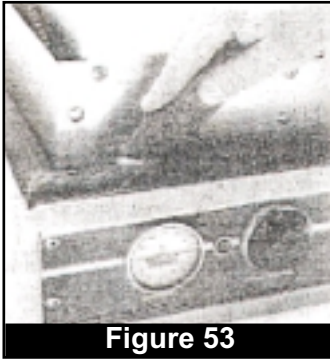

Figure 53

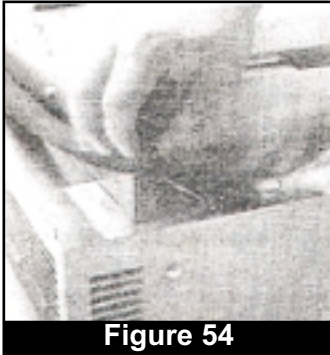

Figure 54

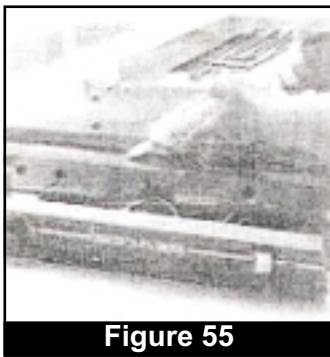

Figure 55

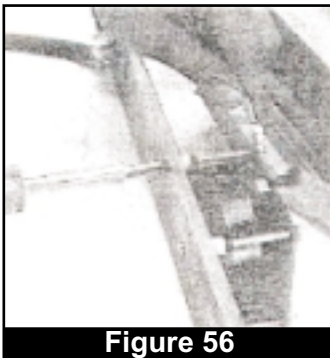

Figure 56

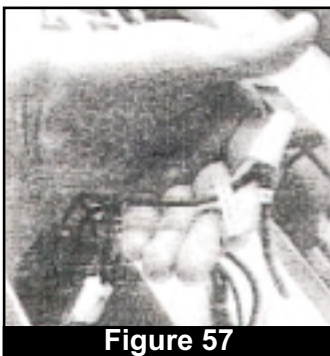

Figure 57

6-1m. Replacing the High-temperature safety thermostat.

Required: Medium (6") flathead screwdriver, Medium (6") phillips screwdriver, Crescent wrench

1. Remove top mounted heating module as found in section 6-1a.
2. Remove four screws that secure the air deflector housing (on your right as you are facing the front of heating module) to the module with a medium (6") flathead screwdriver.
3. Gently lift the air deflector housing to access the nuts and connecting wires to the high temperature safety thermostat. Remove those nuts and washers to free the wires and the thermostat.
4. Attach the new high-temperature thermostat and reconnect the new wires.
5. Reconnect air deflector housing to heating module with the four flathead screws.
6. Replace top mounted heating module (section 6-1 a).

6-1 n. Replacing the top mounted heating module seal (gasket).

Required: Razor blade, General Electric 1209 caulking

1. Remove top mounted heating module as found in section 6-1a.
2. Razor blade old gasket and foam tape off of the heating module. (Fig. 53)
****NOTE:** Remove all caulking and material carefully. A good seal requires a clean surface.
3. Set new gasket into place using double-face foam tape (included with new gasket) to attach new gasket to module. (Fig. 54)
4. Caulk inner and outer edges of new gasket with GE 1209 caulking. Allow caulking to dry for at least 45 minutes. (Fig. 55)
5. Replace top mounted heating module (section 6-1a).

6.1o. Replacing the fan blower cooling fan for CA43 units.

Required: Medium (6") flathead screwdriver, Medium (6") phillips screwdriver, Wiring markers (color or number codes), Electrical tape

1. Remove the back panel of the module by removing the five flathead screws and gently removing the back panel. Lay the panel on a clean work surface.
2. Remove four screws inside the back panel that secure the cooling fan to the back panel with a medium (6") flathead screwdriver. Save spacers for reuse. (Fig. 56)
3. Mark all the wires connected to the cooling fan with a color code or number to make proper re-connection easy. (Fig. 57)
4. Remove wire nuts and retain wire sleeve for reuse. Discard old cooling fan (if under warranty and requested by BEVLES, send fan and Return Material Authorization form to the factory for credit).
5. Slip reserved wire sleeve onto the wires of the new cooling fan.
6. Connect new cooling fan wires to existing wires. It is not important which way you match the new wires.
7. Carefully insert nylon spacers between the cooling fan and back panel. Connect new fan to the back panel with the four flathead screws. (Fig. 56)
8. Replace back panel with the five flathead screws.
9. Replace top mounted heating module (section 6-1a).

7. REPLACEMENT PARTS

Use only BEVLES replacement parts in repairing your unit. This assures you of continued high quality performance.

7-1 HOW TO ORDER

To determine the parts you need:

1. Use the drawings found in section 7-5 and refer to the parts list in section 7-6 to determine the BEVLES part numbers you need.
2. Note the model number, serial number and the date of manufacture of your unit from the serial number label (located in the top right front corner of the right side of the unit).
3. Call the BEVLES manufacturing facilities at (214) 421-7366 or (800) 441-1601 (outside of Texas and Alaska).

7-2 PRICES

Your distributor can provide you with a current price list for replacement parts. Or, call the BEVLES manufacturing facilities for the most recent prices.

7-3 SHIPPING

Common parts are in-stock for immediate processing. Normally, replacement parts will be shipped within two working days.

7-4 WARRANTY

Replacement parts are fully covered by the parts provisions of the BEVLES quality assurance warranty at the front of this manual.

7-5 PARTS DRAWINGS

Exploded drawings provided for:

Model Number	Drawing Number
CA70-CV16, CV16HW, CV32, CV32HW, CVMP12, CVMP15	7-5a. Heating Module 7-5b. Cabinet Assembly
CA43-CV7, CV7HW, CV13,..CV13HV, CVMP6, CVMP7	7-5c. Heating Module 7-5d. Cabinet Assembly

CA70 MODELS

7-5a. Heating Module for CA70 Models	
Drawing Reference Number	Description
1	Heating Module
1A	Heating Module, MP
1B	Heating Module, HW
2	Front Control Panel
2A	Front Control Panel, MP
3	Sheet Metal Screw, #10 x 1/2 s/s phillips
4	Flat Washer, AN960-CIOL sls
5	Thermometer, 6" 50-250°F
6	Thermometer Mounting Bracket
7	Nut, Thermometer Mounting Bracket
8	Indicator Lamp, Solico 5SF3LRN1-6
9	Thermostat, 50-250°F
10	Mounting Screw, #6-32 x 1/4" rd. hd. s/s phillips
11	Knob, Thermostat 50-250°F
12	Socket Set Screw, Thermostat Knob #8-32
13	Clamp, Thermostat Probe
14	Power Switch, LTIGK-6S-WH-NBL
15	Blower Motor
16	Mounting Screw, #10-24 x 1/2" sls phillips
17	Lockwasher, #10 s/s internal tooth
18	Nut, #10-24 hex s/s
20	Motor Air Duct Cover
21	Water Pan Slide
22	Heating Element, 1500W, 120V
22A	Heating Element, 1800W, 120V (MP or HW Models)
23	Front Clip, 0.81" x 4.875"
24	Rear Clip, 0.81" x 5.87" .
25	Ceramic Insulator
26	Screw, #6-32 x 1/4" sls phillips
27	Lockwasher, #6 s/s
28	Power Cord, 14-3 SO
28A	Power Cord, 12-3 SO (MP or HW Models)
29	Elbow Connector
30	High-Temperature (Klixon) Thermostat, 120V/240V
31	Lockwasher, Elbow Connector
32	Elbow Connector Nut
33	Air Flow Cover Extension, MP
34	Motor Housing Cover
34A	Motor Housing Cover, MP

7-5b. Cabinet Assembly for CA70 Models	
Drawing Reference Number	Description
1	Heating Module
1A	Heating Module, MP
1B	Heating Module, HW
2	Cabinet Assembly
2A	Cabinet Assembly, MP
3	Dutch Door, Upper
3A	Dutch Door, Upper for MP
4	Dutch Door, Bottom
4A	Dutch Door, Bottom for MP
5	Full Door
5A	Full Door, MP
6	Door Hinge, 2"
7	Cabinet Hinge, 3"
8	Hinge Pin, 5/16" x 5" rod
9	Machine Screw, 1/4"-20 x 1/2" phillips
10	Latch
11	Latch Strike
12	Latch Pin, 5/16" x 8.5" rod
13	Latch Spring #CDL5019
14	Wiper Blade
14A	Wiper Blade, MP
15	Wiper Blade Retainer
15A	Wiper Blade Retainer, MP
16	Thumb Screw, bakelite
17	Air Duct Assembly, upper (CV32)
18	Air Duct Assembly, lower (CV32)
19	Button, aluminum #10-23-75R
20	Sheet Metal Screw, T/H #8 x 1 1/4" phillips
21	Water Pan
22	Baffle, 22 ga. 7" x 8.5"
23	Door Gasket, magnetic 21.5" x 57"
23A	Door Gasket, magnetic 26" x 57", MP
24	Gasket Retainer, top outer 22.37"
24A	Gasket Retainer, top outer 26.87", M
25	Gasket Retainer, bottom outer 22.37"
25A	Gasket Retainer, bottom outer 26.87", MP
26	Gasket Retainer, side outer 58.37"
27	Sheet Metal Screw, #6 x 3/4" hex head
28	Caster, 5' with brake
29	Caster, 5' without brake
30	Nut, hex 5/16" -18
31	Lockwasher, 5/16" internal tooth .
32	Bolt, hex 5/16" -18 x 1 1/4"
33	Air Duct Assembly, upper (Cv16)
34	Air Duct Assembly, lower (Cv16)
35	Air Duct Assembly, upper (CVMP12)
36	Air Duct Assembly, lower (CVMP12)
37	Wire Hanger, MP
38	Air Duct Assembly, upper (CVMP15)
39	Air Duct Assembly, lower (CVMP15)
40	Extruded Runner, MP

CA43 MODELS

7-5c. Heating Module for CA43 Models	
Drawing Reference Number	Description
1	Heating Module
1A	Heating Module, MP
1B	Heating Module, HW
2	Front Control Panel
2A	Front Control Panel, MP
3	Sheet Metal Screw, #10 x 1/2" S/S phillips
4	Flat Washer, AN96O-C1OL S/S
5	Thermometer, 8" 50-250°F
6	Thermometer Mounting Bracket
7	Nut, Thermometer Mounting Bracket
8	Indicator Lamp, Solico SSF3LRN1-6
9	Thermostat, 50-250°F
10	Mounting Screw, #6-32 x 1/4" rd. hd. s/s phillips
11	Knob, thermostat 50-250°F
12	Socket Set Screw, Thermostat Knob #8-32
13	Clamp, Thermostat Probe
14	Power Switch, LTIGK-6S-WH-NBL
15	Blower Motor
16	Mounting Screw, #10-24 x 1/2" s/s phillips
17	Lockwasher, #10 S/S internal tooth
18	Nut, #10-24 hex s/s
19	Motor Air Duct
20	Motor Air Duct Cover
21	Water Pan Slide
22	Heating Element, 1500W, 120V
22A	Heating Element, 1800W, 120V (MP or HW Models)
23	Front Clip, 0.81" x 4.875"
24	Rear Clip, 0.81" x 5.87"
25	Ceramic Insulator
26	Screw, #6-32 x 1/4" s/s phillips
27	Lockwasher, #6 s/s
28	Power Cord, 14-3 SO
28A	Power Cord, 12-3 SO (MP or HW Models)
29	Elbow Connector
30	Cooling Fan
31	Machine Screw, #10-24 x 2" phillips
32	Spacer
33	High-Temp. (Klixon) Thermostat, 120V/240V
34	Rear Panel
34A	Rear Panel, MP
35	Elbow Connector Nut
36	Lockwasher, Elbow Connector
37	Motor Housing Cover
37A	Motor Housing Cover, MP
38	Air Flow Cover Extension, MP

7-5d. Cabinet Assembly for CA43 Models	
Drawing Reference Number	Description
1	Heating Module
1A	Heating Module, MP
1B	Heating Module, HW
2	Cabinet Assembly
2A	Cabinet Assembly, MP
3	Front Door
3A	Front Door for MP
5	Rear Door
5A	Rear Door, MP
6	Door Hinge, 2"
7	Cabinet Hinge, 3"
8	Hinge Pin, 5/16" x 5" rod
9	Machine Screw, 1/4"-20 x 1/2" phillips
10	Latch
11	Latch Strike
12	Latch Pin, 5/16" x 8.5" rod
13	Latch Spring #CDL5019
17	Air Duct Assembly (CV13)
19	Button, aluminum #10-23-75R
20	Sheet Metal Screw, T/H #8 x 1/4" phillips
21	Water Pan
22	Baffle, 22 ga 7" x 8.5"
23	Door Gasket, magnetic 21.5" x 28.5"
23A	Door Gasket, magnetic 26" x 28.5", MP
24	Gasket Retainer, top outer 22.37"
24A	Gasket Retainer, top outer 26.87", MP
25	Gasket Retainer, bottom outer 22.37"
25A	Gasket Retainer, bottom outer 26.87", MP
26	Gasket Retainer, side outer 29.5"
27	Sheet Metal Screw, #6 x 3/4" hex head
28	Caster, 5" with brake
29	Caster, 5" without brake
30	Nut, hex 5/16"-18
31	Lockwasher, 5/16" internal tooth
32	Bolt, hex 5/16"-18 x 1 1/4"
33	Air Duct Assembly (CV7)
34	Air Duct Assembly (CVMP6)
35	Wire Hanger, MP
36	Air Duct Assembly (CVMP7)
37	Extruded Runner, MP

7-5a. EXPLODED VIEW - HEATING MODULE FOR CA70 MODELS

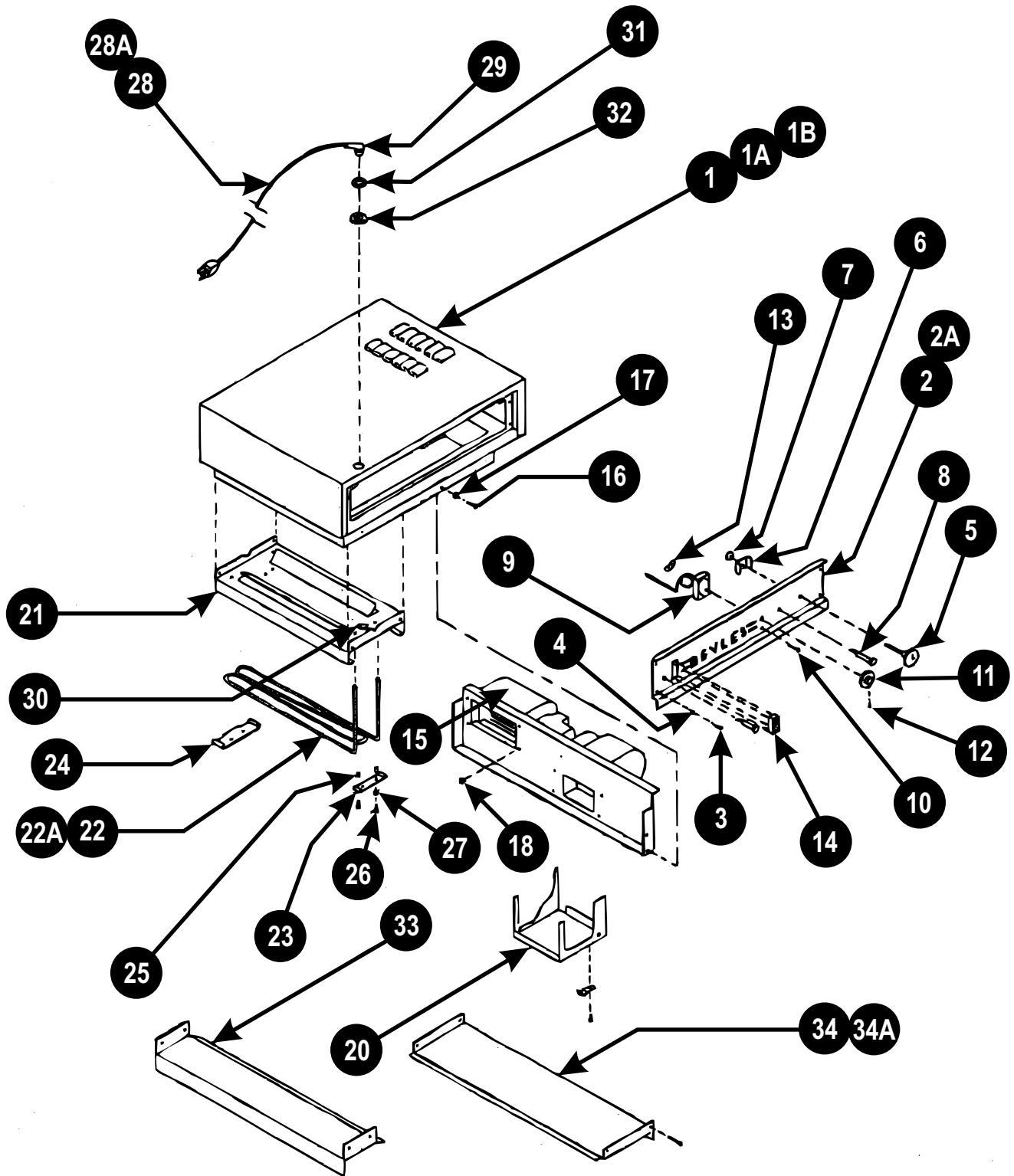

7-5b. EXPLODED VIEW - CABINET ASSEMBLY FOR CA70 MODELS

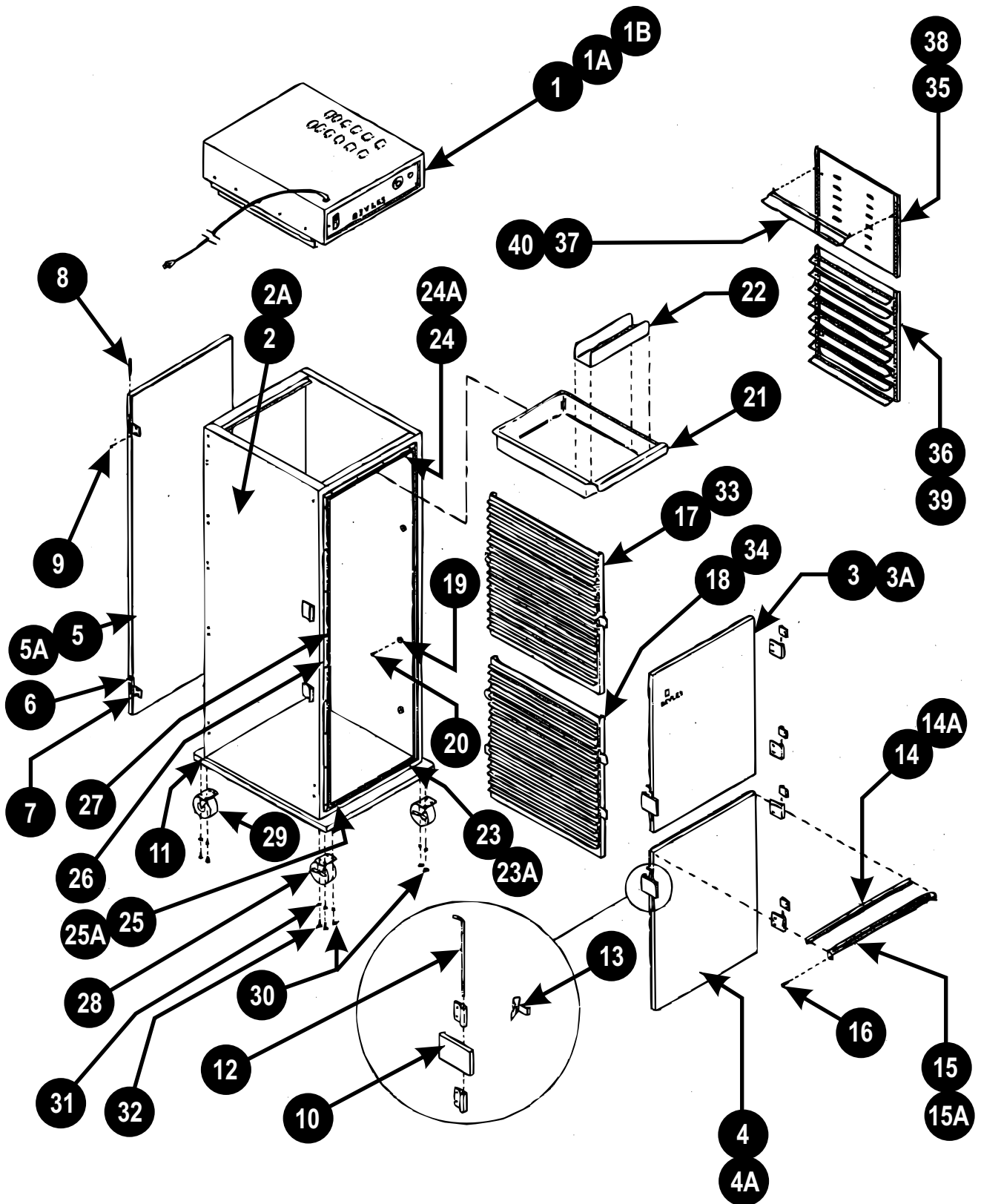

7-5c. EXPLODED VIEW - HEATING MODULE FOR CA43 MODELS

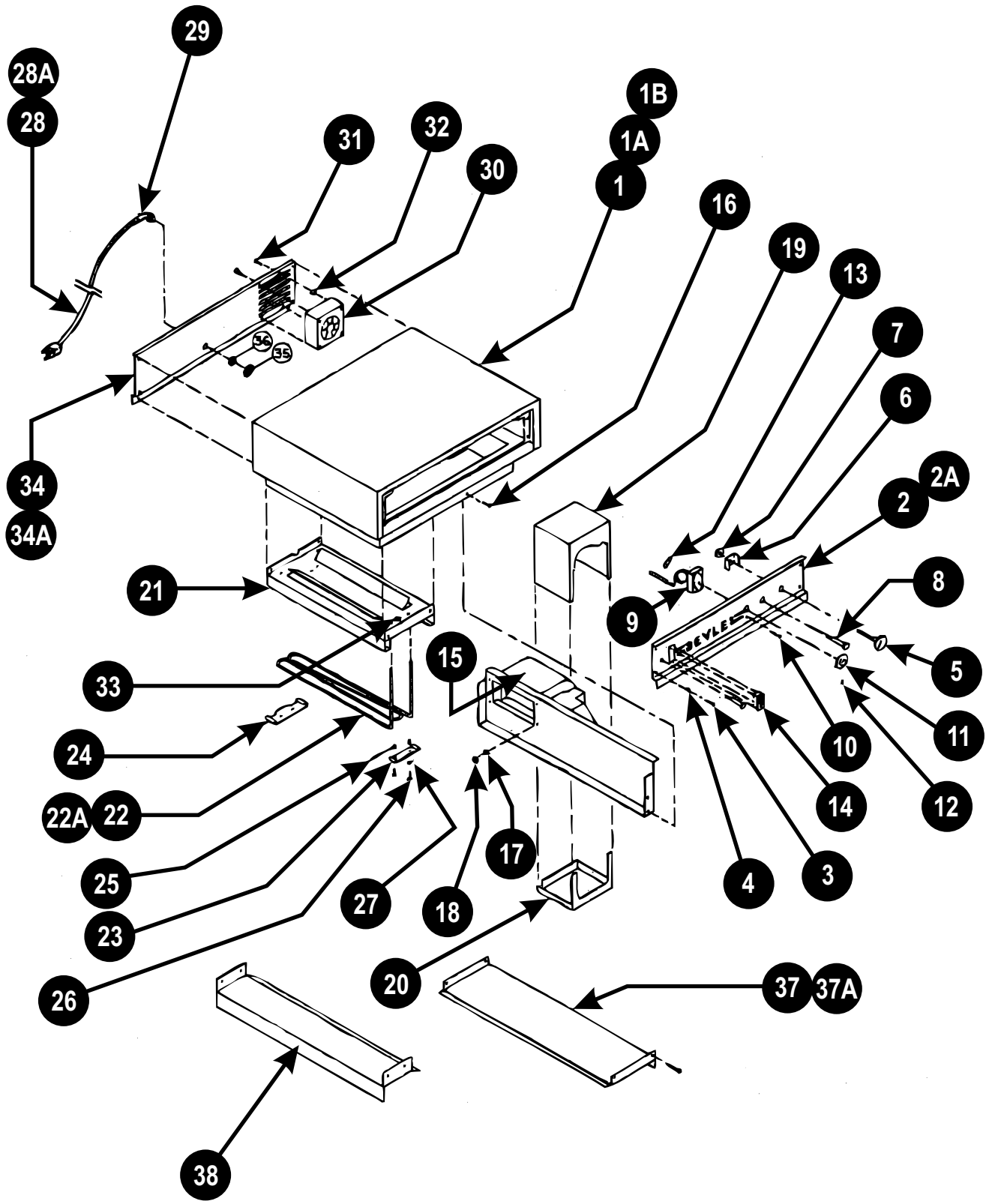

7-5d. EXPLODED VIEW - CABINET ASSEMBLY FOR CA43 MODELS

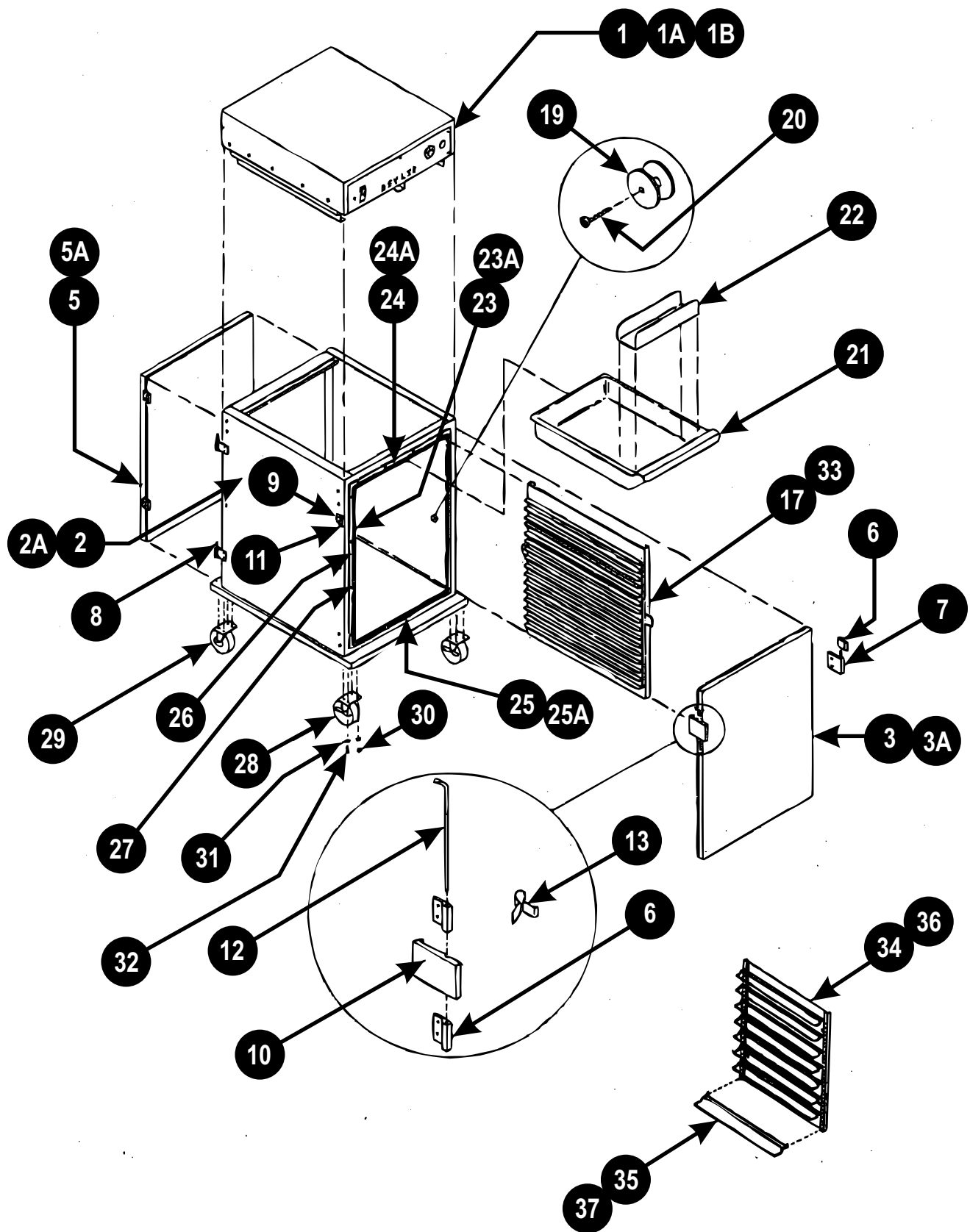

7-6 PARTS LIST

Model Number	List Number	Model Number	List Number
CA70-CV16	7-6a. Heating Module	CA43-CV7	7-6i. Heating Module
CV16HW	7-6b. Heating Module Control Panel	CV7HW	7-6j. Heating Module Control Panel
CV32	7-6c. Heating Module Blower Motor	CV13	7-6k. Heating Module Blower Motor
CV32HW	7-6d. Heating Module Heating Element	CV13HW	7-6l. Heating Module Heating Element
CVMP12	7-6e. Cabinet	CVMP6	7-6m. Cabinet
CVMP15	7-6f. Cabinet Interior	CVMP7	7-6n. Cabinet Interior
	7-6g. Cabinet Full Door		7-6o. Cabinet Front Door
	7-6h. Cabinet Dutch Door (Top and Bottom)		7-6p. Cabinet Rear Door

7-6a. Heating Module Parts List (CA70 Mdl's)		
Dwg 7-5a Ref #	Part Number	Description
1	20024	Heating Module
1A	20128	Heating Module, MP
1B	20136	Heating Module, HW
2	41060	Front Control Panel
2A	41152	Front Control Panel, MP
3	70169	Sheet Metal Screw, #10 x 1/2" s/s phillips
4	70104	Flat Washer; AN960-C10L s/s
5	82128	Thermometer, 6" 50-250°F
6	50468	Thermometer Mounting Bracket
7	70288	Nut, Thermometer Mounting Bracket
8	82116	Indicator Lamp, Salico 5SF3LRN1-6
9	82132	Thermostat, 50-250°F
10	70212	Mounting Screw, #6-32 x 1/4" rd. hd. s/s phillips
11	82136	Knob, thermostat 50-250°F
12	70284	Socket Set Screw, Thermostat Knob #8-32
13	83112	Clamp, Thermostat Probe
14	82082	Power Switch, LTIGK-6S-WH-NBL
15	82024	Blower Motor
16	70173	Mounting Screw, #10-24 x 1/2" s/s phillips
17	70144	Lockwasher, #10 s/s internal tooth
18	70141	Nut, #10-24 hex s/s
20	41068	Motor Air Duct Cover
21	41052	Water Pan Slide
22	82124	Heating Element, 1500W, 120V
22A	82296	Heating Element, 1800W, 120V (MP or HW Mdl's)
23	41044	Front Clip, 0.81" x 4.875"
24	41048	Rear Clip, 0.81" x 5.87"
25	83104	Ceramic Insulator
26	70189	Screw, #6-32 x 1/4" s/s phillips
27	70292	Lockwasher, #6 s/s
28	82076	Power Cord, 14-3 SO
28A	82068	Power Cord, 12-3 SO (MP or HW Models)
29	83108	Elbow Connector
30	82208	High-Temp. (Klixon) Thermostat, 120V/240V
31	70312	Lockwasher, Elbow Connector
32	70316	Elbow Connector Nut
33	41172	Air Flow Cover Extension, MP
34	41072	Motor Housing Cover
34A	41136	Motor Housing Cover, MP

7-6b. Heating Module Control Panel Parts List (CA70 Mdl's)		
Dwg 7-5a Ref #	Part Number	Description
2	41060	Front Control Panel
2A	41152	Front Control Panel, MP
3	70169	Sheet Mtl Screw, #10 x 1/2" s/s phillips
4	70104	Flat Washer, AN960-C10L s/s
5	82128	Thermometer, 6" 50-250°F
6	50468	Thermometer Mounting Bracket
7	70288	Nut, Thermometer Mounting Bracket
8	82116	Indicator Lamp, Solico 5SF3LRN1-6
9	82132	Thermostat, 50-250°F
10	70212	Mounting Screw, #6-32 x 1/4" rd. hd. s/s phillips
11	82136	Knob, thermostat 50-250°F
12	70284	Socket Set Screw, Thermostat Knob #8-32
13	83112	Clamp, Thermostat Probe
14	82082	Power Switch, LTIGK-6S-WH-NBL

7-6c. Heating Module Blower Motor Parts List (CA70 Mdl's)		
Dwg 7-5a Ref #	Part Number	Description
3	70169	Sheet Mtl Screw, #10 x 1/2" s/s phillips
15	82024	Blower Motor
16	70173	Mounting Screw, #10-24 x 1/2" s/s phillips
17	70144	Lockwasher, #10 s/s internal tooth
18	70141	Nut, #10-24 hex s/s
20	41068	Motor Air Duct Cover
33	41172	Air Flow Cover Extension, MP
34	41072	Motor Housing Cover
34A	41136	Motor Housing Cover, MP

7-6d. Heating Element Parts List (CA70 Mdl's)		
Dwg 7-5a Ref #	Part Number	Description
22	82124	Heating Element, 1500W, 120V
22A	82296	Heating Element, 1800W, 120V (MP or HW Mdl's)
23	41044	Front Clip, 0.81" x 4.875"
24	41048	Rear Clip, 0.81" x 5.87"
25	83104	Ceramic Insulator
26	70189	Screw, #6-32 x 1/4" s/s phillips
27	70292	Lockwasher; #6 s/s
30	82208	High-Temp (Klixon) Thermostat, 120/240V

7-6e. Cabinet Parts List (CA70 MdlS)		
Dwg 7-5b Ref #	Part Number	Description
1	20024	Heating Module
1A	20128	Heating Module, MP
1B	20136	Heating Module, HW
2	20028	Cabinet Assembly
2A	20030	Cabinet Assembly, MP
3	20032	Dutch Door, Upper
3A	20108	Dutch Door, Upper for MP
4	20036	Dutch Door, Bottom
4A	20112	Dutch Door, Bottom for MP
5	20040	Full Door
5A	20116	Full Door, MP
6	50132	Door Hinge, 2"
7	50140	Cabinet Hinge, 3"
8	50736	Hinge Pin, 5/16" x 5" rod
9	70073	Machine Screw, 1/4"-20 x 1/2" phillips
10	50392	Latch
11	50400	Latch Strike
12	50720	Latch Pin, 5/16" x 8.5" rod
13	83044	Latch Spring #CDL5019
14	83096	Wiper Blade, 20"
14A	83098	Wiper Blade, 24.5", MP
15	40916	Wiper Blade Retainer
15A	40918	Wiper Blade Retainer, MP
16	70280	Thumb Screw, bakelite
17	20044	Air Duct Assembly, upper (CV32)
18	20048	Air Duct Assembly, lower (CV32)
19	83008	Button, aluminum #10-23-75R
20	70257	Sheet Metal Screw, T/H #8 x 1/4" phillips
21	83100	Water Pan
22	41040	Baffle, 22 ga 7" x 8.5"
23	83120	Door Gasket, magnetic 21.5" x 57"
23A	84024	Door Gasket, magnetic 26" x 57", MP
24	50744	Gasket Retainer, top. outer 22.37"
24A	50814	Gasket Retainer, top outer 26.87", MP
25	50744	Gasket Retainer, bottom outer 22.37"
25A	50814	Gasket Retainer, bottom outer 26.87", MP
26	50740	Gasket Retainer, side outer 58.37"
27	70276	Sheet Metal Screw, #6 x 3/4" hex head
28	80036	Caster, 5" with brake
29	80040	Caster, 5" without brake
30	70068	Nut, hex 5/16"-18
31	70040	Lockwasher, 5/16" internal tooth
32	70324	Bolt, hex 5/16"-18 x 1 1/4"
33	20046	Air Duct Assembly, upper (CV16)
34	20050	Air Duct Assembly, lower (CV16)
35	20152	Air Duct Assembly, upper (CVMP12)
36	20154	Air Duct Assembly, lower (CVMP12)
37	30028	Wire Hanger, MP
38	20156	Air Duct Assembly, upper (CVMP15)
39	20158	Air Duct Assembly, lower (CVMP15)
40	50820	Extruded Runner, MP

7-6f. Cabinet Interior Parts List (CA70 MdlS)		
Dwg 7-5b Ref #	Part Number	Description
17	20044	Air Duct Assembly, upper (CV32)
18	20048	Air Duct Assembly, lower (CV32)
19	83008	Button, aluminum #10-23-75R
20	70257	Sheet Mtl Screw, T/H #8 x 1 1/4" phillips
33	20046	Air Duct Assembly, upper (CV16)
34	20050	Air Duct Assembly, lower (CV16)
35	20152	Air Duct Assembly, upper (CVMP12)
36	20154	Air Duct Assembly, lower (CVMP12)
37	30028	Wire Hanger, MP
38	20156	Air Duct Assembly, upper (CVMP15)
39	20158	Air Duct Assembly, lower (CVMP15)
40	50820	Extruded Runner, MP

7-6g. Cabinet Full Door Parts List (CA70 MdlS)		
Dwg 7-5b Ref #	Part Number	Description
5	20040	Full Door
5A	20116	Full Door, MP
6	50132	Door Hinge, 2"
7	50140	Cabinet Hinge, 3"
8	50736	Hinge Pin, 5/16" x 5" rod
9	70073	Machine Screw, 1/4"-20 x 1/2" phillips
10	50392	Latch
11	50400	Latch Strike
12	50720	Latch Pin, 5/16" x 8.5" rod
13	83044	Latch Spring #CDL5019

7-6h. Cabinet Dutch Door Parts List (CA70 MdlS)		
Dwg 7-5b Ref #	Part Number	Description
3	20032	Dutch Door, Upper
3A	20108	Dutch Door, Upper for MP
4	20036	Dutch Door, Bottom
4A	20112	Dutch Door, Bottom for MP
6	50132	Door Hinge, 2"
7	50140	Cabinet Hinge, 3"
8	50736	Hinge Pin, 5/16" x 5" rod
9	70073	Machine Screw, 1/4"-20 x 1/2" phillips
10	50392	Latch
11	50400	Latch Strike
12	50720	Latch Pin, 5/16" x 8.5" rod
13	83044	Latch Spring #CDL5019
14	83096	Wiper Blade, 20"
14A	83098	Wiper Blade, 24.5", MP
15	40916	Wiper Blade Retainer
15A	40918	Wiper Blade Retainer, MP
16	70280	Thumb Screw, bakelite

7-6i. Heating Module Parts List (CA43 MdlS)

Dwg 7-5c Ref #	Part Number	Description
1	20068	Heating Module
1A	20132	Heating Module, MP
1B	20140	Heating Module, HW
2	41060	Front Control Panel
2A	41152	Front Control Panel, MP
3	70169	Sheet Metal Screw, #10 x 1/2" s/s phillips
4	70104	Flat Washer, AN960-C10L s/s
5	82128	Thermometer, 6" 50-250°F
6	50468	Thermometer Mounting Bracket
7	70288	Nut, Thermometer Mounting Bracket
8	82116	Indicator Lamp, Solico 5SF3LRN1-6
9	82132	Thermostat, 50-250°F
10	70212	Mounting Screw, #6-32 x 1/4" rd. hd. s/s phillips
11	82136	Knob, Thermostat 50-250°F
12	70284	Socket Set Screw, Thermostat Knob #8-32
13	83112	Clamp, Thermostat Probe
14	82082	Power Switch, LTIGK-6S-WH-NBL
15	82024	Blower Motor
16	70173	Mounting Screw, #10-24 x 1/2" s/s phillips
17	70144	Lockwasher, #10 s/s internal tooth
18	70141	Nut, #10-24 hex s/s
19	41144	Motor Air Duct
20	41148	Motor Air Duct Cover
21	41052	Water Pan Slide
22	82124	Heating Element, 1500W, 120V
22A	82296	Heating Element, 1800W, 120V, (MP & HW MdlS)
23	41044	Front Clip, 0.81" x 4.875"
24	41048	Rear Clip, 0.81" x 5.87"
25	83104	Ceramic Insulator
26	70189	Screw, #6-32 x 1/4" s/s phillips
27	70292	Lockwasher, #6 s/s
28	82076	Power Cord, 14-3 SO
28A	82068	Power Cord, 12-3 SO (MP or HW Models)
29	83108	Elbow Connector
30	82108	Cooling Fan
31	70212	Machine Screw, #10-24 x 2" phillips
32	83184	Spacer
33	82208	High-Temp (Klixon) Thermostat, 120/240V
34	41066	Rear Panel
34A	41178	Rear Panel, MP
35	70316	Elbow Connector Nut
36	70312	Lockwasher, Elbow Connector
37	41072	Motor Housing Cover
37A	41136	Motor Housing Cover, MP
38	41172	Air Flow Cover Extension, MP

7-6j. Heating Module Control Panel Parts List (CA43 MdlS)

Dwg 7-5c Ref #	Part Number	Description
2	41060	Front Control Panel
2A	41152	Front Control Panel, MP
3	70169	Sheet M~ Screw, #10 x 1/2" s/s phillips
4	70104	Flat Washer, AN960-C10L s/s
5	82128	Thermometer, 6" 50-250°F
6	50468	Thermometer Mounting Bracket
7	70288	Nut, Thermometer Mounting Bracket
8	82116	Indicator Lamp, Solico 5SF3LRN1-6
9	82132	Thermostat, 50-250°F
10	70212	Mounting Screw, #6-32 x 1/4" rd. hd. s/s phillips
11	82136	Knob, Thermostat 50-250°F
12	70284	Socket Set Screw, Thermostat Knob #8-32
13	83112	Clamp, Thermostat Probe
14	82082	Power Switch, LTIGK-6S-WH-NBL

7-6k. Heating Module Blower Motor Parts List (CA43 MdlS)

Dwg 7-5c Ref #	Part Number	Description
3	70169	Sheet Metal Screw #10 x 1/2" s/s phillips
15	82024	Blower Motor
16	70173	Mounting, Screw #10-24 x 1/2" s/s phillips
17	70144	Lockwasher, #10 s/s internal tooth
18	70141	Nut, #10-24 hex s/s
19	41068	Motor Cover
20	41072	Air Duct Cover
37	41072	Motor Housing Cover
37A	41136	Motor Housing Cover, MP
38	41172	Air Flow Cover Extension, MP

7-6l. Heating Element Parts List (CA43 MdlS)

Dwg 7-5c Ref #	Part Number	Description
22	82124	Heating Element, 1500W, 120V
22A	82296	Heating Element, 1800W, 120V (MP or HW MdlS)
23	41044	Front Clip, 0.81" x 4.875"
24	41048	Rear Clip, 0.81" x 5.87"
25	83104	Ceramic Insulator
26	70189	Screw, #6-32 x 1/4" s/s phillips
27	70292	Lock Washer, #6 s/s
33	82208	High-Temp (Klixon) Thermostat, 120/240V

7-6m. Cabinet Parts List (CA43 MdlS)		
Dwg 7-5d Ref #	Part Number	Description
1	20068	Heating Module
1A	20132	Heating Module, MP
1B	20140	Heating Module, HW
2	20072	Cabinet Assembly
2A	20074	Cabinet Assembly, MP
3	20076	Front Door
3A	20124	Front Door for MP
5	20080	Rear Door
5A	20082	Rear Door, MP
6	50132	Door Hinge, 2"
7	50140	Cabinet Hinge, 3"
8	50736	Hinge Pin, 5/16" x 5" rod
9	70073	Machine Screw, 1/4"-20 x 1/2" phillips
10	50392	Latch
11	50400	Latch Strike
12	50720	Latch Pin, 5/16" x 8.5" rod
13	83044	Latch Spring #CDL5019
17	20084	Air Duct Assembly (CV13)
19	83008	Button, aluminum #10-23-75R
20	70257	Sheet Metal Screw, T/H #8 x 1/4" phillips
21	83100	Water Pan
22	41041	Baffle, 22 ga. 7" x 8.5"
23	83180	Door Gasket, magnetic 21.5" x 28.5", MP
23A	84028	Door Gasket, magnetic 26" x 28.5", MP
24	50744	Gasket Retainer, top outer 22.37"
24A	50818	Gasket Retainer, top outer 26.87", MP
25	50744	Gasket Retainer, bottom outer 22.37"
25A	50818	Gasket Retainer, bottom outer 26.87", MP
26	50810	Gasket Retainer, side outer 29.5"
27	70276	Sheet Metal Screw, #6 x 3/4" hex head
28	80036	Caster, 5" with brake
29	80040	Caster, 5" without brake
30	70068	Nut, hex 5/16-18
31	70040	Lockwasher, 5/16" internal tooth
32	70324	Bolt, hex 5/16"-18 x 1 1/4"
33	20086	Air Duct Assembly (CV7)
34	20162	Air Duct Assembly (CVMP6)
35	30028	Wire Hanger, MP
36	20160	Air Duct Assembly (CVMP7)
37	50820	Extruded Runner, MP

7-6n. Cabinet Interior Parts List (CA43 MdlS)		
Dwg 7-5d Ref #	Part Number	Description
17	20084	Air Duct Assembly (CV13)
19	83008	Button, aluminum #10-23-75R
20	70257	Sheet Metal Screw, T/H #8 x 1/4" phillips
33	20086	Air Duct Assembly (CV7)
34	20162	Air Duct Assembly (CVMP6)
35	30028	Wire Hanger, MP
36	20160	Air Duct Assembly (CVMP7)
37	50820	Extruded Runner, MP

7-6o. Cabinet Front Door Parts List (CA43 MdlS)		
Dwg 7-5d Ref #	Part Number	Description
3	20076	Front Door
3A	20124	Front Door for MP
6	50132	Door Hinge, 2"
7	50140	Cabinet Hinge, 3"
8	50736	Hinge Pin, 5/16" x 5" rod
9	70073	Machine Screw, 1/4"-20 x 1/2" phillips
10	50392	Latch
11	50400	Latch Strike
12	50720	Latch Pin, 5/16" x 8.5" rod
13	83044	Latch Spring #CDL5019

7-6p. Cabinet Rear Door Parts List (CA43 MdlS)		
Dwg 7-5d Ref #	Part Number	Description
5	20080	Rear Door
5A	20082	Rear Door for MP
6	50132	Door Hinge, 2"
7	50140	Cabinet Hinge, 3"
8	50736	Hinge Pin, 5/16" x 5" rod
9	70073	Machine Screw, 1/4"-20 x 1/2" phillips
10	50392	Latch
11	50400	Latch Strike
12	50720	Latch Pin, 5/16" x 8.5" rod
13	83044	Latch Spring #CDL5019

8. WIRING DIAGRAMS AND OTHER TECHNICAL DATA

8-1 WIRING DIAGRAMS:

Model Number	Drawing Number
CA70-CV16, CV16HV, CV32, CV32HV, CVMP12, CVMP15	8-1a. Heating Module
CA43-CV7, CV7HW, CV13, CV13HW, CVMP6, CVMP7	8-1b. Heating Module



Innovative Foodservice Equipment Custom
Designed for Performance, Service and Value.

Phone: +1 (214) 421-7366
Fax: +1 (214) 565-0976
Toll Free: +1 (800) 441-1601
Website: www.BevLes.com
E-mail: sales@BevLes.com

BevLes
729 Third Avenue
Dallas, TX 75226