



# User Guide for the SoundPoint® IP 330/320

SIP 2.1.1

May, 2007 Edition  
1725-11241-001 Rev. A  
SIP 2.1.1



---

## Trademark Information

Polycom®, the Polycom logo design, SoundPoint® IP, SoundStation®, SoundStation VTX 1000®, ViaVideo®, ViewStation®, and Vortex® are registered trademarks of Polycom, Inc. Conference Composer™, Global Management System™, ImageShare™, Instructor RPT™, iPower™, MGC™, PathNavigator™, People+Content™, PowerCam™, Pro-Motion™, QSX™, ReadManager™, Siren™, StereoSurround™, V<sup>2</sup>IU™, Visual Concert™, VS4000™, VSX™, and the industrial design of SoundStation are trademarks of Polycom, Inc. in the United States and various other countries. All other trademarks are the property of their respective owners.

## Patent Information

The accompanying product is protected by one or more U.S. and foreign patents and/or pending patent applications held by Polycom, Inc.

## Disclaimer

Some countries, states, or provinces do not allow the exclusion or limitation of implied warranties or the limitation of incidental or consequential damages for certain products supplied to consumers, or the limitation of liability for personal injury, so the above limitations and exclusions may be limited in their application to you. When the implied warranties are not allowed to be excluded in their entirety, they will be limited to the duration of the applicable written warranty. This warranty gives you specific legal rights which may vary depending on local law.

## Copyright Notice

Portions of the software contained in this product are:  
Copyright © 1998, 1999, 2000 Thai Open Source Software Center Ltd. and Clark Cooper  
Copyright © 1998 by the Massachusetts Institute of Technology  
Copyright © 1998-2003 The OpenSSL Project  
Copyright © 1995-1998 Eric Young (eay@cryptsoft.com). All rights reserved  
Copyright © 1995-2002 Jean-Loup Gailly and Mark Adler  
Copyright © 1996 - 2004, Daniel Stenberg, <daniel@haxx.se>

Permission is hereby granted, free of charge, to any person obtaining a copy of this software and associated documentation files (the "Software"), to deal in the Software without restriction, including without limitation the rights to use, copy, modify, merge, publish, distribute, sublicense, and/or sell copies of the Software, and to permit persons to whom the Software is furnished to do so, subject to the following conditions:

The above copyright notice and this permission notice shall be included in all copies or substantial portions of the Software.

THE SOFTWARE IS PROVIDED "AS IS", WITHOUT WARRANTY OF ANY KIND, EXPRESS OR IMPLIED, INCLUDING BUT NOT LIMITED TO THE WARRANTIES OF MERCHANTABILITY, FITNESS FOR A PARTICULAR PURPOSE AND NONINFRINGEMENT. IN NO EVENT SHALL THE AUTHORS OR COPYRIGHT HOLDERS BE LIABLE FOR ANY CLAIM, DAMAGES OR OTHER LIABILITY, WHETHER IN AN ACTION OF CONTRACT, TORT OR OTHERWISE, ARISING FROM, OUT OF OR IN CONNECTION WITH THE SOFTWARE OR THE USE OR OTHER DEALINGS IN THE SOFTWARE.

© 2007 Polycom, Inc. All rights reserved.

Polycom Inc.  
4750 Willow Road  
Pleasanton, CA 94588-2708  
USA

No part of this document may be reproduced or transmitted in any form or by any means, electronic or mechanical, for any purpose, without the express written permission of Polycom, Inc. Under the law, reproducing includes translating into another language or format.

As between the parties, Polycom, Inc. retains title to, and ownership of, all proprietary rights with respect to the software contained within its products. The software is protected by United States copyright laws and international treaty provision. Therefore, you must treat the software like any other copyrighted material (e.g. a book or sound recording).

Every effort has been made to ensure that the information in this manual is accurate. Polycom, Inc. is not responsible for printing or clerical errors. Information in this document is subject to change without notice.

---

# About This Guide

Thank you for choosing the SoundPoint IP 330/320 SIP, a full-duplex, hands-free phone. This unit provides business telephony features and functions such as multiple call appearances, call hold, transfer, and conference over an IP network.

This User Guide provides everything you need to quickly use your new phone. Verify with your system administrator that the network is prepared for configuring your SoundPoint IP 330/320 SIP phone. As well, read the [Parts List](#) and [Regulatory Notices](#) sections in this guide before you set up and use the SoundPoint IP 330/320 SIP phone. This information can also be found at <http://www.polycom.com/support/voip/>.



---

# Contents

<b>About This Guide</b> . . . . .	<b>iii</b>
<b>1 Getting Started with Your SoundPoint IP 330/320 Phone</b> . .	<b>1-1</b>
Parts List . . . . .	1-2
Assembling Your SoundPoint IP 330/320 Phone . . . . .	1-3
Connecting Network and Power Source . . . . .	1-4
Connecting the Handset and Optional Headset . . . . .	1-4
Attaching the Base . . . . .	1-5
Features of Your SoundPoint IP 330/320 Phone . . . . .	1-8
Before You Use Your SoundPoint IP 330/320 Phone . . . . .	1-10
<b>2 Customizing Your SoundPoint IP 330/320 Phone</b> . . . . .	<b>2-1</b>
Configuring Basic Settings . . . . .	2-2
Appearance of Time and Date . . . . .	2-2
Display Contrast . . . . .	2-3
Headset Memory Mode . . . . .	2-3
Ring Type . . . . .	2-4
Language Support . . . . .	2-5
Directory Search . . . . .	2-5
Managing Call Lists . . . . .	2-6
Managing Contacts . . . . .	2-7
Adding Contacts . . . . .	2-8
Editing Contacts . . . . .	2-10
Deleting Contacts . . . . .	2-11
Placing a Call to a Contact . . . . .	2-12
Searching For a Contact . . . . .	2-12
Managing Incoming Calls . . . . .	2-13
Distinguishing Calls . . . . .	2-13
Rejecting Calls . . . . .	2-13
Diverting Calls . . . . .	2-14
System Customizations . . . . .	2-15

Supporting Multiple Lines .....	2-15
Supporting Multiple Line Keys Per Line .....	2-16
Supporting Shared Lines .....	2-16

### **3 Using the Basic Features of Your SoundPoint IP 330/320 Phone .....3-1**

Placing a Call .....	3-2
Answering a Call .....	3-4
Ending a Call .....	3-7
Muting the Microphone .....	3-7
Adjusting the Volume .....	3-8
Redialing a Number .....	3-8
Putting a Call on Hold .....	3-8
Setting Up a Conference .....	3-9
Transferring a Call .....	3-10
Forwarding Calls .....	3-12
Enabling Do Not Disturb .....	3-13
Assigning Speed Dial Indexes .....	3-14
Using Voice Mail .....	3-16

### **4 Using the Advanced Features of Your SoundPoint IP 330/320 Phone .....4-1**

Using Automatic Call Distribution .....	4-1
Using Multiple Call Appearances .....	4-3
Using Buddy Lists .....	4-4
Presence .....	4-5
Managing Buddies .....	4-5
Integrating With Microsoft Live Communications Server 2005 .....	4-6
Restarting Your Phone .....	4-8

### **5 Troubleshooting Your SoundPoint IP 330/320 Phone .....5-1**

Power and Startup .....	5-2
Controls .....	5-3
Access to Screens and Systems .....	5-4
Calling .....	5-5
Displays .....	5-7
Audio .....	5-7

**Regulatory Notices . . . . .Regulatory Notices–1**

**Index . . . . .Index–1**





---

# Getting Started with Your SoundPoint IP 330/320 Phone

This chapter provides basic installation instructions and information for obtaining the best performance with the SoundPoint IP 330/320 phone.

The SoundPoint IP 330/320 provides a powerful, yet flexible IP communications solution, delivering excellent voice quality. The graphic display supplies content for call information, multiple languages, directory access, and system status. The SoundPoint IP 330/320 supports advanced functionality, including multiple call and flexible line appearances, HTTPS secure provisioning, presence, custom ring tones, local conferencing, and Polycom's superb voice quality.

This chapter contains:

- [Parts List](#)
- [Assembling Your SoundPoint IP 330/320 Phone](#)
- [Features of Your SoundPoint IP 330/320 Phone](#)
- [Before You Use Your SoundPoint IP 330/320 Phone](#)

To customize your phone, refer to [Customizing Your SoundPoint IP 330/320 Phone](#) on page 1-1. To read about the phone's basic features, refer to [Using the Basic Features of Your SoundPoint IP 330/320 Phone](#) on page 3-1. To read the phone's advanced features, refer to [Using the Advanced Features of Your SoundPoint IP 330/320 Phone](#) on page 4-1.

If you require additional information or assistance with your new phone, contact your system administrator.

## Parts List

The following components are included in your SoundPoint IP 330/320 package:

- Polycom SoundPoint IP 330/320 phone

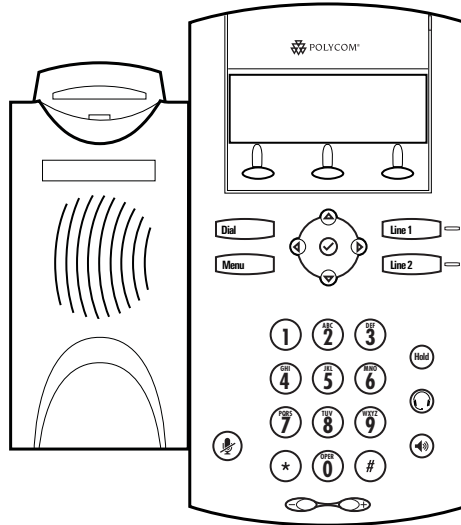

- handset & handset cord

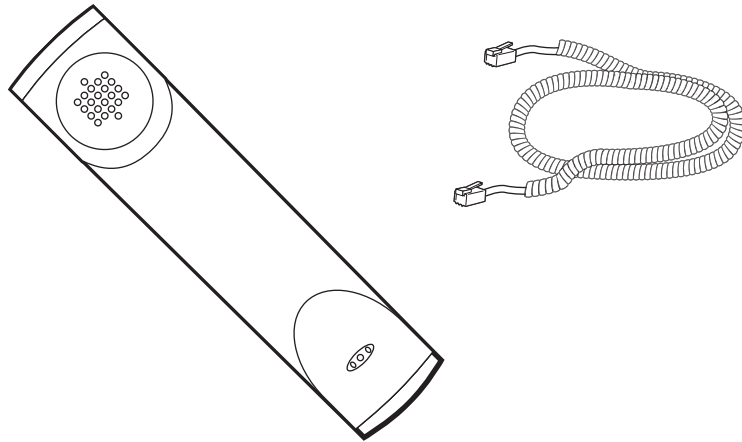

- Phone Base

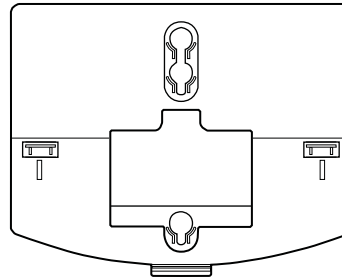

- Network / Power Cable

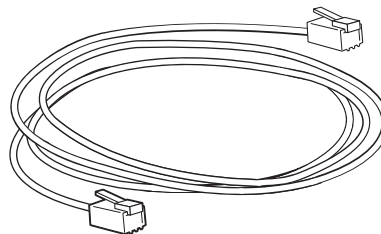

- Quick Start Guide and registration card

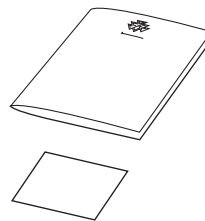

Check this list before installation to ensure that you have received each item. If you are missing any items, contact your system administrator.

## Assembling Your SoundPoint IP 330/320 Phone

This section describes how to assemble your SoundPoint IP 330/320 phone:

- Connect network and power source
- Connect handset and headset (optional)
- Attach phone base

If your phone is already assembled, go directly to [Features of Your SoundPoint IP 330/320 Phone](#) on page 1-8.

## Connecting Network and Power Source

Use Power over Ethernet (PoE) for network and power source connections unless otherwise directed by your system administrator.

### Note

The AC power adapter is a separate, optional accessory. Your system administrator will provide one to you if necessary.

### Power over Ethernet

Using a regular CAT5 cable (optional accessory from Polycom), the phone can be powered from a PoE (IEEE 802.3af) compliant switch or hub.

### To connect the PoE:

- Plug the supplied network cable between the LAN jack on the phone and an available power and data port on the in-line power switch.

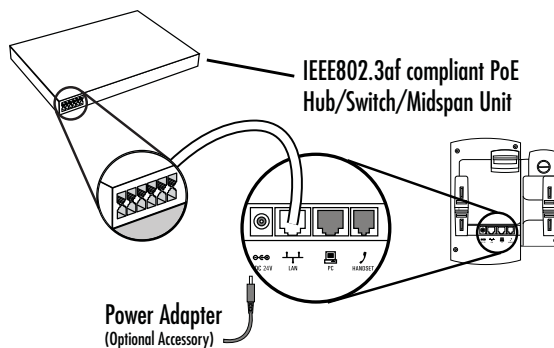

### Note

The SoundPoint IP 330 has an optional PC connection. The SoundPoint IP 320 does not. This is the only difference between the phones.

If you want to use the optional PC connection on the SoundPoint IP 330, a separate ferrite clamp (not included) is required. Contact your system administrator.

## Connecting the Handset and Optional Headset

### To connect the handset and optional headset:

1. Connect the short straight end of the phone cord to the handset and the corresponding longer straight end of the cord to the handset jack on the back of the phone.

2. Connect the headset (optional) to the headset jack on the side of the phone.

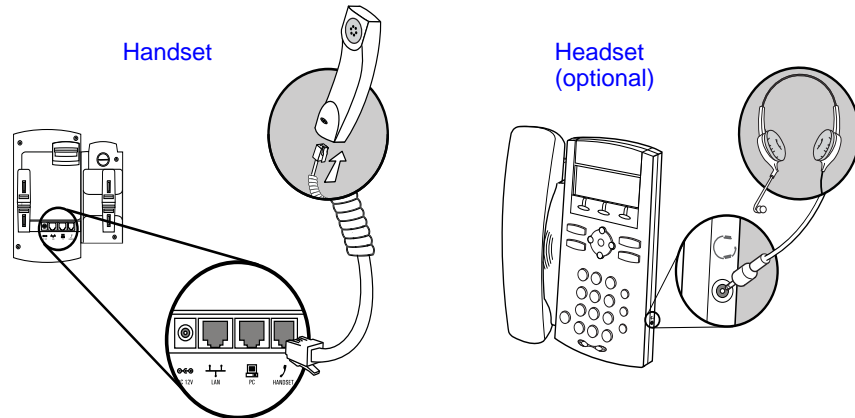

For information on supported headsets, go to [www.polycom.com/support](http://www.polycom.com/support) and select the **Support>Audio Conferencing Products** tab and enter the word headsets in the Knowledge Base text box.

#### Note

If headsets are deployed in high static environments where users frequently disconnect and re-connect the headset to the phone, it is possible that the phone can be damaged by electrostatic discharge (ESD).

You should take precautions to avoid excessive static buildup in your environment. This can include humidity control and removal of synthetic materials near the phone location. Antistatic spray applied to carpets in the workplace can reduce the level of static buildup.

## Attaching the Base

The phone base can be attached to the SoundPoint IP 330/320 in one of two ways:

- As a desk mount
- As a wall mount

Refer to the following sections to attach the base to the phone or, for more detailed instructions, go to <http://www.polycom.com/support/voip/> and search for the “Wallmount Instructions for SoundPoint IP Phones” quick tip.

**To attach the base as a desk mount:**

1. Place all cords in the recessed area above the modular jacks.

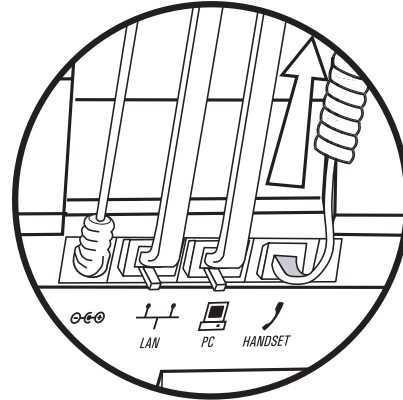

2. Align the two protrusions on the bracket with their corresponding holes in the phone.

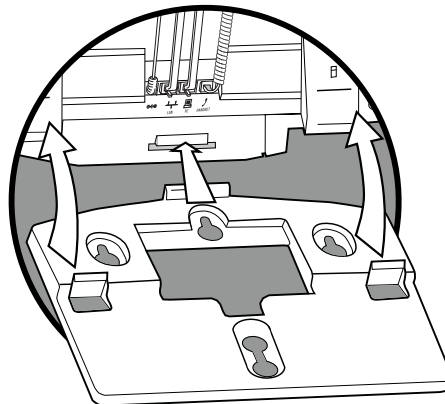

3. Snap them together to lock the base to the phone.



**To attach the base as a wall mount:**

1. Place all cords in the recessed area below the modular jacks.
2. On the back of the phone, remove the key located behind the hook switch and reposition it so that the end tab (at a 45° angle) is facing up.

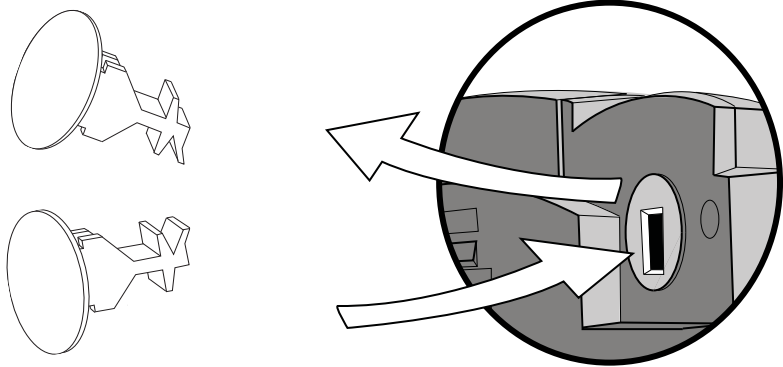

3. Using wall anchors (not included), fasten the base stand with the mounting tab facing up.
4. Align the base stand tabs with their corresponding insertion points on the phone, and then snap the phone into place (as shown).

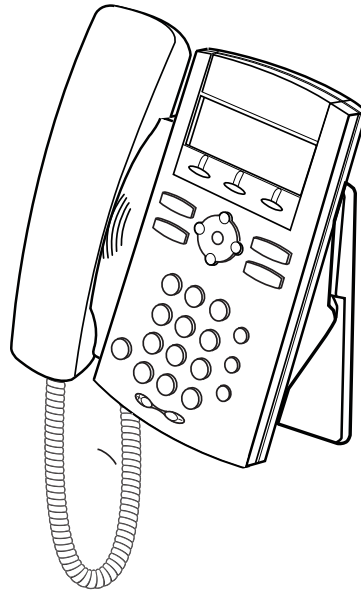

## Features of Your SoundPoint IP 330/320 Phone

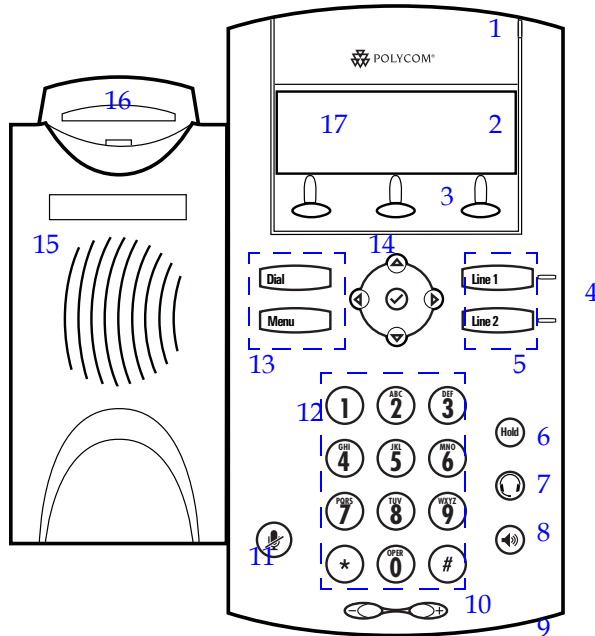





The features of the SoundPoint IP 330/320 phone are:

- 1. Message Waiting Indicator**—This will alert you to incoming calls, new messages, and other events.
- 2. Line Icons**—Use these keys to activate up to lines that can be assigned to your phone. The associated icons represent:

- Registered line
- Registered shared line
- Unregistered line
- VoiceMail/Messages
- Speed-Dial
- Ringing
- Call in progress/Conference
- Call Forward



- Do Not Disturb
  - Presence/BLF
3. **Soft Keys** – The screen will display labels for these keys, to identify their context-sensitive functions.
  4. **Line Indicators** – Individual multi-color LEDs display the dynamic call state and remote user status (busy lamp field (BLF) and presence). The mapping is:
    - Solid green – An active call is in progress.
    - Fast flashing green – There is an Incoming (ringing) call.
    - Flashing red – The call is on hold.
    - Solid red – The line is busy remotely (shared lines).
  5. **Line Keys** and – Use these keys to activate up to lines that can be assigned to your phone.
  6. **Hold** – Holds an active call or resumes a held call.
  7. **Headset** – Allows you to place and receive calls through an optionally connected headset.
  8. **Speakerphone** – Allows for hands-free communication during calls.
  9. **Hands-free Microphone** – Place your phone on a hard, flat surface for best results.
  10. **Volume Keys** – Use these to adjust the volume of the handset, headset, speaker, and ringer.
  11. **Microphone Mute** – Mutes audio transmission locally during calls.
  12. **Dial Pad** – These 12 keys provide the 10 digits, the 26 alphabetic characters, and special characters available in context-sensitive applications.
  13. **Feature Keys** – Access important features using these keys.
    - – Dial phone number entered or view placed call list.
    - – Access local (your phone) and call server features.

**14. Display Control Keys**—Use , , , and  (arrow keys) to scroll through the displayed information.

Use  (the Select key) to select a field of displayed data or enter edit mode for some settings.

**15. Speaker**—For ringer and hands-free audio output.

**16. Hookswitch**



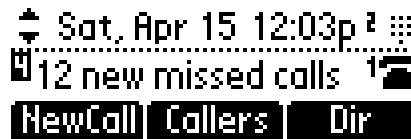
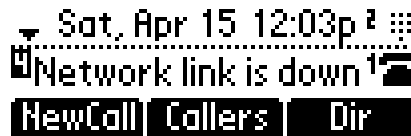

**17. Graphic Display**—Shows information about calls, messages, soft keys, time, date, and other relevant data.

- Important messages appear on the idle display through an animated scrolling list, which has precedence over the normal idle display. The following screens show some examples:



## Before You Use Your SoundPoint IP 330/320 Phone

To navigate through menus and to enter data, these are useful tips:



- Press  to enter the basic settings menu or exit from any menu.
- Press  and  or hold  and  down to scroll through the lists.

**Note**

Press the \* key to page up. Press the # key to page down. These shortcuts can be used when lists appear on more than one page.

- Use the dial pad keys to navigate through and make selections in numbered menu lists.

- The navigation guide icon in the top left-hand corner of the graphic display shows which arrow keys can be used at a particular sublevel.

For example, the following figure shows that , , , and  can be used at this point.



**Note**

After 20 seconds of inactivity, the menu system will also automatically exit to the idle display unless an edit session is in progress.

- To enter text using the dial pad, press the number keys one or more times. For example, for 'A' press '2' and for 'C' press '222'. The text that can be entered by a key is shown beneath the entry line. This is true for all languages that can be displayed by the phone. When in text entry mode, the title will show whether keys will generate numbers (1) or characters (A or A).

The type of text entry available is displayed in the title line.



Switch between alphabetic (with and without an uppercase letter first) and numeric text entry by pressing the # key. Special characters like \* and \_ are considered alphabetic and appear when you press \*, 1, or 0.

**Note**

Pressing the # also allows for URL or IP address entry. These options are only available to system administrators in appropriate menu items. For example, when editing directory contacts use "Abc", "abc", or "123" and when editing server addresses use "URL", "IP", or "123".

**Note**

To enter the "#" character, use the "\*" key to access the appropriate special character. "#" cannot be entered using its own key because it is used to change text entry modes.

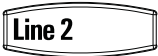
- Press and hold (for one second) from the idle display:
  -  to point to the contact in the directory system where you can scroll through the individual fields.

-  to the Placed Calls list when the phone is idle.

Pressing  again will call the currently highlighted number.

Pressing  while in the dialing editor will dial the current number.

- Press and hold the **Backspace** soft key to delete an entire field.

---

# Customizing Your SoundPoint IP 330/320 Phone

You can customize your SoundPoint IP 330/320 phone by adjusting the setting for time and date, display contrast, and ring type, for example. You can add contacts to the phone's directory manually or from call lists. You can handle incoming calls from different contacts in different ways.

This chapter provides basic operating instructions for customizing your SoundPoint IP 330/320 phone. This chapter contains instructions on:

- [Configuring Basic Settings](#)
- [Managing Call Lists](#)
- [Managing Contacts](#)
- [Managing Incoming Calls](#)

Some customizations of your SoundPoint IP 330/320 phone are performed by your system administrator. These include:

- [Supporting Multiple Lines](#)
- [Supporting Multiple Line Keys Per Line](#)
- [Supporting Shared Lines](#)

To read about the phone's basic features, refer to [Using the Basic Features of Your SoundPoint IP 330/320 Phone](#) on page 3-1. To read about the phone's advanced features, refer to [Using the Advanced Features of Your SoundPoint IP 330/320 Phone](#) on page 4-1.

If you require additional information or assistance with your new phone, contact your system administrator.

## Configuring Basic Settings

You can configure the following basic settings if you press  and then select *Settings > Basic*:

- The appearance of the time and date
- Display contrast
- Headset Memory Mode
- Ring type
- Language support (localization)
- Directory search

### Appearance of Time and Date



The time and date appears on the graphic display of the SoundPoint IP 330/320 SIP phone. If the phone cannot obtain a time and date from a configured SNTP server, the display will flash. Contact your system administrator if either the time or date is incorrect.

You have control over the format of the time and date display and can turn the display of time and date off. The default time and date format appears in the following figure.





Tue, Feb 27 James... 12:36P 3416  
NewCall Callers Dir

**To configure the time and date:**

1. Press .
2. Select *Settings > Basic > Preferences > Time & Date*.
3. Select from *Clock Date*, *Clock Time*, *Clock Order*, or *Enable/Disable*.
4. Scroll through the options under each of these selections using the  and .

- Press  to confirm your choice.  
For example, the following figure shows Clock Time.





- Press  or  repeatedly to return to the idle display.

## Display Contrast

To adjust the contrast on the display to a comfortable level:

- Press .
- Select *Settings > Basic > Contrast*.
- Press the **Up** or **Down** soft keys to increase or decrease the display contrast.







- Press the **Save** soft key to accept changes or  to cancel changes.
- Press  or  repeatedly to return to the idle display.

## Headset Memory Mode

This feature is especially useful for permanent or full-time headset users.

To permanently enable the Headset Memory Mode:

- Press .
- Select *Settings > Basic > Preferences > Headset Memory*.
- Use the  or  to select Enabled.

4. Press  to confirm your choice.



5. Press  or  repeatedly to return to the idle display.

Repeat steps 1 to 4 to select Disabled and turn Headset Memory Mode off.

#### To activate Headset Memory Mode:





- >> Press  twice.

Pressing  or **Answer** soft key to receive a call will now connect to the your headset automatically.

## Ring Type

You can select from the different ring types to distinguish between lines or to have a different ring from your neighbor's phone. You can set distinctive incoming ringing tones for contacts in your local directory (refer to [Editing Contacts](#) on page 1-3).

#### To change the incoming ring to a desired sound:

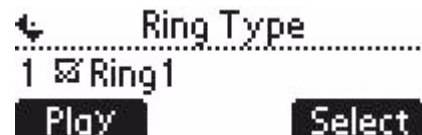

1. Press .
2. Select *Settings > Basic > Ring Type*.
3. (Optional) If multiple lines are configured on your phone, first select the line to change from the list using  and .
4. Using  and , select the desired ring type.

Press the **Play** soft key to hear the selected ring type.



5. Press the **Select** soft key to change to the selected ring type.



6. Press  or  repeatedly to return to the idle display.

## Language Support

Many languages are supported by the SoundPoint IP 330/320 SIP phone.



### To change the language:

1. Press .
2. Select *Settings > Basic > Preferences > Language*.
3. Scroll through the list of available languages.



4. Press  to confirm your choice.

Text that appears on the graphic display will change to the language of your choice.

5. Press  or  repeatedly to return to the idle display.



## Directory Search

You can configure how the search of the Contact Directory is performed. The Contact Directory can be searched by first name or last name.

### To change the directory search parameter:

1. Press .
2. Select *Settings > Basic > Preferences > Directory search*.



- Using  and , select the directory search parameter.  
Last name is the default directory search parameter.





- Press  to select your choice.
- Press the **Yes** or **Cancel** soft keys to accept or cancel changes.



**Note**

Depending on the size of your contact directory, the reconfiguration may take a few minutes.

The phone will restart to set the new directory search mode if you pressed the **Yes** soft key.

## Managing Call Lists

A list of up to four current calls is maintained. You can scroll through this list using the  and . Calls are ordered using the following priorities: active, alerting, then held. Calls with the same priorities are ordered oldest first. If there are no current calls, this list is empty.

Local lists of incoming – both missed and received calls – and outgoing (also known as placed) calls is maintained by the phone (up to 99 for each list). The initial view of both lists shows the list title and the first two calls in the list, where the first call is displayed in reverse video to indicate that it is currently selected. A symbol to indicate whether the call was answered  or missed  is shown for each entry in the incoming list.

Press the **Callers** soft key to view the Received Calls list (shown in the following figure).





Press  to view the Placed Calls list (shown in the following figure).

```

  * Placed Calls
  17 James Dean(446523...)
  16 Bob Smith( 5234466)

```

#### To manage the listed calls:

- To return the call:
  - Press  to return the call.
- To return to the previous menu:
  - Press .
- To store the contact to the Contact Directory:
  - Press  to select the entry, then press the **Save** soft key.

#### Note

Press the **Info** soft key to see the call information. The name is displayed. Access the other information by using the **Up** and **Down** arrow keys.

- To delete the call from list:
    - Press the **Delete** soft key.
- Press  repeatedly to return to the idle display.

#### Note

You can manually clear the call lists. They are automatically cleared when you restart the phone.

## Managing Contacts

You can enter 99 contacts in your phone's Contact Directory.

You can add, edit, delete, dial, or search for a contact in this directory.

```

  * Directory
  1 Bob Smith(5551234)
  2 Lance Baker(5554444)

```

## Adding Contacts

You can add a contact manually or from a call list.

### Adding Contacts Manually

New entries to the Contact Directory are added to the top of the list.

#### To add a contact manually:

1. Press the **Dir** soft key and then .

A new entry appears at the top of the list.



#### Note

When adding the first contact, you do not need to press the **Up** arrow key.

2. Press  to add a new entry.

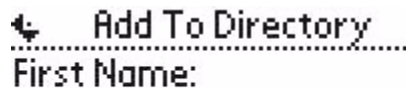

3. Press  to enter a first name.  
Entry to this field is alphabetic as denoted by **Abc**.

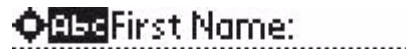

4. Enter the first name of the contact from the dial pad.



5. Press the **Ok** or **Cancel** soft keys to accept or cancel changes.
6. Press  to display the next field in the contact's entry.
7. Repeat steps 3 to 6 to enter the last name of the contact.





8. Repeat steps 3 to 6 to enter a contact number.

This is a required field and it must be unique (not already in the directory).  
Entry to this field is number as denoted by **123**.

 **123** Contact: .....

**Cancel** **<<**

9. Repeat steps 3 to 6 to change the *Speed Dial Index* if desired.  
It is automatically assigned to the next available index value.  
For more information, refer to [Assigning Speed Dial Indexes](#) on page 3-14.
10. Repeat steps 3 to 6 to change the *Ring Type* and *Divert Contact* if desired.  
These fields may be left blank.  
For more information on setting the *Ring Type* field, refer to [Distinguishing Calls](#) on page 2-13.  
For more information on diverting contacts, refer to [Diverting Calls](#) on page 2-14.
11. Repeat steps 3 to 6 to change the *Auto Reject*, *Auto Divert*, *Watch Buddy*, and *Block Buddy* if desired.

Use , , , or  to switch between Enabled and Disabled settings.

For more information on setting the *Auto Reject* field, refer to [Rejecting Calls](#) on page 1-1.

12. Press  to end contact's data entry.





Confirmation  
.....  
Save Directory?  
**Cancel** **Resume** **Yes**

13. Press the **Yes** or **Cancel** soft keys to accept or cancel changes.
14. Press  repeatedly to return to the idle display.  
You may add another entry by repeating steps 3 to 13.

### Adding Contacts From Call Lists

#### To add a contact from a call list:



1. Do one of the following steps:

- a Press the **Callers** soft key to view the Received Calls list.
- b Press  to view the Placed Calls list.
- 2. Use  and  to scroll through the list to find the contact.  
You can also use the \* key to Page Up and the # key to Page Down.
- 3. Press  to select the entry.





- 4. (Optional) Press the **Info** soft key.  
The name is displayed. The number, time and date when the call started, and call duration are accessible through use of .



- 5. (Optional) Press  repeatedly to select the phone number.
- 6. Press the **Save** soft key to save the contact in the phone's directory.
- 7. Press  repeatedly to return to the idle display.

## Editing Contacts

### To edit a contact:

- 1. Press the **Dir** soft key.
- 2. Use  and  to scroll through the list to find the contact.  
You can also use the \* key to Page Up and the # key to Page Down.
- 3. Press  to select the entry.



4. Press the **Edit** soft key.



5. Use and to scroll through the fields, then press to select the field.

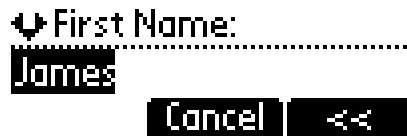

6. Make the desired changes.

The **Ok** soft key is not displayed until a change has been made. The **Cancel** soft key in this context will cancel the edit session for the entry and return to the screen before the **Edit** soft key was selected (see step 3).

Press and to place the cursor either at the beginning or end of the item respectively. Press to move to the next field.



7. Press the **Ok** or **Cancel** soft keys to accept or cancel changes.
8. Press repeatedly to return to the idle display.

#### Note

You can also edit a contact associated with a speed dial key by pressing and holding that speed dial key and then following the steps 5 to 7 above.

## Deleting Contacts

### To delete a contact:

1. Press the **Dir** soft key.
2. Use and to scroll through the list to find the contact.  
You can also use the \* key to Page Up and the # key to Page Down.



3. Press  to select the entry.



4. Press the **Delete** soft key.  
The contact is deleted from the directory. The next entry in the directory appears.
5. Press  repeatedly to return to the idle display.

## Placing a Call to a Contact

### To place a call to a contact:

1. Press the **Dir** soft key.
2. Use  and  to scroll through the list to find the contact.  
You can also use the \* key to Page Up and the # key to Page Down.
3. Press  or lift the handset.

## Searching For a Contact

### To search for a particular contact:

1. Press the **Dir** soft key.
2. Search for a contact using the dial pad.

You can change the directory search parameter used. By default, it is the contact's last name. For more information, refer to [Directory Search](#) on page 2-5.

The first time a dial pad key is pressed, the first entry whose last name starts with a character that matches the first letter on the key label will be retrieved. The second key press repeats the process using the second letter on the key and so on.

For example, to find the first directory entry whose last name starts with J, press the 5 key once. To find the first entry whose last name starts with R, press the 7 key three times.







## Managing Incoming Calls

You can distinguish incoming calls from contacts in your directory by setting up distinctive rings, sending them directly to your voice mail, or by transferring them directly to another party.



### Distinguishing Calls

You can customize your phone so that you can distinguish different parties by ring type.

#### To set a distinctive ring type for a particular contact:

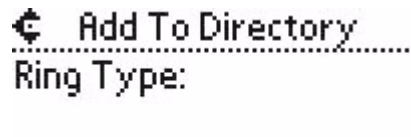
1. Press the **Dir** soft key.
2. Use  and  to scroll through the list to find the contact.
3. Press  to select the entry.
4. Press the **Edit** soft key.
5. Press  repeatedly until the *Ring Type* field is displayed.



6. Press  to edit the Ring Type.
7. Enter the number corresponding to one of the ring types available.  
For more information, refer to [Ring Type](#) on page 2-4.
8. (Optional) To remove an existing value, press .
9. Press the **Ok** or **Cancel** soft keys to accept or cancel changes.
10. Press  repeatedly to return to the idle display.

#### Note

This feature is local to the phone, and may be over-ridden by your organization's settings. For more information, contact your system administrator.





### Rejecting Calls

You can customize your phone so that incoming calls from a particular party are immediately sent to your voice mail.



#### Note

Rejecting calls is not available on shared lines.

**To send incoming calls from a particular contact directly to voice mail:**

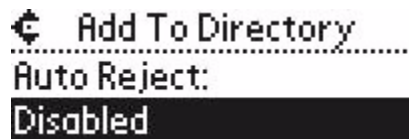
1. Press the **Dir** soft key.
2. Use  and  to scroll through the list to find the contact.
3. Press  to select the entry.
4. Press the **Edit** soft key.
5. Press  repeatedly until the *Auto Reject* field is displayed.







6. Press , and then  to change between Disabled and Enabled.
7. Press the **Ok** or **Cancel** soft keys to accept or cancel changes.
8. Press  repeatedly to return to the idle display.

## Diverting Calls

You can customize your phone so that incoming calls from a particular party are transferred directly to a third party.

**To divert incoming calls from a particular contact:**



1. Press the **Dir** soft key.
2. Use  and  to scroll through the list to find the contact.
3. Press  to select the entry.
4. Press the **Edit** soft key.
5. Press  repeatedly until the *Divert Contact* field is displayed.



6. Press .

 123 Divert Contact: .....

**Cancel** **<<**

7. Enter the number of the party to whom you want to divert the call.
8. Press the **Ok** or **Cancel** soft keys to accept or cancel changes.
9. Scroll down to the *Auto Divert* field.
10. Press , and then  to change between Disabled and Enabled.
11. Press the **Ok** or **Cancel** soft keys to accept or cancel changes.
12. Press  repeatedly to return to the idle display.

## System Customizations



The following section details customizations of your SoundPoint IP 330/320 phone that are performed by your system administrator.

### Supporting Multiple Lines

Your SoundPoint IP 330/320 phone can support up to 2 lines.

Typically, the top-most Line Key is reserved for the principal directory number (DN) of the phone.

Depending on how your phone is configured, the display could resemble one of the following figures:

Tue, Feb 27 James...<sup>2</sup>   
 12:36P 3416<sup>1</sup>   
**NewCall** **Callers** **Dir**

Thu, Dec 21 3416<sup>2</sup>   
 1 29P 3413<sup>1</sup>   
**NewCall** **Callers** **Dir**

## Supporting Multiple Line Keys Per Line

Each line on the phone can be configured to have more than one Line Key associated with it. This enhances call visualization and simplifies call handling. If this is the case, the display could resemble the following figure:



Incoming calls to this line will be distributed evenly among the available Line Keys. Similarly, outgoing calls will be distributed.

The SoundPoint IP 330/320 combines the call appearances for multiple line keys into a single call list.

The line key that a call belongs to is indicated by the reverse colored icon.

## Supporting Shared Lines

Your SoundPoint IP 330/320 phone supports shared lines. A shared line is indicated by a different line icon. In the following figure, the line 3413 is private and the line 3416 is shared.



If two phones share a line, an incoming call to that number will cause both phones to ring. The call can be answered on either phone but not both.

Calls on shared lines can be transferred, put on hold, or added to a conference.

**Note**

Shared lines are an optional feature and may not be supported on your particular system. For more information, contact your system administrator.



**Note**

Call Forwarding is not available on shared lines.

---

# Using the Basic Features of Your SoundPoint IP 330/320 Phone

Your SoundPoint IP 330/320 phone is designed to be used like a regular phone on a public switched telephone network (PSTN). You can place calls, transfer a call to someone else, or conduct a conference call.

At any time, only one active call may be in progress on your phone. The active call is the one that has audio associated with it. There may be up to three other calls on hold or in an “Incoming call” or “Ringing” state. Use  and  to switch between these calls.

This chapter provides basic operating instructions for the SoundPoint IP 330/320 phone. This chapter contains instructions on:



- [Placing a Call](#)
- [Answering a Call](#)
- [Ending a Call](#)
- [Muting the Microphone](#)
- [Adjusting the Volume](#)
- [Redialing a Number](#)
- [Putting a Call on Hold](#)
- [Setting Up a Conference](#)
- [Transferring a Call](#)
- [Forwarding Calls](#)
- [Enabling Do Not Disturb](#)
- [Assigning Speed Dial Indexes](#)
- [Using Voice Mail](#)

To customize your phone, refer to [Customizing Your SoundPoint IP 330/320 Phone](#) on page 2-1. To read about the phone's advanced features, refer to [Using the Advanced Features of Your SoundPoint IP 330/320 Phone](#) on page 4-1.

If you require additional information or assistance with your new phone, contact your system administrator.

## Placing a Call

You can place a call in many ways using your SoundPoint IP 330/320 phone:

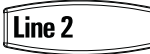
- Using the handset
- Using the speakerphone
- Using the headset
- Using 
- Using  or 

You can also dial the number first, and then choose the method you will use to speak to the other party.

To call a speed dial number, use the dial pad to enter the speed dial index followed by the # key, and then press  or pick up the handset to place a call.

During a call, you can alternate between Handset, Headset, or Hands-Free Speakerphone modes by pressing the  or  keys, or picking up the handset.

Call duration on an active call is monitored through a local call timer. This is visible within the active call window on the graphic display. In the figure below, the call to James Dean has lasted 2 hours 48 minutes 23 seconds so far.



**To place a call using the handset:**

1. Do the following steps in any order:
  - Pick up the handset.

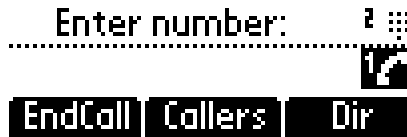





- Dial the desired number using the dial pad.

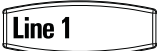

**Note**

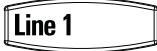
The SoundPoint IP 330/320 do not support URL/IP dialing on registered phones. URL/IP dialing is only allowed on *intentionally* unregistered phones. The dialing mode will default to URL entry.

**To place a call using Hands-Free Speakerphone mode:**

1. Do one of the following steps:
  - a With the handset on-hook, press , , or , or the **NewCall** soft key to obtain dial tone.  
  
Dial the desired number using the dial pad.
  - b With the handset on-hook, dial the desired number using the dial pad.  
  
Press , , or .

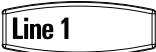
**To place a call using the headset:**

1. Do one of the following steps:
  - a With the optional headset connected, press , , or the **NewCall** soft key to obtain dial tone.  
  
Press .

Dial the desired number using the dial pad.

- b** With the optional headset connected, dial the desired number using the dial pad.

Press .





- c** Press .

You will hear a dial tone. You can enter the desired number now.

**Note**

To permanently enable your headset, refer to [Headset Memory Mode](#) on page 2-3.

**To place a call using the Dial key:**

1. Do one of the following steps:
  - a** Press the **Callers** soft key to view the Receive Call list.
  - b** Press  to view the Placed Call list.
2. Use  and  to scroll through the list to find the contact.
3. Press  to complete the call.

## Answering a Call

When you are not in another call, you can answer a call in three basic ways using your SoundPoint IP 330/320 phone:

- using the handset
- using the speakerphone
- using the headset

The steps for answering an incoming call when you are in another call are different if your phone is configured for:

- A single Line Key per line

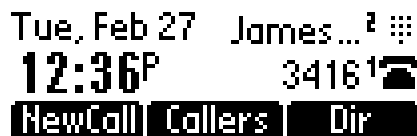

Tue, Feb 27 James...<sup>2</sup> ☰  
12:36P 34161 ☎  
NewCall Callers Dir



- Multiple Line Keys per line



If your phone is configured with multiple call appearances, refer to [Using Multiple Call Appearances](#) on page 4-3 for instructions on how to answer a call.

#### Note

Incoming calls may be ignored by pressing the **Reject** soft key (for private lines) or the **Ignore** soft key (for private and shared lines).

### Answering When Not in Another Call

In all cases, the active call will appear on the graphic display showing call duration and destination.

#### To answer a call using the handset:

- Pick up the handset.

#### To answer a call using Hands-Free Speakerphone mode:

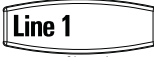
- Do one of the following steps:
  - Press .
  - With the handset on-hook, press  opposite the incoming call (where the line status indicator is flashing green).
  - Press the **Answer** soft key.

#### To answer a call using the headset:

- Press  to answer the call through an optionally connected headset.

If Headset Memory Mode is activated, press  or the **Answer** soft key.

### Answering When in Another Call

You are busy on an active call and a second incoming call arrives on the same phone number.

- If your phone is configured for a single Line Key per line:

- The second call will cause a call waiting tone to be played, the second line status indicator is fast flashing green, and an incoming call icon appears. The call waiting prompt identifying the incoming caller appears for 10 seconds only. You can ignore, answer, or reject the call. (The **Reject** soft key on private lines only.)
- After this point the active call is in focus and the user must scroll to the incoming call appearance to Answer
- If your phone is configured for multiple Line Keys per line:
  - The second call will cause a call waiting tone to be played, the second Line Key indicator to fast flash green, and an incoming call icon appears. The call waiting prompt identifying the incoming caller appears for 10 seconds only. You can ignore, answer, or reject the call. (The **Reject** soft key on private lines only.)
- If your phone is configured for shared lines:
  - The second call will cause a call waiting tone to be played, the second Line Key indicator to fast flash green, and an incoming call icon appears on the second Line Key. The call waiting prompt identifying the incoming caller appears for 10 seconds only.



**Note**

Pressing the **Ignore** soft key will stop the ringing for that call.

**To answer an incoming call on a line configured for a single Line Key:**

**Note**

Use this procedure after the call prompt disappears. The call waiting prompt *interrupts* the active call for 10 seconds, where the incoming call can be immediately dealt with.

1. Press  to put the original call on hold.
2. Press  to access the new call.

Soft key labels are updated on the display showing **Ignore**, **Answer**, and **Reject**.

3. Answer the incoming call.

This places the original call on hold and refreshes the soft key labels.

**To answer an incoming call on a line configured for multiple Line Keys:**

**Note**

Use this procedure after the call prompt disappears. The call waiting prompt *interrupts* the active call for 10 seconds, where the incoming call can be immediately dealt with.

➤ Do one of the following steps:

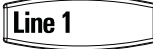
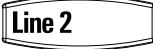
- Answer the call by pressing  or  associated with the second incoming call.

The first call is put on hold and the second call is answered.

- Press  to put the original call on hold.

Soft key labels are updated on the display showing **Ignore**, **Answer**, and **Reject**.

Answer the incoming call.



This places the original call on hold and refreshes the soft key labels.

Answering a call on shared line is no different than on private line, except that there is no **Reject** soft key and another person on the shared line might answer the call.

## Ending a Call

**To end a call:**

➤ Do one of the following steps:

- Press the **EndCall** soft key.
- Replace the handset.
- Press  if in Hands-free Speakerphone Mode, or  if in Headset Mode.

## Muting the Microphone

During a call, press . The Message Waiting Indicator turns red and a microphone on the graphic display indicates that the other party (or parties) cannot hear you.

Microphone Mute applies to all modes: Handset, Headset, and Hands-free Speakerphone. You can still hear all other parties while mute is enabled.

To turn off Microphone Mute, press  again.

## Adjusting the Volume

Press  to adjust receiver volume during a call. Pressing these keys in the idle state adjusts the ringer volume.

### Note

To conform to regulatory requirements, handset and headset volume will return to a preset level after each call, but the configuration can be changed by your system administrator. Hands-free Speakerphone volume settings will be maintained across calls.

## Redialing a Number





**To redial any call placed from your phone:**

- Refer to [To place a call using the Dial key](#): on page 3-4.

## Putting a Call on Hold

During a call, press . This will be indicated on the graphic display by the hold icon as the line indicator.



Press  again or the **Resume** soft key to resume the call. The active audio icon (one of , , or ) appears as the line indicator.

When a call has been on hold for an extended period of time, both visual and audible alerts appear. Contact your system administrator to determine if this feature is enabled/disabled, what the time period is, and what sound effects are available. When active on a call, the sound effects are played at a volume that is typically lower than the normal ringer volume.

### Note

As using the Hold feature typically generates music or a beeping tone, avoid putting a conference call on hold.

## Multiple Calls on Hold

If multiple calls are on hold, use  and  to switch between the calls, then press the **Resume** soft key to retrieve the desired call.

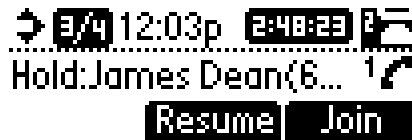

If two or more calls are on hold, an indication appears on the graphic display, for example “3/4”, indicating that this is the third call out of four calls.

If calls are on hold on more than one Line Key, all calls are combined into a single call list. The Line Key that a call is associated with is indicated by the line icon in reverse colors. Pressing a Line Key with calls on hold will place the current active call on hold and resume the first call on that Line Key.

## Setting Up a Conference

You can create a conference with other parties using the phone’s local conference feature.

### To set up a conference:

1. Call the first party.



### Note

You can either dial the phone number directly or search for the number in the Contact Directory or Call Lists. For more information, refer to [Placing a Call](#) on page 3-2, [Searching For a Contact](#) on page 2-12, or [Managing Call Lists](#) on page 2-6.

2. Press **Conf** soft key to create a new call.

The active call is placed on hold.

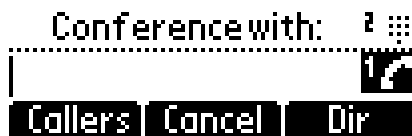

3. Call the second party.



4. When the second party answers, press the **Conf** soft key again to join all parties in the conference.



**To split a conference call:**

- Press the **Split** soft key to split the conference.  
Both parties will be on hold.

**To set up a conference call using the Join soft key:**

- When you are in an active call:
  - a If you have one call on hold (on the same line or other line), use  to go to the call on hold, then press the **Join** soft key.  
A conference is created with the active call, the call on hold and yourself.
  - b If you have more than one call on hold, use  and  to switch to the desired call on hold, press the **Join** soft key.  
A conference is created with active call, the call on hold and yourself.

**To end a conference call:**

- Press the **EndCall** soft key or hang up.  
The other parties will continue to be connected.

## Transferring a Call

A call can be transferred in one of three ways:

- Consultative transfer – The party to whom you want to transfer the call answers their phone before you transfer the call or hang up. You can consult with them before completing the transfer.
  - [To transfer a call](#): on page 3-11.
- Blind transfer – The call is automatically transferred after you dial the number of the party to whom you want to transfer the call.
  - [To perform a blind transfer](#): on page 3-11.

- Attended transfer – The parties are automatically connected to each other after you exit the conference.
  - Set up a conference call and then end your participation. For more information, refer to [Setting Up a Conference](#) on page 3-9.

#### To transfer a call:

1. During a call, press **Trans** soft key.  
The active call is placed on hold.



2. Enter the number to which you want to transfer the call.  
A normal (or consultative) transfer is assumed.

#### Note

Access to the contact directory or received callers list at this point will be added in a future release. For more information, contact your system administrator.







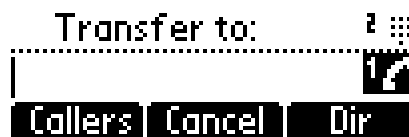



3. As soon as the ring-back sound is heard or after the party answers, press **Trans** soft key to complete the transfer.  
You can talk privately to the party to which you are transferring the call before the transfer is completed.  
If you are using a handset, the transfer can be completed by putting the handset on the cradle.  
You can cancel the transfer before the call connects by pressing the **Cancel** soft key.

#### To perform a blind transfer:

1. During a call, press the **Trans** soft key.
2. Press the **Blind** soft key.



3. Do one of the following steps:
  - a Enter the number to which you want to transfer the call.

- b** Press the **Dir** soft key to access the Contact Directory, use  and  to access the contacts, and then press .
- c** Press the **Callers** soft key to access the Received Call list, use  and  to access the contact, and then press .
- d** Press  to access the Placed Call list, use  and  to access the contact, and then press .

At this point, the call is connected to the number to which you are transferring them.

## Forwarding Calls

You can configure your phone so that all incoming calls are forwarded to another party (known as static forwarding).

All incoming calls can be forwarded to another party while Do Not Disturb is enabled on your phone. For more information, contact your system administrator.

### Note

Call Forwarding is not available on shared lines.  
This feature is local to the phone, and may be overridden by call server settings.  
For more information, contact your system administrator.



### Static Forwarding

**To enable call forwarding to another party:**

1. Press  and select *Features > Forward*.

**123 Contact:**  
.....

**Enable | Cancel | <<**

2. (Optional) If multiple lines are configured on your phone, select the line to forward from the list using  and .



3. Enter a number to forward all future incoming calls to.

#### Note



You can also enter the SIP URL or IP address. For more information on using a SIP URL or IP address, refer to [To place a call using the handset:](#) on page 3-3

4. Press the **Enable** soft key to confirm call forwarding.

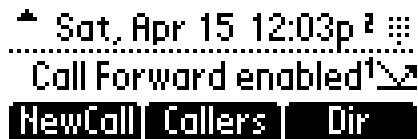
The idle display returns with a moving arrow as the line label to confirm call forwarding is enabled.



#### To disable call forwarding:

1. Press  and select *Features > Forward*.
2. (Optional) If multiple lines are configured on your phone, select the line to forward from the list using  and .
3. Press the **Disable** soft key to turn off call forwarding.

The idle display returns and the regular icon appears as the line indicator.

## Enabling Do Not Disturb

Press  and then select *Features > Do not disturb* to prevent the phone from ringing on incoming calls. A flashing icon and text on the graphic display indicates that Do Not Disturb is on.

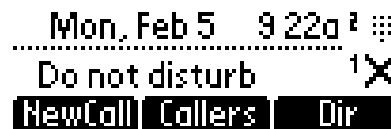



Calls received while Do Not Disturb is enabled are logged in the Missed Calls list unless configured to be forwarded to another party by your system administrator.

To disable Do Not Disturb, press  and then select *Features > Do not disturb* again.

**Note**

This feature is local to the phone, and may be overridden by call server settings. For more information, contact your system administrator.

**Multiple Lines and Do Not Disturb**

If multiple lines are configured on your phone, Do Not Disturb can be set on a line-by-line basis from the list using  and . For more information, contact your system administrator. When Do Not Disturb is enabled for a particular line, this is indicated by a flashing "X" beside the line indicator on the display.

## Assigning Speed Dial Indexes

You can associate a contact with  for single touch dialing of a frequently used number.

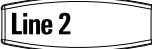
For example in the figure below, pressing  places a call to James.

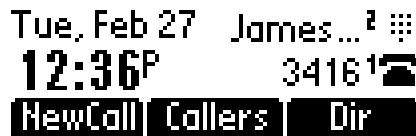
**Note**

The contact with the lowest speed dial index will be associated with the **Line 2** key for single touch dialing.



For other frequently used numbers, you can associate them with a speed dial index. To dial a contact associated with a speed dial index, enter the speed dial index followed by the # key using the dial pad, then press  or pick up the handset

The Speed Dial list can be accessed by pressing  and selecting *Features > Speed Dial...*



When a new entry is added to the Contact Directory, it is automatically assigned the next available speed dial index and the new entry appears at the bottom of the Speed Dial list.

## Assigning New Speed Dial Indexes

### To add or edit a speed dial index for an existing contact:

1. Press the **Dir** soft key.
2. Use  and  to scroll through the list to find the contact.
3. Press  to select the entry.





4. Press the **Edit** soft key.
5. Press  repeatedly until the speed dial index appears.
6. Press  to select the speed dial index for edit.
7. Do one of the following steps:
  - Enter the next available speed dial index.
  - Delete the existing speed dial index by using the **Backspace** soft key, and then enter a new speed dial index.
8. Press the **Ok** or **Cancel** soft keys to accept or cancel changes.
9. Press  repeatedly to return to the idle display.

### Note

Press and hold the unassigned **Line 2** key from the idle display to associate a speed dial index. The next available speed dial index will be assigned automatically.

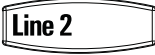
### To assign a new speed dial key:

1. Press and hold  if unassigned.  
A new empty entry in the contact directory is automatically opened allowing contact information to be added.
2. Press  to enter a first name.
3. Enter the first name of the contact from the dial pad.
4. Press the **Ok** or **Cancel** soft keys to accept or cancel changes.
5. Press  to display the next field in the contact's entry.
6. Repeat steps 2 to 5 to enter the last name of the contact.

7. Repeat steps 2 to 5 to enter a contact number.
8. Repeat steps 2 to 5 to change the *Speed Dial Index* if desired.

The index can be any value between the next available index value and the maximum (99).



Polycom recommends that you assign speed dial index values consecutively. For example, the second Line Key is assigned to the speed dial index value "2".

9. Press the **Yes** or **Cancel** soft keys to accept or cancel changes.
10. Press  repeatedly to return to the idle display.

**Note**

To add a speed dial contact if the **Line 2** key is already assigned, refer to [Adding Contacts](#) on page 1-1.

## Using Voice Mail

Your voice mail is saved in a centralized location and may be accessed from your phone.

The presence of new Voice Mail messages is indicated by a flashing Message Waiting Indicator LED on the front of the phone and a visual notification on the graphic display. If the phone is configured for multiple lines, an individual line indicator icon indicates Voice Mail messages left on that line.





A stutter dial tone in place of normal dial tone is used to indicate that one or more voice messages are waiting at the message center.

**Note**

Voice Mail is an optional feature configured on the call server and may not be supported on your particular system. For more information, contact your system administrator.

Screen options may vary with your application. Voice Mail may be accessible with a single key press. Contact your system administrator about this option.

**To listen to voice messages:**

1. Press the **Msgs** soft key or press , select *Features >* *Messages*, and then press .

**Note**

If your SoundPoint IP 330/320 has a **Messages** key, press it to access your Voice Mail.

2. Follow voice or visual prompts on the graphic display to retrieve your messages.

If multiple lines are configured on your phone, select from which line messages are to be retrieved.



---

# Using the Advanced Features of Your SoundPoint IP 330/320 Phone

This chapter provides operating instructions for the advanced features of the SoundPoint IP 330/320 phone. This chapter contains instructions on:

- [Using Automatic Call Distribution](#)
- [Using Multiple Call Appearances](#)
- [Using Buddy Lists](#)
- [Restarting Your Phone](#)

To customize your phone, refer to [Customizing Your SoundPoint IP 330/320 Phone](#) on page 2-1. To read about the phone's basic features, refer to [Using the Basic Features of Your SoundPoint IP 330/320 Phone](#) on page 3-1.

If you require additional information or assistance with your new phone, contact your system administrator.

## Using Automatic Call Distribution

Automatic call distribution (ACD) systems allow companies that handle a lot of incoming phone calls to direct them to a person who is able to talk at the earliest opportunity.

The SoundPoint IP 330/320 phone allows:

- ACD login and logout
- ACD agent available and unavailable

### Note

ACD is not available on all call servers. For more information, contact your system administrator.

**To log into the ACD:**

1. Press .
2. Select *Features > ACD Login/Logout...*



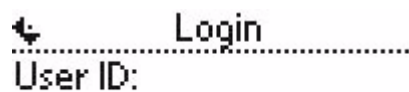

3. Select *Login*.

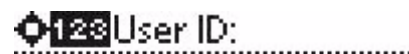

4. Press .



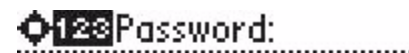

5. Enter your user ID and press the **Login** soft key.
6. Press  to display the next field.
7. Press .



8. Enter your password and press the **Login** soft key.
9. Press  repeatedly to return to the idle display.

**To log out of the ACD:**





1. Press .
2. Select *Features > ACD Login/Logout...*
3. Select *Logout*.
4. Press  repeatedly to return to the idle display.



**To set ACD agent availability:**

1. Press .
2. Select *Features > ACD Agent Availabilit...*



3. Use  and  to switch between Available and Unavailable settings.
4. Press  to select the setting.
5. Press  repeatedly to return to the idle display.

Repeat steps 1 to 5 to set the ACD agent to unavailable.

## Using Multiple Call Appearances

Each line on the phone can be configured to have one or more call appearances. More than one call appearances is useful if there is an active call and an incoming call arrives.

For example, the first figure shows Line 2 in a held call with Dean at extension 1703 and Line 1 has a call on hold.





The second figure shows Line 1 holding a call from Bob at extension 1701.

**To answer an incoming call when configured for multiple call appearances:**

- Do one of the following steps:

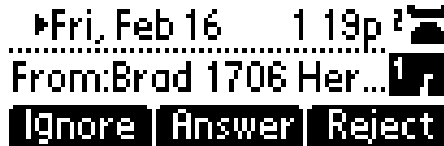
- Press  to put the original call on hold and then answer the incoming call.



- Answer the incoming call during the Call Waiting prompt (first 10 seconds).  
Soft key labels are updated on the display with **Ignore**, **Answer**, and **Reject**.
- Wait for the Call Waiting prompt to disappear, use  to scroll to the incoming call, and then answer the incoming call.

This places the original call on hold and refreshes the soft key labels.

If two or more call appearances are in use, one will appear on the display and the total number will be indicated by a counter at the top right corner of the display. For example "3/4" indicates that the highlighted call is the third one out of a total of four.

You can also place another outbound call on the same first line. Press  during the first call and press the **NewCall** soft key to obtain dial tone for a second call.

## Using Buddy Lists

Your SoundPoint IP 330/320 phone combines interactive message services and status monitoring to complement a traditional messaging application such as e-mail.

Live interaction within a pool of phones is possible by monitoring the "presence" of the parties involved. Your phone can "watch" the status of up to 8 other phones or 8 buddies. These other phones form your "buddy list". The status of your buddies is displayed and updated in real time. Your phone can be "watched" by up to 8 other phones.



If your SoundPoint IP 330/320 SIP phone is configured to work with Microsoft Live Communications Server 2005, the behavior of the presence setting and buddy lists is different. For more information, contact your system administrator.

## Presence

### To view and change your presence settings:

1. Press .
2. Select *Features > Presence > My Status*.



3. Use  or  to scroll through the list, and then press  to select your new status.

This affects information sent to phones watching you.







Presence information will also be sent to watching phones when you go off-hook or enable Do Not Disturb.

## Managing Buddies

### Note

The instructions in this section do not apply if your call server is Microsoft Live Communications Server 2005. In that case, refer to the following section, [Integrating With Microsoft Live Communications Server 2005](#).

### To add or delete a contact from your buddy list:







1. Press the **Dir** soft key.
2. Use  or  to scroll through the list to find the contact.
3. Press  to select the entry.
4. Press  repeatedly until the *Watch Buddy* field appears.
5. Press  to select the *Watch Buddy* field.
6. Use  or  to switch between Enabled and Disabled settings.

When *Watch Buddy* is enabled, the contact is added to your buddy list.  
When *Watch Buddy* is disabled, the contact is removed from your buddy list.

The default for *Watch Buddy* is Disabled.

7. Press the **Ok** or **Cancel** soft keys to accept or cancel changes.
8. Press  repeatedly to return to the idle display.

**To block or unblock a contact from your buddy list:**

1. Press the **Dir** soft key.
2. Use  or  to scroll through the list to find the contact.
3. Press  to select the entry.
4. Press  repeatedly until the *Block Buddy* fields.
5. Press  to select the *Block Buddy* field.
6. Use  or  to switch between Enabled and Disabled settings.

When *Block Buddy* is enabled, the contact cannot watch your phone. When *Block Buddy* is disabled, the contact can watch your phone.

The default for *Block Buddy* is Disabled.

7. Press the **Ok** or **Cancel** soft keys to accept or cancel changes.
8. Press  repeatedly to return to the idle display.

## Integrating With Microsoft Live Communications Server 2005

Your phone can be configured to work with Microsoft Live Communications Server 2005 and communicate with others using Microsoft Office Communicator and Windows Messenger. From your phone, you can invite, join, control, and monitor integrated multipoint audio and video conferences.





Any contacts added through your buddy list will appear as a contact in Microsoft Office Communicator and Windows Messenger. Any contacts added as a contact in Microsoft Office Communicator and Windows Messenger will appear in your buddy list.

To view and change your presence, refer to [To view and change your presence settings](#): on page 4-5.

For more information, contact your system administrator.









**To add a contact to your buddy list:**

1. Press .
2. Select *Features > Presence > Buddy Status*.

3. Do one of the following steps:
  - a If the buddy list is empty, press  to enter a new buddy's contact number.
  - b If the buddy list is not empty, use  to scroll up the new entry, press  to enter a new buddy's contact number.
  - c If the buddy list is not empty, press  to select an entry, then press the **Add** soft key to add a new entry.
4. Enter the desired contact number and press the **Ok** soft key.
5. Press  repeatedly to return to the idle display.

You can also delete a contact or dial a contact from your buddy list.

#### To view and change your privacy list:

1. Press .
2. Select *Features > Presence > Privacy List*.
3. Use  or  to scroll through the list to find the contact.
4. Press  to select the entry.
5. Press **Edit** soft key.
6. Press  to scroll through the list to find the *Access* field.
7. Press  to select the field.
8. For *Access*, use  or  to select Enabled.  
 When *Access* is enabled, you are allowing the contact to see your presence.  
 When *Access* is disabled, you are disallowing the contact from seeing your presence.  
 The default for access is Disabled.
9. Press  repeatedly to return to the idle display.

You can also delete a contact or dial a contact from your privacy list.

For more information on contacting buddies, refer to [Placing a Call](#) on page 3-2 or the Microsoft Office Communicator and Windows Messenger documentation.

## Restarting Your Phone

Periodically, you may need to restart your phone. The reasons for this include:

- Accepting a new configuration
- Accepting new software

**Note**



In the case of problems, it may be possible to restore normal operation of your phone without restarting. Contact your system administrator before attempting to restart your phone.

**Note**

The call lists are automatically cleared when you restart the phone.

**To restart the phone:**

➤ Do one of the following steps:

- Simultaneously press and hold **Hold**, , and  for more than 3 seconds or until a beep is heard.

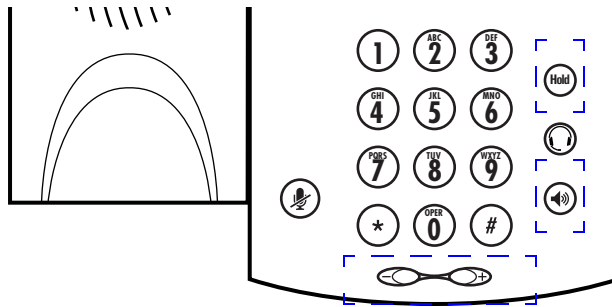

- Press  , then select *Settings > Advanced > Restart Phone*.

You must enter the administrative password to access this menu.

The restart process will begin and is complete when the idle display is shown.

---

# Troubleshooting Your SoundPoint IP 330/320 Phone

This chapter presents problems, likely causes, and corrective actions. Problems are grouped as follows:

- [Power and Startup](#)
- [Controls](#)
- [Access to Screens and Systems](#)
- [Calling](#)
- [Displays](#)
- [Audio](#)

If you still need assistance, contact your system administrator.

## Power and Startup

Symptom	Problem	Corrective Action
There are power issues.	The SoundPoint IP 330/320 phone has no power.	Do one of the following steps: <ul style="list-style-type: none"><li data-bbox="971 453 1409 506">• Verify that no lights appear on the unit when it is powered up.</li><li data-bbox="971 516 1409 569">• Check if the phone is properly plugged into a functional AC outlet.</li><li data-bbox="971 579 1409 663">• Make sure that the phone isn't plugged into a plug controlled by a light switch that is off.</li><li data-bbox="971 674 1409 758">• If plugged into a power strip, try plugging directly into a wall outlet instead.</li><li data-bbox="971 768 1409 852">• Try the phone in another room where the electricity is known to be working on a particular outlet.</li></ul>



## Controls

Symptom	Problem	Corrective Action
<p>The dial pad does not work.</p>	<p>The dial pad on the SoundPoint IP 330/320 phone does not respond.</p>	<p>Do one of the following steps:</p> <ul style="list-style-type: none"> <li>• Check for a response from other feature keys or from the dialpad.</li> <li>• Place a call to the phone from a known working telephone. Check for display updates.</li> <li>• Press the Menu key followed by System Status and Server Status to check if the telephone is registered correctly to the server.</li> <li>• Press the Menu key followed by System Status and Network Statistics. Scroll down to see if LAN port shows active or Inactive.</li> <li>• Check the termination at the switch or hub end of the network LAN cable. Ensure that the switch/hub port connected to the telephone is operational (if not accessible, contact your system administrator).</li> <li>• Before restarting your phone, contact your system administrator, since this may allow more detailed troubleshooting to occur before losing any current status information.</li> </ul>

## Access to Screens and Systems

Symptom	Problem	Corrective Action
There is no response from feature key presses.	The SoundPoint IP 330/320 phone is not in active state.	<p>Do one of the following steps:</p> <ul style="list-style-type: none"> <li>• Press the keys more slowly.</li> <li>• Check with the system administrator to see whether or not the key has been mapped to a different function or disabled.</li> <li>• Make a call to the phone to check for inbound call display and ringing as normal. If successful, try to press feature keys within the call to access the Menu, for example.</li> <li>• Press <b>Menu</b> followed by <b>Status &gt; Lines</b> to confirm line is actively to the call server.</li> <li>• Reboot the phone to attempt re-registration to the call server (refer to <a href="#">Restarting Your Phone</a> on page 4-8).</li> </ul>
The display shows “Network Link is Down”.	The LAN cable is not properly connected.	<p>Do one of the following steps:</p> <ul style="list-style-type: none"> <li>• Check termination at the switch or hub (furthest end of the cable from the phone).</li> <li>• Check that the switch or hub is operational (flashing link/status lights) or contact your system administrator.</li> <li>• Press <b>Menu</b> followed by <b>Status &gt; Network</b>. Scroll down to verify that the LAN is active.</li> <li>• Reboot the phone to attempt re-registration to the call server (refer to <a href="#">Restarting Your Phone</a> on page 4-8).</li> </ul>

## Calling

Symptom	Problem	Corrective Action
There is no dial tone.	Power is not correctly applied to the SoundPoint IP 330/320 phone.	<p>Do one of the following steps:</p> <ul style="list-style-type: none"> <li>• Check that the display is illuminated.</li> <li>• Make sure the LAN cable is inserted properly at the rear of the phone (try unplugging and re-inserting the cable).</li> <li>• If using in-line powering, have your system administrator check that the switch is supplying power to the phone.</li> </ul>
	Dial tone is not present on one of audio paths.	<p>Do one of the following steps:</p> <ul style="list-style-type: none"> <li>• Switch between Handset, Headset (if present) or Hands-Free Speakerphone to see if dial tone is present on other paths.</li> <li>• If dial tone exists on another path, connect a different handset or headset to isolate the problem.</li> </ul>

Symptom	Problem	Corrective Action
The phone does not ring.	Ring setting or volume is low.	Do one of the following steps: <ul style="list-style-type: none"> <li>• Adjust the ringing level from the front panel using the volume up/down keys.</li> <li>• Check same status of handset, headset (if connected) and through the Hands-Free Speakerphone.</li> </ul>
	Outbound or inbound calling is unsuccessful.	Do one of the following steps: <ul style="list-style-type: none"> <li>• Place a call to the phone under investigation. Check that the display indicates incoming call information.</li> <li>• Lift the handset. Ensure dial tone is present and place a call to another extension or number. Check that the display changes in response.</li> </ul>
	You turned off the ringer.	Do one of the following steps: <ul style="list-style-type: none"> <li>• When there is an incoming call, lift the handset, press Speaker key or press Headphone key and you will get a dialtone.</li> <li>• Pressing the ringing Line Key or <b>Answer</b> soft key will answer the call.</li> <li>• If the handset is off-hook when <b>Answer</b> soft key or Line Key is pressed, the call is routed to the handset.</li> <li>• If the handset is on-hook when <b>Answer</b> soft key or Line Key is pressed, the call is routed to the speaker.</li> </ul>
"Service Unavailable" is displayed on the graphic display.	The user pressed the New Call soft key, dialed a number with the handset on-hook, attempted to make a call from the contact directory when the phone was not registered.	Do one of the following steps: <ul style="list-style-type: none"> <li>• Check with the system administrator to see when your phone will be registered.</li> </ul>

## Displays

Symptom	Problem	Corrective Action
<p>There is no display. The display is incorrect. The display has bad contrast.</p>	<p>Power is not correctly applied to the SoundPoint IP 330/320 phone.</p>	<p>Do one of the following steps:</p> <ul style="list-style-type: none"> <li>• Check that the display is illuminated.</li> <li>• Make sure the LAN cable is inserted properly at the side of the phone (try unplugging and re-inserting the cable).</li> <li>• If using in-line powering, have your system administrator check that the switch is supplying power to the phone.</li> </ul>
	<p>The contrast needs adjustment.</p>	<p>Do one of the following steps:</p> <ul style="list-style-type: none"> <li>• Refer to <a href="#">Display Contrast</a> on page 2-3.</li> <li>• Reboot the phone to obtain a default level of contrast (refer to <a href="#">Restarting Your Phone</a> on page 4-8).</li> </ul>
	<p>Outbound or inbound calling is unsuccessful.</p>	<p>Do one of the following steps:</p> <ul style="list-style-type: none"> <li>• Place a call to the phone under investigation. Check that the display indicates incoming call information.</li> <li>• Lift the handset. Ensure dial tone is present and place a call to another extension or number. Check that the display changes in response.</li> </ul>
<p>The display is flickering.</p>	<p>Certain type of older fluorescent lighting causes the display to appear to flicker.</p>	<p>Do one of the following steps:</p> <ul style="list-style-type: none"> <li>• Move the SoundPoint IP 330/320 SIP phone away from the lights.</li> <li>• Replace the lights.</li> </ul>

## Audio

Symptom	Problem	Corrective Action
<p>There is no audio on the headset.</p>	<p>The connections are not correct.</p>	<p>Do one of the following steps:</p> <ul style="list-style-type: none"> <li>• Ensure the headset is plugged into the jack marked Headset at the rear of the phone.</li> <li>• Ensure the headset amplifier (if present) is turned on and/or the volume is correctly adjusted).</li> </ul>



---

# Regulatory Notices

## Service Agreements

Please contact your Polycom Authorized Reseller for information about service agreements applicable to your product.

## Governing Law

This Limited Warranty and Limitation of Liability shall be governed by the laws of the State of California, U.S.A., and by the laws of the United States, excluding their conflicts of laws principles. The United Nations Convention on Contracts for the International Sale of Goods is hereby excluded in its entirety from application to this Limited Warranty and Limitation of Liability.

All rights reserved under International and Pan-American Copyright Conventions. No part of the contents of this manual may be copied, reproduced, or transmitted in any form or by any means, or translated into another language or format, in whole or part, without written consent from Polycom, Inc. Do not remove (or allow anybody else to remove) any product identification, copyright or other notices.

## Limitations of Liability

LIMITATION OF LIABILITY. TO THE FULL EXTENT ALLOWED BY LAW, POLYCOM EXCLUDES FOR ITSELF AND ITS SUPPLIERS ANY LIABILITY, WHETHER BASED IN CONTRACT OR TORT (INCLUDING NEGLIGENCE), FOR INCIDENTAL, CONSEQUENTIAL, INDIRECT, SPECIAL, OR PUNITIVE DAMAGES OF ANY KIND, OR FOR LOSS OF REVENUE OR PROFITS, LOSS OF BUSINESS, LOSS OF INFORMATION OR DATA, OR OTHER FINANCIAL LOSS ARISING OUT OF OR IN CONNECTION WITH THE SALE, INSTALLATION, MAINTENANCE, USE, PERFORMANCE, FAILURE, OR INTERRUPTION OF ITS PRODUCTS, EVEN IF POLYCOM OR ITS AUTHORIZED RESELLER HAS BEEN ADVISED OF THE POSSIBILITY OF SUCH DAMAGES, AND LIMITS ITS LIABILITY TO REPAIR, REPLACEMENT, OR REFUND OF THE PURCHASE PRICE PAID, AT POLYCOM'S OPTION. THIS DISCLAIMER OF LIABILITY FOR DAMAGES WILL NOT BE AFFECTED IF ANY REMEDY PROVIDED HEREIN SHALL FAIL OF ITS ESSENTIAL PURPOSE.

### **Polycom Limited Warranty and Limitation Liability**

LIMITED WARRANTY. Polycom warrants to the end user (“Customer”) that this product is expected to be free from defects in workmanship and materials, under normal use and service, for one year from the date of purchase from Polycom or its authorized reseller.

Polycom’s sole obligation under this express warranty is at Polycom’s option and expense, to repair the defective product or part, deliver to Customer an equivalent product or part to replace the defective item, or if neither of the two foregoing options are reasonably available, Polycom may, on its sole discretion, refund to Customer the purchase price paid for the defective product. All products that are replaced will become the property of Polycom. Replacement products or parts may be new or reconditioned.

Polycom is expected to warrant any replaced or repaired product or part for ninety (90) days from shipment, or the remainder of the initial warranty period, whichever is longer. Products returned to Polycom must be sent prepaid and packaged appropriately for safe shipment, and it is recommended that they be insured or sent by a method that provides for tracking of the package. Responsibility for loss or damage does not transfer to Polycom until the returned item is received by Polycom. The repaired or replaced item will be shipped to Customer, at Polycom’s expense, not later than thirty (30) days after Polycom receives the defective product, and Polycom will retain risk of loss or damage until the item is delivered to Customer.

### **Exclusions**

Polycom will not be liable under this limited warranty if its testing and examination disclose that the alleged defect or malfunction in the product does not exist or results from:

- Failure to follow Polycom’s installation, operation, or maintenance instructions.
- Unauthorized product modification or alteration.
- Unauthorized use of common carrier communication services accessed through the product.
- Abuse, misuse, negligent acts or omissions of Customer and persons under Customer’s control; or
- Acts of third parties, acts of God, accident, fire, lightening, power surges or outages, or other hazards.

### **Warranty Exclusive**

IF A POLYCOM PRODUCT DOES NOT OPERATE AS WARRANTED ABOVE, CUSTOMER’S SOLE REMEDY FOR BREACH OF THAT WARRANTY SHALL BE REPAIR, REPLACEMENT, OR REFUND OF THE PURCHASE PRICE PAID, AT POLYCOM’S OPTION. TO THE FULL EXTENT ALLOWED BY LAW, THE FOREGOING WARRANTIES AND REMEDIES ARE EXCLUSIVE AND ARE IN LIEU OF ALL OTHER WARRANTIES, TERMS, OR CONDITIONS, EXPRESS OR IMPLIED, EITHER IN FACT OR BY OPERATION OF LAW, STATUTORY OR OTHERWISE, INCLUDING WARRANTIES, TERMS, OR CONDITIONS OF MERCHANTABILITY, FITNESS FOR A PARTICULAR PURPOSE, SATISFACTORY QUALITY, CORRESPONDENCE WITH DESCRIPTION, AND NON-INFRINGEMENT, ALL OF WHICH ARE EXPRESSLY DISCLAIMED. POLYCOM NEITHER ASSUMES NOR AUTHORIZES ANY OTHER PERSON TO ASSUME FOR IT ANY OTHER LIABILITY IN CONNECTION WITH THE SALE, INSTALLATION, MAINTENANCE OR USE OF ITS PRODUCTS.



## Safety and Compliance

### Part 15 FCC Rules

This device is compliant with Part 15 of the FCC Rules. Operation is subject to the following two conditions:

1. This device may not cause harmful interference, and
2. This device must accept any interferences received, including interference that may cause undesired operation.

### Class B Digital Device or Peripheral

Note: This equipment is tested and complies with the limits for a Class B digital device, pursuant to Part 15 of the FCC Rules. These limits are designed to provide reasonable protection against harmful interference in a residential installation. This equipment generates, uses, and can radiate radio frequency energy and, if not installed and used in accordance with the instructions, may cause harmful interference to radio communications. However, there is no guarantee that interference will not occur in a particular installation. If this equipment does cause harmful interference to radio or television reception, which can be determined by turning the equipment off and on, the user is encouraged to try to correct the interference by one or more of the following measures:

1. Reorient or relocate the receiving antenna.
2. Increase the separation between the equipment and receiver.
3. Connect the equipment into an outlet on a circuit different from that to which the receiver is connected.
4. Consult the dealer or an experience radio/TV technician for help.

### Modifications

In accordance with Part 15 of the FCC Rules, the user is cautioned that any changes or modifications not expressly approved by Polycom, Inc. could void the user's authority to operate the equipment. This equipment may not be used on a coin service or party line.

### Installation Instructions

Installation must be performed in accordance with all relevant national wiring rules.

L'Installation doit être exécutée conformément à tous les règlements nationaux applicable au filage électrique.

### Plugs Acts as Disconnect Device

The socket outlet to which this apparatus is connected must be installed near the equipment and must always be readily accessible.

La prise électrique à laquelle l'appareil est branché doit être installée près de l'équipement et doit toujours être facilement accessible.

### Industry Canada (IC)

This Class [B] digital apparatus complies with Canadian ICES-003.

Cet appareil numérique de la classe [B] est conforme à la norme NMB-003 du Canada.

### CE and VCCI Mark

This SoundPoint IP 330/320 SIP is marked with the CE mark. This mark indicates compliance with EEC directories 89/336/EEC and 73/23/EEC. A full copy of the Declaration of Conformity can be obtained from Polycom Ltd., 270 Bath Road, Slough, Berkshire, SL1 4DX, UK.

この装置は、情報処理装置等電波障害自主規制協議会（VCCI）の基準に基づくクラスB情報技術装置です。この装置は、家庭環境で使用することを目的としていますが、この装置がラジオやテレビジョン受信機に近接して使用されると、受信障害を引き起こすことがあります。

取扱説明書に従って正しい取り扱いをして下さい。



---

# Index

## Symbols

# key, page down shortcut 1-10

\* key, page up shortcut 1-10

## Numerics

123 icon 2-9

## A

ABC icon 2-8

ACD. *See also* automatic call distribution

answering calls 3-4

assembling your phone 1-3

assigning speed dial indexes 3-14

automatic call distribution 4-1

## B

base, attaching 1-5

block buddies 4-6

buddy lists 4-4

## C

call lists

types of 2-6

calls

ending 3-7

on hold 3-8

with handsets 3-3

with headsets 3-3

conferences, setting up 3-9

contact directory 2-7

contact lists. *See* buddy lists

customizing your phone 2-1

## D

data entry 1-10

data entry, switching modes 1-10

directory search 2-5

directory, contacts 2-7

display contrast 2-3

Do Not Disturb 3-13

## E

ending calls 3-7

## F

features

advanced 4-1

basic 3-1

list of 1-8

SoundPoint IP 330 1-8

forwarding calls 3-12

## G

getting started 1-1

## H

handset

answering a call 3-5

connecting 1-4

illustration 1-2

placing a call 3-3

hands-free mode

answering a call 3-5

placing a call 3-3

headset

answering a call 3-5

connecting 1-4

memory mode 2-3

placing a call 3-3

headset jack 1-5

headset memory mode 2-3

holding calls 3-8

## I

idle display 2-2

inactivity timer 1-11

## L

language support 2-5

## M

- managing buddies 4-5
- microphone mute 3-7
- Microsoft Office Live Communications Server 2005 4-4, 4-6
- multiple call appearances 4-3
- multiple calls, hold 3-9
- multiple keys per line 2-16
- multiple lines
  - call forwarding 3-12
  - Do Not Disturb 3-14
  - ring type 2-4
  - support for 2-15
  - Voice Mail 3-17
- MyStat 4-5

## N

- navigation guide icon 1-11
- navigation key usage 1-10
- network connection, phone 1-4

## P

- parts list 1-2
- placing calls 3-2
- PoE. *See* Power over Ethernet
- Power over Ethernet (PoE) 1-4
- power source, phone 1-4
- presence 4-5
- privacy list 4-7

## R

- redialing numbers 3-8
- restarting phones 4-8
- ring types 2-4
- RJ-9 1-5

## S

- shared lines 2-16
- SoundPoint IP 320. *See* SoundPoint IP 330

## SoundPoint IP 330

- adjusting display contrast 2-3
  - adjusting volume 3-8
  - advanced features 4-1
  - answering calls 3-4
  - assembling 1-3
  - assigning speed dial indexes 3-14
  - attaching base 1-5
  - automatic call distribution 4-1
  - basic features 3-1
  - buddy lists 4-4
  - call lists, types of 2-6
  - calls, on hold 3-8
  - contact directory 2-7
  - customizing 2-1
  - data entry 1-10
  - Do Not Disturb 3-13
  - ending calls 3-7
  - features, list of 1-8
  - figure, features 1-8
  - forwarding calls 3-12
  - getting started 1-1
  - handset 1-4
  - headset 1-4
  - headset memory mode 2-3
  - idle display 2-2
  - illustration 1-2
  - language support 2-5
  - multiple call appearances 4-3
  - multiple keys per line 2-16
  - muting microphone 3-7
  - navigation key usage 1-10
  - parts list 1-2
  - placing calls 3-2
  - presence 4-5
  - redialing numbers 3-8
  - restarting phone 4-8
  - ring type 2-4
  - setting time and date 2-2
  - setting up conferences 3-9
  - shared lines 2-16
  - transferring calls 3-10
  - troubleshooting 5-1
  - useful tips 1-10
  - using multiple lines 2-15
  - voice mail 3-16
- ## SoundPoint IP 330/320
- difference between phones 1-4
  - speakerphone. *See* hands-free mode
  - speed dialing 3-14
  - switching entry modes 1-10

**T**

time and date 2-2

transferring calls 3-10

troubleshooting

  audio problems 5-7

  calling problems 5-5

  controls problems 5-3

  display problems 5-7

  power and startup problems 5-2

  screen and system problems 5-4

**U**

useful phone tips 1-10

**V**

voice mail 3-16

volume 3-8

**W**

watch buddies 4-5

