

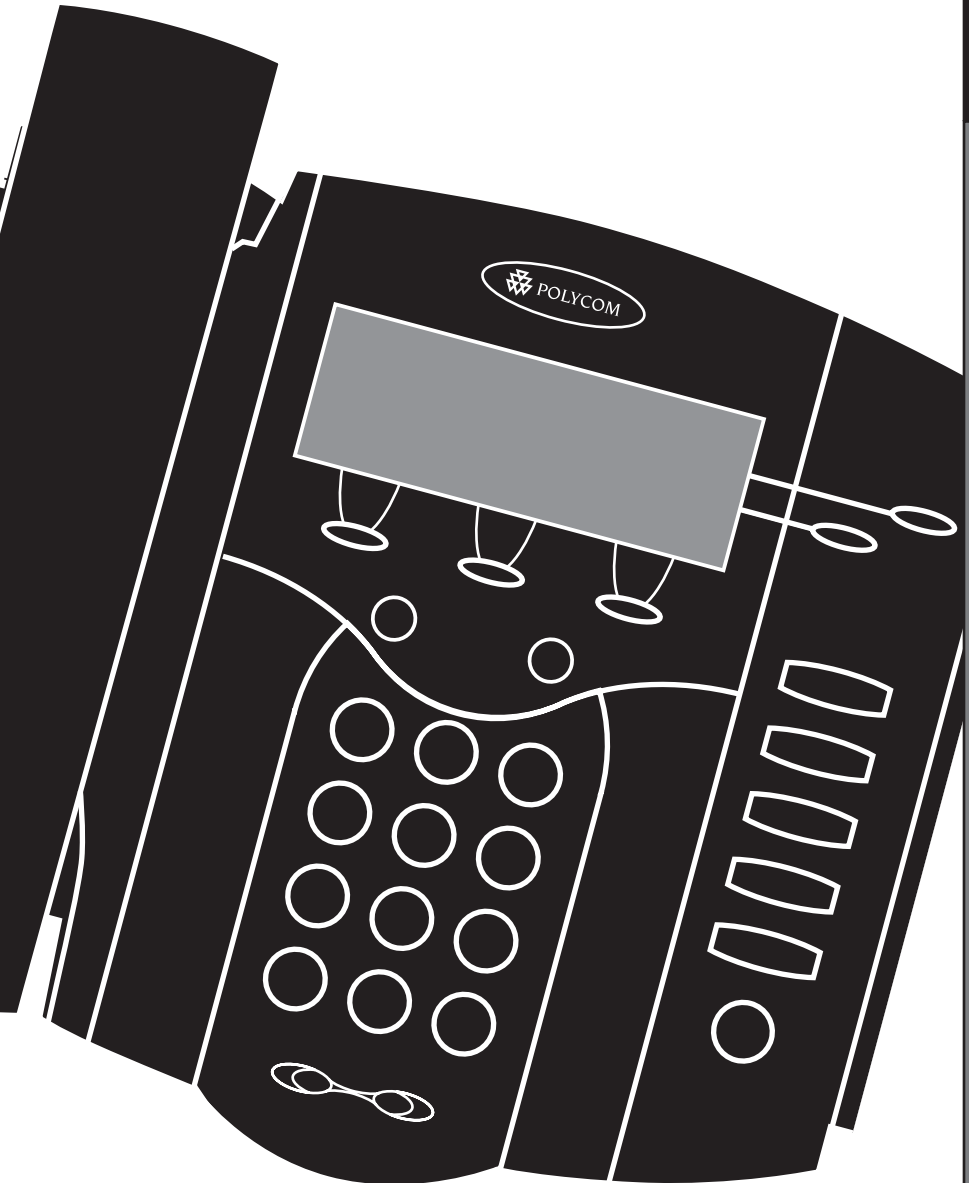

POLYCOM®

User Guide

SoundPoint® IP 300/301 SIP 2.0



Contents

Introduction	1
Parts List	1
Installing SoundPoint® IP 300/301 SIP.....	2
Connecting Network and Power Source.....	2
Connecting the Handset and Optional Headset	3
Attaching the Base.....	3
Features	4
Key Descriptions	5
Using SoundPoint® IP 300/301 SIP	6
Placing a Call	6
Answering a Call.....	7
Call Hold and Resume.....	7
Multiple Calls on Hold.....	7
Microphone Mute.....	7
General Key Use	8
Local Conferencing.....	8
Splitting a Conference	8
Transferring a Call	9
Call Timer.....	9
Ending a Call	9
Redial.....	10
Call Forwarding.....	10
Volume Adjustment.....	10
Do Not Disturb	11
Time and Date	11
Headset Memory Mode	11
Display Contrast	12
Ring Type.....	12
Call Lists	12
Contact List.....	13
Speed Dial	14
Multiple Lines.....	14
Multiple Keys Per Line	14
Multiple Call Appearances	15
Shared Lines.....	15

Voice Mail 16
Distinctive Ringing / Call Treatment..... 16
Phone Reboot..... 17

Optional Features 17
Text Messaging 17
Presence / Status / Buddy Lists..... 18

Troubleshooting 20

Safety and Compliance..... 22
Part 15 Rules 22
Class B Digital Device or Peripheral..... 22
Modifications 22
Installation Instructions 22
Plug Acts as Disconnect Device 22
Industry Canada (IC) 23
CE and VCCI Mark 23

**Polycom Limited Warranty
and Limitation Liability 23**

Exclusions 24

Warranty Exclusive..... 24

Service Agreements..... 24

Limitations of Liability 24

Disclaimer 25

Governing Law 25

Copyright Notice 25



Introduction

Thank you for choosing the SoundPoint® IP 300/301 SIP. This unit provides business telephony features and functions such as Multiple Call Appearances, Call Hold, Transfer, and Conference over an IP network. In this User Guide you will find everything you need to quickly use your new phone. Be sure to verify with your

system administrator that your network is prepared for configuring your SoundPoint® IP 300/301 SIP phone. As well, be sure to read the Parts List and the Safety Notices section in this guide before you set up and use the SoundPoint® IP 300/301 SIP phone.

Parts List

The following items are included in your SoundPoint® IP 300/301 SIP package. Check this list before installation to ensure

that you have received each item. If you are missing any items, please contact your system administrator.

Polycom SoundPoint® IP 300/301 SIP

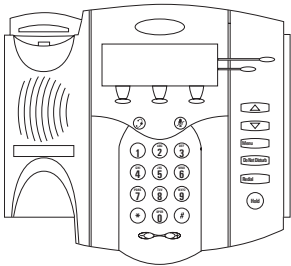

Power Adapter

(specification varies according to country)

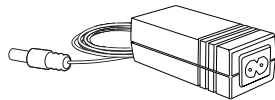

For SoundPoint® 301, the power adapter is not included in the PoE bundle. See your system administrator if you require one.

Handset & Handset Cord

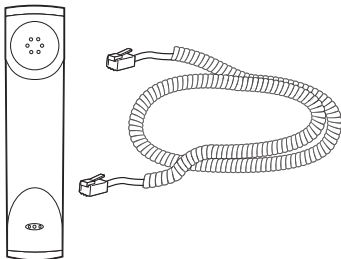

Phone Base

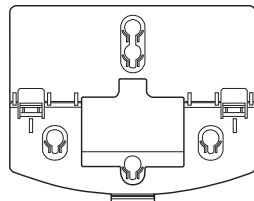

Network / Power Cable

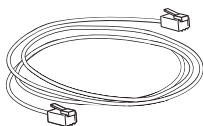

Quick Start Guide



Installing SoundPoint® IP 300/301 SIP

This section provides basic installation instructions and information for obtaining the best performance with the SoundPoint® IP 300/301 SIP phone. If you require additional information or assistance with your new phone, please contact your system administrator.

The SoundPoint® IP 300/301 SIP User Guide includes regulatory compliance information that your system administrator should review and can also be found at: www.polycom.com

Connecting Network and Power Source

AC Power Option

Connect the supplied Network Cable between the LAN jack on the phone and the LAN port on the wall or hub/switch device port. Connect the DC plug of the AC wall adapter into the supplied LAN cable as shown.

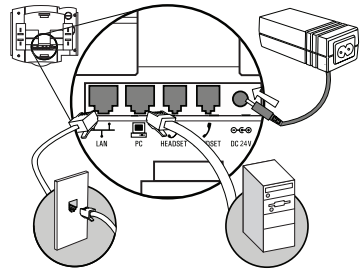

Power over Ethernet (PoE) Option

Using an Inline Power Cable (optional accessory from Polycom), the phone can be alternately powered from a Power over Ethernet (PoE) compliant switch or hub. Inline Power Cables exist for both IEEE 802.3af and Cisco pre-standard PoE options. Plug the keyed end of the Inline Power Cable into the LAN jack on the phone and the other end to an available port on the POE switch or hub.

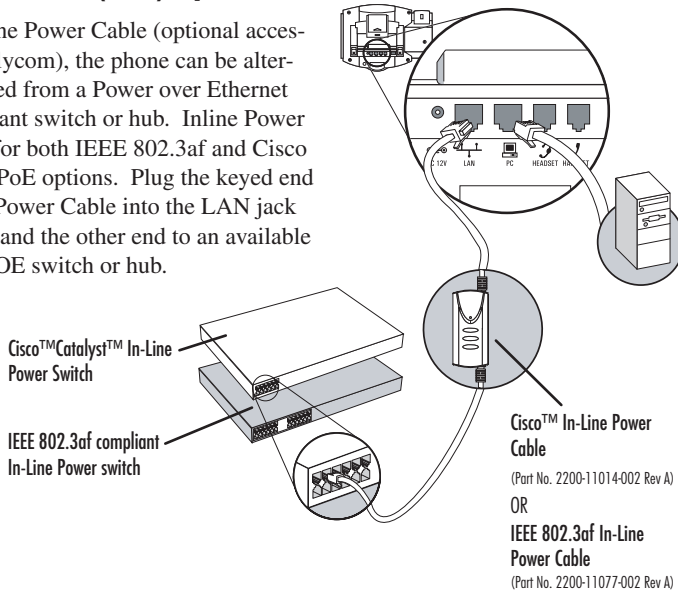

Connecting the Handset and Optional Headset

1. Connect the short straight end of the phone cord to the handset and the corresponding longer straight end of the cord to the handset jack on the back of the phone.
2. Connect the headset (optional accessory) to the headset jack on the back of the phone.

(Optional)

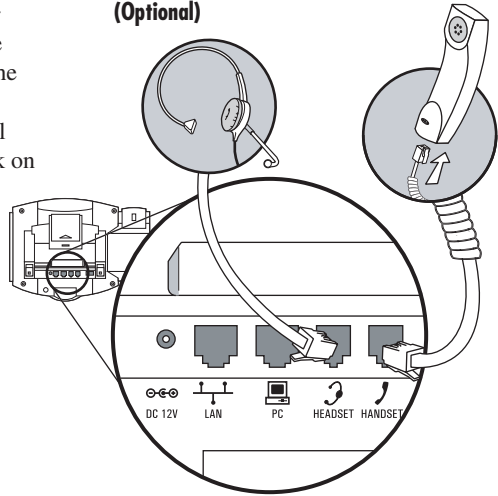

For information on headsets, please visit www.polycom.com and choose the Support link.

Attaching the Base



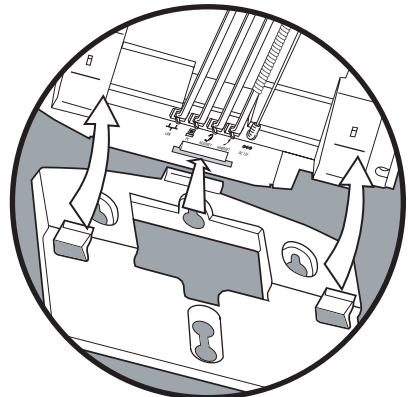
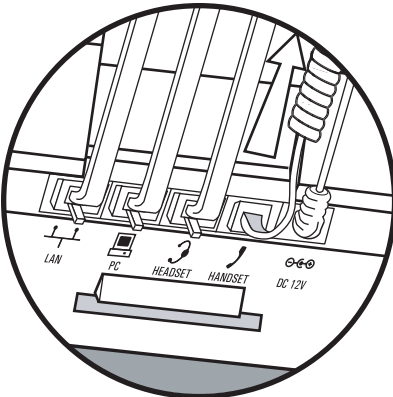



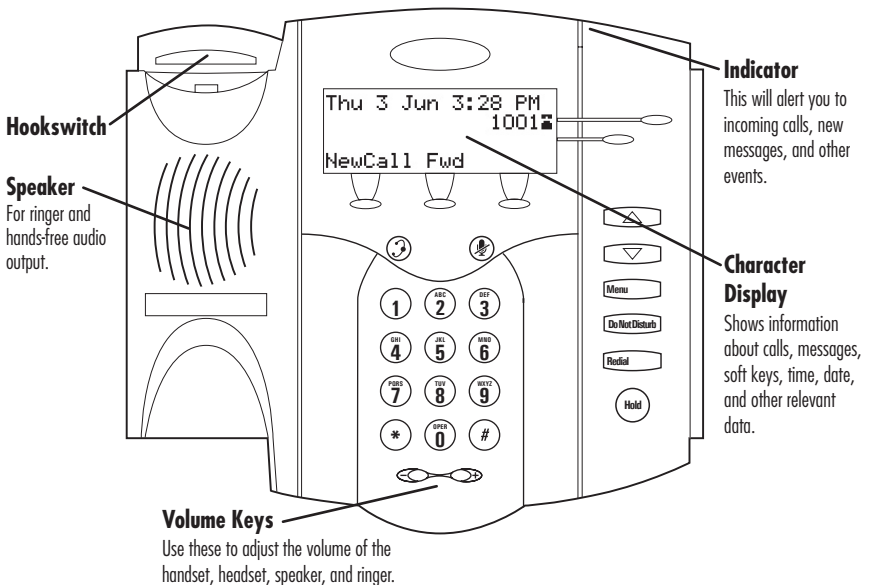
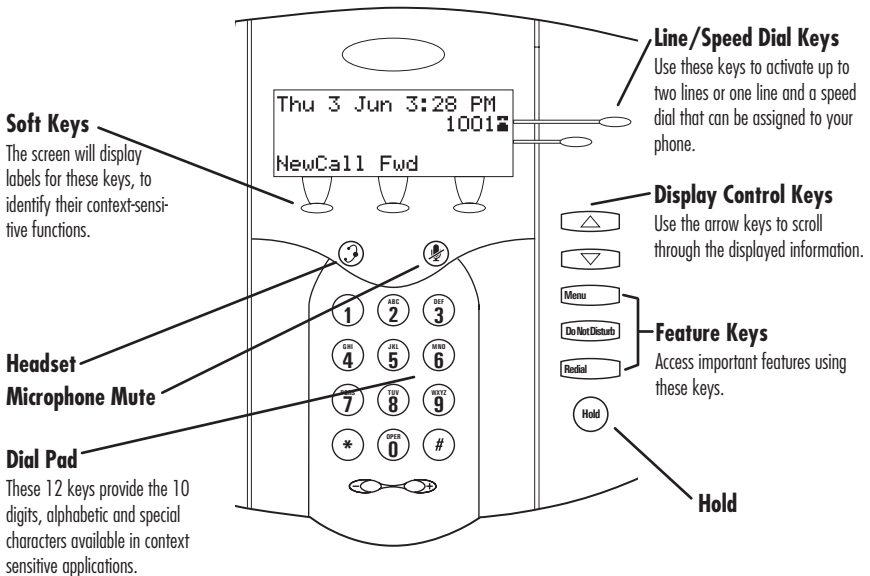



1. Place all cords in the recessed area above the modular jacks as shown.
2. Align the two protrusions on the bracket with their corresponding holes in the phone and snap them together to lock the base to the phone.



Features

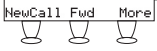

Key Descriptions

Feature Key	Description
	Mutes audio transmission locally during calls.
	Allows you to place and receive calls through an optionally connected headset.
	Line or Speed Dial keys.
	Scrolls through menu options.
	Scrolls through menu options.
	Access local and server features.
	Cancels ringing and directs incoming calls to your Voice Mail (if supported).
	Dials last connected party from the phone.
	Places current active call in Hold state.
	Soft keys to select from various context-sensitive options.
	Volume keys to adjust audio and ringer volume.
Dial Pad	General dialing and alphanumeric entry (including special characters).

Using SoundPoint® IP 300/301 SIP

Placing a Call

Using the Handset:

1. To obtain dial tone, pick up the handset.
2. Dial the desired number.

During a call, you can alternate between handset or headset modes by pressing the  key, or picking up the handset.

Using Listen Mode:

1. With the handset on-hook, press , and choose *Features*, followed by *Listen Mode*.
2. Dial the desired number.

Listen Mode can be used for listening to a conference call but not actively participating, or for checking voice mail.

Using the Headset:

1. With the optional headset connected, press a line key, , or **NewCall** to obtain dial tone.
2. Dial the desired number.

See also Headset Memory Mode.

You also have the option to dial directly from the dial pad without first getting dial tone. Simply enter the number then lift the handset or press the **Dial** soft key or press the  key.

In all cases, the active call will appear on the display showing call duration and destination.

*To obtain the IP address of your phone, press  followed by *Status, Platform and Phone*. The IP address is listed together with other network information.*

Answering a Call



Using the Handset:

Pick up the handset.

Using Listen Mode:

Press the **Answer** soft key or the line key ()

Using the Headset:

Pressing  will answer the call through an optionally connected headset. If headset memory mode is enabled, pressing the line key () will do the same.

In all cases, the active call will appear on the display showing call duration and destination.

*Incoming calls may be ignored by pressing the **Reject** soft key or  during ringing. Note that **Do Not Disturb** stays active when the call is dropped and will remain so until toggled off.*

Call Hold and Resume

During a call, press  or the **Hold** soft key. The call will be placed on hold and this will be indicated on the display. Press the **Resume** soft key to retrieve the call.

Multiple Calls on Hold

If multiple calls are on hold on a single line key, use the arrow keys to switch between the calls then press the **Resume** soft key to retrieve the desired call. If more than two calls are on hold on a single key, an indication will appear on the display, for example “2/3” shows that this is the second call out of three calls.

If calls are on hold on more than one line key, the details of the calls on any line key can be viewed by pressing that line key and holding it down for a few seconds. If a line key is pressed briefly, the first call on hold on that line key will be retrieved.

Microphone Mute





During a call, press . The LED on the phone lights up and a flashing microphone on the display indicates that the other party (parties) cannot hear you.

Microphone Mute applies to handset and headset modes. You can still hear all other parties while Mute is enabled.

To turn off Microphone Mute, press  again.

General Key Use

To navigate through menus and to enter data, these are useful tips:

1. Use  and  or the **Next** and **Prev** soft keys to scroll through lists. In some lists the  and  keys can be used as “Page Up” and “Page Down”.
2. Many soft keys can only be accessed by pressing the **More** soft key.
3. Press  to exit from any menu.
4. To enter text using the dial pad, press the number keys one or more times. For example, for ‘A’ press ‘2’ and for ‘C’ press ‘222’. When in text entry mode the display title will show whether keys will generate numbers (1), upper-case (A) or lower-case (a) characters and the **1/A/a** soft key can change this.

Local Conferencing

You can create a conference with two other parties using the phone’s local conferencing feature.

1. Place a call to the first party.
2. Press the **Conf** soft key to obtain a new line (the active call is placed on hold).
3. Dial the number of the second party or use the arrow keys to access speed dial numbers or the missed call list, or use the Features menu to access placed and received call lists. From one of these lists press the **Dial** soft key.
4. When the second party answers, press the **Conf** soft key again to join all parties in the conference, or press the **Split** soft key to put the first call on hold and keep the second call as the active call.

A conference may be created at any time between an active call and a call which is on hold (on the same line) by pressing the **Join** soft key.

Ending the call on the conference originator’s phone will not end the conference; the other two parties can continue to talk

Splitting a Conference

When a conference has been established, a **Split** soft key is available. Pressing this

key will split the conference into two calls on hold.

Transferring a Call

1. During a call, press the **Trnsfr** soft key (the active call is placed on hold).
2. Dial the number to which you want to transfer the call or use the arrow keys to access speed dial numbers or the missed call list, or use the Features menu to access placed and received call lists. From one of these lists press the **Dial** soft key.
3. Press the **Trnsfr** soft key again or hang up to complete the transfer. This can be done as soon as the ringback sound is heard or you can wait until the third party answers and talk to them before completing the transfer. Press the **Split** soft key to put the first call on hold and keep the second call as the active call.

*A blind transfer (without consultation) can also be supported by pressing the **Blind** soft key.*

Transfer may be cancelled during establishment by pressing the **Cancel** soft key. The original call is resumed.

Call Timer

Call progress on an active call is monitored through a local call timer. This is visible within the active call window on the display.

```
Mon, Nov 22 2:23PM  ◀
To: Bob Smith      ⚡
6337                03:28:
Hold EndCall More
```

Ending a Call

Press the **EndCall** soft key.

OR

Replace the handset, or press  if in Headset Mode.

Redial

Press **Redial** to dial the last call placed from your phone.

To redial another previously dialed number, press the **Menu** soft key, and select *Features*, *Call Lists*, then *Placed Calls*.

You will see a list of previously placed calls. Choose the number you wish to redial and press **Dial**.

Call Forwarding

Calls may be forwarded to another extension as follows:

1. Press the **Fwd** soft key from the phone's idle display or press **Menu** and select *Features* and *Fwd...* at any time.
2. (Optional) If multiple lines are in use, select which line to forward.
3. Enter a number or URL to forward all future calls to.
4. Press the **Enable** soft key to confirm Call Forwarding.

Idle display returns with a moving arrow on the line label to confirm Call Forwarding enabled.

To turn call forwarding off:

1. Press the **Fwd** soft key from the phone's idle display or press **Menu** and select *Features* and *Fwd...* at any time.
2. (Optional) If multiple lines are in use, **Select** which line to disable Call Forward.
3. Press the **Disable** soft key.

Idle display returns and the line indicator now displays the regular icon.

Call Forwarding is not available on shared lines.

Volume Adjustment

Press the volume keys to adjust receiver volume during a call. Pressing these keys in idle state adjusts the ringer volume.

To conform to regulatory requirements, handset and headset volume will return to a preset level after each call. Hands-free volume settings will be maintained across calls.

Do Not Disturb

Press **Do Not Disturb** to prevent the phone from ringing on incoming calls. A flashing icon and text on the display indicates that Do Not Disturb is on.

Calls received while Do Not Disturb is enabled are logged in the *Missed Call* list.

To turn off Do Not Disturb, press **Do Not Disturb** again.

(Optional) If multiple lines are in use, Do Not Disturb can be set on a line-by-line basis. Contact your system administrator for further details. When Do Not Disturb is enabled for a particular line, this is indicated by a flashing “X” beside the line indicator on the display.

Time and Date

Time and Date is clearly displayed on the SoundPoint® IP 300/301 SIP phone. If the phone cannot obtain a time and date from the server, the display will flash. Contact your system administrator if either time or date is incorrect. You have control over the format of the display and can turn it off. Select options which are right for you as follows:

1. Press **Menu**.
2. Select *Settings* followed by *Basic, Preferences, Time & Date*;
3. Select from *Date Format, Time Format, Clock Order* or *Enable/Disable*.
4. Scroll through the options via the up and down arrow keys.
5. Press **Select** to confirm and **Menu** to return directly to the idle display.

Headset Memory Mode

As an option, the headset can be permanently enabled. This is especially useful for regular headset users.

To do this:



1. Press **Menu**.
2. Select *Settings* followed by *Basic, Preferences, Headset Memory*.
3. Use the up or down arrows and **Select** soft key to enable Headset Memory Mode.
4. Press **Menu** to return directly to the main menu.

Subsequent calls to or from this phone using the headset will activate a flashing headset icon on the display. Pressing the line keys or **Answer** soft key to receive a call will now connect to the user's headset automatically.

Repeat steps 1-3 and select **Disable** to turn Headset Memory Mode off.

Display Contrast



To adjust the contrast on the display to a comfortable level:

1. Press . Select *Settings* followed by *Basic, Contrast*.
2. Press the **Up** or **Down** soft keys (or volume keys) to increase or decrease the display contrast.
3. Press the **Ok** or **Cancel** soft keys to accept or cancel changes.
4. Press  or the **Exit** soft key to return to the idle display.

Ring Type

Many ring types are available. You can select different rings to distinguish between lines or to have a different ring from your neighbor's phone.

To change the incoming ring:

1. Press . Select *Settings* followed by *Basic, Ring Type*.
2. (Optional) If multiple lines are used, first select which line to change.
3. Using the arrow keys, highlight the desired ring type. Press the **Play** soft key to hear the selected ring type.
4. Press **Select** to change to the selected ring type.
5. Press  or the **Exit** soft key to return to the idle display.

See also **Distinctive Ringing / Call Treatment**.

If "Silent Ring" is selected, incoming calls can only be answered by pressing the Answer soft key.

Call Lists

A local list of calls missed, received, and placed is maintained by the phone (up to 100 for each).

Press . Select *Features* followed by *Call Lists*. Select *Missed, Received, or Placed Calls* as desired. Call information will be displayed.

Choose:

1. **Edit** to amend the dial string if necessary.
2. **Dial** to return the call.
3. **Exit** to return to the previous menu.
4. **Info** to view information about the call.
5. **Save** to store the contact to the Contact Directory.
6. **Clear** to delete the call from the list.

Press the **Exit** soft key to return to the idle display.



To quickly view the Missed Calls list from the idle display press .

Contact List

In addition to a directory of missed, placed, or received calls, the phone can store a local directory of 200 or more contacts*. You can add, delete, edit, dial, or search for any contact in this list through just a few key strokes.

**Limit depends on Server configuration. Contact your system administrator for full details.*

To add or edit a contact:

1. Press , select *Features* and *Contact List*.
2. Press **Add** to enter another contact into the phone's database or press **Edit** to edit an existing entry.
3. To move between fields when editing, use the **Next** or **Prev** soft keys. Enter first and/or last name from the keypad. Press the **1/A/a** soft key to select between numeric and upper/lower case alphanumeric modes.
4. Enter the Contact number. This is a required field and it must be unique (not already in the directory).
5. Speed Dial Index, Ring Type and Divert Contact may be left blank.
6. Use  and  or the **Change** soft key to switch between Enabled and Disabled settings for the last four fields.
7. Press **Save** to confirm or **Cancel** to abandon the changes, then press **Exit** to return to the idle display.

*Contacts can be easily added from Call Lists. See **Call Lists** for more information.*



To search for a particular contact:

1. Press **Search** from the *Contact List* menu.
2. Using the dial pad, enter the first few characters for First or Last names.
3. Press **Search** to search for contacts.
4. Successful matches can be dialed from the resulting screen.

Speed Dial

Pre-assigned numbers can be associated with speed dial entries for rapid automated dialing. Speed Dial entries are consecutively placed next to assigned line keys on the phone. When a new entry is added to the Contact List, it is automatically assigned the next available speed dial index.

To change a Speed Dial assignment:

1. Press , select *Features* and *Contact List*. Scroll to the desired entry and press **Edit**,
 - ▶ OR press and hold the line key which already has a speed dial number assigned to it. That contact in the list will automatically be displayed.
2. Delete the Speed Dial Index number using the  and then the **Delete** soft keys.
3. If desired, enter a new speed dial index.
4. Press **Save** and **Exit** to return to the idle display.

Idle display could now be as shown:

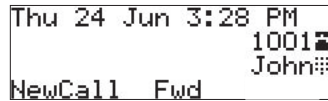

```
Thu 24 Jun 3:28 PM
                1001
                John
NewCall Fwd
```

To quickly view the list of speed dial entries, press  from the idle display.

Multiple Lines

Your SoundPoint® IP 300/301 SIP can support up to two lines, each associated with its own line key. Lines can be configured for private or shared lines.

Typically, the top-most line key is reserved for the principal directory number of the phone. Depending on how your phone is configured, the display could resemble one of the screens shown:

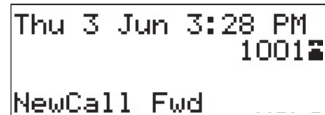

```
Thu 3 Jun 3:28 PM
                1001
                John
NewCall Fwd
```

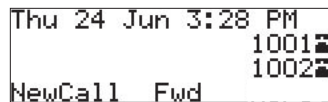

```
Thu 24 Jun 3:28 PM
                1001
                1002
                John
NewCall Fwd
```

Multiple Keys Per Line

A line on the phone can be configured to have two line keys associated with it. If this is the case, the display could look something like this:

Incoming calls to this line will be distributed evenly among the two available keys. Similarly, outgoing calls will be distributed.

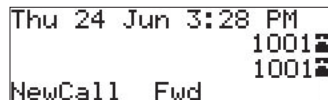

```
Thu 24 Jun 3:28 PM
                1001
                1002
                John
NewCall Fwd
```

Multiple Call Appearances

Each line on the phone can be configured to have one or more call appearances. More than one call appearance is useful if there is an active call and an incoming call arrives on the same line. In the example shown, there is an outbound call with Bob Smith. The second figure shows an incoming call from Jim Green. To answer this incoming call, put the original call on Hold or press the  key to access the new call. Soft key labels will be updated on the display with these options:

1. **Answer** this incoming call.
2. **Reject** the second incoming call.
3. **Forwrd** the incoming call to another extension.

Answering the incoming call places the original on Hold and refreshes the soft key labels as indicated (last figure).

If more than one call appearance is in use, one will appear on the display and the total number will be indicated by a counter at the top right corner of the display. For example, “2/3” indicates that the call on the display is the second one out of a total of three.

A user can also place another outbound call on the same first line. Press **Hold** during the first call and press **NewCall** to obtain dial tone for a second call.

```
Mon, Nov 22 2:23PM 1/2
To: Bob Smith
6337 03:28
Hold EndCall
```

```
From: Jim Green 1/2
To: Bob Smith
6337 04:02
Hold EndCall
```

```
Mon, Nov 22 2:23P 1/2
From: Jim Green
2337 :35
Hold EndCall
```

Shared Lines

The phone supports shared lines*. If two phones share a line, an incoming call to that number will cause both phones to ring. The call can be answered on either phone but not both.

The shared line icon changes to a moving icon when the line is in use remotely.

Calls on shared lines can be transferred, put on hold, or added to a conference.

**Shared lines are an optional feature configured on the server and may not be supported on your particular system. Contact your system administrator to find out.*

Voice Mail

Received messages will be indicated by a flashing Message Waiting Indicator LED on the front of the phone and optionally a visual notification on the display.

Individual line indicators reflect voice messages left on that line (useful if multiple lines are in use).

To listen to voice messages:

1. Press  and select *Features, Messages*^{*,†}.
2. (Optional) If multiple lines are in use, select from which line messages are to be retrieved.
3. Display indicates number of messages and their importance. Press

A stutter dial tone in place of normal dial tone is used to indicate that one or more voice messages are waiting at the message center.

Connect to initiate retrieval from the Message Center,

OR

Press **Clear** to turn off the flashing LED without listening to messages.

4. Follow voice prompts to listen to messages.



^{*}Voice Mail is an optional feature configured on the server and may not be supported on your particular system. Contact your system administrator to find out.

[†]Screen options may vary with server-based application. Voice Mail can be accessed with a single key press. Contact your system administrator to configure this option.

Distinctive Ringing / Call Treatment

You can set distinctive incoming ringing tones for contacts in their local directory. This allows identification of a contact by a specific ring tone.

To set a distinctive ring for a local contact:

1. Press , select *Features, Contact List*.
2. Using the arrow keys, scroll through the directory to choose a contact.
3. Press **Edit** and scroll down using the **Next** soft key to *Ring Type*.
4. Enter a number corresponding to one of the ring types available (press ) then the **Delete** soft

5. Press the **Save** soft key or **Cancel** to abandon the change.

Incoming calls from this contact will now have the distinctive ringing pattern applied.

See **Ring Type** in this guide for further details.

This feature is local to the phone, and may be over-ridden by server settings. Contact your system administrator for more

Phone Reboot

Periodically, the phone may require a user reboot. Reasons for this include accepting a new configuration or new software.

There are two ways to reboot the phone:

- ▶ Simultaneously press and hold the Do Not Disturb, Hold, and Volume keys (highlighted in the figure) for more than 3 seconds
- ▶ Press **Menu** and select *Settings, Advanced, Restart Phone* (the user password is required to access this menu).

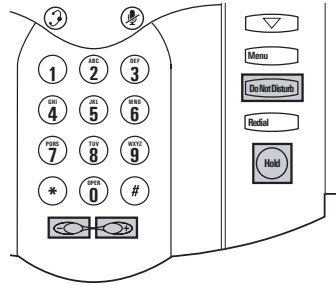

The reboot process will begin and is complete when the idle display is shown.

In the case of problems, it may be possible to restore normal operation of your phone without rebooting. Contact your system administrator before attempting to reboot the phone.

Optional Features

Text Messaging

You can send and receive Text messages on your phone. SIP Instant (Text) Messaging is supported in real-time. Received messages will be indicated by a flashing Message Waiting Indicator LED on the

front of the phone and optionally a visual notification on the display.

To read text messages:

1. Press **Menu** and select *Features, Messages, Instant Messages*,
OR
Press the **InstMsg** soft key to read a message just received.
2. (Optional) If multiple lines are in use, select from which line messages are to be retrieved.
3. Messages appear first to last in sent order.
4. Press the **Next** or **Prev** soft keys to cycle through messages in order.

To send a text message:

1. Press **Menu** and select *Features, Messages, Instant Messages*.
2. (Optional) If multiple lines are in use, first select from which line to send the message.
3. Press the **New** soft key.
4. Enter the desired extension or SIP URL. Press the **1/A/a** soft key to alternate between numeric and upper/lower case alphanumeric modes.
5. Press the **Select** soft key to choose from various pre-scripted short messages.
OR
Press **Edit** to compose a custom message. Use dial pad keys to cycle through the character set. Use keys 1, *, 0, and # to select special characters.
6. Press **Send** when finished.

Presence / Status / Buddy Lists

The phone combines interactive message services and status monitoring to complement a traditional messaging application such as email.

Live interaction within a pool of phones is possible by monitoring the “presence” of the parties involved.

Each phone can “watch” the status of up to eight other phones. These other phones form the “Buddy List”. The status of buddies is displayed and updated in real time. Each phone can also be “watched” by up to eight other phones.

To add or delete a contact from your buddy list, or block a contact:

1. Press **Menu**, select *Features, Contact List*.
2. Using the arrow keys, scroll through the directory to choose a contact.
3. Press **Edit** and scroll down using the **Next** soft key to the *Watch Buddy* or *Block Buddy* fields.
4. Use the arrow keys or the **Change** soft key to switch between Enabled or Disabled status.
5. Press the **Save** soft key or **Cancel** to abandon the change.

The figures show a typical Buddy Status screen display of monitored phones and a My Status display.



```
<My Status>
1.☑Online
2.☐Busy
Exit Select
```

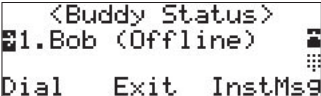

```
<Buddy Status>
☑1.Bob (Offline)
Dial Exit InstMsg
```

To view and change Presence settings:

1. Press  and select *Features* and *Presence*.
2. Choose *My Status* to change your own status.
3. Choose *Buddy Status* to monitor the status of the contacts within your buddy list.
4. Choose *Privacy List* to see which phones are allowed to “watch” your phone and which phones are blocked from “watching” your phone.

Your phone can be configured to work with Microsoft® Office Live Communications Server and communicate with others using Microsoft® Office Communicator and Windows Messenger. Contact your system administrator to find out.

To add a contact in the buddy list:

1. Press the **Buddies** soft key on the idle display to get to the **Buddy Status** screen or press  and select *Features*, *Presence*, *Buddy Status*.
2. Press **More**.
3. Press **Add**.
4. Enter the number of the buddy, for example, 7778.
5. Press **Submit**.

If the buddy is added successfully, you are able to scroll to it on the **Buddy Status** screen.

Any contacts added through the buddy list will appear in as a contact in Microsoft® Office Communicator and Windows Messenger.

Troubleshooting

No Dial-Tone

Verify power is correctly applied to the SoundPoint® IP 300/301 SIP phone:

- Check that the display is illuminated.
- Make sure the LAN cable is inserted properly at the rear of the phone (try unplugging and re-inserting the cable).
- If using in-line powering, check that the switch is supplying power to the phone (contact your system administrator).

Verify if dial tone is present on any other audio paths:

- Switch between handset, headset (if present) or hands-free to see if dial tone is present on these other paths.
- If dial tone exists on one of these, connect a different handset or headset to isolate the problem.

No Display, Incorrect Display or Bad Contrast

Verify power is correctly applied to the SoundPoint® IP 300/301 SIP phone:

- As “No Dial-Tone” above.

Verify contrast adjustment:

- Follow the instructions in this User Guide to adjust the contrast to a darker level.
- Reboot the phone to obtain a default level of contrast (follow the instructions in this User Guide).

Verify successful outbound or inbound calling:

- Place a call to the phone under investigation. Check that the display indicates incoming call information.
- Lift the handset. Ensure dial tone is present and place a call to another extension or number. Check that the display changes in response.

No Ringing

Verify incoming ring setting and volume level:

- Adjust the ringing level from the front panel using the volume up/down keys.
- Check that the Ring Type selected in the Settings menu is not the Silent Ring.

Verify successful outbound or inbound calling:

- As “No Display” above.

No Audio on Headset

Verify correct connections:

- Ensure the headset is plugged into the jack marked **Headset** at the rear of the phone.
- Ensure the headset amplifier (if present) is turned on and/or the volume is correctly adjusted.
- Ensure the headset amplifier (if present) is turned on and/or the volume is correctly adjusted.
- Ensure the headset amplifier (if present) is turned on and/or the volume is correctly adjusted.

No Response from Feature Key Presses

Verify phone is in active state:

- Make a call to the phone to check for inbound call display and ringing as normal. If successful, try to press feature keys within the call to access Directory or Buddy Status for example.
- Press  followed by *Status* and *Lines* to confirm line is actively registered to the server.
- Reboot the phone to attempt re-registration to the server.

Display shows “Network Link is Down”

Verify LAN cable is properly connected:

- Check termination at the switch or hub (furthest end of the cable from the phone).
- Check that the switch or hub is operational (flashing link/status lights) or contact your system administrator.
- Press  followed by *Status* and *Network*. Scroll down to verify LAN port is Active.
- Reboot the phone to attempt re-registration with the server.

Safety and Compliance

Part 15 Rules

This device is compliant with Part 15 of the FCC Rules. Operation is subject to the following two conditions:

1. This device may not cause harmful interference, and

2. This device must accept any interferences received, including interference that may cause undesired operation.

Class B Digital Device or Peripheral

Note: This equipment is tested and complies with the limits for a Class B digital device, pursuant to Part 15 of the FCC Rules. These limits are designed to provide reasonable protection against harmful interference in a residential installation.

This equipment generates, uses, and can radiate radio frequency energy and, if not installed and used in accordance with the instructions, may cause harmful interference to radio communications. However, there is no guarantee that interference will not occur in a particular installation. If this equipment does cause harmful interference to radio or television reception, which can be determined by turning the equipment off

and on, the user is encouraged to try to correct the interference by one or more of the following measures:

1. Reorient or relocate the receiving antenna.
2. Increase the separation between the equipment and receiver.
3. Connect the equipment into an outlet on a circuit different from that to which the receiver is connected.
4. Consult the dealer or an experience radio/TV technician for help.

Modifications

In accordance with Part 15 of the FCC Rules, the user is cautioned that any changes or modifications not expressly approved

by Polycom, Inc. could void the user's authority to operate the equipment.

Installation Instructions

Installation must be performed in accordance with all relevant national wiring rules.

L'Installation doit être exécutée conformément à tous les règlements nationaux applicable au filage électrique.

Plugs Acts as Disconnect Device

The socket outlet to which this apparatus is connected must be installed near the equipment and must always be readily accessible.

La prise électrique à laquelle l'appareil est branché doit être installée près de l'équipement et doit toujours être facilement accessible.

Industry Canada (IC)

This Class [B] digital apparatus complies with Canadian ICES-003.

Cet appareil numérique de la classe [B] est conforme à la norme NMB-003 du Canada.

CE and VCCI Mark

This SoundPoint® IP 300/301 SIP is marked with the CE mark. This mark indicates compliance with EEC directories 89/336/EEC and 73/23/EEC.

A full copy of the Declaration of Conformity can be obtained from Polycom Ltd., 270 Bath Road, Slough, Berkshire, SL1 4DX, UK.

この装置は、情報処理装置等電波障害自主規制協議会（VCCI）の基準に基づくクラスB情報技術装置です。この装置は、家庭環境で使用することを目的としていますが、この装置がラジオやテレビジョン受信機に近接して使用されると、受信障害を引き起こすことがあります。

取扱説明書に従って正しい取り扱いをして下さい。

Polycom Limited Warranty and Limitation Liability

LIMITED WARRANTY. Polycom warrants to the end user (“Customer”) that this product is expected to be free from defects in workmanship and materials, under normal use and service, for one year from the date of purchase from Polycom or its authorized reseller.

Polycom’s sole obligation under this express warranty is at Polycom’s option and expense, to repair the defective product or part, deliver to Customer an equivalent product or part to replace the defective item, or if neither of the two foregoing options are reasonably available, Polycom may, on its sole discretion, refund to Customer the purchase price paid for the defective product. All products that are replaced will become the property of Polycom. Replacement products or parts may be new or reconditioned.

Polycom is expected to warrant any replaced or repaired product or part for ninety (90) days from shipment, or the remainder of the initial warranty period, whichever is longer.

Products returned to Polycom must be sent prepaid and packaged appropriately for safe shipment, and it is recommended that they be insured or sent by a method that provides for tracking of the package. Responsibility for loss or damage does not transfer to Polycom until the returned item is received by Polycom. The repaired or replaced item will be shipped to Customer, at Polycom’s expense, not later than thirty (30) days after Polycom receives the defective product, and Polycom will retain risk of loss or damage until the item is delivered to Customer.

Exclusions

Polycom will not be liable under this limited warranty if its testing and examination disclose that the alleged defect or malfunction in the product does not exist or results from:

- Failure to follow Polycom's installation, operation, or maintenance instructions.
- Unauthorized product modification or alteration.
- Unauthorized use of common carrier communication services accessed through the product.
- Abuse, misuse, negligent acts or omissions of Customer and persons under Customer's control; or
- Acts of third parties, acts of God, accident, fire, lightening, power surges or outages, or other hazards.

Warranty Exclusive

IF A POLYCOM PRODUCT DOES NOT OPERATE AS WARRANTED ABOVE, CUSTOMER'S SOLE REMEDY FOR BREACH OF THAT WARRANTY SHALL BE REPAIR, REPLACEMENT, OR REFUND OF THE PURCHASE PRICE PAID, AT POLYCOM'S OPTION. TO THE FULL EXTENT ALLOWED BY LAW, THE FOREGOING WARRANTIES AND REMEDIES ARE EXCLUSIVE AND ARE IN LIEU OF ALL OTHER WARRANTIES, TERMS, OR CONDITIONS, EXPRESS OR IMPLIED, EITHER IN FACT OR BY OPERATION OF LAW, STATUTORY OR OTHERWISE,

INCLUDING WARRANTIES, TERMS, OR CONDITIONS OF MERCHANTABILITY, FITNESS FOR A PARTICULAR PURPOSE, SATISFACTORY QUALITY, CORRESPONDENCE WITH DESCRIPTION, AND NON-INFRINGEMENT, ALL OF WHICH ARE EXPRESSLY DISCLAIMED. POLYCOM NEITHER ASSUMES NOR AUTHORIZES ANY OTHER PERSON TO ASSUME FOR IT ANY OTHER LIABILITY IN CONNECTION WITH THE SALE, INSTALLATION, MAINTENANCE OR USE OF ITS PRODUCTS.

Service Agreements

Please contact your Polycom Authorized Reseller for information about service

agreements applicable to your product.

Limitations of Liability

LIMITATION OF LIABILITY. TO THE FULL EXTENT ALLOWED BY LAW, POLYCOM EXCLUDES FOR ITSELF AND ITS SUPPLIERS ANY LIABILITY, WHETHER BASED IN CONTRACT OR TORT (INCLUDING NEGLIGENCE), FOR INCIDENTAL, CONSEQUENTIAL, INDIRECT, SPECIAL, OR PUNITIVE DAMAGES OF ANY KIND,

OR FOR LOSS OF REVENUE OR PROFITS, LOSS OF BUSINESS, LOSS OF INFORMATION OR DATA, OR OTHER FINANCIAL LOSS ARISING OUT OF OR IN CONNECTION WITH THE SALE, INSTALLATION, MAINTENANCE, USE, PERFORMANCE, FAILURE, OR INTERRUPTION OF ITS PRODUCTS, EVEN IF POLYCOM

OR ITS AUTHORIZED RESELLER HAS BEEN ADVISED OF THE POSSIBILITY OF SUCH DAMAGES, AND LIMITS ITS LIABILITY TO REPAIR, REPLACEMENT, OR REFUND OF THE PURCHASE PRICE PAID, AT POLY-

COM'S OPTION. THIS DISCLAIMER OF LIABILITY FOR DAMAGES WILL NOT BE AFFECTED IF ANY REMEDY PROVIDED HEREIN SHALL FAIL OF ITS ESSENTIAL PURPOSE.

Disclaimer

Some countries, states, or provinces do not allow the exclusion or limitation of implied warranties or the limitation of incidental or consequential damages for certain products supplied to consumers, or the limitation of liability for personal injury, so the above limitations and exclu-

sions may be limited in their application to you. When the implied warranties are not allowed to be excluded in their entirety, they will be limited to the duration of the applicable written warranty. This warranty gives you specific legal rights which may vary depending on local law.

Governing Law

This Limited Warranty and Limitation of Liability shall be governed by the laws of the State of California, U.S.A., and by the laws of the United States, excluding their conflicts of laws principles. The United Nations Convention on Contracts for the International Sale of Goods is hereby excluded in its entirety from application to this Limited Warranty and Limitation of Liability.

All rights reserved under International and Pan-American Copyright Conventions. No part of the contents of this manual may

be copied, reproduced, or transmitted in any form or by any means, or translated into another language or format, in whole or part, without written consent from Polycom, Inc.

Do not remove (or allow anybody else to remove) any product identification, copyright or other notices.

Polycom, the Polycom logo design, and SoundPoint are trademarks of Polycom, Inc. in the U.S. and various other countries.

Copyright Notice

Portions of the software contained in this product are Copyright (c) 1998, 1999, 2000 Thai Open Source Software Center Ltd. and Clark Cooper.

Permission is hereby granted, free of charge, to any person obtaining a copy of this software and associated documentation files (the "Software"), to deal in the Software without restriction, including without limitation the rights to use, copy, modify, merge, publish, distribute, sublicense, and/or sell copies of the Software,

and to permit persons to whom the Software is furnished to do so, subject to the following conditions:

The above copyright notice and this permission notice shall be included in all copies or substantial portions of the Software.

THE SOFTWARE IS PROVIDED "AS IS", WITHOUT WARRANTY OF ANY KIND, EXPRESS OR IMPLIED, INCLUDING BUT NOT LIMITED TO THE WARRANTIES OF MERCHANTABILITY

ITY, FITNESS FOR A PARTICULAR PURPOSE AND NONINFRINGEMENT. IN NO EVENT SHALL THE AUTHORS OR COPYRIGHT HOLDERS BE LIABLE FOR ANY CLAIM, DAMAGES OR OTHER LIABILITY, WHETHER IN

AN ACTION OF CONTRACT, TORT OR OTHERWISE, ARISING FROM, OUT OF OR IN CONNECTION WITH THE SOFTWARE OR THE USE OR OTHER DEALINGS IN THE SOFTWARE.



Polycom, Inc.
1565 Barber Lane
Milpitas, CA 95035

©2006 Polycom, Inc. All Rights Reserved. Polycom®, SoundPoint®, and the Polycom logo design are registered trademarks of Polycom, Inc. in the U.S. and various countries. All other trademarks are the property of their respective companies.

1725-11329-001 Rev. B