

Enterprise IP Solutions

OfficeServ IP Phone User Guide

ITP-5021D / ITP-5014D





SAFETY CONCERNS

For product safety and correct operation, the following information must be given to the operator/user and shall be read before the installation and operation.

Conventions

 WARNING	WARNING Provides information or instructions that you should follow in order to avoid personal injury or fatality.
--	--

 CAUTION	CAUTION Provides information or instructions that you should follow in order to avoid a service failure or damage to your phone.
--	--

 NOTE	NOTE Indicates additional information for reference.
---	--

Symbols

 Caution	Indication of a general caution
--	---------------------------------

 Restriction	Indication for prohibiting an action for a product
--	--

 Instruction	Indication for commanding a specifically required action
--	--



WARNING

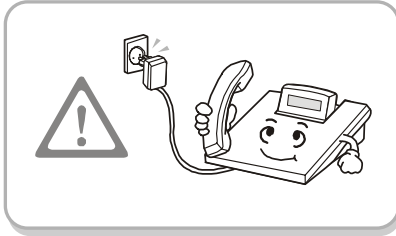

The ITP-5021D/5014D IP phone shall be connected to the local AC power using the power adaptor provided with the IP phone.

Use of an alternative adaptor may result in serious damage and voids the product warranty.

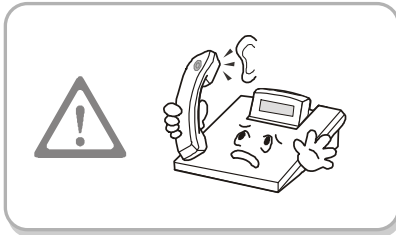

The handset receiver on the digital phone may retain metallic objects. Care should be taken when using the handset in the vicinity of small metal objects.



Avoid placing objects containing water such as vases, cups, cosmetics, and medicines near the phone.

Moisture in the IP phone may cause a fire and electric shocks.



Do not place the phone in a dusty area or areas with extreme or volatile changes in temperature.

It may cause a fire or electric shocks.



Do not install the phone near a heater or flames(cigarette lighter, heating apparatus, etc.).

It may cause a fire or electric shocks.

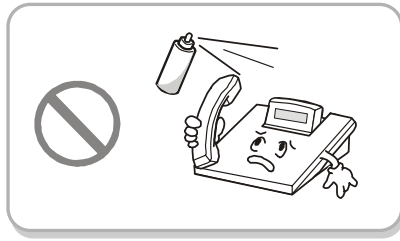

Do not use flammable solvent or materials near the phone. Do not store them near the phone.

It may cause a fire or electric shocks.



If the phone makes excessive noise, emits an odour, or smoke, immediately unplug the phone and call your Authorised Samsung Reseller.

 **CAUTION**

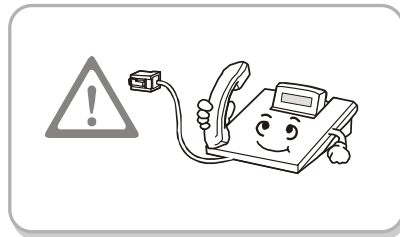

Be careful not to connect the network LAN cable to the PC connection port.

If the LAN cable connected to network is connected to the PC connection port, both telephone and PC communications will be disabled.

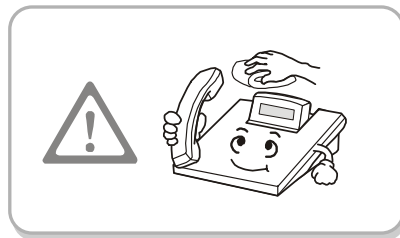

Use a soft dry cloth to clean the phone. Do not use any chemical solvents like wax, benzene, alcohol, thinner, aerosols, lubricant, or detergent.

The use of chemicals on the phone may cause fading/discoloring or damage to the parts.

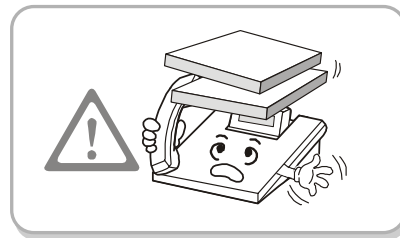

Do not place heavy things on the phone.

It may cause damage to some parts.

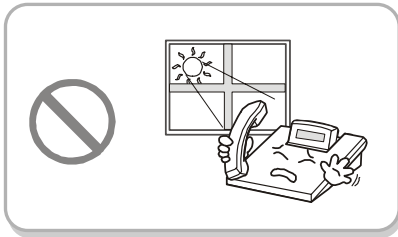

Do not install the phone on an unstable surface or in direct sunlight.

It may cause severe damage to the plastic case of the phone, and reduced the performance of your digital phone.



Do not separate, repair or remodel the phone arbitrarily.

If a repair is needed, please contact your Authorised Samsung Reseller.

TABLE OF CONTENTS

SAFETY CONCERNS

Conventions	2
Symbols	2
Warning	3
Caution	4

PREPARATION

Main Features	8
Front View of the Phone.....	10
Connecting Lines to the Phone	10

THINGS YOU SHOULD KNOW

Volume Adjustment	13
Entering Characters	15
Telephone Status Indicator	17
Button LED.....	18

USING THE FEATURES

Making a Call	19
Answering a Call	24
Features Used During a Call.....	26

APPLICATION MENUS

Navigation Buttons	30
Entering Application Menus.....	33

ANNEX

Troubleshooting	35
Product Specifications.....	38

PREPARATION

Main Features

IP Network

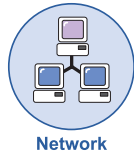

The ITP-5021D/5014D IP phone provides voice communication through the previously installed data network line, making installation of additional telephone lines unnecessary.

Application menu

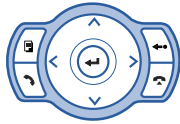

This button allows you to access the IP phone's menu functions. The menu functions include the recent outgoing call log, incoming call log, system directory functions, transferring incoming calls, inquiry of speed dial numbers, and alarm function.

Speed Dial



For frequently used phone numbers, you can press one speed dial button to make a call to the speed dial number.

Pickup



You can answer a call at another extension.

Automatic Redial/Retry



When your call is important but your party is busy on another call, you can use automatic redial/retry function. The IP phone redials the called number automatically until your party is free to take your call.

Hold

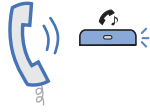

You can use the Hold feature when you need something or another call arrives. Use this button to temporarily hold the current call until you are ready to resume the call. You can even pickup a held call at another station.

Conference Calls



This button is used when multiple parties need to be connected simultaneously during a phone conversation. Up to five parties including you can be connected in a conference call.

Call Forwarding

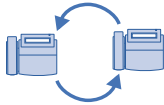

If you cannot answer an incoming call, the call can be forwarded to another extension (unconditionally, while you are busy on a call, or when you are away from your phone).

Do Not Disturb



When you do not want to be disturbed, the DND feature can be set to block incoming calls and the phone will not ring. Your calls can be forwarded to another station when you do not wish to be disturbed.

Paging



If you have an urgent announcement to make, or you wish to locate a colleague, you can page through the speaker of other stations, or through optional external speakers.

Call ID



When there is an incoming call, the caller ID or name will be displayed on the LCD screen. You can see who is calling before answering the call and respond accordingly.

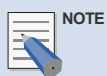

NOTE

- If you have any questions or concerns regarding the features which are not introduced in this user guide, refer to the Technical Manual at e-manual site (<http://www.samsungdocs.com>).

Front View of the Phone

ITP-5021D / ITP-5014D

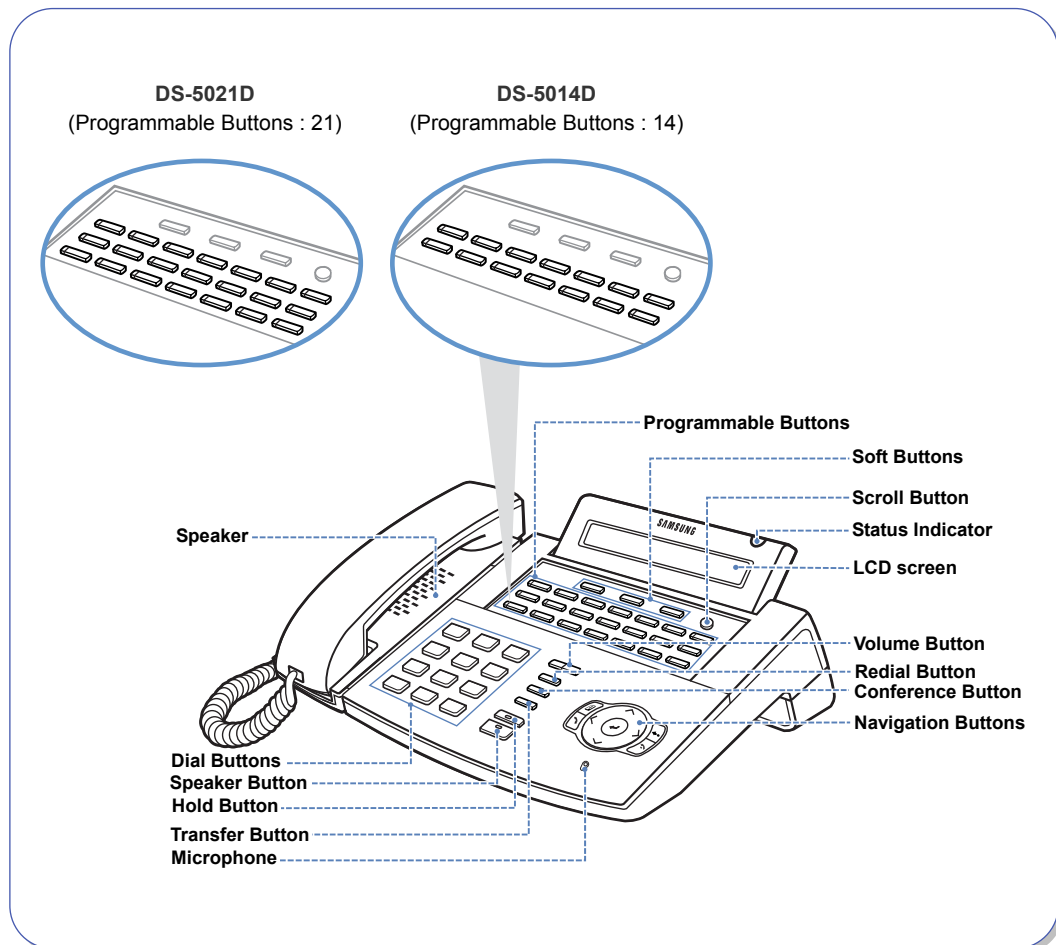

Connecting Lines to the Phone

- 1** Plug the handset cord into the port marked with the symbol.
- 2** Connect the LAN cable connected to your data network to the LAN connection port on the base of the IP phone.
- 3** Connect the LAN cable connected to the PC's network card to the PC connection port on the base of the IP phone.
- 4** Connect the power adaptor. There is a power connection port for the power adaptor on the base of the IP phone. Connect the power adaptor cable to this port. Connect the power adaptor plug to the AC power outlet and the IP phone is automatically booted.

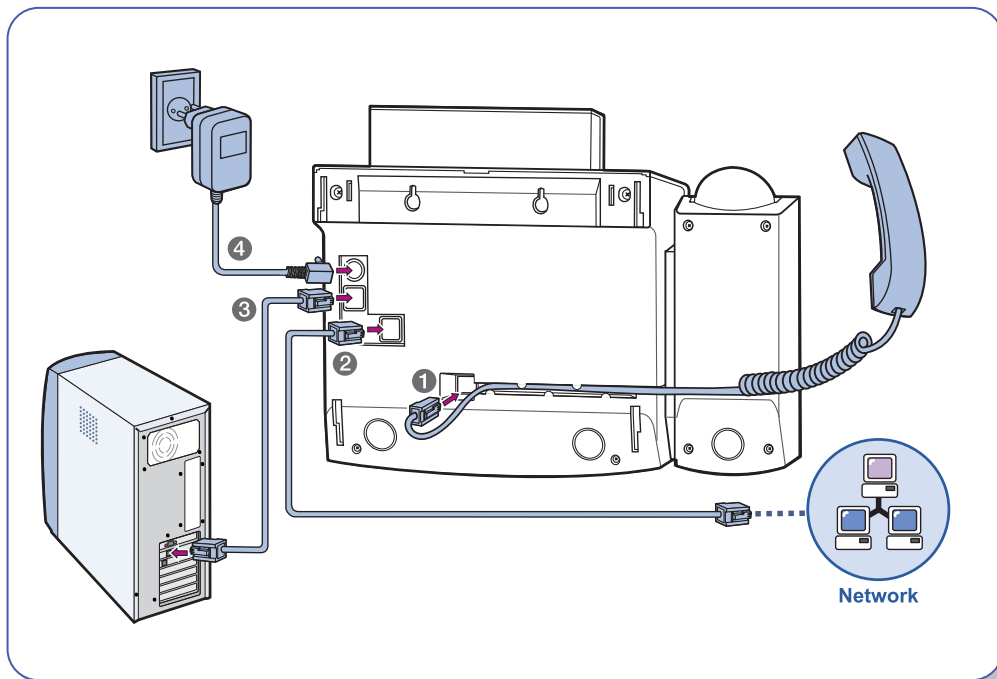

- If you want to use the LAN Jack adaptor, the LAN cable can be connected as follows :

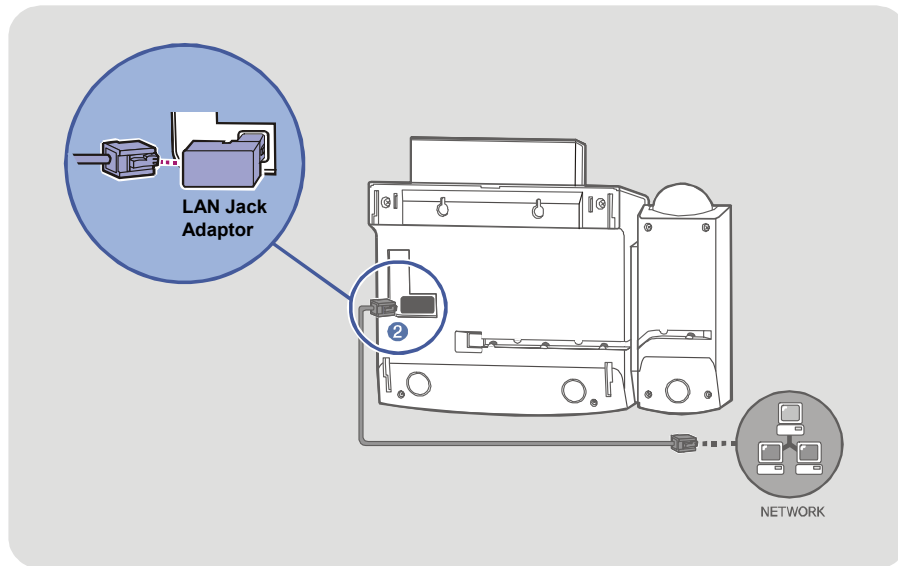

THINGS YOU SHOULD KNOW

Volume Adjustment

The **Volume** [▼ ▲] button is used for adjusting the volume of the handset, speaker, and ringer.

Adjusting Handset Volume



1 During a call using the handset.

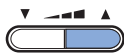

2 Press the [**Volume▲**] button to increase the handset volume.



3 Press the [**▼Volume**] button to decrease the handset volume.

Adjusting Speaker Volume



1 During a call using the **[Speaker]** button.



2 Press the **[Volume▲]** button to increase the speaker volume.



3 Press the **[▼Volume]** button to decrease the speaker volume.

Adjusting Ring Volume



1 To increase the ring volume, press the **[Volume▲]** button while the phone is ringing.



2 To decrease the ring volume, press the **[▼Volume]** button while the phone is ringing.

Entering Characters

Using the dial buttons of this phone, you can easily enter/edit, letters, numbers and special characters.

Special Button Used

To enter letters of the alphabet the following special button is used.
- 'A' Button : Switch to capital/small letters when entering characters.

The 'A' button of the **ITP-5021D/5014D** IP phone is located on the first button of the bottom row of the programmable buttons below the LCD screen.

ITP-5021D

An example for the ITP-5021D is shown.

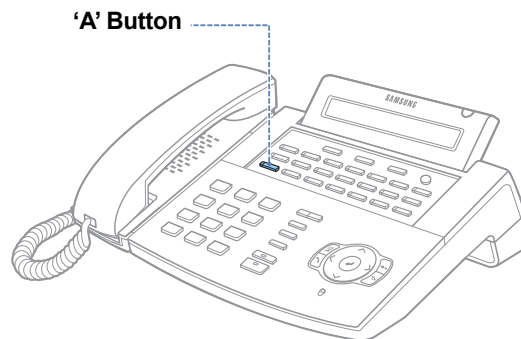

ITP-5014D

An example for the ITP-5014D is shown.

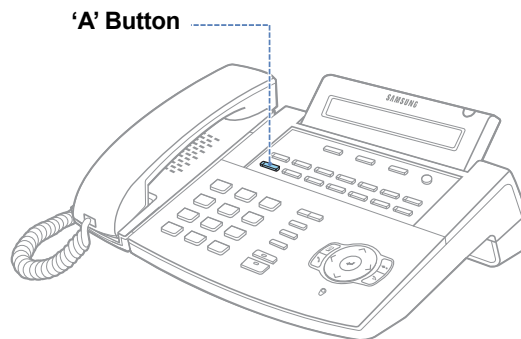

Entering Characters

Press the **Volume** [▼ ▬ ▲] button to move the cursor and insert or modify the desired letter. Press the **Volume** [▼ ▬ ▲] button and move the cursor one space to the right to use the same dial button letters as the previous letter used.

Procedures for entering characters are described below.

Enter the characters according to the table below. Press the 'A' button to switch between capital and lower case letters.

Dial button \ Dial frequency	1	2	3	4	5
0	<	>	.)	0
1	Space	?	,	!	1
2	A	B	C	@	2
3	D	E	F	#	3
4	G	H	I	\$	4
5	J	K	L	%	5
6	M	N	O	^	6
7	P	Q	R	S	7
8	T	U	V	*	8
9	W	X	Y	Z	9
*	:	=	[]	*
#	# ? - [) 	Space . <] _	& , > @ + "	! % / ^ { →	: \$ = (} '

Press the [#] button to enter special characters. Special characters are displayed in the following order.

▶ space ▶ & ▶ ! ▶ : ▶ ? ▶ . ▶ , ▶ % ▶ \$ ▶ - ▶ < ▶ > ▶ / ▶ =
▶ [▶] ▶ @ ▶ ^ ▶ (▶) ▶ _ ▶ + ▶ { ▶ } ▶ | ▶ ; ▶ " ▶ → ▶ ' ▶

Telephone Status Indicator

The status indicator turns on or off according to the telephone status.

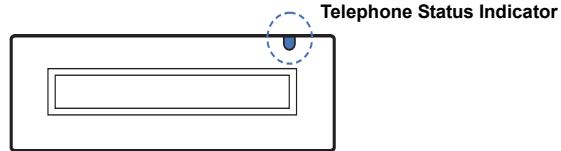

Functions	Status of LCD Indicators
Busy/Off-hook	Steady red
Extension Ring	Flashing red
Trunk Ring	Flashing green
Recalling	Flashing yellow
Message waiting	Flashing red
Calling Denied	Fast flashing red within 1-second interval.

Button LED

The **[Transfer]** button, **[Hold]** button, and **[Speaker]** button have a LED that turns on or off according to the phone status.

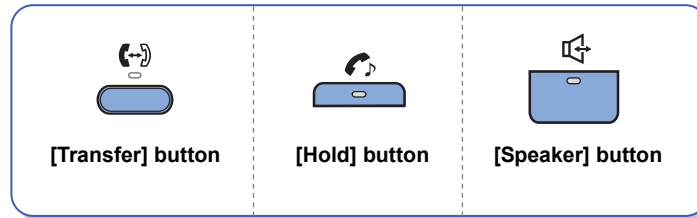

For incoming external calls or intercom calls ringing at your IP Phone the trunk button LED or Call button LED will flash green. The trunk button LED will flash red on other IP Phones with the same trunk button. While holding a call, the green LED of the trunk line will blink. In the following table, the functions of LEDs are summarized.

Functions	Button LED Status
Trunk line or functions are in use	LED is steady green.
New call is ringing	LED is a fast flashing green.
Trunk line or functions are in use	LED is a slow flashing green or red.
New call is ringing	LED is a slow flashing yellow.

USING THE FEATURES

PREPARATION

THINGS YOU SHOULD KNOW

USING THE FEATURES

APPLICATION MENUS

ANNEX

Making a Call

This function is used when you want to make a call to other stations or to make an external call.

Calling an Extension Number

This function is used when you want to make a call to other stations.



- 1** Pick up the handset and check for dial tone.

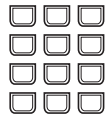

- 2** Dial the extension number or station group number.
Wait until the other party answers the call.
If a short signal tone(not a ringing tone) is heard,
the receiving extension has set up the Voice Announce
or Automatic Answer function.



- 3** Replace the handset or press the **[End]** button
to finish the call.

Calling an Outside number

This function is used when you want to make an external call.



1 Pick up the handset.

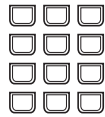

2 Press the trunk or trunk group button or dial the trunk group access code(e.g., 0).

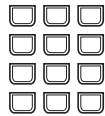

3 Dial the telephone number you want to call.



4 Finish your call by replacing the handset or pressing the **[End]** button.



NOTE

- If the hot keypad feature is used, you can make an external call without picking up a handset by dialling the trunk access code.

Using a Speakerphone

This function is used when you make a call with a speakerphone.



- 1 Press the **[Speaker]** button without lifting the handset.

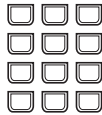

- 2 Dial the telephone number you want to call.
Or, press the trunk line call/extension call button registered.



- 3 Once the called party answers the call, get started with speaking to the called party.

- Lift the handset while speaking to turn off the speaker and continue speaking using the handset.



- 4 Finish the call, by pressing the **[Speaker]** button.



NOTE

- If the LCR(Least Cost Routing) feature is enabled on the OfficeServ system, press the [LCR] button or dial the LCR access code.

New Call

This function allows you to disconnect the existing call and make a new call on the same line.



Press the **[NEW]** button to disconnect your existing



call, wait for dial tone and then make a new call on the same line. If this **[NEW]** button does not appear on your IP Phone, press the Soft button corresponding to **[NEW]** on the LCD screen.

Redial

This function allows you to redial the last external number dialed.

To redial the last telephone number you dialed, press the Send [] button for approximately 2 seconds or press [1] [9]. Pressing the Redial [] button will give you the option to review up to 10 of your previously dialed external numbers.



1 Press the **[Redial]** button.



2 Use the direction buttons or the **[▼Volume▲]** button to select the required number to redial and press the Soft button corresponding to **[Dial]**.



3 To review details about the previous call prior to dialling it, press the Soft button corresponding to **[NND]**.



4 To Press the **[Redial]** button twice to automatically redial the last number you dialed.

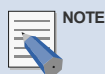

NOTE

- If the hot keypad feature is turned off, you have to lift up the handset first or press the **[Speaker]** button before you begin using the redial feature.
- Redial does not apply to intercom calls.

Save Number with Redial

- 1** To save the number you just dialed for later use,  press the **[SAVE]** button before hanging up.

-  **2** This saved number can be redialled at any time by pressing the **[SNR]** button or dialling [1]▶[7]. The same external trunk line will be selected for you.



NOTE

- The saved telephone number will be saved in memory until you save another number.
- Saved Number Redial does not apply to intercom calls.

PREPARATION

THINGS YOU SHOULD KNOW

USING THE FEATURES

APPLICATION MENUS

ANNEX

Answering a Call

This function is used when you want to answer an intercom call or outside call.

PREPARATION

THINGS YOU SHOULD KNOW

USING THE FEATURES

APPLICATION MENUS

ANNEX

Using a Handset

This function is used when you answer a call with a handset.



1 When the IP Phone rings, pick up the handset or press the [Speaker] button or **[Send]** button.



2 To finish the call replace the handset or press either the **[Speaker]** or [End] button.

Using a Speakerphone

This function is used when you answer a call with a speakerphone.



1 Press the **[Send]** button without lifting the handset.



2 Listen to the speaker to hear a voice of the other party and speak through the microphone.

- You can switch from the speakerphone to the handset by lifting the handset.



3 Finish the call, by pressing the **[Speaker]** button.



NOTE

- Press the [▼Volume▲] button while the phone is ringing to adjust the ringer volume.

Call Pickup

This function is used when you pickup a call that is ringing at another station.
If a call rings on another station and you know the station number, you can answer the call on your IP phone.

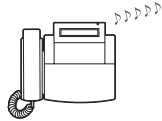

1 A call is ringing on another station.



2 Pick up the handset and listen for the dial tone.



3 Press **[6]** ► **[5]**.

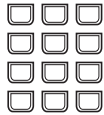

4 Dial the station number that is ringing.

PREPARATION

THINGS YOU SHOULD KNOW

USING THE FEATURES

APPLICATION MENUS

ANNEX

Features Used During a Call

This function is used when you use conveniently during a call.

PREPARATION

THINGS YOU SHOULD KNOW

USING THE FEATURES

APPLICATION MENUS

ANNEX

Hold an Intercom Call

You can put the other party on hold if another intercom call arrives or you wish to use both hands for another task and resume the call later.

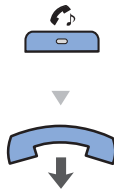

- 1 Press **[Hold]** button and replace the handset to put the current call on hold.

- The intercom call is placed into exclusive hold and cannot be retrieved at another station.

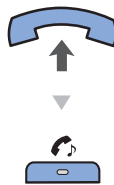

- 2 To call again, pick up the handset, and press the **[Hold]** button.

Hold an Outside Call

You can put the other party on hold if another call arrives or you wish to use both hands for another task and resume the call later.



- 1 While you are engaged in a conversation, press the **[Hold]** button. Then the call on hold will flash green on your phone and the call will flash red on other stations.



- 2 To resume your conversation with the held call, press the button with the flashing green LED.

Mute

During a call you can mute the handset transmitter or microphone while still listening to the other party.



- 1 Press the **[MUTE]** button or the soft button corresponding to **[MUTE]** on the LCD screen. Then, the **[MUTE]** button will turn on red.



- 2 Press the blinking **[MUTE]** button to clear the mute function.

Transferring a Call

While on an outside call you can transfer the call to another internal or outside party.

You can transfer your call to another extension or return to the outside party.



- 1 While on a call, press the **[Transfer]** button.
Your call is automatically put on transfer hold.

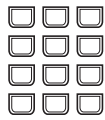

- 2 Dial an extension or group number.
Or, press the [DSS] button or station group button.
Your call will be automatically put on transfer hold.



- 3 For blind transfer, hang up when you hear ringing.
Or, wait for the called party to answer and advise him/her of the call. Then hang up.



NOTE

- When you are transferring a call to a station programmed for Voice Announce or Auto Answer, the transferred call will always ring.
- After the internal party answers, you may alternate back and forth between the parties by pressing the [Transfer] button.
- You cannot transfer an Intercom call by pressing the [DSS] button for the station required. You must press the [Transfer] button first and then press the [DSS] button or dial the destination extension number.

Conference Calls

You can make a conference call of up to 5 parties including yourself. The OfficeServ system also allows each station to pre assign up to 5 conference groups so you can set up a conference call by pressing a single [Group Conference] programmable button. Refer to your System Administrator to confirm that this option is available to you.



- 1 Press the **[Conference]** button while engaged in a conversation. You will hear conference tone.



- 2 Make another call, either intercom or outside. Press the [Conference] button and you will hear conference Tone.



- 3 Make another call to add additional parties or press the **[Conference]** button to join all parties into the conference.
Then, Repeat the last step, until all other parties required are connected.

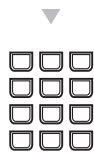

- 4 To drop a person from your conference call, press the **[Conference]** button and dial the extension or trunk number that is to be dropped.



Press the **[Conference]** button again to re-establish the conference.



NOTE

- When attempting to add another person to the conference and you are not able to reach the desired person, simply press the [Conference] button again.

APPLICATION MENUS

PREPARATION

THINGS YOU SHOULD KNOW

USING THE FEATURES

APPLICATION MENUS

ANNEX

Navigation Buttons

The ITP-5021D and ITP-5014D IP Phones are equipped with navigation buttons for convenient use of the IP Phone functions. This chapter introduces the functions available using the navigation buttons and procedures for using the various applications.

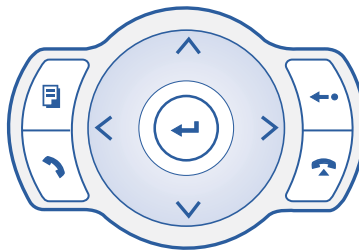

Menu Button

1. OUT CALL LOG
2. IN CALL LOG
3. SPD NO. SEARCH
4. DIRECTORY DIAL
5. FORWARD ASSIGN
6. ALARM ASSIGN

1 The main menu is displayed when the [Menu] button is pressed in the idle state, You can select from the presented options.

1. OUT CALL LOG
2. IN CALL LOG
3. SPD NO. SEARCH
4. DIRECTORY DIAL

2 This menu is displayed when the [Menu] button is pressed when dialling mode or when transferring calls. This allows you select to select and perform a function.

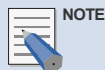

NOTE

- Calls will be maintained even if the [Menu] button is pressed while you are talking. If you press the [End] button or the other buttons except the Navigation buttons in menu mode, you will automatically exit from the menu mode and return to the idle screen.

Send Button

If you press the [Send] button while the [OUT CALL LOG], [IN CALL LOG], [SPD NO. SEARCH], or [DIRECTORY DIAL] function is selected, the corresponding number will be dialled.

- If you press the [Send] button in idle mode, you enter the [OUT CALL LOG] menu.
- If you press the [Send] button in dial mode, you enter the [OUT CALL LOG] menu regardless of the numbers previously dialled.
- If you press the [Send] button while a call is arriving (ringing status), you will answer the call on the speakerphone.

End Button

This button is used to disconnect calls or to exit the IP Phone menus and return to the idle display.

Cancel button

The [Cancel] button is used in menu mode to move to the previous level. If the [Cancel] button is pressed when you first enter menu mode, the menu mode is exited. The [Cancel] button is also used to delete the characters previously entered when entering numbers or characters.

Enter button

This button is used in the menu mode to select or save the item that the cursor is indicating. This button may also be used for the [NND(Name Number Display)] button when receiving calls.

- The [NND] button displays 'caller number', 'caller name', and 'received time' when you press the button, if the caller information is available.

Direction button

These buttons are used when editing menu entries, or when moving between menu items.

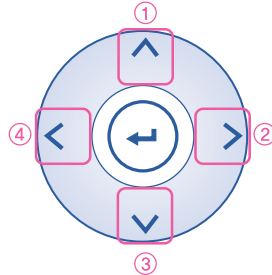

① [^] button is used

Used for moving to the previous menu.

② [>] button is used

In cases where the phone number is long, this button is used for displaying the rear part of the number which is not displayed on the LCD screen.

③ [v] button is used

Used for moving to the next menu.

④ [<] button is used

In cases where the phone number is long, this button is used for displaying the front part of the number which is not displayed on the LCD screen.

Entering Application Menu

When the IP phone is in the standby mode, press the Menu [] button. The main application menu will appear on the LCD screen.

1. OUT CALL LOG
2. IN CALL LOG
3. SPD NO. SEARCH
4. DIRECTORY DIAL
5. FORWARD ASSIGN
6. ALARM ASSIGN

How to Select Menu

To select a menu items, you can use the navigation direction buttons, [▼Volume▲] button or the dial buttons.

- Use the [^]/[v] direction buttons or the [▼Volume▲] button and move to the preferred menu.
- You can select the menu directly by pressing the dial button corresponding to the menu number.
- Press the [Enter] button to select the menu underlined by the cursor to expose sub-menus.
- Press the [End] button to exit the menu and return to the idle screen.
- When buttons other than the navigation buttons are pressed, the menu mode will end.

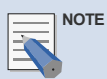
**NOTE**

- When your station is called while in menu mode, your phone will appear as busy to the calling party.

Application Menus

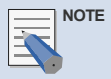
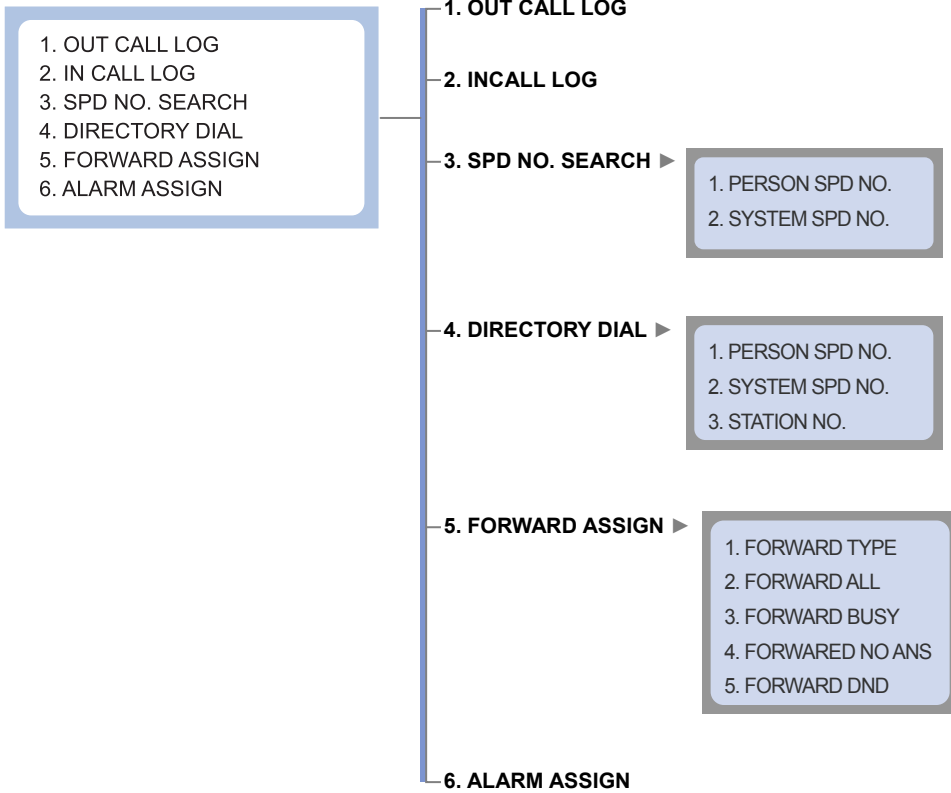

NOTE

- To use the '3. SPD NO. SEARCH' and '5. FORWARD ASSIGN' menu function you should consult your System Administrator.
- If the [Transfer] button is pressed, the available menus are '1. OUT CALL LOG', '2. INCALL LOG', '3. SPD NO. SEARCH', and '4. DIRECTORY DIAL'.

ANNEX

Troubleshooting

Possible problems and troubleshooting steps for your IP phone are described below. Check the troubleshooting steps before contacting your Authorised Samsung Reseller.

? The phone does not boot when the power is connected.

- Check to confirm that the data network cable is connected to the LAN socket on the phone properly.
- Check to confirm that the connected power adaptor is the one supplied with the ITP-5021D/5014D Phone.
- Disconnect the power adaptor from the phone, and connect it again after about 10 seconds.(Refer to 'Connecting Lines to the Phone' section of 'Preparation' in this guide.)

? The phone does function after booting.

- If the screen of the phone displays 'IP conflict', you should consult your IT Manager. This indicates another network device(e.g. PC) is using the same IP address as your phone.
- If the screen of the phone displays 'ID conflict', you should consult your System Administrator. This indicates the user ID for your phone is already in use by another IP phone user.

? Dial tone is not heard when you lift the handset or press the Speaker [] button.

- Check that the data network cable and the data cable to your PC are connected correctly to the LAN and PC sockets respectively.
- Check that the network environment is setup correctly in the phone. (You should consult your System Administrator.)

? Nothing appears on the LCD screen while the ITP-5021D/5014D phone is being used.

Check that the data network cable is correctly connected to the LAN socket on the ITP-5021D/5014D Phone.

(Refer to 'Connecting Lines to the Phone' section of 'Preparation' in this guide.)

? The ITP-5021D/5014D Phone does not ring and volume is too low.

Press the [▼Volume▲] button to adjust the volume.

(Refer to 'Volume Adjustment' section of the 'Things You Should Know' section in this guide.)

? Conversation quality is reduced due to noise and echo.

If you are using the speakerphone, lift the handset and try speaking.

? Excessive echo is emitted during a page announcement or with Auto Answer set.

If IP phones are too close to each other, sound from one speaker might echo during a page or on auto answer call.

Maintain a reasonable distance between IP phones.

? An alarm does not ring at the programmed time.

- Check the current time is set on the ITP-5021D/5014D Phone correctly.
If the current time setting needs to be changed, contact your System Administrator.
- Check if an alarm is set.
(You should consult your System Administrator.)

 **Caller IDs are not displayed on the LCD screen.**

- Confirm with your System Administrator that the caller ID service is available from your telephone company.
- If the caller blocks the sending of their caller ID, the caller ID will not be displayed.
- If the caller makes a call from an area where the caller ID cannot be provided (e.g., international calls), the caller ID will not be displayed.
- If the caller makes a call from a public phone, the caller ID will not be displayed.
- If the caller ID received from the Telephone Company is corrupt, the caller ID will not be displayed.
- If the Telephone Company does not send a caller ID, the caller ID will not be displayed.

Product Specifications

The specifications and features of the ITP-5021D/5014D IP phone are as follows.

Items	Specification	
Model	ITP-5021D	ITP-5014D
Weight(kg)	1.1	1.1
Size(mm)	266(width)×206(length)×119(height)	
Operating Temperature(°C)	0 to 45	
Operating Humidity(%)	10 to 90 non condensing	
Ethernet 10 Base-T/100 Base-Tx	2 Ports(LAN & PC)	
Number ofthe [Programmable] buttons	21	14
Navigation Button	Yes	
Speakerphone	Yes	
LCD	2 Line LCD 24 characters long : English	

PREPARATION

THINGS YOU SHOULD KNOW

USING THE FEATURES

APPLICATION MENUS

ANNEX