

CHICAGO

Electric Power Tools

MULTI-BATTERY CHARGING STATION

Model 92775

OPERATING INSTRUCTIONS

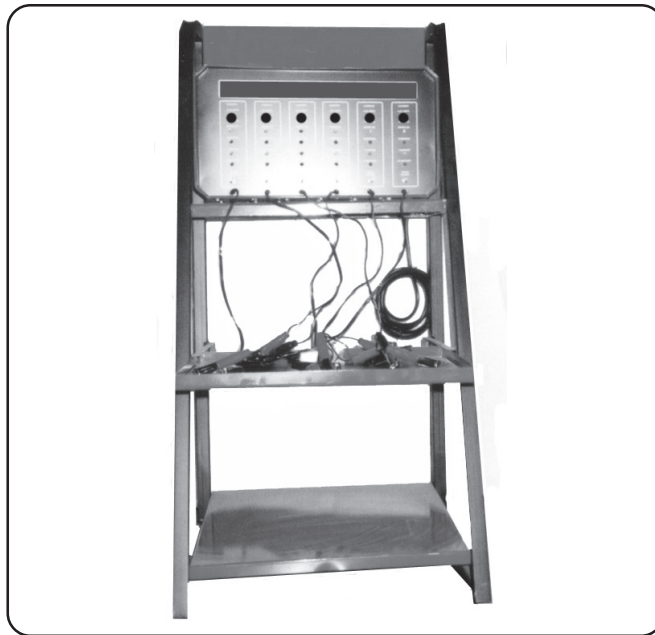

3491 Mission Oaks Blvd., Camarillo, CA 93011
Visit our Web site at: <http://www.harborfreight.com>

**TO PREVENT SERIOUS INJURY,
READ AND UNDERSTAND ALL WARNINGS
AND INSTRUCTIONS BEFORE USE.**

Copyright©2005 by Harbor Freight Tools®. All rights reserved. No portion of this manual or any artwork contained herein may be reproduced in any shape or form without the express written consent of Harbor Freight Tools.

For technical questions or replacement parts, please call 1-800-444-3353.

PRODUCT SPECIFICATIONS

Item	Description
Electrical Requirements	Input Power: 120 VAC / 60 Hz. Power Plug Type: 3 Prong, Polarized. Polarity: Reverse Polarity w/Short Circuit & Overload Protection. Output Power: Can Charge 12 VDC Batteries @ 0.25, 0.50, and 0.90 AMPs.
Charger Clamp Dimensions	2-1/2" Wide x 3-1/4" Long x 5/8" Thick w/17" Cord.
Battery Capacity	Can Charge Up To 6 Batteries At One Time.
Charger Dimensions	11-3/8" Long x 15-1/2" Wide x 8-1/2" High.
Stand Dimensions	18-1/4" Long x 18-1/8" Wide x 37-1/4" High.
Unit Weight	44 Pounds.

NOTE: No replacement parts are available for this product.

UNPACKING

When unpacking, check to make sure all the parts listed and shown on the **Product Features Listing on pages 9 through 11** are included. If any parts are missing or broken, please call Harbor Freight Tools at the number shown on the cover of this manual as soon as possible.

SAVE THIS MANUAL

You will need this manual for the safety warnings and precautions, assembly, operating, inspection, maintenance and cleaning procedures, parts list and assembly diagram. Keep your invoice with this manual. Write the invoice number on the inside of the front cover. Keep this manual and invoice in a safe and dry place for future reference.

GENERAL SAFETY RULES

IMPORTANT SAFETY INSTRUCTIONS



READ AND UNDERSTAND ALL INSTRUCTIONS
Failure to follow all instructions listed in the following pages may result in electric shock, fire, and/or serious injury.

SAVE THESE INSTRUCTIONS

WORK AREA

1. **Keep your work area clean and well lit.** Cluttered benches and dark areas invite accidents.
2. **Do not operate power equipment in explosive atmospheres, such as in the presence of flammable liquids, gases, or dust.** Power equipment creates sparks which may ignite flammables.
3. **Keep bystanders, children, and visitors away while operating power equipment.** Distractions can cause you to lose control. Protect others in the work area.

PERSONAL SAFETY

1. **Stay alert. Watch what you are doing, and use common sense when operating power equipment. Do not use power equipment while tired or under the influence of drugs, alcohol, or medication.** A moment of inattention while operating power equipment may result in serious personal injury.
2. **Dress properly. Do not wear loose clothing or jewelry. Contain long hair. Keep your hair, clothing, and gloves away from moving parts.** Loose clothes, jewelry, or long hair can be caught in moving parts.
3. **Avoid accidental starting. Make sure the Power Switch of the Charger is in its “OFF” position before plugging the Power Cord Plug into an electrical outlet.** Plugging in with the Power Switch “ON” invites accidents.
4. **Do not overreach. Keep proper footing and balance at all times.** Proper footing and balance enables better control of the Charger in unexpected situations.
5. **Use safety equipment. Always wear ANSI approved safety impact eye goggles when using the Charger.**

TOOL USE AND CARE

1. **Do not force the equipment. Use the correct equipment for your application.** The correct equipment will do the job better and safer at the rate for which it is designed. Do not use small equipment, tools, or attachments to do the work of larger industrial equipment, tools, or attachments. Do not use this product for a purpose for which it was not intended.

2. **Do not use the Charger if any of the Control Panel components do not work properly.** Any equipment with a faulty Control Panel is dangerous and must be replaced.
3. **Before making any adjustments, changing accessories, or storing the Charger, make sure all Switches on its Control Panel are in their “OFF” positions.** Such preventive safety measures reduce the risk of starting the equipment accidentally.
4. **Store idle equipment out of reach of children and other untrained persons.** Power equipment is dangerous in the hands of children and untrained users.
5. **Maintain equipment with care.** Do not use damaged equipment. Tag damaged equipment “Do not use” until repaired.
6. **Check for misalignment or binding of moving parts, breakage of parts, and any other condition that may affect the Charger’s operation. If damaged, have the Charger serviced before using.** Many accidents are caused by poorly maintained equipment.
7. **Use only accessories that are recommended by the manufacturer for your model.** Accessories that may be suitable for one Charger may become hazardous when used on another Charger.

SERVICE

1. **Equipment service must be performed only by qualified repair personnel.** Service or maintenance performed by unqualified personnel could result in a risk of injury.
2. **When servicing equipment, use only identical replacement parts. Follow instructions in the “*Inspection, Maintenance, And Cleaning*” section of this manual.** Use of unauthorized parts or failure to follow maintenance instructions may create a risk of electric shock or injury.

SAVE THESE INSTRUCTIONS

GROUNDING

WARNING!

Improperly connecting the grounding wire can result in the risk of electric shock. Check with a qualified electrician if you are in doubt as to whether the outlet is properly grounded. Do not modify the power cord plug provided with the tool. Never remove the grounding prong from the plug. Do not use the tool if the power cord or plug is damaged. If damaged, have it repaired by a service facility before use. If the plug will not fit the outlet, have a proper outlet installed by a qualified electrician.

GROUNDING TOOLS: TOOLS WITH THREE PRONG PLUGS

1. Tools and equipment marked with “Grounding Required” have a three wire cord and three prong grounding plug. The plug must be connected to a properly grounded outlet. If the tool or equipment should electrically malfunction or break down, grounding provides a low resistance path to carry electricity away from the user, reducing the risk of electric shock. **(See Figure A.)**
2. The grounding prong in the plug is connected through the green wire inside the cord to the grounding system in the tool. The green wire in the cord must be the only wire connected to the tool’s grounding system and must never be attached to an electrically “live” terminal. **(See Figure A.)**
3. Your tool must be plugged into an appropriate outlet, properly installed and grounded in accordance with all codes and ordinances. The plug and outlet should look like that in the following illustration. **(See Figure A.)**

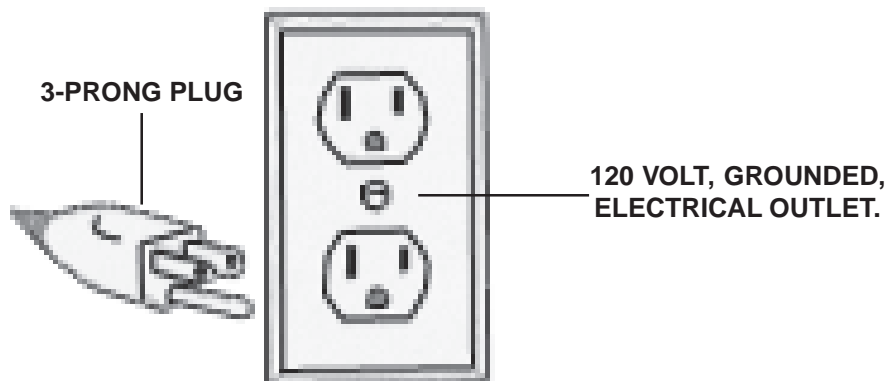

FIGURE A

EXTENSION CORDS

1. ***Grounded*** tools and equipment require a three wire extension cord.
2. As the distance from the supply outlet increases, you must use a heavier gauge extension cord. Using extension cords with inadequately sized wire causes a serious drop in voltage, resulting in loss of power and possible tool and equipment damage. **(See Figure B.)**
3. The smaller the gauge number of the wire, the greater the capacity of the cord. For example, a 14 gauge cord can carry a higher current than a 16 gauge cord. **(See Figure B.)**
4. When using more than one extension cord to make up the total length, make sure each cord contains at least the minimum wire size required. **(See Figure B.)**
5. If you are using one extension cord for more than one tool or equipment, add the nameplate amperes and use the sum to determine the required minimum cord size. **(See Figure B.)**
6. If you are using an extension cord outdoors, make sure it is marked with the suffix "W-A" ("W" in Canada) to indicate it is acceptable for outdoor use.
7. Make sure your extension cord is properly wired and in good electrical condition. Always replace a damaged extension cord or have it repaired by a qualified electrician before using it. Protect your extension cords from sharp objects, excessive heat, and damp or wet areas.

RECOMMENDED MINIMUM WIRE GAUGE FOR EXTENSION CORDS* (120 VOLT)					
NAMEPLATE AMPERES (At Full Load)	EXTENSION CORD LENGTH				
	25 FEET	50 FEET	75 FEET	100 FEET	150 FEET
0-2.0	18	18	18	18	16
2.1-3.4	18	18	18	16	14
3.5-5.0	18	18	16	14	12
5.1-7.0	18	16	14	12	12
7.1-12.0	16	14	12	10	-
12.1-16.0	14	12	10	-	-
16.1-20.0	12	10	-	-	-

*Based on limiting the line voltage drop to five volts at 150% of the rated amperes.

FIGURE B

SYMBOLOLOGY







	Double Insulated
	Canadian Standards Association
	Underwriters Laboratories, Incorporated
V ~	Volts Alternating Current
A	Amperes
no xxxx/min.	No Load Revolutions Per Minute (RPM)

FIGURE C

SPECIFIC SAFETY RULES

1. **Maintain a safe working environment.** Keep the work area well lit. Make sure there is adequate surrounding workspace. Always keep the work area free of obstructions, grease, oil, trash, and other debris. Do not use the Charger in areas near flammable chemicals, dusts, and vapors.
2. **Maintain labels and nameplates on the Charger.** These carry important information. If unreadable or missing, contact Harbor Freight Tools for a replacement.
3. **To avoid electrical shock, never start or run the Charger in the rain.** Never allow water or other liquids to leak inside the body of the Charger.
4. **Do not pull the Charger by its Power Cord or Charger Cables, or pull the Power Cord or Charger Cables around sharp corners or edges.** Keep the Power Cord and Charger Cables away from heated surfaces.
5. **Avoid unintentional starting.** Make sure you are prepared to begin work before turning on any of the Switches on the Control Panel of the Charger.
6. **Do not stand on the Charger.** Standing on the Charger may cause it to tip, causing personal injury and/or product damage.

7. **Never leave the Charger unattended when any of its Switches on the Control Panel are left in their “ON” position.** Make sure all Switches are in their “OFF” position before leaving.
8.  **Make sure to read and understand all instructions and safety precautions as outlined in the manufacturer’s manual for the battery that will be charged.**
9. **Never allow the Red and Black Charger Clamps to touch each other or the same metal object.**
10. **Always connect the Black Charger Clamp of the Charger to the negative (–) terminal on the battery.**
11. **Always connect the Red Charger Clamp of the Charger to the positive (+) terminal on the battery.**
12. **When connecting the Charger Clamps to the terminals on a battery, always connect the Red Charger Clamp first, then connect the Black Charger Clamp.** When disconnecting the Charger Clamps, always disconnect the Black Charger Clamp first, then disconnect the Red Charger Clamp.
13. **Make all Charger Clamp connections before plugging the Charger’s Power Cord Plug into a 120 volt, grounded, electrical outlet and turning on the Power Switch.**
14. **Avoid working alone.** If an accident occurs, an assistant can bring help.
15.  **Always wear clothing and eye protection.** When working on or around lead acid batteries, always wear ANSI approved safety impact eye goggles, work gloves and long sleeve shirt and trousers.
16.  **WARNING!** Lead acid batteries generate hydrogen gas during normal operation, and even more gas is generated when the battery is charging. **Hydrogen gas is explosive, poisonous to breathe, and highly flammable.** To reduce the risk of battery explosion, follow all instructions in this manual and those warnings and instructions published by the battery manufacturer.
17. **Use the Charger in a well ventilated area.** Do not attempt to charge battery around flammable gases or liquids. If necessary, wear an ANSI approved breathing respirator to avoid hydrogen gas fumes.
18. **Use this Charger only with lead acid, rechargeable type batteries.** Remove the battery caps to check liquid level inside battery. If liquid is not present, or if liquid appears to be frozen, do not attempt to charge the battery.
19. **Proper Battery Care:** Battery leakage may occur under extreme usage or temperature conditions. If battery fluid comes in contact with skin, wash with soap

and water and rinse with lemon juice and vinegar. If the fluid comes into contact with the eyes, flush with water for several minutes and contact a doctor immediately. Never burn the battery, as it can explode in a fire. Do not charge a leaking battery. Contact local solid waste authorities for instructions on correct disposal or recycling of old batteries.

20. **Performance of the Charger (if powered by line voltage) may vary depending on variations in local line voltage. Extension cord usage may also affect equipment performance.**

21. **⚠ WARNING!** People with pacemakers should consult their physician(s) before using this product. Electromagnetic fields in close proximity to a heart pacemaker could cause interference or failure of the pacemaker. In addition, people with pacemakers should adhere to the following: Avoid operating power equipment alone. Don't use a power equipment with the power switch(s) locked on. Properly maintain and inspect all power equipment before use to avoid electrical shock.

22. **⚠ WARNING!** The warnings and precautions discussed in this manual cannot cover all possible conditions and situations that may occur. It must be understood by the operator that common sense and caution are factors which cannot be built into this product, but must be supplied by the operator.

SAVE THESE INSTRUCTIONS

CONTROL PANEL FEATURES

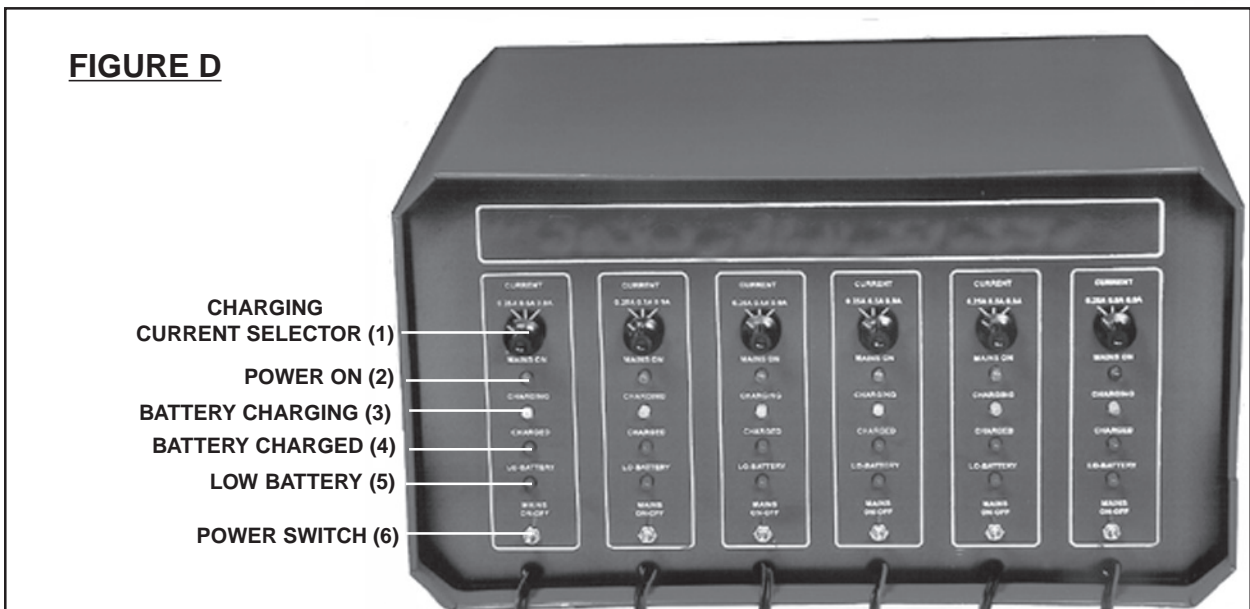

1. **Charging Current Selector (1):** The Charging Current Selector is used for selecting a charging current of either 0.25 AMPs, 0.50 AMPs, or 0.90 AMPs depending upon the 12 volt battery that is to be charged. Use a digital voltmeter (not included) to determine the voltage of the battery. Check the battery manufacturer's recommended charging current. Then, set the Charging Current Selector to the appropriate Amperage. **(See Figure D.)**
2. **Power On (2):** When illuminated, the Power On feature indicates the Battery Charger is on and ready for use. **(See Figure D.)**
3. **Battery Charging (3):** After properly connecting the Charger Clamps to the battery, selecting the correct charging current, and turning on the Battery Charger, the Battery Charging feature will illuminate indicating proper functioning of the Battery Charger. If the Battery Charging feature *does not* illuminate, the voltage of the battery is below 9 volts, and the battery *will not* charge. **(See Figure D.)**
4. **Battery Charged (4):** When illuminated, the Battery Charged feature indicates the battery is fully charged and may then be disconnected from the Battery Charger. **(See Figure D.)**
5. **Low Battery (5):** When illuminated, the Low Battery feature indicates the battery connected *will not* be charged as its voltage is below 9 volts. The battery should be recycled according to local guidelines. **(See Figure D.)**
6. **Power Switch (6):** Always properly connect the Charger Clamps to the battery, and select the correct charging current *before* turning the Power Switch to its "ON" position. Once the battery(s) is charged, turn the Power Switch to its "OFF" position. *Then* disconnect the Charger Clamps, and remove the battery(s). **(See Figure D.)**
7. **Charger Clamps:** Never allow the **Red** and **Black** Charger Clamps to touch each other or the same metal object. Always connect the **Black** Charger Clamp of the Charger to the **negative (-)** terminal on the battery. Always connect the **Red** Charger Clamp of the Charger to the **positive (+)** terminal on the battery. When connecting the Charger Clamps to the terminals on a battery, always connect the **Red** Charger Clamp first, then connect the **Black** Charger Clamp. When disconnecting the Charger Clamps, always disconnect the **Black** Charger Clamp first, then disconnect the **Red** Charger Clamp. Make all Charger Clamp connections before plugging the Charger's Power Cord Plug into a 120 volt, grounded, electrical outlet and turning on the Power Switch.
8. **Internal 12 Volt Relay (8):** The Battery Charger features an internal 12 Volt Relay to protect the Battery Charger from a short circuit and reverse polarity. The 12 Volt Relay will not connect the battery to the Battery Charger unless the battery voltage is more than 9 volts and connected to the proper polarity.



9. **3 AMP Fuse (9):** The 3 AMP Fuse is located on the **rear panel** of the Battery Charger. In the event the Power On (2) feature on any of the six separate circuits *does not* illuminate, turn Power Switch(es) (6) to the “**OFF**” positions and unplug the Battery Charger from its electrical outlet. Temporarily remove the Fuse Cap. Pull out and remove the 3 AMP Fuse to check for a melted wire strand within the Fuse. If necessary, insert a new 3 AMP Fuse into the Fuse Holder. Then replace the Fuse Cap. Plug the Power Cord of the Battery Charger into its electrical outlet, and turn the Power Switch(es) to the “**ON**” position to resume battery charging.

OPERATING INSTRUCTIONS

To Charge A Battery:

1. The Battery Charger features *six* separate circuits that allow the unit to charge up to *six* batteries at once.
2. To charge a battery, pull out the sliding Shelf on the Battery Charger, and place the battery on the Shelf. Connect the Charger Clamps (7) as discussed in Step #7, *page 10*.
3. Set the Current Selector (1) to the appropriate amperage (0.25, 0.50, or 0.90 AMPs). **(See Figure D.)**
4. Plug the Power Cord of the Battery Charger into the nearest 120 volt, grounded, electrical outlet.
5. Turn the Power Switch (6) (for the circuit you are using) to its “**ON**” position. **(See Figure D.)**
6. When illuminated, the Battery Charged (4) feature will indicate the battery is fully charged. **(See Figure D.)**
7. Once the battery is fully charged, turn off the Power Switch (6). Unplug the Battery Charger from its electrical outlet. Then disconnect the Charger Clamps (7) as discussed in Step #7, *page 10*. **(See Figure D.)**
8. When finished using the Battery Charger, make sure to store the Battery Charger in a clean, dry, safe location out of reach of children and other unauthorized people.

INSPECTION, MAINTENANCE, AND CLEANING

1.  **WARNING!** Before performing any inspection, maintenance, or cleaning procedures, make sure all Switches on the Control Panel are in their “**OFF**” positions and the Charger is disconnected from its electrical outlet. Such preventive safety measures reduce the risk of starting the equipment accidentally.
2. **Before each use:** Inspect the general condition of the Charger. Check for misalignment or binding of moving parts, cracked or broken parts, damaged electrical cables, and any other condition that may affect its safe operation. If abnormal noise or vibration occurs, have the problem corrected before further use. **Do not use damaged equipment.**
3. **Battery precautions:** Never burn batteries, as they can explode in a fire. Do not charge leaking batteries. If liquid is not present, or if liquid appears to be frozen, do not attempt to charge the battery. Contact local solid waste authorities for instructions on correct disposal or recycling of the battery.
4. **To clean:** Clean the exterior of the Charger thoroughly with a clean, wet cloth and a mild detergent. Do not introduce any liquid into the interior of the Charger. Do not use solvents. Do not immerse any part of the Charger in liquids.
5. **When storing:** Store the Charger in a safe, dry, location out of reach of children and untrained users.
6. **NOTE:** The parts listed and shown in this manual are for illustration purposes only, and are not available individually as replacement parts.
7.  **WARNING!** All maintenance, service, and repairs not listed in this manual are only to be attempted by a qualified technician.

PLEASE READ THE FOLLOWING CAREFULLY

THE MANUFACTURER AND/OR DISTRIBUTOR HAS PROVIDED THE PARTS LIST AND ASSEMBLY DIAGRAM IN THIS MANUAL AS A REFERENCE TOOL ONLY. NEITHER THE MANUFACTURER OR DISTRIBUTOR MAKES ANY REPRESENTATION OR WARRANTY OF ANY KIND TO THE BUYER THAT HE OR SHE IS QUALIFIED TO MAKE ANY REPAIRS TO THE PRODUCT, OR THAT HE OR SHE IS QUALIFIED TO REPLACE ANY PARTS OF THE PRODUCT. IN FACT, THE MANUFACTURER AND/OR DISTRIBUTOR EXPRESSLY STATES THAT ALL REPAIRS AND PARTS REPLACEMENTS SHOULD BE UNDERTAKEN BY CERTIFIED AND LICENSED TECHNICIANS, AND NOT BY THE BUYER. THE BUYER ASSUMES ALL RISK AND LIABILITY ARISING OUT OF HIS OR HER REPAIRS TO THE ORIGINAL PRODUCT OR REPLACEMENT PARTS THERETO, OR ARISING OUT OF HIS OR HER INSTALLATION OF REPLACEMENT PARTS THERETO.