

Dolphin[®] 7600



with Microsoft[®] Windows[®] CE 5.0

Disclaimer

Hand Held Products, Inc. ("Hand Held Products") reserves the right to make changes in specifications and other information contained in this document without prior notice, and the reader should in all cases consult Hand Held Products to determine whether any such changes have been made. The information in this publication does not represent a commitment on the part of Hand Held Products.

Hand Held Products shall not be liable for technical or editorial errors or omissions contained herein; nor for incidental or consequential damages resulting from the furnishing, performance, or use of this material.

This document contains proprietary information that is protected by copyright. All rights are reserved. No part of this document may be photocopied, reproduced, or translated into another language without the prior written consent of Hand Held Products.

© 2007 Hand Held Products, Inc. All rights reserved.

Web Address: www.handheld.com

Trademarks

Dolphin, Dolphin RF, HomeBase, Mobile Base, and QuadCharger are trademarks or registered trademarks of Hand Held Products, Inc.

Microsoft, Windows, Windows Mobile, Windows CE, Windows NT, Windows 2000, Windows ME, Windows XP, ActiveSync, Outlook, and the Windows logo are trademarks or registered trademarks of Microsoft Corporation.

Other product names mentioned in this manual may be trademarks or registered trademarks of their respective companies and are the property of their respective owners.

The Bluetooth trademarks are owned by Bluetooth SIG, Inc., U.S.A. and licensed to Hand Held Products, Inc..



Table of Contents

Chapter 1 - Agency Approvals

Label Locations	1-1
Regulatory and Safety Approvals for all Dolphin Terminals	1-2
FCC Compliance	1-3

Chapter 2 - Getting Started

Out of the Box	2-1
Desktop	2-2
Command Bar	2-2
Icons in the Command Bar	2-3

Chapter 3 - Terminal Hardware Overview

Standard Terminal Configurations	3-1
Front Panel Features	3-2
Display Backlight	3-3
Using Screen Protectors	3-4
Back Panel Features	3-10
Side Panel Features	3-11
Top Panel Features	3-12
Installing Memory Cards	3-12
Bottom Panel Features	3-14
Using the Accessory Attachment	3-15
Attaching a Belt Clip	3-15
Attaching the Hand Strap	3-15
Dolphin 7600 Peripherals	3-16
Dolphin 7600 Accessories	3-16
Battery Power	3-17
Resetting the Terminal	3-20
Soft Reset (Warm Boot)	3-20
Hard Reset (Cold Boot)	3-20
Suspend Mode	3-20
Changing the Memory Allocation	3-21
Format IPSM	3-21
Dolphin 7600 Terminal Technical Specifications	3-22

Chapter 4 - Using the Keyboards

Overview	4-1
Suspend/Resume	4-1
Function Keys	4-2
Modifier Keys	4-2
Alpha/Numeric Indicator	4-3

29-Key Numeric Keyboard	4-4
Navigation Keys.....	4-4
Hardware Application Buttons.....	4-5
Toggling Between Alpha and Numeric Modes.....	4-6
29-Key Blue Key Combinations (Alpha Mode)	4-7
29-Key Shift Functionality in Numeric Mode	4-7
29-Key Red Key Combinations	4-8
38-Key Alpha Keyboard.....	4-9
Toggling Between Alpha and Numeric Modes.....	4-9
38-Key Red Key Combinations	4-10
38-Key NUM Lock Mode	4-11

Chapter 5 - Using the Image Engine

Overview	5-1
Available Image Engines.....	5-1
Depth of Field	5-1
Supported Bar Code Symbologies.....	5-2
Activating the Engine	5-3
Decoding.....	5-3
Capturing Images.....	5-5

Chapter 6 - Communication

Communication Options.....	6-1
Installing Additional Software.....	6-1
Connecting the USB Cable.....	6-2
ActiveSync Communication.....	6-3
Wireless Radios	6-6
Connecting the Terminal to a Wireless Network.....	6-6
WLAN (802.11b/g Radio).....	6-6
Adding Programs From the Internet.....	6-7
Infrared Communication.....	6-8

Chapter 7 - Bluetooth Manager

Overview	7-1
Enabling the Bluetooth Radio.....	7-1
Setting Tab.....	7-2
BT Service Tab.....	7-2
Serial Port Tab.....	7-3
Connecting to Bluetooth Printers	7-4
Connecting to Other Bluetooth Devices	7-7
Bluetooth ActiveSync.....	7-10

Chapter 8 - Dolphin HomeBase

Overview	8-1
Front Panel	8-2
Back Panel	8-3
Powering the Dolphin HomeBase	8-3
Charging the Main Battery	8-4

Mounting the Dolphin HomeBase	8-5
Bottom Panel Dimensions	8-6
Dolphin HomeBase Technical Specifications	8-7

Chapter 9 - Dolphin QuadCharger

Overview	9-1
Front Panel	9-1
Back Panel	9-2
Supplying Power to the QuadCharger	9-2
Battery Charging	9-3
Recommendations for Storing Batteries	9-3
Mounting the QuadCharger	9-4
Troubleshooting	9-5
Dolphin QuadCharger Technical Specifications	9-6

Chapter 10 - Dolphin Mobile Mount

Overview	10-1
Mounting	10-3

Chapter 11 - Customer Support

Product Service and Repair	11-1
Online Product Service and Repair Assistance	11-1
Technical Assistance	11-2
Online Technical Assistance	11-2
For Further Information	11-2
Limited Warranty	11-3



Label Locations

Dolphin 7600 mobile computers meet or exceed the requirements of all applicable standards organizations for safe operation. However, as with any electrical equipment, the best way to ensure safe operation is to operate them according to the agency guidelines that follow. Please read these guidelines carefully before using your Dolphin mobile computer.

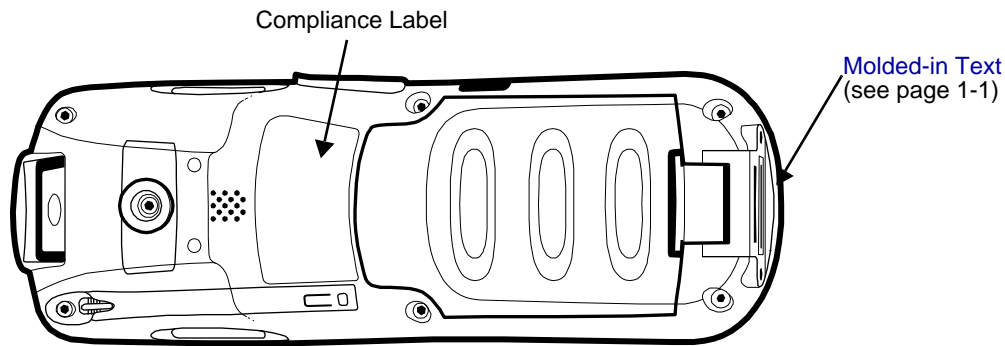

Molded-in Text



Dolphin 7600 Terminals with 802.11b/g and/or Bluetooth

Dolphin 7600 RF terminals are designed to comply with the most current applicable standards on safe levels of RF energy developed by the Institute of Electrical and Electronics Engineers (IEEE) and the American National Standards Institute (ANSI) and has been recommended for adoption by the Federal Communications Commission (FCC).

Regulatory and Safety Approvals for all Dolphin Terminals

Parameter	Specification
U.S.A	FCC Part 15, Class B
Canada	ICES-003
European Community	EN 55022 (CISPR 22) Class B EN60950:2000 EN60825-1:1994 + A11 + A2 EN55024:1998

CE The CE Mark on the product indicates that the system has been tested to and conforms with the provisions noted within the 89/336/EEC Electromagnetic Compatibility Directive and the 73/23/EEC and 93/68/EEC Low Voltage Directive.

For further information, please contact:

Hand Held Products, Inc.
Nijverheidsweg 9
5627 BT Eindhoven
The Netherlands

Hand Held Products shall not be liable for use of our product with equipment (i.e., power supplies, personal computers, etc.) that is not CE marked and does not comply with the Low Voltage Directive.

Laser Safety Label

If the following label is attached to your product, it indicates the product contains a laser engine or laser aimer:

Laser Eye Safety Statement: This device has been tested in accordance with and complies with IEC60825-1: 1993+A1+A2 and 21 CFR 1040.10 and 1040.11, except for deviations pursuant to Laser Notice No. 50, dated July 26, 2001. **LASER LIGHT, DO NOT STARE INTO BEAM, CLASS 2 LASER PRODUCT, 1.0 mW MAX OUTPUT: 650nm.**

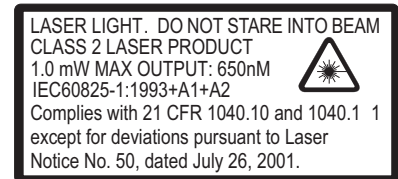

Caution - use of controls or adjustments or performance of procedures other than those specified herein may result in hazardous radiation exposure.

LED Safety Statement

This device has been tested in accordance with IEC60825-1 LED safety, and has been certified to be under the limits of a Class 1 LED device.

CB Scheme

Certified to CB Scheme IEC 60950-1.

FCC Compliance

Dolphin Batch terminals comply with part 15 of the FCC rules. Operation is subject to the following two conditions: (1) this device may not cause harmful interference, and (2) this device must accept any interference received, including interference that may cause undesired operation.

Dolphin RF Terminal—802.11b/g and/or Bluetooth

This device complies with Part 15 of the FCC Rules. Operation is subject to the following two conditions: (1) this device may not cause harmful interference, and (2) this device must accept any interference received, including interference that may cause undesired operation.

This equipment has been tested and found to comply with the limits for a Class B digital device pursuant to Part 15 of the FCC Rules. These limits are designed to provide reasonable protection against harmful interference in a residential installation. This equipment generates, uses, and can radiate radio frequency energy and, if not installed and used in accordance with the instructions, may cause harmful interference to radio communications. However, there is no guarantee that interference will not occur in a particular installation. If this equipment does cause harmful interference to radio or television reception, which can be determined by turning the equipment off and on, the user is encouraged to try to correct the interference by one or more of the following measures:

- Reorient or relocate the receiving antenna.
- Increase the separation between the equipment and receiver.
- Connect the equipment into an outlet on a circuit different from that to which the receiver is connected.
- Consult the dealer or an experienced radio/TV technician for help.

If necessary, the user should consult the dealer or an experienced radio/television technician for additional suggestions. The user may find the following booklet helpful: "Something About Interference." This is available at FCC local regional offices. Our company is not responsible for any radio or television interference caused by unauthorized modifications of this equipment or the substitution or attachment of connecting cables and equipment other than those specified by our company. The correction is the responsibility of the user. Use only shielded data cables with this system.

In accordance with FCC 15.21, changes or modifications not expressly approved by Hand Held Products, Inc. may void the FCC authorization to operate the equipment.



This device and its antenna must not be co-located or operating in conjunction with any other antenna or transmitter. To maintain compliance with FCC RF exposure guidelines for body-worn operation, do not use accessories that contain metallic components.

When using accessories where the terminal is worn on the body, the terminal's touch screen must face away from the body.

CAUTION! Any changes or modifications not expressly approved by the grantee of this device could void the user's authority to operate the equipment.

FCC RF Radiation Exposure Statement

This equipment complies with FCC RF radiation exposure limits set forth for an uncontrolled environment.

Max.SAR Measurement (1g)

- 802.11b: 0.234w/kg
- 802.11g: 0.234w/kg

RF, Regulatory, and Safety Agency Approvals—802.11b/g and/or Bluetooth

Parameter	Specification
RF Approvals U.S.A Canada	FCC Part 15.247 RSS 210

R&TTE Compliance Statement—802.11b/g and/or Bluetooth

Dolphin RF terminals are in conformity with all essential requirements of the R&TTE Directive (1999/5/EC). This equipment has been assessed to the following standards as applicable:

Parameter	Specification
R&TTE	EN 300 328-2:2000 EN 301 489-1 (2002-08) EN 301 489-17 (2002-08) EN 60950:2000 EN 50361:2001

This product is marked with **CE**  in accordance with the Class II product requirements specified in the R&TTE Directive, 1999/5/EC.

The equipment is intended for use throughout the European Community. Its authorization for use in France is restricted as follows:

PAN European Frequency Range: 2.402–2.480 GHz.

Restrictions in France are as follows:

- Indoor use - Maximum power (EIRP*) of 100 mW for the entire 2.4–2.4835 GHz
- Outdoor use - Maximum power (EIRP*) of 100 mW for the 2.400–2.454 GHz band and maximum power (EIRP*) of 10 mW for the 2.454–2.483 GHz band.

Canadian Compliance

This Class B digital apparatus complies with Canadian ICES-003. Operation is subject to the following two conditions: (1) this device may not cause harmful interference, and (2) this device must accept any interference received, including interference that may cause undesired operation.

To prevent radio interference to the licensed service, this device is intended to be operated indoors and away from windows to provide maximum shielding. Equipment (or its transmit antenna) installed outdoors is subject to licensing.

Cet appareil numérique de la Classe B est conforme à la norme NMB-003 du Canada.

For European Community Users

Hand Held Products complies with Directive 2002/69/EC OF THE EUROPEAN PARLIAMENT AND OF THE COUNCIL of 27 January 2003 on waste electrical and electronic equipment (WEEE).

Waste Electrical and Electronic Equipment Information

This product has required the extraction and use of natural resources for its production. It may contain hazardous substances that could impact health and the environment, if not properly disposed.

In order to avoid the dissemination of those substances in our environment and to diminish the pressure on the natural resources, we encourage you to use the appropriate take-back systems for product disposal. Those systems will reuse or recycle most of the materials of the product you are disposing in a sound way.



The crossed out wheeled bin symbol informs you that the product should not be disposed of along with municipal waste and invites you to use the appropriate separate take-back systems for product disposal.

■ If you need more information on the collection, reuse, and recycling systems, please contact your local or regional waste administration.

You may also contact your supplier for more information on the environmental performances of this product.

Pacemakers, Hearing Aids and Other Electrically Powered Devices

Most manufacturers of medical devices adhere to the IEC 601-1-2 standard. This standard requires devices to operate properly in an EM Field with a strength of 3V/m over a frequency range of 26 to 1000MHz. The maximum allowable field strength emitted by the Dolphin is 0.3V/m according to Subpart B of Part 1 of the FCC rules. Therefore, the Dolphin RF has no effect on medical devices that meet the IEC specification.

Microwaves

The radio in the Dolphin RF terminal operates on the same frequency band as a microwave oven. Therefore, if you use a microwave within range of the Dolphin RF terminal you may notice performance degradation in your wireless network. However, both your microwave and your wireless network will continue to function. The Dolphin Batch terminal does not contain a radio, and therefore, is not affected by microwave ovens.



Out of the Box

Verify that your carton contains the following items:

- Dolphin 7600 mobile computer (the terminal)
- Main battery pack (3.7v, Li-ion)
- AC power supply
- Localized plug adapters
- User CD

Note: Be sure to keep the original packaging in case you need to return the Dolphin terminal for service; see [Product Service and Repair](#) on page 11-1.

Step 1. Install the Main Battery

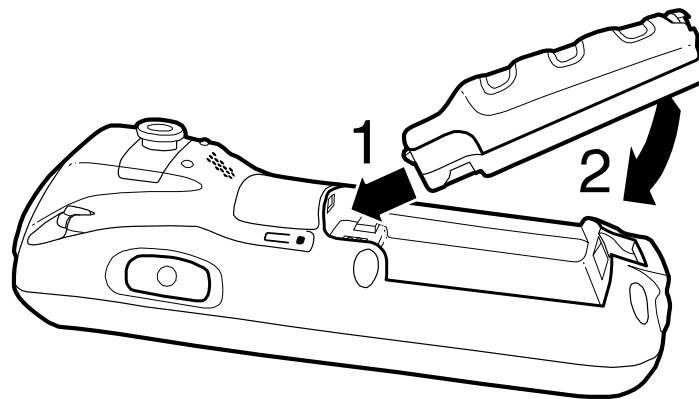

Use only the Li-ion battery packs provided by Hand Held Products. The use of any battery pack not sold/manufactured by Hand Held Products in a Dolphin terminal will void your warranty and may result in damage to the Dolphin terminal or bat

Step 2. Charge the Batteries

Dolphin terminals ship with both the main battery pack and internal backup battery significantly discharged of power. Charge the main battery pack with the Dolphin charging cable for a **minimum of four hours before initial use.**

1. Attach the appropriate plug adapter to the plug of the power cable.
2. Plug the *Dolphin power cable into the [DC Power Jack](#) (see page 3-11) on the left side.
3. Insert the plug into the appropriate power source.

*This power cable can also be used to power the [Dolphin HomeBase](#) (see page 8-1).

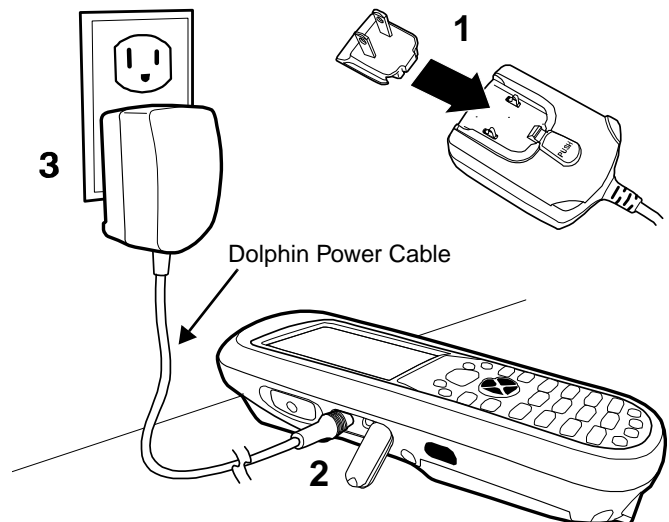

Use only the peripherals, power cables, and power adapters from Hand Held Products. Use of peripherals, cables, or power adapters not sold/manufactured by Hand Held Products will void the warranty and may damage the terminal.

Step 3. Boot the Terminal

Windows CE

The terminal begins booting as soon as power is applied and runs by itself. Do NOT press any keys or interrupt the boot process. When the boot process is complete, the [Desktop](#) (see page 2-2) appears and the terminal is ready for use.

Windows Mobile

The terminal begins booting as soon as power is applied and runs by itself. Do NOT press any keys or interrupt the boot process. Only tap the screen when prompted.

When the boot process is complete, the [Desktop](#) (see page 2-2) appears and the terminal is ready for use.

Desktop

System resets (see [Resetting the Terminal](#) on page 3-20) complete on the Desktop.

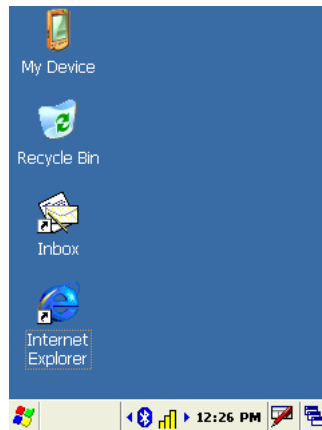

Note: You can access the Desktop any time by tapping the Desktop icon in the command bar  and selecting Desktop on the popup menu.





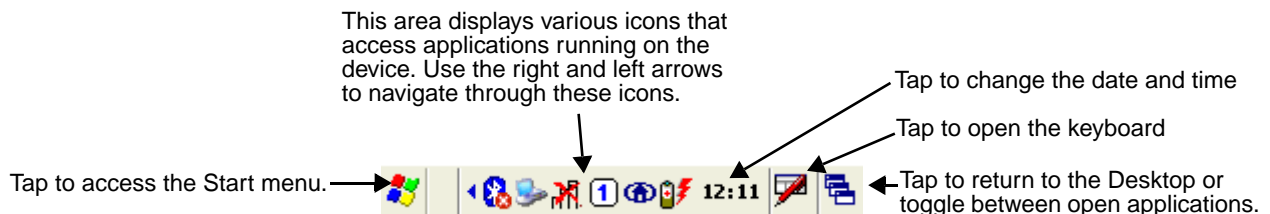





Command Bar

Located at the bottom of application screens, the command bar includes application menus, buttons, and provides access to the Input Panel.

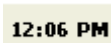

Icons in the Command Bar

The [Command Bar](#) (see page 2-2) contains a number of icons that indicate the status of various functions on the terminal.

Status Icon	Meaning
	Opens the Start menu.
Icons Between the Arrows	
Because there may be more icons than the device can display, use the left and right arrows to scroll through the icons.	
	Accesses the Bluetooth radio. Single-tap this icon to open the Bluetooth Manager (see page 7-1).
	Activates the 802.11b/g radio; see Activating the 802.11b/g Radio on page 7-1..
	Accesses the Meetinghouse Client for the 802.11b/g radio. Single-tap this icon to open the Meetinghouse Client.
	The USB communication cable is connected.
	Indicates the status of battery power. This icon means that the battery is low. Double-tap this icon to open the Power control panel setting.
	Indicates that the device is running on external power. Double-tap this icon to open the Power control panel setting.
	Indicates that the keyboard is in numeric or alpha mode.
	Displays the current time. Double-tap to change the time and date.
	Tap this icon to open the soft input panel (SIP) manually.
	This icon appears when the SIP is open, whether the SIP was opened manually or automatically popped up on an application screen. Tap this icon and select Hide Input Panel on the menu that pops up when you want to close the SIP.

Using the Stylus

The terminal comes with a stylus inserted into the [Stylus Slot](#) (see page 3-10). Use this stylus (or your finger) to select or enter information on the touch screen. The stylus functions as a mouse; generally, a tap is the same as a click.

- Tap** Tap the touch screen once to open menu items and select options.
- Drag** Hold the stylus on the screen and drag across the screen to select text and images.
- Tap & hold** Tap and hold the stylus on an item and a pop-up menu appears. On the pop-up menu, tap the action of the task you want to perform.



Use of other objects other than the stylus, such as paper clips, pencils, or ink pens can damage the touch screen and will void the warranty.

For more information about the touch screen see [Touch Screen Display](#) on page 3-2.

Selecting Programs

Tap **Start > Programs**. To open a program, tap the icon on the menu.

Pop-Up Menus

With pop-up menus, you can quickly choose an action for an item.

1. Tap and hold the stylus on the item name. The pop-up menu appears.
2. Lift the stylus, and tap the action you want to perform.

The contents of pop-up menus change according to the program you're in.

Using Windows Explorer

Use Windows Explorer to navigate through the files on your system. On the desktop, double-tap the **My Device** icon  and Windows Explorer opens to the root level,

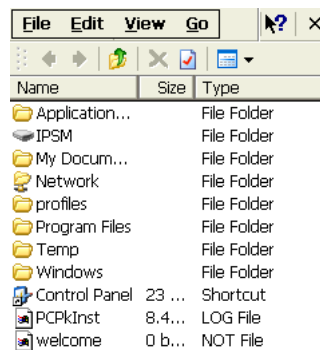

Move files by tapping and holding on the file, then tapping **Cut**, **Copy** or **Paste** on the pop-up menu that appear.

Terminal Hardware Overview

The Dolphin 7600 includes a number of standard terminal configurations as well as charging and communication peripherals and accessories to maximize the efficiency of your application setting.

Standard Terminal Configurations

There are two standard Dolphin 7600 configurations:

Dolphin 7600 WPAN	Dolphin 7600 WPAN/WLAN
<ul style="list-style-type: none"> • Microsoft Windows CE 5.0 • Samsung 2440 400 MHz • 64MB RAM X 128 MB (non-volatile) Memory • 29-key numeric keyboard • 2.8" 1/4 VGA TFT color display • Li-ion battery: 3.7V / 2200 mAh / 8.1 Wh • 5300SR image engine • Bluetooth radio • Dolphin power cable (each Dolphin 7600 device comes with this power cable in the box) 	<ul style="list-style-type: none"> • Microsoft Windows CE 5.0 • Samsung 2440 400 MHz • 128MB RAM X 128 MB (non-volatile) Memory • 29-key numeric keyboard • 2.8" 1/4 VGA TFT color display • Li-ion battery: 3.7V / 3240 mAh / 12.0 Wh • 5300SR image engine • Bluetooth and 802.11b/g radio • Dolphin power cable (each Dolphin 7600 device comes with this power cable in the box)

Front Panel Features



Decode and Scan LEDs

The Scan LED lights red when you press the Scan trigger in scanning applications. The Decode LED lights green when a scanned bar code is successfully decoded. Both LEDs are user-programmable.

Hardware Application Buttons

These hardware buttons appear only on the 29-key numeric keyboard and can be programmed to perform software functions in the Buttons setting (Start > Settings > Control Panel > double-tap Buttons). For more information, see [Hardware Application Buttons](#) on page 4-5.

Keyboard

Keyboards are recessed within the housing to increase durability. There are two keyboard options available: one that defaults to numeric (shown above) and one that defaults to alpha. For information about using both keyboards, see [Using the Keyboards](#) on page 4-1.

Microphone

The integrated microphone can be used for voice-recording and reply.

Touch Screen Display

The display is a 65,536-color LCD (Liquid Crystal Display) covered by a touch screen lens. The 2.8" (1/4) VGA (Video Graphic Array) is TFT (Thin Film Transistor) color, backlit, and the resolution is 240 x 320; see [Display Backlight](#) on page 3-3.



Dolphin 7600 devices ship with a screen protector already installed over the touch screen lens to help prevent damage to the touch screen. Do NOT remove this screen protector before initial use. Hand Held Products recommends using screen protectors, especially for applications that require high-volume interfacing with the touch screen. For more information, see [Using Screen Protectors](#) on page 3-4.

For touch screen input, use the stylus included with the terminal or your finger. The method you choose depends on which one is most appropriate for your application. While there is a great deal of variation in different applications, for buttons or icons that are close together, you generally achieve greater accuracy with the stylus; see [Using the Stylus](#) on page 2-3.



Use of objects, such as paper clips, pencils, or ink pens on the touch screen can damage the input panel and will void the warranty.

Display Backlight

The touch screen display has a backlight that is programmed to turn off after a specified period of time that the device is idle. To change the default timeout parameters, tap **Start > Settings > Control Panel > Display > Backlight** tab.

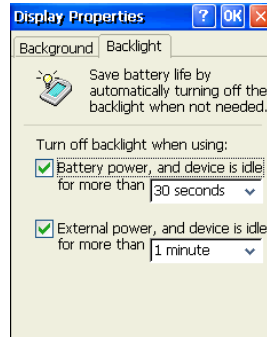

To adjust the intensity of the backlight, tap **Start > Settings > Control Panel > double-tap Backlight**  BackLight.

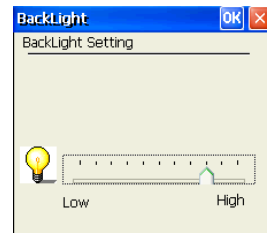

Move the slider to adjust the backlight.

Using Screen Protectors

Hand Held Products defines proper use of the terminal touch panel display as using a screen protector and proper stylus. Screen protectors maintain the ongoing integrity (i.e., prevent scratching) of the touch panel, which is why their use is recommended for applications that require a high to medium level of interface with the touch panel.

Hand Held Products continues to advocate the use of screen protectors on all Dolphin devices. We recommend implementing a screen protector replacement program to ensure that screen protectors are replaced periodically when signs of damage/wear are noticeable. For general use, we recommend replacing the screen protector every thirty (30) days. However, replacement cycles vary according to the average level of touch panel use in your application.

Replacement screen protectors can be purchased directly from Hand Held Products. Please contact a Hand Held Products sales associate for details.

Hand Held Products also mandates use of a proper stylus, which is one that has a stylus tip radius of no less than 0.8mm. Use of the Hand Held Products stylus included with the terminal is recommended at all times.

Hand Held Products warranty policy covers wear on the touch panel for the first 12 months provided that a screen protector is applied and an approved stylus is used for the 12 month duration covered by the warranty.

Removing the Screen Protector

Dolphin 7600s ship with a touch screen protector already installed. To replace the screen protector, you must remove the one already installed.

1. You will need a strong, flat, plastic card (a credit card, for example) to wedge under the existing screen protector.



Note: If you have one, you can also use the small plastic squeegees designed for touch panels.

2. Press the **Blue**  + **Backlight**  keys to put the terminal in suspend mode.

-
- Carefully apply the flat edge of your plastic card to the upper right corner of the touch panel. Catch the edge of the screen protector and pull it up and away from the touch panel.

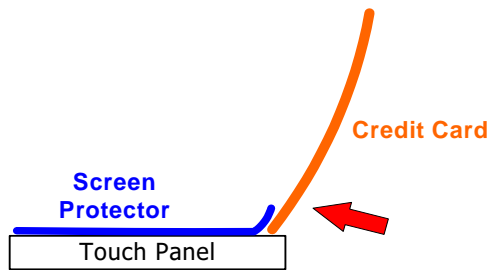

- Wipe the screen with a clean, non-abrasive, lint-free cloth.





Note: Use ionized air, if available, to blow additional dirt or particles off the touch panel.

Installing Your Screen Protector

When installing a new screen protector, use a flat plastic card (such as a credit card) to apply the screen protector smoothly and remove any air bubbles.



Note: If you have one, you can also use the small plastic squeegees designed for touch panels.

1. Press the **Blue**  + **Backlight**  keys to put the terminal back in suspend mode.
2. Clean the touch panel thoroughly with a clean, non-abrasive, lint-free cloth. Make sure nothing is attached to the top of the touch panel.
3. Release the left edge of the releasing paper on the screen protector.

-
- Align the exposed edge of the screen protector along the left edge of the touch panel. Make sure that it lies flush with edges of the touch panel.

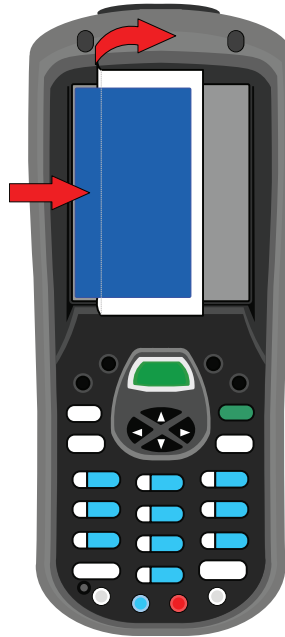

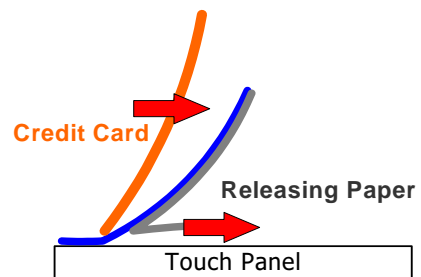
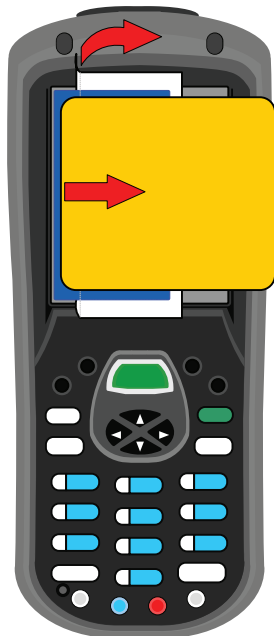

Note: To reposition the screen protector, lift up gently and reapply.

- Use the card on top of the screen protector to smooth it out as you pull on the releasing paper.



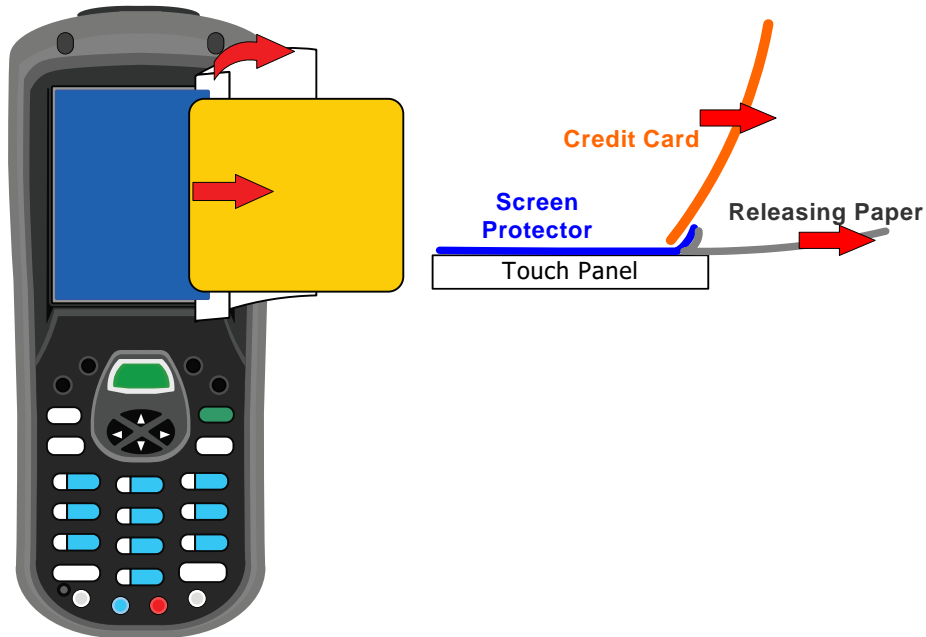

-
6. Pull smoothly and evenly from left to right until the screen protector is applied. Press gently but firmly.



7. Use the card as necessary to smooth out any air pockets or bumps after application. Press gently but firmly.
8. Press the **Backlight**  key to wake the terminal and check the touch panel with the stylus.



9. Verify that the screen accepts input from the stylus as usual. If not, re-apply the screen protector.
10. Press the **Blue**  + **Backlight**  keys to put the terminal back in suspend mode.

11. Clean the surface of the screen protector with a clean, non-abrasive, lint-free cloth.



12. Press the **Backlight**  key to wake the terminal again.

13. For maximum performance, recalibrate the screen. Tap **Start** > **Control Panel** > double-tap **Stylus**  > **Calibration** tab.



14. Tap **Recalibrate** and follow the instructions on the screen.

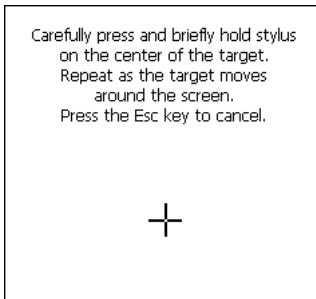

Back Panel Features

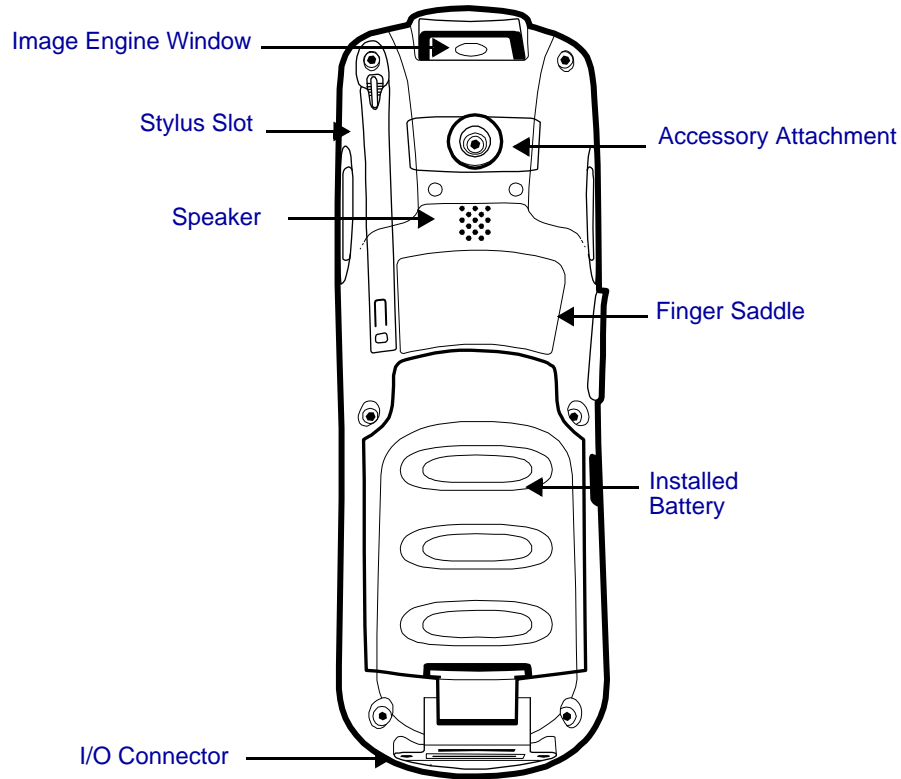

Accessory Attachment

This button can be used with various accessories; see [Using the Accessory Attachment](#) on page 3-15.

Finger Saddle

This is a slightly depressed and angled area of the back panel that is designed to cradle or “saddle” your pointer finger while holding the terminal. This unique ergonomic design makes the terminal comfortable to hold and helps prevent you from accidentally dropping the terminal.

Installed Battery

The back of the battery pack conforms to the back panel. For information about installing the battery, see [Changing the Main Battery Pack](#) on page 3-17. For information about battery power, see [Battery Power](#) on page 3-17.

Speaker

The integrated speaker sounds audio signals as you scan bar code labels and enter data but emits no ambient noise on system activity (i.e. processor, memory access, radio traffic, etc.). The speaker can also be used for playing sounds (e.g., WAV or MP3 files).

The speaker meets the following SPL levels at 40cm:

- 500Hz–67db
- 1KHz–72db
- 4KHz–72db

Stylus Slot

Dolphin 7600 terminals ship with a stylus inserted. Store the stylus in this slot when you’re not using it; see [Using the Stylus](#) on page 2-3.

Side Panel Features

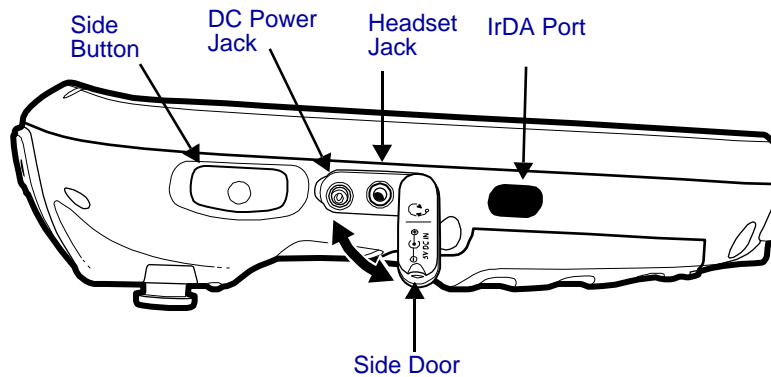

Note: This graphic shows the left side of the Dolphin 7600 terminal.

DC Power Jack

The DC power jack receives external power from the Dolphin power cable that comes in the box with the terminal. When connected to the Dolphin Power Cable, the terminal is powered and the main battery pack is charging.

For more information, about the Dolphin Power Cable, see [Charge the Batteries](#) on page 2-1.

Headset Jack

This is a 2.5mm audio jack that supports a headset with a mono speaker and microphone.

IrDA Port

The IrDA (Infrared Data Association) port communicates with IrDA-enabled devices such as PCs, printers, modems, or other Dolphin 7600 terminals. Maximum data transfer speed is 115 Kbps. You access IrDA communication functionality in the Bluetooth Manager. For more information, see [Infrared Communication](#) on page 6-8.

Side Button

There is a button like this on both side panels. By default, these buttons wake the terminal from suspend mode unless you are in a scanning application, in which case, these buttons activate the image/scan engine. Scanning with the side buttons can be a more comfortable and therefore a more ergonomic alternative to pressing the SCAN key on the keyboard.

These buttons can be programmed to launch applications from the Desktop. For more information about programming these buttons, see [Customizing a Hardware Button](#) on page 4-5.

Side Door

The rubber door on the left side panel provides access to the Headset and DC power jacks.

When closed, the side door seals the terminal from moisture and particle intrusion thus preserving the terminal's environmental rating.

Top Panel Features

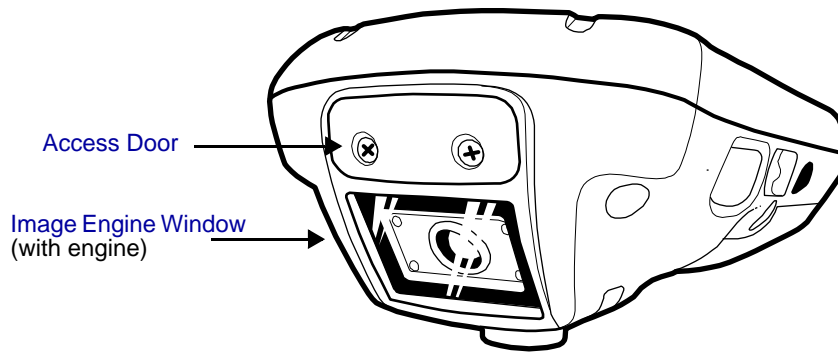

*Pull the plastic tab to remove the plastic film cover over the image engine window before activating the image engine.

Access Door

For more memory, you can install optional memory cards by removing this door. For details, see [Installing Memory Cards](#) on page 3-12.

When closed, the access door seals the memory interface from moisture and particle intrusion thus preserving the terminal's environmental rating.

Image Engine Window

The angled image engine reads and decodes most popular bar code symbologies and takes images like a digital camera. For more information, see [Using the Image Engine](#) on page 5-1.

Installing Memory Cards

The Dolphin 7600 supports Secure Digital (SD) memory cards of the following capacities:

- 256 MB
- 512 MB
- 1 GB
- 2 GB

To install an SD card, you must open the access door on the top panel ([Top Panel Features](#), page 3-12).

Note: Access door removal **requires** a Phillips head screwdriver.

1. Press Blue + Backlight key to put the terminal in suspend mode; see [Suspend Mode](#) on page 3-20.
2. Place the terminal on a flat, secure surface with the keyboard face-up.
3. Unscrew both screws on the access door.

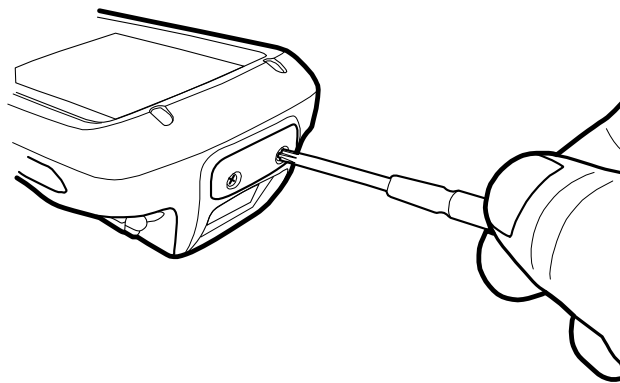

-
4. When the access door is open, slide the SD card into the appropriate slot until it clicks into place. SD cards must be inserted with the label side facing forward (toward the touch screen).

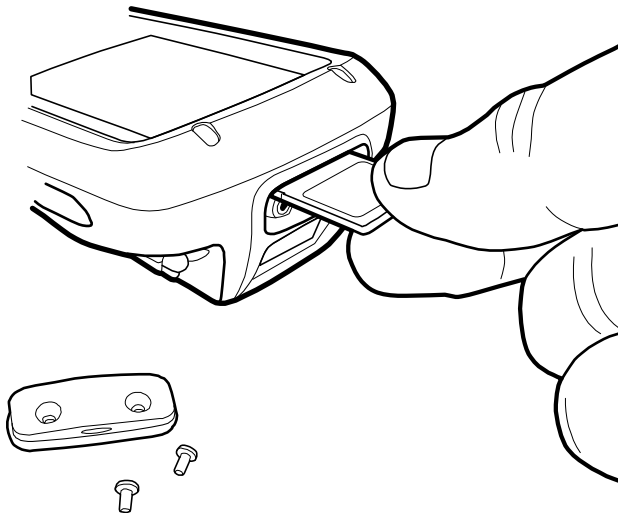

Note: To remove an installed SD card while the access door is open, tap on the edge lightly to unlock the card; the card will pop out just enough for you to grab its edge and pull it out.

5. Replace the access door and tighten the screws.
The rubber gasket and surrounding O-ring inside the access door are required for 1) proper functioning of the SD card and 2) preserving the environmental rating for water sealing. Do not remove the gasket or the O-ring.



Do NOT resume terminal operation while the access door is open! Operating the terminal while the access door is open will void the warranty. The access door must be properly sealed before resuming terminal operation. Failure to seal the access door will void the warranty.

6. Tap the Blue + Backlight keys to resume operation.
7. To verify that the operating system recognizes the new memory card, open Windows Explorer and navigate to My Device\IPSM\Storage Card.

Bottom Panel Features

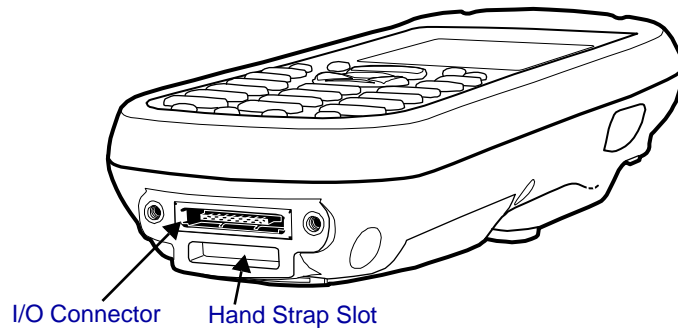

Hand Strap Slot

There is an adjustable, elastic hand strap available for purchase with the Dolphin 7600 terminal. When installing the hand strap, you loop the elastic strip through this slot. For instructions, see [Attaching the Hand Strap](#) on page 3-15.

I/O Connector

The I/O mechanical connector is designed to work exclusively with Dolphin 7600 peripherals and cables. This connector powers the terminal, charges the main battery, and facilitates communication. This connector supports full speed USB 1.1 communication (up to 12 Mbps) and RS-232 communications with a maximum speed of 115Kbps and seven baud rate settings.

Through this connector, you can communicate with a host workstation via Microsoft ActiveSync; see [ActiveSync Communication](#) on page 6-3.

The I/O connector supports the following signals:

- Data Carrier Detect
- Received Data
- Transmitted Data
- Data Terminal Ready
- Signal GND
- Data Set Ready
- Request To Send
- Clear To Send
- Ring Indicator
- USB GND
- USB +5V
- USB D+
- USB D-

Note: Signals referenced are for a DTE device.

Using the Accessory Attachment

The accessory attachment is a standard tab designed to fit universal accessories available for most cell phones.

Attaching a Belt Clip

The accessory attachment on the back panel fits universal swivel clips designed for belts or even pedestal mounts (not available from Hand Held Products).

Simply insert the tab into the slot until you hear a click or follow the instructions that came with the clip or accessory.

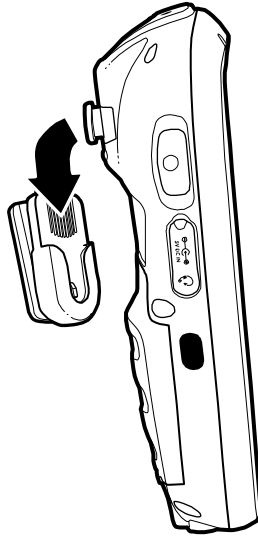

Attaching the Hand Strap

The accessory attachment can also be used to attach the Dolphin 7600 hand strap available from Hand Held Products.

Remove the accessory attachment and thread the hand strap hook underneath. Then, fasten the accessory attachment to the back panel.

Keep in mind that the hand strap covers the battery. When you want to replace the battery, you will need to adjust the hand strap accordingly.

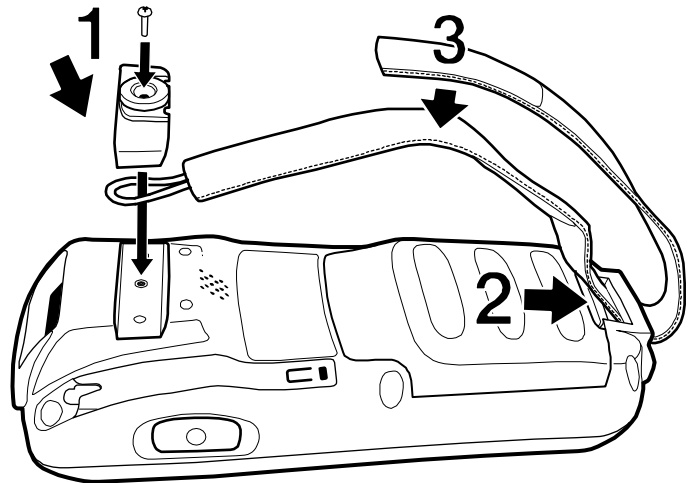

Dolphin 7600 Peripherals

The following items are sold separately and enhance your Dolphin 7600 terminal's capabilities.

Dolphin HomeBase™

The Dolphin HomeBase charging and communication cradle supports USB communication, enabling your terminal to interface with the majority of PC-based enterprise systems. When a terminal is seated in a powered HomeBase, its main battery pack charges in less than four hours. A serial RS-232 version of the Dolphin HomeBase is also available.

For more information, see [Dolphin HomeBase](#) on page 8-1.

Dolphin QuadCharger™

The Dolphin QuadCharger is a four-slot charging station for Dolphin Li-ion battery packs that can charge each battery in less than four hours.

For more information, see [Dolphin QuadCharger](#) on page 9-1.

Dolphin 7600 Accessories

Each of the following items is sold separately to enhance your Dolphin 7600 terminal's capabilities.

Protective Enclosure

This enclosure wraps around the terminal to protect it from wear and tear.

Li-ion Battery Packs

The available Li-ion battery packs provide the main power supply for the terminal. For more information, see [Battery Power](#) on page 3-17.

For information on how to purchase these items, contact a Hand Held Products sales representative.

Battery Power

The Dolphin 7600 features intelligent battery technology with two types of battery power:

- The main battery pack on the back panel (see [Main Battery Pack](#) on page 3-17)
- The backup battery located inside the terminal (see [Internal Backup Battery](#) on page 3-19)

Both batteries work together to prevent data loss when the terminal is used over long periods of time.

Both batteries must be charged to full capacity before using the Dolphin 7600 for the first time!

Main Battery Pack



Use only the Li-ion battery packs provided by Hand Held Products. The use of any battery pack not sold/manufactured by Hand Held Products in a Dolphin terminal will void your warranty and may result in damage to the Dolphin terminal or bat

There are two Li-ion battery packs available for the Dolphin 7600:

Standard Li-ion 3.7V/2200mAh/8.1Wh

Optional Li-ion 3.7V/3240mAh/12.0Wh

The Li-ion battery packs are the primary power source for the Dolphin terminal as well as the internal backup battery.

Changing the Main Battery Pack

Before installing a battery pack, press the Blue + Backlight keys to put the terminal in [Suspend Mode](#) (see page 3-20) so that operations are suspended before removing the main power source. Always put the terminal in suspend mode prior to changing the battery.

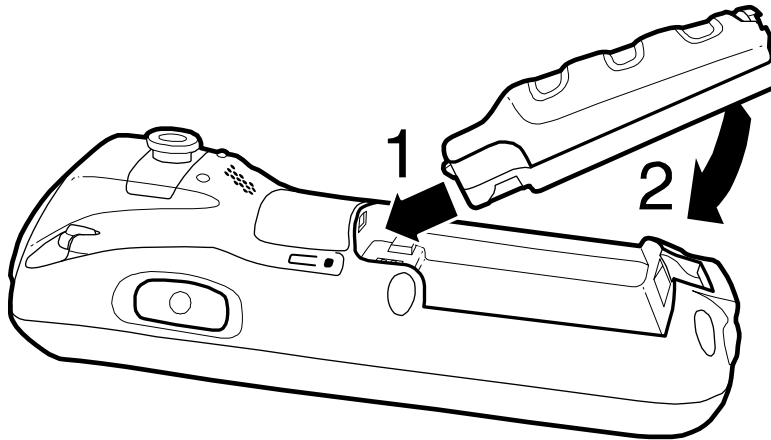

Charging Options

When the battery is installed in the terminal, you can insert the terminal into any one of the following peripherals:

- [Dolphin HomeBase](#) (see page 8-1)
- Dolphin Charge/Comm Cable; [Connecting the USB Cable](#) (see page 6-2)
- [Dolphin Power Cable](#) (see page 2-1)

To fully charge the Li-ion battery before installing in the terminal, use the

- [Dolphin QuadCharger](#) (see page 9-1)

Charging Time

Both Li-ion battery packs require four hours to charge to full capacity.

Managing Main Battery Power

Data and files saved on the Dolphin terminal may be stored in RAM memory; therefore, maintain a continuous power supply to the terminal to help prevent data loss. When you remove a battery pack, insert another charged battery pack in the Dolphin. If the main battery pack is low, insert the terminal into a charging peripheral to power the terminal and begin recharging the battery.

*Note: If the main battery is low and the terminal is in suspend mode, pressing the SCAN button does **not** wake the Dolphin terminal; you must replace the discharged battery with a fully charged battery.*

Checking Battery Power

Power icons appear in the command bar at the bottom of the window. For example,  indicates a low battery. Double-tap on this icon at any time to open the Power system setting. The Battery tab opens displaying the charge status of both the main and backup batteries.

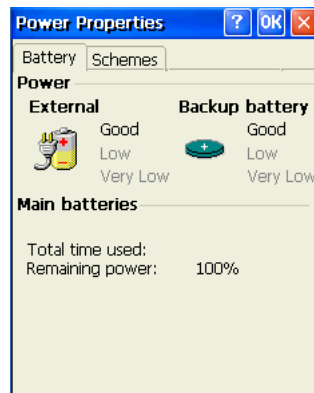

Note: To manually check battery power, also tap Start > Settings > Control Panel > double-tap Power .

Storage Guidelines

To maintain optimal battery performance, follow these storage guidelines:

- Avoid storing batteries outside the specified range of -4 to 122° F (-20 to 50°C) or in extremely high humidity.
- For prolonged storage, do not keep batteries stored in a charger that is connected to a power source.

Guidelines for Battery Use and Disposal

The following are general guidelines for the safe use and disposal of batteries:

- Use only the battery supplied, recommended, or approved by Hand Held Products.
- Replace defective batteries immediately; using a defective battery could damage the Dolphin terminal.
- Never throw a used battery in the trash. It contains heavy metals and should be recycled according to local guidelines.
- Don't short-circuit a battery or throw it into a fire. It can explode and cause severe personal injury.
- Excessive discharge damages a battery. Recharge the battery when your terminal indicates low battery power.
- Although your battery can be recharged many times, it will eventually be depleted. Replace it after the battery is unable to hold an adequate charge.
- If you are not sure the battery or charger is working properly, please send it to Hand Held Products or an authorized Hand Held Products service center for inspection.

Internal Backup Battery

Located inside the terminal, the backup battery is a 2.4V nickel metal hydride (NiMH) battery.

The internal backup battery prevents the terminal from being reset when you remove the main battery pack. This battery retains RAM data and allows the real-time clock to remain operational for up to 30 minutes. If the terminal is left without the main battery pack for more than 30 minutes, the internal backup battery discharges and needs to be recharged to function according to specifications.

Note: Even if the internal backup battery fails, data and programs stored in Flash memory (IPSM) or an optional SD card are not lost. However, the terminal automatically cold boots when you install a fully charged battery pack and you need to reset the real-time clock.

Charging

The internal backup battery charges off the main battery pack and requires eight hours charge time to backup RAM data for 30 minutes. You can begin using the Dolphin terminal after charging the main battery for four hours; however, the internal backup battery will continue to charge off the main battery.

To ensure that the internal backup battery functions properly, maintain a consistent power supply for the first eight hours of terminal operation. This power supply can be external power (using a charging peripheral) or an installed, charged battery pack or a combination of both.

Guidelines

Follow these guidelines to maximize the life of the Dolphin's internal backup battery:

- Keep a charged Li-ion battery pack in the Dolphin terminal.
- Keep the Dolphin terminal connected to a power source when the terminal is not in use.



Resetting the Terminal

There are two ways to reset the Dolphin terminal: a soft reset and a hard reset.

Soft Reset (Warm Boot)

A soft reset re-boots the device without losing RAM data.

You would perform a soft reset 1) when the terminal fails to respond, 2) after installing software applications that require a reboot, or 3) after making changes to certain system settings.



1. Press and hold Red  + ESC  for approximately 5 seconds. The screen turns white and the decode and scan LEDs flash for approximately three seconds.
2. When the reset is complete, the Desktop appears.

Hard Reset (Cold Boot)



A hard reset erases all of the data and applications stored in RAM memory and launches Autoinstall, which re-initializes the terminal.

Hard resets automatically launch a soft reset as part of the boot process.

1. Press and hold Red  + TAB  for approximately 5 seconds. The screen turns white and the decode and scan LEDs light for approximately three seconds.
2. The terminal re-initializes, which re-installs all programs stored in the **IPSMAutoinstall** folder.

Note: Set the time and date after each hard reset to ensure that the system clock is accurate. Tap the date on the command bar to open the Clock setting and set the time and date.



Suspend Mode

Suspend mode suspends terminal operation. The terminal appears to be “off” when in suspend mode. The terminal is programmed to go into suspend mode automatically when inactive for a specified period of time. You can set this time period in the Power setting.



To Put the Terminal in Suspend Mode

Press the Blue  + Backlight  keys.

Note: You should always put the terminal in suspend mode when you change the battery pack; see [Changing the Main Battery Pack](#) on page 3-17.

To Resume Terminal Operation

To resume terminal operation (or “wake” the terminal from suspend mode),

- Press the Blue  + Backlight  keys.

OR

- Press the Scan key .

Troubleshooting Suspend/Resume

If the terminal does not wake when you press the Scan key, the main battery might be too low to resume operation. To check, remove the battery and install a fully charged battery or connect the terminal to a Dolphin charging peripheral.

Changing the Memory Allocation

You can adjust file storage vs. program memory in System Properties.

1. Tap **Start > Settings > Control Panel > Memory** tab.



2. Move the slider to adjust the memory allocation and tap **OK**. The changes take effect immediately.

Format IPSM

“IPSM” stands for Internal Persistent Storage Manager. It’s a folder at the root level of the device. The contents of this folder are stored in non-volatile memory, which means that the data, programs, registry files, and settings stored in this folder persist through cold boots and are not erased. Store those items you would like to keep stored in the terminal on a permanent basis in this folder.

To access the IPSM folder, tap **Start > Programs > Windows Explorer > IPSM**  .

The Format IPSM setting formats the IPSM file system. Think of this like "format c:" on your desktop; it will erase all the files in the specified partition.

Tap **Start > Settings > Control Panel > double-tap Format IPSM**  .



Care and Cleaning of the Dolphin Terminal

When needed, clean the image engine window and the LCD display with a clean, non-abrasive, lint-free cloth. The terminal can be cleaned with a damp cloth.

Dolphin 7600 Terminal Technical Specifications

Operating System	Microsoft Windows CE 5.0
Development Environment	SDK for C/C++, C# and Visual Basic developers for Windows CE 5.0 (Requires Visual Studio 2005 Professional Editions or higher)
Supported Software	PowerNet™ Terminal Emulation (TNVT, 3270, 5250), Hand Held Products MSM (remote device management), and ITScriptNet
Installed Applications	Hand Held Products Power Tools and Demos and ITScriptNet Ready-To-Go applications
CPU	Samsung 2440 400 MHz
Memory	64MB RAM X 128 MB (non-volatile) Memory (standard) 128MB RAM X 128 MB (non-volatile) Memory (optional)
Mass Storage	User-accessible memory expansion slot for SD or MMC flash memory
Display	2.8 in. 1/4 VGA, 240X320, TFT color display
Image Engine	5300SR VGA Area Imager with High-Vis bracket aimer
Keypad	29-key numeric–shifted alpha Backlit Six programmable function keys
Sound/ Voice	On-board speaker and microphone, and compatible with standard headsets
Communications	RS-232/USB connector, IrDA port
Power	Li-ion battery 3.7V / 2200 mAh / 8.1 Wh (standard) Li-ion battery 3.7V / 3240 mAh / 12.0 Wh (optional) Full Shift operation
Charging	5.0V DC input through side access or USB/Serial connector
Charging Peripherals	AC wall adapter and Charge/Communication Cable HomeBase–single-bay terminal charge/communicate Quad Charger–four-slot battery pack charger
WPAN (standard)	Bluetooth Class 2, version 1.2
WLAN (optional)	802.11b/g
WLAN Security	WEP, 802.1x, LEAP, TKIP, MD5, EAP-TLS, EAP-TTLS, WPA-PSK, and PEAP
Co-Located/Operational	Two radios: WLAN/WPAN
Operating Temperature	14° to 122°F (-10° to 50°C)
Charging Temperature	32° to 104°F (0° to 40°C)

Dolphin 7600 Terminal Technical Specifications

Construction	High impact resistant PC/ABS housings Magnesium alloy internal chassis with component shock mounts
Structural	4 ft. (1.2m) multiple drops to concrete, all axis, across operating temperature range
ESD	Air: +/- 12k Vdc Direct: +/- 8k Vdc
Environmental	IP54 rating
Dimensions	7 in. long X 2.7 in. wide X 1.8 in. deep (17.8 cm. long X 6.9 cm. wide X 4.6 cm. deep)
Weight	Approximately 11.7 oz. / 332 g
Regulatory and Compliance	Safety: cUL 60950, NOM, EN60950, BSMI CN14336, CCC GB4943, PSB, SIRIM EMC: FCC Part 15 Class B, ICES-003, EN 301 489-1, EN 301 489-17, EN55022, EN55024, BSMI CNS13438, CCC GB9254, MIC, VCCI, AS/NZS 3548 Radio: FCC 15.247, RSS-210, COFETEL, EN 300 328-1, EN 300 328-2, SRRS ETS 300 328, IDA, SIRIM, MIC, ARIB STD-T33 & T66, AS/NZS 4771



Using the Keyboards

Overview

There are two keyboard options: a 29-key keyboard and the 38-key keyboard.

29-Key Numeric Keyboard







38-Key Alpha Keyboard



The buttons are recessed under the overlay for maximum durability and the panel is backlit for maximum viewability in various lighting conditions.









Suspend/Resume

Both keyboards provide multiple ways to suspend/resume terminal operation.

Suspend	 	Blue + Backlight
Resume		Backlight
		Scan

Function Keys

Function keys appear on both keyboards and perform specific functions.

Name	Key	Function
Backlight		Toggles the keyboard backlight on and off.
Backspace		Backspace moves the cursor back one space. If you are typing text, a character is deleted each time you press the backspace key.
Escape		Cancels an action.
Enter		Performs the same function as the Enter key on a PC or workstation.
Scan		<ul style="list-style-type: none">• Activates the image engine to scan a bar code or take an image.• Wakes the terminal from suspend mode.
Shift 29-key only		Provides shift functionality in application windows and is also the a Caps Lock key when the 29-key keyboard is in alpha mode. <i>Note: On the 38-key keyboard, the Blue modifier key functions as a shift key in both alpha an numeric modes.</i>
Space (SP) 29-key only		Moves the cursor one space forward. If you are typing text, it moves the text one space forward as well. On the 38-key keyboard, you can perform the same function as the SP key by: <ul style="list-style-type: none">• Pressing NUM + E in alpha mode• Pressing E in numeric mode
Tab		Moves the cursor to the next tab stop or field (on a form or application window).

Modifier Keys

Modifier keys modify the next key pressed to perform functions or type special characters.

Name	Key	Function
Blue and Red		Modifies the next key pressed. The overlay of each keyboard is color-coded to indicate the character typed or function performed when the keyboard buttons are pressed in combination with these keys.

For modifier key combinations on the 29-key keyboard:

- See [29-Key Blue Key Combinations \(Alpha Mode\)](#) on page 4-7.
- See [29-Key Red Key Combinations](#) on page 4-8.

For modifier key combinations on the 38-key keyboard:





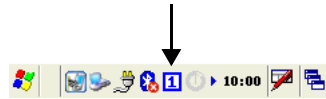

- See [38-Key Red Key Combinations](#) on page 4-10.
- See [38-Key NUM Lock Mode](#) on page 4-11.

Alpha/Numeric Indicator

The command bar on the screen features an icon that indicates the alpha/numeric status of the keyboard.



This icon changes when the keyboard status changes.



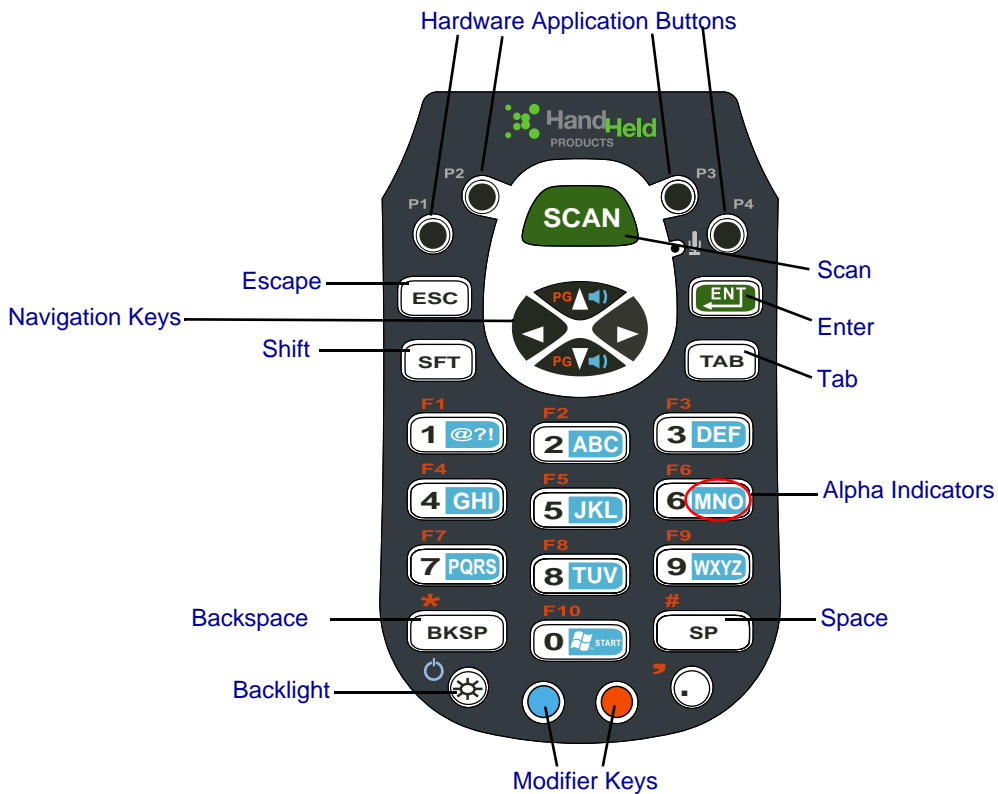

Icon	Keyboard Status
	The keyboard is in lowercase alpha mode only for the next key pressed. The keyboard reverts to the mode it was in prior to the switch for the next key pressed.
	The keyboard is locked in alpha mode.
	The keyboard is in shifted (uppercase) alpha mode only for the next key pressed. The keyboard reverts to the mode it was in prior to the switch for the next key pressed.
	The keyboard is locked in shifted alpha mode.
	The keyboard is in numeric mode only for the next key pressed. The keyboard reverts to the mode it was in prior to the switch for the next key pressed.
	The keyboard is locked in numeric mode.

29-Key Numeric Keyboard



Navigation Keys

Located in the center of each keyboard for easy access with either hand, the navigation keys enable you to move the cursor through application screens.

Key	Description		
	Move the cursor up one row or line. Move the cursor down one row or line.	Volume up or down.	Scroll page up or down.
	Move the cursor one character to the right.		+
	Move the cursor one character to the left.		-

Hardware Application Buttons

These four buttons are programmed to launch software applications from the Desktop.



To customize these settings, tap **Start > Settings > Control Panel > double-tap Buttons**  Buttons .

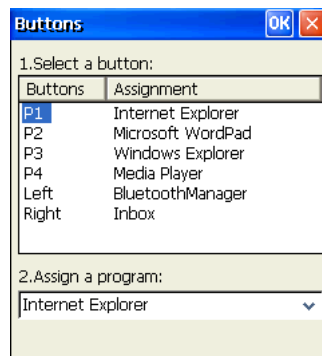

Buttons Column

P1—P4

Left

Right

Matching Hardware Button

Buttons P1—P4 marked on the overlay.

Left side button; see [Side Button](#) on page 3-11.

Right side button; see [Side Button](#) on page 3-11.

Customizing a Hardware Button

1. Select the button you want to modify.
2. Select a program from the **Assign a program** list.
3. Tap **OK** to save all changes and the change is applied immediately.
4. To verify the change, navigate to the Desktop, press the hardware button and verify that the selected application launches.

Toggleing Between Alpha and Numeric Modes

The 29-key keyboard defaults to numeric mode, which means that the keyboard boots up to numeric mode after each hard reset.

Numeric mode is when you type numbers with the number keys. Alpha mode is when you type letters or characters with the number keys. The keyboard switches between alpha and numeric modes easily.

The command bar displays an icon that indicates the status of the keyboard so that you can see which mode you're in when toggling; see [Alpha/Numeric Indicator](#) on page 4-3.

Switching to Alpha Mode

To switch modes, tap the Blue modifier key  as follows:

- Single-tap to switch only the next character pressed to alpha mode.
The keyboard automatically switches back to numeric mode for the next key pressed.
- Double-tap to switch to alpha mode permanently.
Double-tap again to switch back to numeric mode permanently.

Alpha Indicators

Each number key has a blue section with white characters inside it that indicate which letter or symbol is typed when you press that key in alpha mode.

Please note that when typing in alpha mode, you must use the same multi-press method you would use when typing letters on a phone keypad. Each key press types the next letter in the sequence as displayed by the alpha indicator.

Note: You can still use regular Blue key combinations in alpha mode by pressing and holding the Blue modifier key with the next key in the combination. For combinations, see [29-Key Blue Key Combinations \(Alpha Mode\)](#) on page 4-7.

Shift Functionality

In Alpha Mode

When you switch the keyboard to alpha mode, letters type in lowercase by default.

To capitalize letters, tap the SFT key  as follows:

- Single-tap to capitalize only to the next letter pressed.
- Double-tap to turn CAPS LOCK on and off.

In Numeric Mode

Numeric mode is the default keyboard mode. When the keyboard is in numeric mode, tap the SFT key once to produce special characters; see [29-Key Shift Functionality in Numeric Mode](#) on page 4-7.

29-Key Blue Key Combinations (Alpha Mode)

Tap the Blue modifier key to switch to alpha mode for the next key pressed.
Double-tap the Blue modifier key to switch to alpha mode permanently.

Key	Character	Uppercase: Double-tap SFT
1	@ ? ! :	@ ? ! :
2	abc	ABC
3	def	DEF
4	ghi	GHI
5	jkl	JKL
6	mno	MNO
7	pqrs	PQRS
8	tuv	TUV
9	wxyz	WXYZ

Functions

If the keyboard is in numeric mode, tap the Blue key once to achieve the following:

Key Combination	Function
Blue + Up Arrow	Volume up
Blue + Down Arrow	Volume down

29-Key Shift Functionality in Numeric Mode

When the keyboard is in numeric mode (the default state), tap the SFT key once to produce several common characters.

Key	Character
1	!
2	@
3	#
4	\$
5	%
6	^
7	&
8	*
9	(
0)

29-Key Red Key Combinations

Special Characters

Key Combination	Character
Red + Left Arrow	-
Red + Right Arrow	+
Red + BKSP	*
Red + SP	#
Red + .	,
Red + P1	/
Red + P2	=
Red + P3	;
Red + P4	\

Functions

Key Combination	Function
Red + ESC (hold)	Soft reset (warm boot)
Red + TAB (hold)	Hard reset (cold boot)
Red + Up Arrow	Page up
Red + Down Arrow	Page down
Red + 1	F1
Red + 2	F2
Red + 3	F3
Red + 4	F4
Red + 5	F5
Red + 6	F6
Red + 7	F7
Red + 8	F8
Red + 9	F9
Red + 0	F10

38-Key Alpha Keyboard

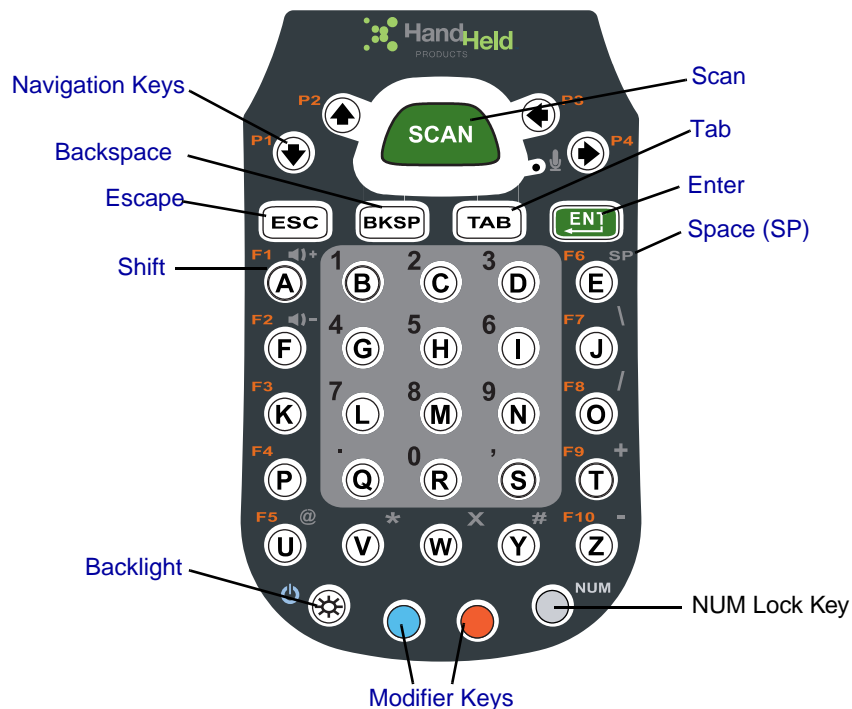

Toggleing Between Alpha and Numeric Modes

The 38-key keyboard defaults to lowercase alpha mode, which means that the keyboard boots up to lowercase alpha mode after each hard reset.

Numeric mode is when you type numbers with the number keys. Alpha mode is when you type letters or characters with the number keys. The keyboard switches between alpha and numeric modes easily.

The command bar displays an icon that indicates the status of the keyboard so that you can see which mode you're in when toggling; see [Alpha/Numeric Indicator](#) on page 4-3.

Shift Functionality in Alpha Mode

- To apply Shift functionality to the next character pressed while in lowercase alpha mode, tap the Blue modifier key once. Shift functionality is removed from the next key pressed automatically.
- To switch into CAPS LOCK mode, tap the Blue modifier key twice. To switch out of CAPS LOCK mode, tap the Blue modifier key twice again.

Switching to Numeric Mode



- To switch to numeric mode for the next key pressed, tap the NUM key once.
- To lock into numeric mode, double-tap the NUM key.
- If locked in numeric mode, double-tap NUM key again to switch back to alpha mode.

For more information about NUM Lock functionality, see [38-Key NUM Lock Mode](#) on page 4-11.

38-Key Red Key Combinations

Key Combination	Function
Red + Down Arrow	P1
Red + Up Arrow	P2
Red + Left Arrow	P3
Red + Right Arrow	P4
Red + Left Side Button	P5
Red + Right Side Button	P6
Red + ESC (hold)	Soft reset (warm boot)
Red + TAB (hold)	Hard reset (cold boot)
Red + A	F1
Red + F	F2
Red + K	F3
Red + P	F4
Red + U	F5
Red + E	F6
Red + J	F7
Red + O	F8
Red + T	F9
Red + Z	F10

38-Key NUM Lock Mode



- To switch to numeric mode for the next key pressed, tap the NUM key once.
- To lock into numeric mode, double-tap the NUM key.
- If locked in numeric mode, double-tap NUM key again to switch back to alpha mode.

Numbers

Key	Character
B	1
C	2
D	3
G	4
H	5
I	6
L	7
M	8
N	9
R	0

Special Characters

Key	Character
J	\
Q	.
S	,
O	/
T	+
U	@
V	*
W	X
Y	#
Z	-

Special Functions

Key	Character
A	Volume up
F	Volume down
E	SP



Using the Image Engine

Overview

The Dolphin 7600 terminal houses a compact image engine using Adaptus™ Imaging Technology that instantly reads all popular 1D and 2D bar codes and supports omni-directional aiming and decoding. The image engine can also capture digital images, such as signatures and pictures of damaged inventory.

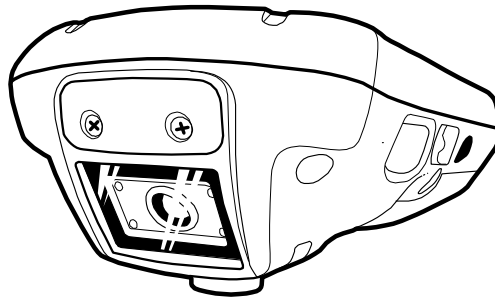

The image engine is angled downward.

Available Image Engines

Dolphin 7600 terminals are equipped with 5300 Standard Range (5300SR) image engines.

Depth of Field

5300 Standard Range (5300SR)

	8.3 mil Linear	10 mil PDF417	13 mil UPC	15 mil Data Matrix	15 mil QR	35 mil MaxiCode
*Working Range:	(.020cm)	(.025cm)	(.033cm)	(.038cm)	(.038cm)	(.089cm)
Near	3.5 in. (8.9cm)	3.1 in. (7.9cm)	2.1 in. (5.3cm)	2.3 in. (5.8cm)	3.1 in. (7.9cm)	2.0 in. (5.1cm)
Far	7.6 in. (19.3cm)	9 in. (22.9cm)	13.2 in. (33.5cm)	10.2 in. (25.9cm)	8.8 in. (22.4cm)	13.0 in. (33cm)

*Data characterized at 23°C and 0 lux ambient light.

Supported Bar Code Symbologies

The Dolphin 7600 image engines support the following bar code symbologies:

Symbology Type	Symbology Name
1D Symbologies	Codabar Code 3 of 9 Code 11 Code 32 Pharmaceutical (PARAF) Code 93 Code 128 EAN with Add-On EAN with Extended Coupon Code EAN-13 GS1 Databar Interleaved 2 of 5 Matrix 2 of 5 Plessey PosiCode Straight 2 of 5 IATA Straight 2 of 5 Industrial Telepen Trioptic Code UCC/EAN-128 UPC and UPC-A
2D Symbologies	Aztec Code 16K Composite Data Matrix GS1 Databar MaxiCode OCR PDF417 QR Code
Composite Codes	Aztec Mesa Codablock F EAN-UCC GS1 Databar-14
OCR	OCR-A OCR-B OCR-US Money Font
Postal Codes	Postnet and most international 4 state codes Australian Post British Post Canadian Post China Post Japanese Post KIX (Netherlands) Post Korea Post Planet Code

Activating the Engine

When a scanning application is open, press the Scan key  to activate the image engine. You can also press one of the side buttons (see [Side Button](#) on page 3-11), which are programmed to activate the image engine in a scanning application by default.

Using Demos

Dolphin Demos are software utilities loaded on all Dolphin terminals that demonstrate the advanced features of the terminal. There are two Demos feature the image engine: Image Demo and Scan Demo.

To access these demos, tap **Start > Programs > Demos**,

- Select **Scan Demo** to verify decoding, or
- Select **Image Demo** to verify imaging.

For more information about Demos, refer to the Dolphin Demos User's Guide, which is available for download from www.handheld.com.

LEDs

The LEDs in the center of both keyboards (for location, see [LEDs](#) on page 4-1) light when using the image engine.

Scan LED The LED on the right lights red when you press the scan trigger in scanning applications.

Decode LED The LED on the left lights green when a scanned bar code is successfully decoded.

Decoding

The Dolphin terminal supports two types of image decoding: full-area imaging and Advanced Linear Decoding (ALD).

Full-area Imaging

Full-area imaging means that the Dolphin terminal support omni-directional aiming, which means that a positive read can be obtained from many positions. For details, see [Omni-Directional Scanning Positions](#) on page 5-4.

ALD

ALD provides fast reading of linear (1D) and stacked linear bar codes (PDF417). For the best read, the aiming pattern should be centered horizontally across the bar code. When ALD is enabled, the reader does not read matrix or postal codes.

To Decode a Bar Code

1. Tap **Start > Programs > Demos > Scan Demo**.
2. Position the Dolphin terminal over one of the sample bar codes on page 5-4. A range of 4–10 inches (10–25 cm) from the bar code is recommended.
3. Project the aiming brackets by pressing and holding the Scan key. The Scan LED lights red.
4. Center the aimer crosshair over the bar code. The aiming beam should be oriented in line with the bar code to achieve optimal decoding; [Omni-Directional Scanning Positions](#), page 5-4
5. When the bar code is successfully decoded, the decode LED lights green and the terminal beeps.

Sample Bar Codes

You can use the following bar codes to verify decoding:

Sample 128



Code 128

Sample PDF417



PDF417 Test Message

Omni-Directional Scanning Positions

The high-vis aiming pattern frames the bar code to provide you with the best scanning performance.

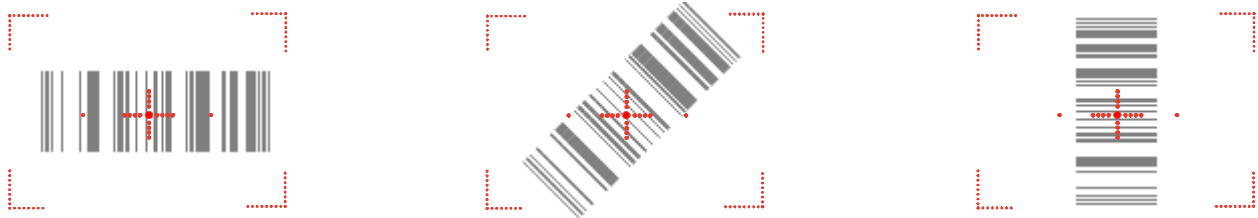

Note: To achieve the best read, the aiming beam should be centered horizontally across the bar code.

The aiming pattern is smaller when the terminal is held closer to the code and larger when the terminal is held farther from the code. Symbologies with smaller bars or elements (mil size) should be read closer to the unit whereas larger bars or elements (mil size) should be read farther from the unit.

Capturing Images

The image-capture process is an intuitive, split-second operation for experienced users. By following basic guidelines, however, new users can easily develop their own technique and, with practice, quickly learn to adapt to different application environments.

Image Preview

When the imaging process is initiated, the touch screen displays a preview of the object. This is a live video image of what the imager is currently viewing and has a slightly degraded appearance compared to the captured image. This is normal; the captured image has a higher resolution.

File Formats

The Dolphin terminal is capable of saving images in a number of industry-standard file formats such as *.bmp, *.jpg and *.png. The default file format for images is a grayscale *.jpg.

File Size

Digital images have a maximum image size of 640 x 480 pixels and may have up to a 256 grayscale image definition. The image quality and related file size are determined by the data compression method used by the software application used to take the image. The average size of the image file is approximately 4–8K. However, the size of the image depends on image content, the more complex the content, the larger the file size.

Taking an Image

1. Tap **Start > Programs > Demos > Image Demo**.
2. Point the Dolphin terminal at the object.
3. Press the Scan key to activate the engine. The touch screen displays a preview of the object.
4. Adjust the terminal's position until the preview on the screen appears as you want it to appear in the image.
5. Hold the terminal still and release the Scan key.
The touch screen flashes, and the captured image appears on the screen.
6. By default, the image is saved to the My Device folder (from the Desktop, tap **My Device** ). To save the image to another location, tap **File > Save As**.

High-Vis Aiming Pattern

If your Dolphin terminal is configured with the 5300SR imager, you can enable the aiming pattern for imaging in the Image Demo application.

1. Tap **Start > Demos > Imaging Demo > Options menu > Aimer**.
2. The aiming pattern is now enabled for imaging.

Uploading Images

Image files can be transmitted to a host workstation via

- Microsoft ActiveSync and a Dolphin communication peripheral
- Wireless radio: 802.11b/g and/or Bluetooth



Communication Options

Dolphin terminals offer several communication options including Microsoft ActiveSync, infrared, and wireless radios.

I/O Connector (Wired Communication)

The mechanical connector on the bottom panel (see [I/O Connector](#) on page 3-14) connects the terminal to various Dolphin communication peripherals that connect to a host workstation via USB (1.1 or higher), thus enabling ActiveSync communication.

For more information, see [ActiveSync Communication](#) on page 6-3.

Wireless Radios (Wireless Communication)

Dolphin 7600 terminals can be equipped with an 802.11b/g or Bluetooth radio or a combination of these radios.

For more information, see [Wireless Radios](#) on page 6-6.

IrDA Port (Wireless Communication)

The IrDA port enables the Dolphin to transmit data via pulses of infrared light to and from other IrDA-compliant devices, such as printers, workstations, and even other Dolphin terminals.

For more information, see [Infrared Communication](#) on page 6-8.

Installing Additional Software

Dolphin terminals ship with the operating system, radio drivers, and custom Hand Held Products software loaded onto the device. These are the default programs that install when your terminal first boots up. You can install additional software programs to the terminal provided that the following parameters are met:

- the software program was created for a Windows CE device.
- The terminal has enough memory to store and run the program.
- The program has an *.exe, *.cab, or *.dll extension.

When selecting programs, verify that the program and version of the program are designed for the Windows CE 5.0 and the terminal's processor. You can verify your processor by tapping Start > Settings > Control Panel > System > General tab. Make a note of the information in the Processor field.

To install additional software, you can use the communication options described in this chapter.

- [Adding Programs via ActiveSync](#), page 6-5.
- [Adding Programs From the Internet](#), page 6-7.

Connecting the USB Cable

Connect the USB cable to the I/O connector to facilitate USB communication between the Dolphin device and host workstation.

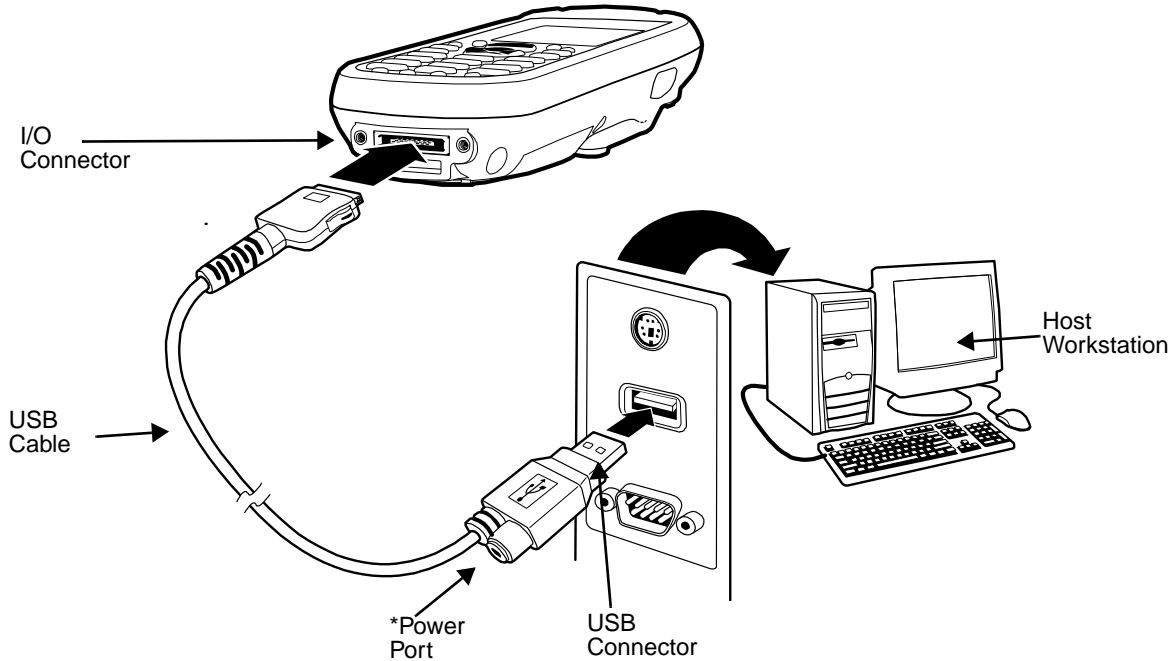

*This is a communication-only cable until you plug the power cable into the power port.

Connecting the Power Cable

The power port on the back end of the USB connector fits the power cable that comes with each Dolphin 7600 device. To charge the device while communicating, connect the power cable to the power port.

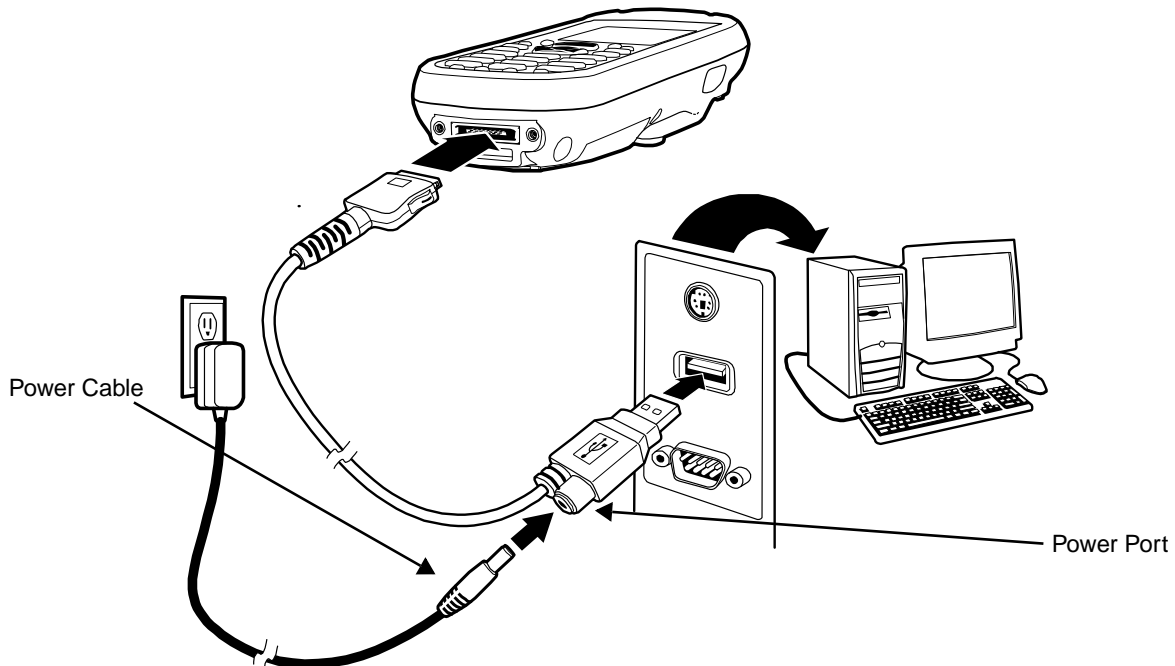

ActiveSync Communication

To synchronize, ActiveSync 4.1 or higher must be installed and configured for the appropriate communication type on the host workstation and the Dolphin terminal. Dolphin terminals ship with ActiveSync already installed. Therefore, if ActiveSync is already installed on the host workstation, you just need to connect the Dolphin terminal to the host workstation (via Dolphin peripheral) to initiate communication.

If ActiveSync 4.1 or higher is not installed on the host workstation, install it from the Microsoft Companion CD that came with the Dolphin terminal. Insert the CD into the CD-ROM drive of the host workstation and click the **yellow arrow**, then **Start Here**, and follow the directions on your screen.

Note: You can also download the most current version of ActiveSync from www.microsoft.com and install.



When communicating via ActiveSync, your terminal must be connected to the host workstation with a communication peripheral sold/manufactured by Hand Held Products, such as the Dolphin HomeBase or Dolphin Charge/Communication cable. Use of any peripheral not sold/manufactured by Hand Held Products may damage your terminal and will void the warranty.

Communication Types

The Dolphin 7600 supports the following types of communication via ActiveSync through its **I/O Connector** (see page 3-14) on the bottom panel:

USB

The USB cable and hardware peripherals allow the Dolphin terminal to communicate with a workstation or to networked through a USB hub. The Dolphin terminal supports full-speed USB communication (USB 1.1); maximum data transfer rate is 12 Mbps. The Dolphin terminal defaults to USB communication out of the box.

RS-232

The RS-232 cable allows the Dolphin terminal to communicate with a workstation, modem, or any RS-232 device. Maximum data transfer rate is 115 Kbps.

Hardware Requirements for Setup

- Dolphin HomeBase or Dolphin communication cable
- Dolphin power cable from Hand Held Products
- USB Cable (for USB communication)
- Serial Cable (for RS-232 communication)
- ActiveSync v4.1 or higher installed on the host workstation
- Windows 98 Second Edition, Windows Me, Windows 2000, Windows NT (4.0 SP6 or higher) or Windows XP computer.

Software Requirements for Communication

To sync successfully, ActiveSync must be configured for same communication type on both the host workstation and the Dolphin terminal. ActiveSync must be setup on your workstation *before* you initiate synchronization from the terminal for the first time.

Setting Up the Host Workstation

Verify that ActiveSync is configured to use the appropriate communication type by clicking **File > Connection Settings**.

For USB communication, check **Allow USB connections**.



For RS-232 communication, connect to **COM1**.



Note: You can have both USB and RS-232 selected in the software without affecting processing. However, your hardware setup should use only RS-232 or USB, not both.

Setting Up the Dolphin Terminal

The Dolphin terminal defaults to USB communication out of the box. To verify and/or change the default setting, tap **Start > Settings > Control Panel > PC Connections.**)

Must be checked to connect with a workstation.

Displays the current connection setting.

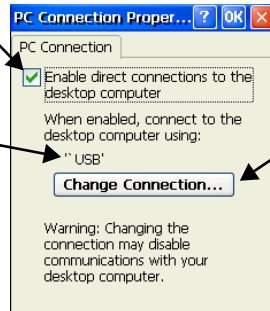

Tap to change the connections settings.

Tap **Change Connection** to change the current settings.

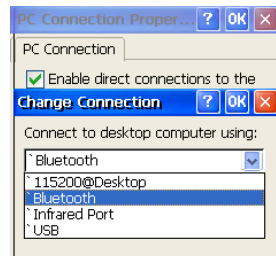

Connection Options

'115200@Desktop

Bluetooth

'Infrared Port

'USB

Select this option to ...

Establish an RS-232 connection.

Establish an ActiveSync connection via Bluetooth; see [Bluetooth ActiveSync](#) on page 7-10. This menu item is present only when Bluetooth has been activated.

Establish an ActiveSync connection via the [IrDA Port](#) (see page 3-11).

Establish a USB connection.

Communicating with the Dolphin Terminal

After setting up both the workstation and the terminal, ActiveSync connection should be automatic.

1. Connect the Dolphin terminal to the a communication peripheral, such as the Dolphin HomeBase.
2. The Dolphin terminal automatically opens ActiveSync to establish a connection.

Synchronizing with the Host Workstation

After setup, synchronization begins automatically whenever the terminal's mechanical connector connects to a Dolphin peripheral that is connected to a host workstation with ActiveSync installed.

Exploring the Terminal from the Workstation

When the terminal and desktop computer are connected, open the main ActiveSync window (on the desktop), and click **Explore**.



The Mobile Device folder opens in Windows Explorer.

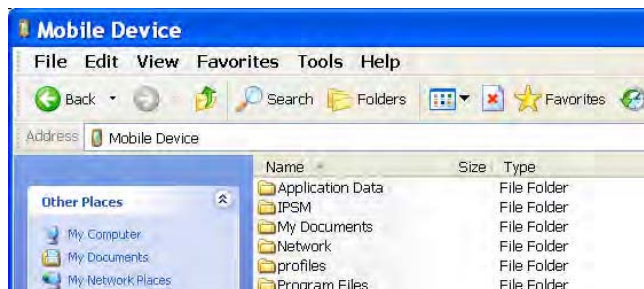

The Dolphin terminal is now treated as a mass storage device, and transferring files is as simple as dragging and dropping or copying and pasting as you would for moving files between folders on your hard drive.

Adding Programs via ActiveSync



When selecting programs, verify that the program and version of the program are designed for the Windows CE 5.0 and the terminal's processor. You can verify your processor by tapping Start > Settings > Control Panel > System > General tab. Make a note of the information in the Processor field.

Generally, software for Windows CE devices must be installed to the host workstation first, then transferred to the Dolphin terminal.

1. Download the program to the workstation from either the Internet or the install CD. You may see a single *.exe or setup.exe file, a *.cab file, or *.dll. (There may also be several versions of files for different device types and processors.)
2. Read any installation instructions, Read Me files, or documentation that comes with the program. Many programs provide special installation instructions.
3. Connect the terminal to the workstation via Hand Held Products communication peripheral.

If the File is an Installer

An installer program is one that installs to the workstation and the terminal simultaneously; one process installs to both devices.

1. On the workstation, double-click the *.exe or *.setup.exe file. The installation wizard begins.
2. Follow the directions on the workstation screen.
The installation process includes transferring the software to the terminal via ActiveSync.

If the File is Not an Installer

Some programs cannot be installed on workstations because they are designed exclusively for Windows CE devices. In these cases, the appropriate files must be stored on the host workstation and transferred to the terminal via ActiveSync Explore.

Note: You know that the program is not an installer because an error message stating that the program is valid but designed for a different type of computer appears when you try to install the program on the workstation.

1. If you cannot find any installation instructions for the program in the Read Me file or documentation, open **ActiveSync** on the workstation and click **Explore**.
2. On the workstation, navigate to the workstation folder containing the program file(s) and copy them to the **Program Files** folder on the terminal.
If you want the program to persist through hard resets, past the program to the **Autoinstall** folder (`\IPSM\AutoInstall`).



3. On the terminal Desktop, tap **My Device** and, in Windows Explorer, navigate to the folder where the program is located.
4. Double-tap on the program file to install it.
If you copied the file to the **Autoinstall** folder, you can choose to install the program by performing a hard reset. The program installs as part of initialization.
5. After installation is complete, access the program by tapping **Start > Programs** and the program appears on the Programs screen. Tap the icon to open the program.

Wireless Radios

There are two radio options: 802.11b/g and Bluetooth.

1. **802.11b/g**: see [WLAN \(802.11b/g Radio\)](#) on page 6-6.
2. **Bluetooth**: see [Bluetooth Manager](#) on page 7-1.

Connecting the Terminal to a Wireless Network

You connect the terminal to a wireless network through the on-board radio (802.11b/g and/or Bluetooth). Each radio has its own configuration program and requires specific information about the wireless network to connect. Successful connection depends heavily on your network infrastructure about which you will need specific information from your network administrator.

WLAN (802.11b/g Radio)

Dolphin 7600s can have a 2.4 GHz 802.11b/g WLAN (Wireless Local Area Network) radio that uses Direct Sequence Spread Spectrum (DSSS) technology. The radio is interoperable with other 802.11b/g, Wi-Fi-compliant products including access points (APs), PCs via PC card adapters, and other wireless portable devices.

By default, the 802.11b/g radio is enabled after each hard reset, which means that the radio begins transmitting a signal as soon as the terminal finishes booting up. The next step is to configure the connection parameters of the radio to connect to a wireless network.

Configuring the WLAN Radio

The WLAN radio is configured in the Hand Held Products WLAN Security Supplicant which you access by double-tapping the program icon in the command tray on the Today screen .

For complete configuration instructions, download the **Hand Held Products WLAN Security Supplicant User's Guide** from www.handheld.com. A link to the **Hand Held Products WLAN Security Supplicant User's Guide** appears on the Dolphin 7600 product page.

Adding Programs From the Internet

When you have established a network connection (whether via modem or wireless radio), you can access the Internet and download additional software programs.

When selecting programs, verify that the program and version of the program are designed for Windows CE 5.0 and the terminal's processor. You can verify your processor by tapping Start > Settings > Control Panel > System > General tab. Make a note of the information in the Processor field.

1. Open Internet Explorer and navigate to the program's location. You may see a single *.exe or setup.exe file, or several versions of files for different device types and processors.
2. Select the program version that matches your Dolphin terminal and processor.
3. Read any installation instructions, Read Me files, or documentation that comes with the program. Many programs provide special installation instructions.
4. Download the program to the terminal straight from the Internet.
You would normally store the program in the **\Program Files** folder unless another location is required by the program.
5. On the terminal, double-tap the installer file; e.g., the *.exe file.
6. The installation wizard for the program begins.
7. Follow the directions on the screen to complete installation.

Infrared Communication

The BT Service tab beams files and data between the terminal and other devices equipped via the IrDA port. The maximum data transfer speed is 115 Kbps.

IrDA Port Location

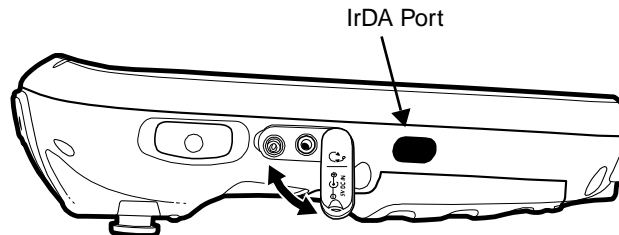

Transferring Files and Information

Note: We recommend disabling the Bluetooth radio before transferring data via infrared. If the Bluetooth radio remains enabled, the Beam File function will pick up MAC addresses as well as IrDA ports.

1. Arrange the hardware so that the infrared port of the Dolphin terminal is aligned with and in range of the infrared port of the other device.

2. Tap the Bluetooth icon  to open the Bluetooth Manager and tap on the [BT Service Tab](#) (see page 7-2).

3. Tap **Beam File**.
OR
Tap **Start > Programs > Beam File**.

4. The device begins scanning for IrDA enabled devices and displays them on the screen with the device ID and "[IrDA]."

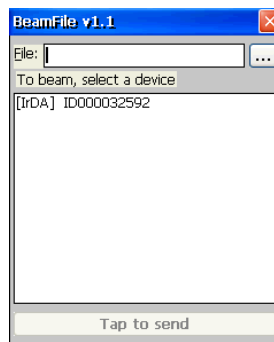

5. Tap  to browse for a file to transfer. Navigate to the file location, select it, and tap **OK**. The name of the file path appears in the **File** field.

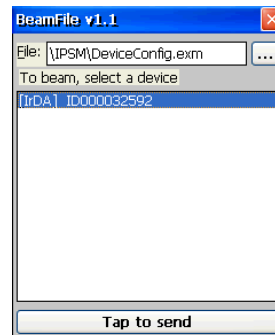
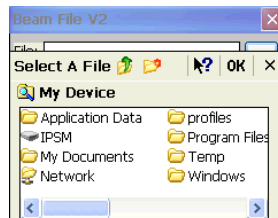

6. Select a device in the list and tap **Tap to Send**.
7. As the file gets ready to send, the button at the bottom reads "Pending..."

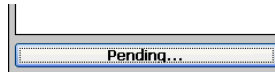

8. While the file is transmitting, the button at the bottom reads "Sending..." and the command bar displays the percentage sent.

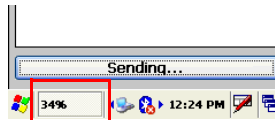

9. When the file is sent, a Success message displays. Tapping **OK** brings you back to the BT Service tab.

Using ActiveSync for IrDA Communication

1. Align the IrDA ports of the Dolphin terminal and a host workstation.

2. Tap **Start > Control Panel > ActiveSync**  ActiveSync.



3. Tap **IrDA Sync**. The IrDA sync process begins immediately.



Overview

Each Dolphin 7600 contains a Bluetooth radio whose driver installs each time the device boots up.

Enabling the Bluetooth Radio

Single-tap the Bluetooth icon in the command bar  or

Tap **Start > Programs > Bluetooth Manager** and tap the **ON** button to activate the Bluetooth radio.

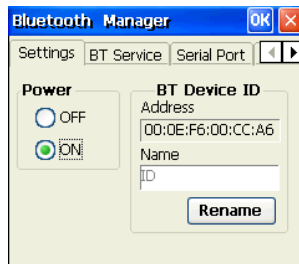

Use the left and right arrows in the upper right corner to scroll through the tab windows.

Tab Window	Description	See Page
Setting Tab	Enables and disables the Bluetooth radio.	7-2
BT Service Tab	<ul style="list-style-type: none"> Scans for Bluetooth services on other devices (see page 7-8). Transfers files via infrared (see page 6-8). 	7-2
Serial Port Tab	Manages the registration of serial ports, both client and server ports.	7-3
About	Displays information about the Bluetooth Manager software.	N/A

Setting Tab

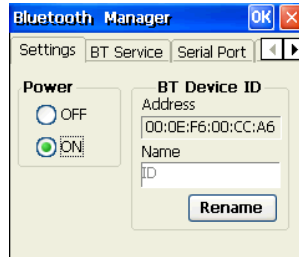

Field	Description
Power	This setting enables and disables the radio.
BT Device ID	
Address	The MAC address from the radio driver.
Name	The first time you open the Bluetooth manager, the default name of the Dolphin device appears.
Rename	Click this button to type in a unique name for the Dolphin terminal. The name change here is not specific to Bluetooth. When you change the name here, it has the same effect as changing the name in the control panel for the whole device (Start > Settings > Control Panel > System > Device Name tab).

BT Service Tab

You scan for other Bluetooth devices on the BT Service tab.

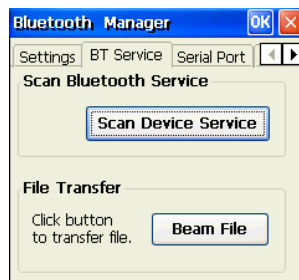

Serial Port Tab

On the Serial Port tab, you can register virtual COM server ports used by the Dolphin terminal to host its Bluetooth services. You can also register client ports used by the Dolphin terminal to access the Bluetooth services of other devices.

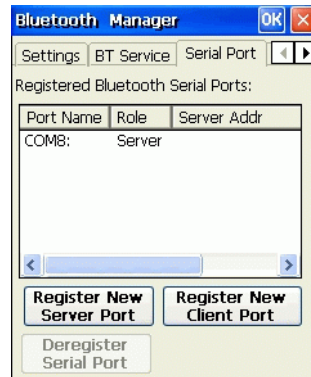

Field	Description
Registered Bluetooth Serial Ports: This list contains the current COM ports in use.	
Port Name	Displays the name of the port (e.g., COM1–COM9).
Role	Identifies the COM port as a server or client COM port.
Server Address	For client ports, this field displays the server address.
Register New Server Port	Tap this button to register a virtual COM port used by the Dolphin terminal to host its Bluetooth services.
Register New Client Port	Tap this button to register a client port used by the Dolphin terminal to access a Bluetooth service on another device.
Deregister Serial Port	Select a port in the list and tap this button to deregister the port.

Connecting to Bluetooth Printers

To connect to a Bluetooth printer, you need to register that printer as a new client port on the Serial Port tab.

1. In the Bluetooth Manager, tap the **Serial Port** tab and tap **Register New Client Port**.



2. The terminal automatically scans for devices in range and displays them.



3. Tap the printer you want to connect to.
4. Authenticate only if the printer has a PIN or if a PIN is known. (Most printers don't have a PIN.)



-
5. Select **Serial Printer** and tap **OK**.



6. Select **COM** from the **COM Prefix** drop-down list.



7. Select the appropriate COM port number from the **COM Index** drop-down list.

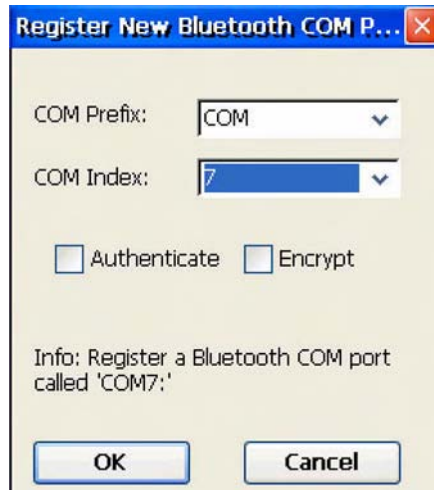

-
8. Tap **OK**. When you have successfully connected, a Registered O.K. dialog box appears.



9. On the Serial Port tab, verify that the COM port is connected to the printer. (The MAC address of the printer will appear in the **Server Addr** column.)



Connecting to Other Bluetooth Devices

1. Power on the Bluetooth radio and tap the **BT Service Tab**.

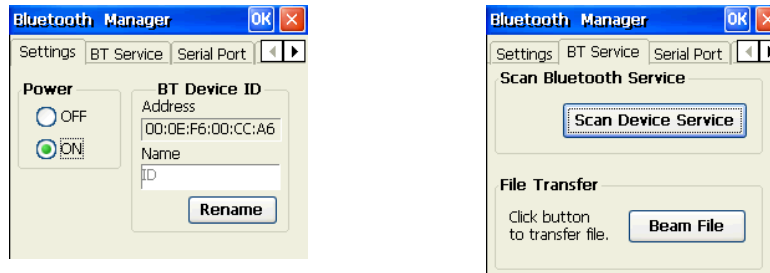

2. Tap **Scan Device Services**, then **Scan Device** on the Scan Device window. The Bluetooth Manager scans for Bluetooth devices and services in range and displays them on the Scan Device Window.

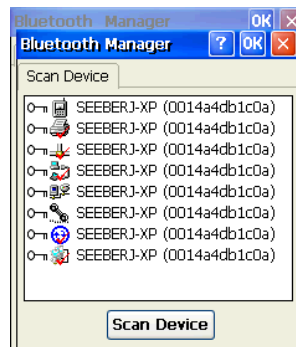

Note: To see a list of what the icons on this window mean, see [Scan Device Window](#) on page 7-8.

3. Double-tap on one of the services and select **Trusted**.



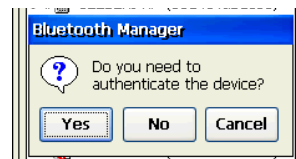

4. Authenticate if required by the device.

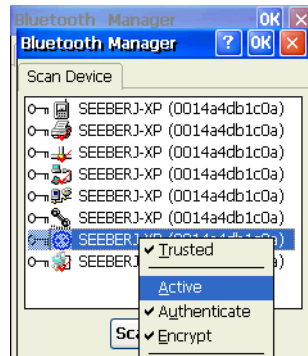

5. If you tap **Yes**, enter the same PIN on both the Dolphin terminal and on the device you're connecting to. If you don't need to authenticate, tap **No** and you return to the list of retrieved devices and services on the Scan Device window.
6. The key icon changes to indicate that the device is now Trusted. (All the device's services will be Trusted the next time they are retrieved in a scan.)

7. On the Scan Device window, double-tap on the same service and select **Active** on the popup menu. The service must be active to use as a wireless connection.





8. The service will now appear with a checkmark to indicate that it's an active connection .









Note: For more information about the popup menu, see [Popup Menu](#) on page 7-9.

Scan Device Window

Found devices appear with a key icon that indicates whether it's a trusted or untrusted device.

-  Indicates Untrusted
-  Indicates Trusted



Found devices also appear with icons to indicate what kind of service is on that device.

Service Icon	The found device contains the following service:
	ActiveSync For details, see Bluetooth ActiveSync on page 7-10.
	Printer For details, see Connecting to Bluetooth Printers on page 7-4.
For details about connecting to the following services, see Connecting to Other Bluetooth Devices on page 7-7.	
	File transfer
	LAN (Local Area Network) access
	Modem (DUN: Dial-up Network Profile)
	Object transfer
	PAN (Personal Area Network)
	Unknown

Popup Menu

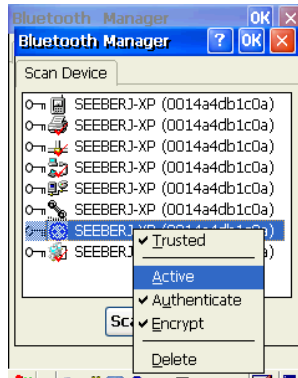
Double-tap on a found device and a popup menu appears that enables you to connect to that device and use the service.



Menu Item	Description
Trusted &/or Untrusted	Changes the found device to a trusted or untrusted device. Untrusted devices Appear with a  icon. Trusted devices Appear with a  icon. Depending on the device and service selected, you may need to authenticate when changing an untrusted device to a trusted device.
Active	Select Active to activate a connection to the device and service. Active appears inactive is the device is not Trusted. A checkmark appears next to this item if the connection is active.
Authenticate	Select Authenticate to require the Dolphin terminal to authenticate on connecting. Authenticate appears inactive is the device is not Trusted. Authenticate appears with a checkmark to the left if authentication has already occurred.
Encrypt	Encrypt appears inactive if the device is not Trusted. Encrypt with a checkmark to the left if encryption has already occurred.
Delete	Deletes the found service. (Other services available on the same device remain in the list.)

Bluetooth ActiveSync

1. On the BT Service tab, tap **Scan Device Service** and retrieve a device with ActiveSync services .
2. You need to activate the service. Double-tap on the service and select **Trusted**, then **Active** on the popup menu.

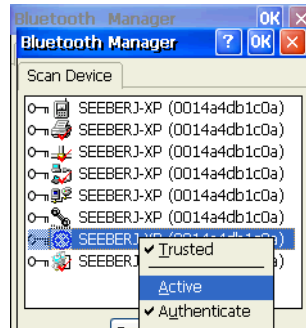

Note: You may need to authenticate the connection by entering a PIN. If not, tap No on the authentication popup window. For more details, see [Connecting to Other Bluetooth Devices](#) on page 7-7.

3. The Bluetooth ActiveSync service is now active. Tap **OK** to close the Scan Device window.

4. Tap **Start > Settings > Control Panel > double-tap ActiveSync**  ActiveSync.

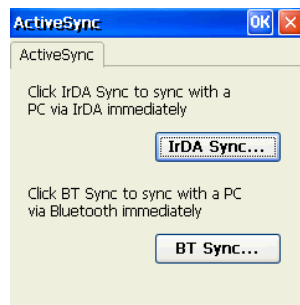

5. Select **BT Sync**. The PC Connection is changed to Bluetooth and the sync process begins just like a normal ActiveSync connection.

Overview

As the hub of your Dolphin 7600 system, the Dolphin HomeBase charging and communication cradle supports full-speed USB 1.1 communication with a workstation. You can also purchase a serial RS-232 Dolphin HomeBase.

Battery Charging

The HomeBase completes a full charge of the main battery pack in less than four hours.

In addition to charging, the HomeBase powers the intelligent battery charging system in the terminal that protects the battery from being damaged by overcharging. The terminal senses when a battery pack is fully charged and automatically switches to a trickle charge that maintains the battery at full capacity.

As a result, Dolphin terminals may be stored in the HomeBase indefinitely without damage to the terminals, battery packs, or peripherals.

Communication

The Dolphin HomeBase can communicate via USB or serial RS-232. Data transmission for USB is up to 12 Mbps. Data transmission for serial RS-232 is up to 115 Kbps.

HomeBases cannot be physically connected to each other—sometimes referred to as “daisy-chaining”—but can be networked together via serial or USB hubs.

Convenient Storage

The battery charging system makes the HomeBase a safe and convenient storage receptacle for your Dolphin terminal.

Capacity

The HomeBase holds one Dolphin 7600 terminal and charges its battery pack.

Power Supply

The power cable that ships with each unit (see [Charge the Batteries](#) on page 2-1) also powers the Dolphin HomeBase.



Use only the peripherals, power cables, and power adapters from Hand Held Products. Use of peripherals, cables, or power adapters not sold/manufactured by Hand Held Products will void the warranty and may damage the terminal.



Use only the Li-ion battery packs provided by Hand Held Products. The use of any battery pack not sold/manufactured by Hand Held Products in a Dolphin terminal will void your warranty and may result in damage to the Dolphin terminal or bat

Front Panel

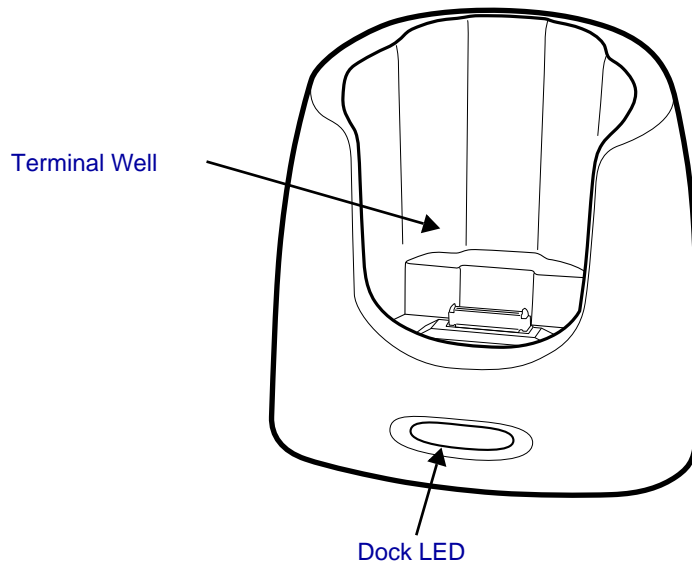

Terminal Well

Place the Dolphin terminal in this well to communicate with a host device, power the terminal, and charge its battery.

Dock LED

Turns solid green when the Dolphin terminal is properly seated in a powered HomeBase. When this light is on, the terminal is connected to the HomeBase.

Rubber Feet

The bottom panel has four rubber feet—one at each corner—to stabilize the unit on a flat surface. You can set the HomeBase on a dry, stable surface, such as a desktop or workbench near an electrical outlet.

Back Panel

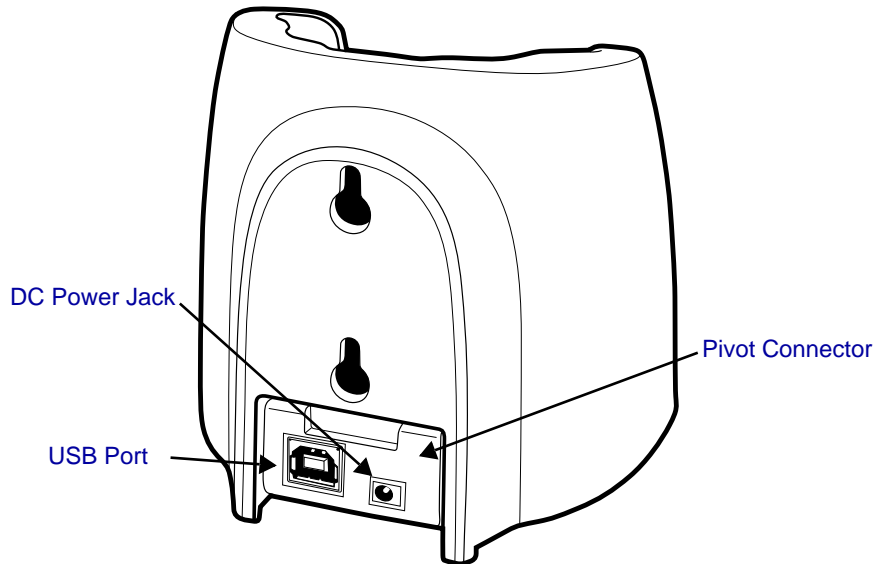

Pivot Connector

This pivoting connector swivels 90 degrees. The default position is horizontal, with the connectors facing straight out the back panel. The pivot connector stops in both the horizontal and vertical positions, with the connectors facing out the bottom panel.

DC Power Jack

Connect the power cable to this power jack; see [Powering the Dolphin HomeBase](#) on page 8-3.

USB Port

This USB port is full-speed (v1.1). Using the USB cable, you can connect the HomeBase to a USB-compliant device to facilitate USB communication to and from the terminal. USB communication occurs through Microsoft ActiveSync (v.4.1 or higher). For more information about ActiveSync setup, see [ActiveSync Communication](#) on page 6-3.

Note: You can also purchase a serial HomeBase with a standard DB9 connector for RS-232 communication.

Powering the Dolphin HomeBase

The terminal requires 5 volts DC input for communication and battery charging; the power adapter on the power cable converts the voltage from the power source to 5 volts DC. Only power adapter cables from Hand Held Products convert the voltage appropriately.

The same power cable that ships with each terminal can be used to power the HomeBase. This cable contains a plug adapter for each geography (US, UK, EU, etc.).

1. Attach the appropriate plug adapter to the power adapter.
2. Plug the power cable into the power source.
3. Plug the connector into the DC power jack on the back panel.
The HomeBase is now powered.

When a terminal is properly seated in the terminal well, the HomeBase powers the terminal, charges the terminal's main battery pack, and launches ActiveSync (see [ActiveSync Communication](#) on page 6-3).

Hand Held Products recommends that you leave the HomeBase connected to its power source at all times, so that it is always ready to use.

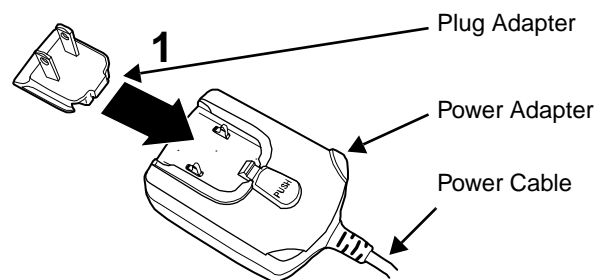

Charging the Main Battery

The HomeBase powers the terminal and fully charges its main battery pack in less than four hours.

As battery packs charge, the charging circuitry follows the two-step charging process (CC-CV) that is recommended for Li-Ion batteries. The process monitors changes in temperature, current, and voltage.

Inserting a Terminal

1. Install the battery pack in the terminal; see [Install the Main Battery](#) on page 2-1.
2. Power the Dolphin HomeBase; see [Powering the Dolphin HomeBase](#) on page 8-3.
3. Slide the terminal into the terminal well until the Dock LED lights green to indicate that the terminal is properly seated.
4. The battery pack begins charging.

Checking Battery Power

To check battery power while the terminal is operating, tap **Start > Settings**

> **Control Panel** > double-tap **Power**  Power .

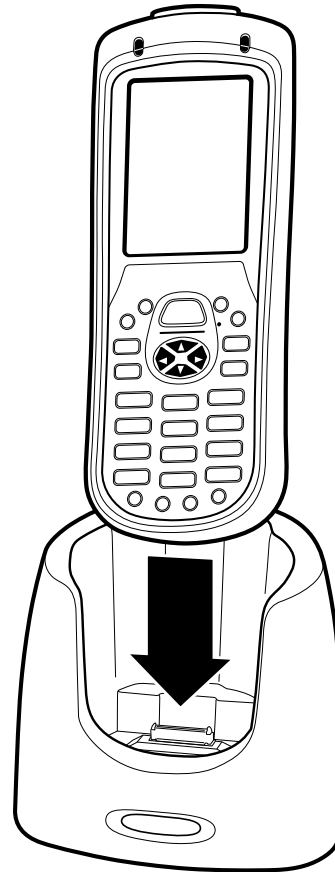
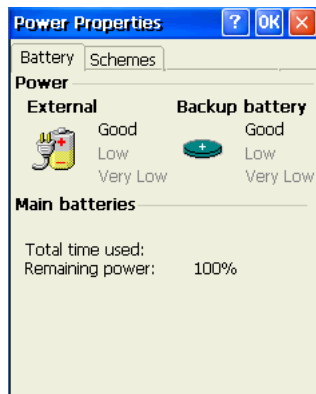

Mounting the Dolphin HomeBase

If you want to mount the HomeBase to a vertical surface, be sure to provide enough workspace with good lighting for the user to view and operate the Dolphin terminal while it is seated in the HomeBase.

Back Panel Dimensions

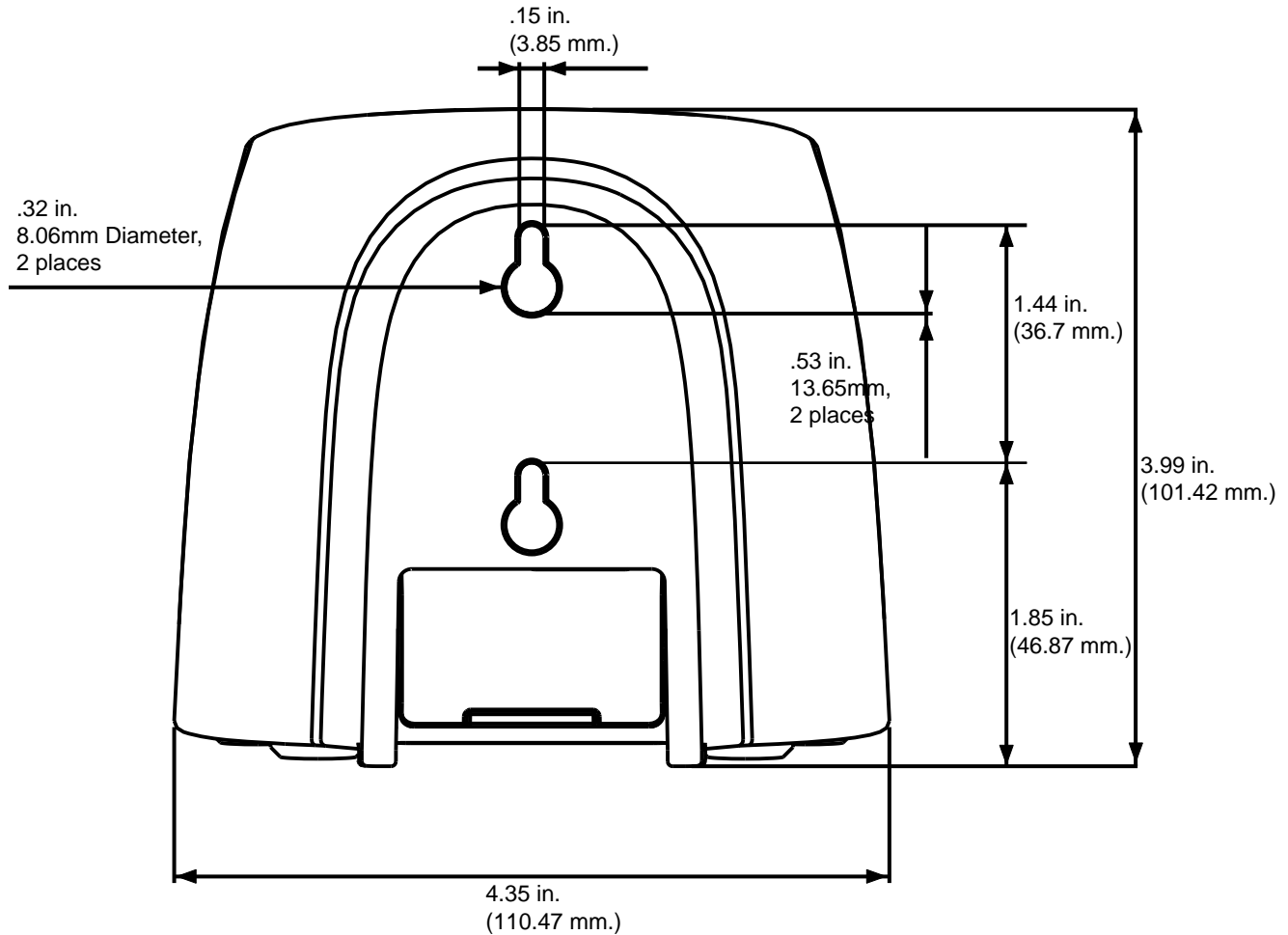

Mounting Guidelines

1. Before you begin, make sure you have two screws that are size #4—diameter measurement of 0.112 in. (2.845 mm).
2. Drill two holes into the wall. The holes should be located approximately 1.44 in. (36.7 mm) apart.
3. Insert a screw into each hole, leaving 0.2 in. (5 mm) of its head exposed.

Bottom Panel Dimensions

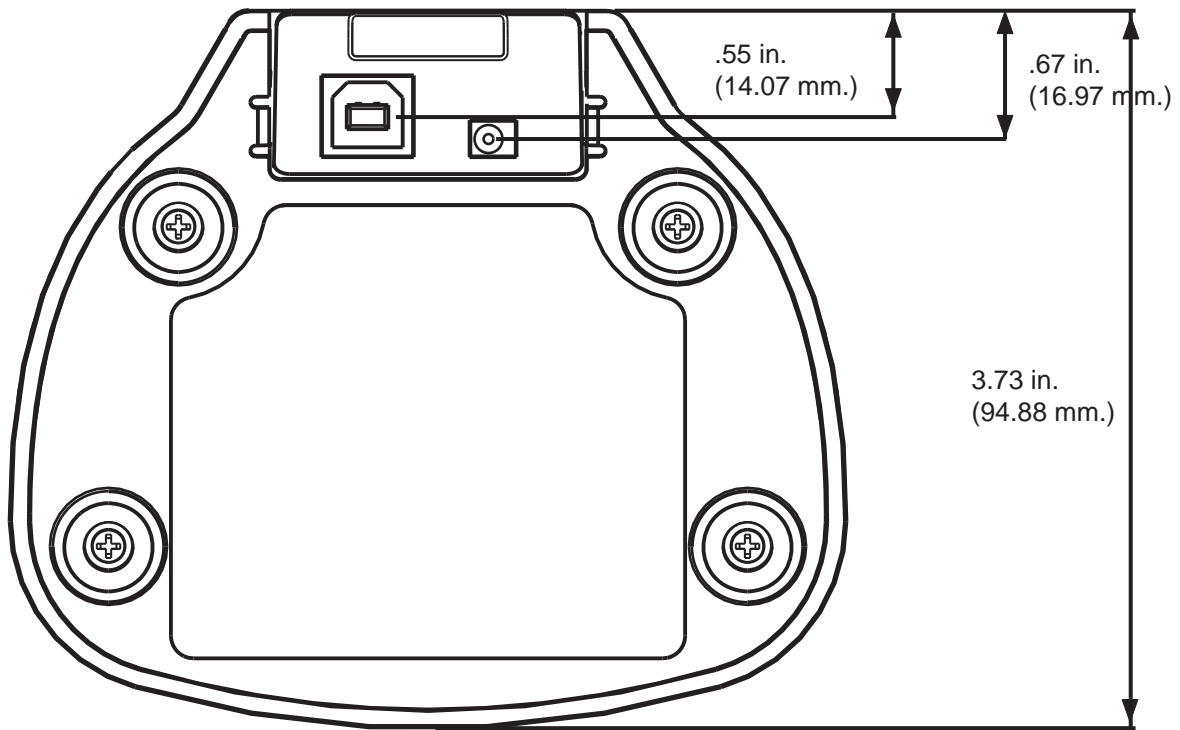

Note: The pivot connector should be facing straight out the bottom panel (as shown) when mounting the HomeBase to a vertical surface.

Dolphin HomeBase Technical Specifications

Structural	
Dimensions	4 in. high X 4.4 in. wide X 3.7 in. deep (10.2 cm. X 11.2 cm. X 9.4 cm.)
Weight	11.2 oz. (318g)
Material	Polycarbonate ABS blend
Color	Gray
Mounting	Two keyholes on the back panel for wall-mounting
Capacity	One Dolphin terminal
Environmental	
Operating Temperature	32° to 104°F (0° to 40°C)
Storage Temperature	-4° to 140°F (-20° to +60°C)
Charging Temperature	32° to 104°F (0° to 40°C)
Electrical Static Discharge	8 KVA immunity on all surfaces
Humidity	90% relative humidity (non-condensing)
Power Supply	
Input (Universal) (from the power source)	100–240 Volts, 0.5 A 50–60Hz Included with Dolphin terminal
Output (to the HomeBase)	5 Volts DC, 3.0 A
Charging	
Standard Charge	Four hours or less
Max Charging Current	2A Max
Standby Current	<100mA
Status LED	Green: Dolphin terminal is properly seated in the HomeBase.
Communication	
Interface	USB B Male connector supports data transmission of up to 12 Mbps OR Standard DB9 serial connector supports data transmission up to 115 Kbps
Agency Approvals	
Power Supply:	UL listed TUV licensed Power Supply compliant to FCC part 15, Class B
Charging:	CE Marking (EMC)
Fire Retardant:	UL 94-VO

Dolphin QuadCharger

Overview

The Dolphin QuadCharger is a four-slot charging station that charges up to four Li-ion battery packs—both 2200mAh and 3240mAh—in four hours. For more details about charging, see [Battery Charging](#) on page 9-3.



Use only the peripherals, power cables, and power adapters from Hand Held Products. Use of peripherals, cables, or power adapters not sold/manufactured by Hand Held Products will void the warranty and may damage the terminal.



Use only the Li-ion battery packs provided by Hand Held Products. The use of any battery pack not sold/manufactured by Hand Held Products in a Dolphin terminal will void your warranty and may result in damage to the Dolphin terminal or bat

Front Panel

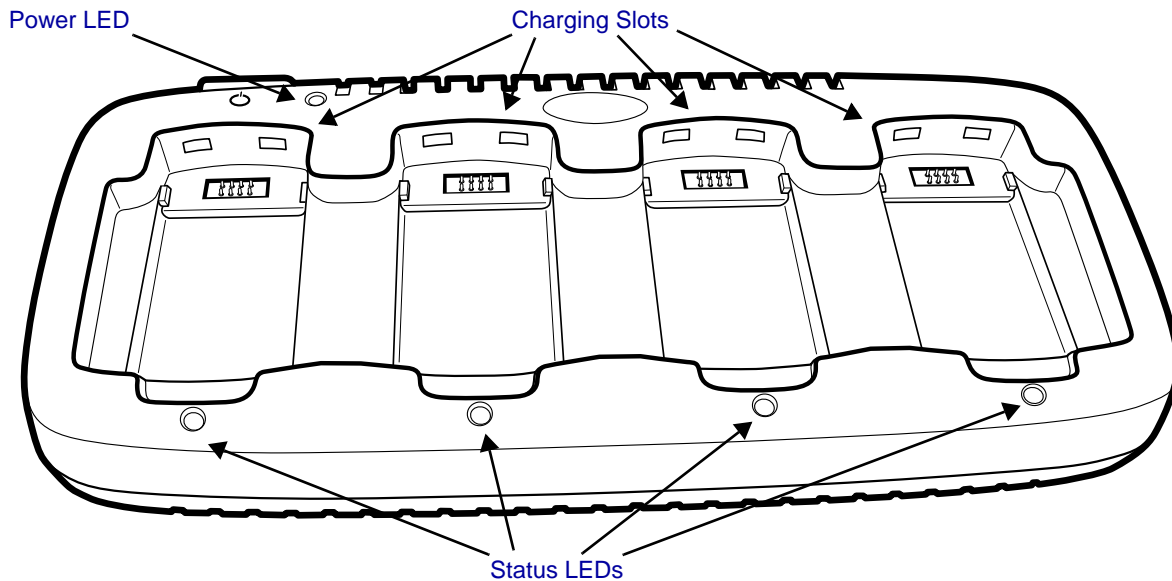

Charging Slots

The QuadCharger contains four charging slots. Each slot holds one battery. When a battery is placed in a slot, it immediately begins charging and its Status LED lights.

Power LED

This LED lights green after power has been applied and the QuadCharger completed initialization.

Status LEDs

A status LED is located above each of the four battery slots. The color of the LED indicates the charge status of the batteries in the slot.

Green (solid)
Orange (solid)
Red (flashing)

The battery has completed its charge cycle and is ready for use.
 The battery is properly seated and charging.
 The QuadCharger encountered an error during the most recent charge cycle.

Back Panel

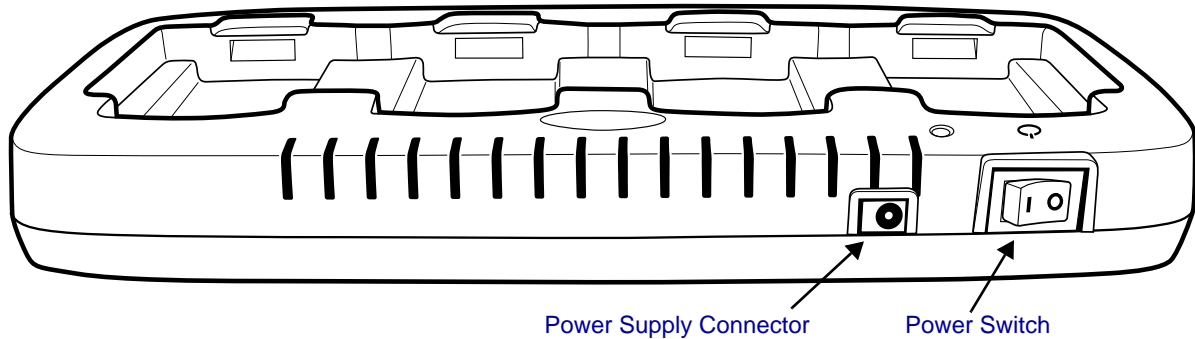

Power Supply Connector

Use this connector to attach the power supply to the QuadCharger. The universal power supply accepts input voltages between 90-265 volts.

Power Switch

Toggle the power switch to turn the QuadCharger on and off.

Supplying Power to the QuadCharger

Use the power adapter cable that comes with the Dolphin QuadCharger so that the input voltage is adjusted appropriately.

1. Locate the AC power adapter cable and plug it into the power source.
2. Connect the power cable to the power adapter.
3. Connect the power cable to the power supply connector on the back of the QuadCharger.
4. Press the power switch to the ON position.
5. The device performs the following power-up diagnostic routine for each slot indicated by the Status LEDs.:
 - All ON Orange
 - delay (500ms)
 - All ON Red
 - delay (500ms)
 - All ON Green
 - delay (500ms)
 - All OFF

Battery Charging

Inserting and Removing Battery Packs

To insert a battery pack, place the end of the battery without the locking tab into the bottom of the charging pocket and snap the battery into place with a hinging motion.

To remove a battery pack, push the locking tab down and pull the battery away from the charging slot with a hinging motion.

Charging Process

The QuadCharger charges Dolphin 7600 Li-ion battery packs in four hours. Each charging slot works independently of the other three. As battery packs charge, the charging circuitry follows the two-step charging process (CC-CV) that is recommended for Li-Ion batteries. The process monitors changes in temperature, current, and voltage.

Temperature

The QuadCharger charges Dolphin 7600 Li-ion battery packs in four hours when charged within the recommended temperature range of 50° to 95° F (10° to 35°C). Temperature has a significant effect on charging. For best results, battery packs should be at room temperature before inserting in the QuadCharger.



When the battery temperature exceeds 40°C, the QuadCharger may exceed the stated four-hour charge time. The QuadCharger stops charging if the battery temperature is greater than 40°C but will begin charging again when the battery temperature is less than 40°C.

To Charge Batteries in the QuadCharger

1. Supply the QuadCharger with power and turn the power switch on.
2. Insert batteries into the appropriate slots.
The Status LED for each slot turns orange to indicate that the battery is properly seated and has begun a charge cycle.
3. When the Status LED turns green, the battery in the slot has completed charging.

Recommendations for Storing Batteries

To maintain top performance from batteries, follow these storage guidelines:

- Avoid storing batteries outside of the specified temperature range of -4 to 122° F (-20 to 50°C) or in extremely high humidity.
- For prolonged storage, do not keep batteries stored in a charger that is connected to a power source.

Mounting the QuadCharger

The QuadCharger should be mounted on a dry, stable surface such as a desktop or workbench, or a flat, vertical surface such as a wall.

Mounting Location

When choosing a location for the QuadCharger:

- Keep in mind that the mounting location must allow users easy access to power switch and power connector.
- Do NOT place the QuadCharger in an enclosed space because restricted air flow can cause the temperature to elevate, which can effect charging. For more information, see [Battery Charging](#) on page 9-3.

Mounting Process

To mount the QuadCharger, slide the DIN Rail into the slot on the bottom panel. Then, using the appropriate nuts and bolts, secure the DIN rail to the desk or wall.

Bottom Panel Mounting Dimensions

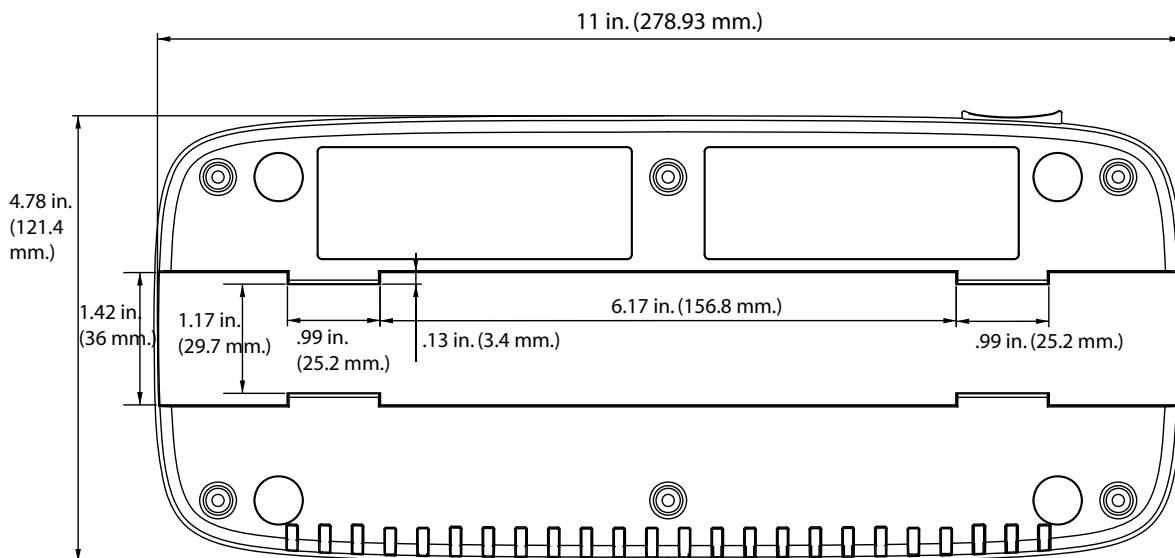

DIN Rail Dimensions

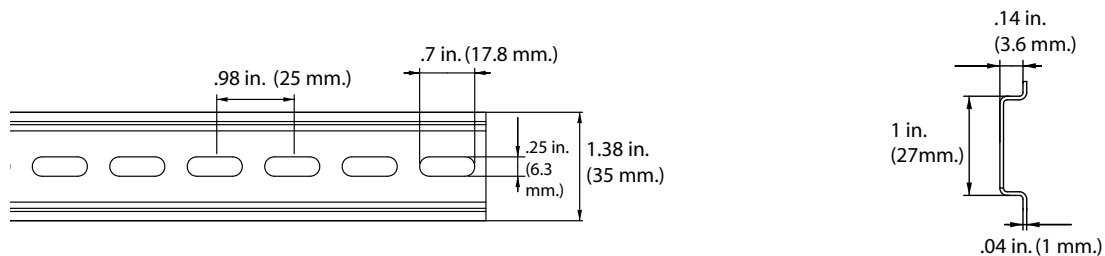

Mounting Guidelines

1. Before you begin, make sure you have two screws that are size #5–diameter measurement of 0.125 in. (3.18 mm).
2. Drill two holes into the wall, using the slots of the DIN Rail to locate. To ensure stability, holes should be located at least 4 inches (101.6mm) apart.
3. Insert a screw into each hole. The screw heads should be flush with the surface of the DIN rail,

Troubleshooting

If you encounter problems with the QuadCharger, refer to chart below for possible solutions. If problems persist, please contact [Technical Assistance](#) (see page 11-2).

Problem	Issue
The Status LED does not come on when I insert a battery pack into a slot.	Check the power connections on the Dolphin QuadCharger; make sure the POWER switch is ON and the battery pack is properly seated.
The Status LED lights red during charging.	Try to charge the battery in one of the other charging slots. If the red Status LED comes on again, then the problem is associated with the battery pack. If the red status stays with the charging slot, the problem is associated with the charging circuitry.
The Status LED lights red and stays on without a battery in the charging slot.	An error occurred during the self-diagnostic test for that particular charging pocket. Call Hand Held Products Product Service and Repair (see page 11-1) to request an RMA.

Dolphin QuadCharger Technical Specifications

Structural	
Dimensions	11 in. long X 4.8 in. wide X 1.5 in. high (27.9 cm. X 12.2 cm. X 3.8 cm.)
Weight	15.1 oz. (428g)
Material	Case: Polycarbonate ABS blend Color: Gray
Mounting	Use DIN rail slide to mount to a desktop or wall; see DIN Rail Dimensions on page 9-4.
Capacity	Supports up to four Li-ion battery packs
Environmental	
Operating Temperature	32° to 104°F (0° to 40°C)
Storage Temperature	-4° to +140°F (-20° to +60°C)
Charging Temperature	32° to 104°F (0° to 40°C)
Electrical Static Discharge	8 KVA immunity on all surfaces
Humidity	90% relative humidity (non-condensing)
Power Supply	
Input (Universal)	100V-240V, 0.8 A 50-60Hz Included with the QuadCharger
Output	12Volts DC, 2.5 A
Charging	
Standard Charge	Four hours or less
Status LEDs	See Status LEDs on page 9-1.
Agency Approvals	
Power Supply	UL listed TUV licensed Power Supply compliant to FCC part 15, Class B
Charging	CE Marking CISPR Pub 22
Fire Retardant	UL94 V-0

Overview

The Dolphin Mobile Mount provides easy and secure access to the Dolphin terminal in mobile environments.



Use only the peripherals, power cables, and power adapters from Hand Held Products. Use of peripherals, cables, or power adapters not sold/manufactured by Hand Held Products will void the warranty and may damage the terminal.

Out of the Box

The Dolphin Mobile Mount ships with

- The plastic mount, which holds one Dolphin 7600 terminal
- A standard, RAM (101-B) mounting bracket with two universal ball joints.
- The nuts and bolts required for installation.

Note: The Dolphin Mobile Mount is not intended for use the imaging/scanning applications.

Inserting a Terminal

Note: It is recommended that you install one of the ball mounts on the back panel before inserting a terminal; see [Mounting](#) on page 10-3.

1. Insert the back panel of a Dolphin 7600 terminal and gently place the lip of the top of the latch in place at the bottom of the image engine window.

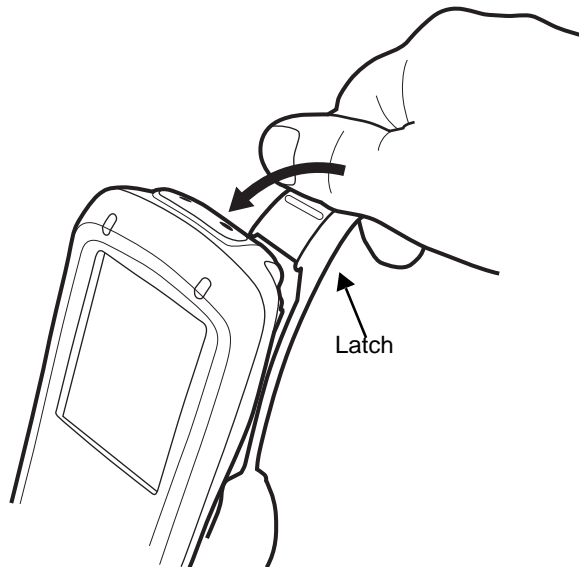

Do NOT pull back on the latch and snap in place! Make sure that the Dolphin terminal is securely fastened inside the mount but do not use excessive force.

-
2. The latch at the top should grip the back of the image engine window slot.

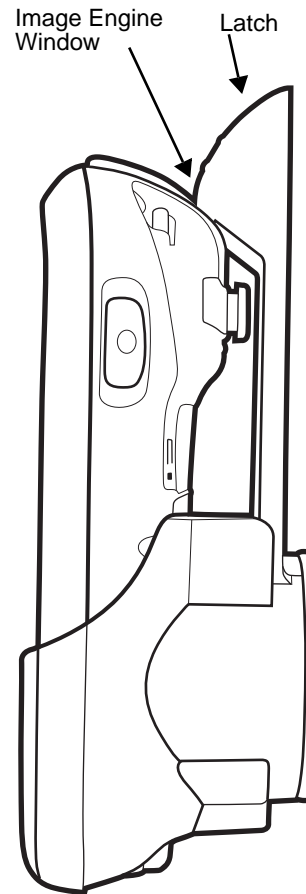

Mounting

The Dolphin Mobile Mount ships with a standard RAM mount (101B). You attach one ball joint that you attach to the back panel of the mount (with the fasteners provided).

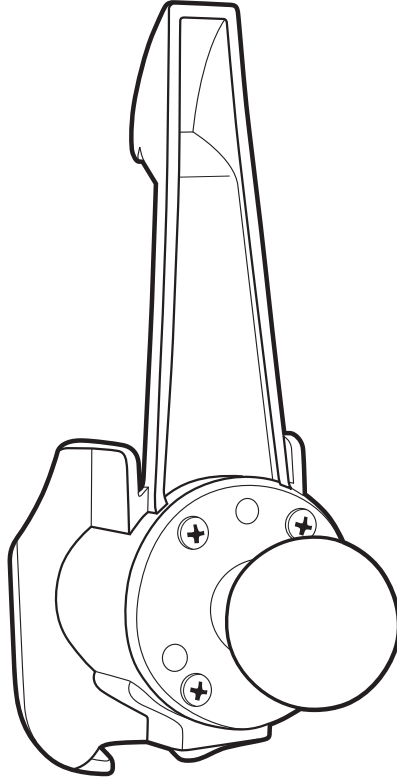

Then, you attach the rest of the RAM mount.

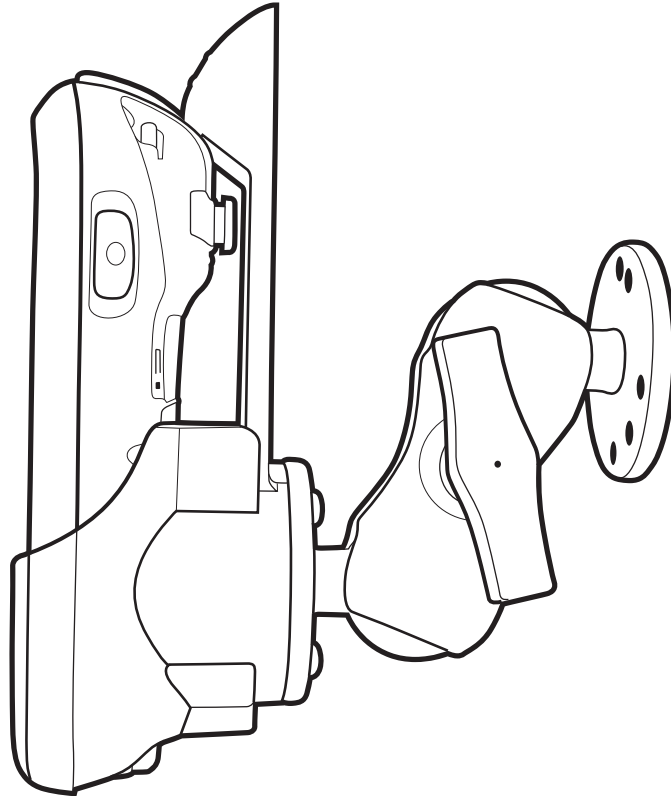
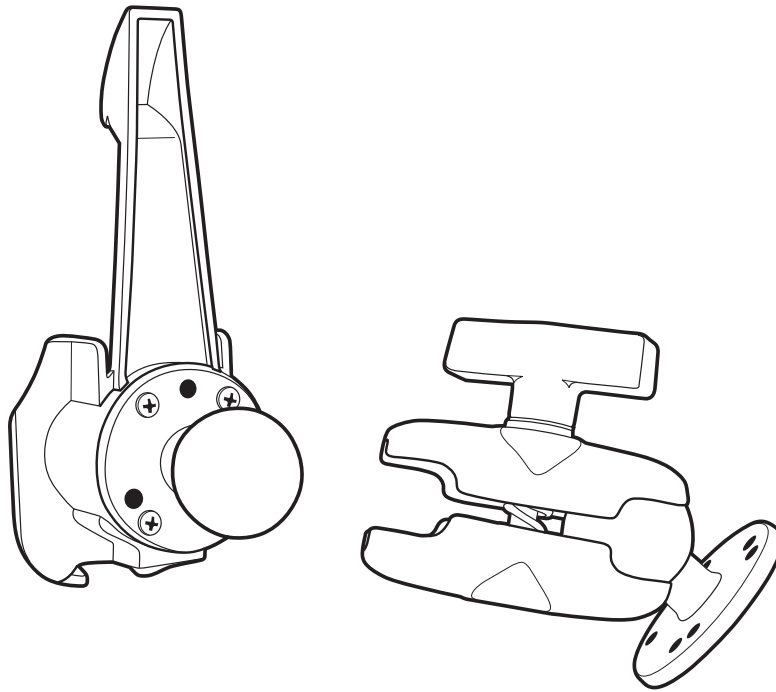

Then, affix the RAM mount to a stable surface.



Product Service and Repair

Hand Held Products provides service for all its products through service centers throughout the world. To obtain warranty or non-warranty service, return the unit to Hand Held Products (postage paid) with a copy of the dated purchase record attached. Contact the appropriate location below to obtain a Return Material Authorization number (RMA #) before returning the product.

North America

Telephone: (800) 782-4263
Fax: (803) 835-8012
E-mail: naservice@handheld.com

Latin America

Telephone: (803) 835-8000
Telephone: (800) 782-4263
Fax: (239) 263-9689
E-mail: laservice@handheld.com

Brazil

Telephone: +55 (21) 2178-0500
Fax: +55 (21) 2178-0505
E-mail: brservice@handheld.com

Mexico

Telephone: +52 (55) 5203-2100
Fax: +52 (55) 5531-3672
E-mail: mxservice@handheld.com

Europe, Middle East, and Africa

Telephone: +31 (0) 40 2901 633
Fax: +31 (0) 40 2901 631
E-mail: euservice@handheld.com

Asia Pacific

Telephone: +852-2511-3050
Fax: +852-2511-3557
E-mail: apservice@handheld.com

Japan

Telephone: +813-5770-6312
Fax: +813-5770-6313
E-mail: apservice@handheld.com

Online Product Service and Repair Assistance

You can also access product service and repair assistance online at www.handheld.com.

Technical Assistance

If you need assistance installing or troubleshooting, please call your Distributor or the nearest Hand Held Products technical support office:

North America/Canada

Telephone: (800) 782-4263
Fax number: (315) 554-6705
E-mail: natechsupport@handheld.com

Latin America

Telephone: (803) 835-8000
Telephone: (800) 782-4263
E-mail: latechsupport@handheld.com

Brazil

Telephone: +55 (21) 2178-0500
Fax: +55 (21) 2178-0505
E-mail: brsuporte@handheld.com

Mexico

Telephone: (803) 835-8000
E-mail: latechsupport@handheld.com

Europe, Middle East, and Africa

Telephone: +31 (0) 40 7999 393
Fax: +31 (0) 40 2425 672
E-mail: eurosupport@handheld.com

Asia Pacific

Telephone - Hong Kong: +852-3188-3485 or 2511-3050
Telephone - China: +86 21 6361 3818
E-mail: aptechsupport@handheld.com

Japan

Telephone: +813 5770-6312
E-mail: aptechsupport@handheld.com

Online Technical Assistance

You can also access technical assistance online at www.handheld.com.

For Further Information

To download the full User's Guide for these products, visit our website at www.handheld.com.

Limited Warranty

Hand Held Products, Inc. ("Hand Held Products") warrants its products to be free from defects in materials and workmanship and to conform to Hand Held Products' published specifications applicable to the products purchased at the time of shipment. This warranty does not cover any Hand Held Products product which is (i) improperly installed or used; (ii) damaged by accident or negligence, including failure to follow the proper maintenance, service, and cleaning schedule; or (iii) damaged as a result of (A) modification or alteration by the purchaser or other party, (B) excessive voltage or current supplied to or drawn from the interface connections, (C) static electricity or electro-static discharge, (D) operation under conditions beyond the specified operating parameters, or (E) repair or service of the product by anyone other than Hand Held Products or its authorized representatives.

This warranty shall extend from the time of shipment for the duration published by Hand Held Products for the product at the time of purchase ("Warranty Period"). Any defective product must be returned (at purchaser's expense) during the Warranty Period to Hand Held Products' factory or authorized service center for inspection. No product will be accepted by Hand Held Products without a Return Materials Authorization, which may be obtained by contacting Hand Held Products. In the event that the product is returned to Hand Held Products or its authorized service center within the Warranty Period and Hand Held Products determines to its satisfaction that the product is defective due to defects in materials or workmanship, Hand Held Products, at its sole option, will either repair or replace the product without charge, except for return shipping to Hand Held Products.

EXCEPT AS MAY BE OTHERWISE PROVIDED BY APPLICABLE LAW, THE FOREGOING WARRANTY IS IN LIEU OF ALL OTHER COVENANTS OR WARRANTIES, EITHER EXPRESSED OR IMPLIED, ORAL OR WRITTEN, INCLUDING, WITHOUT LIMITATION, ANY IMPLIED WARRANTIES OF MERCHANTABILITY OR FITNESS FOR A PARTICULAR PURPOSE.

HAND HELD PRODUCTS' RESPONSIBILITY AND PURCHASER'S EXCLUSIVE REMEDY UNDER THIS WARRANTY IS LIMITED TO THE REPAIR OR REPLACEMENT OF THE DEFECTIVE PRODUCT. IN NO EVENT SHALL HAND HELD PRODUCTS BE LIABLE FOR INDIRECT, INCIDENTAL, OR CONSEQUENTIAL DAMAGES, AND, IN NO EVENT, SHALL ANY LIABILITY OF HAND HELD PRODUCTS ARISING IN CONNECTION WITH ANY PRODUCT SOLD HEREUNDER (WHETHER SUCH LIABILITY ARISES FROM A CLAIM BASED ON CONTRACT, WARRANTY, TORT, OR OTHERWISE) EXCEED THE ACTUAL AMOUNT PAID TO HAND HELD PRODUCTS FOR THE PRODUCT. THESE LIMITATIONS ON LIABILITY SHALL REMAIN IN FULL FORCE AND EFFECT EVEN WHEN HAND HELD PRODUCTS MAY HAVE BEEN ADVISED OF THE POSSIBILITY OF SUCH INJURIES, LOSSES, OR DAMAGES. SOME STATES, PROVINCES, OR COUNTRIES DO NOT ALLOW THE EXCLUSION OR LIMITATIONS OF INCIDENTAL OR CONSEQUENTIAL DAMAGES, SO THE ABOVE LIMITATION OR EXCLUSION MAY NOT APPLY TO YOU.

All provisions of this Limited Warranty are separate and severable, which means that if any provision is held invalid and unenforceable, such determination shall not affect the validity of enforceability of the other provisions hereof.

Hand Held Products extends these warranties only to the first end-users of the products. These warranties are non-transferable.

The limited duration of the warranty for the Dolphin 7600 is as follows:

- Terminals with an integrated imager are covered by a one-year limited warranty.
- Touch screens are covered by a one-year limited warranty.
- Dolphin HomeBase, Dolphin Mobile Mount, Dolphin ChargeBase, Dolphin Mobile Charger, and Dolphin QuadCharger are covered by a one-year limited warranty.

Use of any peripheral not manufactured/sold by Hand Held Products will void the warranty. This includes but is not limited to: cables, power supplies, cradles, and docking stations.

Use only power adapters approved for use by Hand Held Products. Failure to do so may result in improper operation or damage to the unit and will void the warranty.

Batteries are covered by a one-year limited warranty. Use of any battery not sold/manufactured by Hand Held Products may damage the terminal and/or the battery and will void the warranty. Batteries returned to Hand Held Products in a reduced state may or may not be replaced under this warranty. Battery life will be greatly increased when following the battery instructions in the Dolphin 7600 User's Guide.

How to Extend Your Warranty

Hand Held Products offers a variety of service plans on our hardware products. These agreements offer continued coverage for your equipment after the initial warranty expires. For more information, contact your Sales Representative, Customer Account Representative, or Product Service Marketing Manager from Hand Held Products, or your Authorized Reseller.





Hand Held Products, Inc.

700 Visions Drive

P.O. Box 208

Skaneateles Falls, NY 13153-0208