



Cisco IP Phone 7970 Series for Cisco CallManager 4.1(3)

INCLUDING LICENSE AND WARRANTY



Corporate Headquarters

Cisco Systems, Inc.
170 West Tasman Drive
San Jose, CA 95134-1706
USA
<http://www.cisco.com>
Tel: 408 526-4000
800 553-NETS (6387)
Fax: 408 526-4100

Text Part Number: 78-15630-03



Common Phone Tasks

If you want to...	Then...
View your call logs	Press  and choose a call log. To dial, scroll to a listing and go off-hook.
Edit a number in a call log	Press EditDial . Use << or >> to erase or skip digits.
Dial from a corporate directory	Choose  > Corporate Directory . Enter letters and press Search . Go off-hook to dial.
Place or answer a new call with a call active	Press NewCall or Answer . The first call is placed on hold automatically.
Hold and resume a call	Press the Hold or Resume softkey.
Transfer a call to a new number	Press Transfer , enter the number, then hang up (or press Transfer again if your phone does not support on-hook transfer).
Transfer two calls (on the same line) to each other	Scroll to each call and press Select . Then press more > DirTrfr . Or, to stay on the line with callers, press Join .
Start a standard conference call	Press more > Confrn and dial the participant. Then press Confrn again.



Cisco, Cisco IOS, Cisco Systems, and the Cisco Systems logo are registered trademarks of Cisco Systems, Inc. or its affiliates in the United States and certain other countries. All other brands, names, or trademarks mentioned in this document or Website are the property of their respective owners. The use of the word partner does not imply a partnership relationship between Cisco and any other company. (0501R)

© 2005 Cisco Systems, Inc. All rights reserved.

78-15630-03



Cisco IP Phone 7970 Series

Softkey Definitions

Icon Reference

Button Icon Definitions

















Common Phone Tasks





Softkey Definitions

AbbrDial	Dial using a speed dial index number
Answer	Answer a call
Back	Return to the previous Help topic
Barge	Add yourself to a call on a shared line
CallBack	Receive notification when a busy extension becomes available
Cancel	Cancel an action or exit a screen without applying changes
cBarge	Add yourself to a call on a shared line and establish a conference call
CFwdALL	Setup/cancel call forwarding
Clear	Delete records or settings
Close	Close the current window
ConfList	View conference participants
Confrn	Create a conference call
Delete	Remove characters to the right of the cursor when using EditDial
Dial	Dial an entered phone number
DirTrfr	Transfer two calls to each other
EditDial	Edit a number in a call log
EndCall	Disconnect the current call
Erase	Reset settings to their defaults
Exit	Return to the previous screen
GPickUp	Answer a call ringing in another group
iDivert	Send a call to your voice messaging system

Join	Join several calls on a single line to create a conference call
Links	Access related Help topics
Main	Display the Help main menu
MeetMe	Host a Meet-Me conference call
more	Display additional softkeys
NewCall	Make a new call
OPickUp	Answer a call ringing in another group that is associated with your group
Park	Store a call using Call Park
PickUp	Answer a call in your group
Private	Prevent others from viewing or barging calls on a shared line
QRT	Submit call problems to the system administrator
Redial	Redial the most recently dialed number
Remove	Remove a conference participant
Resume	Resume a call on hold
RmLstC	Drop the last party added to conference call
Save	Save the chosen settings
Search	Search for a directory listing
Select	Select an item on the screen
Transfer	Transfer a call
Update	Refresh content and get the latest information
VidMode	Choose a video display mode for a video conference
<<	Delete entered characters
>>	Move through entered characters

Icon Reference

Call State	
	Call Forwarding enabled
	Call on hold
	Connected call
	Off-hook
	On-hook
	Incoming call
	Shared line in use
Secure Calls	
	Authenticated call
	Secure call
Selected Input Device	
	Handset in use
	Headset in use
	Speakerphone in use
Critical Calls	
	Priority call
	Medium priority call
	High priority call
	Highest priority call

Other Features	
	Speed Dial button configured
	Messages waiting
	Video enabled
	Option selected
	Feature enabled

Button Icon Definitions

	Messages
	Services
	Help
	Directories
	Settings
	Speaker
	Mute
	Headset



Contents

Getting Started 1

How to Use this Guide 1

Using and Cleaning the Touchscreen Display 2

Where to Find Additional Information 2

 More Information about Customizing Your Phone on the Web 3

Safety and Performance Information 3

Connecting Your Phone 6

An Overview of Your Phone 9

Buttons and Hardware 9

Touchscreen Features 12

Call-Handling and Navigation Tips 13

 Understanding Lines vs. Calls 13

 Understanding Call and Line Icons 13

 Going On-Hook and Off-Hook 14

 Selecting Calls 14

 Viewing and Switching Between Calls 15

 Choosing Touchscreen Items 16

 Using Feature Menus 16

 Entering and Editing Text 17

Getting Help on Your Phone 17

Understanding Feature Functionality and Availability 17

Basic Call Handling 18

Placing a Call 18

Answering a Call 22

Ending a Call 23

Using Hold and Resume	23
Using Mute	23
Transferring a Connected Call	24
Forwarding Your Calls to Another Number	25
Making Conference Calls	26
Types of Supported Conference Calls	26
Starting and Joining a Standard Conference	27
Starting or Joining a Meet-Me Conference Call	28

Advanced Call Handling 29

Storing and Retrieving Parked Calls	29
Picking Up a Redirected Call on Your Phone	30
Using a Shared Line	31
Understanding Shared Lines	31
Adding Yourself to a Shared-Line Call	32
Preventing Others from Viewing or Joining a Shared-Line Call	33
Tracing Suspicious Calls	33
Making and Receiving Secure Calls	34
Prioritizing Critical Calls	35

Using a Handset, Headset, and Speakerphone 36

Obtaining a Headset	36
Using AutoAnswer with a Headset or the Speakerphone	37

Customizing Phone Settings 38

Adjusting the Volume	38
Customizing Rings and Message Indicators	39
Customizing the Touchscreen	39
Setting Up Speed Dial Features	40

Using Voice Messaging, Call Logs, and Directories 41

Accessing Voice Messages	41
Using Call Logs and Directories	42

Accessing Your User Options Web Pages 43

Logging In to the User Options Web Pages 43

Subscribing to Phone Services 44

Understanding Additional Configuration Options 45

Troubleshooting Your Phone 47

Using the Quality Reporting Tool 47

Cisco One-Year Limited Hardware Warranty Terms 48

Index 51



Getting Started

How to Use this Guide

This guide provides you with an overview of the features available on your phone. You can read it completely for a solid understanding of your phone's capabilities, or refer to the table below for pointers to commonly used sections.

If you want to...	Then
Explore your phone on your own	Press  on the phone when you need assistance.
Clean the touchscreen	See the “Using and Cleaning the Touchscreen Display” section on page 2.
Review safety information	See the “Safety and Performance Information” section on page 3.
Connect your phone	See the “Connecting Your Phone” section on page 6.
Use your phone after it is installed	Start with the “An Overview of Your Phone” section on page 9.
Learn what the button lights mean	See the “Buttons and Hardware” section on page 9.
Learn about the touchscreen	See the “Touchscreen Features” section on page 12.
Make calls	See the “Placing a Call” section on page 18.
Put calls on hold	See the “Placing a Call” section on page 18.
Mute calls	See the “Using Mute” section on page 23.
Transfer calls	See the “Transferring a Connected Call” section on page 24.
Make conference calls	See the “Making Conference Calls” section on page 26.
Share a phone number	See the “Using a Shared Line” section on page 31.
Use your phone as a speakerphone	See the “Using a Handset, Headset, and Speakerphone” section on page 36.
Change the volume levels or the ringer sound	See the “Customizing Phone Settings” section on page 38.
Set up speed dialing	See the “Setting Up Speed Dial Features” section on page 40.
View your missed calls	See the “Using Call Logs and Directories” section on page 42.

Using and Cleaning the Touchscreen Display

Your Cisco IP Phone 7970 series features a high-resolution color touchscreen display. Refer to the table below for recommendations on the best practices for protecting and maintaining the touchscreen.

If you want to...	Then
Choose touchscreen items	Press (or tap) an item on the touchscreen with your fingertip. Do not use a device or object other than your fingertip to press the touchscreen. Your phone's touchscreen was designed to respond best when using your fingertip, and using other objects could damage the display.
Disable the touchscreen	Press the Display button and hold for more than one second. The Display button changes to flashing green, and the screen displays the "Touchscreen Disabled" message. The touchscreen remains disabled for about a minute unless you enable it sooner.
Enable the touchscreen	Press the Display button and hold for more than one second. The Display button stops flashing, and the screen displays the "Touchscreen Enabled" message.
Clean the touchscreen	Disable the touchscreen before cleaning it. Once the touchscreen is disabled, use a soft, dry cloth to wipe the touchscreen. Do not use any liquids or powders on the phone. Using anything other than a soft, dry cloth can contaminate phone components and cause failures.
Wake the touchscreen	When you first use your phone in the morning or after a period of inactivity (determined by your system administrator), the backlight on your touchscreen might be disabled. This is a sleep mode similar to a screen saver on your computer. To wake or activate the touchscreen, press any button or the touchscreen, or lift the handset.

Where to Find Additional Information

You can access the most current Cisco IP Phone documentation on the World Wide Web at this URL:

http://www.cisco.com/univercd/cc/td/doc/product/voice/c_ipphon/index.htm

You can access the Cisco website at this URL:

<http://www.cisco.com/>

International Cisco websites can be accessed from this URL:

http://www.cisco.com/public/countries_languages.shtml

More Information about Customizing Your Phone on the Web

Your Cisco IP Phone is a network device that can share information with other network devices in your company, including your computer. You can use your Cisco CallManager User Options web pages to establish and customize phone services and to control phone features and settings from your computer. This Guide provides a brief overview of these capabilities. For complete instructions, refer to *Customizing Your Cisco IP Phone on the Web* at the following URL:

http://www.cisco.com/univercd/cc/td/doc/product/voice/c_ipphon/index.htm

Safety and Performance Information

Installing and Using Your Phone

Read the following safety notices before installing or using your Cisco IP Phone:



Warning

IMPORTANT SAFETY INSTRUCTIONS

This warning symbol means danger. You are in a situation that could cause bodily injury. Before you work on any equipment, be aware of the hazards involved with electrical circuitry and be familiar with standard practices for preventing accidents.

SAVE THESE INSTRUCTIONS



Warning

Read the installation instructions before you connect the system to its power source.



Warning

Ultimate disposal of this product should be handled according to all national laws and regulations.



Warning

Do not work on the system or connect or disconnect cables during periods of lightning activity.



Warning

To avoid electric shock, do not connect safety extra low voltage (SELV) circuits to telephone network voltage (TNV) circuits. LAN ports contain SELV circuits, and WAN ports contain TNV circuits. Some LAN and WAN ports use RJ-45 connectors. Use caution when connecting cables.

**Caution**

Inline power circuits provide current through the communication cable. Use the Cisco provided cable or a minimum 24 AWG communication cable.

**Warning**

The power supply must be placed indoors.

Using an External Power Supply

The following warnings apply when you use the external power supply with the Cisco IP Phone:

**Warning**

This product relies on the building's installation for short-circuit (over current) protection. Ensure that a fuse or circuit breaker no larger than 120 VAC, 15A U.S. (240 VAC, 10A international) is used on the phase conductors (all current-carrying conductors).

**Warning**

The device is designed to work with TN power systems.

**Warning**

The plug-socket combination must be accessible at all times because it serves as the main disconnecting device.

**Caution**

Only use the Cisco specified power supply with this product.

Using External Devices with Your Cisco IP Phone

The following information applies when you use external devices with the Cisco IP Phone:

Cisco recommends the use of good quality external devices (speakers, microphones, and headsets) that are shielded against unwanted radio frequency (RF) and audio frequency (AF) signals.

Depending on the quality of these devices and their proximity to other devices such as mobile phones or two-way radios, some audio noise may still occur. In these cases, Cisco recommends that you take one or more of the following actions:

- Move the external device away from the source of the RF or AF signals.
- Route the external device cables away from the source of the RF or AF signals.
- Use shielded cables for the external device, or use cables with a better shield and connector.
- Shorten the length of the external device cable.
- Apply ferrites or other such devices on the cables for the external device.

Cisco cannot guarantee the performance of the system because Cisco has no control over the quality of external devices, cables, and connectors. The system will perform adequately when suitable devices are attached using good quality cables and connectors.



Caution

In European Union countries, use only external speakers, microphones, and headsets that are fully compliant with the EMC Directive [89/336/EC].

Connecting Your Phone

Your system administrator will likely connect your new Cisco IP Phone to the corporate IP telephony network. If that is not the case, refer to the to the graphic and table below to connect your phone.

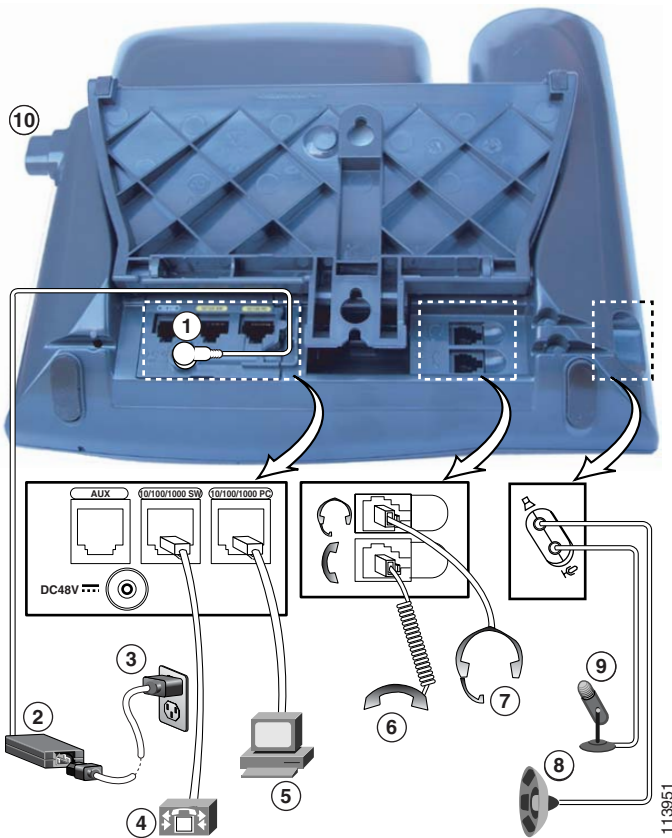

1	DC Adaptor port (DC48V)	6	Handset port
2	Power supply with DC connector for phone	7	Headset port
3	AC power cable with wall socket plug	8	External speakers port
4	Network port (10/100/1000 ¹ SW)	9	External microphone port
5	Access port (10/100/1000 ¹ PC)	10	Footstand button

1. Not available for all phone models. Contact your system administrator for assistance.

Adjusting the Footstand

To change the angle that your phone sits on your desktop, adjust the footstand while pressing the footstand button.

Adjusting the Handset Rest

When you connect your phone, you might want to adjust the handset rest to ensure that the receiver will not slip out of the cradle. See the table below for instructions.

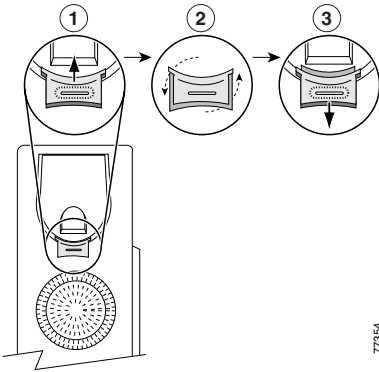

77954

1	Set the handset aside and pull the square plastic tab from the handset rest.
2	Rotate the tab 180 degrees.
3	Slide the tab back into the handset rest. An extension protrudes from the top of the rotated tab. Return the handset to the handset rest.

Registering with TAPS

After your phone is connected to the network, your system administrator might ask you to auto-register your phone using TAPS (Tool for Auto-Registered Phones Support). TAPS might be used either for a new phone or to replace an existing phone.

To register with TAPS, pick up the handset, enter the TAPS extension provided by your system administrator, and follow the voice prompts. You might need to enter your entire extension, including the area code. After your phone displays a confirmation message, hang up. The phone will re-start.

Headset Information

To use a headset, connect it to the headset port on the back of your phone.

Although Cisco Systems performs some internal testing of third-party headsets for use with the Cisco IP Phones, Cisco does not certify or support products from headset or handset vendors. Because of the inherent environmental and hardware inconsistencies in the locations where Cisco IP Phones are

deployed, there is not a single “best” solution that is optimal for all environments. Cisco recommends that customers test the headsets that work best in their environment before deploying a large number of units in their network.

In some instances, the mechanics or electronics of various headsets can cause remote parties to hear an echo of their own voice when they speak to Cisco IP Phone users.

Cisco Systems recommends the use of good quality external devices, like headsets that are screened against unwanted radio frequency (RF) and audio frequency (AF) signals. Depending on the quality of these devices and their proximity to other devices such as cell phones and two-way radios, some audio noise may still occur. See the “Using External Devices with Your Cisco IP Phone” section on page 5 for more information.

The primary reason that support of a headset would be inappropriate for the Cisco IP Phone is the potential for an audible hum. This hum can either be heard by the remote party or by both the remote party and you, the Cisco IP Phone user. Some potential humming or buzzing sounds can be caused by a range of outside sources, for example, electric lights, being near electric motors, large PC monitors. In some cases, a hum experienced by a user may be reduced or eliminated by using a local power cube (CP-PWR-CUBE-2). See the “Using an External Power Supply” section on page 4 for more information.

Subjective to the User

Beyond the physical, mechanical and technical performance, the audio portion of a headset must sound good to you (the user) and to the party on the far end. Sound is subjective and Cisco cannot guarantee the performance of any headsets or handsets, but some of the headsets and handsets on the sites listed below have been reported to perform well with Cisco IP Phones.

Nevertheless, it is ultimately still the customer’s responsibility to test this equipment in their own environment to determine suitable performance.

For information about headsets, see:

<http://vxicorp.com/cisco>

<http://plantronics.com>

An Overview of Your Phone

The Cisco IP Phone 7970 Series are full-feature telephones that provide voice communication over the same data network that your computer uses, allowing you to place and receive phone calls, put calls on hold, speed dial numbers, transfer calls, make conference calls, and so on.

In addition to basic call-handling features, your phone supports specialized or advanced telephony features that can extend and customize your call-handling capabilities.

Your Cisco IP Phone also provides you with:

- Access to network data and services—You can access specialized web-based services from your phone
- Online control from your User Options web pages—You can customize your phone's features using a web browser on your computer
- A comprehensive online help system—You can obtain helpful tips, descriptions, and procedures directly from your phone

Buttons and Hardware

Some of the hardware features on your phone include:















- A full-color touchscreen display
- Eight backlit line buttons, which provide dynamic call-state information
- Speakerphone or headset mode support
- Five softkey buttons for access to telephony features
- Four feature buttons for access to messages, directories, services, and settings
- One-button access to built-in online help
- Button for temporarily disabling the touchscreen and for waking the touchscreen from power-save mode

Refer to the following illustration and table for details.



98454





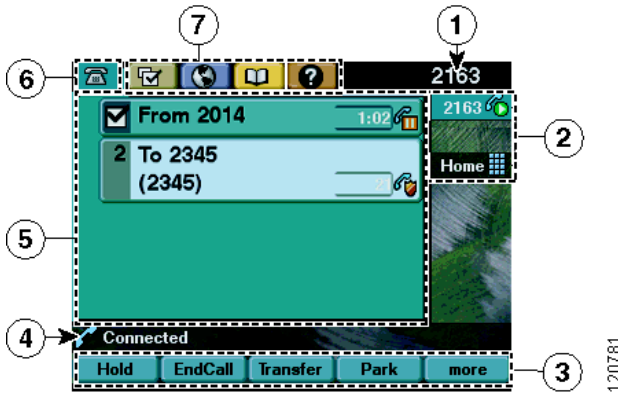

<p>1 Programmable buttons</p>	<p>Depending on configuration, programmable buttons provide access to:</p> <ul style="list-style-type: none"> • Phone lines (line buttons) • Speed-dial numbers (speed-dial buttons) • Web-based services (for example, a Personal Address Book button) • Phone features (for example, a Privacy button) <p>The buttons illuminate to indicate status:</p> <ul style="list-style-type: none"> ● Green, steady—Active call on this line (off hook) ● Green, blinking—Call on hold on this line ● Amber, steady—Privacy feature enabled ● Amber, blinking—Incoming call ringing on this line ● Red—Shared line, currently in use ● No color—No call activity on this line (on hook)
<p>2 Footstand button</p>	<p>Allows you to adjust the angle of the phone base.</p>

3	Display button 	Awakens the touchscreen from power-save mode or disables it for cleaning.  No color—Touchscreen available, ready for input  Green flashing—Touchscreen disabled  Green steady—Touchscreen and backlight disabled See the “Using and Cleaning the Touchscreen Display” section on page 2.
4	Messages button 	Typically auto-dials your voice message service (varies by service). See the “Accessing Voice Messages” section on page 41.
5	Directories button 	Opens/closes the Directories menu. Use it to access call logs and corporate directories. See the “Using Call Logs and Directories” section on page 42.
6	Help button 	Activates the Help menu. See the “Getting Help on Your Phone” section on page 17.
7	Settings button 	Opens/closes the Settings menu. Use it to control touchscreen appearance and ring sounds. See the “Customizing Phone Settings” section on page 38.
8	Services button 	Opens/closes the Services menu. See the “Accessing Your User Options Web Pages” section on page 43.
9	Volume button 	Controls the volume and other settings. See the “Customizing Phone Settings” section on page 38.
10	Speaker button 	Toggles the speakerphone on or off.
11	Mute button 	Toggles the Mute feature on or off.
12	Headset button 	Toggles the headset on or off.
13	Navigation button 	Allows you to scroll through menus and highlight items. Use in conjunction with softkeys to activate highlighted items. Also, while the phone is on-hook, press the Navigation button to access phone numbers from your Placed Calls log.
14	Keypad	Allows you to dial phone numbers, enter letters, and choose menu items.
15	Softkey buttons 	Each activates a softkey option (displayed on your touchscreen).
16	Handset light strip	Indicates an incoming call or new voice message.
17	Touchscreen	Shows phone features. See the “Touchscreen Features” section on page 12.

Touchscreen Features

This is what your main touchscreen might look like with active calls and several feature menus open. Press (or tap) with your fingertip to activate touch-sensitive items on your touchscreen.



1	Primary phone line	Displays the phone number (extension number) for your primary phone line. If several tabs are open, the time and date display here also.
2	Icons for programmable buttons	<p>Icons indicate how programmable buttons  are set up on your phone:</p> <ul style="list-style-type: none">  Phone line icon—Corresponds to a phone line and displays the call or line state. Your phone might have multiple phone lines.  Speed-dial icon—If available, corresponds to a speed-dial button. See the “Setting Up Speed Dial Features” section on page 40.  Phone service icon—If available, corresponds to a web-based phone service, such as the Personal Address Book.  Feature icon—If available, corresponds to a feature, such as Privacy.
3	Softkey labels	Each displays a softkey function. To activate a softkey, press the softkey button  or the softkey label on the touchscreen.
4	Status line	Displays audio mode icons, status information, and prompts.
5	Call activity area	Displays current calls per line, including caller ID, call duration, and call state. See the “Viewing and Switching Between Calls” section on page 15.
6	Phone tab	Indicates call activity. Press this tab to return to call activity area if needed.
7	Feature tabs	Each indicates an open feature menu. Press a tab to switch between open menus. See the “Using Feature Menus” section on page 16.

Call-Handling and Navigation Tips

These guidelines can help you handle calls and navigate menus on your Cisco IP Phone.

Understanding Lines vs. Calls

It can be easy to confuse *lines* and *calls* on your phone. Use these tips to avoid confusion:

Lines







Phone models in the Cisco IP Phone 7970 Series support up to eight lines. Each line corresponds to a phone number (or extension) that others can use to call you. The number of lines assigned to your phone depends on how your system administrator configures your phone's programmable buttons. To see how many lines you have, look at the programmable button icons and labels on your touchscreen. You have as many lines as you have phone numbers and phone line icons: 



Calls

Each line can support multiple calls. Therefore, you might find yourself handling several calls on one phone line. The default configuration is four calls per line, but your system administrator can adjust this number according to your needs. Regardless of the number of lines, your phone supports a maximum of 200 calls at time.

Understanding Call and Line Icons





Your phone displays icons to help you determine the call and line state (on-hook, on hold, ringing, connected, and so on).

Icon	Call or line state	Description
	On-hook line	No call activity on this line. If you are dialing on-hook (pre-dial), the call is not in-progress until you go off-hook.
	Off-hook line	You are actively dialing a number or an outgoing call is ringing. See the “Placing a Call” section on page 18 for dialing options.
	Connected call	You are connected to the other party.
	Ringing call	A call is ringing on one of your lines. See the “Answering a Call” section on page 22 for more information.
	Call on hold	You have put this call on hold. See the “Using Hold and Resume” section on page 23 for details.
	Remote-in-use	Another phone that shares your line has a connected call. See the “Using a Shared Line” section on page 31 for details.

Icon	Call or line state	Description
	Authenticated call	See the “Making and Receiving Secure Calls” section on page 34.
	Encrypted call	See the “Making and Receiving Secure Calls” section on page 34.

Going On-Hook and Off-Hook

Some phone tasks and instructions differ depending on whether the phone is *on-hook* or *off-hook*.

- On-Hook—The phone handset is resting in the cradle, no calls are active, and you do not have an active dial tone. Your phone provides on-hook dialing (*pre-dial*), which enables you to enter or choose phone numbers before activating the call. When your phone is on-hook, this icon appears next to each phone number: 
- Off-Hook—The phone handset is lifted from the cradle, the speakerphone is active, or any of several other methods are used to get a dial tone or to answer an incoming call. When your phone is off-hook, one of these icons appears, depending on the call or line state: , , or . See the “Understanding Call and Line Icons” section on page 13 for related information.





Selecting Calls

Many phone features require that you select the calls you want to use with a particular feature. For example, if you have four held calls but only want to join two of them in a conference call, you can select the calls that you want to add to the conference before activating the feature.

If you want to...	Then...
Highlight a call	Use the Navigation button to scroll through the call list. Highlighted calls appear on a lighter and brighter background.
Select a call	Highlight a connected or held call and press Select . Selected calls are indicated with a <input checked="" type="checkbox"/> next to them.
Verify selected calls	Use the Navigation button to scroll through the list of calls. Selected calls are indicated with a <input checked="" type="checkbox"/> and are grouped together in the call list.

Viewing and Switching Between Calls

These tips can help you switch between calls on one or more lines. If the call that you want to switch to is not automatically highlighted, press the call appearance on your touchscreen or scroll to it.

If you want to...	Then...
Switch between calls on one line	Highlight the call you are switching to and press Resume . The other call is placed on hold automatically.
Switch from a connected call to answer a ringing call	Press Answer or the press a blinking amber button  . Doing so automatically places the first call on hold.
Switch between calls on different lines	Press the blinking green button  for the line that you are switching to. If there is a single call holding on the line, the call will resume automatically. If there are multiple calls holding on the line, highlight the specific call (if necessary) and press Resume .
See all calls on a specific line	Press  , then immediately press the line button. Doing so shows call details but will not impact the call state; it is therefore useful if you are talking on one line and want to view held calls on another line.
See an overview of line activity (one call per line)	Press  for the highlighted line. (A line appears highlighted when the calls associated with it are displayed on the phone screen.) Doing so prompts the phone to switch to <i>call overview mode</i> and display one call per line. This call is either the active call or, if all calls are on hold, the held call with the longest duration. To return to the standard view, press  , then immediately press the line button.





Tips

- Only one call can be active; other calls will be placed on hold automatically.
- When you have multiple calls on one line, calls with the highest precedence and longest duration display at the top of the call list. See the “Prioritizing Critical Calls” section on page 35.
- Calls of a similar type are grouped together in the call list. For example, calls that you have interacted with are grouped near the top, selected calls are grouped next, and calls that you have not yet answered are grouped last.

Choosing Touchscreen Items

To choose a touchscreen item...	Do this...
By touch	Press (or tap) an item on the touchscreen with your fingertip. Note that pressing a phone number on the touchscreen can cause the phone to dial the number.
By item number	Press the corresponding number on your keypad. For example, press 4 to choose the fourth item in a menu.
By scrolling	Press the Navigation button to scroll through a list and to highlight an item. Press a relevant softkey such as Select or Dial to finish the action, or tap the item on the touchscreen with your fingertip.

Using Feature Menus







If you want to...	Then...
Open or close a feature menu	Press a feature button:  Messages  Services  Help  Directories  Settings
Scroll through a list or menu	Press the Navigation button.
Go back one level in a feature menu	Press Exit . (Note that if you press Exit from the top level of a menu, the menu will close.)
Switch among open feature menus	Press a feature tab on your touchscreen. (Each feature menu has a corresponding tab. The tab is visible when the feature menu is open.)

Entering and Editing Text

If you want to...	Then...
Enter a letter on your touchscreen	Press the appropriate keypad number one or more times to select a letter (with or without capitalization) from the pop-up menu. When you pause, the cursor automatically advances to allow you to enter the next letter.
Delete within an entry or move your cursor	Press << or Delete to remove a letter or digit. Press >> to move the cursor to the right.

Getting Help on Your Phone

Your Cisco IP Phone provides a comprehensive online help system. Help topics appear on the touchscreen. See the table below for details.

If you want to...	Then...
View the main menu	Press  on your phone and wait a few seconds for the menu to display. If you are already in Help, press Main . Main menu topics include: <ul style="list-style-type: none">• About Your Cisco IP Phone—Descriptive details about your phone• How do I...?—Procedures and information about common phone tasks• Calling Features—Descriptions and procedures for calling features• Help—Tips on using and accessing Help
Learn about a button or softkey	Press  , then quickly press a button or softkey.
Learn about a menu item	Press  , then quickly press the menu item on the touchscreen. Or, press  twice quickly with the menu item highlighted.
Get help using Help	Press  . After a second or two, press  again or choose Help from the Main Menu.

Understanding Feature Functionality and Availability







The operation of your Cisco IP Phone and the features available to you may vary, depending on the call processing agent used by your company and also on how your company's phone support team has configured your phone system. Therefore, some of the features included in this Phone Guide might not be available to you or might work differently on your phone system. Contact your support desk or system administrator if you have questions about feature operation or availability.





Basic Call Handling





This section covers basic call-handling tasks such as placing, answering, transferring, and conferencing calls. The features you use to perform these tasks are standard and available on most phone systems.



Placing a Call

To place a call, pick up the handset and dial. Or use one of the other options outlined in the table below.

If you want to...	Then...
Pre-dial (dial on-hook, without first getting a dial tone)	<p>Do one of the following:</p> <ul style="list-style-type: none">• Enter a phone number. (The Auto-Dial feature might pop up to suggest matching phone numbers from your Placed Calls log.)• Press the Navigation button to display phone numbers from your Placed Calls log. <p>Next, press the phone number appearance on your touchscreen to dial. Or do one of these actions to go off-hook and dial the highlighted phone number:</p> <ul style="list-style-type: none">• Lift the handset• Press  or • Press Dial• Press  (a line button)
Dial using the speakerphone	<p>Press New Call and enter a phone number. Or, you can press  before or after dialing, re-dialing or speed dialing a number.</p> <p>Many of the actions that you can take to dial will automatically trigger speakerphone mode, assuming that the handset is in its cradle and  is not lit. These actions include pressing Redial, a speed dial button, or a phone number on your touchscreen.</p>
Redial the most recently dialed number	<p>Press Redial. By default, Redial uses your primary line. However, you can open a secondary line and then press Redial. To open a line, press .</p>

If you want to...	Then...
Speed dial a number	<p>Do one of the following:</p> <ul style="list-style-type: none"> • Press  (a speed-dial button) before or after going off-hook. • Enter a speed dial index number (1-99 on the keypad) while on-hook and press AbbrDial. <p>For details, see the “Setting Up Speed Dial Features” section on page 40.</p>
Place a call when another call is active (using another line)	<p>Press  for the new line. The call on the first line will be placed on hold automatically.</p>
Place a call when another call is active (using the same line)	<p>Press Hold, then press New Call. You can now dial, redial, or speed dial a number. Or you can continue talking on the active call while preparing to dial from a call log or directory. (See the next two rows in this table for details.)</p>
Dial from a call log	<p>Choose  > Missed Calls, Received Calls, or Placed Calls. To dial, press the listing or scroll to it and go off-hook.</p> <p>If you want to dial from a call log while on another active call, scroll to a call record and press Dial. Then choose a menu item to handle the original call:</p> <ul style="list-style-type: none"> • Hold—Puts the first call on hold and dials the second. • Transfer—Transfers the first party to the second. (Then press Transfer again to complete the action.) • Conference—Creates a conference call with all parties. (Then press Confrn to complete the action.) • End Call—Disconnects the first call and dials the second.
Dial from a corporate directory on the phone	<p>Choose  > Corporate Directory (exact name can vary). Use your keypad to enter letters, then press Search. To dial, press the listing or scroll to it and go off-hook.</p> <p>If you want to dial from a directory while on an active call, scroll to a listing and press Dial. Then choose a menu item to handle the original call:</p> <ul style="list-style-type: none"> • Hold—Puts the first call on hold and dials the second. • Transfer—Transfers the first party to the second. (Then press Transfer again to complete the action.) • Conference—Creates a conference call with all parties. (Then press Confrn to complete the action.) • End Call—Disconnects the first call and dials the second.

If you want to...	Then...
Dial from a corporate directory web page	Use the Cisco WebDialer feature. Open a web browser and go to your company directory. Click on a phone number in the directory. Click Dial to place the call. Click Hangup to end the call. See the <i>Customizing Your Cisco IP Phone on the Web</i> guide for more details: http://www.cisco.com/univercd/cc/td/doc/product/voice/c_ipphon/index.htm
Dial using a headset	Do one of the following: <ul style="list-style-type: none"> • If  is unlit, press it before or after dialing, re-dialing, or speed-dialing a number. • If  is lit, press New Call, Redial, a speed dial button, or  (a line button). If necessary, enter a phone number and press Dial.
Receive notification when a busy or ringing extension becomes available	Call the number and press CallBack while listening to the busy tone or ring sound. Hang up. When the extension becomes available, your phone will provide you with an audio and visual alert. (The call back to this number is not automatic; you must place the call.) CallBack is a special feature that your system administrator might configure for your phone. Note that CallBack will fail if the other party has call forwarding enabled.
Dial on a secondary line	Press  for the line that you want to use.
Make a priority (precedence) call	Enter the MLPP access number (provided by your system administrator) followed by the phone number. For more details, see the “Prioritizing Critical Calls” section on page 35.
Dial from a Personal Address Book (PAB) entry or Fast Dial code	Choose  > PAB service or Fast Dial service (exact names might vary). To dial from a listing, press it or scroll to it and go off-hook. For help subscribing to the PAB or Fast Dial service, see the “Accessing Your User Options Web Pages” section on page 43.
Place a call using a billing or tracking code	Dial a number and enter a client matter code (CMC) or a forced authorization code (FAC) when prompted by a distinctive tone. Your system administrator will tell you if you need to enter CMC or FAC codes and can provide you with detailed instructions.







If you want to...	Then...
Place a call using your Cisco Extension Mobility profile	<p>Make sure that you are logged in to Extension Mobility (EM). Choose  > EM Service (exact name might vary), then use your keypad to enter login information. If you are sharing a phone, you might need to log in to EM before you can access certain features or complete a call.</p> <p>EM is a special, non-default feature that your system administrator can assign to phones and phone users. Refer to the <i>Customizing Your Cisco IP Phone on the Web</i>: http://www.cisco.com/univercd/cc/td/doc/product/voice/c_ipphon/index.htm</p>
Make a video call	<p>Check the touchscreen display for this icon: </p> <p>If the icon is present, your phone is video-enabled and can support Cisco VT Advantage. This enables you to make video calls using your Cisco IP Phone, your personal computer, and an external video camera. Contact your system administrator for assistance and refer to the <i>Cisco VT Advantage Quick Start Guide and Cisco VT Advantage User Guide</i>: http://www.cisco.com/univercd/cc/td/doc/product/voice/c_ipphon/index.htm</p>

Tips

- If you make a mistake while entering a phone number, press << to erase one or more digits. Press **Cancel** to exit the dialing attempt.
- If you cannot hear a dial tone or complete a phone call, one or more of the following factors might apply. If necessary, ask your system administration for more information.
 - You need to log into the Extension Mobility service from the  button on your phone.
 - You need to enter a client matter code or forced authorization code after dialing a number.
 - Your phone has time-of-day restrictions that prevent you from using some features during certain hours of the day.



Answering a Call

To answer a call, go-off hook by picking up the handset. Or see the table below for more options.

If you want to...	Then...
Answer with a headset	Press  , if unlit. Or, if  is already lit, press Answer or  (the flashing line button).
Answer with the speakerphone	Press  , Answer , or  .
Switch from a connected call to answer a ringing call	Press Answer or, if the call is ringing on a different line, press the flashing amber button  . Either action answers the new call and automatically places the first call on hold. See the “Using Hold and Resume” section on page 23 for more information.
Answer a call using call waiting	Ask your system administrator to setup the Call Waiting feature for your phone. When this feature is enabled, you will hear a call waiting tone and see caller ID information if a new call comes in while you are on another call. To answer the call, press Answer . To return to the original call, you must put this call on hold. See the “Using Hold and Resume” section on page 23.
Automatically connect an incoming call after a ring or two	Ask your system administrator to set up the AutoAnswer feature. For more information, see the “Using AutoAnswer with a Headset or the Speakerphone” section on page 37.
Retrieve a held call on another phone (such as a phone in a conference room)	Use Call Park. See the “Storing and Retrieving Parked Calls” section on page 29.
Use your phone to answer a call that is ringing on another phone	Use Call Pickup. See the “Picking Up a Redirected Call on Your Phone” section on page 30.
Answer a priority call	Hang up the current call and press Answer . See the “Prioritizing Critical Calls” section on page 35.
Send an incoming call directly to your voice messaging system	Press iDivert . The incoming call automatically transfers to your voice message greeting.



Ending a Call

To end a call, hang up. See the table below for details.

If you want to...	Then...
Hang up while using the handset	Return the handset to its cradle. Or press EndCall .
Hang up while using the headset	Press  . If you want to keep headset mode activated (keep the button lit after hanging up), press EndCall .
Hang up while using the speakerphone	Press  or EndCall .
Hang up one call but preserve another call on the same line	Press EndCall . If necessary, remove the call from hold first.

Using Hold and Resume

Only one call can be active at any given time; all other calls will be placed on hold.



If you want to...	Then...
Put a call on hold	Make sure the call you want to put on hold is highlighted and press Hold .
Remove a call from hold on the current line	Make sure that the appropriate call is highlighted and press Resume .
Remove a call from hold on a different line	Press  (a blinking line button). If there is a single call holding on this line, the call will resume automatically. If there are multiple calls holding, make sure that the appropriate call is highlighted and press Resume . Note that a held call is indicated by the call-on-hold icon:  .

Tips

- Engaging the Hold feature typically generates music or a beeping tone. For this reason, avoid putting a conference call on hold.

Using Mute

Mute disables the audio input for your phone. With Mute enabled, you can hear other parties on a call but they cannot hear you.

If you want to...	Then...
Toggle Mute on	Press  .
Toggle Mute off	Press  .

Transferring a Connected Call

Transfer redirects a connected call. The *target* is the number to which you want to transfer the call.

If you want to...	Then...
Transfer a call without talking to the transfer recipient	Press Transfer and enter the target number. When you hear the call ringing, hang up. If your system administrator did not enable on-hook transfer, you must press Transfer again to complete the transfer. To cancel the transfer, press EndCall .
Talk to the transfer recipient before transferring a call (consult transfer)	Press Transfer and enter the target number. Wait for the transfer recipient to answer. If the recipient accepts the transferred call, hang up. (If your system administrator did not enable on-hook transfer on your phone, you must press Transfer again to complete the transfer.) To cancel the transfer, press EndCall .
Transfer two current calls to each other (direct transfer)	Scroll to highlight any call on the line and press Select . Repeat this process for the second call. With one of the selected calls highlighted, press DirTrfr . (You might need to press more to see DirTrfr .) The two calls connect to each other and drop you from the call. If you want to stay on the line with the callers, use Join to create a conference instead. For details, see the “Making Conference Calls” section on page 26.
Send a call to your voice messaging system	Press iDivert . The call is automatically transferred to your voice message greeting. You can use iDivert with a call that is active, ringing, or on hold.

Tips

- When on-hook transfer is enabled, you can either hang up or press **Transfer**, then hang up.
- If on-hook transfer is not enabled on your phone, be aware that hanging up instead of pressing **Transfer** cancels the transfer action and places the party to be transferred on hold.
- You cannot use **Transfer** to redirect a call on hold. Press **Resume** to remove the call from hold before transferring it.

Forwarding Your Calls to Another Number

You can use Call Forward All to redirect your incoming calls from your Cisco IP Phone to another number.



Tip Enter the Call Forward All target number exactly as you would dial it from your desk phone. For example, enter an access code or the area code, if necessary.

If you want to...	Then...
Set up call forwarding on your primary line	Press CFwdALL and enter a target phone number.
Cancel call forwarding on your primary line	Press CFwdALL .
Verify that call forwarding is enabled on your primary line	Look for this icon above the primary phone number:  . Also, check that the status text near the bottom of the touchscreen displays the call forwarding target number.
Set up or cancel call forwarding for any line	Log in to your User Options web pages, choose your device, then choose Forward all calls... from the main menu. You can set up or cancel call forwarding for each line on your phone. See the “Logging In to the User Options Web Pages” section on page 43 for login instructions. When call forwarding is enabled for any line other than the primary line, your phone does not provide you with any confirmation that calls are being forwarded. Instead, you must confirm your settings in the User Options pages.

Tips

- You can forward your calls to a traditional analog phone or to another IP phone, although your system administrator might restrict the call forwarding feature to numbers within your company.
- You must configure this feature per line; if a call reaches you on a line where call forwarding is not enabled, the call will ring as usual.

Making Conference Calls

Your Cisco IP Phone allows you to join three or more people into one telephone conversation, creating a conference call.

Types of Supported Conference Calls

There are two types of conference calls: Standard and Meet-Me.

Standard Conference Calls

In standard (or “ad hoc”) conference calls, the conference organizer must call participants to add them to the conference. Using your Cisco IP Phone, you can create standard conference calls in different ways, depending on your needs and your phone’s configuration:

- **Confrn**—Use this softkey to establish a standard conference by calling each participant. Standard conference calling is a default feature available on most phones.
- **Join**—Use this softkey to establish a standard conference among several calls already on one line.
- **cBarge**—Use this softkey to add yourself to an existing call on a shared line and to turn the call into a standard conference call. This is an optional feature available only for shared lines, and your system administrator must configure it for you. See the “Using a Shared Line” section on page 31 for details.

See the “Starting and Joining a Standard Conference” section on page 27 for additional instructions.

Meet-Me Conference Calls

Meet-Me conferencing allows participants to join a conference by calling the conference number directly, rather than waiting for the conference initiator to call them.

To start a Meet-Me conference, press the **MeetMe** softkey on your phone, then dial the Meet-Me phone number provided by your system administrator.

To participate in a Meet-Me conference, dial the Meet-Me phone number at a specified time. Conference participants hear a busy tone if they call into the conference before the conference initiator has dialed in. Once the conference initiator has dialed in, the Meet-Me conference is established and can continue even if the conference initiator disconnects.

Meet-Me conferencing is a special feature that your system administrator must configure for you.

See the “Starting or Joining a Meet-Me Conference Call” section on page 28 for additional instructions.

Starting and Joining a Standard Conference

A standard conference allows at least three people to participate in a single call. See the table below for details.

If you want to...	Then...
Start a standard conference call by calling participants	During a connected call, press Confrn to add another party to the call. (You may need to press the more softkey to see Confrn .) Enter the conference participant's phone number. After the call connects and you have spoken to the conference participant, press Confrn again to add this party to your call. Repeat to add additional participants.
Invite current callers to join a standard conference	With two or more calls on a single line, scroll to highlight any call on the line and press Select . Repeat this process for each call you want to add to the conference. From one of the selected calls, press Join . (You may need to press the more softkey to see Join .) Note that the active call is selected and added to the conference automatically.
Participate in a standard conference	Answer the phone when it rings. You do not need to do anything special to participate in a standard conference call.
Barge (add yourself to) a call on a shared line and turn the call into a standard conference call	Highlight a remote-in-use call on a shared line and press cBarge . (You may need to press the more softkey to display cBarge .) Other parties on the call will hear a barge tone. See the "Using a Shared Line" section on page 31 for details.
View a list of conference participants	Highlight an active conference, and press ConfList . Participants are listed in the order in which they join the conference with the most recent additions at the top.
Get an updated list of conference participants	While viewing the conference list, press Update .
See who started the conference	While viewing the conference list, locate the person listed at the bottom of the list with an asterisk (*) next to the name.
Drop the last party added to the conference	Highlight the participant's name at the top of the conference list and press Remove . (The last participant is always listed at the top of the list.) Or, when not viewing the conference list, press RmLstC . You can remove participants only if you initiated the conference call.

If you want to...	Then...
Remove any conference participant	Highlight the participant's name and press Remove . You can remove participants only if you initiated the conference call.
End your participation in a standard conference	Hang up or press EndCall . If you did not initiate the conference call, hanging up will not disrupt the connection for the remaining parties. If you initiated the conference call, hanging up might end the conference (depending on how your system administrator configured your phone). To avoid this, you can transfer the conference to another caller before hanging up. That caller then acts as the "virtual controller" for the conference. A virtual controller cannot add or remove parties; however, the conference continues with the established participants.

Tips

- Calls must be on the same line before you can add them to a standard conference call. If calls are on different lines, transfer them to a single line before using **Confrn** or **Join**.
- If you get an error stating, "No Participant Info" when attempting to use **Join**, be sure that you have selected at least one call in addition to the active call, which is selected automatically.
- Depending on how your phone is configured, if you leave a conference after creating it, the conference might end. See the last row of the above table for more information.

Starting or Joining a Meet-Me Conference Call

Meet-Me conferencing allows participants to join a conference by calling the conference number directly, rather than waiting for the conference initiator to call them. See the following table for details.

If you want to...	Then...
Establish a Meet-Me conference	Press NewCall or lift the receiver to go off-hook. Then press MeetMe and dial the Meet-Me conference number. (See your administrator for a list of valid numbers.) Remember to inform participants about the conference number so that they can dial in. Participants will hear a busy tone if they call the conference number before you have dialed in.
Participate in a Meet-Me conference	Dial the Meet-Me conference number (provided by the conference initiator). You will be connected to the conference only after the conference initiator has dialed in.
End a Meet-Me conference	Hang up or press EndCall .

Advanced Call Handling

Advanced call-handling tasks involve special (non-standard) features that your system administrator might configure for your phone depending on your call-handling needs and work environment. You will not have access to these features unless your system administrator enables them for you.

Storing and Retrieving Parked Calls

You can park a call when you want to store the call so that you or someone else can retrieve it from another phone in the Cisco CallManager system (for example, a phone at a co-worker's desk or in a conference room). Call Park is a feature that your system administrator must enable for you.

If you want to...	Then...
Store an active call using Call Park	During a call, press Park . (You may need to press the more softkey to see Park .) This prompts your phone to store the call. Note the call park number displayed on your phone screen and hang up.
Retrieve a parked call	Enter the call park number from any Cisco IP Phone in your network to connect to the call. You have a limited amount of time to retrieve the parked call before it reverts to ringing at its original destination. See your system administrator for this time limit.

Picking Up a Redirected Call on Your Phone

Your system administrator might enable Call PickUp for your phone if you share call-handling responsibilities with co-workers. Call PickUp allows you to answer a call that is ringing on a co-worker's phone by redirecting the call to your phone. You can use Call PickUp features to handle calls for co-workers who are in your call pickup group (**PickUp**), who are in another pickup group (**GPickUp**), or who are in a group associated with your group (**OPickUp**).

If you want to...	Then...
Answer a call that is ringing on another extension within your call pickup group	Press PickUp to connect to the call. (You might have to go off-hook to press PickUp .) If your system administrator did not enable auto-pickup, the call will ring on your phone when you press PickUp . In this case, press Answer to connect to the call.
Answer a call that is ringing on another extension outside of your group	Press GPickUp . (You might have to go off-hook to press GPickUp .) Enter the group pickup code provided by your system administrator to connect to the call. If your system administrator did not enable auto-pickup, the call will ring on your phone when you press GPickUp and enter the group pickup code. In this case, press Answer to connect to the call.
Answer a call that is ringing on another extension in your group or in an associated group	Press OPickUp to connect to the call. (You might have to go off-hook to press OPickUp .) If your system administrator did not enable auto-pickup, the call will ring on your phone when you press OPickUp . In this case, press Answer to connect to the call.

Tips

- When you press **PickUp** and **GPickUp**, you connect to the call that has been ringing for the longest time.
- With **OPickUp**, your system administrator can associate multiple call pickup groups with your group and assign a priority to the groups. When you press **OPickUp**, you connect to the ringing call in the pickup group with the highest priority.
- If you want to pick up the call on an extension other than your primary line, first press an available line button and then press a Call PickUp softkey.

Using a Shared Line

Your system administrator might assign a “shared” phone line to you. Typically, a shared line has two main uses:

- One person uses multiple phones—For example, your shared line is assigned to both your desk phone and a lab phone. An incoming call to the shared line rings on both phones and you can use either phone to answer the call.
- Multiple people share a line—For example, you are one of many people who can handle incoming calls on the shared line, or you are a manager who shares an extension number with your assistant.

Understanding Shared Lines

Remote-in-Use

If you have a shared line, you might see the remote-in-use icon on your phone screen: . This icon indicates that a co-worker is currently using the shared line. You can place and receive calls as usual on a shared line, even when the remote-in-use icon appears.

Sharing Call Information and Barging

Unless a co-worker who shares your line has the Privacy feature enabled, you can see information on your phone screen about calls that your co-worker places and receives on the shared line. This information might include caller ID and call duration. Conversely, when you are using a shared line, information about your call is displayed on the co-worker’s phone screen.

When call information is visible in this way, you and co-workers can add yourselves to calls on the shared line using either the Barge or cBarge feature. Adding yourself to a call on a shared line is called *barging*. For more information about barging, see the “Adding Yourself to a Shared-Line Call” section on page 32.

Privacy



If you do not want co-workers who share your line to see information about your calls, enable the Privacy feature. Doing so also prevents co-workers from barging your calls. See the “Preventing Others from Viewing or Joining a Shared-Line Call” section on page 33.

Maximum Supported Calls on a Shared Line

The maximum number of calls that a shared line supports can vary by phone. Thus, at times you might not be able to make a new call on the shared line even if your co-worker can. For example, your phone supports a maximum of four calls on a shared line and your co-worker’s phone supports five calls on the same line. If there are four calls on the line, the **NewCall** softkey is unavailable to you but available to your co-worker.

Adding Yourself to a Shared-Line Call

Depending on how your phone is configured, you can add yourself to an established call on a shared line using Barge or cBarge. Typically, only *one* of these features will be available to you.







If you want to...	Then...
See if a co-worker has an active call on the shared line	<p>Look at the shared line number. When the line is in use from another phone, the line button displays red  and the remote-in-use icon appears: .</p> <p>If your co-worker has Privacy enabled, the Barge and cBarge softkeys are not available and you cannot barge the call. In this case, you cannot view information for the private call on your touchscreen, but you can still use the shared line to place and receive new calls.</p>
View current calls on the shared line	Press the red line button  for the remote-in-use line. All non-private calls appear in the call activity area of the touchscreen.
Add yourself to a call on a shared line using the Barge softkey	<p>Highlight a remote-in-use call on your phone screen and press Barge. (You may need to press the more softkey to display Barge.) Other parties hear a beep tone announcing your presence.</p> <p>When you hang up, the remaining parties hear a disconnect tone and the original call continues.</p>
Add yourself to a call on a shared line using the cBarge softkey	<p>Highlight a remote-in-use call on your touchscreen and press cBarge. (You may need to press the more softkey to display cBarge.) Other parties hear a tone and brief audio interruption, and call information changes on the phone screen.</p> <p>Note that, unlike Barge, cBarge converts the call into a standard conference call, allowing you to add new conference participants to the call. (To learn more about conference features that you can use with cBarge, see the “Making Conference Calls” section on page 26.)</p> <p>When you hang up, the call remains a conference call (provided at least three participants remain on the line).</p>

Tips

- **Barge** and **cBarge** softkeys are not available for private calls.
- You cannot barge an encrypted call if the phone you are using is not configured for encryption. When your barge attempt fails for this reason, your phone plays a fast busy tone. See the “Making and Receiving Secure Calls” section on page 34.
- You will be disconnected from a call that you have joined using **Barge** if the call is put on hold, transferred, or turned into a conference call.

Preventing Others from Viewing or Joining a Shared-Line Call

If you share a phone line, you can use the Privacy feature to prevent others who share the line from viewing or barging your calls (adding themselves to calls on the shared lines using the Barge or cBarge feature).

If you want to...	Then...
Prevent others from viewing or barging any calls on a shared line	Enable Privacy by pressing the button labeled Private  . When Privacy is on, this icon appears next to the Privacy button  and the button illuminates amber  .
Allow others to view or barge any calls on a shared line	Disable Privacy by pressing the button labeled Private  . When Privacy is off, this icon appears next to the Privacy button  and the button appears unlit  .

Tips

- If the phone that shares your line has Privacy enabled, you can make and receive calls using the shared line as usual. However, you cannot add yourself to existing calls on the shared line, and the barge softkeys will not be available to you.
- The Privacy feature applies to all shared lines on your phone. Consequently, if you have multiple shared lines on your phone and Privacy is enabled, coworkers will not be able to view or barge calls on any of your shared lines.

Tracing Suspicious Calls

If you are receiving suspicious or malicious calls, your system administrator can add the Malicious Call Identification (MCID) feature to your phone. This feature enables you to identify an active call as suspicious, which initiates a series of automated tracking and notification messages.



If you want to...	Then...
Notify your system administrator about a suspicious or harassing call	Press MCID . You will hear a special tone and see the message, “MCID successful” on your phone. The call remains active until you end the call.

Making and Receiving Secure Calls

Depending on how your system administrator has configured your phone system, your phone might support making and receiving secure calls.

Your phone is capable of supporting these types of calls:

- *Authenticated* call—The identities of all phones participating in the call have been verified.
- *Encrypted* call—The phone is receiving and transmitting encrypted audio (your conversation) within the Cisco IP network. Encrypted calls are also authenticated.
- *Non-secure* call—At least one of the participating phones or the connection does not support these security features, or the phones cannot be verified.

If you want to...	Then...
Check the security level of a call	Look for a security icon in the top right corner of the call activity area, next to the call duration timer:  Authenticated call  Encrypted call Neither security icon appears if the call is non-secure.
Determine if secure calls can be made in your company	Contact your system administrator.







Note There are interactions, restrictions, and limitations that affect how security features work on your phone. For more information, ask your system administrator.

Prioritizing Critical Calls

In some specialized environments, such as military or government offices, you might need to make and receive urgent or critical calls. If you have the need for this specialized call handling, your system administrator can add Multilevel Precedence and Preemption (MLPP) to your phone.

Keep these terms in mind:

- *Precedence* indicates the priority associated with a call.
- *Preemption* is the process of ending an existing, lower priority call while accepting a higher priority call that is sent to your phone.







If you...	Then...
Want to choose a priority (precedence) level for an outgoing call	Contact your system administrator for a list of corresponding precedence numbers for calls.
Want to make a priority (precedence) call	Enter the MLPP access number (provided by your system administrator) followed by the phone number.
Hear a special ring (faster than usual) or special call waiting tone	You are receiving a priority (precedence) call. An MLPP icon on your phone screen indicates the priority level of the call.
Want to view priority level of a call	<p>Look for an MLPP icon on your phone screen:</p> <ul style="list-style-type: none">  Priority call  Medium priority (immediate) call  High priority (flash) call  Highest priority (flash override) or Executive Override call <p>Higher priority calls are displayed at the top of your call list. If you do not see an MLPP icon, the priority level of the call is normal (routine).</p>
Want to accept a higher-priority call	Answer the call as usual. If necessary, end an active call first.
Hear a continuous tone interrupting your call	You or the other party are receiving a call that must preempt the current call. Hang up immediately to allow the higher priority call to ring through.

Tips

- When you make or receive an MLPP-enabled call, you will hear special ring tones and call waiting tones that differ from the standard tones.
- If you enter an invalid MLPP access number, a verbal announcement will alert you of the error.

Using a Handset, Headset, and Speakerphone

The table below describes how to use these devices.

If you want to...	Then...
Use the handset	Lift it to go off-hook; replace it to go on-hook.
Use a headset	<p>Press  to toggle headset mode on and off. (AutoAnswer users should see the “Using AutoAnswer with a Headset or the Speakerphone” section on page 37 for exceptions.)</p> <p>You can use the headset in conjunction with all of the controls on your phone, including  and .</p> <p>See the “Obtaining a Headset” section on page 36 for headset purchasing information.</p>
Use the speakerphone	<p>Press  to toggle speakerphone mode on or off.</p> <p>Many of the actions you can take to dial a number or answer a call will automatically trigger speakerphone mode, assuming that the handset is in its cradle and  is not lit.</p>
Switch to the headset or speakerphone (from the handset) during a call	Press  or  , then hang up the handset.
Switch to the handset (from the speakerphone or headset) during a call	Lift the handset (without pushing any buttons).

Tips





- See the “Connecting Your Phone” section on page 6 to locate the headset port.
- See the “Basic Call Handling” section on page 18 for detailed instructions about how to use the handset, headset, and speakerphone to place, answer, end, and otherwise handle calls.

Obtaining a Headset

Your phone supports four- or six-wire headset jacks. For information about purchasing headsets, see the “Headset Information” section on page 7 and go to the following URL: <http://vxicorp.com/cisco>

Using AutoAnswer with a Headset or the Speakerphone

You might use AutoAnswer if you receive a high volume of incoming calls or handle calls on behalf of others. Your system administrator configures AutoAnswer to work with either your speakerphone or headset. See the table below for details.

If you...	Then...
Use AutoAnswer with a headset	<p>Keep headset mode active (in other words, keep  illuminated) even when you are not on a call. To keep headset mode active, press EndCall to hang up (rather than pressing  to end the call), then press NewCall or Dial when placing new calls.</p> <p>If your phone is set up to use AutoAnswer in headset mode, calls will be answered automatically only if  is lit. Otherwise, calls will ring normally and you will need to manually answer them.</p>
Use AutoAnswer with the speakerphone	<p>Keep the handset in the cradle and headset mode inactive (in other words, keep  unlit).</p> <p>If your phone is set up to use AutoAnswer in speakerphone mode, calls will be answered automatically using the speakerphone only if the above criteria are met. Otherwise, calls will ring normally and you will need to manually answer them.</p>



Customizing Phone Settings

You can personalize your Cisco IP Phone by adjusting settings, as described in the tables below. Keep in mind a few tips when reviewing this information:

- Most settings are accessible on your phone, but a few are accessed online from your User Options web pages. See the “Logging In to the User Options Web Pages” section on page 43 for more information.
- If  is not responsive, your system administrator might have disabled this button on your phone. Ask your system administrator for more information.

Adjusting the Volume

The table below describes how to adjust and save volume levels on your phone.

If you want to...	Then...
Adjust the volume level for a call	Press  during a call or after invoking a dial tone. You can press Save to save this volume setting for future calls. Note that volume settings for the handset, speakerphone, and headset must be adjusted separately.
Adjust the volume level for the ringer	Press  while the handset is in the cradle and the headset and speakerphone buttons are off. The new ringer volume is saved automatically.





Customizing Rings and Message Indicators

You can customize the way your phone indicates an incoming call or a new voice mail message for each of your lines. Customized ring sounds and other indicators can help you quickly differentiate between multiple lines. For example, you can choose a chirping sound to indicate an incoming call on Line 1 and a drumbeat to indicate an incoming call on Line 2.

If you want to...	Then...
Change the ring sound	Choose  > User Preferences > Rings . Choose a phone line or the default ring setting. Next, choose a ring type to play a sample of it. When you find a ring sound that you want, press Select and Save . Press Cancel to revert to the previously saved setting. Press Default to apply the default ring setting to a selected phone line.
Change the ring pattern (flash-only, ring once, beep-only, etc.)	Log in to your User Options web pages, select your device, then choose Change the Ring Settings for your phone from the main menu. Note that your system administrator might need to enable this option.
Change the way that the voice message light on your handset works	Log in to your User Options web pages, select your device, then choose Change the Message Waiting Lamp policy... from the main menu. Typically, the default system policy tells your phone to “always light” when you receive a new voice message.

Customizing the Touchscreen

You can adjust the touchscreen to fit your needs. See the table below.

If you want to...	Then...
Change the touchscreen brightness	Choose  > User Preferences > Brightness . To make adjustments, press Up , Down or  . Then press Save . Press Cancel to revert to the previously saved setting.
Adjust the touchscreen to accommodate your viewing angle	Choose  > User Preferences > Viewing Angle . To make adjustments, press Up , Down or  . Then press Save . Press Cancel to revert to the previously saved setting.
Change the background image	Choose  > User Preferences > Background Images . To view available images, use the touchscreen or Navigation button. Press Select to choose an image. Press Preview if you want to see how the background will look and Exit to return to the selection menu. Press Save to accept the image or press Cancel to revert to the previously saved setting.
Change the language on your touchscreen	Log in to your User Options web pages, select your device, then choose Change the Locale... from the main menu.

Setting Up Speed Dial Features

Speed dial features allow you to press a button or enter an index code to place a call.

You can set up speed dialing for your phone in two ways:

- Speed dialing with a button—You can assign a speed dial number to any available programmable button on your phone that has not already been configured as a line, feature, or service button.
- Speed dialing with an index code—Using the Abbreviated Dialing feature, you can enter an assigned index number (1 to 99) rather than dialing the entire phone number.

Set up both types of speed dial features from your User Options web pages, as described in the table below. (See the “Logging In to the User Options Web Pages” section on page 43 for more information about your User Options pages.)

If you want to...	Then...
Add speed dial numbers to phone buttons	Log in to your User Options web pages, select your device, then choose Add/Update Speed Dials from the main menu. In the Speed Dial Settings on Phone section, enter a phone number and label for each available speed dial button. Enter the number exactly as you would dial it from your desk phone. For example, enter an access code such as 9 or the area code, if necessary. The label you enter appears next to the speed dial button on your touchscreen.
Add speed dial numbers to use with Abbreviated Dialing	Log in to your User Options web pages, select your device, then choose Add/Update Speed Dials from the main menu. In the Speed Dial Settings not associated with a phone button section, enter a phone number and label for each available speed dial button. Enter the number exactly as you would dial it from your desk phone. For example, enter an access code such as 9 or the area code, if necessary.
Remove a speed dial number	Delete the phone number and label from either of the speed dial web pages.

Tips



- For details on making calls using either speed dial feature, see the “Placing a Call” section on page 18.
- Your system administrator can assign speed dial buttons to your phone and restrict the number of speed dial buttons that you can configure.

Using Voice Messaging, Call Logs, and Directories

This section describes how you can use feature buttons to access voice messages, call logs, and directories.



Accessing Voice Messages

Your company determines the voice message service that your phone system uses. For the most accurate and detailed information about this service, refer to the documentation that came with it. For a general overview of voice message service features, refer to the table below.

If you want to...	Then...
Set up and personalize your voice message service	Press  and follow the voice instructions. If a menu appears on your touchscreen, choose an appropriate menu item.
See if you have a new voice message	Look at your phone for the following indicators: <ul style="list-style-type: none"><li data-bbox="427 789 1237 846">• A steady red light on your handset. (This indicator can vary. See the “Customizing Rings and Message Indicators” section on page 39.)<li data-bbox="427 857 1233 886">• A flashing envelope icon  and text message on your touchscreen.
Listen to your voice messages or access the voice messages menu	Press  . Depending on your voice message service, doing so either auto-dials the message service or provides a menu on your touchscreen.
Send a call to your voice message system	Press iDivert . The iDivert feature automatically transfers a call (including a ringing or held call) to your voice message system. Callers will hear your voice message greeting and can leave you a message.

Using Call Logs and Directories

Your phone maintains logs of your missed, placed, and received calls. You can use the Directories button to access these records. You can also access a corporate directory (if available).

If you want to...	Then...
View your call logs	Choose  > Missed Calls , Placed Calls , or Received Calls . Each log can store up to 100 records.
Dial from a call log	<p>Choose a listing and go off-hook. If you need to edit the number displayed in the record (to add or to remove a prefix, for example), press EditDial followed by << or >> to erase digits or move the cursor.</p> <p>If you want to dial from a call log while on an active call, scroll to a call record and press Dial. Then choose a menu item to handle the original call:</p> <ul style="list-style-type: none">• Hold—Puts the first call on hold and dials the second.• Transfer—Transfers the first party to the second and drops you from the call. (Press Transfer again after dialing to complete the action.)• Conference—Creates a conference call with all parties, including you. (Press Confrn after dialing to complete the action.)• End Call—Disconnects the first call and dials the second.
Erase your call logs	Press  , then press Clear . Doing so erases your Missed, Placed, and Received call logs.
Dial from a corporate directory	<p>Choose  > Corporate Directory (exact name can vary). Search for a listing by entering letters with your keypad. (You can search using a partial name.) To dial from a listing, press it, or scroll to it and go off-hook.</p> <p>If you want to dial from a directory while on an active call, scroll to a listing and press Dial. Then choose a menu item to handle the original call:</p> <ul style="list-style-type: none">• Hold—Puts the first call on hold and dials the second.• Transfer—Transfers the first party to the second and drops you from the call. (Press Transfer again after dialing to complete the action.)• Conference—Creates a conference call with all parties, including you. (Press Confrn after dialing to complete the action.)• End Call—Disconnects the first call and dials the second.



Note

If the network shuts down or is reset, you might lose information in your call logs.

Accessing Your User Options Web Pages

Because your Cisco IP Phone is a network device, it can share information with other network devices in your company, including your computer and web-based services accessible using a web browser on your computer.

You can establish phone services, and control settings and features from your computer using the Cisco CallManager User Options web pages. Once you configure features and services on the web pages, you can access them on your phone.

For example, you can set up speed dial buttons from your web pages, then access them on your phone.

This section describes how to access your User Options web pages and how to subscribe to phone services. For more details about the features you can configure and the phone services to which you can subscribe, refer to *Customizing Your Cisco IP Phone on the Web* at the following URL:
http://www.cisco.com/univercd/cc/td/doc/product/voice/c_ipphon/index.htm

Logging In to the User Options Web Pages

Procedure

- Step 1** Obtain a User Options URL, user ID, and default password from your system administrator.
 - Step 2** Open a web browser on your computer and enter the URL (provided by your system administrator) and log on.
 - Step 3** From the general menu, select your device type (phone model) in the “Select a device” drop-down list.
After you make your selection, a context-sensitive menu appears with options appropriate for your device type.
-

Tips for Navigating the User Options Pages

- Select your device from the menu page to see all of your options.
- Click **Update** to apply and save your changes.
- Click **Return to the Menu** to get back to the context-sensitive menu.
- Click **Log Off** to exit the User pages.



Subscribing to Phone Services

Before you can access subscription phone services on your phone, you need to subscribe to them by using your computer to access the User Options web pages. (See the “Logging In to the User Options Web Pages” section on page 43 for help logging in.)

Phone services can include:

- Web-based information, such as stock quotes, movie listings, and weather reports
- Network data, such as corporate calendars and searchable directories
- Phone features, such as My Fast Dials and a Personal Address Book

Refer to the following table for more information.

If you want to...	Then do this after you log in and select your device type...
Subscribe to a service	From the main menu, choose Configure your Cisco IP Phone Services . Select a service from the “Available Services” drop-down list and click Continue . Enter more information upon request (such as a zip code or PIN), then click Subscribe .
Change or end subscriptions	From the main menu, choose Configure your Cisco IP Phone Services . Click a service in the “Your Subscribed Services” panel. Click Update after making changes, or click Unsubscribe .
Add a service to a programmable button 	After subscribing to a service, choose Add/Update your Service URL Buttons from the main menu. For each available button, select a service from the drop-down list and enter a text description. Click Update after making changes. Your system administrator determines how many programmable buttons are available for services and might assign service buttons to your phone.
Access a service on your phone	Press  on your phone. Or, if you have added a service to a programmable button  , press the button.
Learn how to use phone services	See <i>Customizing Your Cisco IP Phone on the Web</i> : http://www.cisco.com/univercd/cc/td/doc/product/voice/c_ipphon/index.htm

Understanding Additional Configuration Options

Your system administrator can configure your phone to use specific button and softkey templates along with special services and features, if appropriate. The table below provides an overview of some configuration options that you might want to discuss with your phone system administrator based on your calling needs or work environment.





Note You can locate Phone Guides and other documents listed in this table from the following URL: http://www.cisco.com/univercd/cc/td/doc/product/voice/c_ipphon/index.htm

If you...	Then...	For more information...
Need to handle more calls on your phone line	Ask your system administrator to configure your line to support more calls.	Talk to your system administrator or phone support team.
Need more than one phone line	Ask your system administrator to configure one or more additional directory numbers for you.	Talk to your system administrator or phone support team.
Need more speed dial buttons	First make sure that you are using all of your currently available speed dial buttons. If you need additional speed dial buttons, try using Abbreviated Dialing or subscribing to the Fast Dial service. Another option is to attach the Cisco IP Phone 7914 Expansion Module to your phone.	See the: <ul style="list-style-type: none">• “Setting Up Speed Dial Features” section on page 40• “Subscribing to Phone Services” section on page 44• <i>Cisco IP Phone 7914 Expansion Module Phone Guide</i>
Work with (or work as) an administrative assistant	Consider using: <ul style="list-style-type: none">• The Cisco IP Manager Assistant service• a shared line	See the: <ul style="list-style-type: none">• “Using a Shared Line” section on page 31• <i>Cisco IP Manager Assistant User Guide</i>
Want to use one extension for several phones	Request a shared line. This allows you to use one extension for your desk phone and lab phone, for example.	See the “Using a Shared Line” section on page 31.

If you...	Then...	For more information...
Share phones or office space with co-workers	Consider using: <ul style="list-style-type: none"> • Call Park to store and retrieve calls without using the transfer feature • Call Pickup to answer calls ringing on another phone • a shared line to view or join co-workers' calls • Cisco Extension Mobility to apply your phone number and user profile to a shared Cisco IP Phone 	Ask your system administrator about these features and see the: <ul style="list-style-type: none"> • “Advanced Call Handling” section on page 29 • “Using a Shared Line” section on page 31 • “Using the Extension Mobility Service” section in the document <i>Customizing Your Cisco IP Phone on the Web</i>
Answer calls frequently or handle calls on someone’s behalf	Ask your system administrator to set up the AutoAnswer feature for your phone.	See the “Using AutoAnswer with a Headset or the Speakerphone” section on page 37.
Need to make video calls	Consider using Cisco VT Advantage, which enables you to make video calls using your Cisco IP Phone, your personal computer, and an external video camera.	Contact your system administrator for additional assistance and see the <i>Cisco VT Advantage Quick Start Guide</i> and <i>User Guide</i> .
Want to temporarily apply your phone number and settings to a shared Cisco IP Phone	Ask your system administrator about the Cisco Extension Mobility Service.	See the “Using the Extension Mobility Service” section in the document <i>Customizing Your Cisco IP Phone on the Web</i> .

Troubleshooting Your Phone

This section tells you how to access information about your Cisco IP Phone and phone calls to help your system administrator or technician diagnose problems with your phone.

If you are asked to...	Then...
Access network configuration data	Choose  > Network Configuration and select the network configuration item that you want to view.
Access status data	Choose  > Status and select the status item that you want to view.
Access phone model information	Choose  > Model Information .



Note If  is not responsive, your system administrator might have disabled this button on your phone. Ask your system administrator for more information.

Using the Quality Reporting Tool

Your system administrator may temporarily configure your Cisco IP Phone with the Quality Reporting Tool (QRT) to troubleshoot performance problems. If QRT is enabled for your phone, you can use the **QRT** softkey to submit information about problem phone calls to your system administrator. (You might need to press the **more** softkey to display **QRT**.)

Depending on how your system administrator configured the Quality Reporting Tool for your phone, you can use the **QRT** softkey to:

- Immediately report an audio problem on a current call
- Select a general problem from a list of categories and choose reason codes

Cisco One-Year Limited Hardware Warranty Terms

There are special terms applicable to your hardware warranty and various services that you can use during the warranty period. Your formal Warranty Statement, including the warranties and license agreements applicable to Cisco software, is available on Cisco.com. Follow these steps to access and download the *Cisco Information Packet* and your warranty and license agreements from Cisco.com.

1. Launch your browser, and go to this URL:
http://www.cisco.com/univercd/cc/td/doc/es_inpk/cetrans.htm
The Warranties and License Agreements page appears.
2. To read the *Cisco Information Packet*, follow these steps:
 - a. Click the **Information Packet Number** field, and make sure that the part number 78-5235-03A0 is highlighted.
 - b. Select the language in which you would like to read the document.
 - c. Click **Go**.
 - d. The Cisco Limited Warranty and Software License page from the Information Packet appears.
 - e. Read the document online, or click the **PDF** icon to download and print the document in Adobe Portable Document Format (PDF).



Note

You must have Adobe Acrobat Reader to view and print PDF files. You can download the reader from Adobe's website: <http://www.adobe.com>

3. To read translated and localized warranty information about your product, follow these steps:
 - a. Enter this part number in the Warranty Document Number field:
78-10747-01C0
 - b. Select the language in which you would like to view the document.
 - c. Click **Go**.
The Cisco warranty page appears.
 - d. Read the document online, or click the **PDF** icon to download and print the document in Adobe Portable Document Format (PDF).

You can also contact the Cisco service and support website for assistance:

http://www.cisco.com/public/Support_root.shtml.

Duration of Hardware Warranty

One (1) Year

Replacement, Repair, or Refund Policy for Hardware

Cisco or its service center will use commercially reasonable efforts to ship a replacement part within ten (10) working days after receipt of a Return Materials Authorization (RMA) request. Actual delivery times can vary, depending on the customer location.

Cisco reserves the right to refund the purchase price as its exclusive warranty remedy.

To Receive a Return Materials Authorization (RMA) Number

Contact the company from whom you purchased the product. If you purchased the product directly from Cisco, contact your Cisco Sales and Service Representative.

Complete the information below, and keep it for reference.

Company product purchased from	
Company telephone number	
Product model number	
Product serial number	
Maintenance contract number	



Index

A

- abbreviated dialing **40**
- answering calls **22**
- audio problems **47**
- authenticated calls **34**
- AutoAnswer **37**
- AutoDial **18**

B

- barge
 - and privacy **33**
 - and shared lines **31**
 - using **32**
- buttons, identifying **9**

C

- call activity area, viewing **12**
- call forwarding **25**
- call logs
 - dialing from **18**
 - erasing **42**
 - viewing and dialing from **42**
- call park **29**
- call pickup **30**
- call waiting **22**

- CallBack **20**
- call-handling, advanced **29**
- call-handling, basic **18**
- calls
 - answering **22**
 - compared to lines **13**
 - conference features for **26**
 - ending **23**
 - forwarding **25**
 - handling multiple **15**
 - holding and resuming **23**
 - icons for **13**
 - maximum per line **13, 31**
 - multiple parties on **26**
 - muting **23**
 - parking **29**
 - placing **18**
 - prioritizing **35**
 - redirecting while ringing **22, 30**
 - reporting problems with **47**
 - secure **34**
 - selecting **14**
 - storing and retrieving **29**
 - transferring **24**
 - viewing **12, 15**
- cBarge, See barge

Cisco IP Phone

- adjusting height of **7**
 - connecting **6**
 - description of **9**
 - documentation for **2**
 - feature configuration for **17, 45**
 - illustration of **9**
 - online help for **17**
 - registering **7**
 - securing handset rest **7**
 - web-based services for **43**
- conference calls
- Meet-Me **26, 28**
 - standard **26, 27**
- corporate directory
- dialing from web page with **20**
 - using on phone **19**

D

- dialing, options for **18**
- directories button **11**
- directory
 - dialing from web page with **20**
 - using on phone **19, 42**
- display button **2, 11**
- documentation, accessing **2**

E

- encrypted calls **34**
- ending a call, options for **23**
- extension numbers, viewing **12**

F

- Fast Dial service
 - dialing with **20**
 - subscribing to **44**
- feature buttons
 - directories **11**
 - help **11**
 - messages **11**
 - services **11**
 - settings **11**
- feature menus **16**
- feature tabs **12**
- features, availability of **17, 45**
- footstand
 - adjusting **7**
 - button for **10**
- forwarding calls, options for **25**

G

- group call pickup **30**

H

- handset
 - light strip **11**
 - securing in cradle **7**
 - using **36**
 - volume **38**
- hanging up, options for **23**
- headset
 - answering calls with **22**
 - button for **11**

- hanging up with **23**
- mode **36**
- placing calls with **20**
- volume **38**

headset performance, general **7**

help button **11**

help, using **17**

hold

- and switching calls **15**
- and transferring **24**
- using **23**

I

icons, for call states **13**

installing, Cisco IP Phone **6**

K

keypad

- description of **11**
- entering text with **17**

L

line buttons **10**

lines

- description of **13**
- viewing **12**

M

Malicious Call Identification (MCID), using **33**

Meet-Me conferences **26, 28**

menus, using **16**

messages

- indicator for **39, 41**
- listening to **41**

messages button **11**

missed calls, records of **42**

MLPP, using **35**

multiple calls, handling **15**

mute button **11**

mute, using **23**

N

navigation button **11**

network configuration data, locating **47**

O

off-hook

- description of **14**
- dialing **18**

on-hook

- description of **14**
- dialing **18**

online help, using **17**

P

Personal Address Book (PAB)

- dialing from **20**
- subscribing to **44**

- phone lines
 - buttons for **10**
 - description of **13**
 - viewing **12**
- phone tab **12**
- placed calls, records of **42**
- placing calls, options for **18**
- pre-dial **14, 18**
- prioritizing calls **35**
- privacy
 - and shared lines **31**
 - using **33**
- programmable buttons
 - description of **10**
 - labels for **12**

Q

- QRT, using **47**

R

- received calls, records of **42**
- redial **18**
- remote-in-use icon for shared lines **31**
- resume, using **23**
- ringer
 - customizing **39**
 - indicator for **11**
 - volume **38**

S

- safety warnings **3**
- secure calls **34**
- selecting calls **14**
- services button **11**
- services, subscribing to **44**
- settings button **11**
- settings, customizing **38**
- shared lines
 - and remote-in-use icon **31**
 - description of **31**
 - maximum calls on **31**
 - with barge **32**
 - with privacy **33**
- softkey buttons
 - description of **11**
 - labels for **12**
- speakerphone
 - answering calls with **22**
 - button for **11**
 - hanging up with **23**
 - mode **36**
 - placing calls with **18**
 - volume **38**
- speed dial
 - buttons for **10**
 - configuring **40**
 - labels **12**
 - using **19**
- status data, locating **47**
- status line, viewing **12**
- suspicious calls, tracing **33**
- switching calls **15**

T

TAPS **7**

text, entering on phone **17**

Tool for Auto-Registered Phones Support **7**

touchscreen

- adjusting contrast **39**

- changing language **39**

- choosing items **2, 16**

- cleaning **2**

- disabling/enabling **2**

- features of **12**

- waking **2**

transferring, options for **24**

troubleshooting **47**

U

User Options web pages

- accessing **43**

- and phone services **44**

V

voice message indicator **41**

voice message service **41**

volume button **11**

volume, adjusting **38**

W

warnings, safety **3**

WebDialer **20**



Corporate Headquarters
Cisco Systems, Inc.
170 West Tasman Drive
San Jose, CA 95134-1706
USA
www.cisco.com
Tel: 408 526-4000
800 553-NETS (6387)
Fax: 408 526-4100

European Headquarters
Cisco Systems International BV
Haarlerbergpark
Haarlerbergweg 13-19
1101 CH Amsterdam
The Netherlands
www-europe.cisco.com
Tel: 31 0 20 357 1000
Fax: 31 0 20 357 1100

Americas Headquarters
Cisco Systems, Inc.
170 West Tasman Drive
San Jose, CA 95134-1706
USA
www.cisco.com
Tel: 408 526-7660
Fax: 408 527-0883

Asia Pacific Headquarters
Cisco Systems, Inc.
168 Robinson Road
#28-01 Capital Tower
Singapore 068912
www.cisco.com
Tel: +65 6317 7777
Fax: +65 6317 7799

Cisco Systems has more than 200 offices in the following countries. Addresses, phone numbers, and fax numbers are listed on the Cisco Website at www.cisco.com/go/offices

Argentina • Australia • Austria • Belgium • Brazil • Bulgaria • Canada • Chile • China PRC • Colombia • Costa Rica • Croatia • Cyprus • Czech Republic • Denmark • Dubai, UAE
Finland • France • Germany • Greece • Hong Kong SAR • Hungary • India • Indonesia • Ireland • Israel • Italy • Japan • Korea • Luxembourg • Malaysia • Mexico
The Netherlands • New Zealand • Norway • Peru • Philippines • Poland • Portugal • Puerto Rico • Romania • Russia • Saudi Arabia • Scotland • Singapore
Slovakia • Slovenia • South Africa • Spain • Sweden • Switzerland • Taiwan • Thailand • Turkey • Ukraine • United Kingdom • United States • Venezuela • Vietnam • Zimbabwe

CCSP, CCVP, the Cisco Square Bridge logo, Follow Me Browsing, and StackWise are trademarks of Cisco Systems, Inc.; Changing the Way We Work, Live, Play, and Learn, and iQuick Study are service marks of Cisco Systems, Inc.; and Access Registrar, Aironet, ASIST, BPX, Catalyst, CCDA, CCDP, CCIE, CCIP, CCNA, CCNP, Cisco, the Cisco Certified Internetwork Expert logo, Cisco IOS, Cisco Press, Cisco Systems, Cisco Systems Capital, the Cisco Systems logo, Cisco Unity, Empowering the Internet Generation, Enterprise/Solver, EtherChannel, EtherFast, EtherSwitch, Fast Step, FormShare, GigaDrive, GigaStack, HomeLink, Internet Quotient, IOS, IP/TV, iQ Expertise, the iQ logo, iQ Net Readiness Scorecard, LightStream, Linksys, MeetingPlace, MGX, the Networkers logo, Networking Academy, Network Registrar, Packet, PIX, Post-Routing, Pre-Routing, ProConnect, RateMUX, ScriptShare, SlideCast, SMARTnet, StrataView Plus, TeleRouter, The Fastest Way to Increase Your Internet Quotient, and TransPath are registered trademarks of Cisco Systems, Inc. and/or its affiliates in the United States and certain other countries.

All other trademarks mentioned in this document or Website are the property of their respective owners. The use of the word partner does not imply a partnership relationship between Cisco and any other company. (0502R)

© 2005 Cisco Systems, Inc. All rights reserved.



The Java logo is a trademark or registered trademark of Sun Microsystems, Inc. in the U.S. or other countries.