



# **IP Office Release 6**

## **H323 IP Telephone Installation**

#### Notices

While reasonable efforts have been made to ensure that the information in this document is complete and accurate at the time of printing, Avaya assumes no liability for any errors. Avaya reserves the right to make changes and corrections to the information in this document without the obligation to notify any person or organization of such changes.

#### Documentation disclaimer

Avaya shall not be responsible for any modifications, additions, or deletions to the original published version of this documentation unless such modifications, additions, or deletions were performed by Avaya.

End User agree to indemnify and hold harmless Avaya, Avaya's agents, servants and employees against all claims, lawsuits, demands and judgments arising out of, or in connection with, subsequent modifications, additions or deletions to this documentation, to the extent made by End User.

#### Link disclaimer

Avaya is not responsible for the contents or reliability of any linked Web sites referenced within this site or documentation(s) provided by Avaya. Avaya is not responsible for the accuracy of any information, statement or content provided on these sites and does not necessarily endorse the products, services, or information described or offered within them. Avaya does not guarantee that these links will work all the time and has no control over the availability of the linked pages.

#### Warranty

Avaya provides a limited warranty on this product. Refer to your sales agreement to establish the terms of the limited warranty. In addition, Avaya's standard warranty language, as well as information regarding support for this product, while under warranty, is available to Avaya customers and other parties through the Avaya Support Web site: <http://www.avaya.com/support>. Please note that if you acquired the product from an authorized Avaya reseller outside of the United States and Canada, the warranty is provided to you by said Avaya reseller and not by Avaya.

#### Licenses

THE SOFTWARE LICENSE TERMS AVAILABLE ON THE AVAYA WEBSITE, [HTTP://SUPPORT.AVAYA.COM/LICENSEINFO/](http://support.avaya.com/licenseinfo/) ARE APPLICABLE TO ANYONE WHO DOWNLOADS, USES AND/OR INSTALLS AVAYA SOFTWARE, PURCHASED FROM AVAYA INC., ANY AVAYA AFFILIATE, OR AN AUTHORIZED AVAYA RESELLER (AS APPLICABLE) UNDER A COMMERCIAL AGREEMENT WITH AVAYA OR AN AUTHORIZED AVAYA RESELLER. UNLESS OTHERWISE AGREED TO BY AVAYA IN WRITING, AVAYA DOES NOT EXTEND THIS LICENSE IF THE SOFTWARE WAS OBTAINED FROM ANYONE OTHER THAN AVAYA, AN AVAYA AFFILIATE OR AN AVAYA AUTHORIZED RESELLER, AND AVAYA RESERVES THE RIGHT TO TAKE LEGAL ACTION AGAINST YOU AND ANYONE ELSE USING OR SELLING THE SOFTWARE WITHOUT A LICENSE. BY INSTALLING, DOWNLOADING OR USING THE SOFTWARE, OR AUTHORIZING OTHERS TO DO SO, YOU, ON BEHALF OF YOURSELF AND THE ENTITY FOR WHOM YOU ARE INSTALLING, DOWNLOADING OR USING THE SOFTWARE (HEREINAFTER REFERRED TO INTERCHANGEABLY AS "YOU" AND "END USER"), AGREE TO THESE TERMS AND CONDITIONS AND CREATE A BINDING CONTRACT BETWEEN YOU AND AVAYA INC. OR THE APPLICABLE AVAYA AFFILIATE ("AVAYA").

Avaya grants End User a license within the scope of the license types described below. The applicable number of licenses and units of capacity for which the license is granted will be one (1), unless a different number of licenses or units of capacity is specified in the Documentation or other materials available to End User. "Designated Processor" means a single stand-alone computing device. "Server" means a Designated Processor that hosts a software application to be accessed by multiple users. "Software" means the computer programs in object code, originally licensed by Avaya and ultimately utilized by End User, whether as stand-alone products or pre-installed on Hardware. "Hardware" means the standard hardware originally sold by Avaya and ultimately utilized by End User.

#### License types

Designated System(s) License (DS). End User may install and use each copy of the Software on only one Designated Processor, unless a different number of Designated Processors is indicated in the Documentation or other materials available to End User. Avaya may require the Designated Processor(s) to be identified by type, serial number, feature key, location or other specific designation, or to be provided by End User to Avaya through electronic means established by Avaya specifically for this purpose.

#### Copyright

Except where expressly stated otherwise, no use should be made of materials on this site, the Documentation(s) and Product(s) provided by Avaya. All content on this site, the documentation(s) and the product(s) provided by Avaya including the selection, arrangement and design of the content is owned either by Avaya or its licensors and is protected by copyright and other intellectual property laws including the sui generis rights relating to the protection of databases. You may not modify, copy, reproduce, republish, upload, post, transmit or distribute in any way any content, in whole or in part, including any code and software. Unauthorized reproduction, transmission, dissemination, storage, and or use without the express written consent of Avaya can be a criminal, as well as a civil, offense under the applicable law.

#### Third Party Components

Certain software programs or portions thereof included in the Product may contain software distributed under third party agreements ("Third Party Components"), which may contain terms that expand or limit rights to use certain portions of the Product ("Third Party Terms"). Information regarding distributed Linux OS source code (for those Products that have distributed the Linux OS source code), and identifying the copyright holders of the Third Party Components and the Third Party Terms that apply to them is available on the Avaya Support Web site: <http://support.avaya.com/Copyright>.

#### Preventing toll fraud

"Toll fraud" is the unauthorized use of your telecommunications system by an unauthorized party (for example, a person who is not a corporate employee, agent, subcontractor, or is not working on your company's behalf). Be aware that there can be a risk of toll fraud associated with your system and that, if toll fraud occurs, it can result in substantial additional charges for your telecommunications services.

#### Avaya fraud intervention

If you suspect that you are being victimized by toll fraud and you need technical assistance or support, call Technical Service Center Toll Fraud Intervention Hotline at +1-800-643-2353 for the United States and Canada. For additional support telephone numbers, see the Avaya Support Web site: <http://support.avaya.com>. Suspected security vulnerabilities with Avaya products should be reported to Avaya by sending mail to: [securityalerts@avaya.com](mailto:securityalerts@avaya.com).

#### Trademarks

Avaya and Aura are trademarks of Avaya, Inc. The trademarks, logos and service marks ("Marks") displayed in this site, the documentation(s) and product(s) provided by Avaya are the registered or unregistered Marks of Avaya, its affiliates, or other third parties. Users are not permitted to use such Marks without prior written consent from Avaya or such third party which may own the Mark. Nothing contained in this site, the documentation(s) and product(s) should be construed as granting, by implication, estoppel, or otherwise, any license or right in and to the Marks without the express written permission of Avaya or the applicable third party. Avaya is a registered trademark of Avaya Inc. All non-Avaya trademarks are the property of their respective owners.

#### Downloading documents

For the most current versions of documentation, see the Avaya Support Web site: <http://www.avaya.com/support>

#### Contact Avaya Support

Avaya provides a telephone number for you to use to report problems or to ask questions about your product. The support telephone number is 1-800-242-2121 in the United States. For additional support telephone numbers, see the Avaya Web site: <http://www.avaya.com/support>

# Contents

## 1. IP Office H323 IP Phones

- 1.1 What is New ..... 8
- 1.2 Supported Phones..... 10
- 1.3 System Capacity..... 11
- 1.4 Phone Firmware..... 12
- 1.5 Simple Installation..... 13
- 1.6 Installation Requirements..... 14
- 1.7 Licenses ..... 15
- 1.8 Network Assessment..... 16
- 1.9 Voice Compression..... 17
- 1.10 QoS ..... 19
- 1.11 Potential VoIP Problems..... 19
- 1.12 User PC Connection..... 20
- 1.13 Power Supply Options..... 21
- 1.14 File Server Options..... 23
- 1.15 File Auto Generation..... 24
- 1.16 Control Unit Memory Card..... 25

## 2. Installation

- 2.1 Adding Licenses..... 30
- 2.2 Creating/Editing the Settings File..... 31
- 2.3 Manually Creating Extensions..... 33
- 2.4 Phone Connection..... 34
- 2.5 Static Address Installation..... 35
- 2.6 Phone Registration..... 36
- 2.7 Extension & User Setup..... 37
- 2.8 Phone Security..... 37
- 2.9 Backup Restore..... 38
- 2.10 Listing Registered Phones..... 41
- 2.11 Error Messages..... 42

## 3. Other Installation Options

- 3.1 VPN Remote Phones..... 44
- 3.2 VLAN and IP Phones..... 47

## 4. Static Administration Options

- 4.1 QOS Option Settings..... 55
- 4.2 Secondary Ethernet (Hub)/IR Interface  
Enable/Disable..... 55
- 4.3 View Details..... 56
- 4.4 Self-Test Procedure..... 57
- 4.5 Resetting a Phone..... 58
- 4.6 Site Specific Option Number..... 59
- 4.7 Automatic Gain Control..... 60

## 5. Restart Scenarios

- 5.1 Boot File Needs Upgrading..... 63
- 5.2 No Application File or Application File Needs  
Upgrading ..... 63
- 5.3 Correct Boot File and Application File Already  
Loaded ..... 63

## 6. Infrared Dialling

- 6.1 Enabling the IR Port..... 67
- 6.2 Dialling Phone Numbers..... 67
- 6.3 Beaming Files During a Call..... 68

## 7. Alternate DHCP Server Setup

- 7.1 Using a Windows DHCP Server..... 71
- 7.2 Alternate Options..... 74

## 8. WML Server Setup

- 8.1 Testing 4620 WML Browsing Using Xitami..... 77
- 8.2 Setting the Home Page..... 79
- 8.3 Apache Web Server WML Configuration..... 80
- 8.4 Microsoft IIS Web Server WML Configuration..... 80
- 8.5 Open URL Entry..... 81
- Index .....83



# Chapter 1.

# IP Office H323 IP Phones



# 1. IP Office H323 IP Phones

This documentation provides notes for the installation of [supported Avaya 1600, 4600 and 5600 IP](#) <sup>[10]</sup> phones onto IP Office phone systems. It should be used in conjunction with the existing installation documentation for those series of phones, especially the following:

- 9600 Series IP Telephones Administrator Guide (16-300698)
- 4600 Series IP Telephone LAN Administrator Guide (555-233-507).
- 1600 Series IP Telephones Administrators Guide (16-601443).

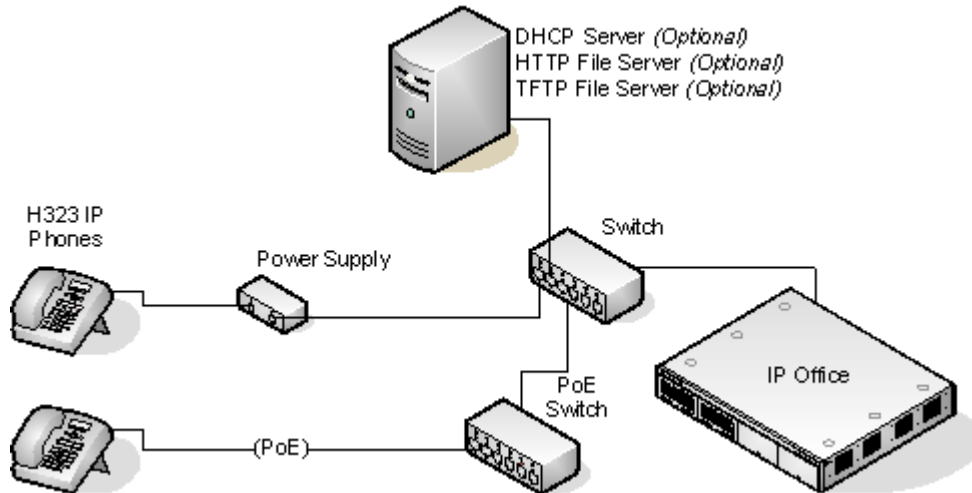

- DHCP versus Static IP Installation  
Though static IP installation of H323 IP phones is possible, installation using DHCP is strongly recommended. The use of DHCP eases both the installation process and future maintenance and administration. For static installations, following a boot file upgrade, all static address settings are lost and must be re-entered.
- Network Assessment  
High quality voice transmission across an IP network requires careful assessment of many factors. Therefore:
  - We strongly recommend that IP phone installation is only done by installers with VoIP experience.
  - The whole customer network must be assessed for its suitability for VoIP, before installation. Avaya may refuse to support any installation where the results of a network assessment cannot be supplied. See [Network Assessment](#) <sup>[16]</sup> for further details.

---

## 1.1 What is New

### IP Office Release 6

The following changes specific to Avaya H323 IP phone support have been made as part of the IP Office 5.0 release.

- **Avaya IP Phone Licenses**  
On IP500 and IP500 V2 systems, Avaya 1600, 4600, 5600, 9600, IP DECT, DECT R4, T3 IP, Spectralink and VPN phones are licensed by Avaya IP Endpoint licenses. These licenses are consumed by each phone as it registers with the IP Office system. Existing VCM channel resources and VCM Channel licenses enable a number of unlicensed phone registrations.
  - Existing VPN Remote licenses are no longer used. Phones using VPNremote client software require an Avaya IP Phones license.
  - Licenses are used on a first come first served basis as phones register with the IP Office system. Phones that register but cannot get a license will only be able to make emergency calls. Through the IP Office configuration, it is possible to pre-allocate available license capacity to selected extensions.
- **9600 Series Phones**  
IP Office Release 6 supports a number of phones from the 9600 Series of phones. Supported phones are the 9620L, 9620C, 9630G, 9640, 9640G, 9650 and 9650C.

### IP Office Release 5

The following changes specific to Avaya H323 IP phone support have been made as part of the IP Office 5.0 release.

- **Embedded Memory Card Usage**  
In order to simplify H323 phone installation and maintenance, a number of changes have been made, employing the Embedded Voicemail memory card supported by IP406 V2 and IP500 control units.
  - **Automatic File Loading**  
Using the Embedded File Management option within IP Office Manager, the option File | Upload Phone Files will transfer all necessary phone firmware files required for phones supported by IP Office 5.0 to the memory card. Those files are then available to the phones if the IP Office is configured as the HTTP/TFTP server for phones.
  - **[Auto-Generated File Operation](#)**<sup>[24]</sup>  
If the IP Office is configured as the HTTP/TFTP file server for H323 phones, the Embedded Voicemail memory card is used as the file store. The file server normally requires copies of various .scr and .txt files to be present. For IP Office 5.0, if those files are not present on the memory card, the IP Office will auto-generate a suitable file when it is requested by a phone.
- **Extension Quality of Service Measurement**  
Through the IP Office configuration, H323 IP phones (1600 Series, 4600 Series and 5600 Series) can be enabled to send QoS information to the IP Office system. For other types of extension, when their call involves a VCM channel, QoS information is available. The QoS information is round trip delay, jitter and packet loss. This information is used in a number of ways.
  - **QoS Display**  
Within the IP Office System Status Application (SSA), the current QoS measurements are shown for calls. This is in addition to the QoS measurement already displayed by SSA for IP trunks.
  - **QoS Alarms**  
QoS alarms thresholds can be set within the IP Office configuration. On calls where a threshold is exceeded, an alarm is generated at the end of the call. The alarm will contain the maximum value of all the QoS measurements. QoS alarms are shown in SSA. They can also be specified for output as alarms via SNMP, Syslog and/or email.
- **Resilience**  
IP Office 5.0 includes support for a number of 'resilience' features within an IP Office Small Community Network. This includes support for registered H323 phones and their users if the IP Office with which they are registered should not be available on the network. For details of resilience operation refer to the IP Office 5.0 Manager manual.
- **VLAN Setting**  
This option within the IP Office configuration (System | LAN1/LAN2 | VoIP) is applied to H323 phones using the IP Office for DHCP support. If set to *Disabled*, the L2Q value indicated to phones in the DHCP response is 2 (disabled). If set to *Not Present*, no L2Q value is included in the DHCP response.



## IP Office 4.2

The following changes specific to H323 IP phone support have been made as part of the IP Office 4.2 release.

- **Support for 1600 Series Phones**  
IP Office 4.2 Q4 2008+ supports the 1603, 1608, 1616 IP phones.
- **HTTP Server Support**  
For Avaya IP phones using IP Office DHCP, the address of the HTTP server from which those phones should download their software and settings files can now be specified in the IP Office configuration. 4600 Series and 5600 Series phones attempt to load files via HTTPS and then HTTP before falling back to TFTP. 1600 Series IP phones only support HTTPS or HTTP.
  - **HTTP-TFTP Relay**  
The IP Office control unit supports HTTP-TFTP relay for HTTP file requests from phones.
    - **HTTP-TFTP Using an Embedded Memory Card**  
For IP Office 4.2, using the Embedded Voicemail memory card is also supported for HTTP file requests for up to 50 IP phones. This is done by setting the TFTP Server IP Address and HTTP Server IP Address to the control unit IP address. This method is supported for up to 50 IP phones.
    - **HTTP-TFTP Using IP Office Manager**  
For the [IP Office 4.2 Q4 2008 maintenance release](#), HTTP-TFTP Relay is support using IP Office Manager as the TFTP server. This is done by setting the TFTP Server IP Address to the address of the Manager PC and the HTTP Server IP Address to the control unit IP address. This method is supported for up to 5 IP phones.
  - **HTTP User Backup and Restore**  
The HTTP file support methods detailed in this manual are for the download of phone firmware, settings and language files to phones. HTTP support for phone user settings backup and restore requires a separate HTTP server, the address of which is defined with the phone settings files rather than through the DHCP server configuration settings.
- **Secondary Site Specific Options Number**  
A Site Specific Option Number (SSON) is used by Avaya IP phones when requesting phone specific settings from a DHCP server. When the IP Office is acting as the DHCP server, the matching number must be set in the IP Office configuration. IP Office 4.2 now provides two fields for settings SSON numbers in order to support Avaya 4600 and 5600 Series IP Phones (which use a default SSON of 176) and Avaya 1600 Series phones (which use a default SSON of 242).
- **IP Phone Restart using System Status Application**  
Individual Avaya IP phones or groups of phones can be selected and then restarted remotely using the System Status Application. This allows individual phones or groups of phones to be restarted in order to upgrade their firmware.
- **IP500 DHCP Enhancements**  
The scope of DHCP support on IP500 has been enhanced in a number of areas.
  - **Full Avaya IP Phone Support**  
Previous only a maximum of 5 IP phones have been supported if using the IP Office for DHCP and TFTP functions. An external DHCP server is required to support more than 5 Avaya IP Phones. For IP Office 4.2+, the IP500 supports the full extension capacity of the IP500 control unit.
  - **Multiple DHCP IP Address Pools**  
On each IP Office LAN interface, up to 8 DHCP address ranges (called 'pools') can be specified. These pools do not have to be on the same subnet as the IP Office itself. This allows devices being supported by IP Office DHCP to be given addresses on a different subnet than the IP Office.
  - **DHCP for Avaya IP Phones Only**  
The DHCP pools provided by the IP Office can be restricted for use by Avaya IP phones only. The IP Office will then not respond to DHCP request from other devices.
- **Embedded Card File Management**  
For systems with a compact flash memory card installed, the contents of the card can be viewed through Manager. This mode is accessed through the File | Advanced | Embedded File Management option. This view can also be used to add and remove files from the card. This may be useful when the memory card is being used to store music on hold files and or phone firmware files.
- **IP500 VCM Controls**  
For IP Office 4.2+, the VCM controls for echo and comfort noise supported in the IP Office configuration (System | VCM) are now also applied to IP500 VCM cards.

## 1.2 Supported Phones

This documentation provides installation notes for the following Avaya IP phone supported by IP Office. Other Avaya IP phones, for example 3600 Series and IP DECT are covered by separate installation documentation.

H323 IP Phones	Supported Models	802.3af PoE Class		PC Port	IP Office Core Software
		Class	Idle		
1600 Series	1603	2	4.4W	–	4.2 Q4 2008 +.
	1603SW	2	4.4W	✓	
	1608	2	3.7W	✓	
	1616	2	2.7W	✓	
4600 Series	4601	2	3.5W	–	3.0+
	4602	1	–	–	2.1+.
	4602SW	2	3.5W	✓	
	4606	0	4.1W	✓	Up to 3.2.
	4610SW <sup>[1]</sup>	2	4.0W	✓	3.0+.
	4612	0	4.1W	✓	Up to 3.2.
	4620	3	4.0W	–	2.0+.
	4620SW	2	–	✓	
	4621SW <sup>[1]</sup>	2	5.75W	✓	3.0+.
	4624	0	4.1W	✓	Up to 3.2.
	4625	3	6.45W	✓	3.2+
5600 Series	5601	2	3.5W	–	3.0+.
	5602	1	–	–	
	5602SW	2	4.1W	✓	
	5610SW <sup>[1]</sup>	2	3.1W	✓	
	5620	3	3.6W	✓	
	5621SW <sup>[1]</sup>	2	–	✓	3.2+.
9600 Series	9620L	1	2.0W	✓	6+
	9620C	2	3.9W	✓	
	9630G	2	4.6W	✓	
	9640	2	3.9W	✓	
	9640G	2	3.9W	✓	
	9650	2	4.7W	✓	
	9650C	2	3.7W	✓	

### 1. VPNremote Support

These phones can also be used with VPNremote firmware.

### 2. 1603/1603SW

These phones require a PoE Splitter unit in order to user PoE.

## 1.3 System Capacity

System capacity can be separated into two aspects; the number of configurable phone extensions and the number of simultaneous IP phone calls.

### Extension Capacity

The maximum number of H323 IP phones supported by an IP Office system is based on that system's maximum capacity for extensions of any type as listed in the table below. To find the capacity for IP phones remove the number of physical non-IP extensions installed on the system, ie. extension ports on the IP Office control unit and any external expansion modules.

IP Office Unit	Maximum Extensions	Maximum VCM Channels
IP406 V2	190	30
IP412	360	60
IP500	384	128
IP500 V2	384	148

### Call Capacity

There are a number of situations where the IP Office system needs to provide a voice compression channel in order for an IP phone to make calls. These channels are provided by Voice Compression Modules (VCMs) installed in the IP Office system. The number of VCM channels required and how long the channel is required will depend on a number of factors. For further details see [Voice Compression](#) [17].

A simple summary is:

- A VCM channel is required during call setup.
- The VCM channel is released if the call is to/from another IP device using the same compression codec (the supported VCM codecs are G711, G729 and G723a).
- The VCM channel is used for the duration of the call when the call is to/from/via a non-IP device (extension or trunk line).
- It should be remembered that VCM channels are also used for calls from non-IP devices to IP lines if those are configured in the IP Office system (IP, SIP and SES lines).
- Calls from IP phones to the IP Office voicemail server use a VCM channel.
  - Note that on Small Office Edition systems with Embedded Voicemail, an additional channel is used for every call to voicemail.

---

## 1.4 Phone Firmware

The firmware in Avaya IP phones is upgradeable and different releases of firmware are made available via the Avaya support website. However H323 IP phones used on an IP Office system must only use the IP Phone software supplied with the IP Office Manager application. Other versions of IP Phone software may not have been tested with IP Office and so should not be used unless IP Office support is specifically mentioned in their accompanying documentation.

The phone firmware files are installed as part of the IP Office Manager application and are found in the applications installation directory. By default this is c:\Program Files\Avaya\IP Office\Manager.

For IP Office 4.2+, the firmware files are also available on the IP Office Administrator Applications CD from which IP Office Manager is installed. The files are located in the \program files\Avaya\IP Office\Manager folder of the installation files. This makes it easier to locate all the files needed for IP phone installation though it also includes the .bin files used for IP Office control and external expansion units.

## 1.5 Simple Installation

The diagram below shows a simple installation scenario that can be supported by all IP Office systems running IP Office Release 6.

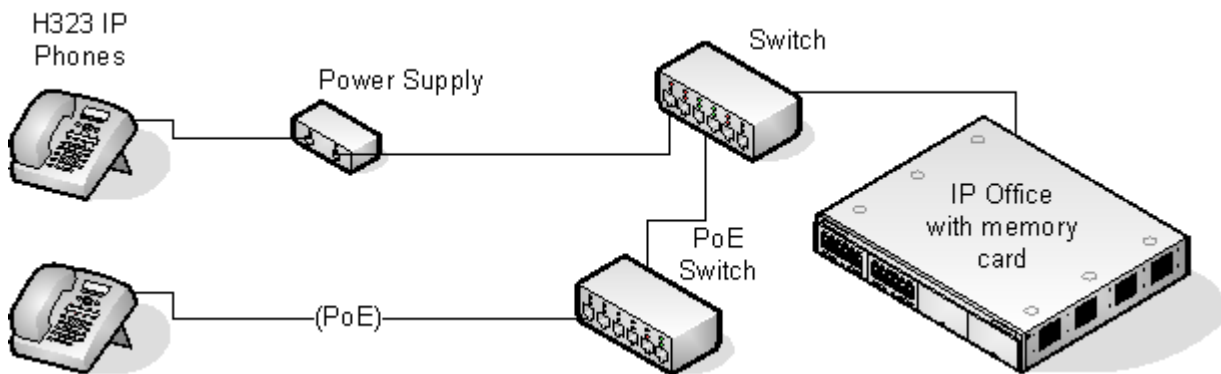

This type of installation uses the following equipment:

- IP Office  
The IP Office control unit is performing a number of roles for the phones:
  - DHCP Server  
The IP Office unit is acting as the DHCP server for the Avaya IP phones. Key settings such as the file server address are entered into the IP Office configuration and then provided to the phones in addition to their IP address. The IP Office DHCP server can be configured to provide DHCP addresses only in response to requests from Avaya IP phones. This allows an alternate DHCP server to be used for other devices that use DHCP.
    - The IP Office control unit can provide DHCP support for up to 272 phones. Alternatively a separate DHCP server can be used.
  - H323 Gatekeeper  
IP phones require an H323 gatekeeper to which they register. The gatekeeper then controls connecting calls to the phone. In this scenario the IP Office control unit acts as the H323 Gatekeeper.
  - File Server  
During installation the IP phones need to download software and settings files for a file server. If the IP Office control unit is fitted with a memory card (mandatory on IP500 v2 control units), that card can be used as the file source.
    - The IP Office control unit with memory card can act as the file server for up to 50 phones. Alternatively a 3rd-party HTTP server can be used.
- Switch  
The IP Office control units have limited numbers of LAN connection ports. They are intended to be connected to a LAN switch with port capacity for the customers network equipment.
- Power Supplies  
Each H323 IP phone requires a power supply.
  - Individual Power Supply Units  
An individual power supply unit can be used with each phone. This will require a power supply socket at each phone location. Note that for phones using a button module add-on, for example a EU24 or BM32, an individual power supply unit is a requirement.
  - Power over Ethernet Supply  
Most Avaya IP phones can be powered from an 802.3af Power over Ethernet (PoE) power supply. The IP Office system does not provide PoE ports so a separate PoE switch or PoE injector devices will be required to power a phone using PoE.

---

## 1.6 Installation Requirements

To install an IP phone on IP Office, the following items are required:

- Extension Number and User Details  
A full listing of the planned extension number and user name details is required. The planned extension number must be unused and is requested by the phone during installation.
- Power Supplies  
Each phone requires a power supply. Avaya IP phones do not draw power from the IP Office. A number of options exist for how power is supplied to the phones. See [Power Supply Options](#) [21].
- LAN Socket  
An RJ45 Ethernet LAN connection point is required for each phone.
- Category 5 Cabling  
All LAN cables and LAN cable infrastructure used with H323 IP phones should use CAT5 cabling. Existing CAT3 cabling may be used but will be limited to 10Mbps (maximum).
- LAN Cables  
Check that an RJ45 LAN cable has been supplied with the IP phone for connection to the power supply unit. You will also need an additional RJ45 LAN cable for connection from the power unit to the customer LAN.
  - A further RJ45 LAN cable can be used to connect the user's PC to the LAN via the IP phone [not supported on 4601, 4602, 5601 and 5602 H323 IP phones].
- Voice Compression Channels  
The IP Office Unit must have voice compression channels installed. Channels are required during the connection if calls involving IP phones and may also be required during the call. See [Voice Compression Channels](#) [17] for full details.
  - For Small Office Edition units, either 3 or 16 voice compression channels are pre-built into the unit.
  - For IP400 control units, voice compression channels are provided by fitting a [Voice Compression Module](#) [17].
  - For IP500 control units, channels are installed using a IP500 VCM base card and licenses or using IP400 VCM modules on an IP500 Legacy Card.
- DHCP Server  
The IP Office Unit can perform this role for up to 5 IP phone devices. If another DHCP server already exists, this may be able to do DHCP for the H323 IP phones, see [Alternate DHCP Servers](#) [70]. Static IP addressing can also be used, if required, but is not recommended.
  - For IP500 IP Office 4.2+ systems, up to 272 IP phones are supported using the IP Office Manager.
- HTTP/TFTP File Server  
A PC running the IP Office Manager application can perform this role for up to 5 H323 IP phones. An IP Office control unit with a memory card can use that memory card as the source for up to 50 phones. Otherwise an alternate HTTP file server is required.
- H323 Gatekeeper  
The IP Office Unit performs this role.
- IP Office Manager PC  
A PC running Manager is required for IP Office Unit configuration changes. This PC should have a static IP address.
- IP Telephone Software  
The software for IP phone installation is installed into the IP Office Manager program folder during Manager installation.
- Licence Keys  
For IP Office Release 6, licenses Avaya IP Endpoint licenses are required on IP500 and IP500 V2 systems. Refer to Licenses.

## 1.7 Licenses

The following licensing rules apply to the support of Avaya H323 IP phones on IP Office Release 6 systems.

### IP500 and IP500 V2 IP Office Systems

On IP500 and IP500 V2 systems, Avaya IP Endpoint licenses are required for Avaya H323 IP phones. This includes all 1600, 4600, 5600, 9600, IP DECT, DECT R4, T3 IP, Spectralink and VPN phones supported by IP Office Release 6.

- The system will automatically license 12 Avaya IP phones for each IP500 VCM 32 or VCM 64 card installed in the system without requiring additional licenses to be added to the configuration.
- Additional Avaya IP phones are licensed either by the addition of Avaya IP Endpoints licenses above or the conversion of legacy IP500 VCM Channels licenses to Channel Migration licenses (see below).
- By default licenses are consumed by each Avaya IP phone that registers with the IP Office in the order that they register. The license is released if the phone unregisters. However, it is possible to reserve a license for particular phones in order to ensure that they always obtain a license. This is done through the Reserve Avaya IP Endpoint License setting of each IP extension.
- Avaya IP phones without a license will still be able to register but will be limited to making emergency calls only (Dial Emergency short code calls). The associated user will be treated as if logged off and the phone will display *"No license available"*. If a license becomes available, it will be assigned to any unlicensed DECT handsets first and then to any other unlicensed Avaya IP phone in the order that the phones registered.
- For existing IP500 systems being upgraded to IP Office Release 6, the existing VCM channels and IP500 VCM Channels license are treated as follows:
  - For each IP400 VCM card installed in the system, each VCM channel supported by the card allows support for 3 Avaya IP phones.
  - For each IP500 VCM32 and IP500 VCM64 card installed in the system, the 4 unlicensed VCM channels previously provided by each card are converted to allow unlicensed support of 12 Avaya IP phones.
  - For each legacy IP500 VCM Channels license, the license are converted Channel Migration licenses supporting 3 Avaya IP phones. See the Channel Migration license below.
  - The IP500 VCM 32 and IP500 VCM 64 cards will provide their full capacity of VCM channels, ie. providing up to 32 or 64 channels depending on the card type and the codecs being used.

### Other IP Office Systems

On other IP Office systems, licenses are only required for phones using VPNremote firmware.

---

## 1.8 Network Assessment

-  **WARNING:** A Network Assessment is Mandatory  
When installing H323 IP phones on an IP Office system, it is assumed by Avaya that a network assessment has been performed. If a support issue is escalated to Avaya, Avaya may request to see the results of the network assessment and may refuse to provide support if a suitable network assessment was not performed.

Current technology allows optimum network configurations to deliver VoIP with voice quality close to that of the public phone network. However, few networks are optimum and so care should be taken assessing the VoIP quality achievable across a customer network.

Not every network is able to carry voice transmissions. Some data networks have insufficient capacity for voice traffic or have data peaks that will impact voice traffic on occasion. In addition, the usual history of growing and developing networks by integrating products from many vendors makes it necessary to test all the network components for compatibility with VoIP traffic.

A network assessment should include a determination of the following:

- A network audit to review existing equipment and evaluate its capabilities, including its ability to meet both current and planned voice and data needs.
- A determination of network objectives, including the dominant traffic type, choice of technologies and setting voice quality objectives.
- The assessment should leave you confident that the network will have the capacity for the foreseen data and voice traffic, and can support H323, DHCP, TFTP and jitter buffers in H323 applications.

The network assessment targets are:

- **Latency:** *Less than 180ms for good quality. Less than 80ms for toll quality.*  
This is the measurement of packet transfer time in one direction. The range 80ms to 180ms is generally acceptable. Note that the different audio codecs used each impose a fixed delay caused by the codec conversion as follows:
  - G711: 20ms.
  - G723a: 80ms.
  - G729: 40ms.
- **Packet Loss:** *Less than 3% for good quality. Less than 1% for toll quality.*  
Excessive packet loss will be audible as clipped words and may also cause call setup delays.
- **Jitter:** *Less than 20ms.*  
Jitter is a measure of the variance in the time for different packets in the same call to reach their destination. Excessive jitter will become audible as echo.
- **Duration:** *Monitor statistics once every minute for a full week.*  
The network assessment must include normal hours of business operation.



## 1.9 Voice Compression

Calls to and from IP devices can require conversion to the audio codec format being used by the IP device. For IP Office systems this conversion is done by voice compression channels. These support the common IP audio codecs G711, G723 and G729a.

For IP400 control units channels can be added by fitting IP400 Voice Compression Modules (VCMs). For the IP500 control units, channels can be added using IP500 VCM cards, IP500 Combination Cards and or IP400 Voice Compression Modules.

The voice compression channels are used as follows:

Call Type	Voice Compression Channel Usage
IP Device to Non-IP Device	These calls require a voice compression channel for the duration of the call. If no channel is available, busy indication is returned to the caller.
IP Device to IP Device	<p>Call progress tones (for example dial tone, secondary dial tone, etc) do not require voice compression channels with the following exceptions:</p> <ul style="list-style-type: none"> <li>• Short code confirmation, ARS camp on and account code entry tones require a voice compression channel.</li> <li>• Devices using G723 require a voice compression channel for all tones except call waiting.</li> </ul> <p>When a call is connected:</p> <ul style="list-style-type: none"> <li>• If the IP devices use the same audio codec no voice compression channel is used.</li> <li>• If the devices use differing audio codecs, a voice compression channel is required for each.</li> </ul>
Non-IP Device to Non-IP Device	No voice compression channels are required.
Music on Hold	This is provided from the IP Office's TDM bus and therefore requires a voice compression channel when played to an IP device.
Conference Resources and IP Devices	Conferencing resources are managed by the conference chip which is on the IP Office's TDM bus. Therefore, a voice compression channel is required for each IP device involved in a conference. This includes services that use conference resources such as call listen, intrusion, call recording and silent monitoring.
Page Calls to IP Device	IP Office 4.0 and higher only uses G729a for page calls, therefore only requiring one channel but also only supporting pages to G729a capable devices.
Voicemail Services and IP Devices	Calls to the IP Office voicemail servers are treated as data calls from the TDM bus. Therefore calls from an IP device to voicemail require a voice compression channel.
Fax Calls	These are voice calls but with a slightly wider frequency range than spoken voice calls. IP Office only supports fax across IP between IP Office systems with the Fax Transport option selected. It does not currently support T38.
T38 Fax Calls	<p>IP Office 5.0+ supports T38 fax on SIP trunks and SIP extensions. Each T38 fax call uses a VCM channel.</p> <p>Within a Small Community Network, a T38 fax call can be converted to a call across an H323 SCN lines using the IP Office Fax Transport Support protocol. This conversion uses 2 VCM channels.</p> <p>In order use T38 Fax connection, the Equipment Classification of an analog extension connected to a fax machine can be set <i>Fax Machine</i>. Additionally, a new short code feature Dial Fax is available.</p>

Note: T3 IP devices must be configured to 20ms packet size for the above conditions to apply. If left configured for 10ms packet size, a voice compression channel is needed for all tones and for non-direct media calls.

---

## Measuring Channel Usage

The IP Office System Status Application can be used to display voice compression channel usage. Within the Resources section it displays the number of channel in use. It also displays how often there have been insufficient channels available and the last time such an event occurred.

The IP500 VCM cards, the level of channel usage is also indicated by the LEDs (1 to 8) on the front of the IP500 VCM card.

## Installing VCM Cards

Refer to the IP Office Installation manual.

## 1.10 QoS

When transporting voice over low speed links it is possible for normal data packets (1500 byte packets) to prevent or delay voice packets (typically 67 or 31 bytes) from getting across the link. This can cause unacceptable speech quality.

Therefore, it is vital that all traffic routers and switches in the network to have some form of Quality of Service (QoS) mechanism. QoS routers are essential to ensure low speech latency and to maintain sufficient audible quality.

IP Office supports the DiffServ (RFC2474) QoS mechanism. This is based upon using a Type of Service (ToS) field in the IP packet header. On its WAN interfaces, IP Office uses this to prioritize voice and voice signalling packets. It also fragments large data packets and, where supported, provides VoIP header compression to minimize the WAN overhead.

### Note

- IP Office does not perform QoS for its Ethernet ports including the WAN Ethernet port on the Small Office Edition.

## 1.11 Potential VoIP Problems

It is likely that any fault on a network, regardless of its cause, will initially show up as a degradation in the quality of VoIP operation. This is regardless of whether the fault is with the VoIP telephony equipment. Therefore, by installing a VoIP solution, you must be aware that you will become the first point of call for diagnosing and assessing all potential customer network issues.

### Potential Problems

- **End-to-End Matching Standards**  
VoIP depends upon the support and selection of the same voice compression, header compression and QoS standards throughout all stages of the calls routing. The start and end points must be using the same compression methods. All intermediate points must support DiffServ QoS.
- **Avoid Hubs**  
Hubs introduce echo and congestion points. If the customer network requires LAN connections beyond the capacity of the IP Office Unit itself, Ethernet switches should be used. Even if this is not the case, Ethernet switches are recommended as they allow traffic prioritization to be implemented for VoIP devices and for other device such as the Voicemail Server PC.
- **Power Supply Conditioning, Protection and Backup**  
Traditional phone systems provide power to all their attached phone devices from a single source. In a VoIP installation, the same care and concern that goes into providing power conditioning, protection and backup to the central phone system, must now be applied to all devices on the IP network.
- **Multicasting**  
In a data only network, it is possible for an incorrectly installed printer or hub card to multicast traffic without that fault being immediately identified. On a VoIP network incorrect multicasting will quickly affect VoIP calls and features.
- **Duplicate IP Addressing**  
Duplicate addresses is a frequent issue.
- **Excessive Utilization**  
A workstation that constantly transmits high traffic levels can flood a network, causing VoIP service to disappear.
- **Network Access**  
An IP network is much more open to users connecting a new device or installing software on existing devices that then impacts on VoIP.
- **Cabling Connections**  
Technically VoIP can (bandwidth allowing) be run across any IP network connection. In practice, Cat5 cabling is essential.

---

## 1.12 User PC Connection

To simplify the number of LAN connections from the user's desk, it is possible to route their PC Ethernet LAN cable via some H323 IP phones. The LAN cable should be connected from the PC to the socket with a PC symbol (🖨) at the back of the IP phone. The PC's network configuration does not need to be altered from that which it previously used for direct connection to the LAN.

Except for phones with a G suffix this port supports 10/100Mbps ethernet connections. Phones with a G suffix also support 1000Mbps Gigabit connections. For other phones a separate Gigabit Adapter (SAP 700416985) must be used. This device splits the data and voice traffic before it reaches the phone, providing a 10/100Mbps output for the phone and a 10/100/1000Mbps output for the PC. The adapter is powered from the phone's existing PoE supply or 1151 type power supply unit. Refer to the "Gigabit Ethernet Adapter Installation and Safety Instructions" (16-601543).

## 1.13 Power Supply Options

Each H323 IP phone requires a power supply. They do not draw power from the IP Office phone system. Listed below are the power supply options that can be used.

### Spare Wire Power Options

The following power supplies use the normally unused pin 7 & 8 connections in the CAT3 or CAT5 network cable. This is referred to as "spare wire" or "mid-span" power supply units. They can be used with 4600 Series and 5600 Series IP phones.

- Avaya 1151D1 Power Supply Unit (PSU)  
A power supply unit for a single IP phone. Has a LINE port for the LAN cable from the IP Office, and a PHONE port for the LAN cable to the IP phone. Power into the PSU requires a 90 to 264V AC, 47 to 63HZ mains supply. A green LED indicates when power is available.



- Avaya 1151D2 Power Supply Unit  
Same as the 1151C1 above but with integral battery backup. When AC mains supply is removed, the battery will power the IP phone for between 8 hours at light load (2 Watts) and 15 minutes at full load (20 Watts). A green LED indicates when power is available. A yellow LED indicates when the backup is charging. The green LED flashes when the phone is running from the backup battery.

### Dedicated Plug-Top Power Supply Units

1600 Series IP phones can be powered using plug-top PSU's. Different models of PSU exist for various power outlet sockets. These connect to the phone using a barrel connector.

---

## 802.3af Power over Ethernet (PoE) Options

IEEE 802.3af is a standard commonly known as Power over Ethernet (PoE). It allows network devices to receive power via the network cable using the same wires as the data signals. All the H323 IP phones supported on IP Office also support this standard. Note that for phones being used with an add-on unit such as an EU24, EU24BL or BM32, an individual power supply must be used rather than PoE.

- Exceeding the Class limit of a PoE port or the total Class support of a PoE switch may cause incorrect operation.
- Avaya 1152A1 Power Distribution Unit (Mid-Span Power Unit)  
This is a 1U high 19-inch rack mountable unit. It is available in models to support 6, 12 or 24 PoE devices including H323 IP phones. For each device, it provides a RJ45 data in ports and a matching RJ45 data and power out port. It can support a maximum of 200 Watts or a peak of 16.8 Watts per port.



- Power of Ethernet (POE) Switch  
The Avaya P333T-PWR Switch is a Ethernet LAN switch which also provides PoE input for up to 24 devices including H323 IP phones.



- IP Phone Inline Adaptor  
This adaptor allows 4602, 4602SW, 4620, 4621 and 4625 H323 IP phones and 5600 Series equivalents to be powered from a Cisco Catalyst power blade. Using these adaptors, up to 24 H323 IP phones can be supported on a single power blade. The phones do not provide the Catalyst switch with information on their power requirements and future changes to Catalyst switch software may affect operation.



## 1.14 File Server Options

During installation and maintenance, the phones download software and settings files. In order to do this a phone first request files for an HTTPS server. If it gets no response it then tries to obtain the files from an HTTP server. 4600 and 5600 Series phones will then try TFTP. The address of the server to use is provided through DHCP or entered during static phone installation.

- The phones will check the file server every time they are restarted. However if they do not find it they will continue by using the existing files they have. Therefore there is no requirement for the file sever to be permanently available. The file server is only required during phone installation and maintenance.

The following options are available for the file server for IP phones being installed on an IP Office system.

File Server	Description	Up to X Phones	TFTP	HTTP	HTTPS
IP Office Manager	When running, the IP Office Manager acts as a HTTP/TFTP server for file requests from phones.	5	✓	✓	–
IP Office Unit Memory Card	For IP Office control units fitted with an additional memory card, that card can be used to provided the software files. Various other files can be <a href="#">auto-generated</a> <sup>(24)</sup> by the IP Office if not present on the memory card.	50	✓	✓	–
3rd Party Software	3rd Party HTTP and TFTP file server software is available from many sources including Avaya.	–	✓	✓	✓

---

## 1.15 File Auto Generation

For IP Office 5.0+, for systems configured to use the IP Office control unit's memory card as the file server source, the IP Office is able to auto-generate the necessary file in response to a phone request if the specific file is not present on the card. This operation is supported for the following files:

- **16xxupgrade.txt**  
This file will list the the firmware files for 1600 Series series phones supported by the IP Office. The last line will contain the filename *46xxsettings.txt*.
- **46xxupgrade.scr**  
This file will list the firmware files for 4600 Series and 5600 Series phones supported by the IP Office. The last line will contain the filename *46xxsettings.txt*.
- **96xxupgrade.txt**  
This file will list the the firmware files for 1600 Series series phones supported by the IP Office. The last line will contain the filename *46xxsettings.txt*.
  - For both the files above, the appropriate *.bin* files must be manually copied to the memory card. The IP Office 5.0 Manager application provides controls for this.
  - The contents of the files above are System Locale dependant as different firmware files are required to support certain language locales (for example Russia).
- **46xxsettings.txt**  
This file will match the file supplied with the IP Office 5.0+ Manager application except as follows:
  - The *BRIURI* value will be set to indicate the IP Office memory card as location for backup and restore actions.
  - The *LANG1FILE* to *LANG4FILE* values for 1600 Series phone non-English language files will be determined from the best match to the system locale and the most common user locales. Languages supported are Dutch, French, French (Canadian), German, Italian, Latin Spanish, Portuguese, Russian, Spanish.
- **1600 Series Language files**  
If the *46xxsettings.txt* file is auto-generated, the matching 1600 Series phone languages specified in that file will also be auto-generated.
- **<ext>\_16xxdata.txt**  
If the *46xxsettings.txt* file is auto-generated, it will specify the IP Office memory card as the location for phones to backup and restore user settings. If no file exists for a user, a file will be auto-generated.



## 1.16 Control Unit Memory Card

The memory card used with IP406 V2, IP500 and IP500 V2 systems can be used to store files including those used by Avaya IP Phones.

- Non-Avaya supplied Compact Flash memory cards can be used for this type of file storage. However, they will not support embedded voicemail.
- If an Avaya supplied memory card is used, any files stored in this way will reduce the message storage capacity of the Compact Flash memory card.
- The IP500 V2 control unit requires a System SD card at all times and this card normally holds a full set of IP Office firmware files including those used by Avaya IP phones.

### Transferring Files Using IP Office Manager

IP Office 4.2+ allows the contents of the memory card in a system to be viewed and updated. This is done using IP Office Manager and requires the same user name and password access as used for configuration changes.

1. Within IP Office Manager, select File | Advanced | Embedded File Management.
2. The Select IP Office discovery menu is shown. Select the IP Office systems whose memory card you want to view and click OK.
3. Enter a user name and password for configuration access to that system.
  - **TFTP: Received TFTP Error "Not Found"** in the Manager status bar indicates that no card was detected in the selected system. To select another system use File | Open File Settings. To return Manager to normal configuration mode select File | Configuration.
4. The contents of the card are shown in Manager.
  - For IP Office 5.0+, all the phone firmware files can be transferred by selecting File | Upload Phone Files or for IP500 V2 systems File | Upload System Files. This will automatically select the phone firmware files that Manager has available and transfer them to the memory card.
  - New files can be drag and dropped to the Files section of the currently selected folder or transferred using File | Upload File.... The transfer is serial and can be interrupted by other activities on the IP Office system. Therefore it is recommended that files are transferred in small batches.
  - Existing files can be deleted by right-clicking on the file and selecting Delete.
  - Files can be downloaded from the card by right-clicking on the file and selecting Download. The file is downloaded to the Manager applications working directory.
5. When transfers have been completed, to select another system use File | Open File Settings. To return Manager to normal configuration mode select File | Configuration.



# Chapter 2.

# Installation

---

## 2. Installation

Check the following before beginning installation:

### 1. IP Office Manager PC

Check that the applications for configuring and monitoring an IP Office system are available and able to connect to that system.

- Check that IP Office Manager and IP Office System Status Application (SSA) or System Monitor are installed and can be used to connect to the IP Office system.
- Verify that you can receive the configuration from the system and send it back to the IP Office.
- Ensure that the Manager PC has been given a static IP address.

### 2. Voice Compression Channels

The IP Office Unit must be fitted with a [voice compression channels](#) <sup>[17]</sup>. Use either SSA or System Monitor application to verify that the voice compression channels are available. SSA list the VCM channels on the Resources screen. The initial lines of Monitor output include the item *VCOMP=* which will state the number of channels installed in the control unit.

### 3. Avaya IP Endpoint Licenses

If installing onto an IP500 or IP500 V2 system, each phone requires a license.

### 4. File Server Settings

Using Manager, receive the configuration from the IP Office. Select System and then select the System tab. Check the following:

- System Name  
On the System tab ensure that a Name for the IP Office Unit has been entered.
- TFTP Server IP Address  
If using TFTP to download software file to the phones, enter the TFTP server address here. This address is used by the IP phones (excluding 1600 Series) being supported by IP Office DHCP. If another DHCP server is being used, that address must be set via the DHCP settings on that server, see [Alternate DHCP Setup](#) <sup>[70]</sup>.
  - The default *0.0.0.0* will cause the phones to broadcast for any TFTP server available on the same subnet as themselves.
  - To use the memory card installed in the system, enter the LAN1 IP address of the IP Office system (the address is shown on the LAN1 tab). To use this option the card must be loaded with the IP phone software files, see [Control Unit Memory Card](#) <sup>[23]</sup>.
  - If a 3rd-party TFTP server is being used, set the IP address to the address of the PC running that software.
- HTTP Server IP Address  
IP Office 4.2+ supports the use of HTTP for file requests from IP phones. This is necessary for 1600 Series phones and is supported by all other Avaya IP phones. This address is used by the IP phones being supported by IP Office DHCP. If another DHCP server is being used, that address must be set via the DHCP settings on that server, see [Alternate DHCP Setup](#) <sup>[70]</sup>.
  - The default *0.0.0.0* disables HTTP support.
  - For IP Office 4.2, using the Embedded Voicemail memory card is also supported for HTTP file requests for up to 50 IP phones. This is done by setting the TFTP Server IP Address and HTTP Server IP Address to match the control units IP address. This is supported for up to 50 IP phones.
  - If a 3rd-party HTTP server is being used, set the IP address to the address of the PC running that software.

### 5. H323 Gatekeeper Settings

Select System and then select the LAN1 tab. Select the Gatekeeper sub tab. Check the following settings:

- H323 Gatekeeper Enabled  
Ensure that this option is enabled.
- H323 Auto-created Extn  
This installation process assumes that this option is enabled until after installation of the phones has been completed. If not enabled the you must manually add extensions to the IP Office configuration before installation. See [Manually Creating Extensions](#) <sup>[33]</sup>.
- H323 Auto-create User  
This installation process assumes that this option is enabled until after installation of the phones has been completed. If not enabled the you must manually add users to the IP Office configuration before installation.
- Primary Site Specific Option Number  
Devices being supported by DHCP can request device specific information using a site specific option number (SSON). This method is used for Avaya IP phones to request phone specific information from a DHCP server. For IP phones being supported by IP Office DHCP, the SSON set here should match that being used by the phones. By default Avaya 4600 and 5600 Series IP phones use the 176 as their SSON.

- Secondary Site Specific Option Number (*IP Office 4.2+*)  
This field allows a second SSON to be specified for use by IP phones. By default Avaya 1600 Series IP phones use 242 as their SSON.

#### 6. DHCP Server

If not using the IP Office for DHCP, check that the alternate DHCP server has been configured for the IP phones. It will need to include details of the files server and gateway settings. See [Alternate DHCP Setup](#)<sup>[70]</sup>. If using the IP Office for DHCP, select System and then the LAN1 or LAN2 tab.

- DHCP Mode  
Check that the IP Office is set as *Server*. This allows it to respond to DHCP requests on its subnet.
- Number of DHCP IP Addresses  
Set this to a number sufficient for all the IP devices, including phones, that will be supported by the IP Office DHCP.
- Advanced/DHCP Pools (IP500 4.2+)  
For IP Office 4.2+ on IP500 systems, multiple ranges of IP addresses can be configured for use by IP Office DHCP. In addition, the IP Office DHCP can be restricted to Avaya IP phones only by selecting *Apply to Avaya IP Phones Only*.

#### 7. IP Phone Software and Settings Files

The software for IP phone installation is supplied on the IP Office Administrator Applications CD. Those files must be placed on the file server. The files are automatically installed as part of the IP Office Manager application and so are already present if IP Office Manager is used as the file server.

- If another source is used as the file server, the software and settings files must be copied to that server. For pre-IP Office 4.2 system the files must be copied from the Manager application folder. For IP Office 4.2+ the files can be copied from the location program files\Avaya\IP Office\Manager on the installation CD.
- If it does not exist already an additional file, *46xxsettings.txt*, is also required. See [Creating a 46xxsettings.txt File](#)<sup>[31]</sup>.

#### 8. Extension Number and User Name Details

A full listing of the planned extension number and user name details is required. The planned extension number must be unused and is requested by the phone during installation.

---

## 2.1 Adding Licenses

On IP500 and IP500 V2 systems, each Avaya IP phone requires a license. This includes all 1600, 4600, 5600, 9600, IP DECT, DECT R4, T3 IP, Spectralink and VPN phones supported by IP Office Release 6.

- The system will automatically license 12 Avaya IP phones for each IP500 VCM 32 or VCM 64 card installed in the system without requiring additional licenses to be added to the configuration.
- Additional Avaya IP phones are licensed either by the addition of Avaya IP Endpoints licenses above or the conversion of legacy IP500 VCM Channels licenses to Channel Migration licenses (see below).
- By default licenses are consumed by each Avaya IP phone that registers with the IP Office in the order that they register. The license is released if the phone unregisters. However, it is possible to reserve a license for particular phones in order to ensure that they phones always obtain a license. This is done through the Reserve Avaya IP Endpoint Licence setting of each IP extension.
- Avaya IP phones without a license will still be able to register but will be limited to making emergency calls only (Dial Emergency short code calls). The associated user will be treated as if logged off and the phone will display *"No license available"*. If a license becomes available, it will be assigned to any unlicensed DECT handsets first and then to any other unlicensed Avaya IP phone in the order that the phones registered.
- For existing IP500 systems being upgraded to IP Office Release 6, the existing VCM channels and IP500 VCM Channels license are treated as follows:
  - For each IP400 VCM card installed in the system, each VCM channel supported by the card allows support for 3 Avaya IP phones.
  - For each IP500 VCM32 and IP500 VCM64 card installed in the system, the 4 unlicensed VCM channels previously provided by each card are converted to allow unlicensed support of 12 Avaya IP phones.
  - For each legacy IP500 VCM Channels license, the license are converted Channel Migration licenses supporting 3 Avaya IP phones. See the Channel Migration license below.
  - The IP500 VCM 32 and IP500 VCM 64 cards will provide their full capacity of VCM channels, ie. providing up to 32 or 64 channels depending on the card type and the codecs being used.

## 2.2 Creating/Editing the Settings File

During installation, the H323 IP phones request software by downloading and following instructions within the 46xxupgrade.scr file. This file is provided as part of the IP Office Manager software and should not normally be changed.

The last lines of the 46xxupgrade.scr file instruct the phone to request the file 46xxsettings.scr or 46xxsettings.txt. If present, that file is downloaded and used to set customer site specific options for the H323 IP phones. It is this 46xxsettings file that is used to contain site specific options for phones and should be edited to meet the customer requirements before installation of the phones.

### File Auto-Generation

For IP Office 5.0+, when using the IP Office's memory card for file serving, a number of files including the [46xxsettings.txt file can be auto-generated](#)<sup>[24]</sup>.

### Manually Editing the File

1. Using Windows Notepad or any other plain text editing tool, open the *46xxsettings.txt* file.
2. Edit the file as required. The file contains numerous comments and notes. Further details of the various settings are contained in the 4600 Series IP Telephone LAN Administrator Guide. For some specific options see the notes below.
  - A # character at the start of a line comments out the command on that line. Note however that for some options the phones will assume a default value if the option in the 46xxsettings.txt file is commented out. For example if SET PHNOL is commented out, the phones will assume the addition of a dial 9 prefix to numbers.
3. Place this file in the same folder as the 4600 Series IP Phone software files including the 46xxupgrade.scr file. Normally this is the same folder as the Manager application.
4. Ensure that you have a copy of the edited file.

### Dialing Prefix

For IP Office systems the addition or removal of dialing prefixes is normally done by the IP Office system rather than individual phones or applications. For IP Office operation the following changes are recommended in the **ENHANCED LOCAL DIALING RULES** section of the 46xxsettings.txt file.

- Change **## SET ENHDIALSTAT 0** to **ENDIALSTAT 0**.
- Change **## SET PHNOL 9** to **SET PHNOL ""**.

### 802.1Q Tagging

Unless specifically required for the customer network, for IP Office operation it is recommended that **## SET L2Q 0** is changed to **SET L2Q 2**.

### WML Web Server Setup

If a WML web site has been setup for viewing by phone users, see [WML Server Setup](#)<sup>[76]</sup>, the site address is set through the 46xxsettings file. Change **## WMLHOME http://.....** to **WMLHOME** followed by the required address.

---

## 1600/9600 Series Phone Languages

In addition to English, the 1600 and 9600 phones can support up to 4 language other languages. This is done by the phones downloading languages files specified in the 46xxsettings.txt file. Currently 9 non-English language files are provided as part of the IP Office Manager installation.

Language	1600 File	9600 File
Dutch	mlf_dutch.txt	mlf_9600_dutch.txt
French Canadian	mlf_french_can.txt	mlf_9600_french_can.txt
French	mlf_french_paris.txt	mlf_9600_french_paris.txt
German	mlf_german.txt	mlf_9600_german.txt
Italian	mlf_italian.txt	mlf_9600_italian.txt
Latin Spanish	mlf_spanish_latin.txt	mlf_9600_spanish_latin.txt
Portuguese	mlf_portuguese.txt	mlf_9600_portuguese.txt
Russian	mlf_russian.txt	mlf_9600_russian.txt
Spanish	mlf_spanish.txt	mlf_9600_spanish.txt

The files to download to the phones are defined in the # **SETTINGS1603**, # **SETTINGS1608** and # **SETTINGS1616** sections of the 46xxsettings.txt file. To have the phone download a language file, remove the ## in front of one of the **SET** options and change the file name to match the required language.

## Backup/Restore



Phones can use an HTTP server as a location to which the user's phone settings are backed up and restore when they log on or off the phone. See [Backup Restore](#) <sup>38</sup> for full details.



## 2.3 Manually Creating Extensions

If installing without auto-create extensions enabled, then VoIP extensions and associated users must first be created in IP Office Manager.

The procedure below covers the minimum required to create a VoIP extension and associated user. Further customization is as per any extension and user.

1. In Manager, receive the system's configuration.
2. To display the list of existing extensions, click  Extension in the left-hand panel. Right-click on the right-hand panel and select New.
3. In the Extn tab, set the following:
  - Extension ID  
For non-VoIP extension this number is assigned automatically. For a VoIP extension, enter any number so long as it is unique, i.e. not already used by another extension.
  - Base Extension  
Enter the extension number to assign to the phone. Again, this must be unique.
4. In the VoIP tab, the required IP Address and/or MAC Address can be set if required for additional phone security. See [Phone Security](#) <sup>[37]</sup>.
5. To add the new extension, click OK.
6. To display the list of existing users, click  User in the left-hand panel. Right-click on the right-hand panel and select New.
7. In the User tab set the following:
  - Name  
Enter a name for the extension user. The name must be unique. If voicemail is in use, this name will be used as the basis for a new mailbox with matching name.
  - Extension  
This must match the extension number set in the VoIP extension created above.
8. Click on the Button Programming tab.
9. For the first three buttons, you must click on the Action field and select Appearance | Appearance.
10. Click on OK.
11. When all new IP phone extension being added have been setup, send the new configuration back to the system. Set the Reboot Mode to Immediate or When Free as Extension changes cannot be merged.

---



## 2.4 Phone Connection

In this process the phone is connected to its power source and the ethernet LAN. As soon as the phone is powered up it will start to request information.

1. Follow the steps in [Preparation](#)<sup>[28]</sup>. If these steps are not followed, installation will fail. Ensure that the selected file server is running and that the required files are present. Check that the DHCP server is running.
2. Connect the network LAN cable to the data-in socket of the power supply being used for the phone.
  - On 1151 power supply units, the socket is marked LINE.
  - On the 1152 power supply units, the lower sockets are data-in.
3. Connect the LAN cable supplied with the IP phone from the power supplies data and power out socket to the socket with a LAN port symbol (☐) at the back of the IP phone.
  - On 1151 power supply units, the socket is marked PHONE.
  - On the 1152 power supply units, the upper sockets are data and power.
4. The phone's message indicator should glow red for a few seconds. The phone will then begin its software loading.
5. After a short delay, the phone displays Initializing and then Loading.... The loading phase may take a few minutes.
6. If the phone has an existing software boot file (ie. it has been previously installed), it will load that file and then display Starting....
7. If the phone displays No Ethernet, check the connection to the LAN.
8. The phone displays DHCP and a timer as it attempts to request an IP address and other information from a DHCP server. On 4601 and 5601 phones, initially all lamps will be on as the phone initializes. All lamps on (with the button a lamp flashing) indicates attempting DHCP.
  - To switch to static address installation  
Press \* whilst DHCP is shown if you want to enter static address installation. See [Static Address Installation](#)<sup>[35]</sup>. This is not recommended for 4601 and 5601 IP phones.
9. After a few seconds, DHCP negotiation should be completed. If the timer reaches more than 60 seconds, it could indicate an error in either the network or DHCP server configuration.
10. Once DHCP has completed successfully, the phone will display *HTTP* or *TFTP* as it request files from the file server indicated by the DHCP settings. The first file requested is the *46xxupgrade.scr* file. This file contains details of the other files that the phone should load.
  - The phones will go through a sequence of loading files, restarting and loading further files until the files on the phone match those listed for it in the *46xxupgrade.scr* file. For phones with some files already installed, the sequence may vary depending on whether the existing files match those specified in the *46xxupgrade.scr* file.
  - On 4601 and 5601 phones, all lamps will be on with both the button a and button b lamps flashing whilst file loading is attempted and occurring.
11. The phone now requests additional files according to the instructions it found in the *46xxupgrade.scr* file. The phone will go through a cycle of requesting files, loading files and then transferring the files into its flash memory.
12. Following file loading, the phone displays Ext. =. See [Phone Registration](#)<sup>[36]</sup>.

## 2.5 Static Address Installation

Static addressing is only necessary when a DHCP server is unavailable or not desired. For ease of maintenance and installation, it is strongly recommended that a DHCP server is installed and that static addressing is avoided. Following a boot file upgrade, static address information must be reinstalled. This process is not supported on 4601 and 5601 phones.

1. Follow the steps in [Phone Connection](#) <sup>[34]</sup> until DHCP is shown on the phone display. Press \* at this point to switch the phone to static address installation.
  - Existing installed phones can be made to start static address installation using the following key sequence. While the phone is on-hook and idle, press MUTE 2 3 3 7 # (MUTE A D D R #).
2. The phone will display a sequence of settings and the existing value for each of those settings. To accept the current value, press # or enter a value and then press #.
3. While entering data in the following actions it may sometimes be necessary to backspace. The method for doing this varies according to the phone type:
  - 4602, 5602:  Speaker key.
  - 4606:  Conference key.
  - 4612 & 4624:  Previous key.
  - 4610, 4620, 4625, 5610, 5620: Left-most key.
4. The settings shown for static address installation are:
  - Phone=  
This is the phone's IP address. To accept the current value, press # or enter a value and then press #. If entering a new value, press the \* key to enter a '.' character between digits.
  - CallSv=  
This is the address of the H323 gatekeeper. For IP Office systems this is the IP address of the IP Office LAN1.
  - CallSvPort=  
This is the Gatekeeper transport layer port number. For Avaya IP phones the value used should be 1779. To accept the current value, press # or enter a value and then press #.
  - Router=  
This is the address of the phone's default IP gateway. For IP Office this is typically the IP address of the IP Office LAN1. To accept the current value, press # or enter a value and then press #.
  - Mask=  
This is the phone's IP Mask (also called the subnet mask). The mask is used with the IP address to indicate the phone's subnet. This should match the IP mask set for the IP Office Unit.
  - FileSv=  
This is the address of the file server from which the phone should request software and settings files. Enter the address of the TFTP or HTTP configured with the Avaya IP phone software file set.
  - 802.1Q=  
To change the setting press \*. Press # to accept the value.
  - VLAN ID=  
For details of VLAN configuration see [VLAN and IP Phones](#) <sup>[47]</sup>.
5. If you go through without changing anything the phone displays No new values. Press #.
  - If the phone displays Enter command power off and on again.
6. Once all the values have been entered or the existing values accepted the phone will display Save new values?. To save the values press #. The phone will save the values and then restart using those values.
  - If a new boot program is downloaded from the TFTP server after you enter static address information, you will need to re-enter your static address information.

---

## 2.6 Phone Registration

For new phones and phones that have been [reset](#)<sup>58</sup>, the phone will request an extension number. If auto-create is enabled the extension number used, if free, will create new extension and user entries in the IP Office configuration. If auto-create is not enabled, the extension number used must match a VoIP extension entry within the IP Office configuration, see [Manually Creating Extensions](#)<sup>33</sup>.

1. Following file loading the phone will request extension information:



- Ext. =  
Enter the extension number the phone should use and press #. Wrong Set Type is displayed if you try to use the extension number of an existing non-IP extension.
  - On 4601 and 5601 phones, this stage is indicated by the lamp at the top of the phone and on the MESSAGES button flashing 0.5 seconds on/off.
- Password =  
The password used is as follows:
  - If using auto-create for a new user and extension, just enter any number and press #. Any digits entered for a password here are not validated or stored.
  - If not using auto-create extension for a new extension, enter the user's Login Code as set in the IP Office configuration.
  - During subsequent phone restarts, even though the password is requested, it will only be validated if the phone's extension number is changed.

2. Test that you can make and receive calls at the extension.

## 2.7 Extension & User Setup

If installing using auto-create extensions, you can now use IP Office Manager to open the IP Office unit's configuration and alter the extension and user settings for the phone.

The following process covers the minimum extension and user setup required.

1. In Manager, receive the system's configuration.
2. To display the list of existing extensions, click  Extension.
3. The  icon indicates VoIP extensions. A new extension will have been created matching the extension number entered above. In the extension's VoIP tab, the Compression Mode default is *Automatic Selection*.
4. To display the list of existing users, click  User. In the list of users, a new user will have been created matching the VoIP extension number above.
5. Double-click on the IP phone extension user to display their settings.
6. In the User tab, set the user Name and Full Name as required.
7. Click the Digital Telephony tab.
8. For the first three buttons, you must click on the Action field and select Appearance | Appearance.
9. Click OK.
10. When all new IP phone extension have been setup, send the new configuration back to the system. Set the Reboot Mode to Immediate or When Free as extension changes cannot be merged.

## 2.8 Phone Security

There are a number of methods by which additional security can be implemented to ensure that an IP phone does not adopt the identity of another.

- **Disable Auto-Create Extension**  
Following installation, disabling Auto-Create Extn Enabled in the IP Office Manager System | Gatekeeper tab stops new IP devices from assigning themselves as new extensions.
- **Restrict the IP Address**  
Entering a value for this field in the extension's VoIP tab will restrict usage to devices configured with that address.
- **Set a User Login Code**  
If a user Login Code is set, then any other IP device trying to log on as that extension must also enter the correct login code. If a login code is set, the user can use hot desk to log off and log on elsewhere.

---

## 2.9 Backup Restore

1600 Series H323 IP Telephones support using a HTTP server as the location to which they can backup and restore user specific data. These options are used if the location of the HTTP server for backup/restore has been specified in the phone 46xxsettings file.

- The address of the HTTP server for backup/restore operation is separate from the address of the HTTP server used for phone firmware files downloads.
- The HTTP server being used for backup/restore will require configuration changes to allow the phones to send files to it.
- For IP Office 5.0, the IP Office memory card can be used as the location for backup/restore of user settings. That includes [file auto generation](#)<sup>[24]</sup>. When using auto-generation, some settings within the restore file are based on the user's IP Office settings.

Backup is used when the phone user logs out of the phone. During the log out process, the phone creates a file containing the user specific data and sends that to the BRURI location. The file is named with the user's extension number and *\_16xxdata.txt*, for example *299\_16xxdata.txt*.

Restore is used when a user logs in at the phone. The phone sends a file request for the appropriate file based on the users extension number. If the file is successfully retrieved the phone will import the settings and, after a "Retrieval OK" message, continue as normal. If the file cannot be retrieved, a "Retrieval failed" message is displayed and the phone will continue with its existing settings.

### Specifying the BRURI Value

1. Open the 46xxsettings.txt file.
2. Locate the line containing the SET BRURI value.
3. If the line is prefixed with # characters, remove those and any space.
4. After SET BRURI, enter a space and then the address of the HTTP backup server, for example *SET BRURI http://192.168.0.28*. If necessary you can specify the path to a specific server directory and or include a specific port number, for example *SET BRURI http://192.168.0.28/backups:8080*.

### HTTP Authentication

HTTP authentication can be supported. If set it will be used for both the backup and the restore operations. The authentication credentials and realm are stored in the phone's reprogrammable non-volatile memory, which is not overwritten when new telephone software is downloaded.

Both the authentication credentials and realm have a default values of null. If the HTTP server requires authentication, the user is prompted to enter new credentials using the phone. If the authentication is successful, the values used are stored and used for subsequent backup and restore operations.

### Manual Backup/Restore Control

Users can request a backup or restore using the Advanced Options Backup/Restore screen as detailed in the user guide for their specific telephone model.

## 1600 Series Phone Backup File

The following is an example of a backup/restore file for a 1600 Series phone user.

```

ABKNAME001=Extn201
ABKNUMBER001=201
ABKNAME002=Extn201ad
ABKNUMBER002=201
ABKNAME003=Extn203
ABKNUMBER003=203
Redial=0
Call Timer=0
Visual Alerting=1
Call Log Active=1
Log Bridged Calls=1
Log Line Calls=1
Log Calls Answered by Others=0
Audio Path=2
Personalized Ring=7
Handset AGC=1
Headset AGC=1
Speaker AGC=1
Error Tone=1
Button Clicks=0
Display Language=English

```

The table below lists entries that may be found in the backup file. Note that values are not written unless the setting has been changed by the user. For IP Office 5.0+, those items indicated as IP Office are controlled by values stored and supplied by the user's IP Office settings.

Field	Description	IP Office User
ABKNAMEmmm ABKNUMBERmmm	These paired entries are used for personal contacts entered into the phone. The <i>mmm</i> value in each pair in replace by a 3 digit number starting with 001. The first line of the pair stores the contact name, the second line stores the phone number for the contact.	✓
LANGUSER	Display language. The language name is stored.	✓
LOGACTIVE	Call log active on (1) or off (0).	✓
LOGBRIDGED	Log bridged calls on (1) or off (0).	✓
LOGLINEAPPS	Log line calls on (1) or off (0).	✓
LOGOTHERANS	Log calls answered by others on (1) or off (0).	✓
OPTAGCHAND	Handset Automatic Gain Control on (1) or off (0).	–
OPTAGCHEAD	Headset Automatic Gain Control on (1) or off (0).	–
OPTAGCSPKR	Speaker Automatic Gain Control on (1) or off (0).	–
OPTAUDIOPATH	Audio Path	–
OPTCLICKS	Button Clicks on (1) or off (0).	✓
OPTERRORTONE	Error Tone on (1) or off (0).	✓
PERSONALRING	Personalized Ring. A numeric value (1 to 8) for the selected ring is stored.	✓
PHNREDIAL	Redial	✓
PHNSCRONCALL	Go to call screen on calling on (1) or off (0).	–
PHNSCRONALERT	Go to call screen on ringing on (1) or off (0).	–
PHNTIMERS	Call Timer on (1) or off (0).	✓
PHNVISUALALERT	Visual alerting on (1) or off (0).	✓

---

## HTTP Server Configuration for Backup/Restore

### For IIS Web Servers

Create a backup folder under the root directory of your web server. All backup files will be stored in that directory.

For example, if your backup folder is *C:/inetpub/wwwroot/backup*, the 46xxsettings.txt file should have a line similar to *SET BRURI http://www.website.com/backup/*.

1. Go to Start | Settings | Control Panel | Administrative Tools and select, depending on the Windows version, Internet Information Services Manager or Internet Information Services.
2. Right click on the folder created for backup or right click on Default Web Site if there is no specific backup directory.
3. Select Properties.
4. In the Directory tab, make sure the Write box is checked.
5. Additional step for IIS 6.0:
  1. Go to Start | Settings | Control Panel | Administrative Tools.
  2. Below Default Web Site, select Web Services Extension.
  3. Make sure the WebDAV option is set to *Allowed*.

### For Apache Web Servers

Create a backup folder under the root directory of your Web server. Make the folder writable by everyone. All backup files will be stored in that directory.

For example, if the backup folder is *C:/Program Files/Apache Group/Apache2/htdocs/backup*, the 46xxsettings.txt file should have a line similar to *SET BRURI http://www.website.com/backup/*.

1. Edit your Web server configuration file httpd.conf.
2. Uncomment the two LoadModule lines associated with DAV:

```
LoadModule dav_module modules/mod_dav.so
LoadModule dav_fs_module modules/mod_dav_fs.so
```

- Note: If these modules are not available on your system, typically the case on some Unix/Linux Apache servers, you have to recompile these two modules (mod\_dav & mod\_dav\_fs) into the server. Other ways to load these modules might be available. Check your Apache documentation at <http://httpd.apache.org/docs/> for more details.

3. Add the following lines in the httpd.conf file:

```
#
# WebDAV configuration
#
DavLockDB "C:/Program Files/Apache Group/Apache2/var/DAVLock"
<Location />
Dav On
</Location>
```

4. For Unix/Linux Web servers the fourth line might look more like: `DavLockDB/usr/local/apache2/var/DAVLock`
5. Create the var directory and make it writable by everyone. Right click Properties | Security | Add | Everyone | Full Control.



## 2.10 Listing Registered Phones

Using TFTP, a list can be obtained from the IP Office system of all the registered RAS users which includes H323 IP phones. For example:

```
Extn2602,2602,192.168.42.2,1720  
ains600,2600,192.168.42.10,1026  
Extn2601,2601,192.168.42.4,1720  
New,2702,192.168.42.200,1720
```

1. In Windows, select Start | Run and enter cmd for the Windows command line interpreter.
2. If necessary, use cd commands to select the directory into which you want the list placed as the current directory.
3. Enter tftp -i xxx.xxx.xxx.xxx get nasystem/h323\_ras\_list yyyyyyy.txt where:
  - xxx.xxx.xxx.xxx is the IP address of the IP Office unit.
  - yyyyyyy.txt is the name of a text file that does not already exist in that directory.
4. The TFTP command will confirm when the file has been successfully transferred.
5. To close the command line interpreter window, type exit.
6. Open the text file using Wordpad or a similar tool.

The IP Office Monitor application (Sysmon) can also show how many phones have registered and how many are currently waiting to register. The System | Print trace filter option must be selected to see these messages. This appears as lines of the form:

```
792ms PRN: GRQ from c0a82c15 --- RAS reaches the maximum capacity of 10; Endpoints registered 41
```

---

## 2.11 Error Messages

The 4600 Series H323 IP phones issue error messages in English only.

- **Checksum error**  
Downloaded application file was not downloaded or saved correctly. The phone automatically resets and attempts to re-initialize.
- **DHCP: CONFLICT**  
At least one of the IP addresses offered by the DHCP server conflicts with another address. Review DHCP server administration to identify duplicate IP addresses.
- **Failed to set phone IP address**  
The IP phone was originally installed on one switch with Static Addressing and has subsequently been installed on another switch with an active DHCP server assigning dynamic IP addresses. Reset the phone.
- **File too large cannot save file**  
The phone does not have sufficient room to store the downloaded file. Verify the proper filename is administered in the TFTP script file and that the proper application file is located in the appropriate location on the TFTP server.
- **Hardware failure**  
Hardware failure prevented downloading of application file. Replace the phone.
- **IP Address in use by another**  
The phone has detected an IP address conflict. Verify administration to identify duplicate IP addresses.
- **No Ethernet**  
When first plugged in, the IP phone is unable to communicate with the Ethernet. Verify the connection to the Ethernet jack, verify the jack is Category 5, verify power is applied on the LAN to that jack, etc.
- **No file server address**  
The TFTP server IP address in the IP phone's memory is all zeroes. Depending on the specific requirements of your network, this may not be an error. If appropriate, either administer the DHCP server with the proper address of the TFTP server, or administer the phone locally using the ADDR option.
- **Resetting on URQ**  
Restarting following a reboot of the IP Office Unit.
- **System busy**  
The resource being called upon should be checked for its availability. If it appears operational and properly linked to the network, verify addressing is accurate and a communication path exists in both directions between the phone and the resource.
- **Timeout Error**  
Protocol timeout error. Retry. If failure continues, check network congestion, addresses, etc. to identify cause of timeout.
- **TFTP Error**  
Request for file from TFTP server timed out. Check that IP Office Manager or the indicated TFTP source within the IP Office configuration are running and that the 4600 Series phone software files are available.
- **Wrong Set Type**  
Another device is already assigned to the extension number of the IP phone.

# **Chapter 3.**

## **Other Installation Options**

## 3. Other Installation Options

### 3.1 VPN Remote Phones

Avaya IP Office VPNremote firmware can be used to connect IP phones at remote locations to the IP Office via IPSec VPN tunnels. IP Office 4.1 and higher supports this with some 4600 Series and 5600 Series IP phones. IP Office Release 6 also supports VPNremote on 9600 Series phones supported by IP Office.

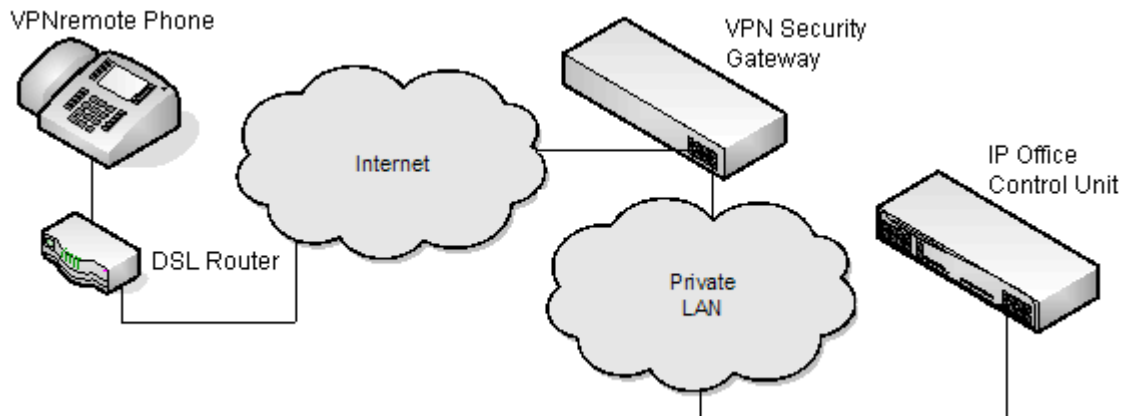

Key components are:

1. IP Office VPNremote Phone Firmware

This firmware is provided on the IP Office Administrator Applications DVD for IP Office 4.1 and higher. IP Office VPNremote firmware is provided for the 4610SW, 4621SW, 5610SW and 5621SW phones and 9600 Series phones only. Other VPNremote phones are not supported.

2. TFTP Server

During installation a HTTP server is required to load the firmware onto the phones. The same TFTP server as being used for internal IP phone extensions can be used.

3. IP Office VPNremote Phone Licenses

The operation of VPNremote phones with IP Office is licensed using VPN IP Extension licenses entered into the IP Office's configuration. The licenses control the number of VPNremote phones supported by the IP Office.

- For IP Office Release 6 this does not apply to IP500 and IP500 V2 control units which license all Avaya IP phones including VPN ones using Avaya IP Endpoint licenses.

4. VPN Security Gateway

VPNremote phones uses VPN protocols not directly supported by the IPSec VPN tunnels that can be provided by IP Office control units. Therefore the VPN tunnel from the VPNremote phones must end at a compatible VPN gateway device. The device being used must support one of the following methods:

- Avaya Gateways

Avaya security gateway devices (SG and VSU) use an Avaya proprietary protocol called CCD.

Avaya SG Series (4.6 firmware or higher).

Avaya VSU Series (3.2 firmware or higher).

- Non-Avaya Gateways

Non-Avaya VPN gateways with IKE Extended Authentication (Xauth) with Preshared Key (PSK). Installation notes exists for the following listed below. This does not imply any recommendation of those devices by Avaya or preclude other devices. Note that Avaya cannot guarantee support for services through non-Avaya devices.

Cisco VPN 300 Series Concentrators.

Netgear FVS338 VPN Router.

Cisco PIX 500 Series Security Appliances.

Kentrox Q2300 VPN Router.

Juniper Networks NetScreen Series VPN Devices.

Adtran Netvanta 3305 VPN Router.

Juniper Networks Secure Services Gateway 500 Series.

Sonicwall Tz170 VPN Router.

Juniper Networks Integrated Security Gateway (ISG) Series.

Netgear FVX538 VPN Router.

## Installation Documentation

This document only covers notes and differences specific to installation of VPNremote phones with IP Office. The installation and configuration of Avaya VPNremote phones is covered in a number of existing documents available from the Avaya support website (<http://support.avaya.com>).

Product Section	Title	Doc Reference
VPNremote Phone	VPNremote for the 4600 Series IP Telephones Administrators Guide	19-600753
	Application Notes for Configuring Avaya VPNremote Phone with Juniper Secure Services Gateway using Policy-Based IPsec VPN and XAuth Enhanced Authentication	317687
	Configuring Cisco PIX Security Appliance using Cisco Adaptive Security Device Manager (ASDM) VPN Wizard to Support Avaya VPNremote Phones	317678
	Configuring Cisco PIX Security Appliance with Microsoft Internet Authentication Service and Active Directory using RADIUS to Support Avaya VPNremote Phones	317675
	Configuring Cisco VPN Concentrator to Support Avaya VPNremote Phones	317672
	VPNremote for 4600 Series IP Telephone User Installation and Configuration Quick Start - Pre-Deployment	19-601708
	VPNremote for 4600 Series IP Telephone User Installation and Configuration Quick Start - Self Installer	19-602363
IP Office	Technical Tip 184 - Configuring a VPN Remote IP Phone with a Netgear FVS338 VPN Router.	322690
	Technical Tip 185 - Configuring a VPN Remote IP Phone with a Kentrox Q2300 VPN Router.	322702
	Technical Tip 186 - Configuring a VPN Remote IP Phone with an Adtran Netvanta 3305 VPN Router.	322714
	Technical Tip 190 - Configuring a VPN Remote IP Phone with a Sonicwall Tz170 VPN Router	325830
	Technical Tip 196 - Configuring a VPN Remote IP Phone with a Netgear FVX538 VPN Router.	327056

## Supported VPNremote Phone Firmware

Unless otherwise advised, only the firmware provided on the IP Office Administrator Applications DVD should be used for VPNremote phones connected to an IP Office. That firmware is tested with the IP Office release represented by the DVD for correct operation. The firmware is located in a zip file in the folder \bin\VPN Phone.

Whilst other VPNremote firmware releases may be made available by Avaya for download, those firmware release may not have been specifically tested with IP Office.

---

## Configuring the IP Phone for VPNremote

In addition, a VPN Phone Allowed checkbox option is present on the Extension | VoIP settings tab of IP extensions. This checkbox is used to indicate to the IP Office, which IP extensions are VPNremote and therefore require use of a license.

1. Using IP Office Manager, receive the current configuration from the IP Office system.
2. Click on  Extension and select the entry for the IP extension.
3. Select the VoIP tab.
4. Enable VPN Phone Allowed.
5. Click OK.
6. Repeat this for any other existing IP extensions that are going to be converted to VPN connection.
7. Save the configuration back to the IP Office system.

## Configuring 4600 Series VPN Remote Phones for IP Office Licensing

By default, 5600 Series phones running VPNremote firmware use licenses available from the IP Office to which they connect. However 4600 Series phones running VPNremote can be licensed in a number of ways and so need to be instructed to use the IP Office for licensing.

In order to inform that 4600 Series VPNremote phones to use IP Office licensing, the following line must be added to the 46vpnsettings.txt file:

- SET SMBLIC 1

## 3.2 VLAN and IP Phones

This section describes the configuration of an VLAN networking infrastructure for use with Avaya IP Office and 4600 Series IP Phones. In this example an HP Procurve Ethernet 2626 PWR Ethernet switch is used to manage the VLAN's. A basic understanding of the IEEE 802.2p/q standard is required.

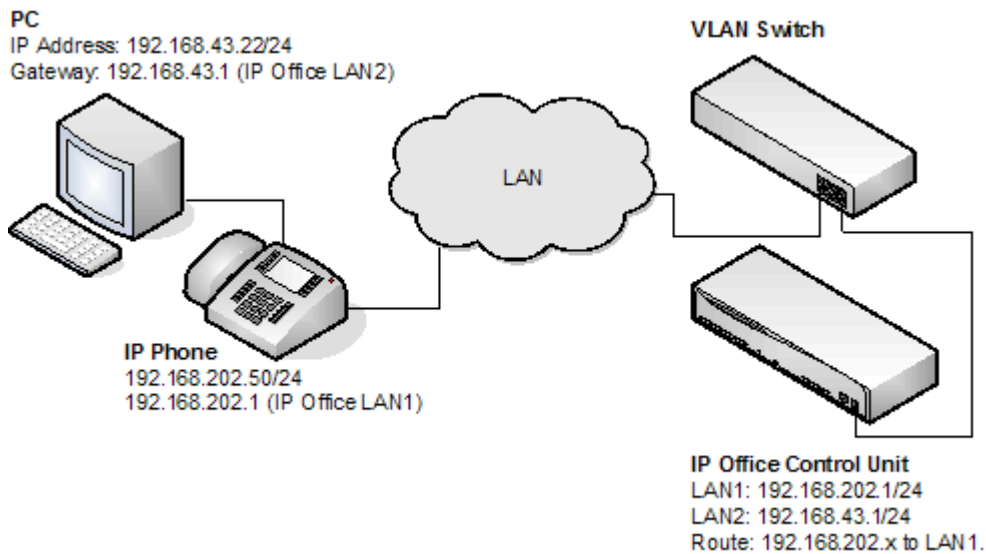

The use of VLAN allows separate collision domains to be created on Ethernet switches. In the case of IP Office and IP Phones the advantages are:

1. It allows PC's to continue in the same IP subnet while IP Phones can use a new and separate IP addressing scheme.
2. Broadcast traffic is not propagated between the PC data network and the IP Phones voice network. This helps performance as otherwise broadcast traffic must be evaluated by all receivers.
3. VLAN networking and traffic prioritisation at layer 2 are closely bound together in the same 802.2 standard. It is therefore easier to maintain L2 QOS when using a VLAN.

The table below shows the three ways in which VLAN can be deployed with an Ethernet Switch. The first two methods require only elementary configuration and as this document assumes both PC and IP Phones share the same Ethernet port, the focus will be the third method (overlapping).

Type	Description	Advantages	Disadvantages
No VLAN	Both Voice and Data occupy the same collision domain	Simple configuration	PC broadcast traffic adverse effect on Voice traffic. Requires two ports per user (one for IP Phone and one for PC).
Physical VLAN	Separate VLAN for data and voice	Simple configuration	Requires two ports on switch (one for IP phone and one for PC).
Overlapping VLAN	A single port on the switch carrying both the IP Phones as well as the PC traffic.	Requires only a single port for both PC and IP Phone. PC broadcast traffic cannot adversely effect Voice traffic.	Complex configuration.

## VLAN and DHCP

The use of VLAN has implications on DHCP if DHCP is being used for support of IP phones and or PC's. The table below details the available options when using a single port for PC and IP Phones on a VLAN enabled network.

DHCP Option	Description
None (Static addressing)	Manual configuration of each IP Phone.
Separate DHCP Servers	Two PCs, one for each VLAN.
Multihomed DHCP Server	A single PC with two NIC Cards; one for each VLAN.
DHCP Relay	The option must be supported by the Ethernet switch.

If using DHCP, when the IP Phone starts it will first perform a DHCP discovery without a VLAN tag. If the DHCP reply contains a new VLAN setting (scope option 176), the Phones will release all existing IP parameters and then perform a new DHCP discovery using the supplied VLAN ID. If the IP Phone does not get a new VLAN ID, the phone will continue with the settings provided in the original DHCP reply.

The VLAN ID can also be passed to the phones through the 46xxsettings file. Again if this method is used the IP phone will release all its existing IP parameters and perform a new DHCP discovery on the supplied VLAN ID.

A potential error loop condition can occur if the DHCP server and 46setting files have conflicting VLAN values. This is because the IP Phones release all their IP parameters and restart if their VLAN ID is changed. Another way this error loop can occur is if two DHCP servers are used; The Avaya 4600 IP Phone would repost this condition if it occurs.

As stated, when an IP phone is given a new VLAN ID, via TFTP or DHCP, it will immediately releases its current IP parameters and issue a new DHCP request using the new VLAN ID. In this way, when the IP Phones are first a DHCP reply from the DHCP server on the data VLAN, it contains the VLAN ID of the voice VLAN. The phone will release the data VLAN settings and send a new DHCP request tagged for the voice VLAN.

### Data VLAN DHCP Settings

Option	Data VLAN DHCP Settings	Voice VLAN DHCP Settings
IP Address	192.168.43.x	192.168.202.x
Mask	255.255.255.0	255.255.255.0
3: Router	192.168.43.1	192.168.202.1
176	L2Q=1, L2QVLAN=202, VLANTEST=0	MCIPADD=192.168.202.1, MCPORT=1719, TFTP SRVR=192.168.202.X VLANTEST=0

The VLANTEST parameter is the length of time the IP Phone is to continue DHCP requests in a VLAN (0 means unlimited time).



Example setup - Overview

The network is devised to allow the user PC to connect to the switch port of the IP Phone. A single cable then connects PC and IP Phone to the Ethernet Switch. For the purpose of this example VLAN 209 is used for voice traffic and VLAN 210 for data traffic. The LAN1 interface of the IP Office control unit resides on the voice VLAN while the LAN2 interface resides in the data VLAN. Communications between the voice and data VLAN's is facilitated by the IP Office control unit's router function.

HP-Switch - Configuration

Shown below are the web and CLI configuration output from the HP Procurve Switch.. These were obtained using the configuration guidelines which can be found below.

The screenshot shows the HP Procurve Web Configuration interface. At the top, it displays 'AvayaLabs - Status: Non-Critical' and 'HP J8164A ProCurve Switch 2626-PWR'. The 'Configuration' tab is selected. Underneath, the 'VLAN Configuration' sub-tab is active, showing a table of configured VLANs. The table has columns for VLAN ID, VLAN Name, VLAN Type, Tagged Ports, Untagged Ports, Forbid Ports, and Auto. Three VLANs are listed: VLAN 1 (Native [Prim]), VLAN 209 (Red [Voice]), and VLAN 210 (Blue [Data]). Each row has a 'Modify' button. At the bottom of the table, there is a control bar with 'ADD/REMOVE VLANs', a checked checkbox for 'GVRP Enabled', and a 'GVRP Mode' button.

VLAN ID	VLAN Name	VLAN Type	Tagged Por	Untagged Ports	Forbid Ports	Auto	
1	Native (Prim:	STATIC	(STATIC) None (GVRP) None	1-2,4, 7-26	None	3,5-6	Modify
209	Red [Voice]	STATIC	(STATIC) 3 (GVRP) None	5	None	1-2,4, 6-26	Modify
210	Blue [Data]	STATIC	(STATIC) None (GVRP) None	3,6	None	1-2,4-5, 7-26	Modify

ADD/REMOVE VLANs       GVRP Enabled      GVRP Mode

Figure 1 HP Procurve Web Configuration

### HP Procurve CLI output

```
; J8164A Configuration Editor; Created on release #H.08.60

hostname "AvayaLabs"
snmp-server community "public" Unrestricted
vlan 1
name "Native"
untagged 1-2,4,7-26
ip address 192.168.202.201 255.255.255.0
no untagged 3,5-6
exit
vlan 209
name "Red [Voice]"
untagged 5
tagged 3
exit
vlan 210
name "Blue [Data]"
untagged 3,6
exit
gvrp
spanning-tree
```

The table below summarizes the HP configuration for ports and VLAN's.

Port	VLAN 209 Voice	VLAN 210 Data	Description
3	Tagged	Untagged	This port was added to both VLAN 209 and VLAN 210. However there is an important difference between adding to these VLAN's. When adding port 3 to VLAN 209 the Mode option must be tagged but untagged when adding to VLAN 210.
5	Untagged	–	This port is included only in VLAN 209 and not included in VLAN 210. The Mode option must be set to Untagged for port 5 in this VLAN.
6	–	Untagged	Port 6 is included only in VLAN 210 and not included in VLAN 209. The Mode option MUST be set to Untagged in this VLAN.

The operation of this network is dependant on the functionality defined in HP documentation. Specifically HP refers to this type of VLAN operation as Overlapping VLAN. The configuration relies also on that fact that Avaya 4600 IP Phones support VLAN operation .

Example System Overview

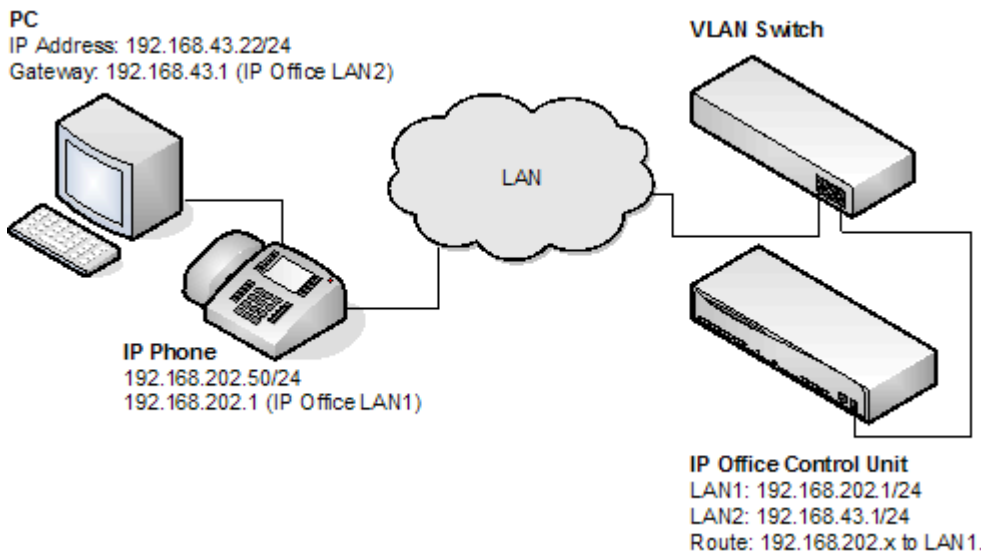

IP Office Configuration

The table below details the configuration for IP Office. Additional configuration is not required by IP Office in support 802.1 Tagging.

Option	Value
IP Address LAN1	192.168.202.1
IP Mask LAN1	255.255.255.0
IP Address LAN2	192.168.43.1
IP Mask LAN2	255.255.255.0
Router	192.168.202.1
Call Server	192.168.202.1

IP Phone- Configuration

For this example the IP phone was configured with fixed IP addressing as shown below:

Option	Value
IP Address	192.168.202.50
IP Mask	255.255.255.0
Router	192.168.202.1
Call Server	192.168.202.1
VLANID	209

VLAN Switch Configuration

The table below summarizes the HP configuration for ports and VLAN's.

Port	VLAN 209 Voice	VLAN 210 Data
3	Tagged	Untagged
5	Untagged	-
6	-	Untagged

The PC –Configuration

Shown below is the IP configuration of the PC1; no option in support of 802.1p or 802.1q is enabled on the PC.

Option	Value
IP Address	192.168.43.22
IP Mask	255.255.255.0
Router	192.168.43.1

Summary

On the port on which the PC and IP phone resides two types of Ethernet frames can be received (i.e. sent from Phone or PC).

1. Tagged Packets are sent by IP Phone
2. Untagged packets are sent by PC

When an untagged packet is sent by the PC attached to the IP Phone port it will be propagated only to VLAN 210. This is because when we added the port 3 to VLAN 210 the Mode option was specified as untagged. While for the other VLAN (209) the option Tagged was select for port 3 in VLAN 209. Therefore tagged packets will go to VLAN 209 while the untagged will go to 210.

When a packet is originated from an IP Phone it is tagged. Because the option un-tagged is selected for port 5 in VLAN 209 then the 802.1 tag is removed before the switch forwards the packet to this port. Similarly when an untagged packet is originated and sent by IPO the switch will tag the packet before forwarding LAN port 3.



# **Chapter 4.**

# **Static Administration**

# **Options**

---

## 4. Static Administration Options

A number of settings can be altered through the phone after installation.

- Values assigned through static administration override any set through the *46xxsettings.txt* file. They will remain active for the IP phone until a new boot file is downloaded.

These procedures should only be used if you are using static address installation. Do not use these procedures if you are using DHCP.



- To set parameters for all H323 IP phones on a system, you can edit the *46XXsettings.scr* script file.

### Hold vs Mute

Many of the static administration features are accessed using key sequences that begin by pressing either MUTE or HOLD. In recent firmware releases preference has been given to using MUTE and some phones, for example the 1600 Series, will only support MUTE.

### Entering Data for Administrative Options

This section describes how to enter data for the administrative options.

1. All local procedures are started with the phone idle. Then dialling MUTE and then a sequence of up to 7 numbers followed by #.
2. After the MUTE button is pressed, a 6-second timeout is in effect between button presses. If a valid button is not pressed within 6 seconds of the previous button, the collected digits are discarded and no administrative option is started.
3. Attempts to enter invalid data are rejected and the phone emits an error beep.
4. If a numeric digit is entered for a value or for a field of an IP address or subnet mask after only a zero has been entered, the new digit will replace the zero.
5. To go to the next step, press #.
6. To backspace within a field depends upon the phone type:
  - 4601, 4602, 5601, 5602:  Speaker key.
  - 4606:  Conference key.
  - 4612 & 4624:  Previous key.
  - 4610, 4620, 4625, 5610, 5620: Left-most key.

## 4.1 QoS Option Settings

Administering QoS options is not mandatory, but it is highly recommended. Use the following procedure to set Quality of Service (QoS) options.

1. While the phone is on-hook and idle, press the following sequence: MUTE 7 6 7 # (MUTE Q O S #).
2. The current 802.1Q settings are shown in sequence:
  - L2 audio=  
This is the phone's current 802.1 audio parameter. To accept the current value, press # or enter a value (between 0 and 7) and then press #.
  - L2 signaling=  
This is the phone's 802.1 signaling parameter. To accept the current value, press # or enter a value (between 0 and 7) and then press #.
  - L3 audio=  
This is the phone's Differential Services audio parameter. To accept the current value, press # or enter a value (between 0 and 63) and then press #.
  - L3 signaling=  
This is the phone's Differential Services signaling parameter. To accept the current value, press # or enter a value (between 0 and 63) and then press #.
3. If no new values were entered during this procedure, No new values is displayed. To end the procedure, press #.
4. If new values were entered during this procedure, Save new values? is displayed. To end the procedure or save the new values, press #. New values being saved is displayed and the phone returns to normal operation.

## 4.2 Secondary Ethernet (Hub)/IR Interface Enable/Disable

Use the following procedure to enable or disable the hub interface found on some H323 IP phones (usually marked with a  symbol). The default for the hub interface is enabled.

The same procedure can also be used to enable or disable the IR port found on some H323 IP phones, see [Infrared Dialling](#) .

1. While the phone is on-hook and idle, press the following sequence: MUTE 4 6 8 # (MUTE I N T #). The phone's port settings are shown in sequence. The options vary between different models of phone.
  - PHY2=  
This is the PC connection LAN socket marked as  on the phone. Press 1 or 0 to enable or disable the hub interface respectively. To continue, press #.
  - IR=  
This is the infrared (IR) port located on the front of some H323 IP phones. Press 1 or 0 to enable or disable the hub interface respectively. To continue, press #.
2. If you changed the setting, Save new values? is displayed. To end the procedure or save the new values, press #. If you press #, New values being saved is displayed and then returns to normal operation.

---

## 4.3 View Details

You can use the following procedure to view a number of phone details. These are in addition to the other static address and local administration options which can also be used to review settings.

1. While the phone is on-hook and idle, press the following sequence: MUTE 8 4 3 9 # (MUTE V I E W #).

- To display the set of details, press \* at any time during viewing.
- To end the procedure and restore the user interface to its previous state, press #.

2. A sequence of values are displayed. The values available may vary between phone models and the level of IP phone software installed on the phone. To display the next value press \*. To exit the information display press #.

- Model  
Shows the phones model number; for example, 4624D02A.
- Market  
Shows 1 for export or 0 for domestic (US). Not displayed on all phone types.
- Phone SN  
Shows the phone's Serial Number.
- PWB SN  
Shows the phone's Printed Wiring Board Serial Number.
- PWB comcode  
Shows the PWB's comcode.
- MAC address  
Shows the phone's MAC address as paired hexadecimal numbers.
- L2 tagging  
Indicates whether L2 tagging is on, off or set to auto.
- VLAN ID  
The VLAN ID used for the phone. The default is 0.
- IP address  
The IP address assigned to the phone.
- Subnet mask  
The subnet mask assigned to the phone.
- Router  
The router address assigned to the phone.
- File server  
The address of the file server assigned to the phone.
- Call server  
The address of the phone's H323 Gatekeeper.
- 802.1X  
The current setting for 802.1X operation if being used.
- Group  
This displays the group value set on the phone. Group values can be used to control which options (both firmware and settings) a phone downloads. Refer to the 4600 Series Phones LAN Administrator Guide.
- Protocol  
Display *Default*.
- filename1  
Shows the name of the phone application file in the phone's memory. These are values from within the boot file loaded and not the actual file name.
- 10Mbps Ethernet or 100Mbps Ethernet  
Shows the speed of the detected LAN connection.
- filename2  
Shows the boot file name and level. These are values from within the boot file loaded and not the actual file name.



## 4.4 Self-Test Procedure

1. To start the IP phone self-test procedures, press the following sequence: MUTE 8 3 7 8 # (MUTE T E S T #). The phone does the following:

- Each column of programmable button LED's is lit for half a second from left to right across the phone, in a repeating cycle. The Speaker/Mute LED and the message waiting LED are also lit in sequence.
- Buttons (other than #) generate a click if pressed.
- Phones with displays show Self test # =end for 1 second after self-test is started. Then a block character (all pixels on) is displayed in all display character locations for 5 seconds. Display of the block character is used to find bad display pixels.

2. One of the following is finally displayed:

- If self-test passes:  
Self test passed  
#=end

- If self-test fails:  
Self test failed  
#=end

3. To end the self-test, press #. The phone returns to normal operation.

---

## 4.5 Resetting a Phone

### Resetting a Phone

Resetting a phone clears the phones user settings but retains system settings such as the DHCP and file server addresses.

1. While the phone is on-hook and idle, press the following sequence: MUTE 7 3 7 3 8 # (MUTE R E S E T #). Reset values? is displayed.
2. To cancel this procedure press \*. To continue press #.
  - **WARNING**  
As soon as you press #, all static information will be erased without any possibility of recovering the data.
3. Whilst the system values are reset to their defaults, Resetting values is displayed.
4. Once the system values are reset, Restart phone? is displayed.
  - To end the procedure without restarting the phone, press \*.
  - To restart the phone, press #. The remainder of the procedure then depends on the status of the boot and application files. See [Restart Scenarios](#) <sup>62</sup>.

### Clearing a Phone

Clearing a phone removes all data values including settings such as the DHCP and file server addresses. This returns the phone to almost its original out-of-box state. The phone will still retain the firmware files it has downloaded.

1. While the phone is on-hook and idle, press the following sequence: MUTE 2 5 3 2 7 # (MUTE C L E A R #). Clear all values? is displayed.
2. To cancel this procedure press \*. To continue press #.
  - **WARNING**  
As soon as you press #, all static information will be erased without any possibility of recovering the data.
3. Whilst the system values are reset to their defaults, Clearing values is displayed.
4. Once all values are cleared, the phone will restart as if a new phone.

## 4.6 Site Specific Option Number

The Site Specific Option Number (SSON) is used by IP phones to request information from a DHCP server that is specifically for the phones and not for other IP devices being supported by the DHCP server. This number must match by a similarly numbered 'option' set on the DHCP server that define the various settings required by the phone.

The default SSON used by Avaya 4600 and 5600 Series IP phones is 176. The default SSON used by Avaya 1600 Series IP phones is 242. For phones being supported by IP Office DHCP, the SSON used by the phone must be matched by the site specific option numbers set in the IP Office configuration (System | LAN | Gatekeeper).

- **WARNING**  
Do not perform this if using static addressing. Only perform this procedure if using DHCP addressing and the DHCP option number has been changed from the normal default (176).

Setting the SSON on an IP Phone:

1. While the phone is on-hook and idle, press the following sequence: Mute 7 7 6 6 # (Mute S S O N #). SSON= is displayed followed by the current value.
2. Enter the new setting. This must be a number between 128 and 255.
3. To cancel this procedure, press \* or press # to save the new value.

Setting the SSON on IP Office

Note that changing the IP Office SSON settings requires the system to be rebooted.

1. In IP Office Manager, receive the system's current configuration.
2. Double-click  System.
3. Click the LAN tab.
4. Select the Gatekeeper sub tab.
5. Set the Site Specific Option Number (SSON) fields to the required numbers. For IP Office 4.2+ two SSON fields are available.
6. Click OK.
7. Send the configuration back to the system. Select Immediate or When Free as the Reboot Mode.

---

## 4.7 Automatic Gain Control

Automatic Gain Control (AGC) raises the volume when a caller is speaking quietly and lowers the volume when the caller is loud. AGC can be separately switched on or off for the phone handset, headset and speaker.

The AGC settings for all H323 IP phones can also be set through the 46xxsetting.txt file. On some phones it can also be switched on or off through the phone's user menus.

Switching automatic gain control on/off:

1. While the phone is on-hook and idle, press either MUTE 2 4 2 # (MUTE A G C #). The current AGC settings are displayed. Note that these may vary depending on the headset/speaker support provided by the phone model.
  - Handset AGC =  
Press the indicated key for the required setting (0 = off and 1 = on) and then press #.
  - Headset AGC =  
Press the indicated key for the required setting (0 = off and 1 = on) and then press #.
  - Speaker AGC =  
Press the indicated key for the required setting (0 = off and 1 = on) and then press #.
2. The phone should return to its normal idle state.

# **Chapter 5.**

# **Restart Scenarios**

---

## 5. Restart Scenarios

The sequence of the restart process depends on the status of the boot and application files on the TFTP server and those already downloaded to the phone. This appendix explains the different scenarios possible.

All of the following start-up processes involve the same initial steps as the phone negotiates with the DHCP and the TFTP server.

- After power is applied the phone displays Restarting...
- Initializing is then displayed.
- When either the application file (if there is one) or the boot code is uncompressed into RAM, Loading is displayed. Since this takes a while, asterisks, then periods, then asterisks are displayed on the second line to indicate that something is happening.
- When control is passed to the code in RAM, Starting is displayed.
- The phone detects and displays the speed of the Ethernet interface in Mbps (that is 10 or 100). The message No Ethernet means the LAN interface speed cannot be determined.
  - The Ethernet speed indicated is the LAN interface speed for both the phone and any attached PC.
- DHCP is displayed whilst the phone obtains an IP address and other information from the LAN's DHCP server. The number of elapsed seconds is incremented until DHCP successfully completes.
  - If the phone has been setup using static addressing (by pressing \* when DHCP is shown), it will skip DHCP and use the static address settings it was given.
  - Note that uploading a new boot file at any time erases all static address information.
- TFTP is displayed whilst waiting for a response from the TFTP server. 46XXUPGRADE.SCR is displayed whilst downloading the upgrade script TFTP server.
  - TFTP Error: Timed Out is displayed if the phone cannot locate TFTP server or upgrade script file. If the phone has been previously installed it will continue with the existing files in its memory.
- After the upgrade script is loaded, the sequence depends on the status of the files currently held in the phones memory, compared to those listed in the upgrade script.
  - [Boot File Need Upgrading](#) <sup>63</sup>.
  - [No Application File or Application File Needs Upgrading](#) <sup>63</sup>.
  - [Correct Boot File and Application File Already Loaded](#) <sup>63</sup>.

## 5.1 Boot File Needs Upgrading

Having processed the upgrade script file, the software determines that the name of the boot code file in the phone does not match that in the upgrade script. The script specifies the name of the new file to load.

- The phone displays the file name and the number of kilobytes loaded.
- The phone displays Saving to flash while the new boot file is stored in its flash memory. The percentage of the file stored and the number of seconds that have elapsed are shown. This will usually take longer than it took to download the file.
- The phone displays Restarting as it prepares to reboot using the new boot file.
- The phone displays Initializing.
- While the new boot file is uncompressed into RAM, the phone displays Loading. Since this takes a while, asterisks, then periods, then asterisks are displayed on the second line to indicate that something is happening.
- When control is passed to the software that has just loaded, the phone displays Starting.
- The phone displays Clearing whilst the flash memory is erased in preparation for rewriting the code. The percentage of memory erased and number of elapsed seconds are also shown.
- Updating is displayed whilst the boot code is rewritten. The percentage of boot code rewritten and number of elapsed seconds are also shown.
- When the new boot code has been successfully written into the flash memory, the phone resets so that the status of the phone application files can be checked.

Continue with the next procedure; [No Application File or Application File Needs Upgrading](#) [63].

## 5.2 No Application File or Application File Needs Upgrading

This happens with normal application file upgrades. Having processed the upgrade script file, the software determines that the name of the boot file in the phone is the correct version. It next determines that the name of the application file does not match that stored in the phone.

- The phone displays the required file name as it downloads the file from the TFTP server. It also displays the number of kilobytes downloaded.
- Saving to flash is displayed. The percentage of file stored and the number of seconds that have elapsed is also displayed. This will usually take longer than it took to download the file.
- The phone is reset so that the new system-specific application file can be executed.
- Continue with the next procedure; [Correct Boot File and Application File Already Loaded](#) [63].

## 5.3 Correct Boot File and Application File Already Loaded

This happens with most normal restarts. Having processed the upgrade script file, the software determines that the name of the boot file in the phone and the phone application file match those specified in the upgrade script.

- System-specific registration with the switch is started. The phone requests the extension number it should use and the password.
  - By default, the phone displays the last extension number it used. To accept, press #.
  - Whilst a password request is shown, password verification is not performed except if the user changes the extension number.
  - The password checked against is the user's Login Code stored in IP Office Manager.
- Upon completion of registration, a dial-tone is available on the phone.





# Chapter 6.

# Infrared Dialling

---

## 6. Infrared Dialling

Some H323 IP phones include an infrared (IR) port at the front of the phone. This includes the 4606, 4612, 4624 and 4620 phone. The port appears as a dark plastic window on the front edge of the phone, just below the normal dialling keys.



You can use the IR port in the following ways:

- Dial a Number to Start a Call  
This can be done by beaming the contact information held in a personal organizer address book.
- Swap Text Files During a Call  
If calling another IP phone extension that has an IR port, text files can be beamed between extensions.

When using infrared beaming, the following must be remembered:

- The device beaming or receiving must be IrDA compatible. This is the case for most computer and personal organizer IR ports.
- The range of transmission is typically a maximum of 5 feet (1.5 meters) and with a 5° degree spread (this is unlike IR devices used for remote controls which typically beam over a long range and much wider angle spread).
- For details of enabling and using IR beaming from your personal organizer or PC, refer to the manufacturer's information.

Note

- Some personal organizers can be set to beam to modems and mobile phones which use different transmission formats. The personal organizer may need to be set to beaming to another PC/personal organizer for dialling to work.
- These features have been tested with several devices as indicated. However, this is not a commitment to continually test or support those devices against future levels of software.

## 6.1 Enabling the IR Port

By default, where fitted the IR port on H323 IP phones is enabled. If necessary, it can be disabled.

1. With the phone on-hook and idle, press MUTE 4 6 8 # (MUTE I N T #). PHY2= and the current status is displayed. This is the setting for the phone's pass-through Ethernet port.
2. To continue, press #. IR=. The current status is displayed.
3. Change the status if required by following the displayed prompts and then press #. The phone will restart.

## 6.2 Dialling Phone Numbers

You can use the IR port to receive phone numbers beamed from an IR enabled PC or pocket organizer device. Any device that can beam contacts in the VCard format (.vcf) can be used.

If you are unsure of the file format used by your IR device, you can try beaming a contact anyway. The display on the IP phone will show the name of the file it received. If that ends in .vcf, then the phone should dial the number in the VCard file.

You will need to remember the following:

- The phone will only dial the first phone number in the VCard file.
- If your IP Office system has been setup to need a prefix for external dialling, that prefix must be in the VCard phone number.

In addition to dialling the phone number digits, the following additional characters can be included in the phone number:

- m = Mute
- c = Conference
- h = Hold
- t = Transfer
- , (comma) = 2-second pause

The following sections contains examples of dialling contacts by beaming from various different devices.

### Palm Organizer

The following was tested using a Palm Vx and M505. The connection setting (Prefs | Connection) must be *Ir to PC/Handheld*.

1. To enter the address book, click on the phone button or icon.
2. Locate the person or organization that you want to dial.
3. To go to Address View, click on the entry.
4. On the letters area of the graffiti pad, make a sweep from the bottom-left to the top-right. A set of icons should appear. Click on the beam icon. Alternatively, click on the menu icon and select Beam Address.

### Windows Pocket PC

The following was tested using a Compaq iPAQ Pocket PC:

1. In Contacts, select the entry you want to dial.
2. Click Tools and then select Beam Contact. The Pocket PC will search for and then display the IR enabled devices found. The IP phone should appear on the list.
3. Select the IP phone and the contact information will be beamed to it.

---

## 6.3 Beaming Files During a Call

During a call between two IR enabled extensions on the same system, you can also beam files between IR devices at each end.

The types of file sendable and receivable will depend on those supported by the devices sending and receiving, as if they were face to face.

VCard files can be exchanged without being interpreted as a number to dial.

### Palm Organizer

The following was tested using a Palm Vx and M505.

1. Inform the caller that you want to beam them a file and to have their Palm positioned in front of their extensions IR port ready to receive.
2. Locate the file that you want to send.
3. On the letters area of the graffiti pad, make a sweep from the bottom-left to the top-right. A set of icons should appear. Click on the beam icon. Alternatively, click on the Menu icon and select the displayed Beam option. The phones should display the first eight characters and the file extension of the file being transferred.

# **Chapter 7.**

# **Alternate DHCP Server Setup**

---

## 7. Alternate DHCP Server Setup

The recommended installation method for H323 IP phones uses a DHCP server. When 5 or less H323 IP phones are being supported, the DHCP can be performed by the IP Office Unit itself. However, if more than 5 H323 IP phones are being supported, a separate DHCP server must be used.

- For IP Office 4.2+ running on an IP500 IP Office system, the full IP extension capacity is supported using the IP Office for DHCP.

This document outlines, as an example, the basic steps for using a Windows server as the DHCP server for IP phone installation. However, the principles of defining a scope is applicable to most DHCP servers.

You will need the following information from the customer's network manager:

- The IP address range and subnet mask the H323 IP phones should use.
- The IP Gateway address.
- The DNS domain name, DNS server address and the WINS server address.
- The DHCP lease time.
- The IP address of the IP Office unit.
- The IP address of the PC running Manager (this PC acts as a file server for the H323 IP phones during installation).

## 7.1 Using a Windows DHCP Server

### 1. Checking for DHCP

1. On the server, select Start | Program | Administrative Tools | Computer Management.
2. Under Services and Applications in the Computer Management Tree, locate DHCP.
3. If DHCP is not present then you need to install the DHCP components. Refer to the Microsoft documentation.

### 2. Windows DHCP Setup for H323 IP Phones

#### 2a. Creating the Scope

A DHCP scope defines the IP addresses that the DHCP server can issue in response to DHCP requests. Different scopes may be defined for different types of devices.

1. Select Start | Programs | Administrative Tools | DHCP.
2. Right-click on the server and select New | Scope.
3. The scope creation wizard will be started, click Next.
4. Enter a name and comment for the scope and click Next.
5. Enter the address range to use, for example from 200.200.200.1 to 200.200.200.15 (remember the host part cannot be 0).
6. Enter the subnet mask as either the number of bits used or the actual mask, for example 24 is the same as 255.255.255.0 and click Next.
7. You can specify addresses to be excluded. You can do this either entering a range (e.g. 200.200.200.5 to 200.200.200.7) and clicking Add, or entering a single address and clicking Add.
  - Note: You should exclude the IP Office from this range, as the DHCP Options in the IP Office should be disabled. This is only a recommendation. You can also accomplish this by leaving available addresses outside of the scopes range.
8. Click Next.
9. You can now set the lease time for addresses. If set too large, addresses used by devices no longer attached will not expire and be available for reuse in a reasonable time. This reduces the number of addresses available for new devices. If set too short, it will generate unnecessary traffic for address renewals. The default is 8 days. Click Next.
10. The wizard gives the option to configure the most common DHCP options. Select Yes and then click Next.
11. Enter the address of the gateway and click Add. You can enter several. When all are entered, click Next.
12. Enter the DNS domain (eg. example.com) and the DNS server addresses. Click Next.
13. Enter the WINS server addresses and click Add and then click Next.
14. You will then be asked if you wish to activate the scope. Select No and then click Next.
15. Click Finish. The new scope will now be listed and the status is *Inactive*.

---

## 2b. Adding a 242 Option

In addition to issuing IP address information, DHCP servers can issue other information in response to requests for different specific DHCP option numbers. The settings for each option are attached to the scope.

1600 Series H323 IP phones request option 242 from the DHCP server. The option should include defining the address of the phone's H323 gatekeeper (the IP Office) and the address of the HTTP file server.

1. Right-click on the DHCP server.
2. From the pop-up menu, select Predefined options.
3. Select Add.
4. Enter the following information:
  - Name: 16xxOptions
  - Data type: String
  - Code: 242
  - Description: IP Phone settings

5. Click OK.

6. In the string value field, enter the following:

```
MCIPADD=xxx.xxx.xxx.xxx,MCPORT=1719,HTTPSRVR=yyy.yyy.yyy.yyy,HTTPDIR=z, VLANTEST=0
```

where:

- *MCIPADD*= is the H323 Gatekeeper (Callserver) address. Normally, this is the IP Office Unit's LAN1 address. You can enter several IP addresses, separating each by a comma with no space. This allows specification of a fallback H323 gatekeeper.
  - Note: The phones will wait 3 minutes before switching to the fallback and will not switch back when the first server recovers, until the phone is rebooted.
- *MCPORT*= is the RAS port address for initiating phone registration. The default is 1719.
- *HTTPSRVR*= is the HTTP file server IP address. .
- *HTTPDIR*= is the HTTP file directory where the IP phone files are located. This entry is not required if those files are in the server's root directory.
- *VLANTEST*= is the number of minutes phones should attempt to register on a specific VLAN before defaulting back to VLAN 0. This field is optional. A setting of 0 disables the fallback to registering on VLAN 0.
- The maximum string length is 127 characters. To reduce the length the TFTP Server address can be specified through attaching an Option 66 entry to the Scope. See [Alternate Options](#) [74].

7. Click OK.

8. Expand the server by clicking on the [+] next to it.

9. Click on the scope you just created for the 1600 phones.

10. In the right-hand panel, right-click on the scope and select Scope Options.

11. In the general tab, make sure 242 is checked.

12. Verify the String value is correct and click OK.



### 2c. Adding a 176 Option

4600 and 5600 Series H323 IP phones use option 176 rather than option 242 as above.

The option 176 can be setup to use the same HTTP file server as the 1600 Series phones. However some older 4600 Series H3232 IP phones only support TFTP. Therefore the options for a TFTP scope are shown below.

1. Right-click on the DHCP server.
2. From the pop-up menu, select Predefined options.
3. Select Add.
4. Enter the following information:
  - Name: 46xxOptions
  - Data type: String
  - Code: 176
  - Description: IP Phone settings

5. Click OK.

6. In the string value field, enter the following:

`MCIPADD=xxx.xxx.xxx.xxx,MCPORT=1719,TFTPSRVR=yyy.yyy.yyy.yyy,TFTPDIR=z, VLANTEST=0`

where:

- *MCIPADD*= is the H323 Gatekeeper (Callserver) address. Normally, this is the IP Office Unit's LAN1 address. You can enter several IP addresses, separating each by a comma with no space. This allows specification of a fallback H323 gatekeeper.
  - Note: The phones will wait 3 minutes before switching to the fallback and will not switch back when the first server recovers, until the phone is rebooted.
- *MCPORT*= is the RAS port address for initiating phone registration.
- *TFTPSRVR*= is the TFTP Server IP Address. Normally, this is the IP address of the PC running Manager.
- *TFTPDIR*= is the TFTP Server directory where the IP phone files are located. This entry is not required if those files are in the TFTP server's default directory.
- *VLANTEST*= is the number of minutes phones should attempt to register on a specific VLAN before defaulting back to VLAN 0. This field is optional. A setting of 0 disables the fallback to registering on VLAN 0.

7. The maximum string length is 127 characters. To reduce the length the TFTP Server address can be specified through attaching an Option 66 entry to the Scope. See [Alternate Options](#) <sup>(74)</sup>.

8. Click OK.

9. Expand the server by clicking on the [ + ] next to it.

10. Click on the scope you just created for the 4600 phones.

11. In the right-hand panel, right-click on the scope and select Scope Options.

12. In the general tab, make sure 176 is checked.

13. Verify the String value is correct and click OK.

### 2d. Activate the Scope

The scope can be manually activated by right clicking on the scope, select All Tasks and select Activate. The activation is immediate.

You should now be able to start installing H323 IP phones using DHCP. If Manager is being used as the HTTP or TFTP server ensure that it is running on the specified PC.

---

## 7.2 Alternate Options

In this document, all IP phone information is issued through the Scope and the Option 176 settings. Depending on the DHCP server, other options may have to be used within the scope.

- Option 1 - Subnet mask
- Option 3 - Gateway IP Address  
If using more than one address, the total list can contain up to 255 total ASCII characters. You must separate IP addresses with commas with no intervening spaces.
- Option 6 - DNS server(s) Address  
If using more than one address, the total list can contain up to 127 total ASCII characters. You must separate IP addresses with commas with no intervening spaces. At least one address in Option 6 must be a valid, non zero, dotted decimal address.
- Option 15 - DNS Domain Name  
This string contains the domain name to be used when DNS names in system parameters are resolved into IP addresses. This domain name is appended to the DNS name before the IP telephone attempts to resolve the DNS address. Option 15 is necessary if you want to use a DNS name for the HTTP server.
- Option 51 - DHCP Lease Time  
If this option is not received, the DHCP offer is not be accepted. Avaya recommends a lease time of six weeks or greater. If this option has a value of FFFFFFFF hex, the IP address lease is assumed to be infinite as per RFC 2131, Section 3.3, so that renewal and rebinding procedures are not necessary even if Options 58 and 59 are received. Expired leases cause Avaya IP Telephones to reboot.
  - Avaya recommends providing enough leases so an IP address for an IP telephone does not change if it is briefly taken offline.
  - DHCP standard states that when a DHCP lease expires, the device should immediately cease using its assigned IP address. If the network has problems and the only DHCP server is centralized, the server is not accessible to the given telephone. In this case the telephone is not usable until the server can be reached.
  - Avaya recommends, once assigned an IP address, the telephone continues using that address after the DHCP lease expires, until a conflict with another device is detected. The 1600 Series IP Telephone customizable parameter DHCPSTD allows an administrator to specify that the telephone either:
    - Comply with the DHCP standard by setting DHCPSTD to 1
    - Continue to use its IP address after the DHCP lease expires by setting DHCPSTD to 0. This is the default. If used, after the DHCP lease expires the telephone sends an ARP Request for its own IP address every five seconds. The request continues either forever, or until the telephone receives an ARP Reply. After receiving an ARP Reply, the telephone displays an error message, sets its IP address to 0.0.0.0, and attempts to contact the DHCP server again.
- Option 52 - Overload Option  
If this option is received in a message, the telephone interprets the sname and file fields in accordance with IETF RFC 2132, Section 9.3, listed in Appendix B: Related Documentation.
- Option 53 - DHCP Message Type  
Value is 1 (DHCPDISCOVER) or 3 (DHCPREQUEST).
- Option 55 - Parameter Request List  
Acceptable values are: 1 (subnet mask), 3 (router IP address[es]), 6 (domain name server IP address[es]), 15 (domain name), NVSSON (site-specific option number)
- Option 57 - Maximum DHCP Message Size
- Option 58 - DHCP Lease Renew Time  
If not received or if this value is greater than that for Option 51, the default value of T1 (renewal timer) is used as per IETF RFC 2131, Section 4.5.
- Option 59 - DHCP Lease Rebind Time  
If not received or if this value is greater than that for Option 51, the default value of T2 (rebinding timer) is used as per IETF RFC 2131, Section 4.5

### Note

- The H323 IP phones, any Option 66 settings will be overridden by any TFTP entry in Option 176. Using Option 66 as part of the Scope is useful if alternate Gatekeeper addresses are required in the Option 176 settings whilst keeping within the 127 character limit.

# Chapter 8.

# WML Server Setup

---

## 8. WML Server Setup

The 4610SW, 4620, 4620SW, 5610SW, 5620 and 5620 phones can act as WAP (Wireless Access Protocol) browsers. This allows them to view WML (Wireless Markup Language) pages. WML is a page coding language similar to HTML but intended for phone devices with small screens and no full keyboard.

To do WAP browsing, the phones need to be configured to access a home page. That home page can contain links and information appropriate to the customer installation.

This section looks at the setting up and configuration of a simple test system. The aim is to introduce the basic principles of WAP browsing operation.

- For testing and demonstration purposes Avaya host a set of WML files at <http://support.avaya.com/elmodocs/avayaip/4620/home.wml>.
- Most PC web browsers cannot display .wml files. However Opera is able display WML pages which makes it a useful tool with which to test WML access and operation.

### What WML is Supported

The phones are WML 1.2 compliant WAP browsers. However, they do not support all WML 1.2 tags.

For details of those WML 1.2 tags supported, refer to the 4600 Series IP Telephone LAN Administrator's Guide.

WTAI (Wireless Telephony Application Interface) links are supported to allow numbers embedded in WML pages to be dialed from phones.

## 8.1 Testing 4620 WML Browsing Using Xitami



### 1. Introduction

Xitami is a small and simple web server application. It is used here to configure one of our LAN PC's as a web server able to provide .wml pages in response to requests from an IP phone.

- **Web Server PC**  
Any Windows PC on the IP Office LAN. Ideally this PC should have a fixed IP address.
- **Server Software**  
Xitami can be obtained from <http://www.imatix.com>. A copy is available on the IP Office Documentation CD. If an alternate Apache or IIS web server is available refer to the section on configuring [Apache](#) or [IIS](#) for WML files.
- **Sample WML Pages**  
A number of sample pages can be downloaded from <http://support.avaya.com/japple/css/japple?PAGE=ProductArea&temp.productId=107755>.

### 2. Installing the Web Server

For this test we used a web server called Xitami. It is a simple, small and flexible web server for use on Windows based PC's.

1. On the server PC, run Xitami.exe to start installation of the web server.
2. Accept the various defaults.
3. When asked for a User Name and Password, note the details entered.
4. When finished, select Run. The Xitami server appears as an  icon.
5. To display the web servers basic properties, double-click . Note the IP addresses.
6. To close the window without stopping the web server, click Close.
7. Open the PC's web browser and enter `http://<server IP address>`. You should see the default Xitami web pages.

If there are other PC's on the IP Office LAN they should also be able to browse the web server's IP address.

### 3. Configuring the Xitami Web Server for WAP

Basic web browsing consist of requests to the web server for .htm and .html text pages and .gif and .jpg images which are then displayed by a browser program. WAP browsing uses different file types, wml for text and .wbmp for images.

The web server needs to be configured to recognize those file types, and several others, as files that might be requested by a WAP browser program. This is done by adding what many web servers refer to as MIME types.

1. On the web server PC, open the folder C:\Xitami.
2. Using a plain text editor such as Notepad or WordPad, open the file Xitami.cfg.
3. Scroll down the file to the section [MIME]. You will see that it is a list of settings for different text, image and application files types.
4. Scroll the end of the file and add the following new set of MIME type for files that are supported by H323 IP phones with a WAP browser.

```
# WAP MIME types
wml=text/vnd.wap.wml
```

5. Save the file.

---

#### 4. Installing Sample WML Pages

Download the sample pages from Avaya (see the link above).

1. On the web server PC, open the folder c:\Xitami\webpages. For Apache and IIS use the appropriate root folder.
2. Create a new sub-folder called 4620.
3. Copy the sample .wml pages into this folder.

##### 4a. Creating a Simple WML Page

As an alternative to using the sample pages provided, you can create a simple .wml page using an editor such as Notepad.

1. Start Notepad.
2. Add the following text:

```
<?xml version="1.0"?>
<!DOCTYPE wml PUBLIC "-//WAPFORUM//DTD WML 1.1//EN"ξ "http://www.wapforum.org/DTD/wml\_1.2.xml"
<wml>
<card id="card1" title="Hello World!">
<p>Hello world!</p>
</card>
</wml>
```

3. Save the file as index.wml. Notepad may save the file as index.wml.txt. If this happens, rename the file back to index.wml.
4. Copy the file into the folder c:\Xitami\webpages\4620.

##### 4b. Dialling from a WML Page

WTAI (Wireless Telephony Application Interface) allows numbers contained in a WML page to be dialed.

An example WTAI link is shown below:

```
<a href="wtai://wp/mc;200" title="Reception">Call Reception</a>
```

This example link displays as Call Reception and have an adjacent phone icon. Pressing the adjacent display key on the phone will dial the number contained in the link.

## 8.2 Setting the Home Page

WAP capable H323 IP phones display a key option labeled Web when setup with a home page (press PHONE/EXIT if in any other menu).

To access the home page, press the adjacent display key. The home page is set by editing the *46XXsetting.scr* file found in the IP Office Manager applications program folder.

- For testing and demonstration purposes Avaya host a set of WML files at <http://support.avaya.com/elmodocs/avayaip/4620/home.wml>.
- Most PC web browsers cannot display .wml files. However Opera is able display WML pages which makes it a useful tool with which to test WML access and operation.

1. Locate the 46XXsettings.txt file that has been previously downloaded to the phones. This will contain any custom settings for the Avaya IP phones being supported on the system.

- If only the file 46XXsettings.scr is present rename it as 46XXsettings.txt.

2. Double-click on 46XXsettings.txt. The file will open in Notepad. The section relating to WML browsing is towards the end of the file. It will look similar to the following:

```
##### SETTINGS FOR AVAYA 4620 IP PHONE #####
## 4620 Web Launch page in WML - Default: Avaya hosted
SET WMLHOME http://192.168.42.200/4620/index.wml
## The Proxy server used for your LAN - IP address or human readable name (check your browser settings).
# SET WMLPROXY nj.proxy.avaya.com
## The http proxy server port (check your browser settings).
SET WMLPORT 8000
## Exceptions: You must use an IP address not a DNS name
# Example: SET WMLEXCEPT 111.222.333.444
## Text coding for the web pages defaulted to ASCII.
SET WMLCODING ASCII
##### END OF AVAYA 4620 IP PHONE #####
```

3. Edit SET WMLHOME to be the address of the sample index.wml file on the web server. In this example; *http://192.168.42.200/4620/index.wml*.

4. If DNS is being used to access the web server by IP name, the SET DOMAIN and SET DNSSRV lines at the start of the 46XXsettings.scr file should be edited to match the LAN settings. The preceding #'s should be removed from the lines to make them active.

5. Close and save the file.

6. Restart the phones. Once the phone has restarted it should display Web as one of the screen option.

---

## 8.3 Apache Web Server WML Configuration

Apache is an open-source web server that is available on many platforms. Basic familiarity with Unix is necessary to configure it. The following is a step-by-step guide for configuring Apache Web-server:

1. To set MIME types in Apache, a plain text file called `httpd.conf` is used.
2. The location for this file varies depending on the individual setup, but the most usual path is `/etc/httpd/conf/httpd.conf`. If the operating system is Windows, then look for a folder called `conf` under where Apache is installed.
3. Using a text editor, open `httpd.conf`.
4. Scroll down to the `AddType` section (usually at the bottom of the file) and add the following line: `AddType text/vnd.wap.wml wml`
5. Save the file.

## 8.4 Microsoft IIS Web Server WML Configuration

Microsoft Internet Information Server (IIS) is configured through the Internet Service Manager.

The following step-by-step guide can be used to set up MIME types necessary for WML:

1. Select Start | Control Panel | Administrative Tools | Internet Services Manager.
2. Right-click on Server and select Properties.
3. In the Computer MIME Map section, click Edit.
4. Click New Type and create a new file type using the parameters below:
  - Associated extension: `wml`
  - Content type: `text/vnd.wap.wml`
5. Click OK.
6. Stop and restart the web server so that the newly added MIME types are picked up.



## 8.5 Open URL Entry

This document provides sample WML code on how to develop WML pages implementing a text box-based go to a URL function. This code allows a user to enter a URL into a text entry area and link to that site.

Please note that these are examples, not an exhaustive list. All WML code is presented in italics.

### Case 1. Input Box Followed by an Anchor Tag

Description: The user enters a URL into the text entry box and clicks on the URL to retrieve it.

```
<input name="url" title="Name" />  
<anchor title="get it">  
Go Get It  
<go method="get" href="$(url)">  
</go>  
</anchor>
```

### Case 2. Input Box Followed by an A Tag

```
<input name="url" title="Name" />  
<a href="$(url)">Go Get It</a>
```

### Case 3. Input Box Followed by a Submit Button

```
<input name="url" title="Name" />  
<do type="submit" name="submit" label="Submit">  
<go method="get" href="$(url)">  
</go>  
</do>
```

### Case 4. Input Box Followed by an Anchor Tag Where the Anchor Tag Already Displays HTTP://

This method displays http so that the user only has to type in the URL at the end of http://.

```
<input name="url" title="Name" value="http://" />  
<anchor title="GET">  
Go Get it  
<go method="get" href="$(url)">  
</go>  
</anchor>
```



# Index

## 1

100Mbps Ethernet 56  
 10Mbps 14  
 10Mbps Ethernet 56  
 1151C1 21  
 1151C1/1151C2 34  
 1151C2 21  
 1152A1 34  
 150ms 16  
 1719,TFTPSVR 71  
 176 option 71  
 192.168.202.x 47  
 192.168.202.X VLANTEST 47  
 192.168.42.200/4620/index.wml 79  
 192.168.43.x 47  
 19-inch 21  
 1b 31  
 1U 21  
 1W 21

## 2

25ms 17  
 264V AC 21  
 2a 71  
 2b 71  
 2c 71  
 2-second 67

## 3

3.5W 21  
 30A Switch Upgrade Base 21  
 3600 7  
 3616 7  
 3b 35  
 3-party  
   configuring 13

## 4

4.0W 21  
 4.1W 21  
 4.6W 21  
 4.9W 21  
 45-days 44  
 4600 7, 31, 42, 44, 47, 70, 76  
   created 71  
 4600 Series IP Telephone LAN Administrator's Guide 44  
   refer 76  
   see 70  
 4600 Site Specific Settings 31  
 4601dape1\_82.bin 23  
 4601dbte1\_82.bin 23  
 4602dape1\_82.bin 23  
 4602dbte1\_82.bin 23  
 4602sape1\_82.bin 23  
 4602sbte1\_82.bin 23  
 4602SW 7, 20, 21  
 4606 7, 20, 21  
   includes 66  
 4610SW 7, 20, 21, 44, 76  
 4620 7, 21, 31, 66, 76, 77  
   relating 79  
 4620IP 20  
 4620SW 7, 20, 44, 76  
 4621SW 7, 44  
   applies 21  
 4622

  support 7  
 4624D 21  
 4624D01 21  
 4624D02A 56  
 4625SW 21, 44  
 46setting files 47  
 46vpnsettings.txt file 44  
 46xx  
   VPNremote 44  
 46xxOptions 71  
 46XXsetting.scr 79  
 46XXsetting.scr file  
   editing 79  
 46xxsetting.txt file 60  
 46xxsettings file 47  
 46XXsettings.scr 31  
   back 79  
   edit 54  
 46XXsettings.scr file  
   46XXsettings.txt 79  
   start 79  
 46XXsettings.txt 28, 31  
   46XXsettings.scr file 79  
 46xxsettings.txt file  
   Creating 31  
 46XXupgrade.scr 62  
 46xxupgrade.scr file  
   lines 31  
 46xxupgrade.scr file instruct  
   phone 31  
 47  
   63HZ 21  
 4a 77  
 4b 77

## 5

5.0W 21  
 5.9W 21  
 5601ape1810.bin 23  
 5601bte1810.bin 23  
 5602dape1806.bin 23  
 5602dbte1806.bin 23  
 5602sape1806.bin 23  
 5602sbte1806.bin 23  
 5602SW 7, 20, 21  
 5610SW 7, 20, 44, 76  
 5620SW 7, 20  
 5621SW phones 44

## 6

6.0W 21  
 6.45W 21  
 63HZ  
   47 21  
 64ms 17  
 6k3 17

## 7

7.7W 21  
 792ms PRN 41

## 8

8.0W 21  
 801.11b 7  
 802.11a/b/g 7  
 802.11b 7  
 802.1p 47  
 802.1Q 35, 47, 55  
 802.3af 21

---

8k 17

**9**

9.9W 21

90  
     PSU requires 21

**A**

a10d01b2\_2.bin 23

a20d01a2\_2.bin 23

a20d01b2\_2.bin 23

AC 21

access point 7

Access Points 7

Action 33, 37

Activate  
     Scope 71

Active Directory using RADIUS 44

Add 21, 33, 44, 47, 77, 80  
     clicking 71

ADDR 42

address 14, 19, 23, 35, 37, 42, 47, 58, 59, 62, 66, 67, 70, 71, 74, 77, 79  
     PC 28

address programming 35

Address View 67

AddType 80

AddType text/vnd.wap.wml wml 80

Administrative 56, 71, 80

Administrative Details 56

administrative options 54, 56

Administrative Tools 71, 80

Adtran Netvanta 3305 VPN Router 44

Advanced 79

AGC 60

ains600,2600,192.168.42.10,1026 41

All LAN 14

All Tasks 71

Alternate 13, 28, 70, 74

Alternate DHCP Servers 13, 28  
     Avaya IP 70

Alternate Options 74

Anchor Tag 81

Anchor Tag Already Displays HTTP  
     Anchor Tag Where 81

Anchor Tag Where  
     Anchor Tag Already Displays HTTP 81

Apache 80

Apache Web Server 80

Apache Web-server 80

Apache-Tomcat 44

Appearance 33, 37

Appendix 62

appendix explains 62

application file 42, 56, 62, 63

Application File Already Loaded 63

Application File Needs Upgrading 63

Application Notes  
     Configuring 44

Applications 16, 23, 42, 44, 56, 58, 62, 63, 71, 77, 79

applies 19, 36, 42, 62  
     4621SW 21

ASCII  
     defaulted 79

ASDM 44

attaching  
     Option 66 71

Audio 55

Auto-create Extn Enable 28, 37

Automatic Gain Control 60

Automatic Selection 37

auto-negotiated 17

autorun 23

autorun during PC 23

Avaya 20, 21, 25, 44, 47, 70, 79  
     escalated 16  
     including 23  
     number 7

Avaya 1151C1 21

Avaya 1151C2 21

Avaya 1152A1 Power Distribution Unit 21

Avaya 30A Switch Upgrade Base  
     fitting 20

Avaya 4622SW IP Telephone 44

Avaya Gateways 44

Avaya H.323 IP 7

Avaya IP 44, 47  
     Alternate DHCP Servers 70

Avaya IP Office 44, 47

Avaya P333T-PWR Switch 21

Avaya SG Series 44

Avaya Voice Priority Processor 7

Avaya VSU Series 44

Avaya WebLM 44

Avaya WebLM Software 44

AvayaLabs 47

Avays VSU Series 44

Avoid Hubs 19

AVPP 7

**B**

b10d01b2\_2.bin 23

b20d01a2\_2.bin 23

b20d01b2\_2.bin 23

back 35, 71  
     46XXsettings.scr 79  
     index.wml 77  
     IP 20, 34  
     Manager PC's 25

back spacing 35

backlight 21

Backup 19, 21

bbla0\_83.bin 23

Beam Address 67

Beam Contact 67

Beaming  
     Files During 68

beaming files 68

bin/VPN Phone 44

Blue 47

boot 7, 35, 54, 56, 58, 62, 63

Boot File 7, 35, 54, 56, 62, 63

Boot File Needs Upgrading 63

Browsing Using Xitami 77

Button Programming 33

**C**

c0a82c15 41

cabling 14  
     Connections 19

Call 7, 14, 17, 19, 31, 36, 37, 42, 44, 47, 77, 80  
     During 68  
     subnet 35  
     Swap Text Files During 66

- call answering 7
- Call Reception 77
- Call Server 47
- call signalling 17
- called 46xxsettings.txt 31
- called CCD 44
- Callserver 71
- CallSv 35
- CallSvPort 35
- card1 77
- cat 5 14
- CAT3 21
  - Existing 14
- CAT5 14, 19, 21
- CAT5 cabling 14
- Catalyst
  - changes 21
  - provide 21
- Category 14, 42
- cause 19
  - timeout 42
- CD 23, 44, 77
- CD/DVD 44
- changes 14, 23, 25, 28, 31, 33, 35, 36, 37, 47, 54, 55, 59, 63, 67
  - Catalyst 21
- checkbox 44
- Cisco
  - Configuring 44
- Cisco Adaptive Security Device Manager 44
- Cisco Catalyst 21
- Cisco PIX 500 Series Security Appliances 44
- Cisco PIX Security Appliance
  - Configuring 44
- Cisco VPN 300 Series Concentrators 44
- Cisco VPN 3000 Series Concentrators 44
- Clearing 63
- CLI configuration 47
- clicking
  - Add 71
- Close 16, 41, 77, 79, 80
- cmd
  - Windows 41
- codecs 17
- Compact Flash 25
- Compaq iPAQ Pocket PC 67
- Compression Mode 37
- Computer Management 71
- Computer Management Tree 71
- Computer MIME Map 80
- Concentrator 44
- conf 80
- configuration 7, 14, 16, 20, 23, 28, 33, 37, 42, 44, 47, 59, 70, 76, 79, 80
  - file source 25
  - Microsoft IIS 80
- configuration back 25, 33, 37, 44, 59
- Configuration Quick Start 44
- configuring
  - 3-party 13
  - Application Notes 44
  - Cisco 44
  - Cisco PIX Security Appliance 44
  - File Source 25
  - VPN Remote 44
- CONFLICT 42
- Connect 14, 17, 19, 20, 44, 47
  - LAN 34
- Connections 14, 20, 21, 34, 42, 44, 55, 56, 67
  - Cabling 19
- Contacts 66, 67
- Control Panel 80
- Control Unit Memory Card
  - Using 25
- Control Unit Settings 28
- Correct Boot File 63
- Creating 47
  - 4600 71
  - 46xxsettings.txt File 31
  - Scope 71
  - Simple 77
- Currently VPNremote Phone 44
- D**
- Data 16, 17, 19, 20, 21, 34, 35, 47, 58, 71
- Data occupy 47
- data VLAN's 47
- Data/Common/WML/samples 77
- def06r1\_8\_3.bin 23
- def24r1\_8\_3.bin 23
- Default 17, 35, 37, 44, 55, 58, 59, 63, 67, 71, 77
  - ASCII 79
- defaults 58
- defines 47, 59, 70
  - IP 71
- Definity 70
- Deployment Guide 44
- DHCP 13, 14, 16, 23, 35, 42, 47, 54, 58, 59, 62, 74
  - alternate 70
  - connection 34
  - introduction 7
  - preparation 28
  - windows 71
- DHCP Address Installation 34, 35
- DHCP addressing 59
- DHCP Options 47, 59, 71
- DHCP Relay 47
- DHCP Server 13, 14, 23, 28, 34, 35, 42, 47, 59, 70, 71, 74
- DHCP server assigning 42
- DHCP Settings 47
- DHCP Setup
  - H.323 IP Phones 71
- dialling 66, 67, 77
- dialling contacts 67
- Dialling Phone Numbers 67
- DiffServ 19
  - IP Office supports 19
- DiffServ QoS 19
- Digital Telephony 37
- Direct Media 17
- Disable Auto-Create Extension 37
- display 28, 33, 34, 35, 36, 37, 55, 56, 57, 58, 59, 60, 62, 63, 67, 68, 77, 79, 81
  - IR 67
- displayed Beam option 68
- displays Clearing 63
- displays Initializing 34, 63
- displays Loading 63
- DNS 70, 71, 74, 79
- DNS Domain Name 70, 74
- DNS Server Address 70, 74
- Doc Reference 44
- DOCTYPE wml PUBLIC 77

---

Documentation CD 77  
Double-click System 59  
Duplicate IP Addressing 19  
during  
    Call 68  
    Manager 14  
DVD 44

**E**  
Edit SET WMLHOME 79  
editing 80  
    46XXsetting.scr file 79  
    46XXsettings.scr 54  
Embedded Voicemail Memory 23  
END OF AVAYA 4620 IP PHONE 79  
END OF FILE 31  
Endpoints 41  
End-to-End Matching Standards 19  
English 42  
Enter 14, 23, 25, 28, 33, 34, 35, 36, 37, 41, 44, 55, 59, 67, 74, 77, 79, 81  
    subnet 71  
    WINS 71  
Enter cmd 25, 41  
Enter tftp 41  
entered during 55  
error messages 42  
escalated  
    Avaya 16  
etc/httpd/conf/httpd.conf 80  
Ethernet 19, 42, 47, 62, 67  
    Power 21  
Ethernet LAN 21  
Ethernet Switch 47  
EU24 21  
EU24BL 21  
Example setup - Overview 47  
Excessive Utilization 19  
Existing  
    CAT3 14  
Ext 36  
extension 37  
Extension ID 33  
Extension Number 14, 28, 33, 36, 37, 63  
    IP phone 42  
extensions 7, 14, 17, 28, 33, 36, 37, 42, 44, 66, 68, 79, 80  
    phone requests 63  
    user changes 63  
Extn 33, 37  
Extn2601,2601,192.168.42.4,1720 41  
Extn2602,2602,192.168.42.2,1720 41

**F**  
file 23, 25, 28, 31, 36, 41, 42, 44, 47, 56, 58, 62, 63, 66, 67, 68, 71, 77, 79, 80  
    phone displays 63  
File Source  
    Configuring 25  
File Writer  
    set 25  
filename1 56  
filename2 56  
Files During  
    Beaming 68  
FileSv 35  
Find 57  
Finish 71, 77  
fitting

Avaya 30A Switch Upgrade Base 20  
following  
    H.323 IP 7  
form 25, 28, 41  
    Quality 19  
Full Name 37

**G**  
G.711 17  
G.723 17  
G.729a 17  
G.729b 17  
gatekeeper 13, 14, 28, 35, 37, 59, 71, 74  
Gatekeeper Enabled 28  
Gatekeeper Settings 28  
GEN  
    phone 21  
GEN1 21  
GEN1 4612 21  
GET 81  
Get It 81  
Get It</a 81  
gif 77  
GRQ 41  
gvrp 47

**H**  
H.08.60 47  
H.232 20  
H.323 7, 13, 14, 16, 17, 20, 21, 23, 28, 31, 41, 42, 54, 55, 59, 60, 66, 67, 70, 71, 74, 77, 79  
H.323 Gatekeeper 13  
H.323 IP 14, 17, 20, 23, 28, 31, 41, 42, 54, 55, 59, 60, 66, 67, 70, 74, 77, 79  
    following 7  
    including 21  
    installing 16, 71  
    number 7  
    provide 13  
H.323 IP phone requires 21  
H.323 IP phones 7, 13, 14, 17, 20, 21, 23, 28, 31, 41, 55, 60, 67, 70, 74, 77, 79  
    DHCP Setup 71  
H323 Gatekeeper 14, 71  
Hello World 77  
Hold 35, 55, 56, 57, 58, 60, 67  
home page 31, 76, 79  
hostname 47  
HP 47  
HP Procurve 47  
HP Procurve CLI 47  
HP Procurve Ethernet 2626 PWR Ethernet 47  
HP Procurve Switch 47  
HP-Switch 47  
href 77, 81  
htm 77  
HTML 76, 77  
httpd.conf 80

**I**  
i10c01a2\_2.bin 23  
i10d01a2\_2.bin 23  
i20d01a2\_2.bin 23  
IEEE 802.2p/q  
    understanding 47  
IEEE 802.3af 20, 21  
IIS 80  
IIS 5.0 80

---

- IIS Admin Service' 80
  - IKE Extended Authentication 44
  - Immediate 33, 37, 71
  - Important Note 66
  - Inactive 71
  - includes 13, 16, 28, 41, 47, 67, 77
    - 4606 66
    - Avaya 23
    - H.323 IP 21
    - PC 20
    - WAN Ethernet 19
  - index.wml 79
    - back 77
  - index.wml file 79
  - index.wml.txt 77
  - Infrared Dialling 66
  - Initializing 34, 63
  - Input Box Followed 81
  - installation 19, 23, 28, 31, 34, 37, 44, 54, 58, 70, 76, 77, 79
    - DHCP 7
      - requirements 14
      - small 13
      - static address 35
  - Installation Documentation 44
  - Installation Requirements 14
  - installing
    - H.323 IP 16, 71
    - IP 14
    - Sample 77
    - VCM 17
    - Web Server 77
  - Internet 44, 80
  - Internet Authentication Service 44
  - Internet Service Manager 80
  - Introduction 7, 77
  - IP 13, 16, 17, 19, 23, 25, 28, 31, 33, 36, 37, 41, 42, 44, 47, 54, 58, 59, 62, 63, 66, 70, 74, 76, 77, 79
    - back 20, 34
    - defines 71
    - install 14
    - match 35
    - power 21
    - Select 67
    - start 57
    - use 7
  - IP address 14, 19, 23, 25, 28, 33, 34, 35, 37, 41, 42, 47, 62, 70, 71, 74, 77, 79
  - ip address 192.168.202.201 255.255.255.0 47
  - IP Address and/or MAC Address 33
  - IP Address LAN2 47
  - IP Gateway 70
  - IP Mask 35, 47
  - IP Mask LAN1 47
  - IP Mask LAN2 47
  - IP Office 7, 13, 14, 16, 17, 19, 21, 23, 25, 28, 31, 33, 35, 36, 37, 41, 42, 44, 47, 58, 59, 63, 67, 70, 71, 77, 79
  - IP Office Administration CD 28
  - IP Office Administrator 23, 44
  - IP Office Administrator Applications CD 23
  - IP Office Documentation CD 77
  - IP Office Embedded Voicemail 23
  - IP Office Engineers 77
  - IP Office Engineers Toolkit 77
  - IP Office IP Endpoint 7
  - IP Office LAN 77
  - IP Office Licensing 44
  - IP Office Manager 7, 13, 14, 23, 31, 33, 36, 37, 42, 44, 59, 63, 79
  - IP Office Manager application 7, 13, 14, 23
  - IP Office Manager PC 14
  - IP Office Manager System 37
  - IP Office Monitor application 28, 41
  - IP Office supports 7
    - DiffServ 19
  - IP Office System 7, 13, 16, 17, 25, 41, 44, 58, 67
  - IP Office Unit 7, 13, 14, 17, 19, 23, 25, 28, 35, 41, 42, 70, 71
  - IP Office Unit configuration 14
  - IP Office Unit Memory Card 23
  - IP Office Unit's LAN1 71
  - IP Office's configuration 44
  - IP Office's data 17
  - IP Office's LAN1 23, 28
  - IP Office's TDM 17
  - IP phone 7, 13, 14, 20, 21, 23, 28, 33, 34, 37, 44, 47, 54, 57, 59, 66, 67, 70, 71, 74, 77, 79
    - extension number 42
  - IP Phone Inline Adaptor 21
  - IP Phone Software 7, 23, 28
  - IP Phone Software Version 7
  - IP Softphone Fails To Register With 44
  - IP Telephone 14, 44, 70, 76
  - IP Telephone LAN Administrator's Guide 70, 76
  - IP Telephone R2.3 LAN Administrator Guide 44
  - IP Telephone Software 14
  - IP Telephones Administrators Guide 44
  - IP400 44
  - IP403 7, 17
  - IP406 7, 17, 23, 25, 28
  - IP406 V1 7, 17
  - IP406 V2 7, 17, 23, 25, 28
  - IP412 7, 17
  - IPO 44, 47
  - IPO LIC 44
  - IPSec VPN 44
  - IPSets Firmware 23
  - IPSets Firmware/4601dbtel1\_82.bin 25
  - IR 55, 66, 67, 68
    - display 67
    - PC/Handheld 67
  - IR beaming 66
  - IR Interface Enable/Disable 55
  - IR port 55, 66, 67, 68
  - IR port ready 68
  - IrDA 66
  - ISG 44
- J**
- J8164A Configuration Editor 47
  - Java 44
  - jpg 77
  - JRE 44
  - Juniper Networks Integrated Security Gateway 44
  - Juniper Networks NetScreen 44
  - Juniper Networks NetScreen Series VPN 44
  - Juniper Networks Secure Services Gateway 500 Series 44
  - Juniper Secure Services Gateway using Policy-Based 44
- K**
- Kentrox Q2300 VPN Router 44
- L**
- L2 47, 55

---

L2 QOS 47  
L2 signaling 55  
L2Q 47  
L2QVLAN 47  
L3 55  
L3 signaling 55  
LAN 19, 20, 21, 42, 44, 47, 55, 56, 62, 70, 76, 77  
    Connect 34  
    match 79  
    PC 14  
LAN Administrator's Guide 70, 76  
LAN Cables 14, 20, 21, 34, 79  
LAN PC's 77  
LAN Socket 14, 55  
LAN1 25, 28, 35, 47, 71  
LAN2 47  
LAN's DHCP 62  
Leave Manager 28  
LED 21  
    waiting 57  
Licence Keys 14  
license key 14  
LINE 21, 34  
lines 41, 44, 62, 63, 77, 79, 80  
    46xxupgrade.scr file 31  
    Monitor 28  
Listing  
    Registered 41  
Loading 62, 63  
Loading... 34  
login 37  
Login Code 36, 37  
**M**  
M505 67, 68  
MAC 37, 44, 56  
MAC Address 37, 44, 56  
Maintenance Manual 7  
manage  
    VLAN's 47  
Manager 13, 23, 25, 28, 31, 33, 35, 37, 44, 70, 71, 79, 80  
    during 14  
Manager application 13, 23, 28, 31, 35  
    Open 79  
Manager Installation 7, 14  
Manager PC 25, 28, 79  
Manager PC's  
    back 25  
Manager's TFTP Log 28  
Mandatory 16, 55  
Manually Creating Extensions 33  
match 19, 33, 37, 59, 63  
    IP 35  
    LAN 79  
    RJ45 21  
May 2007 7  
Mbps 62  
MCIPADD 47, 71  
MCPOR 47, 71  
Menu icon 67, 68  
MESSAGES button 36  
MESSAGES button flashing 0.5 36  
MG 7  
Microsoft 44, 74, 80  
    Refer 71  
Microsoft DHCP 74  
Microsoft IIS Web Server 80

Microsoft Internet Information Server 80  
Microsoft Windows 2000/server 80  
Microsoft Windows NT 80  
Microsoft Windows XP 80  
Mid-Span Power Unit 21  
MIME 80  
    set 77  
Minimum Assessment Target 16  
Minimum Firmware 44  
MMC 80  
Mode option 47  
Mode option MUST 47  
Monitor 16  
    lines 28  
multicast 19  
Multicasting 19  
Multihomed 47  
MultiVantage 70  
**N**  
Name 14, 20, 23, 28, 33, 37, 41, 44, 47, 56, 63, 67, 71, 74,  
77, 79, 81  
Name Details 28  
nasystem/h323\_ras\_list yyyyyyyy.txt 41  
Native 47  
Netgear FVS338 VPN Router 44  
Network Access 19  
network assessment 7, 16  
New 19, 28, 33, 35, 36, 37, 47, 54, 55, 59, 62, 63, 71, 77,  
80  
New Type 80  
New,2702,192.168.42.200,1720 41  
Next 63, 71  
NIC Cards 47  
No Ethernet 34, 42, 62  
No new 55  
Non-Avaya 25, 44  
Non-Avaya Gateways 44  
non-IP 17, 36  
    number 7  
non-IP extension 36  
non-VoIP extension 33  
Notepad 77, 79, 80  
NT 4.0 80  
Number 14, 17, 20, 21, 28, 33, 35, 36, 37, 44, 54, 56, 59,  
62, 63, 67, 68, 71, 76, 77  
    Avaya 7  
    H.323 IP 7  
    non-IP 7  
    Start 66  
    VCM 7  
**O**  
OK 25, 33, 37, 44, 59, 71, 80  
on/off 36, 60  
on the phone button 67  
Open 19, 28, 37, 41, 80, 81  
    Manager application 79  
    PC's 77  
Open URL Entry 81  
operate 80  
Option 14, 21, 23, 31, 41, 42, 44, 47, 54, 55, 56, 59, 68,  
71, 74, 79, 80  
Option 15 74  
Option 176 74  
    requesting 71  
Option 66 74  
    attaching 71



- Option Settings 55
- options exist 14
- OR 79
- Other H.323 IP 7
- Overlapping VLAN 47
- P**
- p>Hello world!</p 77
- Packet Loss 16
- page coding 76
- Pages 76, 77, 79, 80, 81
- pages implementing 81
- Palm 67, 68
- Palm Organizer 67, 68
- Palm Vx 67, 68
- part 23, 31, 44, 71
  - Scope 74
- Password 36, 63, 77, 79
- PC 7, 23, 25, 35, 44, 47, 55, 62, 66, 67, 70, 77, 79
  - address 28
  - include 20
  - LAN 14
  - running 71
- PC Ethernet LAN 20
- PC Port 20
- PC Softphone 7
- PC/Handheld
  - lr 67
- PC/personal 66
- PC's 47
- PC1 47
- PCs 47
- PC's 20
  - Open 77
- PC's web 77
- phone 7, 13, 14, 16, 17, 19, 20, 23, 28, 33, 35, 37, 42, 44, 47, 54, 55, 56, 57, 58, 59, 60, 62, 63, 67, 68, 70, 71, 74, 76, 77, 79
  - 46xxupgrade.scr file instruct 31
  - connection 34
  - dialling 67
  - GEN 21
  - infrared dialling 66
  - registration 36, 41
  - security 37
- Phone Connection 34
- phone displays 36, 63, 79
  - file 63
- phone during installation 14, 28, 70
- Phone Manager 7
- Phone Manager Pro PC Softphone 7
- phone obtains 62
- phone requests 31, 44, 79
  - extension 63
- phone requires 14
- phone returns 55, 57
- Phone Security 33, 37
- Phone SN 56
- PHONE/EXIT 79
- phone's Differential 55
- phone's Differential Services 55
- phone's IP Mask 35
- phones look 13
- phones need 71, 76
- Phones share 47
- PHY2 55, 67
- Pocket PC 67
- PoE 21
- PoE input 21
- Potential Problems 19
- Potential VoIP Problems 19
- power 14, 19, 20, 34, 36, 42, 62
  - Ethernet 21
  - IP 21
- power conditioning 19
- power over ethernet 20, 21
- Power over Ethernet Options 21
- power supply 14, 19, 21, 34
- Power Supply Conditioning 19
- Power Supply Options 21
- Power Supply Unit 14, 21, 34
- Predefined 71
- Pre-Deployment 44
- Preferences 28
- Prefs 67
- preinstalled 28
- preparation 28, 63
- Preshared Key 44
- Press Web 79
- Print 37, 41, 56
- Printed Wiring Board 56
- Printed Wiring Board Serial Number 56
- prioritisation 47
- prioritization 19
- Product Section 44
- Program 14, 23, 35, 71, 77, 79
- Program Files/Avaya/IP Office/Manager 79
- Program Files/Avaya/IP Office/Toolkit/Data/Common/WML/samples 77
- Properties 77, 80
- Protection 19
- Protocol timeout 42
- provide switching 20
- provides 14, 16, 17, 19, 20, 23, 31, 44, 47, 77, 81
  - Catalyst 21
  - H.323 IP 13
  - RJ45 21
- Proxy 79
- PSK 44
- PSU 21
- PSU requires
  - 90 21
- PWB comcode
  - Shows 56
- PWB SN 56
- Q**
- QoS 19, 55
- QoS Option Settings 55
- Quality 7, 16, 19
  - form 19
  - Service 55
- R**
- RAM 62, 63
- RAS 41, 71
- RAS users 41
- Reboot 25, 33, 37, 59, 63, 71, 79
  - Restarting following 42
- Reboot Mode 59
  - Set 33, 37
- Reception">Call Reception</a 77
- Red 34, 47
- refer 7, 21, 44, 47, 66, 77

---

- refer 7, 21, 44, 47, 66, 77
  - 4600 Series IP Telephone LAN Administrator's Guide 76
  - Microsoft 71
- Registered 44, 71
  - Listing 41
- registration 36, 63, 71
- relating
  - 4620 79
- Release 2.0 Administrator Guide 44
- Release 4.3 Administration Guide 44
- repost 47
- requesting
  - Option 176 71
- Reset System Values 58
- reset sytem values 58
- Resetting 58
- restart 13, 23, 36, 42, 47, 58, 62, 63, 67, 79, 80
- Restart Scenarios 62
- Restarting following
  - reboot 42
- Restarting... 62
- RFA Name 44
- RFC2474 19
- RJ45 14
  - matching 21
  - provides 21
- RJ45 Ethernet LAN 14
- RJ45 LAN 14
- Run 7, 13, 14, 19, 21, 23, 25, 28, 35, 41, 42, 44, 70, 77, 79, 80
  - PC 71
- S**
- Sample 79, 81
  - Installing 77
- SAP Code 44
- Save 35, 42, 44, 55, 59, 63, 77, 79, 80
- savilltech.com 71
- Scope 47, 70
  - Activate 71
  - Creating 71
  - part 74
- Scope Options 47, 71
- scr 79
- scr extension 79
- Screen OS 5.1.0 44
- script file 42, 54, 62, 63
- Secondary Ethernet 55
- see 13, 14, 16, 28, 31, 33, 34, 35, 36, 41, 54, 55, 58, 60, 71, 77, 79
  - 4600 Series IP Telephone LAN Administrator's Guide 70
- select 25, 33, 36, 37, 41, 44, 47, 59, 68, 71, 77, 79, 80
  - IP 67
  - System 28
- Select Add 71
- select All Tasks 71
- Select File 28, 79
- Select Immediate 59
- Select No 71
- Select Start 25, 41, 71, 80
- Select View 28, 79
- Select Yes 71
- Self Installer 44
- self test 57
- Self-Test Procedure 57
- sendable 68
- Serial Number 56
- Series 7, 21, 31, 42, 44, 47, 70, 76
- Series H.323 IP phones 42
- Series IP Phone 31
- Series phone 42
- Server 13, 23, 25, 42, 44, 47, 62, 70, 71, 74, 77, 79, 80
- Service 19, 23, 44, 71, 80
  - Quality 55
  - Type 19
- Services signaling 55
- Set 16, 23, 28, 31, 35, 36, 37, 42, 47, 54, 55, 56, 60, 66, 67, 68, 71, 74, 76, 79, 80
  - File Writer 25
  - MIME 77
  - Reboot Mode 33, 37
  - SSON 59
- SET DNSSRV 79
- SET DOMAIN 79
- SET L2Q 31
- SET SMBLIC 44
- SET WMLCODING ASCII 79
- SET WMLEXCEPT 111.222.333.444 79
- SET WMLHOME 79
- SET WMLPORT 8000 79
- SET WMLPROXY nj.proxy.avaya.com 79
- SETTINGS FOR AVAYA 4620 IP PHONE 79
- Setup 33, 37, 47, 58, 62, 67, 79, 80
- Several H.323 IP phones 66
- SG 44
- Shows 13, 19, 41, 47, 57, 67
  - PWB's comcode 56
- Simple 47, 76
  - Creating 77
- site specific option number 59
- Site Specific Settings 31
- Small Installation 13
- Small Office Edition 7, 14, 17, 19, 23, 25, 28
- snmp-server 47
- Spare Wire 21
- Spare Wire Power Options 21
- Speaker/Mute LED 57
- Specifically HP 47
- SSON
  - Setting 59
- Start 19, 25, 28, 35, 41, 44, 47, 62, 63, 71, 77, 80
  - 46XXsettings.scr file 79
  - IP 57
  - Number 66
- start installing 71
- Start Manager 79
- Start Notepad 77
- static address 7, 23, 28, 34, 42, 54, 56, 62
  - installation 35
- Static Administration Options 54
- Static IP 7, 14, 28
- Static IP Installation 7
- Step 34, 35, 62, 70
- stores 25, 36, 42, 63
- String
  - Verify 71
- Submit Button 81
- subnet 47, 70
  - called 35
  - Enter 71
- subnet mask 35, 70, 71

- support.avaya.com 44
- Supported 13, 14, 16, 17, 19, 21, 23, 25, 34, 35, 44, 47, 66, 68, 70, 74, 76, 77
  - 4622 7
- SV 7
- SW 20
- Swap Text Files During
  - Call 66
- Sysmon 41
- System 7, 14, 19, 21, 23, 25, 33, 37, 41, 42, 47, 54, 58, 59, 68, 70, 76, 79, 80
  - select 28
- System | System 23
- System Name 28
- System Overview 47
- system-specific 63
- System-specific registration 63
- T**
- Tag 47, 76, 81
- Tagged Packets 47
- Technical Tip No 44
- text/vnd.wap.wml 77, 80
- TFTP 13, 16, 35, 41, 42, 44, 47, 58, 62, 63, 70, 71, 74, 79
  - control unit memory card 25
  - installation 14
  - introduction 23
  - preparation 28
  - timeout waiting 23
- TFTP Error 42, 62
- TFTP Introduction 23
- TFTP Log 23, 28, 79
- TFTP Server 13, 14, 23, 25, 28, 35, 42, 44, 58, 62, 63, 70, 71, 74, 79
- TFTP Server Name 74
- TFTP Server Options 14
- TFTPDIR 71
- TFTPLog 28
- TFTPSRVR 47, 71
- These 7, 17, 21, 23, 34, 37, 41, 47, 54, 56, 66, 81
- These require
  - VPNremote 7
- Third-TFTP Software 23
- Timed Out 42, 62
- timeout 23
  - cause 42
- Timeout Error 42
- timeout waiting
  - TFTP 23
- Tomcat 44
- toolkit 77
- Tools 23, 31, 41, 67, 71, 80
- ToS 19
- Trial 44
- txt file 31
- Type 7, 13, 16, 17, 21, 25, 41, 47, 68, 71, 77, 80, 81
  - Service 19
- U**
- Under Services 71
- understanding
  - IEEE 802.2p/q 47
- unit's 47
- Unix 80
- Unrestricted 47
- Untagged 47
- upgrading
  - application file 63
  - boot file 63
- URL
  - user enters 81
- URQ 42
- US 56
  - use 13, 14, 19, 21, 25, 33, 36, 37, 41, 42, 44, 47, 54, 55, 56, 58, 62, 63, 66, 67, 70, 71, 77, 79
  - IP 7
  - VCM 17
- user 14, 19, 20, 28, 33, 36, 37, 41, 44, 47, 56, 60, 63, 77, 80, 81
  - user changes
    - extension 63
- User Details 14
  - user enters
    - URL 81
- User Name Details 28
- User PC Connection 20
- User Setup 37
  - user's Login Code 36, 37, 63
- Using 7, 17, 19, 21, 23, 28, 31, 36, 37, 41, 42, 44, 47, 54, 59, 62, 63, 66, 67, 68, 70, 71, 74, 77, 80
  - Control Unit Memory Card 25
- Using Manager 25
- Using Option 66 74
- Using Windows 2000 Server 71
- V**
- VCard 67, 68
  - VCard file 67
  - VCard phone 67
- vcf 67
- VCM 28
  - installing 17
  - number 7
  - use 17
- VCM 10 17
- VCM 16 17
- VCM 20 17
- VCM 24 17
- VCM 30 17
- VCM Channels 7, 17
- VCOMP 28
- Verify 42
  - String 71
- View 23, 28, 56, 76
- View Administrative Details 56
- VLAN 35, 47, 71
  - vlan 209 47
  - vlan 210 47
  - VLAN ID 35, 47
  - VLAN networking 47
  - VLAN Switch Configuration 47
  - VLAN's
    - manage 47
- VLANID 47
- VLANTEST 47, 71
- Voice 7, 14, 16, 17, 19, 20, 28, 47
  - voice compression 19, 28
    - channels 17
    - installation 14
- Voice Compression Channel Capacity 17
- Voice Compression Channels 17, 28
- Voice Compression Module 14, 28
  - voice signalling 19
  - voice traffic 16, 20, 47
  - voicemail 19, 25, 33

---

Voicemail Server PC 19  
VoIP 7, 14, 16, 19, 33, 36, 37, 44  
VPN 44  
VPN Devices 44  
VPN Phone Allowed 44  
VPN Phone Allowed checkbox option 44  
VPN Phone Unlimited 44  
VPN phones 44  
VPN Remote  
    Configuring 44  
VPN Remote Phones 44  
VPN Security Gateway 44  
VPN Security Gateway Device 44  
VPN Wizard 44  
VPNremote  
    46xx 44  
    These require 7  
VPNremote Phone 44  
VPNremote Phone Firmware 44  
VPNremote Phone License File 44  
VPNremote Phone Licenses 44  
VSU 44

**W**  
waiting  
    LED 57  
WAN 19  
WAN Ethernet  
    including 19  
WAP 76, 79  
    Web Server 77  
WAP browsing 76  
WAP browsing uses 77  
WAP MIME 77  
WAPFORUM//DTD WML 1.1//EN" 77  
WARNING 16, 35, 58, 59  
Watts 21  
wbmp 77  
Web 31, 44, 47, 77, 79, 80  
web browsing 31, 77  
Web Launch 79  
Web Server 79, 80  
    Installing 77  
    WAP 77  
web server needs 77  
Web Server PC 77  
WebLM 44  
WebLM server 44  
website 44  
When Free 33, 37, 59  
Windows 25, 31, 66, 70, 74, 77, 79, 80  
    2000 71  
    cmd 41  
    pocket PC 67  
Windows 2000/server 80  
Windows Notepad 31  
Windows NT 80  
Windows PC 77  
Windows Pocket PC 67  
Windows XP 80  
winnt/system32/inetsrv/iis 80  
WINS 70  
    Enter 71  
Wireless Access Protocol 76  
Wireless Markup Language 76  
Wireless Telephony Application Interface 76, 77  
Within Manager 28

WML 31, 76, 77, 79, 80, 81  
WML browsing 79  
WML Page 77  
wml pages 77  
WML Server Setup 76  
Wordpad 41, 77  
Worst Case 21  
wp/mc;200 77  
Wrong Set Type 36, 42  
WTAI 76, 77  
www.wapforum.org/DTD/wml\_1.2.xml 77

**X**

x10d01a2\_2.bin 23  
x20d01a2\_2.bin 23  
Xauth 44  
XAuth Enhanced Authentication 44  
Xitami 77  
Xitami.cfg 77  
Xitami.exe 77  
Xitami/webpages 77  
Xitami/webpages/4620 77  
xml 77  
xx.xxx.xxx.xxx 71  
xxx.xxx.xxx.xxx 41  
xxx.xxx.xxx.xxx,MCPORT 71

**Y**

yyy.yyy.yyy.yyy 71  
yyy.yyy.yyy.yyy,TFTPDIR 71  
yyyyyyy.txt 41



Performance figures and data quoted in this document are typical, and must be specifically confirmed in writing by Avaya before they become applicable to any particular order or contract. The company reserves the right to make alterations or amendments to the detailed specifications at its discretion. The publication of information in this document does not imply freedom from patent or other protective rights of Avaya or others.

All trademarks identified by the ® or ™ are registered trademarks or trademarks, respectively, of Avaya Inc. All other trademarks are the property of their respective owners.

This document contains proprietary information of Avaya and is not to be disclosed or used except in accordance with applicable agreements.

© 2010 Avaya Inc. All rights reserved.