

ARGUS QC-3195B USER MANUAL

Package Contents:

Argus QC-3195 3.2MP Digital Camera

Battery Charger with 4 Rechargeable
AAA Batteries

Camera Pouch

Mini Tripod

Cleaning Cloth

Driver and Software CD

Table of Contents

Safety and General Information.....	2
Getting to Know Your Camera.....	4
Camera Setup.....	6
Driver Installation.....	12
Specifications.....	18
Troubleshooting.....	18
Battery Charger.....	20

Safety and General Information

Thank you for purchasing the Argus QC-3195B. We hope that you enjoy this camera for years of trouble-free operation. Please read this manual carefully before using the camera and follow the instructions to avoid any damage that could be caused by improper operation.

Caution

The software CD-ROM packaged with the camera is designed to be used with a personal computer only. Do not attempt to play this CD-ROM on a stereo or CD player as this may cause damage to both the disc and the CD player.

This camera is a precision electronic device. Do not attempt to service this camera yourself. Opening or removing the cover may expose you to dangerous voltages or other risks. Further, avoid exposing this camera to direct sunlight as doing so could cause a fire.

Before Using Your Camera

Use your camera to shoot several trial images before taking pictures of important subjects to ensure proper operation. Any loss caused by the malfunction of this

product (such as costs of photography or loss of benefit generated by the photography) is not the responsibility of Argus Camera Company and no compensation will be given for it.

Copyright Information

Unless agreed by the rightful owner, pictures taken with this digital camera cannot be used in violation of copyright law. Moreover, when there is a “No Photography” restriction in place, you cannot record any performance, improvisation, or exhibit even for personal use. Any transfer of pictures or memory cards with data must be conducted under the constraints of copyright law.

Caution When Using the Camera

This product consists of intricate electrical parts. To ensure that the camera photographs normally, do not drop or hit the camera when taking pictures. Avoid using or placing the camera in the following locations:

1. Damp and dusty places.
2. Sealed vehicles or other places exposed to direct sunlight or subject to extreme temperatures.
3. Turbulent environments.

Do not open the battery cover when the power is on as this may cause a loss of images.

If the camera has gotten wet, immediately turn the power OFF and remove the batteries. Do not attempt to dry it with an external heat source.

How to Maintain Your Camera

1. If the lens, LCD display, or viewfinder is dirty, please use the accompanying cleaning cloth to wipe the surface clean. Avoid touching these areas with your fingers.
2. When not in use, keep the camera in its carrying case, otherwise you risk scratching the lens, LCD display, or viewfinder.
3. Do not use soap, detergent, or other solution to clean the camera; use a clean, soft cloth only.

Getting to know Your Camera

Camera Components Guide

- | | |
|-------------------|-----------------------------|
| 1. Flash | 11. Battery/Card slot cover |
| 2. Self-timer LED | 12. Up button |
| 3. Lens | 13. Right button |
| 4. Viewfinder | 14. Menu button |
| 5. USB | 15. Down button |
| 6. Tripod mount | 16. Flash button |
| 7. Flash LED | 17. Playback button |
| 8. Shutter button | 18. Display button |
| 9. ON/OFF button | 19. Left button |
| 10. Strap bar | 20. LCD screen |

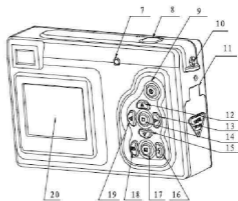
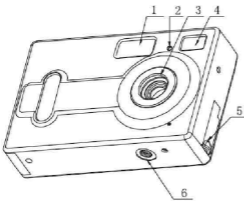

LCD display

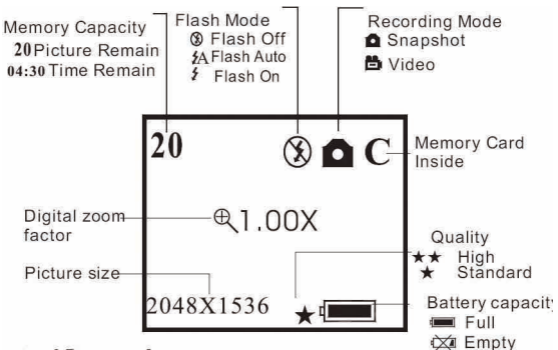

Prepare Your Camera for Use

Load Batteries and Memory Card

Open the battery cover and insert three of the included AAA rechargeable batteries or three new alkaline batteries according to the polarity indicated on the battery door, then insert the memory card and close the cover.

When the battery power is low, an icon will appear on the screen. You will need to select what kind of battery you are using. If you use alkaline batteries, you should select 1 and the battery capacity icon will display half full indicating that you will not be able to use the flash but you will still be able to take pictures until the icon displays empty; If you are using rechargeable batteries, select 2 and the battery capacity icon will display full indicating that you can take pictures until the icon shows that the battery capacity is empty.

Turning the Camera ON/OFF

To turn the camera on, press the ON/OFF button for 2 to 3 seconds until the operation LED is lit. To turn off the camera, press the ON/OFF button for 2 seconds. The camera will also power off automatically after 30 seconds of inactivity if not connected to the computer via the USB cable. The auto power off time can be manually set as described in the Auto Power Off section of this manual.

Camera Setup

Taking Pictures and Recording Options

Image Capture

Pressing the menu button will enter the capture select menu. Press the UP or DOWN button to select the desired capture mode, then press menu button to confirm.

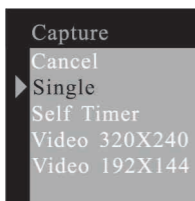

Color Options

From the Image Capture menu, press the RIGHT button to enter the Color Options menu. Press the UP or DOWN button to select the item that you wish to adjust and the menu button to enter the selected item.

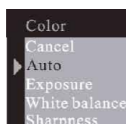

Adjusting Exposure Value:



Selecting the desired White Balance:



Adjusting the Sharpness:



Resolution

Press the UP or DOWN button to select the desired resolution and press the menu button to confirm.

Super: 2304X1728
High: 2048X1536
Middle: 1600X1200
Low: 1280X1024

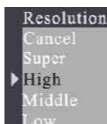

Quality

Press the UP or DOWN button to select the preferred quality level and press the menu button to confirm.



Auto Power-Off Time

Press the DOWN button to set the Auto Power-Off Time.



Set the Date and Time

Press the DOWN button to set date and time.

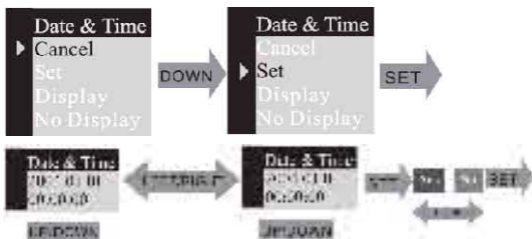

If DISPLAY is selected, the date & time will show on the captured images. If you do not want the date and time on the pictures, select NO DISPLAY.

Set Frequency

Changing the frequency may help to reduce flicker if you use fluorescent lights.

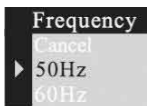

Language

Press the UP or DOWN button to select the desired language and press the menu button to confirm.



Playback

Pressing the PLAYBACK button will put the camera in preview mode.

Erase, Format, and Protect

While viewing an image, you can press the menu button to enter the erase menu. From this menu, press the UP or DOWN button to select erase “One” frame or “All.” Selecting “All” will erase all images currently stored in memory or on the SD/MMC card. Press the main button to confirm file deletion.

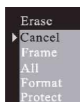

Selecting the format mode will format the memory card inside camera. Formatting the memory card will erase all images stored on it.



Selecting the protected mode will protect the frame selected from deletion.

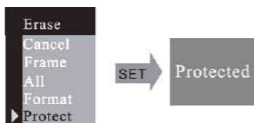

If you want unprotect an image, select go to the protected picture, enter “Erase” mode as previously described, and select “Unprotect” by pressing the right button and pressing the menu button to confirm.



DPOF (Digital Print Order Format)

By using DPOF, you can select an image for printing and set the quantity that you want to print.

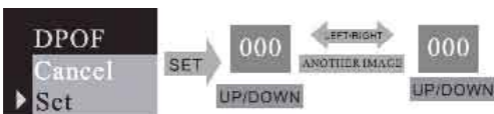

Rotation

Press UP or DOWN button to select the rotation angle, and menu button to enter the selected angle.

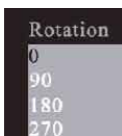

ZOOM/PAN

In picture preview mode, you can ZOOM in on an image and use the PAN function to move the display range of the image. After entering the ZOOM / PAN menu, press the DOWN button to enter PAN mode and the menu button to confirm. Press the UP, DOWN, LEFT, and RIGHT buttons to view the entire display

range of the picture. To cancel the PAN function, press the MENU button followed by the DOWN button to Cancel.



Using Your Digital Camera

Taking Pictures

To take a picture, frame your subject in either the LCD display or the viewfinder and press the shutter button. You will here a beeping sound to indicate that the snapshot is finished. Simultaneously, the number of available images on the LCD display will decrease by one.

Use the Self-Timer

To include yourself in a captured image, you can set this camera to pause 10 seconds before taking a picture. To enter the SELF-TIMER mode, press the menu button and select SELF-TIMER, then press the menu button to confirm. After you press the shutter button, the self-timer LED will blink for 10 seconds and then take a picture.

Record Video

Your digital camera can be used to take short video clips without sound. To enter video capture mode, press the menu button and change to the VIDEO mode. Press the menu button to confirm. After confirming VIDEO, press the shutter button to start recording video.

Use the Flash

By pressing the flash button, you will enter the FLASH menu. You can choose FLASH AUTO, ON, or OFF. Choosing flash AUTO or ON will cause the camera to charge the flash. While the flash is charging, the LCD display will be dark and the operation LED will blink. When the LED stops blinking and the LCD display

turns on, charging is completed and the flash is ready. The FLASH ON function will always use the flash, while the FLASH AUTO function will use the flash only when required by the camera.

Digital Zoom Feature

In the image/capture modes you can use the digital zoom feature which will allow you to take close-up images of your subject. While in capture mode, press the UP button to zoom in and the DOWN button to zoom out.

Playback

Pressing the Playback button enters Preview mode which will allow you to view all captured images one at a time. While in preview, you can press the DISPLAY button to change from one picture viewing to a display of nine images at a time. While viewing a single picture, pressing the UP or DOWN button will zoom in or zoom out the picture and pressing the LEFT/RIGHT buttons will change to the next or previous image. To play a video while viewing the nine picture screen, select the image with the directional buttons and then press the DISPLAY button.

Download Images to a Computer

Enter preview mode and connect the camera to the computer via the USB cable. You will not need to install a driver for image download if you use Windows 2000/ME/XP. Simply connect the camera to PC, the LCD screen will display "MSDC" and the camera will be recognized as a removable disk, allowing you can directly copy the pictures from the camera to your computer. *If you are using Windows 98SE, you must install the camera driver before attaching the camera to the computer.* To install the camera drivers, please refer to the section on Installing Drivers. After the driver is installed, connect the camera to PC in while in preview mode and the computer will find a USB mass storage device and install the device driver automatically. After this process is complete, the camera will be recognized as a removable disk and the pictures can be copied to the computer.

Driver Installation

Insert the accompanying CD into the CD-ROM drive and the install dialogue box will appear automatically (shown below)



Click on the OK button and then next screen will appear.

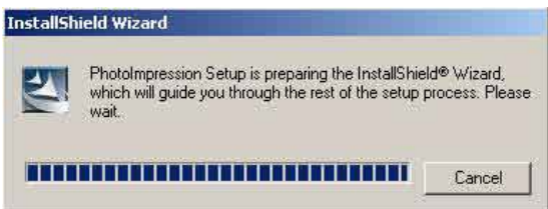

The Arcsoft PhotoImpression 5.0 Setup screen will appear.

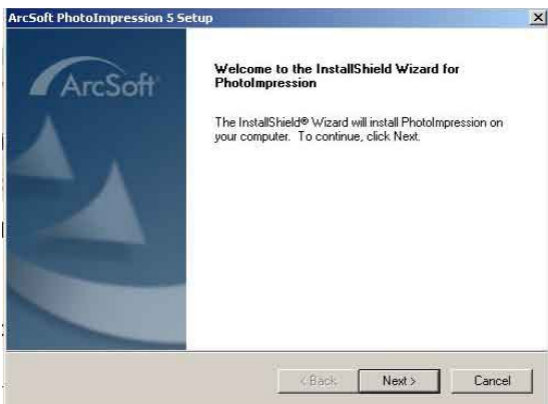

Click on the **NEXT** button to proceed to the next step.



Click on the **YES** button and the next screen will ask for the location where you want to save this program.

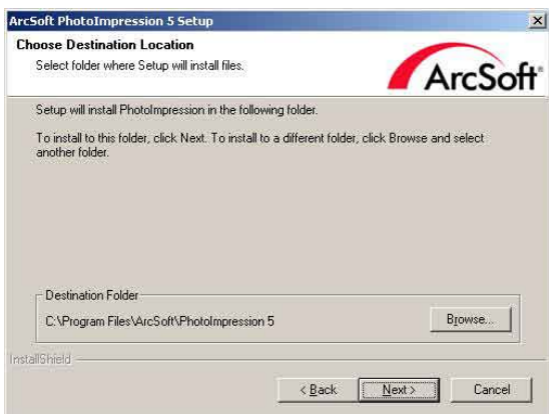

By default, this program will be saved within C:\Program Files\Arcsoft\PhotoImpression5. Click on the **Next** button to proceed.

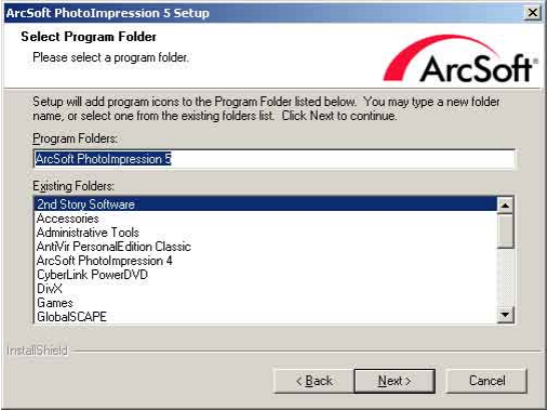

Continue to click on the **Next** button.

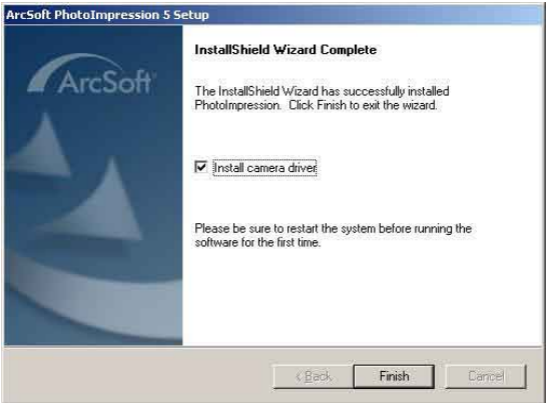

Once the installation is completed, click on **FINISH** and it will install the driver for the camera.

4-1 Installation of the Driver



Click on the NEXT button to proceed to the next step.



Click on the NEXT button.

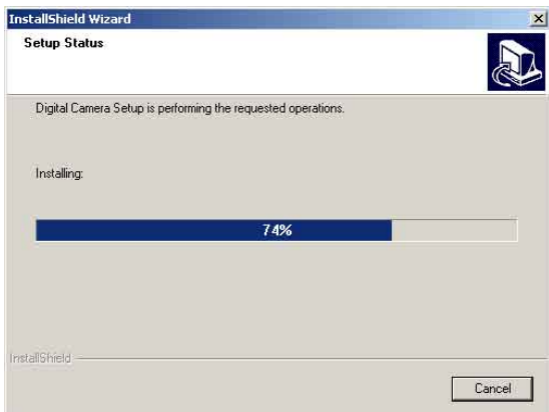

This screen shows the progress of the installation of the driver.



Click on the **Finish** button to complete the Driver installation for the camera.

Chapter 5: Specifications:

*3 in 1 mode:

Digital Still Camera mode: image Capture

PC Camera mode: video Capturing / Conferencing

Camcorder mode: Video clips

*Sensor: CMOS sensor, 3 Mega pixel

*Lens: F=3.0 f=8.35

*Focus Range: 1.5M to infinity

*Illumination: 100-16000(lux)

*Shutter Speed: Electronic shutter 1/20-1/6000 s

*Image Resolution:

Super (2304X1728)/High (2048X1536)/ Medium (1600X1200)/

Low (1280X1024) for image Capture

VGA (640X480)/QVGA (320X240) for PC camera mode

QVGA (320X240)/QCIF(192X144) for Video Recording mode

*Memory: Internal 16MB Flash

External SD and MMC card compatible

*Self Timer: 10 secs *ZOOM:8X Digital Zoom

*Color LCD screen: 1.5 inch TFT Display

*Flash mode: On/Auto/Off

*Battery: 3 AAA (alkaline/1.5V)

*Interface: USB 1.1

Minimum System Requirements

CPU: Pentium III 800MHz and higher

OS: Windows 98SE/2000/ME/XP

Memory: 128MB and higher

Disk Space: At least 250MB space free CD-ROM Drive

Troubleshooting

Camera will not turn on

Battery is not properly installed- remove and reinstall the batteries.

Insufficient battery voltage- Do not use old batteries or batteries with mixed battery life

Flash will not fire

Flash set to OFF -Set the flash to Auto or On. Flash has not been fully charged The flash takes a few seconds to charge up while the Operation LED is blinking. Flash light is fully charged when the Operation LED turns off.

Battery level is low - When the battery indicator does not show a fully charged battery, the voltage is too low for the flash to work. Please change batteries.

Image is blurred / out of focus

Subject is out of focal range. Ensure that there is at least 1.5m (5ft) between the camera lens and subject.

Camera moved during the shot- Hold the camera steady while taking the picture. When flash is on, hold the camera steady until flash has fired twice(The first flash is to reduce red-eye and to detect the brightness of the target.)

Computer does not recognize camera for Windows 98SE,

The camera driver has to be installed before picture download. In picture preview mode, ensure that USB mode is set to MSDC before connecting the camera to the computer. For Windows 2000/ ME /XP, the camera is recognized as a plug -&-playable, removable flash disk without driver installation under MSDC mode.

It is recommended that you disconnect your digital camera from your computer after use.

Subject in recorded image is too dark

Insufficient light for shooting Set the flash On, or adjust the exposure compensation to a positive (+) setting.

Flickering on lcd screen or recorded image

Incorrect frequency setting Check the correct anti-flicker frequency (50Hz or 60Hz) under fluorescent light setting.

Picture download problem

Flash disk does not display images recorded. The camera will load two removable flash drives on your computer under MSDC mode. The first drive is the external SD or MMC cartridge and the second drive is the recorded images saved in the built-in memory of the camera. In cases when the removable flash drive names coincide with those already assigned by the computer

in the network, you need to reassign the name for the removable flash disks:

Right click <My Computer> Manage Disk Management

Right click blue bar of removable disk which is on

line Change Drive Letter & Paths Change Assign the

Following Drive Letter (assign an unused drive name)

OK Open the new renamed removable flash drive to

download recorded pictures

GP[®] Nite-lite POWERBANK[®]

Instruction Manual

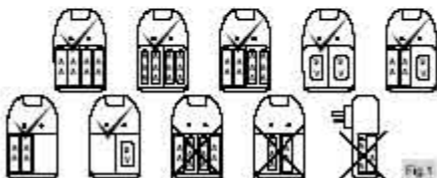

Operating Instructions:

1. GP PowerBank has 2 charging channels. It can charge 2 or 4 AA /AAA NiMH batteries and 1 or 2 9V NiMH batteries. AA /AAA and 9V batteries can be charged at the same time. (Fig.1)
2. Insert the batteries into the battery compartment with correct polarity and position. (Fig.1)
3. Directly plug GP PowerBank into its corresponding AC power outlet for charging.
4. The green LED indicators will light up when charging is in progress. The LED will remain on until GP PowerBank is disconnected from the outlet or the batteries are removed.
5. To ensure the batteries are fully charged, please refer to the charging time table.(Fig.2)
6. After the batteries are fully charged, either take the batteries out for use or leave them in the plugged-in GP PowerBank to keep them in

full condition.

7. It is always safe to continuously charge GP NiMH batteries with GP PowerBank because of low charging rate.
8. GP PowerBank is equipped with a night light function. The night light can operate individually or during batteries' charging. To turn on the night light, push the switch on the top of the charger to the right.(Fig.3)

Attention:

1. For new or long stored batteries, 2 to 3 times of charging and discharging are required to optimize the battery performance.
2. If the batteries are not used for a period of time, please recharge them before use.
3. Remove batteries from the electrical device if the device is not going to be used for a long time.
4. It is normal for batteries to become warm during charging.
5. Charging temperature : 0°C to 45°C Battery storage temperature : -20°C to 35°C

Caution:

1. Charge only NiMH AA, AAA and 9V rechargeable batteries. Charging other types of batteries (e.g. NiCd, Alkaline etc.) may lead to a burst, causing personal injury.
2. Do not mix new and used batteries, or use batteries of different brands or capacities at the same time.
3. Do not wet, incinerate or disassemble the charger and the batteries.
4. Do not short circuit the batteries.
5. For indoor and dry location use only. Do not expose the charger to rain, snow or extreme conditions.