

Telex

Operating Instructions



RadioCom™

BTR-1, TR-1

**Professional
Wireless
Intercom System**

TELEX®

Table of Contents

Section 1 Introduction	1-1
General Description	1-1
System Features	1-1
BTR-1 Block Diagram	1-3
TR-1 Block Diagram	1-4
Section 2 BTR-1 Base Station	2-1
Controls and Connections - Front Panel	2-1
Controls and Connections - Rear Panel	2-2
Section 3 TR-1 Beltpack	3-1
Controls and Connections - Top Panel	3-1
Controls and Connections - Rear Panel	3-2
Section 4 Specifications	4-1
BTR-1 Specifications	4-1
TR-1 Specifications	4-2
Section 5 Initial Equipment Set-Up	5-1
Unpacking	5-1
Rack Mounting	5-2
Rack Mounting a Single Base Station	5-2
Rack Mounting Two Base Stations Side-by-Side	5-2
Antenna Connection	5-3
Antenna Polarization	5-3
Distance Between Antennas	5-3
Antenna Placement	5-3
Section 6 BTR-1 Operation	6-1
Basic Operational Description	6-1
System Quick Start	6-1
Interfacing to the BTR-1	6-3
TX/RX Antennas	6-3
2W Intercom Ports	6-3
4W Intercom Ports	6-4
Auxiliary Port	6-4
CAN Bus	6-4
Relay	6-4
Local Headset	6-5
Powering the Base Station	6-5
Start-up	6-5
Status Screen	6-5
Encryption Code	6-6
System Settings	6-6
Name and Number	6-6
Base Main Settings	6-6
Intercom Type	6-7
Auxiliary Line	6-7
Base TX Power	6-7
Sidetone Levels	6-7
Frequency Settings	6-7
Intercom Settings	6-8
RF Meter	6-9
ClearScan	6-9
Special Button Functions	6-10

Table of Contents (continued)

Section 7 TR-1 Operation	7-1
Basic Operational Description.....	7-1
System Quick Start.....	7-1
Battery Installation.....	7-2
Transmit Modes (PT TALK, PT TX).....	7-3
Headset Connection.....	7-3
Sidetone.....	7-3
Antenna Connections.....	7-3
TR-1 Top Panel.....	7-4
On/Off Volume Control.....	7-4
BAT/O.M. Light.....	7-4
Talk button.....	7-4
A/B Selection Switch.....	7-4
C Pushbutton.....	7-4
Group and Channels.....	7-5
Transmit Frequency.....	7-5
Receiver Frequency.....	7-6
Battery Display.....	7-6
Microphone Gain.....	7-7
Transmit Power.....	7-7
Encryption Code.....	7-7
Serial Number Code.....	7-8
Auto Programing.....	7-8
Software/Channel Map Version.....	7-8
ClearScan.....	7-8
Lock Out.....	7-9
1st Use.....	7-9
Factory Reset.....	7-9
Section 8 TR-1 Menu Structure	8-1
Section 9 BTR-1 Menu Structure	9-1
Section 10 Frequency Bands	10-1
Section 11 Trouble Shooting	11-1
Section 12 Battery Information	12-1
Section 13 2-Wire Intercom Specifications	13-1
Section 14 FCC Information	14-1
Section 15 Software License	15-1
Section 16 Accessories and Replacement Parts	16-1

General Description

The Telex RadioCom™ BTR-1 UHF wireless intercom systems is the ultimate in reliable, high performance, encrypted full duplex communications.

The BTR-1 system includes the BTR-1 frequency agile base station and a TR-1 frequency agile beltack. The BTR-1 system provides full duplex, encrypted digital communication.

The base station provides the beltack with access to a six intercom port matrix of 2-wire systems or communication to a 4-wire intercom system. The system can interface with Audiocom® (Telex), RTS® TW, Clear-Com® 2-wire intercom systems as well as 4 wire communication systems.

In addition to the 2 and 4-wire intercom systems the base station provides connections for auxiliary balanced audio input and output, as well as relay closure and the ability for using one of the six intercom lines as a wireless only communication intercom. The system is also perfectly suited for stand-alone operation.

The BTR-1 has been designed for reliable, efficient operation. Operating in the 482 to 746 MHz range. The unit has expansion ability to add dozens of base stations to create a system. The high-efficiency beltack provides up to 9 hours of uninterrupted operation using standard alkaline batteries.

System Features

- Frequency agile base station and beltacks.
- No external computer/device required to select frequencies.
- Telex Communications proprietary digitally encrypted wireless communication between the base station and beltack.
- AC or DC operation in the 12 to 15 Volt range.
- Backlit base station LCD allows the user to easily monitor the beltack's status.
- The frequencies of a beltack may be changed at the beltack or from the base station.
- Beltack units contained in a weather and shock resistant die cast magnesium case.
- Six channels of 2-Wire intercom.
- Compatible with Audiocom® (Telex), RTS TW, Clear-Com®, RTS Matrix and other wired intercom types.
- Relay contact closure on the base station that can be activated from the beltack.
- ClearScan function to automatically find the best channels on which to operate.
- Base stations are table or rack mountable.

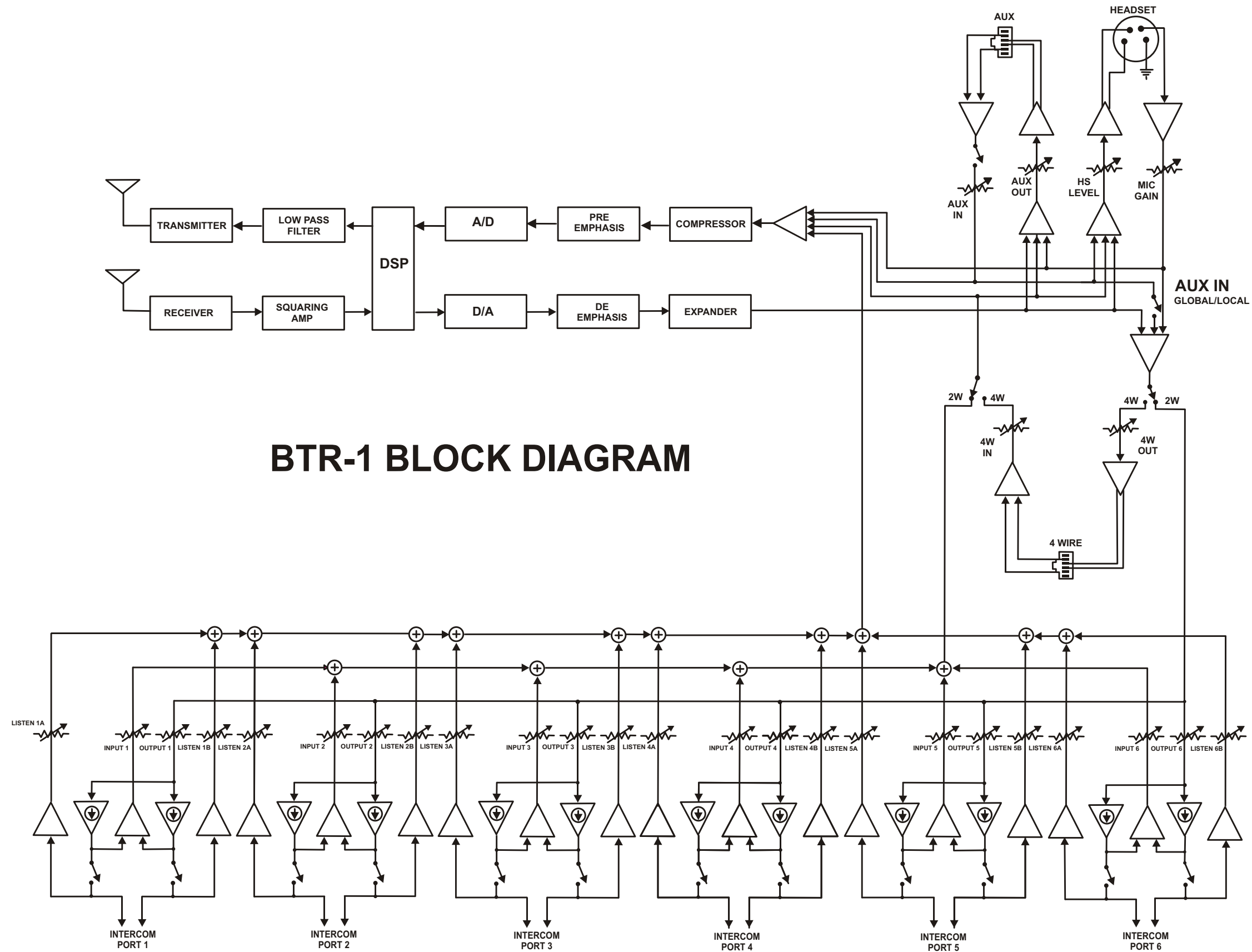

BTR-1 BLOCK DIAGRAM

Figure 1-1
BTR-1 Block Diagram

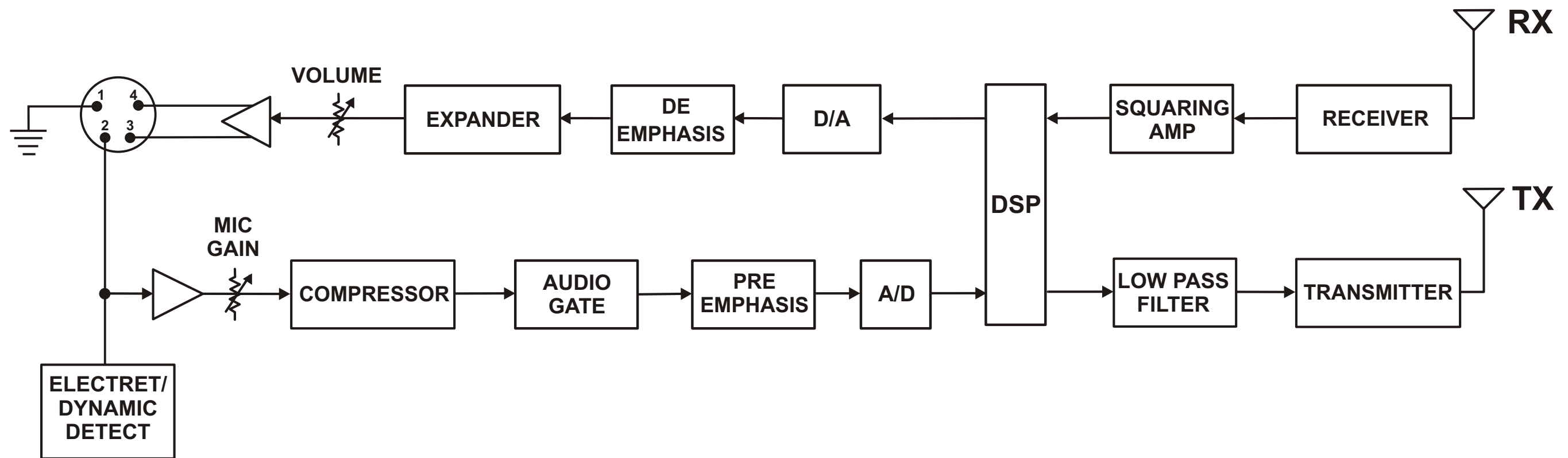

Figure 1-2
TR-1 Block Diagram

Section 2

BTR-1 Base Station

Controls and Connections - Front Panel

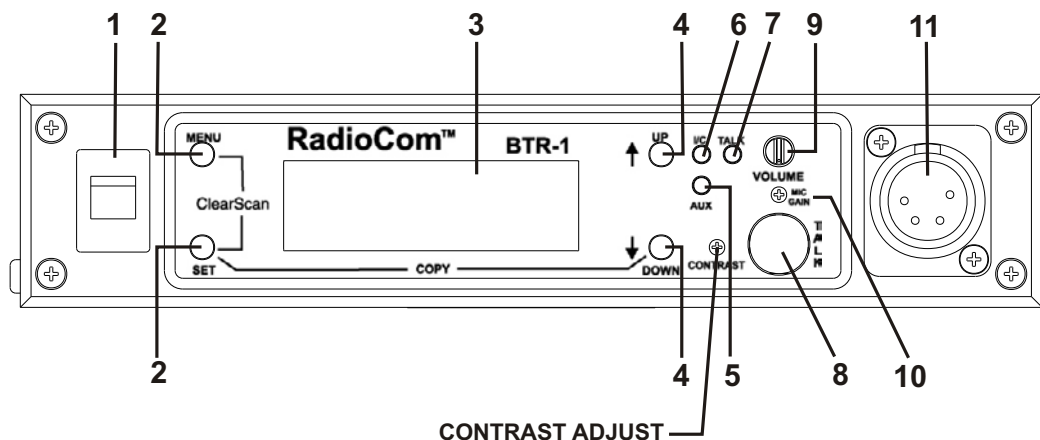
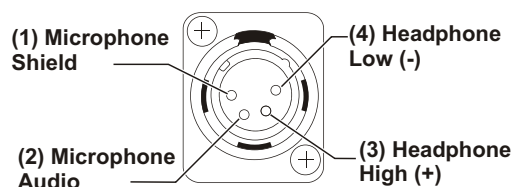

Figure 2-1
BTR-1 - Front Panel

1. **On/Off Switch:** Turns the base station on/off
2. **[Menu] and [Set] buttons:** Used to select menus and set options on the LCD.
3. **Backlit LCD w/Contrast Adjust:** Adjust the level of contrast to the LCD.
4. **[Up] and [Down] buttons:** Used to select menus and set options on the LCD.
5. **Peak Aux Level Light:** Will flash red when the auxiliary input level into the base station is too high.
6. **Peak Intercom Level Light:** Will flash red when the intercom input levels into the base station are too high.
7. **Talk Light:** Green when the talk button is active. Will turn red when the microphone level into local headset is high.
8. **Talk Button:** Press to enable the audio path from the headset.
9. **Headset Volume:** Used to adjust the volume level out to a headphone.
10. **Microphone Gain:** Adjusts the audio gain from the local headset microphone.

11. **Local Headset Connector:** Male XLR connector for Telex units, Female XLR connector for RTS units. A dynamic or electret headset microphone is automatically detected.

Telex Units



RTS Units

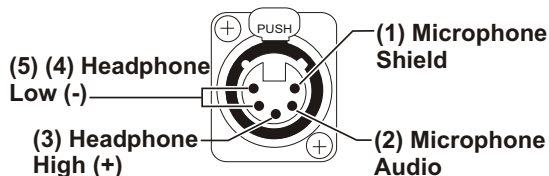
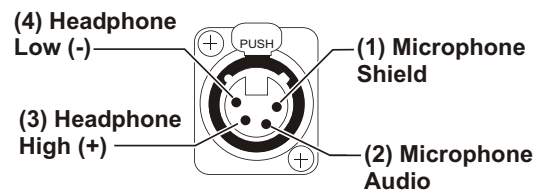

Figure 2-2
Local Headset Wiring

Controls and Connections - Rear Panel

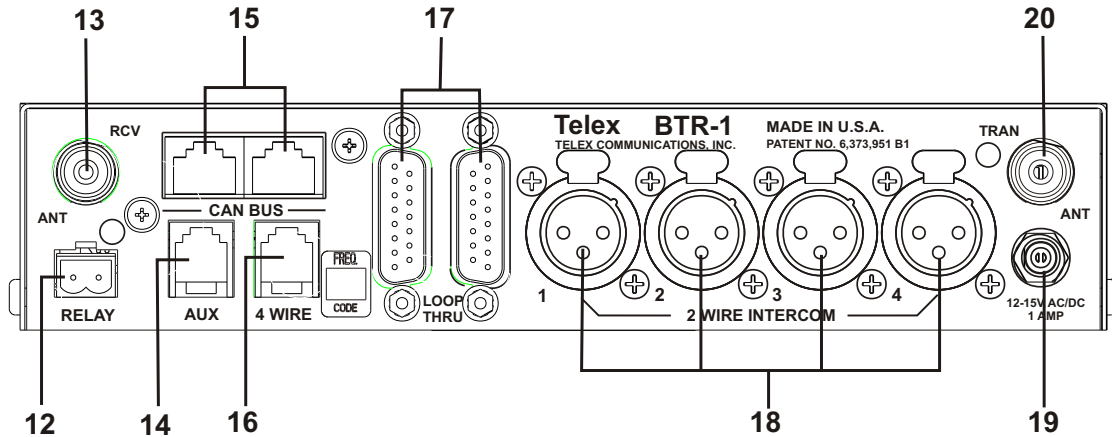

Figure 2-3
BTR-1 - Rear Panel

12. **Relay Contacts:** Normally Open. When activated it will close.
13. **Receive Antenna Connector:** TNC Female connector. The color dot near the connector must match the color of the antenna.
14. **Auxiliary Connector:** RJ-11 connector used to connect balanced auxiliary audio into and out of a base station.
15. **CAN Bus:** RJ-45 connectors used to connect a base station to a CAN type of communications bus.
16. **4 WIRE Connector:** RJ-11 connector used to connect balanced 4-W audio into and out of the base station.
17. **Intercom Loop Thru:** Two DB15 connectors used to loop 6 channels of intercom audio thru a base station.
18. **Intercom Jacks:** XLR intercom jacks to allow interfacing to the first four intercom ports via XLR connectors in addition to them being available at the DB15 connectors.
19. **Power Connector:** Input power jack that requires 12 to 15 Volts AC or DC at 1000 mA.
20. **Transmit Antenna Connector:** TNC Female connector. The color dot near the connector must match the color of the antenna.

Section 3

TR-1 Beltpack

Controls and Connections - Top Panel

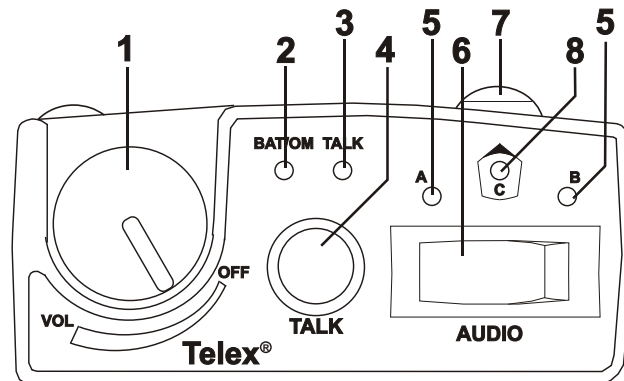

Figure 3-1
TR-1 Top Panel

- On/Off & Volume Control:** Turns the beltpack power on and controls headset volume.
- BAT/O.M. Light:**

Battery	Light flashes on power up	= Battery OK
	Light on continuously	= Battery Low
	Light does not flash or come on	= Battery Dead
Overmodulation	Light flashes on loudest speech	= Gain OK
	Light flashes on all speech	= Gain too high
	Light never flashes on loudest speech	= Gain too Low

- Talk Light:** LED is on when the talk button is active.
- Talk button:** Press to enable the audio path from the headset.

Selectable Modes: TALK	Push-to-Talk
	Push-to-Latch
	Off

- A and B Lights:** "A" light is on if selection switch in A position. "B" light is on if selection switch in B position.
- Selection Switch:** Switches between base station presets A or B.
- "C" Pushbutton:** Press to enable the base station "C" presets.

Selectable Modes: Button "C"	Momentary
	Latching
	Quarterback
	Off
	Push-to-Talk
	Latching Talk

- "C" Button Light:** "C" light is on if "C" pushbutton active.

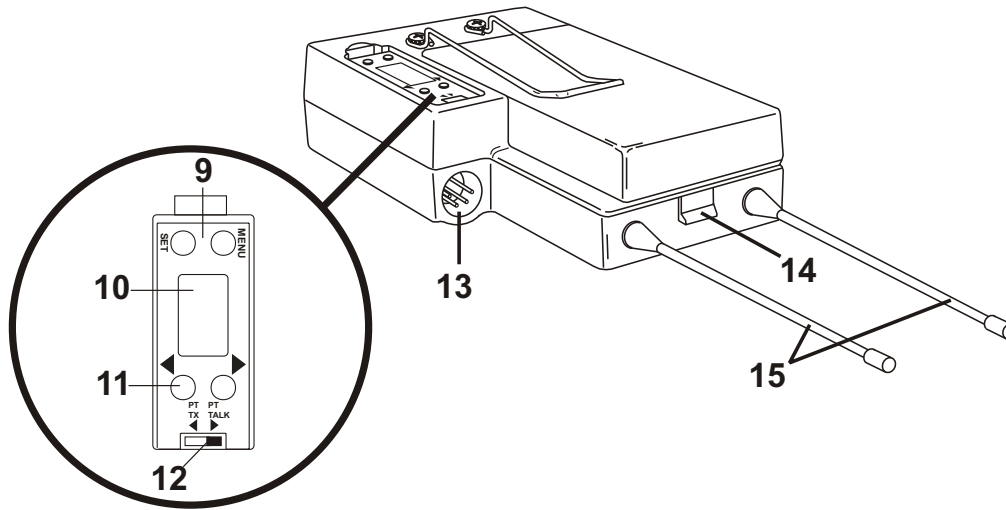

Controls and Connections - Rear Panel

Figure 3-2
TR-1 Rear Panel/Connector/Antennas

9. **[MENU] and [SET] buttons:** Used to select menus and set options on the LCD.
10. **LCD (Liquid Crystal Display)**
11. **[UP] and [DOWN] buttons:** Used to select beltpack options on the LCD.
12. **Push-to-Talk/Push-to-Transmit Switch:**
Push-to-Talk (PT TALK): The transmitter is always on. No audio is sent unless the talk button is active. Recommended position.

Push-to-Transmit (PT TX): The transmitter and audio paths are off except when the talk button is active.
13. **Headset Connector:** Male XLR connector for Telex units, Female XLR connector for RTS units.
14. **Battery Latch:** Press down to enable the battery pack to be released. While the latch is held down, slide the battery pack about 1/8 inch back, toward the latch, until it stops, then lift out.
15. **Receive and Transmit Antennas:** The antennas are screw type, 1/4 wave, replaceable antennas. The color dot on the screw end of the antenna must match color dot on antenna receptacle.

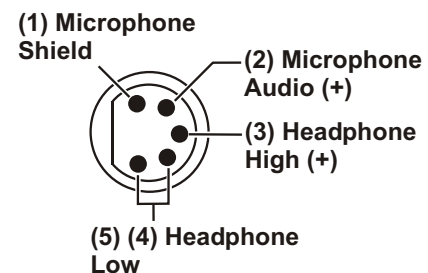
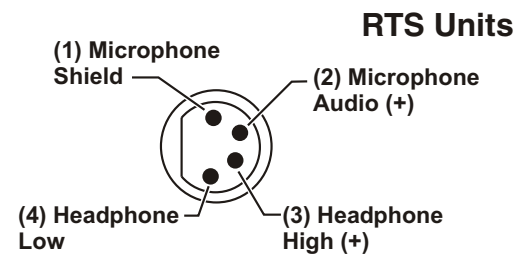
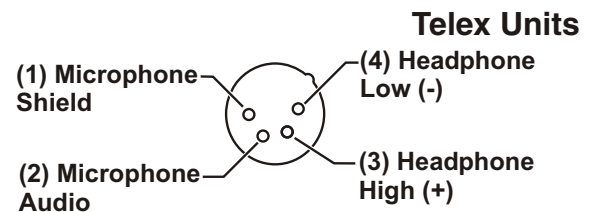

Figure 3-3
Headset Jack Wiring

**BTR-1
Specifications**

Overall

RF Frequency Range	482 - 608 MHz, 614 - 746 MHz in 18 MHz TX and RX bands
Power Requirements	12-15 Volts AC/DC @ 1 Amp
Temperature Range	-4° F to 130° F (-20° C to 55° C)
Dimensions	8.25" W x 1.72" H x 9.00" D (20.9 cm x 4.4 cm x 22.9 cm)
Weight	3 lbs 8 oz (1.59 kg)
TX Antenna	½ Wave (supplied), TNC Male Connector
RX Antenna	½ Wave (supplied), TNC Male Connector
FCC ID:	B5DM519
Frequency Response	100Hz-4.0kHz
Four Wire Input	Level Adjustable (2 Vrms typical)
Four Wire Output	Level Adjustable (2 Vrms typical)
Telex Intercom	Input/Output Level Adjustable (1 Vrms typical), Line impedance 300Ω
RTS Intercom	Input/Output Level Adjustable (0.775 Vrms typical), Line Impedance 200Ω
ClearCom® Intercom	Input/Output Level Adjustable (1 Vrms typical), Line Impedance 200Ω
Auxiliary Input	Level Adjustable (2 Vrms typical)
Auxiliary Output	Level Adjustable (2 Vrms typical into 600Ω)
Microphone input sensitivity	10mV (200 Source)
Local Headset Output	200mW output into 150Ω (1% Distortion)
Mute of Wire Income Port	100 dB (30kHz Low Pass Filtered)

Transmitter

Type	Synthesized Transmitter, 720 channels
Transmit Power	50mW typical (High), 5 mW typical (Normal)
Modulation Type	GMSK
Deviation	Complies with FCC 74.861
RF Frequency Stability	0.005%
Radiated Harmonics & Spurious	Exceeds FCC specifications

Receiver

Type	Dual Conversion Superheterodyne, 720 channels each
RF Sensitivity	<0.8 μV for 12 dB SINAD
IF Selectivity	3 dB at 230 kHz
Image Rejection	70 dB or better
RF Frequency Stability	0.005%
Distortion	<1% at peak level
S/N Ratio out to wired Intercom Ports	80 dB (30kHz Low Pass Filtered)

TR-1 Specifications

RF Frequency Range	482 - 608 MHz, 614-746 MHz in 18 MHz TX and RX bands
Power Requirements	6 "AA" Cells Alkaline (NiMH optional)
Current Draw	190 mA (Push-to-Talk, Talk On)
Temperature Range	-4° F to 130° F (-20° C to 55° C)
Dimensions	3.75"W x 5.10"H x 1.65" D (9.5 cm x 12.9 cm x 4.2 cm)
Weight	15 oz (425g) with alkaline batteries
TX Antenna	1/4 Wave (supplied), Screw type, Replaceable
RX Antenna	1/4 Wave (supplied), Screw type, Replaceable
FCC ID:	B5DM520
Frequency Response	100Hz-4.0kHz
Microphone input sensitivity	7 mV (200 Source)
Local Headset Output	200 mW output into 150Ω (1% distortion)

Transmitter

Type	Synthesized, 720 channels
Transmit Power	50 mW typical (High), 5 mW typical (Low), or auto-power switching
Modulation Type	GMSK
Deviation	Complies with FCC 74.861
RF Frequency Stability	0.005%
Radiated Harmonics & Spurious	Meets or exceeds FCC specifications

Receiver

Type	Dual Conversion Superheterodyne, Synthesized, 720 channels
RF Sensitivity	<0.8 μV for 12 dB SINAD
IF Selectivity	3 dB at 230 kHz
Image Rejection	70 dB or better
RF Frequency Stability	0.005%
Distortion	<1% at peak level
S/N Ratio in From wired Intercom Ports	80 dB (30kHz Low Pass Filtered)

Section 5

Initial Equipment Set-Up

Unpacking

Unpack your RadioCom™ system. Below are the items that should come with your base station and each belt pack. Contact the shipper or your dealer immediately if anything is damaged or missing.

BTR-1

Quantity	Description
1	BTR-1 Base Station
1	Operating Instructions
1	In-Line Power Supply
2	Antennas (one Transmit, one Receive)
1	Limited Warranty Sheet
4	Rubber Feet
1	Gain Adjust Plastic Screwdriver
1	Two Terminal Plug (for Relay)
2	Large Phillips Pan head Screw for Rack Mounting
2	Small Phillips Flathead Screw for rack Mounting
1	Single Unit Rack Mount Bracket
1	Dual Units (Side by Side) Middle Rack Mount Bracket
1	Rack Mount Side Bracket
1	Interconnect Cable (15 pin to 15 pin)

TR-1

Quantity	Description
1	TR-1 Beltpack with Antennas
1	Instruction Card
1	Battery Pack
1	Limited Warranty Sheet

Rack Mounting

The rack mounting brackets come with each BTR-1. These brackets may be used to mount a single base station in a 19" wide rack or mount two base stations side by side in a rack. Figure 5-1 shows the three brackets that come with a base station.

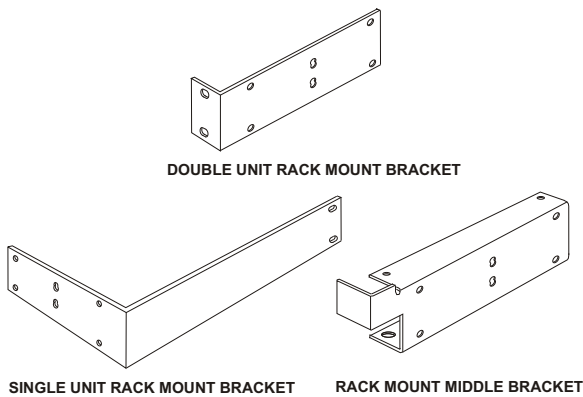

Figure 5-1
Rack Mount Brackets

Rack Mounting a Single Base Station

1. Remove the four pan head screws (two on each side) closest to the front panel.
2. Place the double unit side bracket on the side of the base station you wish closest to the edge of the rack.
3. Replace the two pan head screws and use a third pan head screw (2 supplied with base station) to screw into the upper middle location of the bracket.
4. Place the single unit rack mount bracket on the other side of the base station.
5. Replace the two pan head screws and the other pan head screw that came with the base to secure the bracket. Screw the third screw into the upper middle hole of the bracket.
6. Use the rack mount screws (not supplied) to secure the unit to the rack.

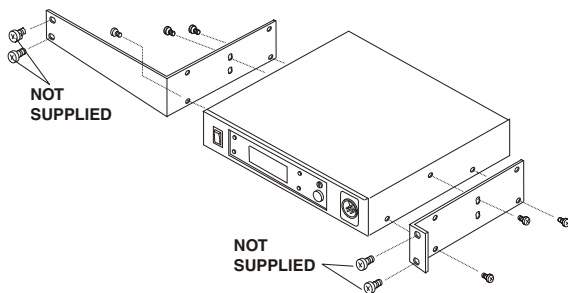

Figure 5-2
Rack Mounting of a Single Unit

Rack Mounting Two Base Stations Side-by-Side

1. Remove the four pan head screws (two on each side) closest to the front panel.
2. Place the double unit side brackets on the sides of the base stations you wish closest to the edge of the rack.
3. Replace the two pan head screws and use a third pan head screw (2 supplied with base station) to screw into the upper middle location of the rack mount middle bracket.
4. Place the dual bracket on the other sides of the base stations. Make sure the bracket is flipped so the front bend is toward the front of the base station. As you face the rack, the right base station will have the middle bracket front bend high and left base station will have the bend low.
5. Replace the two pan head screws and the other pan head screw into the upper middle hole of each bracket.
6. Use the four flat head screws (2 supplied with base station) to secure the top and bottom of the middle brackets together.
7. Use rack mount screws (not supplied) to secure the unit to the rack.

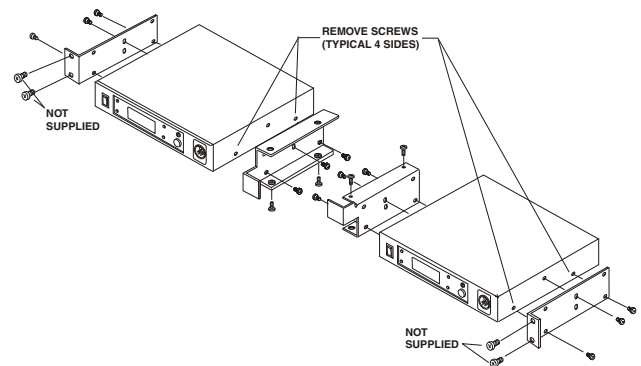

Figure 5-3
Rack Mounting Two Base Units Side-by-Side

Antenna Connection

The base station is supplied with two (2) antennas. One 1/2-wave antenna for Transmit and one 1/2-wave for Receive. The antennas have TNC male connectors.

The frequency range of the antennas should match the receiver and transmitter of the base station. Match the color code on the antenna with the color code on the base station.

Attach the transmit 1/2-wave antenna to the antenna input receptacle labeled “TRAN” on the right side of the rear panel. The antenna should be vertically aligned.

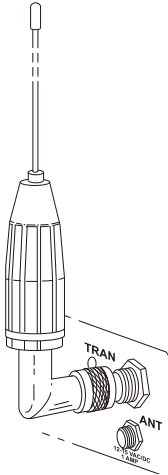

Figure 5-4
Attaching Transmit 1/2-Wave Antenna

Attach the receive 1/2-wave antenna to the antenna input receptacle labeled “RCV” on the left side of the rear panel. The antenna should be vertically aligned.

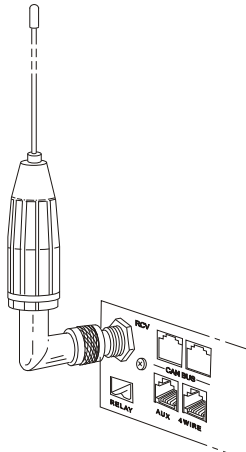

Figure 5-5
Attaching Receive 1/2-Wave Antenna

Antenna Polarization

The Telex Wireless Intercom System is “Vertically Polarized”. This means both the transmitting and receiving antennas should operate in the vertical position.

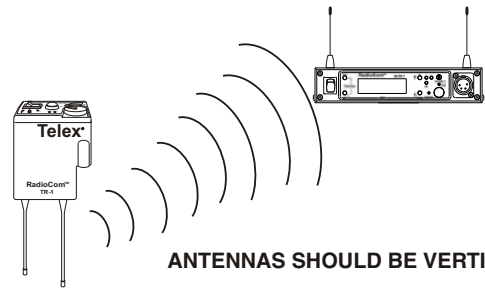

Figure 5-6
Vertically Polarized Antennas

Distance between Antennas

The distance between the base station’s receive and transmit antennas is not adjustable when the antennas are connected directly on the back of the unit.

The antennas can be remoted for better signal path. A Telex coax assembly with remote antennas may be required. See “Accessory and Replacement Parts” section for ordering information.

NOTE: If your base station is to be located in a shielded rack mount enclosure or other poor RF location, you must remote the 1/2-wave antennas with coax assemblies. See “Accessories and Replacement Parts” section for remote mounting hardware.

Antenna Placement

Proper antenna placement probably has the most effect on your TELEX Wireless Intercom System’s overall performance. The following suggestions will result in optimum performance.

Proper placement of the belt pack can be critical. The antennas should be in the open. Bending the antennas up and placing the belt pack in a pocket, etc., will reduce system distance.

It is suggested that the unit be worn on the belt or pocket with both antenna’s vertical for best operating range and performance.

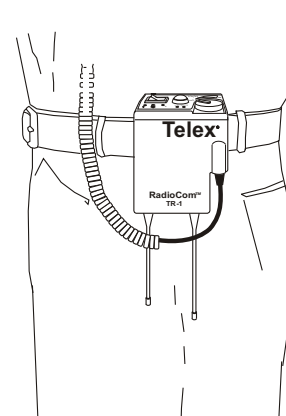

Figure 5-7
Proper Dressing of the Antennas

Keep the distance between the base station and the beltacks as short as possible. The greater the distance, the weaker the signal. Make sure the “signal paths” between the base station and beltacks are unobstructed. You should be able to visibly locate the base station antennas at all times for best performance.

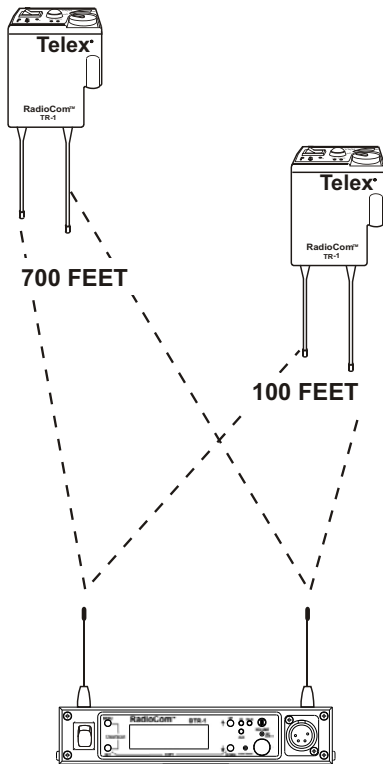

Figure 5-8
Distance Between base station and beltack

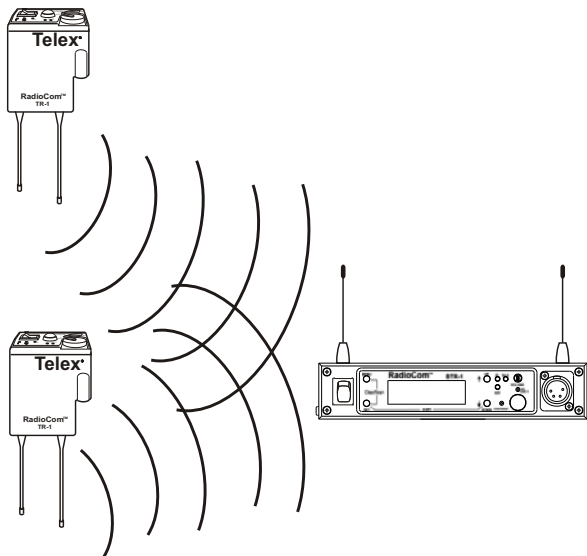

Figure 5-9
Keeping Site Clear to Antennas

Attempting to operate the wireless intercom system through or around walls, ceilings, metal objects, etc. will reduce system range and performance.

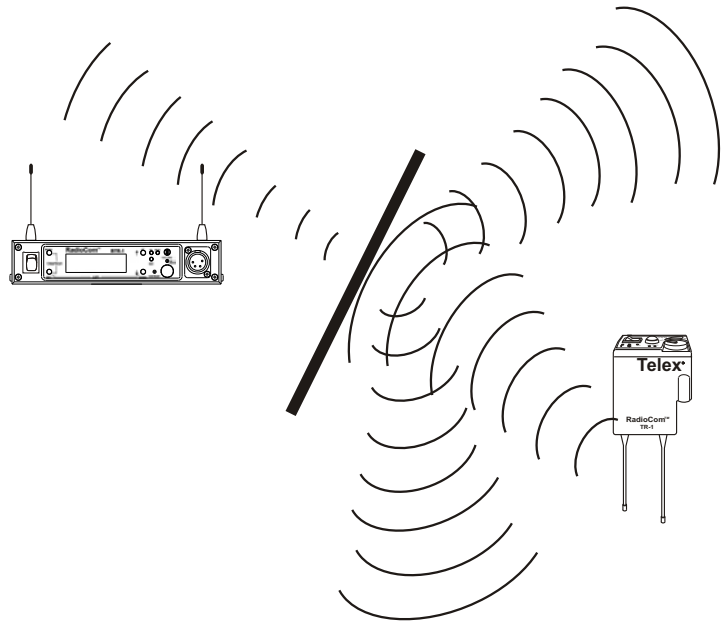
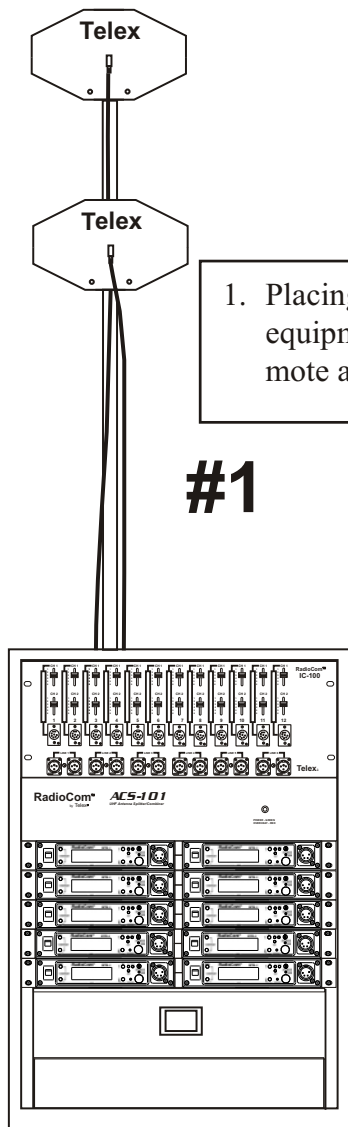

Figure 5-10
Operating System Near Obstructions

DO NOT - mount the base station 1/2-wave antennas on, or next to metal, such as beams, walls with metal studs, equipment racks, etc. This also applies to the antennas when assembled directly to the Base Station. This will “detune” the antennas which can result in noise or loss of RF signal at the base station.

Keeping the distance from the base station and beltack as short, and unobstructed as possible will produce the most reliable performance.

The base station is supplied with two antennas. This should provide satisfactory system performance in most applications. System range can be enhanced by removing the 1/2-wave antennas.



2. Placing the BTR on top of a shelf or equipment rack unobstructed without remoting the antennas is OK.

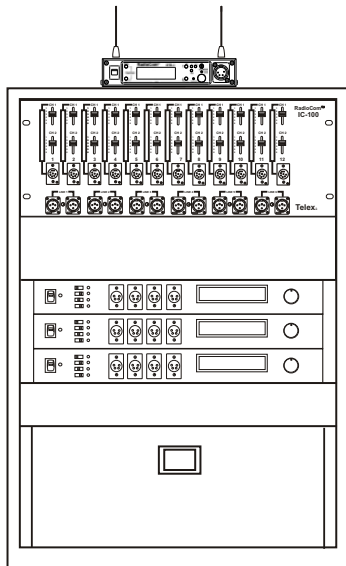

3. Placing BTRs in a shelf or equipment rack with the antennas mounted on the back of the BTR or the side of the rack is **BAD**.

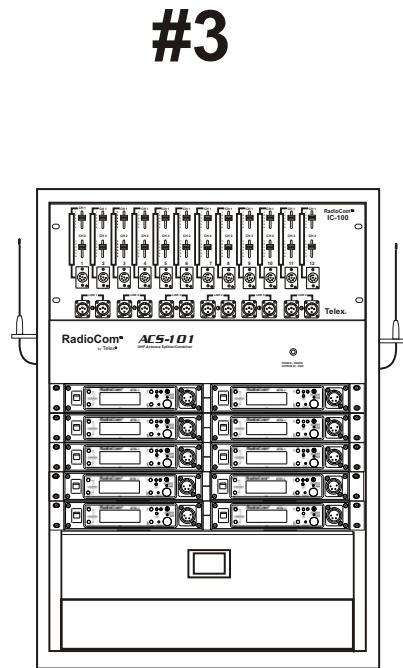

Figure 5-11
Antenna Placement

Basic Operational Description

The BTR-1 is a full duplex (simultaneous talk and listen) base station that works in conjunction with a TR-1 beltpack.

The base station, via the beltpack, allows communication with other wireless or wired users. The A, B and C buttons on beltpack are assigned their functions at the base station. The base station also has the ability to program the frequencies of the beltpack over-the-air. The sidetone for the base station's local headset and the beltpack are also adjusted at the base station.

If base stations are being used stand alone (no 2-wire power supply) but interconnected via the 2W interconnect cables, all used intercom channels must be loaded or a loud squeal may result.

System Quick Start

The following is a list to quickly get a base station and beltpack operating.

1. Ensure the base station and beltpack are of the same frequency bands.
2. Attach antennas to base station.
3. Power-up the base station.
4. Press <MENU> + <SET> + <UP> + <DOWN> on the base station once it is powered up.
5. Load the base station with a AudioCom power supply on intercoms 1 and 2 or place a load on intercoms 1 and 2.
6. Press <MENU> as powering-up the beltpack.
7. Set the encryption code on the base station.
8. Set the encryption code on the beltpack to match the base station.
9. Set the serial number of the base station in the beltpack.
10. The base should now indicate a battery voltage indicating the base station and beltpack are communicating.
11. Plug a headset into the base station and beltpack. Adjust the microphone gain on both so the overmodulation light flashes only on the loudest expected speech level.

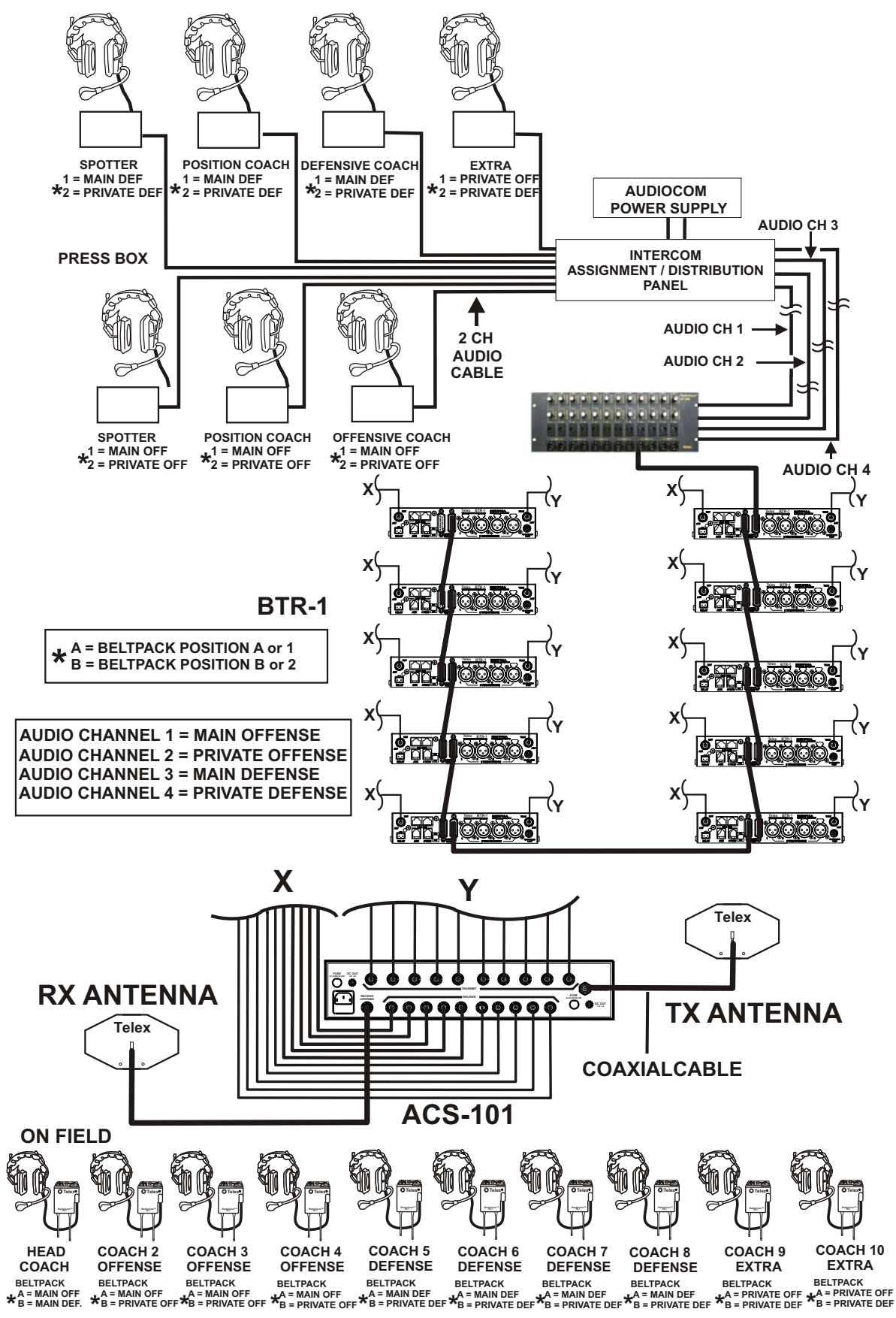

Figure 6-1
Example of a BTR-1 Ten Pack System Being Used by a Football Team

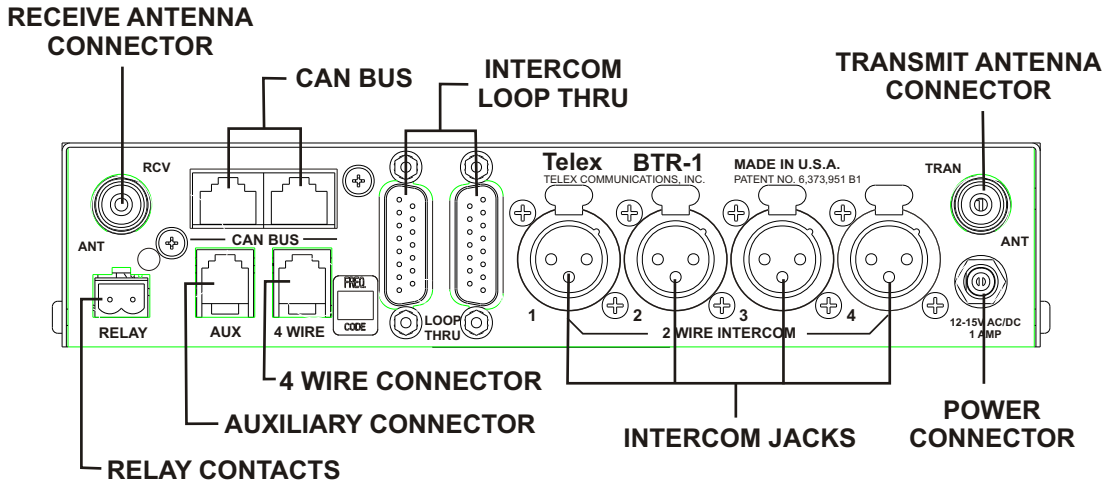

Figure 6-2
BTR-1 Rear Connectors

Interfacing to the BTR-1

TX / RX Antennas

The TNC jack marked “RCV” is for the receive antenna. The TNC jack marked “TRAN” is for the transmit antenna. The base station will come with two ½ wave antennas. Always match the color dot on the base station with the colored band on the antenna.

2W Intercom Ports

The base station has the ability to interface with up to six lines of 2-wire intercom. Intercoms 1 to 4 are available in two locations, the XLR ports and the D-sub loop thru connectors. Intercoms 5 and 6 are available only at the D-sub. See Figure 6-3 for the intercom assignments of the XLR and D-sub connectors. The female and male connectors are paralleled together. For a description of how to set up the 2W port refer to Intercom Settings in this Section.

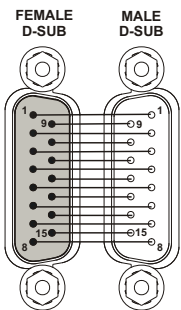

Physical Connections		Possible Connections when BTR-1 in Indicated Mod				
XLR Number, XLR Pin	DB-15	RTS XLR Mode		RTS DB15 Mode	2W Telex Mode	Clear-Com Mode
XLR 1, pin 2	1	OR	IC 1	CH 1	IC 1	
XLR 1, pin 3	9		IC 1	CH 2		IC 1
XLR 2, pin 2	2	OR	IC 2	CH 1	IC 2	
XLR 2, pin 3	10		IC 2	CH 2		IC 2
XLR 3, pin 2	3	OR	IC 3	CH 1	IC 3	
XLR 3, pin 3	11		IC 3	CH 2		IC 3
XLR 4, pin 2	4			IC 4	IC 4+	
XLR 4, pin 3	12				IC 4-	IC 4
	5			IC 5	IC 5+	
	13				IC 5-	IC 5
	6			IC 6	IC 6+	
	14				IC 6-	IC 6
XLRs 1,2,3,4, pin 1	7 & 8		GND	GND	GND	GND
	15		QB*	QB*	QB*	QB*

*QB= Quarter back mode. See intercom setting section.

Figure 6-3
Intercom Assignments of XLR and D-Sub Connectors

4W Intercom Ports

The base station can connect to a 4-wire system via the RJ-11 jack labeled “4 WIRE”. The pinout for this jack may be seen in figure 6-4. For a description of how to set up the 4 Wire Jack refer to intercom settings in this section. The 4 Wire jack is for balance input and output signals.

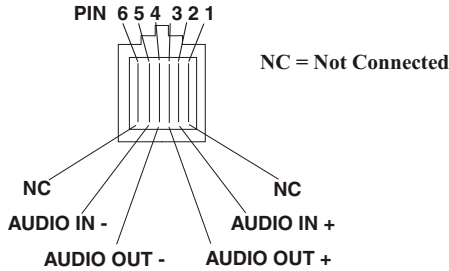

Figure 6-4
Pinout of the 4-Wire Jack

Auxiliary port

This jack allows a balanced input auxiliary signal to be placed into the base station. It also allows a balanced output signal to be brought out of the base station. The input signal can be software selected to be local or global. A local input signal is only heard at the base station’s local headset and belt-pack. A global input signal is heard throughout the intercom system(s) the base station is currently connected to via the selection of the belt-pack’s A, B or C button. The pinout for this jack is in figure 6-5.

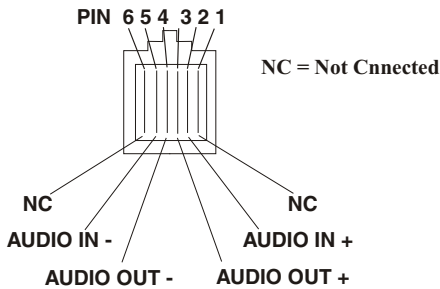

Figure 6-5
Pinout of the Auxiliary Jack

CAN Bus

The CAN bus allows the connection of multiple base stations to a Frequency Manager. The Frequency Manager then can be used to set all the base stations to a frequency plan plus set a variety of other options on the base station. The base stations then can program their belt-packs via an over-the-air link. Thus a whole system can be set-up with only a few button presses at the frequency manager. Each frequency manager can control up to 10 base station.

The CAN bus cable starts at the Frequency Manager and then proceeds to the first base station. From the first base station, the CAN bus daisy chains through all the base stations, stopping finally at the Frequency Manager. Both base station RJ-45 CAN bus connectors are wired in parallel so it does not matter which jack is used for the input or output cable. See Figure 6-6 below for a sample routing of the CAN bus cable. **NOTE:** For clarity the power, interconnect, and TX/RX cables are not shown in the figure.



Figure 6-6
CAN Bus Cables

Relay

A software selectable relay closure is available at the base station. The relay is normally open. However the base station software options can be set so the relay closes when the belt-pack’s “C” button is pushed. The relay schematic is shown in Figure 6-7.

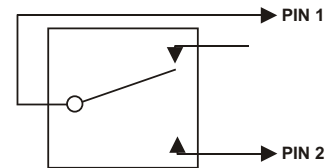

Figure 6-7
Relay Schematic

A “Phoenix” type connector (supplied) plugs into the relay contact port on the base station. This connector provides a screw-type closure for an easy connection to wires.

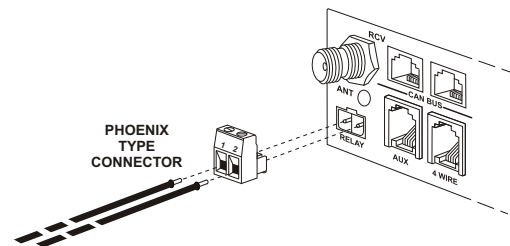

Figure 6-8
Relay Contact Jack Adapter

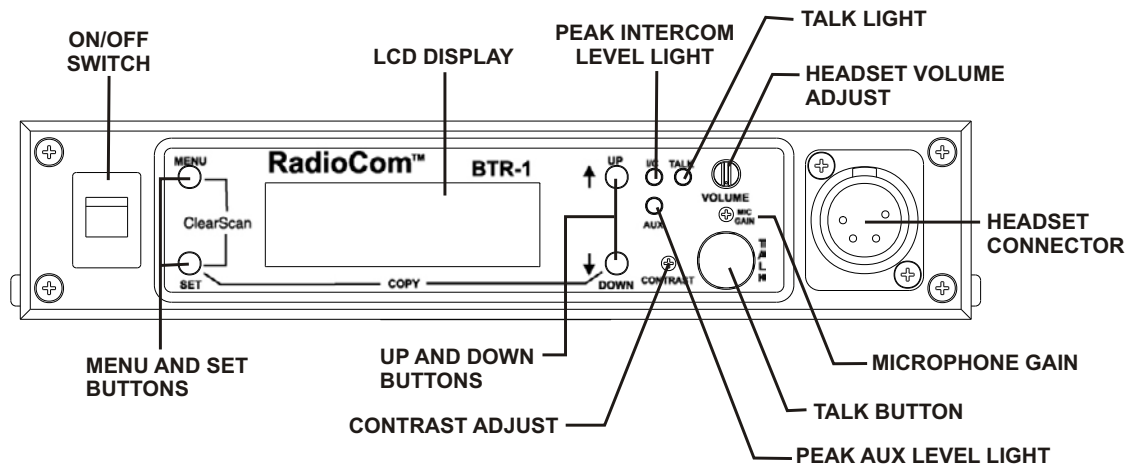

Figure 6-9
Front Controls and Connector

Local Headset

The local base station headset always following the audio selection of the beltpack. It cannot be set to independently select intercom channels.

Volume Control

Turn control clockwise to increase the headphone volume.

Talk Button

Press to enable audio path from the headset microphone. The talk light will activate when the talk button is active. This light has two functions. Green indicates activation of the talk button. Red or flashing red on most speech indicates overmodulation (too strong of input audio).

Overmodulation:

Light flashes on loudest speech = Gain OK
 Light flashes on all speech = Gain too High
 Light never flashes on loud speech = Gain too Low

Microphone Gain

The microphone gain of the base station's headset microphone maybe adjust via the pot above the Talk button. A plastic screwdriver was provided with the base station for this purpose. Adjust the gain for the overmodulation setting as shown above.

Powering the Base Station

The base station requires 12 – 15 Volts AC or DC at 1 Amp for power. The power jack accepts a 5.5 mm x 2.1 mm screw on plug. An inline 12 Volt DC power supply was provided with the base station.

Power the base station via the rocker switch located to the left as facing the base station.

Start-up

When the BTR-1 is powered-up the 1st screen displayed is the start-up splash screen. It will be displayed for about 3 seconds. This screen contains the software version and channel map versions that are loaded into the base station. The following screen has software version sb10016, and channel map versions B0001 and 30001. This indicates it is a B3 unit.



After 3 seconds the status screen will appear. See the "BTR-1 Menu Structure" section for a flowchart of the main BTR-1 screens.

Status Screen

The status screen is the main information screen of the base station. It displays a number of system items:

- Name of Base Station
- Number of Base Station
- The Beltpack Button Currently Selected
- Group and Channels
- Intercoms Active
- The Bands of System A2, B3, E7, etc.
- The Intercom Type Selected 2W or 4W
- Battery Life at the Beltpack

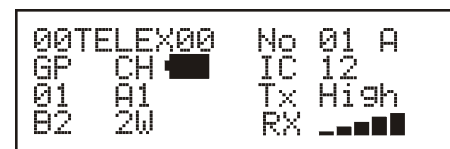

The status screen may be changed to an alternate display by pressing <MENU> for 3 seconds. The alternate display shows the base name and number in double wide and double tall characters. It also indicates the system's band and frequencies in normal characters. Pressing <MENU> for 3 seconds again will revert back to the main status screen.

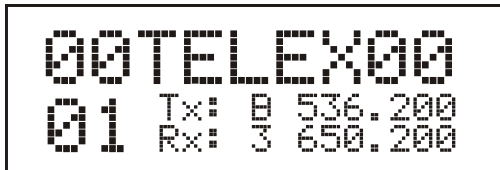

Encryption Code

The base station has a four digit, hexadecimal, encryption code that can be set by the user. It must match the code at the beltback in order for communication between the beltback and base station to occur.

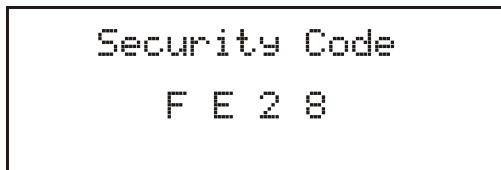

Changing the Encryption Code

1. From the status screen hit <MENU> once to arrive at the security code / system settings / intercom settings/RF meter menu screen.
2. Select the security code menu with the <UP>/<DOWN> arrow buttons and press <SET> to go to the security code screen.
3. The first code position will be flashing. Set the digit by using the <UP>/<DOWN> arrow buttons then pressing <SET> to go to the next code position.
4. After the last code position is set press <MENU> to go back to the status screen or press <SET> to begin editing again.

System Settings

The systems settings allows a number of base station characteristics to be set. This includes base name, base number, intercom type, aux type, base TX power, BP off mode, sidetone and frequencies.

Name and Number

The name of the base station may be set to any 10 digit alphanumeric character. For example, in a football situation the name of the coach may be entered. This provides an easy identifier to the user as to who's base station it is.

The number of the base station can also be set from 1 to 10. In a system of base stations managed by a frequency manager the base number must be set to a unique number because this is how the frequency manager identifies the base station.

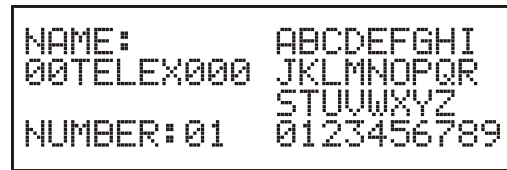

Changing the Base Name and Number

1. From the status screen hit <MENU> once to arrive at the security code / system settings / intercom settings/RF meter menu screen.
2. Select the system settings menu with the <UP>/<DOWN> arrow buttons and press <SET> to go to base setting sub-menu.
3. Select the base name and number menu with the <UP>/<DOWN> arrow buttons and press <SET> to go to the base name and number set screen.
4. The first name position will be flashing. Set the alphanumeric character by using the <UP>/<DOWN> arrow buttons then pressing <SET> to go to the next position. Up to 10 characters may be set.
5. After the alphanumeric characters are set the screen proceeds to the number selection. Select the number menu with the <UP>/<DOWN> arrow buttons and press <SET> to set it.
6. After the number is set press <MENU> to go back to the status screen or press <SET> again to begin the process over again.

Base Main Settings

This important screen enables the user to set the wired intercom type connected to the system, the auxiliary input type, the transmitter power, BP Off Mode, and the base station and beltback side tone levels.

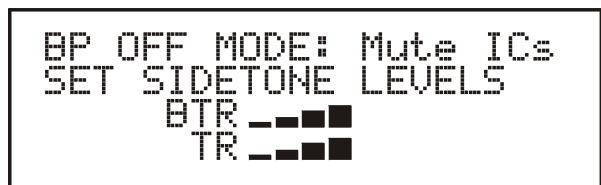
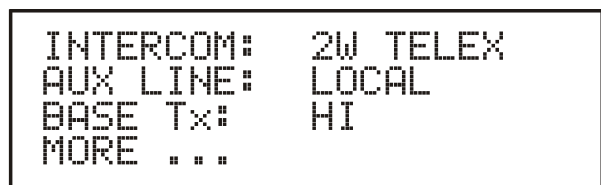

Intercom Type

The base station has the ability to interface to a variety of wired intercom systems. These include Telex (AudioCom), RTS 2W, ClearCom, Four Wire Systems and others.

Auxiliary Line

The auxiliary line may be set to local or global.

Local = Any audio placed into the auxiliary input port is routed only to the base station's local headset and beltpack

Global = Any audio placed into the auxiliary input port is routed not only to the base station's local headset and beltpack, but also to any wired system connected to the base station.

Base TX Power

The base station transmit power can be set to two positions.

NORM = The transmit power is about 10 dB below maximum power. This is 5 mW typically.

HI = The transmit power is at full power. This is 50 mW typically.

BP Off Mode

This option sets the base station's wired connectivity when the beltpack is off, out of communications range or in Push-to-Tx mode, with the talk button OFF.

MUTE ICs = The base station drops connectivity to any wired intercom connected to it after 1 second of no communications from a beltpack.

LAST IC = The base station maintains connectivity to the wired intercom(s). The base station remains on the last intercom channel(s) selected when not receiving communications from a beltpack.

BTN A = The base station connect to the "A" button defined wired intercom(s) when not receiving communications from a beltpack.

BTN B = The base station connects to the "B" button defined wired intercom(s) when not receiving communications from a beltpack.

BTN C = The base station connects to the "C" button defined wired intercom and activates the "C" button options (QB and/or relay if active) when not receiving communications from a beltpack.

Sidetone Levels

The sidetone is the amount of a user's own voice that is feed back to their headphones. Both the beltpack and base station sidetone may be adjusted in the base main settings.

Changing the Intercom and Auxiliary types, TX power and Sidetone

1. From the status screen hit <MENU> once to arrive at the security code / system settings / intercom settings/RF meter menu screen.
2. Select the system settings menu with the <UP>/<DOWN> arrow buttons and press <SET> to go to the base station settings sub-menu.
3. Select the base main settings menu with the <UP>/<DOWN> arrow buttons and press <SET> to go to the base station main settings set screen.
4. The intercom type will be flashing. Set the type by using the <UP>/<DOWN> arrow buttons then pressing <SET> to go to aux line options.
5. The aux line type will be flashing. Set local or global by using the <UP>/<DOWN> arrow buttons then press <SET> to go to the base station Tx options.
6. The Tx option will be flashing. Set Norm or High by using the <UP>/<DOWN> arrow buttons then press <SET> to go to the beltpack off mode option.
7. The beltpack OFF mode will be flashing. Set the desired mode by using the <UP>/<DOWN> arrow buttons, then press <SET> to go to the set sidetone levels option.
8. The screen will change to a BTR and TR side level options screen. Set the BTR side level by using the <UP>/<DOWN> arrow buttons then press <SET> to go on to the TR sidetone level.
9. After the TR sidetone is set press <MENU> twice to go back to the status screen or press <SET> again to begin the editing of the base main setting again.

Frequency Settings

The group and channels of factory defined groups may be changed in this screen. However, factory defined frequencies cannot be changed. User defined groups and channels may be defined in this screen too. The user defined frequencies can be changed by the user.

Gp 01	Ch A1
Tx	Rx
536.200	650.200
TU 25	TU 44

Whenever the group, channels or frequencies are changed at the base, it will display the following screen:

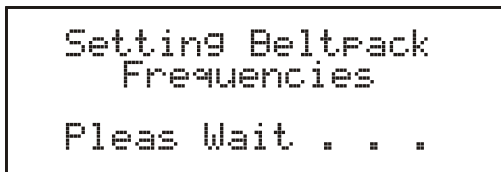

This will occur regardless of a beltpack communication to the base station or not. It is a broadcast type of message. If a beltpack is communication with the base station, then two software menu functions in the beltpack determines if that beltpack will follow the base to the new frequencies or stay where it is currently. One option is called, "Auto Programming", the other option is, "Transmit Power". The beltpack auto programming must be set to ON and the Transmit Power set to "Auto" for automatic frequency programming of the beltpack to occur. More detail on these two options may be found in the "TR-1 Operation" section of the manual.

Changing Groups / Channels / Frequencies

1. From the status screen hit <MENU> once to arrive at the security code / system settings / intercom settings / RF meter menu screen.
2. Select the system settings menu with the <UP>/<DOWN> arrow buttons and press <SET> to go to the base station settings sub-menu.
3. Select the Frequency settings menu with the <UP>/<DOWN> arrow buttons and press <SET> to go to the Groups/Channels/Frequencies set screen.
4. The group will be flashing. Set desired groups by using the <UP>/<DOWN> arrow buttons then press <SET> to go to the transmit channel.
5. The transmit channel will be flashing. Set the channel by using the <UP>/<DOWN> arrow buttons then press <SET> to go to the receive channel.
6. The receive channel will be flashing. Set the channel by using the <UP>/<DOWN> arrow buttons then pressing <SET> to end editing in factory defined groups.
7. In factory defined groups, after the RX channel is set press <MENU> once to go back to the status screen. Press <SET> again to begin the editing of the screen again. In user defined groups the editing continues with the Tx frequency then Rx frequency. Once these are set, press <MENU> once to go back to the status screen or press <SET> again to begin the editing of the screen again.

Intercom Settings

While the intercom type was set in the base main settings, the other 2W intercom setting are done in this screen. The assignment of the three beltpack buttons, A, B and C, to the intercom ports are done here. The intercom input and output levels are also set here. This screen also provides the ability to set the intercom to mute, talk or listen and activate or deactivate auxiliary audio to an intercom channel. The C button also has the added selectable options of QB on/off and Relay on/off.

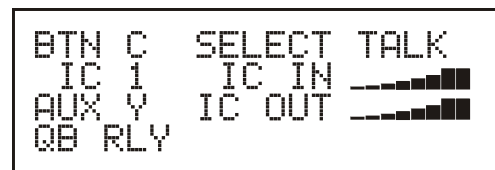
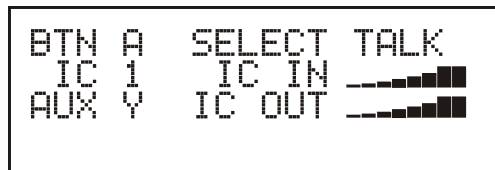

Setting the A, B and C TR-1 button intercom selections

1. From the status screen hit <MENU> once to arrive at the security code / system settings / intercom settings / RF meter menu screen.
2. Select the intercom settings menu with the <UP>/<DOWN> arrow buttons and press <SET> to go to the intercom settings.
3. The button selected will be flashing (A, B or C). Select the desired button by using the <UP>/<DOWN> arrow buttons then press <SET>. The intercom port will now be flashing.
4. Select the intercom port to be set. Intercoms 1 – 6 will be available (1-3 in 2W RTS XLR). Set the intercom port by using the <UP>/<DOWN> arrow buttons then press <SET>. If in 2W RTS XLR mode an additional option will appear. This is RTS Channel 1 or 2 Select. Use the <UP>/<DOWN> arrow buttons to set the RTS Channel, then press <SET>. The intercom mode will start to flash. Select from Mute, Talk or Listen.

MUTE = The intercom port is off. No audio is placed on or taken from that port.

TALK = The intercom port is active. Audio is passed to and from the beltpack and base station's local headset.

LISTEN = The audio on the intercom port can be heard at the beltpack and base's local headset, but no audio is passed to the intercom port from the beltpack or local headset.

- If talk is selected the user will be asked to set the intercom in and out levels. If Listen is selected the user will be asked to set the listen level. Use the <UP>/<DOWN> arrow buttons to adjust the levels, then press <SET> to accept the levels. NOTE: Inverted character for the intercom / listen levels indicates the option is off. After levels are set the aux input selection is now active.
- The aux input selection will now be flashing. Use the <UP>/<DOWN> arrow buttons to select aux audio Yes or No. Press <SET> to accept the choice. Aux input is selectable by button only. Setting the aux input for button A to yes sets all intercoms active for that button to yes, setting it to no sets all intercom ports for no.
- If aux input was set to “Y” then the user will be asked to set the auxiliary input and output levels. Use the <UP>/<DOWN> arrow buttons to adjust the input and output levels, then press <SET> to accept the levels. Press <MENU> once to go back to the status screen or press <SET> again to begin the editing of the screen again.
- On the “C” button there are two more selectable options: QB and RELAY. If active these options are in normal characters, if off the options are in inverted characters. Use the <UP>/<DOWN> arrow buttons to select the option then press <SET> to accept the option.

QB = If active, when the button C on the beltpack is pressed, a 1000 Ohm path to ground is activated at pin 15 of the male and female D-sub connector in the rear of the unit. This can be used to active a PTT on some external radio systems. Audio from the beltpack and local base station’s headset is also available at pin 15 only when QB is active.

Relay = If active, when button C on the beltpack is pressed, a relay closure is activated on the rear of the base station.

RF Meter

This screen displays a larger version of the 5 bars of received signal strength displayed on the status screen. It also displays the receive frequency.

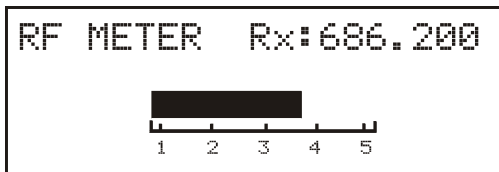

Changing to the RF Meter Screen

- From the status screen hit <MENU> once to arrive at the security code / system settings / intercom settings / RF meter menu screen.

- Select the RF meter menu with the <UP>/<DOWN> arrow keys and press <SET> to go to the RF meter.

ClearScan™

Press and hold <MENU> + <SET> for 3 seconds to enter the ClearScan™ menu. There will be three option from with to choose from by using the <UP>/<DOWN> arrow buttons and then press <SET>. Those options and the results are explained below.

ClearScan™ Groups

This option scans all the groups in the base station. The group with the highest number of clear receive channels is listed at the top of the list (<UP> arrow all the way to the top). The next group down has the second highest number of clear receive channels and so forth. Channels that clearly have RF interference on them are inverted.

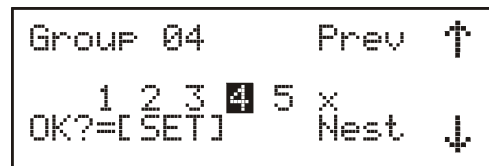

A possible result of ClearScan™ Groups is shown below:
 ✕ = No frequency in that receive channel position. It would be dashed lines if examined in the group/channels screen.

4 = Interference found on the receive channel during the groups scan.

After a group is decided upon, press <SET> to select that group. A ClearScan™ Channels is now initialed. See ClearScan™ Channels description.

ClearScan™ Channels

This option scans all the receive channels within the base station's currently set group. This scan is also initialed after a ClearScan Groups in order to find the clear receive channels within that group. The receive channel with the least amount of RF noise on it is listed at the far left (<UP> arrow all the way to the left). The next channel to the right has the next least amount of RF noise on it and so forth. Channel that clearly have RF interference on them are inverted.

A possible result of a ClearScan™ Channels is shown below.

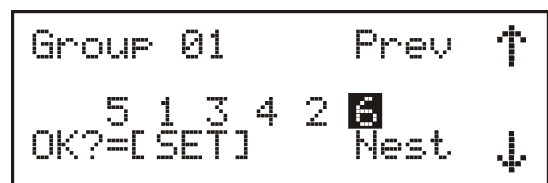

S = Interference found on the receive channel during the scan or no receive frequency in that receive channel position.

After a channel is decided upon, press <SET> to select that channel

ClearScan™ Band

This option continuously scans the whole receive band until user intervention. The scan starts at the beginning of the band, then checks and records every 200kHz for the RF received signal strength level. Press <SET> to store the results in user group 63u. Press <MENU> to bail out of the band scan without saving any results. The results of the six clearest RF frequency areas are listed in the receive side of user group 63u. Channel 1 is the best (clearest) frequency found, channel 2 is the next best and so forth, to channel 6.

```
GP 63u      CH A1
Tx          Rx
---.---    703.400
TV --      TV 52
```

Special Button Functions

Factory Defaults

Press and hold <MENU> + <SET> + <DOWN> for 3 Seconds. A screen displaying, "Factory Defaults" will then appear.

This function sets the base station to Group1, channels A and 1 and ERASES any user defined groups in memory. It will also set the unit to factory defined parameters.

1st Use Defaults

Press and hold <MENU> while turning on the base station. A screen displaying, "Factory Defaults" will then appear.

This function sets the base station to Group 1, channels A and 1 and RETAINS any user defined groups in memory. It will also set the unit to factory defined parameters.

Alternate Screen

Press and hold <MENU> for 3 seconds to toggle between the alternate screen and the status screen. The alternate screen is shown below.

```
00TELEX00
01 Tx: 0 536.200
Rx: 3 650.200
```

The alternate screen displays the base name and number in double wide double tall characters. Up to ten character in the name can be displayed. It also shows the bands of the unit and the currently set frequencies.

Lockout

Press and hold the <UP> + <DOWN> buttons for 3 seconds to lock or unlock the base station. A padlock will appear on the status and alternate screens if the base is locked.

This function locks out a user from changing any options at the base station.

Copy

Press and hold the <SET> + <DOWN> buttons for 3 seconds and the following screen will appear:

```
Copy Group 01
to Group 51u
```

This allows the user to select a user group to copy the current group to. Now the user could edit that group slightly if desired.

Display Start-up Screen

Press and hold <DOWN> + <TALK> for 3 seconds.

```
Telex Communications
RadioCom™
sb10016      00001
              30001
```

This function allows the user to check the software and channel map version of the base station without rebooting the base.

Section 7 TR-1 Operation

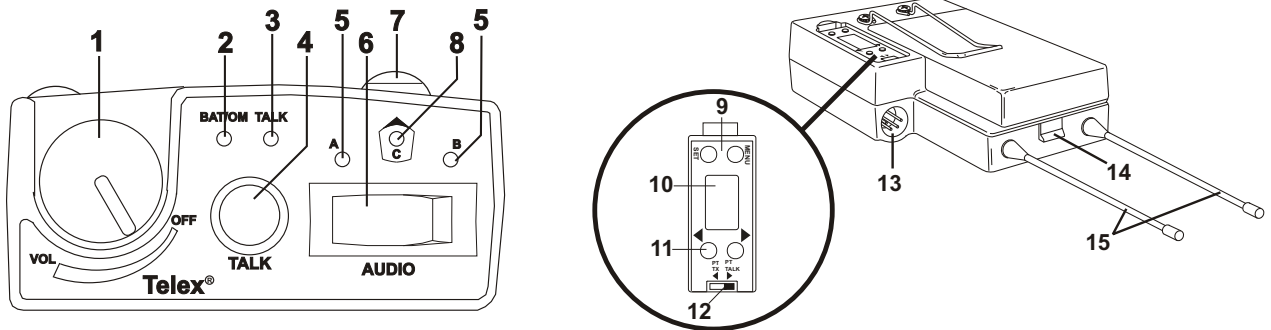

1. On/Off & Volume Control
2. BAT/O.M. Light
3. Talk Light
4. Talk Button
5. A and B Lights
6. Selection Switch
7. "C" Pushbutton
8. "C" Button Light

9. [MENU] and [SET] Buttons
10. LCD Display
11. [UP] and [DOWN] Buttons
12. Push-to-Talk/Push-to-Transmit Switch
13. Headset Connector
14. Battery Latch
15. Receive and Transmitter Antennas

Figure 7-1
Controls and Connections

Basic Operational Description

The TR-1 is a full duplex (simultaneous talk and listen) beltpack that works in conjunction with a BTR-1 base station. The beltpack allows a user, via a headset attached to the beltpack, to communicate with other wireless or wired users. Other base stations and / or wired intercom systems connect to the beltpack's base station. The base station is what allows the audio path interconnecting for the beltpack audio.

The talk button on the beltpack turns the microphone input of the beltpack on or off. The A / B rocker switch and the C button select preset audio paths that are set-up via the base station. For example, the base station may be set-up for A to route beltpack audio to and from wired intercom 1, B routes beltpack audio to and from wired intercom 2 and C to route audio to and from wired intercoms 1 and 2 plus active a relay.

System Quick Start

1. Ensure the base station and beltpack are of the same frequency bands.
2. Attach antennas to base station.

3. Ensure intercom ports 1 and 2 are loaded via a Telex (AudioCom) load (300Ω between pins 2 and 3) or connected to a power supply. **WARNING:** Failure to load the intercom ports could cause a loud feedback due to excessive gain when a headset is placed on the base or beltpack.
4. Power-up the base station.
5. Press <MENU> + <SET> + <UP> + <DOWN> on the base station once it is powered up.
6. Press <MENU> as powering-up the beltpack.
7. Set the encryption code on the base station.
8. Set the encryption code on the beltpack to match the base station.
9. Set the serial number of the base station in the beltpack.
10. The base should now indicate a battery voltage indicating the base station and beltpack are communicating.
11. Plug a headset into the base station and beltpack. Adjust the microphone gain on both so the overmodulation light flashes only on the loudest expected speech level.

Battery Installation

Ensure that the On/Off volume control knob is turned off. Press down and hold down the battery release latch, slide the battery pack about 1/8 inch back, toward the latch, until it stops. Then lift battery pack out. Replace batteries as follows:

- 1. Open the battery pack by inserting finger nail and lifting.

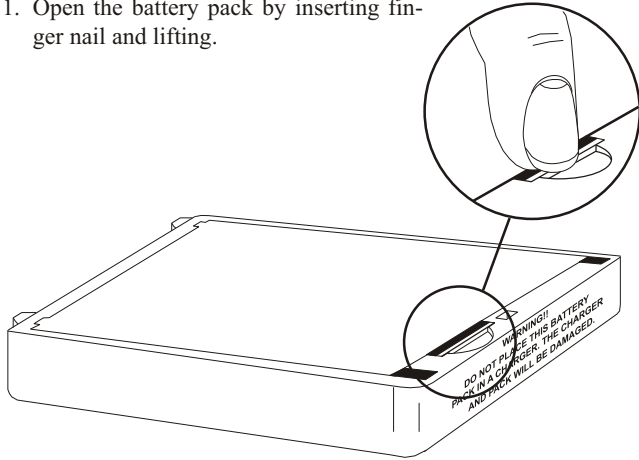

- 2. Pull battery strap to remove low or dead batteries.

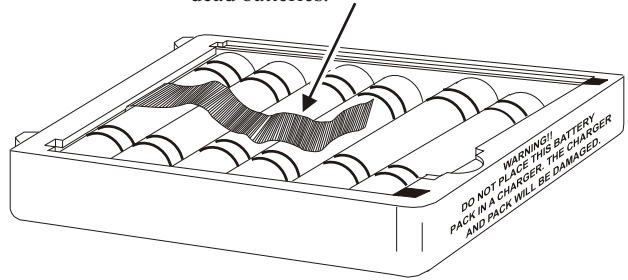

- 3. Load new batteries following the polarity as shown in battery case



- 5. Be sure strap goes under batteries.

- 6. Tuck end of strap under door when placing the battery cover back on the case.

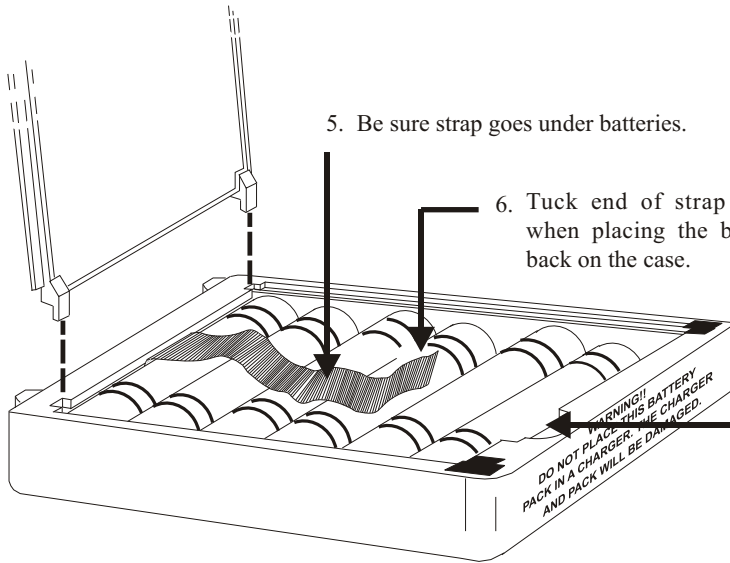

- 4. Start loading at the end of the case where the strap is attached to the case.

Figure 7-2
Battery Installation

WARNING: Do not place an alkaline TR battery pack in any battery charger. Severe charger and batter pack damage may results.

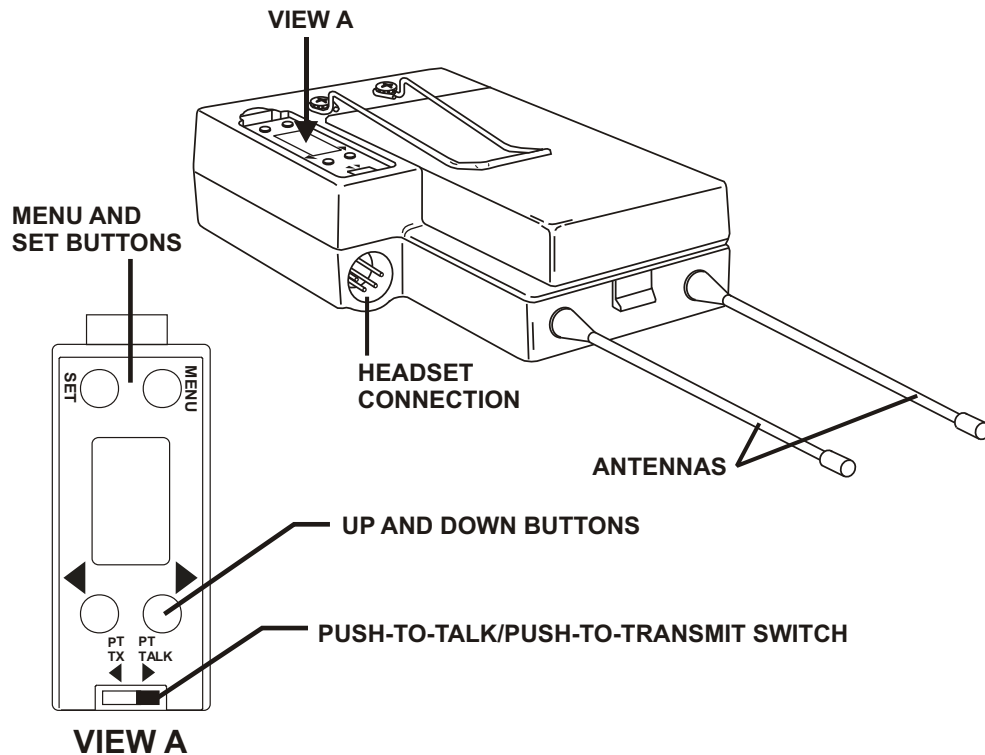

Figure 7-3
TR-1 Controls

Transmit Modes (PT TALK, PT TX)

The rear panel has a slide switch that can be set to the following two modes:

PT TALK (Push-to-Talk) – The transmitter is always on. No audio is sent unless the talk button is active. Recommended position.

PT TX (Push-to-Transmit) – The transmitter and audio path are off except when the talk button is active.

Headset Connection

The headset connector is a XLR type connector. Four or five pin Telex or RTS headset connectors may be installed in the unit. See the “TR-1 Controls and Connections” section for information on the pinouts. A dynamic or electret headset microphone is automatically detected by the beltpack and a bias voltage supplied if needed.

Sidetone

Sidetone is the amount of the users voice that is feedback to their headphone. The sidetone level in the beltpack is set at the base station. Please see “BTR-1 Operation” section for how to set this level.

Antenna Connection

The beltpack comes with two detachable, screw type, $\frac{1}{4}$ wave antennas. Attach the two antennas by screwing the antennas into the receptacles at the bottom of the beltpack. The color dot on the screw end of the antenna must match the color dot on the antenna receptacle.

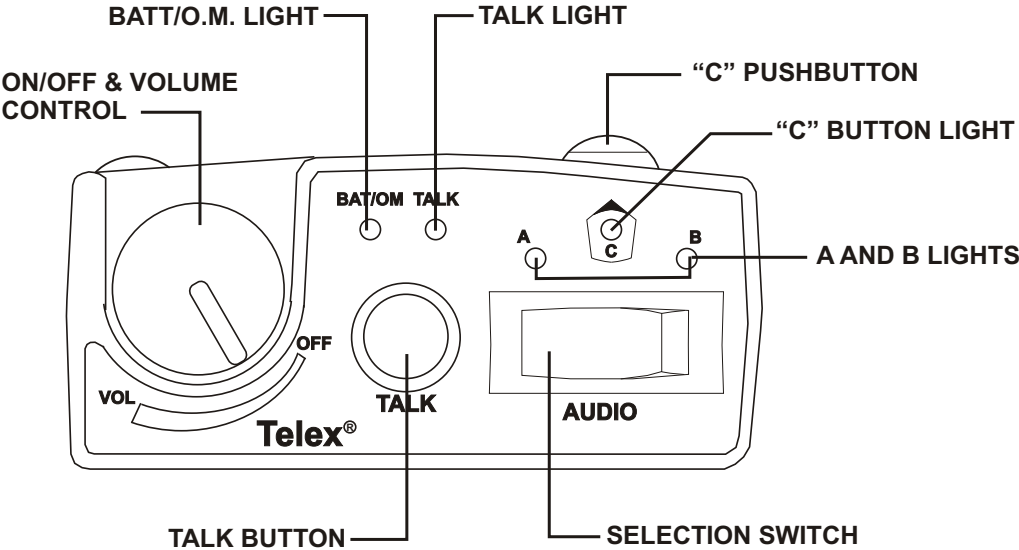

Figure 7-4
TR-1 Top Panel Controls

On / Off Volume Control

Turn control clockwise to turn the beltback on and adjust the headphone volume.

BAT/O.M. Light

This light has two functions. It indicates over modulation (too strong of input audio) and low battery.

Battery	Light flashes on power up	= Battery OK
	Light on continuously	= Battery Low
	Light does not flash or come on	= Battery Dead
Over modulation	Light flashes on loudest speech	= Gain OK
	Light flashes on all speech	= Gain to high
	Light never flashes on loudest speech	= Gain to Low

Talk Button

Press to enable audio path from the headset microphone. The talk light will activate when the talk button is active. It has three software selectable modes that can be seen via the LCD display of the beltback. The mode of the talk button may be selected by pressing and holding <SET> while hitting the talk button. The current mode of the talk button will be displayed the first time the talk button is hit. Hit the talk button again to change the mode of the button. Release the <SET> button to accept the currently displayed setting.

Selectable Modes: TALK	Push-to-Talk
	Push-to-Latch
	Off

A / B Selection Switch

This rocker switch switches between A and B button base station pre-sets.

C Pushbutton

The C button activates the base station C audio paths and special functions.

Selectable Modes: Button "C"	Momentary
	Latching
	Quarterback
	OFF
	Push-to-Talk
	Latching Talk

The mode of the C button may be selected by pressing and holding <SET> while hitting the C button. The current mode of the C button will be displayed the first time the C button is hit. Hit the C button again to change the mode of the button. Release the <SET> button to accept the currently displayed setting.

Group and Channels

The first LCD screen the beltback displays after power-up is the group / channels screen. This screen shows the currently selected group followed by the receive and transmit channels where the unit is set.

Editing Group / Channels

1. Push <SET> to edit the group. The group number will begin flashing.
2. Select the desired group with the, <UP>/<DOWN> arrow buttons.
3. Push <SET> to accept the group. The receive channel letter will now begin flashing.
4. Select the desired channel with arrows buttons.
5. Push <SET> to accept the receive channel. The transmit channel number will now begin flashing.
6. Select the desired channel with the arrow buttons.
7. Push <SET> once more to accept the transmit channel.
8. The new group containing the selected channels is now set.

NOTE: Pressing <MENU> during the group/channels editing will bail out of the editing without any changes.

Factory group's frequencies are not changeable.
User group's (Group 51u to 64u) frequencies are changeable.

Transmit Frequency

This screen displays the frequency in MHz of the beltback transmitter. The frequency is not changeable in factory defined groups. The frequency is changeable in user groups.

Editing the TX Frequency (User Groups Only)

1. Set the unit to the desire user defined group and channels. See Groups and Channels Instructions. The menu structure at the right (Figure 7-5) indicates how to get to the transmit frequency screen.
2. Push <SET> to edit the TX frequency. The frequency will begin flashing.
3. Select the desired frequency with the <UP>/<DOWN> arrow buttons. The frequency can be changed in 25 kHz steps.
4. Push <SET> to place the unit on the new transmit frequency.

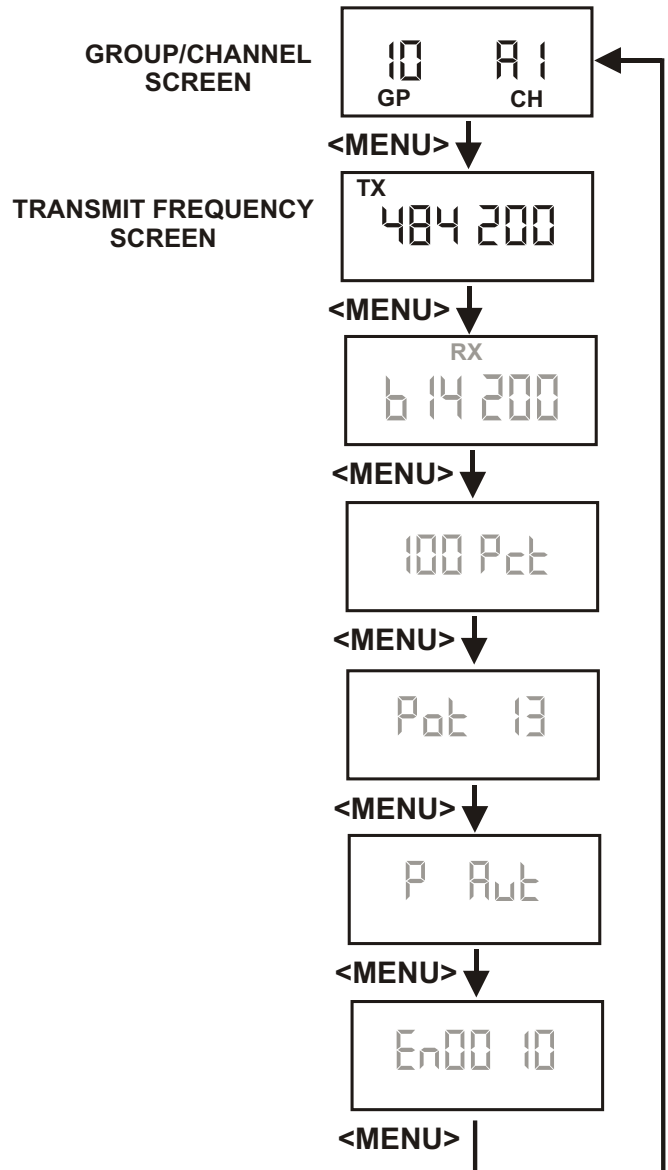

Figure 7-5
Group/Channel and Transmit Frequency Screen

Receive Frequency

This screen displays the frequency in MHz of the beltpack receiver. The frequency is not changeable in factory defined groups. The frequency is changeable in user groups.

Editing the RX Frequency (User Groups Only)

1. Set the unit to the desired user defined group and channels. See Groups and Channels Instructions. The menu structure at the right (Figure 7-6) indicates how to get to the receive frequency screen.
2. Push <SET> to edit the RX frequency. The frequency will begin flashing.
3. Select the desired frequency with the <UP>/<DOWN> arrow buttons. The frequency can be changed in 25 kHz steps.
4. Push <SET> to place the unit on the new receive frequency.

Battery Display

The battery display screen indicates the current percentage of battery life based upon alkaline batteries being used in the unit. NiMH battery packs will lose voltage much faster than alkaline batteries toward the end of life.

Battery Percentages

- 100 Pct = Fresh Battery
- 75 Pct = 75 % Life Left
- 50 Pct = 50 % Life Left
- 25 Pct = 25 % Life Left
- 10 Pct = 10 % Life Left. Low Battery Light Active.
- 0 Pct = Battery Dead. Unit will lose communication at any time.

Setting the Low Battery Alert Tone

The beltpack has an audio alert tone that is sent to the headphone if the battery life reaches 10 %. The tone is at 1 kHz and is heard for 0.5 seconds every 30 seconds. The tone is only heard at the beltpack. The alert tone function may be turned on or off at the beltpack:

Low Battery Alert Tone On/Off

1. Press <SET> at the battery percentage screen. The screen below will appear.



2. The low battery tone option will also begin flashing.
3. Use the <UP>/<DOWN> arrow buttons to turn the option on or off.

4. Push <SET> to accept the change. The display will now return to the battery life screen.

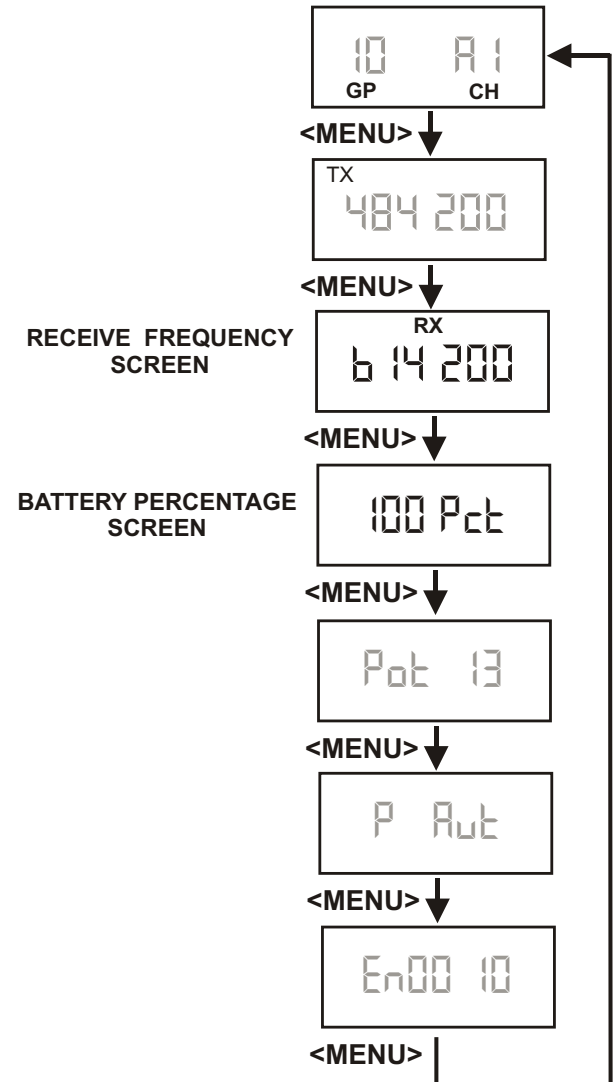

Figure 7-6
Receive Frequency/Battery Percentage Screen

Microphone Gain

This screen displays the setting of the microphone gain of the beltpack. There are 16 possible settings. The number 0 indicates no microphone gain, the number 15 is maximum gain. Each step is about 3 dB of audio.

Adjusting the Microphone Gain

1. Push <SET> at the microphone gain screen. The number will begin flashing.
2. Select the desired gain with the <UP>/<DOWN> arrow buttons.
3. Push <SET> to place the unit at the indicated microphone gain.

Transmit Power

The transmit power screen displays the current setting of the beltpack transmitter's output power level. There are three settings.

Transmit Power Settings

Auto (Default)	The beltpack's transmitter adjusts its output level according to information sent to the beltpack from the base station. NOTE: A decimal point in the display indicates the transmitter is at high power, no dot means the unit is at low transmit power.
High	The beltpack is transmitting at full power, nominal 50 mW, constant.
Low	The transmitter is at low power, nominal 5 mW, constant.

When the unit is set to auto the beltpack will set its power setting according to information being sent from the base station. The base station information will tell the beltpack the appropriate power setting to use based upon received signal strength level at the base station from the beltpack. By reducing the transmit power when possible, the battery life of the beltpack can be slightly extended. Also intermodulation products can be reduced.

Changing the Transmit Power Setting

1. Push <SET> at the transmit power screen. The power setting will begin flashing.
2. Select the power setting with the <UP>/<DOWN> arrow buttons.
3. Push <SET> to place the unit at the indicated setting.

Encryption Code

The encryption code screen allows the setting of four hexadecimal digits. Any combination of letters and/or numbers may be selected. The beltpack's code must match the base station's code for audio recovery. This code along with the serial number encryption code discussed on the next page, means there is over 4 billion possible code combinations.

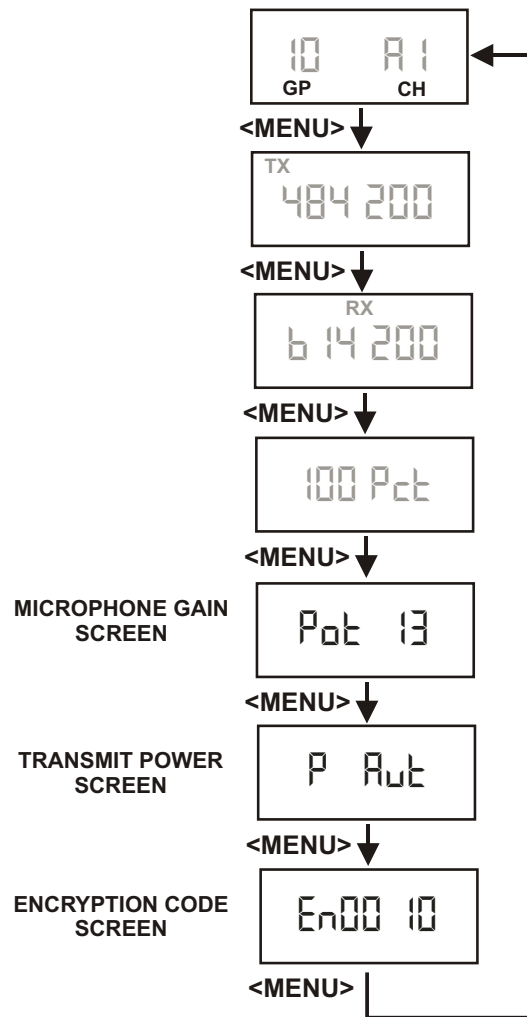

Figure 7-7
Microphone Gain Screen and Transmit Power Screen

Changing the Encryption Code

1. Push <SET> at the encryption code screen. The first code location will begin flashing.
2. Select the desired number / letter with the <UP>/<DOWN> arrow buttons.
3. Push <SET> to set the code. Now the next code location will begin flashing.
4. Set the next three code locations in the same manner.

Serial Number Code

The base serial number is required to be input to the beltack to allow communication with that base station. The number, like the encryption code, is composed of four hexadecimal digits. This extra security along with the encryption code means there is over 4 billion possible code combinations.

Changing the Serial Number Code

1. Press and hold <MENU> + <UP> buttons at the encryption code screen for about 3 seconds. The serial number set screen will appear.



2. Push <SET> to start the first number flashing. Select the desired number with the <UP> <DOWN>/ arrow buttons.
3. Push <SET> to set the code. Now the next code location will begin flashing.
4. Set the next three code locations in the same manner.

Auto Programming

This function allows the base station to change the beltack's frequencies "over-the-air". Thus whenever the base station's groups / channels are changed the beltack will automatically follow. If the beltack's frequencies are changed "over-the-air", the beltack will place those frequencies in group 64u, and go to group 64u.

Auto frequency programming, via the base station changing frequencies, only will occur at the beltack if the following is set: Beltack already in communication with the base station, beltack auto programming set to on and beltack transmit power set to auto.

Enabling / Disabling Auto Programming

1. In any of the beltack main screens press and hold <UP> the button for 3 seconds. The following screen will appear.



2. The auto programming option will also begin flashing.
3. Use the <UP>/<DOWN> arrow buttons to turn the option on or off.
4. Push <SET> to accept the change. The display will now return to the main screen.

Software / Channel Map Version

The software and channel maps of the beltack may be displayed from any of the main beltack screens.

Viewing the Software and Channel Maps Version

1. In any of the beltack main screens press and hold the <DOWN> button for 3 seconds. The following screen containing the software version will appear.



2. As long as the <DOWN> button is pressed the software version in the beltack will be displayed.
3. When the button is released the following two channel map screens will be displayed for a second each.



4. The first screen indicates the receive channel map in the beltack. The second screen indicates the transmit channel map. The above screens indicate that it is a A4 band beltack.
5. The screen will now revert back to the main screen.

ClearScan

ClearScan allows the selection of RF clear channels in an area. The beltack ClearScan has three modes:

1. **Scan Groups**- The beltack's receiver scans all the factory defined groups and any user defined groups that have been set. The result is a list of the top 20 groups, ranked in order of the most clear receive channels in that group. The <UP> arrow all the way to the top is the group with the most clear channels.
2. **Scan within a Group** - The beltack's receiver scans all the receive channels within a group. The result is a list of the channels in that group ranked in order of best to worst channels. The <UP> arrow all the way to the top is the channel that is the best.
3. **Scan Band** – The beltack's receiver scans the entire band of frequencies continuously. It starts at the beginning of the receive band and checks the frequency every 100 kHz until the end of the receive band, then starts over. The user must push <SET> to stop the scanning. The 100 kHz step size is as close as is needed because the narrowest receive filters are 230 KHz wide. This is why every 25 KHz is not scanned.

Entering ClearScan

1. Press and hold <MENU> + <SET> for 3 seconds. The following screen will appear:

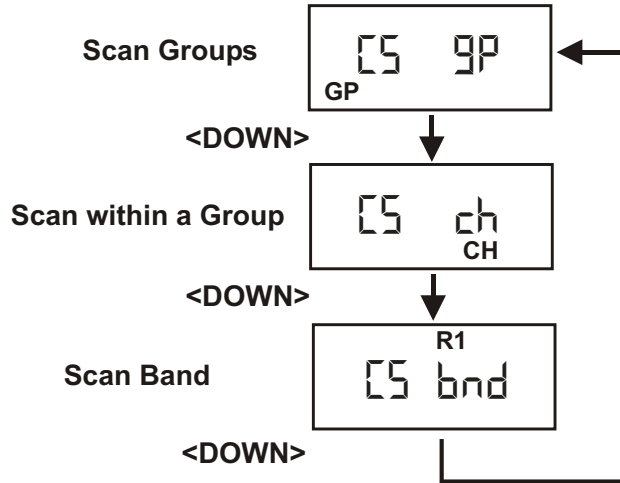

Figure 7-8
ClearScan Menus

2. Use the <DOWN> arrow button to select the type of ClearScan desired.
 3. Push <SET> to start the ClearScan.
 4. Scan Groups
 - a. After the scan is done the group icon will be flashing. The left side of the screen will display the group. The right side of the screen will display the number of receive channels clear in that group.
 - b. Use the <UP>/<DOWN> arrows buttons to select a group, then push <SET> to set the group and start the channel scan within that group.
 - c. After the scan within a group use the <UP>/<DOWN> to select a channel.
 - d. Hit <SET> to set the channel. The unit will now be set to the group selected earlier and the receive channel just selected.
- NOTE:** The transmit channel will be the one in that group that the unit was already set to. The ClearScan of the base station would select the best beltback transmit channels to use.
5. Scan with in a Group
 - a. After the scan is done the channel icon will be flashing. The right side of the screen will display the best channel in the group. Use the <UP>/<DOWN> arrows buttons to select a channel, then push <SET> to set the channel.

6. Scan Band
 - a. Push <SET> to stop the scan band searching. The unit will sort the result and display the top 20 clear frequencies.
 - b. Use the <UP>/<DOWN> arrows to select a frequency then push <SET>.
 - c. The receive frequency is placed in user group 63u.

NOTE: The transmit frequency will not be in group 63u. The frequency to enter for transmit would be the result a base station scan band.

Lock Out

This function allows the user to lock the top panel and menu options. The talk button and A, B and C presets button will still work but the C and talk button mode can not be changed. Likewise the values and screen in the beltback can be viewed but not changed.

Enabling / Disabling Lock Out

1. Press and hold the <UP> and <DOWN> buttons for three seconds. The word "SECURE" will appear on the screen when lock out is active.
2. Press and hold the and button for three seconds again to disable lock out. The work "ACCESS" will appear.

1st Use

This function sets the beltback to Group 1, channels A and 1 and leaves any user defined groups in memory. It will set unit to factory defined menu settings. It will also set the "Talk" and "C" button to their default modes.

Activating 1st Use

1. Press and hold the <MENU> button as powering-up the beltback.

Factory Reset

This function sets the beltback to Group 1, channels A and 1 and **ERASES** any user defined groups in memory. It will set unit to factory defined menu settings. It will also set the "Talk" and "C" button to their default modes.

Activating 1st Use

1. Press and hold the <MENU> + <SET> + <UP> + <DOWN> for three seconds.

TR-1 Beltpack Screen Flowchart

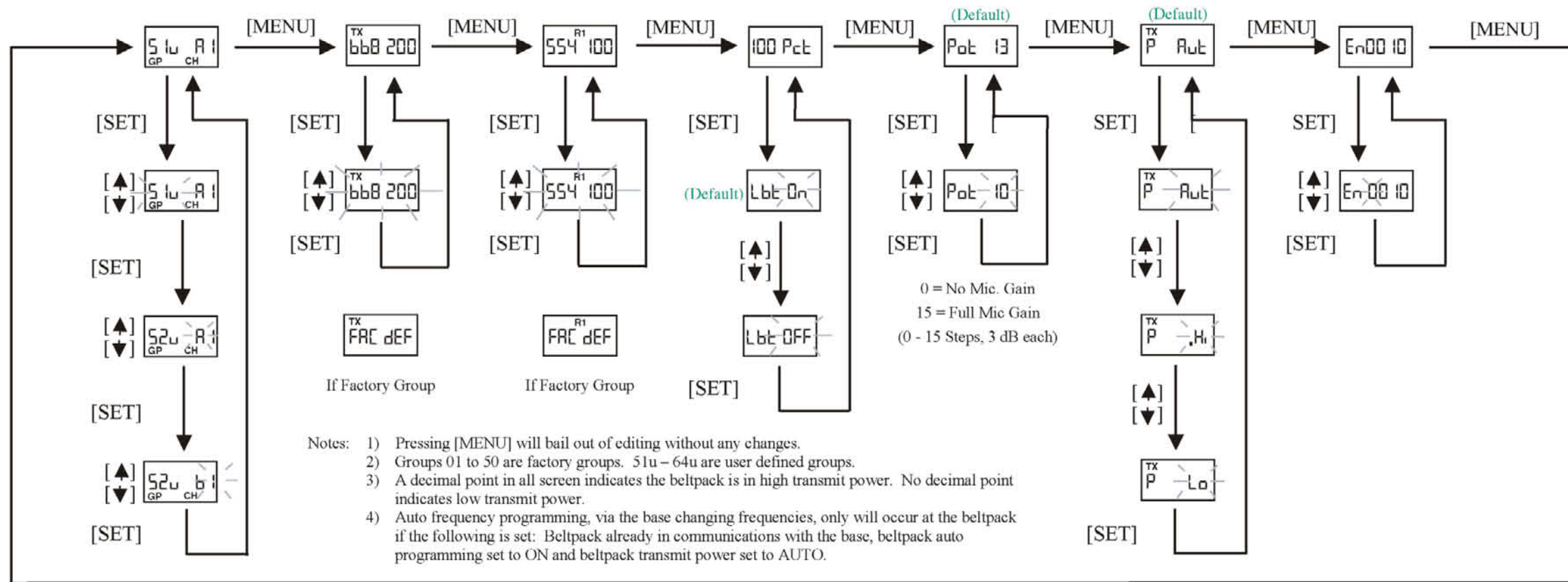

Software / Ch Maps	Talk Button	“C” Button	Clear Scan	Serial Number Set	Lock Out	1 st Use	Factory Reset	Auto Program
Hold [▼] for 3 seconds 5 10 044 Release [▼] 200 00 1 Displayed for 2 seconds 400 00 1 Displayed for 2 seconds Then back to last menu screen	Hold [SET] and hit Talk (Default) 5b LARt Hit Talk 5b OFF Hit Talk 5b PLEt Hit Talk	Hold [SET] and hit “C” (Default) c PLEt Hit “C” c LARt Hit “C” c Eb Hit “C” c OFF Hit “C” c t PLEt Hit “C” c t LARt	Hold [MENU] + [SET] for 3 seconds Scan for Best Gp. [5 GP 9P] [▼] Scan for Best Ch. [5 ch CH] [▼] Scan Band [5 R1 bnd] [▼]	Must be in Encrypt Set Screen [MENU] + [▲] for 3 seconds [▲] 5n 1050 [▼] [SET] After last number is set it defaults back to Encrypt Screen	Hold [▲] + [▼] for 3 seconds to lock 5Ec urE Hold [▲] + [▼] for 3 seconds to unlock ACC ESS During Lock if [SET] hit Loc Out	Hold [MENU] as Powering-up Unit Sets unit to Gp 01, Ch A1 All user settings kept	Hold [MENU] + [SET] + [▲] + [▼] for 3 seconds Sets unit to Gp 01, Ch A1 All user settings erased Set to factory defaults	Hit [▲] for 3 seconds [▲] RULt On [▼] [SET] (Default) [▼] RULt OFF

Figure 8-1 TR-1 Menu Structure

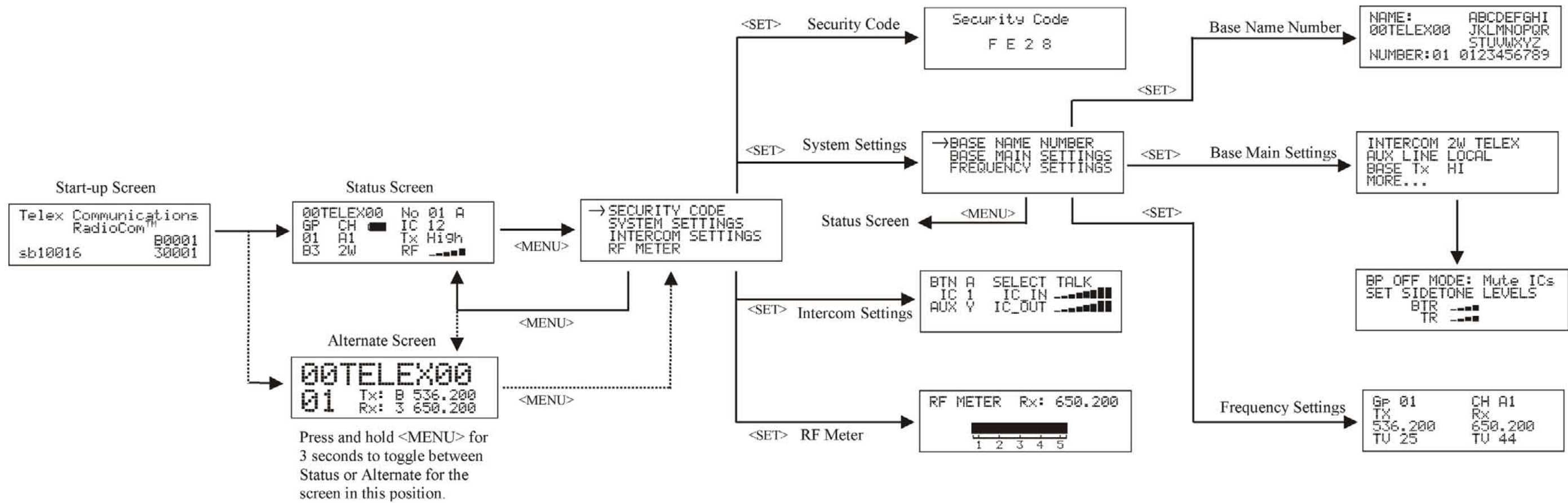

NOTE: Pressing <MENU> once, after setting parameters in a non-menu screen, returns the unit to the status or alternate screen.

Figure 9-1
BTR-1 Menu Structure

Section 10 Frequency Bands

Frequency Bands

The BTR-1 system operates in TV channels 16 to 36 and 38 to 59. This is the frequency range of 482 to 608 MHz and 614 MHz to 746 MHz. The band, TV channels and frequencies are shown in Table 2. Most bands are 18 MHz wide, however band 7 is 24 MHz wide.

Bands F to E are always base transmit bands (beltpack receive bands). Bands 1 to 7 are always base receive bands (beltpack transmit bands). Thus an A2 base station would be comprised of an A band transmitter paired with a 2 band receiver.

Band Pairing for Systems

All band pairs cannot be made into a system (a single system is comprised of a base and beltpack). Table 1 show the available band pairings.

Base TX Bands	Base RX Bands
F	1, 2, 3, 4, 5, 6, 7
H	1, 2, 3, 4, 5, 6, 7
A	2, 3, 4, 5, 6, 7
B	3, 4, 5, 6, 7
C	4, 5, 6, 7
D	5, 6, 7
E	6, 7

**Table 1
Available Band Pairings**

In Table 1 it can be seen that a C base station transmit band can be paired with 4, 5, 6 or 7 receive bands. However, a C3 unit cannot be made. This is because a certain amount of frequency separation between transmit and receive bands is required for good transmit and receive operation. If they are too close the RF performance of the system is reduced.

Band	TV	Freq. Start	Freq. End
F	16	482	488
	17	488	494
	18	494	500
H	19	500	506
	20	506	512
	21	512	518
A	22	518	524
	23	523	530
	24	530	536
B	25	536	542
	26	542	548
	27	548	554
C	28	554	560
	29	560	566
	30	566	572
D	31	572	578
	32	578	584
	33	584	590
E	34	590	596
	35	596	602
	36	602	608
Not Used	37	608	614
1	38	614	620
	39	620	626
	40	626	632
2	41	632	638
	42	638	644
	43	644	650
3	44	650	656
	45	656	662
	46	662	668
4	47	668	674
	48	674	680
	49	680	686
5	50	686	692
	51	692	698
	52	698	704
6	53	704	710
	54	710	716
	55	716	722
7	56	722	728
	57	728	734
	58	734	740
	59	740	746

**Table 2
Band Names and TV Channels**

Factory Group Plan

There are 50 factory defined groups in a base station and beltack. These group are organized in different ways to provide flexibility to the user on selecting frequencies. A group is composed of intermodulation free frequencies, but a group is also organized to be composed of frequencies in different combinations of the TV channels. The user then can select a group that is clear of broadcast TV channels in the area by selecting a group(s) that doesn't use those channels.

Table 3 indicates how the factory defined groups use the three TV channels for transmit and 3 TV channels for receive. A shaded TV channel indicates the group has frequencies in that channel. The white TV channel indicates the group has no frequencies in that TV channel. Group 1 uses at least one frequency from each of the three TV channels for TX and RX. However group 50 uses only the third TV channel for TX and RX.

Group	Base TX Freq.			Base RX Freq.		
	TV1	TV2	TV3	TV4	TV5	TV6
1	Shaded	Shaded	Shaded	Shaded	Shaded	Shaded
2	Shaded	Shaded	Shaded	Shaded	Shaded	Shaded
3	Shaded	Shaded	Shaded	Shaded	Shaded	Shaded
4	Shaded	Shaded	Shaded	Shaded	Shaded	Shaded
5	Shaded	Shaded	Shaded	Shaded	Shaded	Shaded
6	Shaded	Shaded	Shaded	Shaded	Shaded	Shaded
7	Shaded	Shaded	Shaded	Shaded	Shaded	Shaded
8	Shaded	Shaded	Shaded	Shaded	Shaded	Shaded
9	Shaded	Shaded	Shaded	Shaded	Shaded	Shaded
10	Shaded	Shaded	Shaded	Shaded	Shaded	Shaded
11	Shaded	Shaded	Shaded	Shaded	Shaded	Shaded
12	Shaded	Shaded	Shaded	Shaded	Shaded	Shaded
13	Shaded	Shaded	Shaded	Shaded	Shaded	Shaded
14	Shaded	Shaded	Shaded	Shaded	Shaded	Shaded
15	Shaded	Shaded	Shaded	Shaded	Shaded	Shaded
16	Shaded	Shaded	Shaded	Shaded	Shaded	Shaded
17	Shaded	Shaded	Shaded	Shaded	Shaded	Shaded
18	Shaded	Shaded	Shaded	Shaded	Shaded	Shaded
19	Shaded	Shaded	Shaded	Shaded	Shaded	Shaded
20	Shaded	Shaded	Shaded	Shaded	Shaded	Shaded
21	Shaded	Shaded	Shaded	Shaded	Shaded	Shaded
22	Shaded	Shaded	Shaded	Shaded	Shaded	Shaded
23	Shaded	Shaded	Shaded	Shaded	Shaded	Shaded
24	Shaded	Shaded	Shaded	Shaded	Shaded	Shaded
25	Shaded	Shaded	Shaded	Shaded	Shaded	Shaded
26	Shaded	Shaded	Shaded	Shaded	Shaded	Shaded
27	Shaded	Shaded	Shaded	Shaded	Shaded	Shaded
28	Shaded	Shaded	Shaded	Shaded	Shaded	Shaded
29	Shaded	Shaded	Shaded	Shaded	Shaded	Shaded
30	Shaded	Shaded	Shaded	Shaded	Shaded	Shaded
31	Shaded	Shaded	Shaded	Shaded	Shaded	Shaded
32	Shaded	Shaded	Shaded	Shaded	Shaded	Shaded
33	Shaded	Shaded	Shaded	Shaded	Shaded	Shaded
34	Shaded	Shaded	Shaded	Shaded	Shaded	Shaded
35	Shaded	Shaded	Shaded	Shaded	Shaded	Shaded
36	Shaded	Shaded	Shaded	Shaded	Shaded	Shaded
37	Shaded	Shaded	Shaded	Shaded	Shaded	Shaded
38	Shaded	Shaded	Shaded	Shaded	Shaded	Shaded
39	Shaded	Shaded	Shaded	Shaded	Shaded	Shaded
40	Shaded	Shaded	Shaded	Shaded	Shaded	Shaded
41	Shaded	Shaded	Shaded	Shaded	Shaded	Shaded
42	Shaded	Shaded	Shaded	Shaded	Shaded	Shaded
43	Shaded	Shaded	Shaded	Shaded	Shaded	Shaded
44	Shaded	Shaded	Shaded	Shaded	Shaded	Shaded
45	Shaded	Shaded	Shaded	Shaded	Shaded	Shaded
46	Shaded	Shaded	Shaded	Shaded	Shaded	Shaded
47	Shaded	Shaded	Shaded	Shaded	Shaded	Shaded
48	Shaded	Shaded	Shaded	Shaded	Shaded	Shaded
49	Shaded	Shaded	Shaded	Shaded	Shaded	Shaded
50	Shaded	Shaded	Shaded	Shaded	Shaded	Shaded

Table 3
Groups and TV Channel Used
Shaded = TV used,
Not Shaded = TV not used.

Section 11 Troubleshooting

Reread the sections of this manual to make sure you have completed system set-up properly.

If you are unable to solve the problem, contact the dealer from whom you purchased the system for assistance.

PROBLEM	SOLUTION
DISTORTION - System's audio quality seems distorted at medium to high input levels.	Reduce microphone gain by adjusting microphone gain control.
HISS - System seems to produce a "hiss" which is undesirable.	Check the gain setting on all beltacks and the base station. They may be too low or too high. Check to make sure you are still well within range of the base station
LOW OUTPUT - System produces a low output level.	Check the gain setting on both the beltacks and the base station. They may be too low.
FEEDBACK - Moving around area of use produces "squeal" or "howl" in various locations using ext. speakers.	Reduce the gain settings on both the beltacks and the base station. They may be too high. If in the 2W Mode, the intercom channel you are on maybe unloaded.
DROPOUTS - When moving around the area of use there seems to be locations where the signal "swooshes" or completely disappears.	Make sure both antennas on the base station and beltack are connected and follow the location suggestions. Change the location of the base station and antennas or avoid the bad areas with the beltacks.
NO AUDIO from BASE STATION or BELTPACK headsets.	Check talk LED to make sure is is on. Make sure beltack batteries are OK. Make sure the base station and the beltack serial number and encryption codes all match.

Section 12 Battery Information

Improper battery selection, use, installation and care are the cause of numerous wireless system failures.

Alkaline Batteries: Alkaline batteries such as Mallory's DURACELL® or Eveready's ENERGIZER® provide the most reliable operation in wireless transceivers.

The use of low cost carbon-zinc batteries is NOT recommended.

Nickel-Metal Hydride Batteries: These batteries can save you money in the long run, as they can be recharged. Typical battery life is about 90% of the length of time alkaline batteries last.

Cold Temperatures and Batteries

The battery life times listed in this section are at room temperature. Alkaline and Nickel-Metal Hydride batteries service hours falls off significantly at low temperatures due to battery chemistry. Alkaline batteries typically have less than half their room temperature service life if used at freezing 32° F (0° C). Due to the service hours reduction of Alkaline and Nickel Metal Hydride batteries at low temperature the user will need to change batteries more often.

Another solution is using Lithium AA cells if backpacks are to be used in very cold temperatures. Lithium batteries, like the Energizer® E² Lithium AA cells, are excellent batteries at cold temperatures. At the temperatures of 15° F (-9° C), Lithium AA cells will last about 7 times longer than Alkaline batteries. that equates to 2 hours for Alkaline vs 14 hours for Lithiums. However, the tradeoff is Lithiums cost more and are less friendly to the environment than alkalines.

Battery Life:

TR-1

Alkaline, 8-10 hours typical

Nickel Metal Hydride, 7-9 Hours typical

WARNING:

Do not place an alkaline TR battery pack in any battery charger. Severe charger and battery pack damage may result.

Section 13

2-Wire Systems Specifications

<p>RTS</p> <p>Input Impedance:.....200Ω</p> <p>Output Level:.....0.775 Vrms nominal</p> <p>Bridging Impedance:.....>10kΩ</p> <p>Call Signaling:</p> <p> Send:20kHz 100 Hz, 240 mVrms</p> <p> Receive:20kHz 800 Hz, 100 mVrms</p> <p>Power Voltage:28.0 VDC nominal</p>	
---	--

<p>AudioCom/Telex</p> <p>Input Impedance:.....300Ω</p> <p>Output Level:.....1.0 Vrms nominal</p> <p>Bridging Impedance:.....>10kΩ</p> <p>Call Signaling:</p> <p> Send:20kHz 100 Hz, 05 mVrms</p> <p> Receive:20kHz \pm800 Hz, 100 mVrms</p> <p>Power Voltage:24.0 VDC nominal</p>	
---	--

<p>Clear-Com</p> <p>Input Impedance:.....200Ω</p> <p>Output Level:.....1.0 Vrms nominal</p> <p>Bridging Impedance:.....>10kΩ</p> <p>Call Signaling:</p> <p> Send:.....12 3 VDC</p> <p> Receive:4 VDC Minimum</p> <p>Power Voltage:30.0 VDC nominal</p>	
---	--

FCC LICENSING

The Telex BTR-1 and the TR-1 Transmitter/Receiver are Type Accepted under United States Federal Communications Commission Part 74. Licensing of Telex equipment is the User's responsibility and licensibility depends on the user's classification, users application, and frequency selected. Telex strongly urges the user to contact the appropriate telecommunications authority for any desired clarification.

This device complies with part 15 of the FCC Rules. Operation is subject to the condition that this device does not cause harmful interference.

CAUTION: Changes or modifications made by the user could void the user's authority to operate the equipment.

End-User License Agreement for Telex® Software

IMPORTANT - Please read this document carefully before using this product.

THIS DOCUMENT STATES THE TERMS AND CONDITIONS UPON WHICH TELEX COMMUNICATIONS, INC. (the "COMPANY") OFFERS TO LICENSE THE INSTALLED SOFTWARE OR PROGRAM (the "SOFTWARE") FOR USE WITH THE PRODUCT IN WHICH IT WAS INSTALLED. YOU ARE AGREEING TO BECOME BOUND BY THE TERMS OF THIS AGREEMENT. IF YOU DO NOT AGREE TO THE TERMS OF THIS AGREEMENT, DO NOT USE THIS PRODUCT. PROMPTLY RETURN THE PRODUCT TO THE PLACE WHERE YOU OBTAINED IT FOR A FULL REFUND.

The installed software as supplied by the Company is licensed, not sold, to you for use only under the terms of this license, and the Company reserves all rights not expressly granted to you. You own the product or other media on or in which the Software is originally or subsequently recorded or fixed, but the Company retains ownership of all copies of the Software itself.

1. License: This license allows you to use the Software for internal purposes only on a single product in which it was installed.
2. Restrictions: (a) You may not market, distribute or transfer copies of the Software to others or electronically transfer or duplicate the software. YOU MAY NOT REVERSE ENGINEER, DECOMPILE, DISASSEMBLE, MODIFY, ADAPT, TRANSLATE, RENT, LEASE OR LOAN THE SOFTWARE OR CREATE DERIVATIVE WORKS BASED ON THE SOFTWARE OR ANY ACCOMPANYING WRITTEN MATERIALS. (b) The Software and the accompanying written materials are copyrighted. Unauthorized copying of the Software, including portions thereof or the written materials, is expressly forbidden. (c) You understand that the Company may update or revise the Software and in so doing incurs no obligation to furnish such updates to you.
3. Limited Warranty: The company does not warrant that the operation of the Software will meet your requirements or operate free from error. The company DISCLAIMS ALL OTHER WARRANTIES AND CONDITIONS EITHER EXPRESS OR IMPLIED, INCLUDING THE WARRANTIES OF MERCHANTABILITY, FITNESS FOR A PARTICULAR PURPOSE AND NON-INFRINGEMENT OR THIRD PARTY RIGHTS.
4. Limited Liability: The liability of the company for any claims arising out of this License based upon the Software, regardless of the form of action, shall not exceed the greater of the license fee for the Software or \$50.

Section 16

Accessories and Replacement Parts

ALP-600

480-800 MHz Bi-Directional Log Periodic Antenna Includes mounting hardware and 10 feet (3 meters) of coaxial cable with TNC Connectors

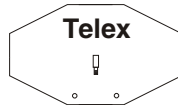

P N. 878896

ALP-450

450-900 MHz Log Periodic Antenna Includes mounting hardware and 10 feet (3 meters) coaxial cable with TNC connectors



Order No. 71147000

Antenna Cables

Special low loss antenna cables with TNC Connectors

Model No.	Length	Order No.
CXU-2	2 Ft. (.7 meter)	691459-8
CXU-10	10 Ft. (3 meter)	690419
CXU-25	25 Ft. (7.6 meter)	71151-025
CXU-50	50 Ft. (15 meter)	71151-050
CXU-75	75 Ft. (23 meter)	71151-075
CXU-100	100 Ft. (30 meter)	71151-100

Base Station's 1/2-Wave Antennas

Model No.	Part No.	Band Color	Frequency
CLA-1	870658-1	Blue	520-565 MHz
CLA-2	870658-2	Yellow	565-615 MHz
CLA-3	870658-3	Red	615-660 MHz
CLA-4	870658-4	White	560-690 MHz
CLA-5	870658-5	Green	690-725 MHz
CLA-6	870658-6	Orange	725-760 MHz
CLA-10	870658-10	Tan	470-518 MHz
CLA-11	870658-11	Pink	515-548 MHz
CLA-12	870658-12	Brown	542-575 MHz

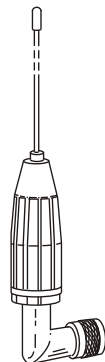

AB-2

Bracket for 1/2 wave Antenna with 10 ft. of coax-

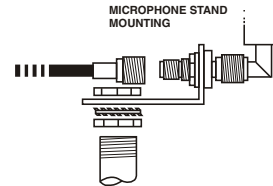

PN 71138000

BTR Power Supply

12 VDC, 1 AMP879963

BTR Power Cords

U.S./Canada 600092

BTR XLR Intercom Dummy Load

Telex type878935

RTS type878990

TR LCD/ switch cover450364

Loop Thru Patch Cable690523

2 Pin Relay Connector2862046

BP-700 TR Battery pack, alkaline

(batteries not included).....71315-000

BP-700NM TR Nickel Metal Hydride

Battery pack71315-001

BC-1NM4

Four Slot "Smart" Charger with Four Nickel Metal Hydride Battery Packs

U.S./Canada301778400

Euro301778401

BC-1NM

Single Slot "Smart" Charger with Nickel Metal Hydride Battery Pack

U.S./Canada301778100

Euro301778101

Beltpack's 1/4-wave antenna

Part No.	Color Dot	Frequency
879220-1	Violet	425-485 MHz
879220-2	Black	485-556 MHz
879220-3	Yellow	556-636 MHz
879220-4	Green	636-726 MHz
879220-5	Red	726-826 MHz

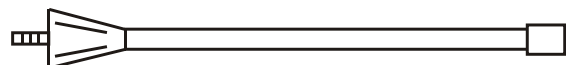

TELEX[®]

TELEX COMMUNICATIONS, INC. • 12000 Portland Ave. South, Burnsville, MN 55337.

PN 803959 REV B

March 2005

Made in U.S.A.