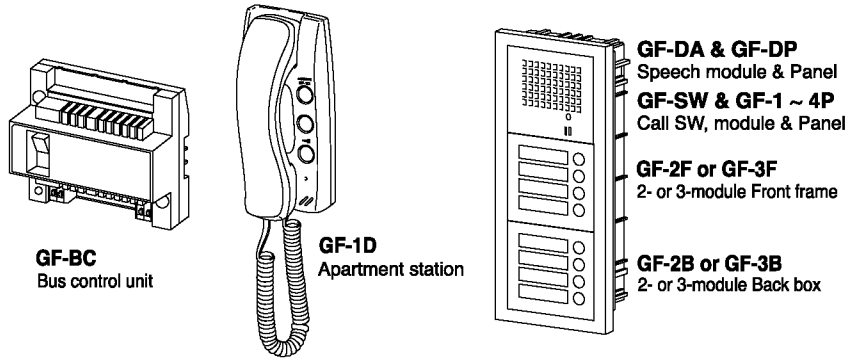

TWO-WIRE BUS APARTMENT SYSTEM**GF SYSTEM****INSTALLATION MANUAL**

This Manual is enclosed in GF-BC, Bus Control Unit box. Operation Manual is enclosed in GF-1D Apartment Station box.

Before actually installing the equipment, the contents of this Manual must be thoroughly read and understood.

After installation, please keep the Installation Manual, containing instructions for wiring & programming, as well as WARRANTY.

**Precautions on Installation & Wiring**

 **WARNING** (Negligence could result in death or serious injury to people)







 **CAUTION** (Negligence could result in injury to people or damage to property)

 **General Prohibitions**



 **Prohibitions to subject the unit to water**

 **Prohibitions to dismantle the unit**

 **WARNING**

1. These devices are electrical. Wiring must be performed by qualified personnel. 
2. Do not modify or alter the equipment. 
3. Do not connect any power source other than specified to terminals +, -. Doing so may cause fire or damage the unit. 
4. The equipment must not be exposed to water or any other liquid. 
5. Make sure wires are connected properly before plugging the power supply into an electrical outlet. 
6. AC outlet must be away from moisture and dust. 

 **CAUTION**

1. Do not install or make any wire terminations while power supply is plugged in, or it could cause electrical shock or damage the unit. 
2. Mount the intercom on wall in a convenient location, but not where it could be bumped or jarred.
3. Do not install the unit in any of the following locations, as it may cause the system to malfunction:
 - **High or extreme cold temperature area:**
under direct sunlight, near equipment that varies in temperature, in front of air-conditioner, inside a refrigerated area, etc.
 - **Places subject to moisture or humidity extremes.** 
 - **Places subject to environmental conditions,** such as oil, dust, chemicals, salt, etc.
 - **Places subject to constant vibration or impact.**

GENERAL PRECAUTIONS

1. The equipment, except the entrance station, is designed for indoor use only. Do not install them outdoors.
2. The system is not operable during a power failure.
3. In areas where broadcasting station antennas are close by, intercom system may be affected by radio frequency interference.
4. Keep all wiring at least 30cm, 1' away from AC100 ~ 240V wiring, fluorescent lighting, or dimmer switches. Otherwise, cross AC wiring at a 90° angle.

SYSTEM COMPONENTS

Apartment station — Bus control unit & Power supply

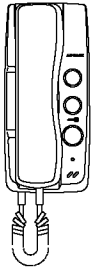

OPTION



Doorbell Button

GF-1D
Apartment station

- Packet of screws
- OPERATION MANUAL

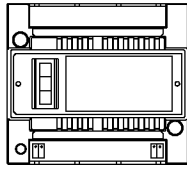

GF-BC
Two-wire Bus control unit

- Packet of screws
- INSTALLATION MANUAL
- Hexagonal wrench

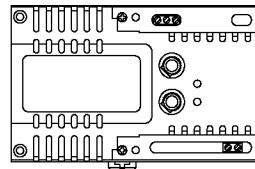

PS-24ME (AC 230V)
Power supply

- Packet of screws
- DIN rail
- Terminal cover
- Fuse

PS-2410LC (AC 120V)
PS-2410LD (AC 230V)

OPTION

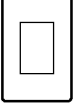

MAW-B
Relay for external light

Entrance station

FRONT FRAME

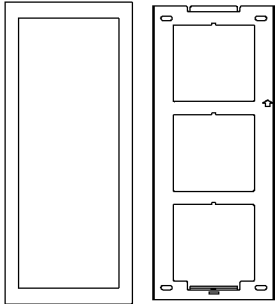

GF-3F
3-module front frame

- Mounting bracket
- Packet of screws
- Weather stripping (for reinforcement)

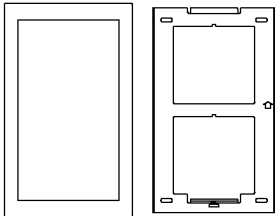

GF-2F
2-module front frame

- Mounting bracket
- Packet of screws
- Weather stripping (for reinforcement)

OPTION

GF-H Rain hood
GF-C 80cm (3-1/8") connecting wire

PANEL

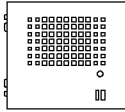

GF-DP
Panel only

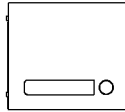

GF-1P
1-call button panel

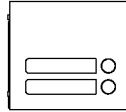

GF-2P
2-call button panel

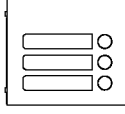

GF-3P
3-call button panel

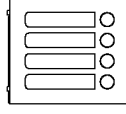

GF-4P
4-call button panel

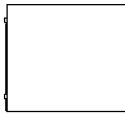

GF-BP
Blank panel

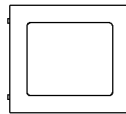

GF-AP
Address panel

MODULE

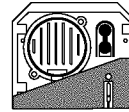

GF-DA
Speech module

- Connector

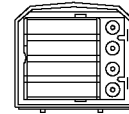

GF-SW
Call switch module

- Directory card (plate & paper)
- Connector

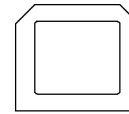

GF-AD
Address module

- Directory card (plate & paper)
- Connector

BACK BOX

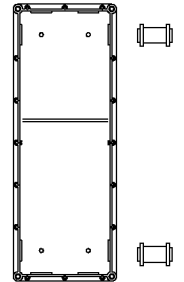

GF-3B
3-module back box

- Packet of screws
- Joint pipe (x 2)
- Metal plate

Do not discard.

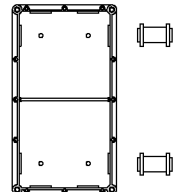

GF-2B
2-module back box

- Packet of screws
- Joint pipe (x 2)
- Metal plate

Do not discard.

Open a hole in the wall for mounting back box (es).

It is suggested to mount the back box at the height of 150cm (5') (up to box center). Allow a space of 2mm (1/8") or more on each side of back box in the wall.

EXAMPLES

- Two-module back boxes (x2)
- Three-module back boxes (x3)

Joint pipe (ea.2)

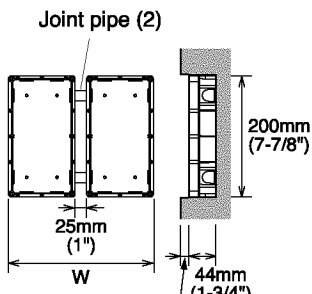

Mount back box not more than 15mm (1/2") in recess.

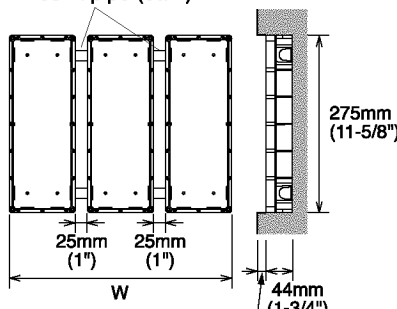

Mount back box not more than 15mm (1/2") in recess.

BACK BOX DIMENSIONS

- Module back boxes assembled

Back boxes	W (mm)	W (inch)
One row	110	4-5/16"
Two rows	245	9-5/8"
Three rows	380	15"
Four rows	515	20-1/4"
Five rows	650	25-9/16"
Six rows	785	30-7/8"
Seven rows	920	36-1/4"
Eight rows	1055	41-9/16"
Nine rows	1190	46-1/8"

For best results, the back box(es) must be mounted strictly horizontally.

MOUNTING ENTRANCE STATION

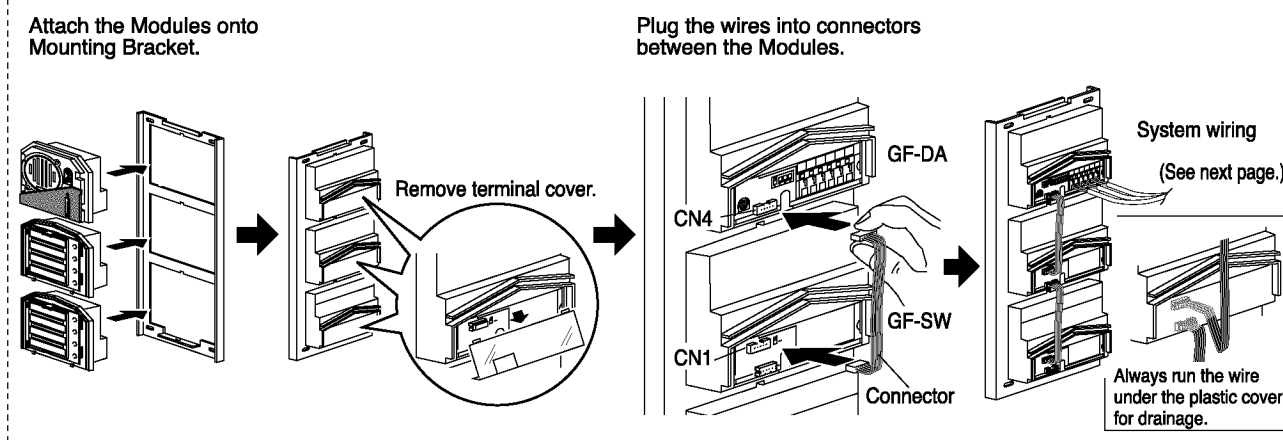
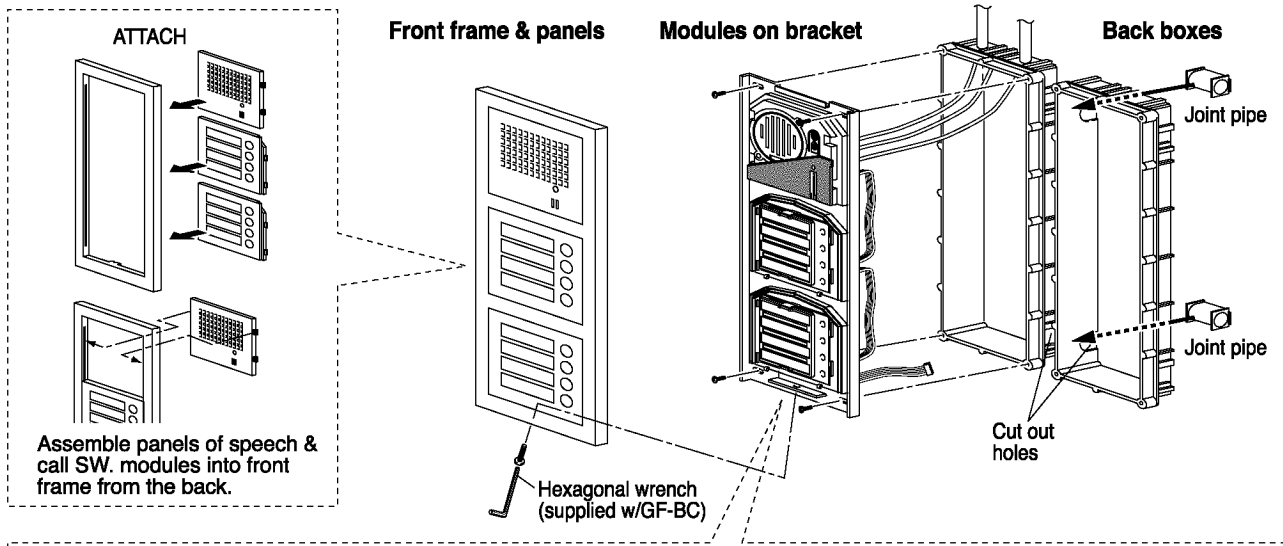

Interconnecting Modules with Plug-in Connectors

As shown, the Modules must be connected in a daisy-chained manner.

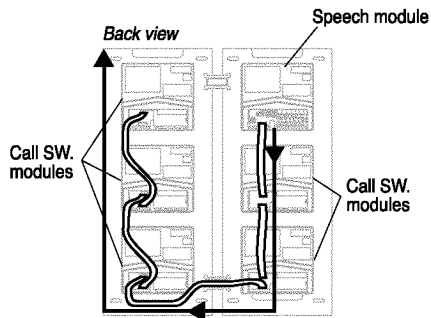

1 Connect the Modules as shown in drawings.

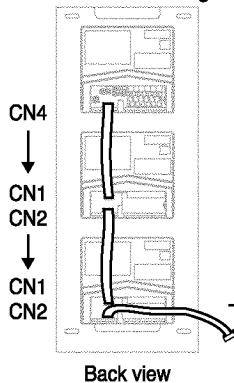

2 Pass the connecting wire through joint pipe (pre-opened), and plug to CN1 of Call SW. of next row.

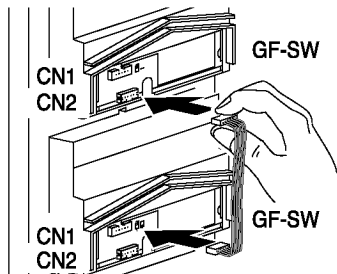
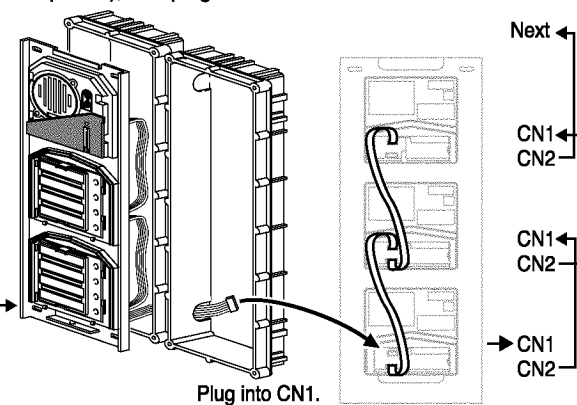

Locating Speech module (GF-DA) in the middle row

GF-C, 80cm(3-1/8") connecting wire

In advance, pass a 80cm(3-1/8") long connecting wire through joint pipes.

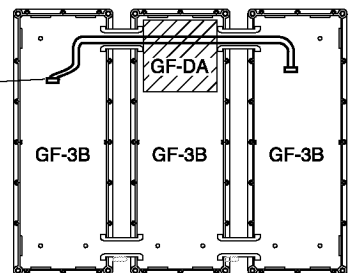

MOUNTING & WIRING

GF Entrance Station

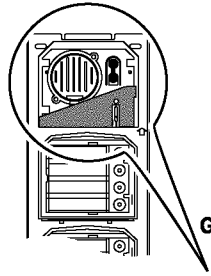

(Entrance station #1)
GF-DA Speech Module
Back view

SETTING

Entrance # SET switches

To set for Entrance stations #1 ~ 5, set DIP switches on Speech Module (GF-DA) as shown below. All the Entrance stations will malfunction if positioned in any other manner.

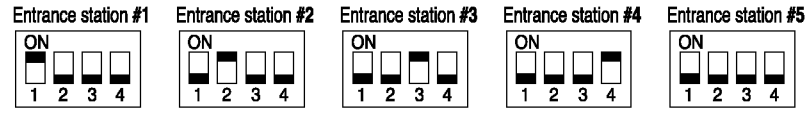

Shipped in "#1" position.

Door release timer

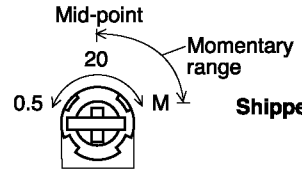

Shipped in "Momentary" position.

0.5	0.5 sec. duration;	Turn counterclockwise completely.
-	0.5 ~ 20 sec. duration;	Turn clockwise to obtain longer second of duration.
20	20 sec. duration;	Turn up to the mid-point.
M	Momentary activation(*);	Turn to any point between 20 - M.

(*) Activated as long as the door release button is held down.

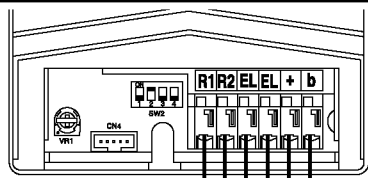
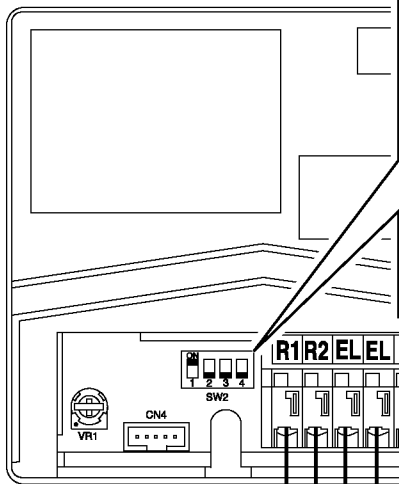

(Entrance station #2)
GF-DA
Speech Module
Back view

5P connector
from upper socket
of a module below

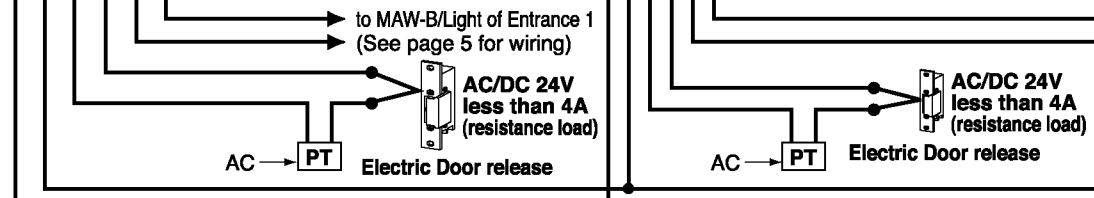

PT: Power transformer

Put a conductor into insert-lock terminals.

*To release a conductor, press UNLOCK button, then pull the conductor.

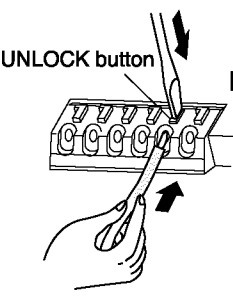

When mounting multiple rows of panels, attach the metal plates and tighten screws on the brackets.

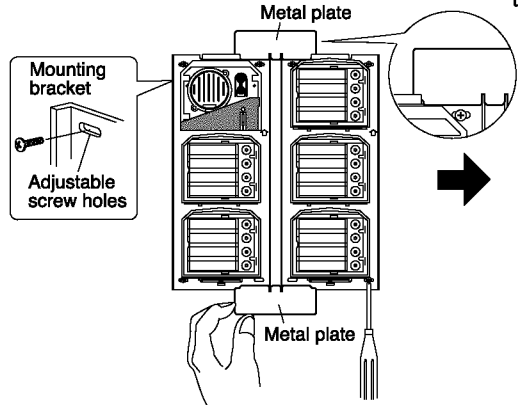

After wiring & setting, mount the module-mounted bracket to back box. Finally, attach front frame/panel to the bracket.

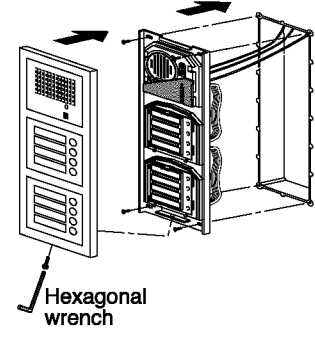

Light

APARTMENT
(See next page.)

To next apartments

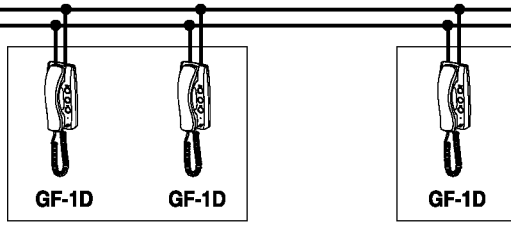
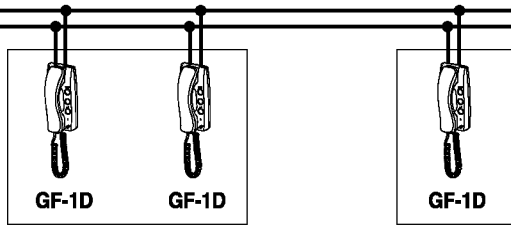

NP

To next apartments

GF-1D

GF-1D

GF-1D

GF-1D

GF-1D

GF-1D

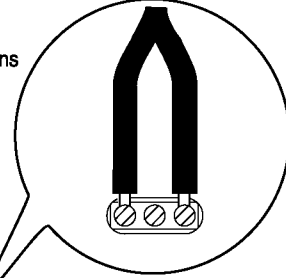

AC power line

AC 230V input

CONTROL UNIT & POWER SUPPLY

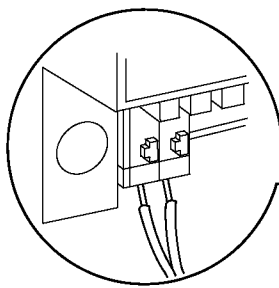

GF-BC

PS-24ME

DC 24V, 0.9A output

+

-

R1

R2

Red (+)

Black (-)

White

Blue (unused)

Option

MAW-B Relay

Junction point

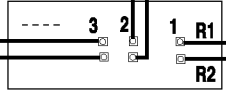

NP

Light control

Orange

Orange

TIMER

AC

For controlling light at the entrance, use Aiphone's MAW-B relay, which provides dry closure contact.

MOUNTING

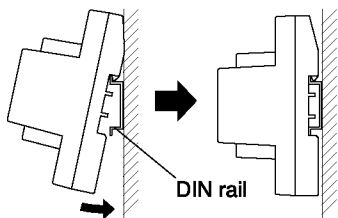

DIN rail for GF-BC:
W-DIN11 available from Aiphone

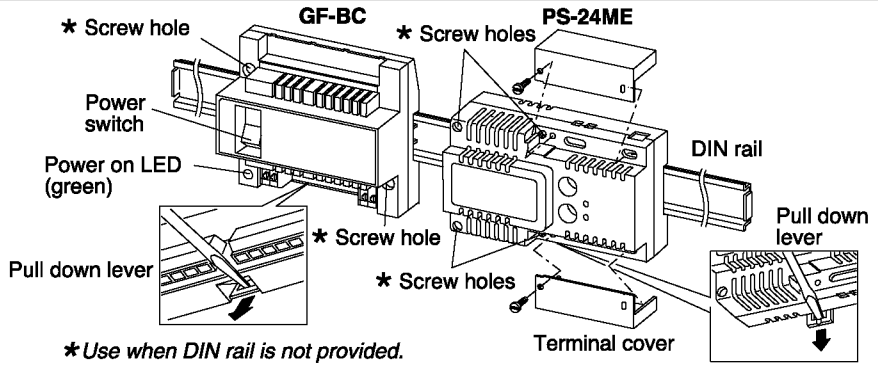

* Use when DIN rail is not provided.

HOW TO RESET BREAKER (Power switch)

When system malfunctions, check the wiring. Check the fuse of power supply. Turn off the power switch of GF-BC and turn on again, resetting the whole system operation.

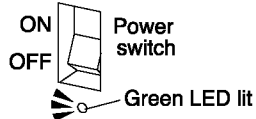

SETTING UP SYSTEM

Prior to setting up GF system, make sure all the stations have been installed and wired in proper manner. Leave the front frame & module panels unattached.

Step 1 Press PROGRAM switch on GF-DA Speech Module.

Turn on power switch of GF-BC.

Power switch (Breaker)

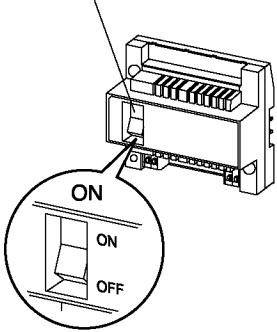

When front panels are already mounted, open unscrewing the bottom screw.

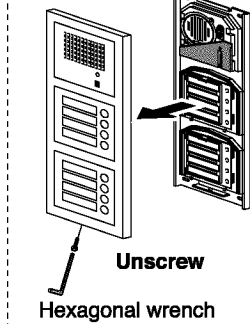

Hexagonal wrench

Open the rubber cap. Then push PROGRAM SW. momentarily.

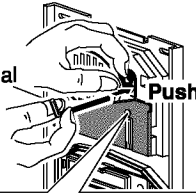

In-use LED

Wait for approx. 15 sec. and see the LED steadily lit.

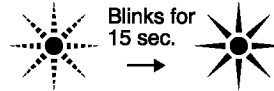

Note: At the rest Entrance stations, the in-use LED is steadily lit and blocks out any calling.

SETTING FOR "LIGHT" button (OPTION)

In-use LED



While In-use blinks (within 15 sec.), press an assigned call button.

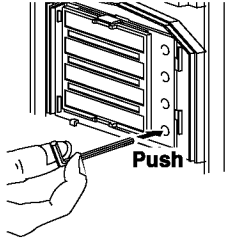

BEEP tone

→ **LIGHT button is set.**
(Turns on entrance light, controlled by MAW-B relay.)

Step 2 At an Apartment station #1, lift handset. Communication channel is established with Entrance station instantly. Hearing single BEEP tone means the station correctly set. Hang up handset.

Apartment station #1

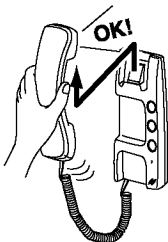

Entrance station

BEEP TONE

→ Call button 1 - Apartment 1 is set.

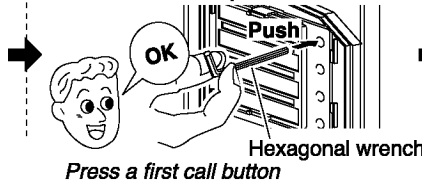

Press a first call button

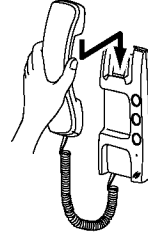

For a second station, if installed, lift second handset and press the same call button 1. Beep tone sounds twice.

Second Apartment station #1

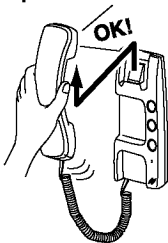

Entrance station

DOUBLE BEEP TONE

→ Call button 1 - Apartment 1 - 2 is set.



Press a first call button

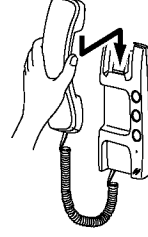

Step 3 Go to each apartment consecutively, and program each handset station in the same manner as in Step 2.

Step 4 When completed, press PROGRAM switch on GF-DA Speech Module again to finish the programming.

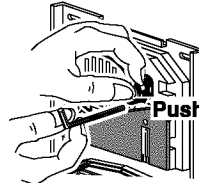

Do not forget to replace the rubber cap.

To correct wrong setting

Apartment station
Lift handset.

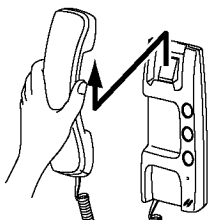

Entrance station

Keep pressing a call button to clear until a continuous tone is heard.
(Consecutively, operate same way for next call button, if any)

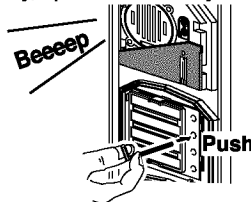

Following Step 2,
Reset on apartment station(s) that have been cleared.

For 2-station apartment

- Clearing a call button cancels programming for two stations, correctly set or not. Individually reprogram both stations.

TECHNICAL PRECAUTIONS

- Temperature** GF Entrance station: $-10^{\circ}\text{C} \sim +60^{\circ}\text{C}$ ($+14^{\circ}\text{F} \sim +140^{\circ}\text{F}$).
 GF-BC: $0^{\circ}\text{C} \sim +40^{\circ}\text{C}$ ($+32^{\circ}\text{F} \sim +104^{\circ}\text{F}$).
 GF-1D: $0^{\circ}\text{C} \sim +40^{\circ}\text{C}$ ($+32^{\circ}\text{F} \sim +104^{\circ}\text{F}$).
- Rain hood (option)** GF Entrance station is weather-resistant, but for best results, it should be protected from direct weather conditions. Install a rain hood (GF-H) to protect it from direct rainfall.
- Filling in name & address** Fill in directory or address on the transparent plate with an oil-soluble pen, etc. and attach the plate to module.

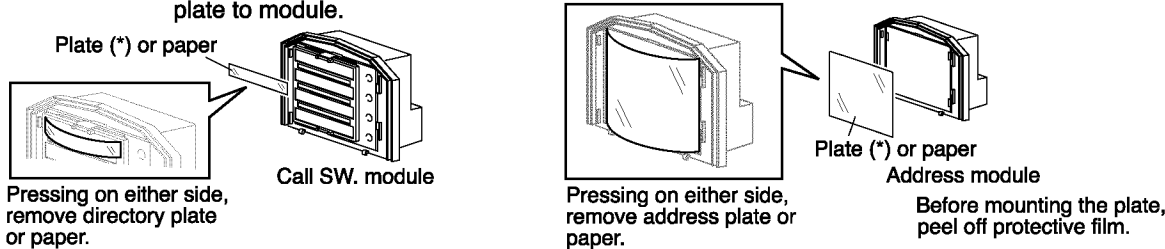

- Setting up after replacement** In case an apartment station is replaced after all the wiring is done, turn the power switch off and back on again on GF-BC. Then reprogram that apartment station only.
- Operations** At the end of communication, hang up the handset on cradle. If a handset is off the hook, call tone will still ring at two stations. But for approx. 45 sec. after called, the inside audio is activated on that apartment station and heard at the entrance. Momentarily hang up handset, and resume communication.
- While an apartment station rings with a call from an entrance station, a call from the doorbell button will not be heard.
- Cleaning** Clean GF equipment with a soft cloth dampened with neutral household cleanser. Never use any abrasive cleaner or cloth.

SPECIFICATIONS

- Power source:** DC 24V (GF-BC), supplied by PS-24ME or a power supply as specified.
- Current consumption:** Max. 700mA. Standby: 30mA (8-call, one entrance).
- Call-in tone:** Two types of call tones, one from entrance station, the other from doorbell button, distinguishable
- Talk path:** Single channel, non-open.
- Communication:** Simultaneous with handset (no calling or communication between apartment stations).
- Wiring:** 2 wires common Bus, GF-BC to Entrance station(s) & Apartment stations via junction point throughout system.
- Type of Cable:** 2 conductors, solid copper & non-braided, polyethylene insulation, 0.8mm dia. ~ 1.6mm dia. (20AWG ~ 14AWG).
- Wiring distance:**

	Diameter of wires	0.8mm dia.	20AWG
• Junction point to GF-1D (farthest)		300m	980'
• Junction point to Entrance station		300m	980'
• Total wiring distance		2,500m	1.5 miles
• GF-BC to Power supply		5m	16'
• GF-BC to Junction point		5m	16'
• MAW-B to each GF-DA, light & power supply		300m	980'
- Bus line capacity:** Multiple Bus lines (divided at junction point).
 - Apartment station: max. 50 on a Bus line.
 - Entrance station: max. 3 on a Bus line.
- Station capacity:**

Apartment station:	Per system: 150 pcs in total
	Per apartment: max. 2 pcs
Entrance station:	Per system: max. 5 pcs GF-DA
	Per panel: max. 25 pcs GF-SW
- Door release terminals:** EL, EL rated less than 4A (resistance load), AC/DC 24V, for dry closure contact for door release.

WARRANTY

Aiphone warrants its products to be free from defects of material and workmanship under normal use and service for a period of one year after delivery to the ultimate user and will repair free of charge or replace at no charge, should it become defective upon which examination shall disclose to be defective and under warranty. Aiphone reserves unto itself the sole right to make the final decision whether there is a defect in materials and/or workmanship; and whether or not the product is within the warranty.

This warranty shall not apply to any Aiphone product which has been subject to misuse, neglect, accident, or to use in violation of instructions furnished, nor extended to units which have been repaired or altered outside of the factory.

This warranty does not cover batteries or damage caused by batteries used in connection with the unit.

This warranty covers bench repairs only, and any repairs must be made at the shop or place designated in writing by Aiphone. Aiphone will not be responsible for any costs incurred involving on site service calls.