

# TOSHIBA



## USER'S GUIDE



## ***TDP-P6*** ***Digital Projector***

English

Français

Deutsch

Español

日本語



**English**

## Declaration of Conformity

Manufacturer: Toshiba Corporation  
1-1, Shibaura 1-Chrome, Minato-ku, Tokyo, Japan

We declare under our sole responsibility that the TDP-P6 projector conform to the following directives and norms:

EMC Directive 89/336/EEC, Amended by 93/68/EEC

EMC: EN 55022

EN 55024

EN 61000-3-2

EN 61000-3-3

Low Voltage Directive 73/23/EEC, Amended by 93/68/EEC

Safety: EN 60950: 2000

August, 2003

## Trademarks

Apple, Macintosh, and PowerBook are trademarks or registered trademarks of Apple Computer, Inc. IBM is a trademark or registered trademark of International Business Machines, Inc. Microsoft, PowerPoint, and Windows are trademarks or registered trademarks of Microsoft Corporation.

## FCC Warning

This equipment has been tested and found to comply with the limits for a Class A digital device, pursuant to part 15 of the FCC Rules. These limits are designed to provide reasonable protection against harmful interference when the equipment is operated in a commercial environment. This equipment generates, uses, and can radiate radio frequency energy and, if not installed and used in accordance with the instruction manual, may cause harmful interference to radio communications. Operation of this equipment in a residential area is likely to cause harmful interference in which case the user will be required to correct the interference at his own expense.

## Agency Approvals

NOM, c-Tick, SJQA, IRAM

Other specific Country Approvals may apply, see please product certification label.

## Canada

This Class A digital apparatus complies with Canadian ICES-003.

Cet appareil numérique de la classe A est conforme à la norme NMB-003 du Canada.

## Remote Control Warning

Laser radiation class II product; wavelength 650nm; maximum output 1mW. Remote control complies with applicable requirements of 21 CFR 1040.10 and 1040.11.

Remote control complies with applicable requirements of EN 60 825-1: 1994 +A11.

**Do not look into the laser beam emitted  
from the top of the remote control.**



## Table of Contents

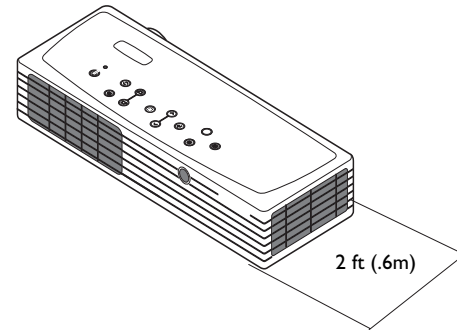
Introduction	5
Connecting a computer	6
Required computer connections	6
Displaying a computer image	7
First-time projector use with Windows 98	8
Adjusting the image	10
Connecting a video device	11
Displaying a video image	12
Shutting down the projector	14
Troubleshooting your setup	14
Using the keypad buttons	22
Using the remote control	23
Using the audio	24
Optimizing computer images	25
Presentation features	25
Optimizing video images	26
Customizing the projector	26
Using the menus	27
Picture menu	28
Settings menu	31
Maintenance	34
Cleaning the lens	34
Replacing the projection lamp	35
Appendix	37
Accessories	37
For assistance with this projector	37
Red LED Behavior and Projector Errors	38
Projected image size	38

If you are experienced in setting up presentation systems, use the *Quick Set Up* card that was included in the box. For complete details on connecting and operating the projector, refer to this User's Guide.

### Important Operating Considerations

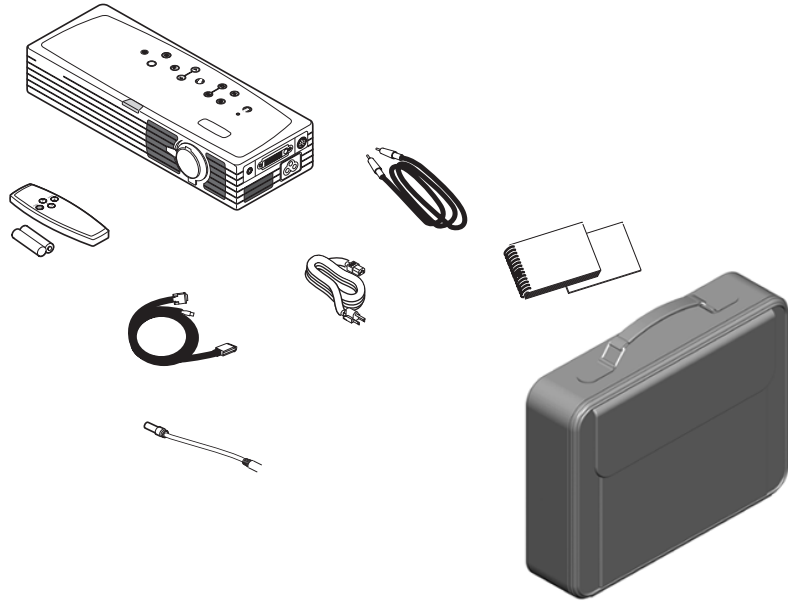
Do not place the projector on a tablecloth or other soft covering that may block the vents. Intake vents are placed along the left, front and back sides of the projector. Exhaust vents are placed along the right side of the projector. In the unlikely event that the lamp ruptures, discard any edible items and thoroughly clean the area along the right side of the projector.

Do not place objects in the area along the right side of the projector



# Introduction

Your new digital projector packs great performance into a shape and size customized for the mobile professional. It fits comfortably in your laptop bag then transitions easily into your presentation environment. It is easy to connect, easy to use, and easy to maintain.



# Projector components and features

# Connecting a computer

## Required computer connections

Connect the black end of the computer cable to the **Computer in** connector on the projector. Connect the blue end to the video (VGA) port on your computer. If you are using a desktop computer with a single VGA port, you first need to disconnect the monitor from that computer's video port.

Connect the black power cable to the connector on the side of the projector and to your electrical outlet.

The Power LED on the projector's keypad turns solid green and the fans start to run.

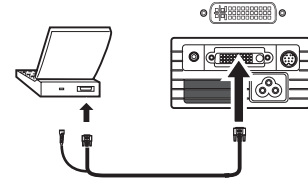
**NOTE:** Always use the power cable that shipped with the projector.

## Optional computer connections

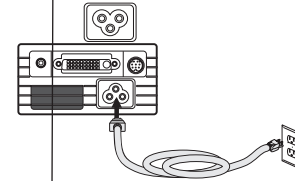
To advance slides in a PowerPoint™ presentation using the remote, plug the USB connector on the computer cable into the USB mouse connector on your computer. USB drivers must be installed to use the USB feature. For more information, see page 9.

To have sound with your presentation, connect the audio cable to your computer and to the computer **Audio In** connector on the projector.

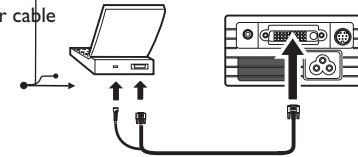
connect computer cable



connect power cable



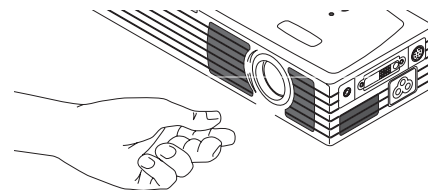
connect USB portion of computer cable



## Displaying a computer image

Remove the lens cap.

Press **Power** to remove lens cap.



Press the **Power** button on the top of the projector.

The LED flashes green. When the lamp comes on, the startup screen is displayed and the LED is steady green. It can take a minute for the image to achieve full brightness.

**? No startup screen?** Get help on page 15.

Turn on your computer.

The computer's image should appear on the projection screen. If it doesn't, press the **Source** button on the projector's keypad.

Make sure your laptop's external video port is active.

Many laptops do not automatically turn on their external video port when a projector is connected. Refer to your computer's documentation to learn the activation commands specific for your computer. For example, some laptops use a key combination of FN + F5 to turn the external display on and off.

**? No computer image?** Try pressing the **Auto Image** button on the keypad. Get help on page 16.

## First-time projector use with Windows 98

The first time you connect a computer running Windows 98 to the projector, the computer recognizes the projector as “new hardware” and the Add New Hardware Wizard appears. Follow these instructions to use the Wizard to load the correct driver (which was installed with your Windows operating system).

If you are running Windows 2000, Windows ME, or Windows XP, skip these steps and go to “Adjusting the image” on page 10.

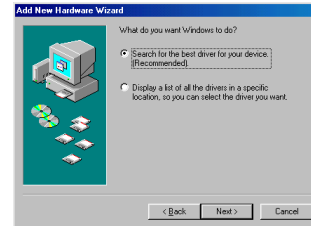
**a** Click **Next** to begin searching for the driver.

**a**



**b** Make sure “Search for the best driver” is selected, then click **Next**.

**b**



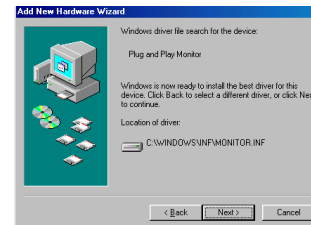
**c** Uncheck any checked boxes, then click **Next**. Windows automatically locates the driver. If this driver has been removed, reload the driver using your Windows operating system CD.

**c**



**d** When Windows finds the driver, you are ready to install it. Click **Next**.

**d**





**Skip this page if you did not connect the USB portion of the computer cable. The USB connection enables slide advance during presentations and projector control software.**

**For Windows 98:**

- If you connected the USB cable, the Add New Hardware Wizard appears again. Drivers must be installed to use the USB functionality.
- **The Wizard launches three times.**

The first time it detects a USB Composite Device.

The second time a USB Human Interface Device (for the keyboard).

The third time it detects a USB Human Interface Device (for the mouse).

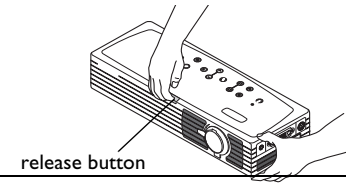
**For Windows 2000, Windows ME, and Windows XP:**

- The USB drivers are automatically installed.

## Adjusting the image

Adjust the height of the projector, if necessary, by pressing the release button to extend the elevator foot.

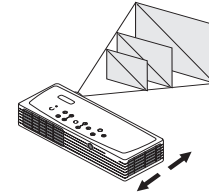
adjust height



Position the projector the desired distance from the screen at a 90 degree angle to the screen.

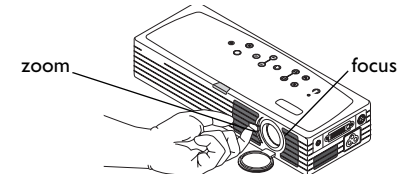
See page 38 for a table listing screen sizes and distances.

adjust distance



Adjust the zoom tab or the focus dial by rotating them until the desired image size and sharpness are produced.

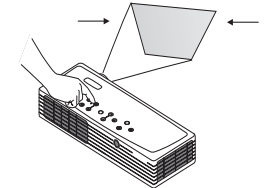
adjust zoom and focus



If the image is not square, adjust the keystone by using the buttons on the keypad.

Press the upper **Keystone** button to reduce the upper part of the image, and press the lower **Keystone** button to reduce the lower part.

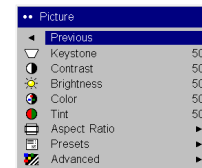
adjust keystone



Adjust the Contrast or Brightness in the Picture menu.

See page 27 for help with the menus.

adjust Contrast or Brightness



# Connecting a video device

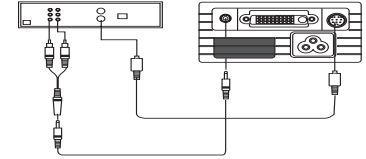
## Standard video connections

Plug the S-video cable's connector into the S-video-out connector on the video device. Plug the other connector into the **S-Video** connector on the projector.

Plug the white connector of the audio adapter into the left audio out connector on the video device and plug the red connector into the right audio out connector on the video device.

Plug the audio cable into the other end of the audio cable adapter and into the **audio in** connector on the projector.

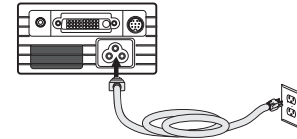
connect S-video cable and audio cable and adapter



Connect the black power cable to the connector on the side of the projector and to your electrical outlet. The Power LED on the keypad turns solid green and the fans start to run.

**NOTE:** Always use the power cable that shipped with the projector.

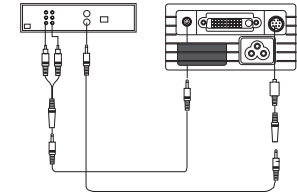
connect power cable



## Optional video connections

If the video device uses a composite video connector, plug a composite video cable (sold separately) into the composite connector on the video device and into the S-video adapter. Plug the S-video adapter into the **S-video** connector on the projector. Use the audio cables as described above.

connect composite video cable and adapter and audio cable and adapter



The screen is displayed. For the image to achieve full brightness,

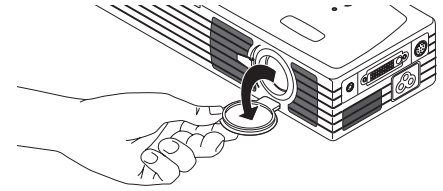
**? No startup screen?** Get help on page 15.

Plug in and turn on the video device.

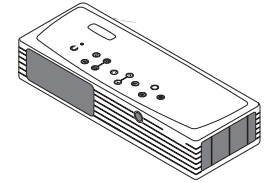
**? No video image?** Try pressing the **Source** or **Auto Image** button on the keypad. Get help on page 15.

Adjust the height of the projector by pressing the release button to extend the elevator foot.

Position the projector the desired distance from the screen at a 90 degree angle to the screen. See page 38 for a table listing screen sizes and distances to the screen.

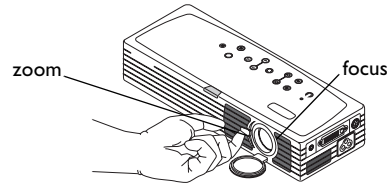


press Power



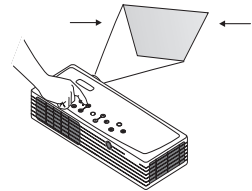
Adjust the zoom using the tab or the focus using the dial by rotating them until the desired image size and sharpness are produced.

adjust zoom and focus



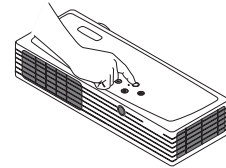
If the image is not square, adjust the keystone using the buttons on the keypad. Press the upper **Keystone** button to reduce the upper part of the image, and press the lower **Keystone** button to reduce the lower part.

adjust keystone



Adjust the volume on the keypad.

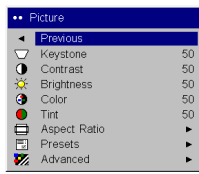
adjust volume



Adjust the **Contrast**, **Brightness**, **Color**, or **Tint** in the Picture menu.

See page 27 for help with the menus.

adjust Picture menu



## Shutting down the projector

By default, the projector automatically displays a blank screen after no active source is detected for 30 minutes. This blank screen helps preserve the life of the projector. The image returns when an active source is detected or a remote or keypad button is pressed.

### Screen Save

You can make the blank screen appear after a different time interval using the **Settings>System** menu. See page 32. There are six time options, ranging from five minutes to 30 minutes with five minute intervals.

### Power Save

The projector also has a Power Save feature that, when activated, automatically turns the lamp off after no signals are detected for 20 minutes. After 10 additional minutes with no signal, the projector powers down. If an active signal is received before the projector powers down, the image is displayed. You must press the Power button to display an image after 30 minutes have passed. When Power Save is enabled, Screen Save is disabled. See page 31.

### Turning off the projector

To turn off the projector, press the **power** button and verify that you want to turn the projector off by pressing the power button again within 3 seconds. You can cancel the shutdown by not pressing the **power** button a second time. The lamp turns off and the LED blinks green for 1 minute. When the lamp has cooled, the LED lights green. Unplug the power cable to completely power off the projector.

## Troubleshooting your setup

If your image appears correctly on the screen, skip to the next section (page 23). If it does not, troubleshoot the setup.

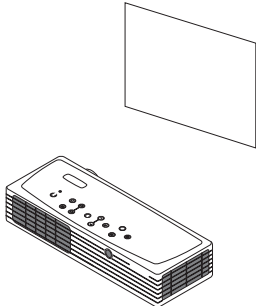
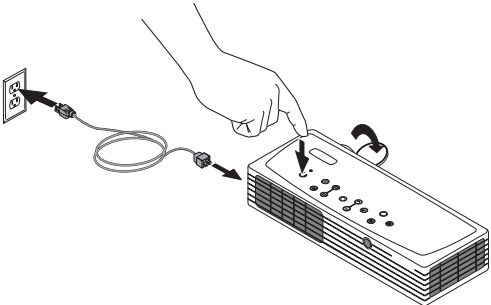
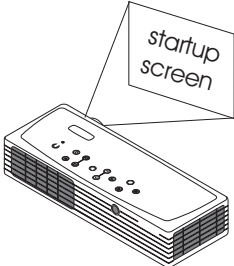
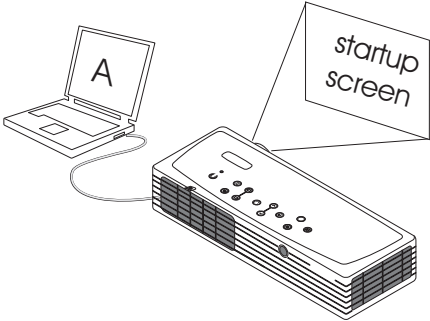

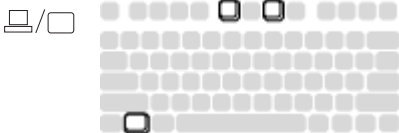
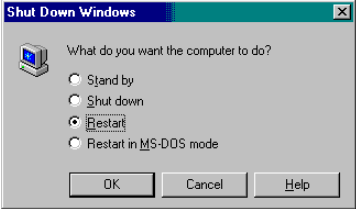
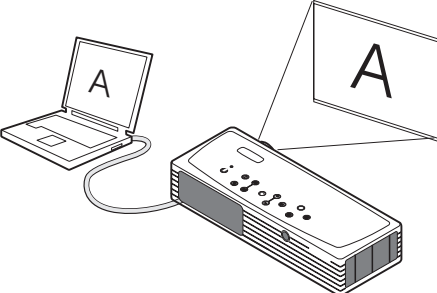
The LED on top of the projector indicates the state of the projector and can help you troubleshoot.

**Table 1: LED behavior and meaning**

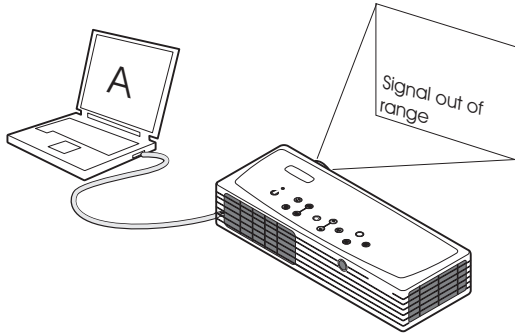
LED color/behavior	Meaning
solid green	The projector is plugged in, or the projector has been turned on and the software has initialized or the projector has been turned off.
blinking green	The power button has been pressed and the software is initializing, or the projector is powering down.
blinking red see page 38 for more information	A fan or lamp failure has occurred. Make sure the vents aren't blocked (see page 20). Turn off the projector and wait one minute, then turn the projector on again. If the Change Lamp message appears, replace the lamp and reset the lamp timer. Contact your Toshiba Dealer if the problem persists.
solid red	An unidentifiable error: please contact your Toshiba Dealer.

The following tables show common problems. In some cases, more than one possible solution is provided. Try the solutions in the order they are presented. When the problem is solved, you can skip the additional solutions.

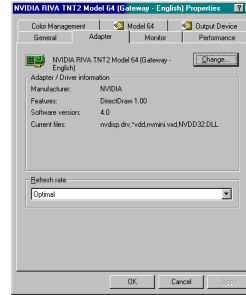
Source Troubleshooting

Problem	Solution	Result
<p data-bbox="53 184 260 207"><b>No startup screen</b></p> 	<p data-bbox="666 150 1119 202"><b>Plug power cable in and press the power button. Remove lens cap.</b></p> 	<p data-bbox="1187 184 1355 207"><b>Correct image</b></p> 
<p data-bbox="53 575 373 598"><b>Only startup screen appears</b></p> 	<p data-bbox="666 603 1013 661"><b>Press the Source button</b> </p> <p data-bbox="666 640 1013 663"><b>Activate laptop's external port</b></p>  <p data-bbox="661 839 770 890"><b>or restart laptop</b></p> 	<p data-bbox="1187 569 1499 592"><b>Computer image projected</b></p> 

**No computer image, just the words “Signal out of range”**

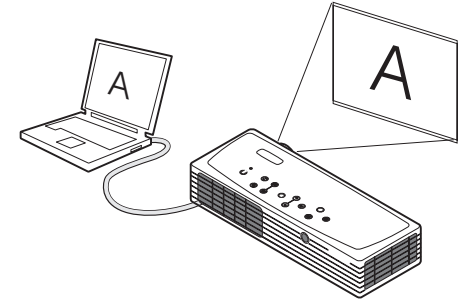


**Adjust computer refresh rate in Control Panel>Display>Settings>Advanced>Adapter (location varies by operating system)**



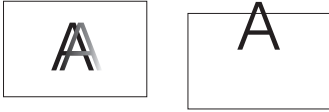
**You may also need to set a different resolution on your computer, as shown on the following page**

**Computer image projected**



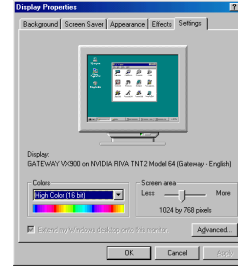


**Image fuzzy or cropped**



**Set your computer's display resolution to the native resolution of the projector  
(Start>Settings>Control Panel>Display>Settings tab, select 1024x768)**

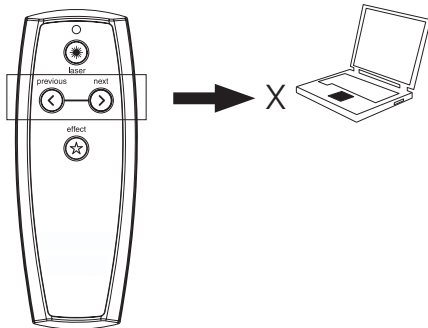
**For a laptop, disable laptop monitor or turn-on dual-display mode**



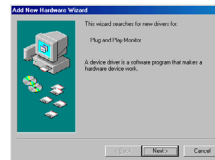
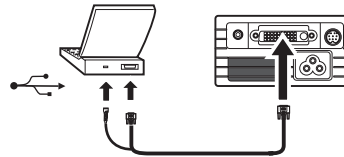
**Image clear and not cropped**



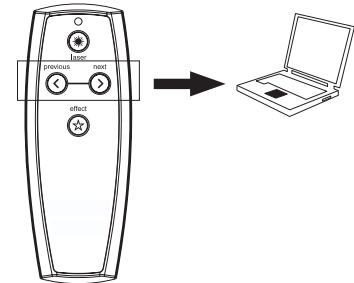
**Remote control not advancing PowerPoint slides**



**Connect computer cable (page 6), then load USB drivers, if needed (page 8)  
Check batteries in remote**



**Remote advances slides.  
See page 23 for information on the remote**



## Projector troubleshooting

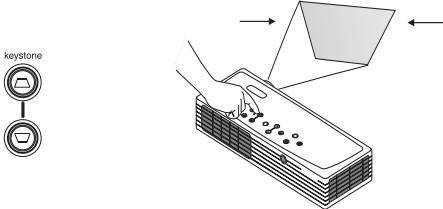


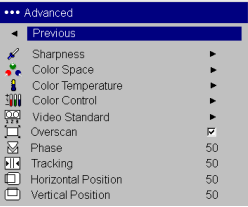


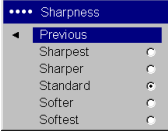

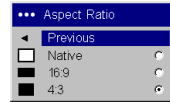
Problem	Solution	Result
<p data-bbox="53 166 251 189"><b>Image not square</b></p> 	<p data-bbox="664 158 968 181"><b>Adjust keystone on keypad</b></p> 	<p data-bbox="1189 158 1345 181"><b>Square image</b></p> 
<p data-bbox="53 433 401 456"><b>Edges of video image distorted</b></p> 	<p data-bbox="664 422 1154 468"><b>Turn Overscan on in the Picture&gt;Advanced menu</b></p> 	<p data-bbox="1189 433 1355 456"><b>Correct image</b></p> 
<p data-bbox="53 726 239 749"><b>Image not sharp</b></p> 	<p data-bbox="664 715 1147 761"><b>Adjust Sharpness in the Picture&gt;Advanced menu</b></p> 	<p data-bbox="1189 726 1355 749"><b>Correct image</b></p> 

Image does not fit 16:9 screen



Change aspect ratio to 16:9 in  
Picture>Aspect ratio menu



Correct image

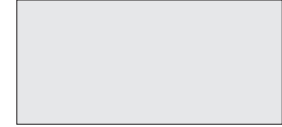
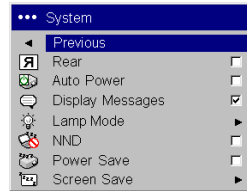


Image reversed left to right



Turn off Rear in Settings>System menu



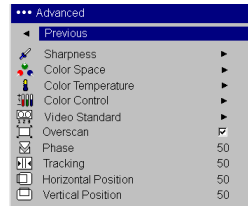
Correct image



Video image “torn” and fragmented



Change Video Standard in  
Picture>Advanced menu



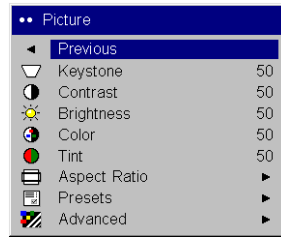
Correct image



**Projected colors don't match source**

~~COLOR~~

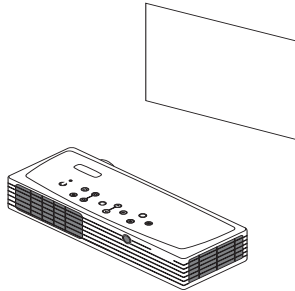
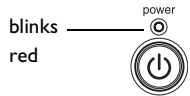
**Adjust color temperature, color space, color control, brightness, and contrast in the Picture and Advanced menus. Also, adjust color and tint (video sources only).**



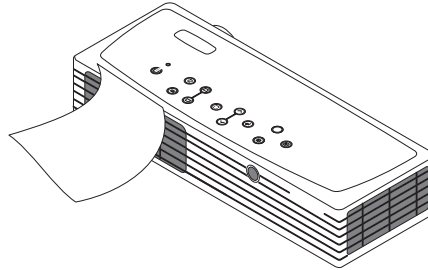
**Correct image**

COLOR

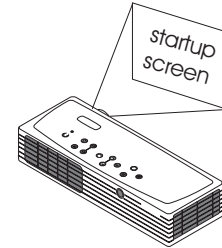
**Lamp won't turn on, LED blinking red (page 14)**



**Make sure vents aren't blocked; allow projector to cool for one minute**



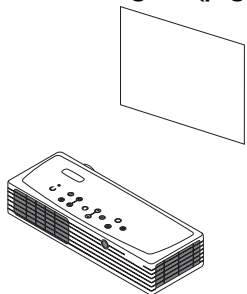
**Unplug projector; wait one minute; plug in projector and turn it on: lamp lights**



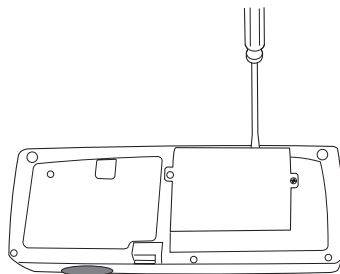
### Lamp won't turn on, LED blinking red (page 14)

blinks  
red

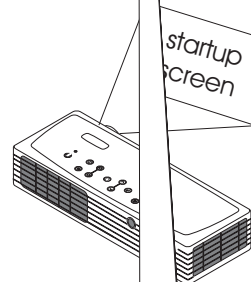
power



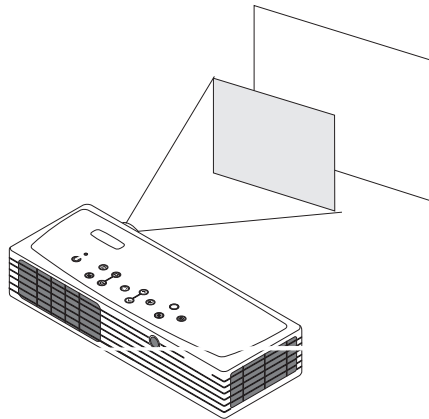
### Lamp must be replaced (page 35)



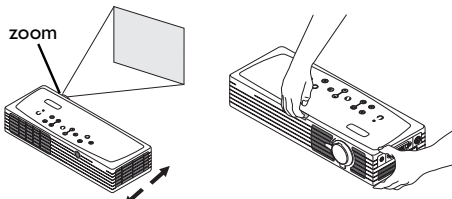
### Lamp turns on



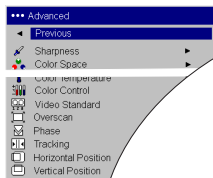
### Image not centered on screen



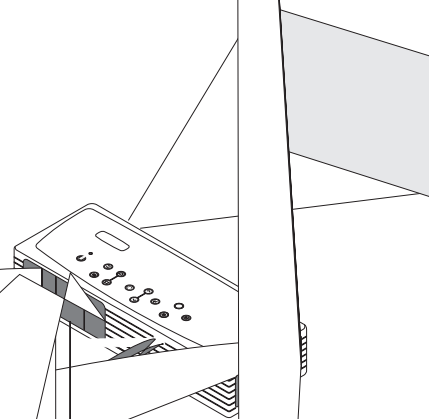
### Move projector, adjust zoom, adjust height



### Adjust horizontal or vertical position in Picture>Advanced menu



### Correct image



### Still need assistance?

If you still need assistance, please contact your authorized Technical Support representative.

## Using the keypad buttons

Most buttons are described in detail in other sections, but here is an overview of their functions:

**Power**—turns the projector on (page 7) and off (page 14).

**Menu**—displays the on-screen menus (page 27).

**Select**—confirms choices made in the menus (page 27).

**Up/Down arrows**—navigates to and adjusts settings in the menus (page 27).

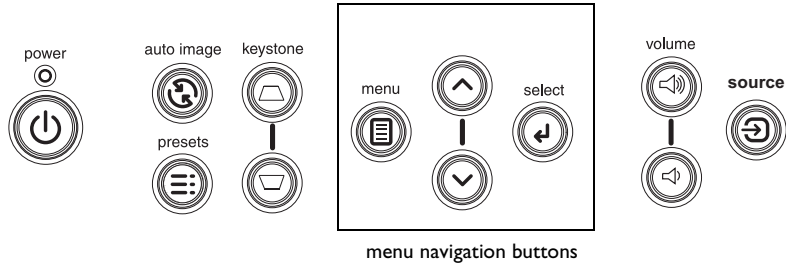
**Auto Image**—resets the projector to the source.

**Presets**—cycles through the available preset settings (page 29).

**Keystone**—adjusts squareness of the image (page 10).

**Volume**—adjusts sound (page 24).

**Source**—changes the active source between computer and video.



## Using the remote control

The remote uses two (2) provided AAA batteries. They are easily installed by sliding the cover off the remote's back, aligning the + and - ends of the batteries, sliding them into place, and then replacing the cover.

To operate, point the remote at the projection screen or at the projector (not at the computer). The range of optimum operation is about 30 feet (9.14m).

To use the laser pointer, press and hold the **Laser** button. The laser turns off when the button is released, or times out after two (2) minutes of continuous operation.

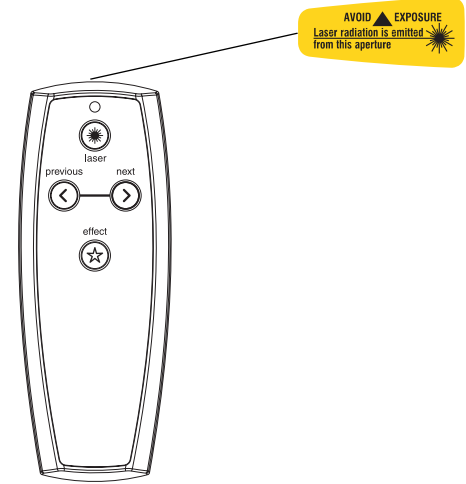
**WARNING:** Do not look into the laser beam emitted from the top of the remote control.

Previous and Next buttons allow you to navigate through your PowerPoint presentation while in Slide Show mode. Connect the USB connector on the computer cable to your computer to use these buttons. When you do this for the first time, the Add New Hardware wizard may appear. See page 8 for details on loading the correct USB drivers.

The effect button allows you to invoke a user-definable action, such as freeze or blank the screen (see page 32 to learn to program this button).

### Troubleshooting the remote

- Make sure the batteries are installed in the proper orientation and are not dead. When battery power is adequate, the LED at the top of the remote lights when any button is pressed.
- Make sure you're pointing the remote at the projector, not the computer, and are within the remote range of 30 feet (9.14m).
- If you are trying to advance PowerPoint slides, make sure the USB cable is connected (page 6) and the correct drivers are installed (page 8).



## Using the audio

To play sound from the projector, connect your source to the Audio In connector on the projector.

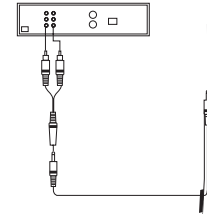
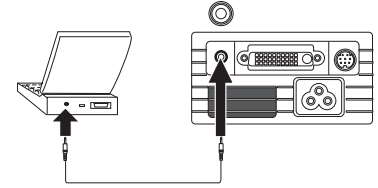
To adjust the volume, use the buttons on the keypad.

### Troubleshooting audio

If there is no sound, check the following:

- Make sure the audio cable is connected.
- Make sure mute isn't active (used with the **Effect** key).
- Make sure the volume is turned up enough. Press the volume button on the keypad.
- Adjust the audio source.
- If playing a video, make sure the playback has not been paused.

connect audio cable





## Optimizing computer images

After your computer is connected properly and the computer's image is on the screen, you can optimize the image using the onscreen menus. For general information on using the menus, see page 27.

- Adjust the Keystone, Contrast, or Brightness in the Picture menu.
- Change the Aspect Ratio. Aspect Ratio is the ratio of the image width to image height. TV screens are usually 1.33:1, also known as 4:3. HDTV and most DVDs are 1.78:1, or 16:9. Choose the option that best fits your input source. See page 28 for details.
- Adjust the Color Space, Color Temperature, or Color Control in the Advanced menu.
- Adjust the Phase, Tracking, or Horizontal or Vertical position in the Advanced menu.
- Once you have optimized the image for a particular source, you can save the settings using Presets. This allows you to quickly recall these settings later. See page 29.

## Presentation features

Several features are provided to make it easier to give presentations. The following is an overview, details are found in the menu section on page 27.

- The remote's **Effect** button allows you to assign various features to the key. The default effect is About, which displays information about the projector and current source. You can select from Blank, Mute, Aspect Ratio, Source, Auto Image, Freeze, Zoom, and About. See page 32 for details.
- The Freeze effect allows you to freeze the displayed image. This is useful if you want to make changes on your computer without your audience seeing them.
- The Startup Logo and Blank Screen menu options let you change the default startup screen to a black, white, or blue screen. See page 32.
- Two menu options, Power Save and Screen Save, are provided to automatically shut down the projector after several minutes of inactivity or display a black screen. This helps preserve lamp life. See page 31 and page 32.
- A Lamp Mode option is also available to let you optimize lamp brightness or lamp life. See page 31.

## Optimizing video images

After the video device is connected properly and the image is on the screen, you can optimize the image using the onscreen menus. For general information regarding menu usage, see page 27.

- Adjust the Keystone, Contrast, Brightness, Color, or Tint in the Picture menu. See page 28.
- Change the Aspect ratio. Aspect ratio is the ratio of the image width to image height. TV screens are usually 1.33:1, also known as 4:3. HDTV and most DVDs are 1.78:1, or 16:9. Choose the option that best fits your input source. See page 28.
- Select a Sharpness setting in the Advanced menu. See page 30.
- Select a different Color Temperature, or use the Color Control to individually adjust the intensity of the red, green, and blue color. See page 30.
- Select a different Video Standard. Auto tries to determine the standard of the incoming video. Select a different standard if necessary. See page 30.
- Turn overscan on to remove noise around the video image. See page 30.
- Once you have optimized the image for a particular source, you can save the settings using Presets. This allows you to quickly recall these settings later. See page 29.

## Customizing the projector

You can customize the projector for your specific setup and needs. See page 31 to page 33 for details on these features.

- For rear projection, turn Rear mode on in the **Settings>System** menu.
- Specify which source the projector checks first for active video during power-up.
- Specify the function of the Effect Key on the remote.
- Turn the projector's display messages on and off.
- Turn on power saving features.
- Specify blank screen colors and startup logos.
- Specify the menu language.
- Specify a lamp mode to optimize either brightness or lamp life.
- Prevent your computer from entering Screen Save mode.
- Save settings for the active source as a preset.

# Using the menus

To open the menus, press the **Menu** button on the keypad. (The menus automatically close after 60 seconds if no buttons are pressed.) The Main menu appears. Use the arrow buttons to move up and down to highlight the desired submenu, then press the **Select** button.

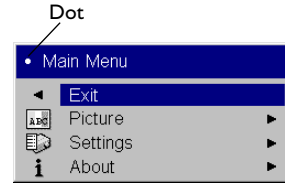
To change a menu setting, highlight it, press **Select**, then use the up and down arrow buttons to adjust the value, select an option using radio buttons, or turn the feature on or off using check boxes. Press **Select** to confirm your changes. Use the arrows to navigate to another setting. When your adjustments are complete, navigate to Previous, then press **Select** to go to the previous menu; select Exit or press the **Menu** button at any time to close the menus.

Dots appear before the menu name. The number of dots indicate the menu's level, ranging from one (the Main menu) to four (the most nested menus).

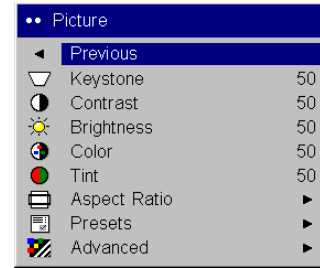
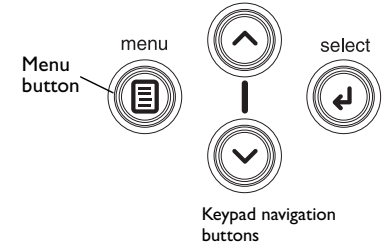
The menus are grouped by usage:

- The Picture menu provides image adjustments.
- The Settings menu provides set-up type adjustments that are not changed often.
- The About menu provides a read-only display of information about the projector and source.

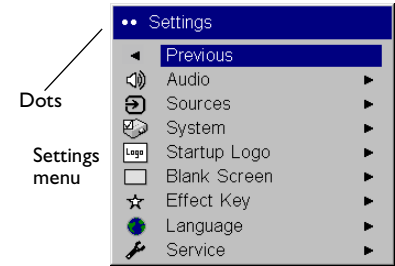
Certain menu items may be hidden until a particular source is connected. For example, Sharpness is only available for video sources and will be hidden when a computer source is active. Other menu items may be grayed out when they are not available. For example, Brightness is grayed out until an image is active.



Main menu

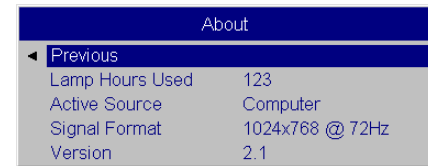


Picture menu



Settings menu

About menu



## Picture menu

To adjust the following five settings, highlight the setting, press **Select**, use the up and down arrows to adjust the values, then press **Select** to confirm the changes.

**Keystone:** adjusts the image vertically and makes a squarer image. You can also adjust keystone from the keypad.

**Contrast:** controls the degree of difference between the lightest and darkest parts of the picture and changes the amount of black and white in the image.

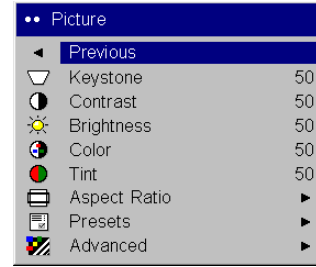
**Brightness:** changes the intensity of the image.

**Color:** (video sources only) adjusts a video image from black and white to fully saturated color.

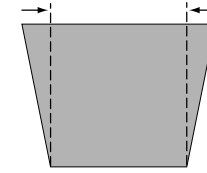
**Tint:** (NTSC video sources only) adjusts the red-green color balance in the image.

**Aspect Ratio:** Aspect ratio is the ratio of the image width to image height. TV screens are usually 1.33:1, also known as 4:3. HDTV and most DVDs are 1.78:1, or 16:9. The default is 4:3, which displays the input resized up or down to fill the display area.

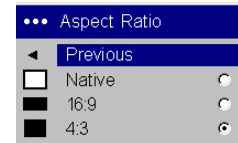
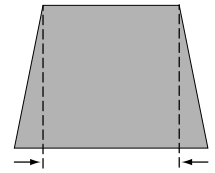
Select Native to see the unmodified input with no resizing by the projector. Select 16:9 to watch enhanced widescreen DVDs.



increasing keystone



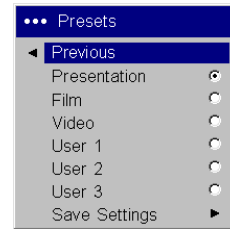
decreasing keystone



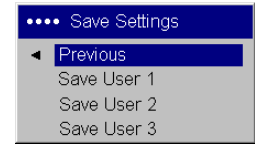
Aspect ratio

**Presets:** The provided Presets optimize the projector for displaying computer presentations, film images, and video images. (Film input is material originally captured on a film camera, like a movie; video input is material originally captured on a video camera, like a TV show or sporting event.) You can use the preset as a starting point, then further customize the settings for each source. The settings you customize are saved in the preset for each source. To restore the factory default settings, choose Factory Reset in the **Settings>Service** menu.

There are also three user-definable presets. To set a preset for the current source, adjust the image, select **Save Settings** in the Presets menu, then choose Save User 1, 2, or 3. You can recall these settings in the future by selecting the appropriate user presets.



Presets



Save User Presets

## **Advanced menu**

**Sharpness:** (video sources only) changes the clarity of the edges of a video image. Select a sharpness setting.

## **Color Space**

## Settings menu

**Audio:** allows volume adjustments. You can also adjust volume from the keypad.

**Screen Save:** automatically blanks the screen with a black color after no signals are detected for a preset number of minutes (the default is 30 minutes). The image returns when an active source is detected or a remote or keypad button is pressed. Screen Save is disabled when Power Save is enabled.

**Startup Logo:** allows you to display a blank Black, White, or Blue screen instead of the default screen at startup and when no source is detected.

**Blank Screen:** determines what color displays when no source is active.

**Effect Key:** allows you to assign a different function to the **Effect** button on the remote to quickly and easily use the effect. Only one effect can be enabled at a time. Highlight an effect and press **Select** to choose a different one.

**Blank:** shows an empty screen.

**Mute:** turns off all sound.

**Aspect Ratio:** sets the ratio of the image width to image height.

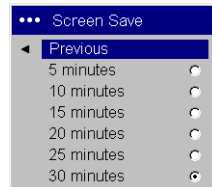
**Source:** cycles through the available sources.

**Auto Image:** causes sources to be reacquired.

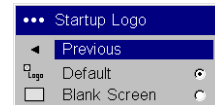
**Freeze:** pauses the projected image.

**Zoom:** lets you magnify a part of the screen. This feature only works if you purchase an optional remote control with mouse buttons and cursor control. To use the Zoom effect, press **Effect**, then press the left button to zoom the image, press the right mouse decrease the magnification. You can use the cursor control to pan the image, displaying different parts of it (only if the image is magnified). To return to the original size and cancel Zoom, press the **Effect** button a second time.

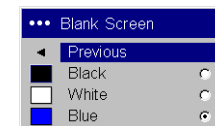
**About:** is the default effect. It displays the About menu.



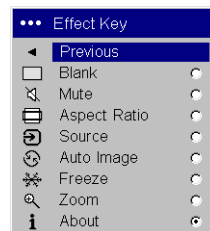
Screen Save



Startup Logo



Blank Screen



Effect Key



**Language:** allows you to select a language for the onscreen display of menus and messages.



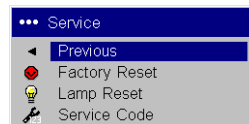
Language

**Service:** to use these features, highlight them and press **Select**.

**Factory Reset:** restores all settings (except Lamp Hours) to their default after displaying a confirmation dialog box.

**Lamp Reset:** resets the lamp hours counter in the About menu to zero after displaying a confirmation dialog box. Do this only after changing the lamp.

**Service Code:** only used by authorized service personnel.



Service menu

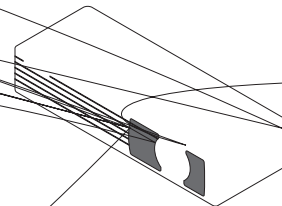
## Maintenance

### Cleaning the lens

- 1 Apply a non-abrasive camera lens cleaner to a soft, dry cloth.

Avoid using an excessive amount of cleaner, and don't apply the cleaner directly to the lens. Abrasive cleaners, solvents or other harsh chemicals might scratch the lens.

- 2 Lightly wipe the cleaning cloth over the lens in a circular motion. If you don't intend to use the projector immediately, replace the lens cap.



## Replacing the projection lamp

The lamp hour timer in the About menu counts the number of hours the lamp has been in use. Fifty hours before the specified end of the lamp's life, the message "Change lamp" briefly appears on the screen at each startup. After 50 additional hours, the lamp will no longer light. You can order new lamp modules from your dealer.

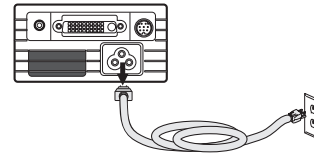
- 1 Turn off the projector and unplug the power cable.
- 2 Wait 60 minutes to allow the projector to cool thoroughly.
- 3 Turn the projector upside down and loosen the two screws on the lamp door. Pry the door straight up to disengage the power interrupt connector (located on the underside of the door) and remove the lamp door. Be sure to pry the door straight up, not at an angle, to avoid damaging the power interrupt connector.

**NOTE:** The projector will not turn on while the lamp door is removed.

- 4 Pull the pull tab on the lamp module up to release the catch.
- 5 Pinch the lamp cable's connector tabs to release the catch while pulling firmly on the connector to unplug the lamp.

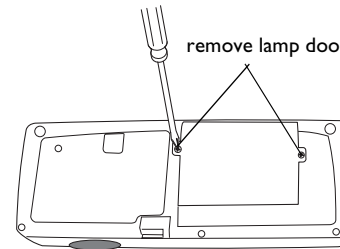
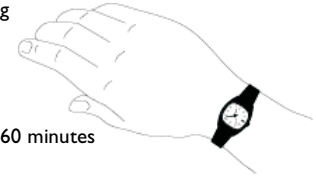
About	
◀ Previous	
Lamp Hours Used	123
Active Source	Computer
Signal Format	1024x768 @ 72Hz
Version	2.1

About menu

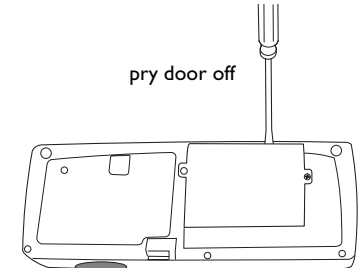


turn off and unplug  
the projector

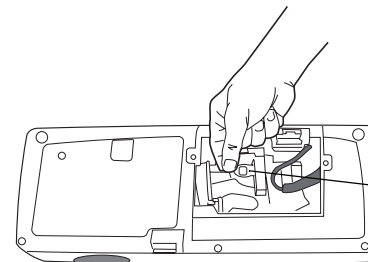
wait 60 minutes



remove lamp door screws



pry door off



release the pull tab

## WARNINGS:

- To avoid burns, allow the projector to cool for at least 60 minutes before you replace the lamp.
- Do not drop the lamp module. The glass may shatter and cause injury.
- Do not touch the glass lamp screen. Fingerprints can obscure projection sharpness.
- Be extremely careful when removing the lamp housing. In the unlikely event that the lamp ruptures, small glass fragments may be generated. The lamp module is designed to contain most of these fragments, but use caution when removing it.

**6** Carefully remove the lamp module. Note that the lens end of the module has a tab that connects in a slot in the bottom of the lamp cavity. You must pull upward with enough force to disconnect the tab from the slot. Dispose of the lamp in an environmentally proper manner.

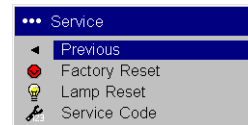
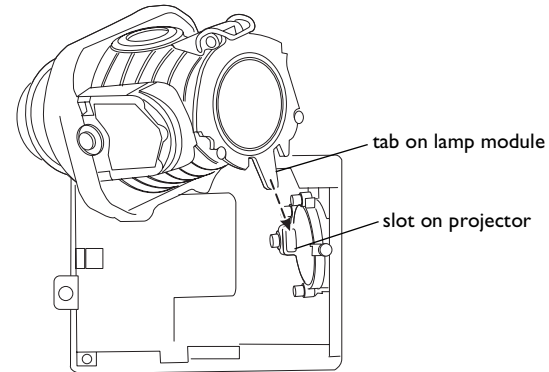
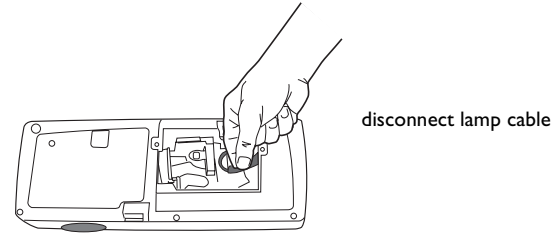
**7** Install the new lamp module. Slide the new module straight down over the tunnel/hood, align the tab with the slot, then press to connect.

**8** Re-latch the pull tab while pressing down on the lamp module.

**9** Re-plug in the lamp cable.

**10** Replace the lamp door by aligning the connector on the back of the door with the projector and replacing the two lamp door screws.

**11** Plug in the power cable, then press the **Power** button to turn the projector back on. Reset the lamp hour timer by simultaneously holding down the two **Volume** keys on the projector's keypad for 10 seconds. At that point the LED will turn green and you can power on the projector. You can also navigate to the **Settings>Service** menu and select **Lamp Reset** to reset the lamp timer.



reset lamp time in Service menu

# Appendix

## Accessories

### Standard Accessories (ship with the projector)

---

Shipping Box (with packaging)

Carry Case

Computer Cable 6.6 ft (2 m)

S-Video Cable 6 ft (1.8 m)

S-video to RCA Adapter

Audio Cable 6 ft (1.8 m)

Audio Cable Adapter

Power Cable (US) 10 ft (3m)

Power Cable (European) 10 ft  
(3m)

Remote Control

Projection Lamp Module (included  
in projector)

Quick Setup card

User's Guide

Safety Card

## For assistance with this projector

For assistance with your Toshiba projector in the United States, please visit [www.toshiba.com/tacp](http://www.toshiba.com/tacp) or contact by phone at 800-846-6672.

For assistance with your Toshiba projector in Europe, please visit [www.toshiba-europe.com](http://www.toshiba-europe.com) or contact your local Toshiba dealer.

For assistance with your Toshiba projector in Asia/Japan, please contact your local Toshiba dealer.

## Red LED Behavior and Projector Errors

If the projector is not functioning properly and the red LED is blinking, consult **Table 2** to determine a possible cause. There are two second pauses between the blinking cycles.

**Table 2:**

<b>Red LED Behavior</b>	<b>Explanation</b>
One (1) blink	The lamp won't strike after five (5) attempts. Check the lamp and lamp door installations for loose connections.
Two (2) blinks	The lamp counter hours have exceeded lamp life hours. Replace the lamp and reset the lamp hours counter.
Three (3) blinks	The projector has shut down the lamp. Turn off the projector and wait one minute, then turn the projector on again. Replace the lamp. Contact your local Toshiba dealer for repair if replacing the lamp does not solve the problem.
Four (4) blinks	The fan has failed. Contact your local Toshiba dealer for repair.
Five (5) blinks	The projector is overheating. Check for a blocked air vent. Contact your local Toshiba dealer for repair if clearing the air vents does not solve the problem.
Solid red	Unidentifiable error: contact your local Toshiba dealer.

## Projected image size

**Table 3:**  
**Range of distance to the screen for a given screen size**

<b>Diagonal Screen Size (inches/m)</b>	<b>Image Width (inches/m)</b>	<b>Distance to screen</b>	
		<b>Maximum distance (feet/m)</b>	<b>Minimum Distance (feet/m)</b>
40/1	32/0.8	5.6/1.7	4.8/1.5
50/1.3	40/1	6.9/2.1	6/1.8
60/1.5	48/1.2	8.2/2.5	7.2/2.2
100/2.5	80/2	13.8/4.2	12.1/3.7

## **A**

- About 32
- Aspect Ratio 32
- audio 24
- Audio In connector 6, 11
- audio volume 13
- Auto Image 32
- Auto Power 31

## **B**

- Blank 32
- blinking green 14
- blinking red 14
- Brightness 10

## **C**

- cleaning the lens 34
- Color 13
- colors are incorrect 20
- computer connections
  - optional 6
  - required 6
- Computer connector 6
- computer image
  - optimize 25
- Contrast 10, 13

## **D**

- Display Messages 31
- Drivers 8
  - USB 9
  - Windows 98 9

## **E**

- Effect Key 32
- elevator foot 10

## **F**

- first time use
  - driver installation 8
- focus 10, 13

- For 37
- Freeze 32
- fuzzy image 17

## **I**

- image
  - display video 12
- image display
  - computer 7
- image does not fit screen 19
- image edges distorted 18
- image not centered 21
- image not sharp 18
- image not square 18
- image reversed 19
- image size matrix 38
- image torn 19

## **K**

- Keystone 10, 13

## **L**

- lamp replacement 35
- lamp won't turn on 20, 21
- Language 33
- laptop
  - connecting 6
  - external video port 7

## **LED**

- blinking green 14
- blinking red 20
- solid green 14
- solid red 21
- LED behavior 14
- Lens cleaning 34
- Low Power 31

## **M**

Main menu 27  
menu system 27  
Mute 32

## **N**

no computer image 16  
no startup screen 15

## **O**

only startup screen appears 15

## **P**

Picture menu 28  
Power button 12  
power cable 6, 11  
Power Save 31  
presentation features 25  
projector  
    customizing 26  
    shutdown 14  
    standard accessories 37  
    troubleshooting problems 14  
projector height 10, 12  
projector positioning 10, 12

## **R**

Rear 31  
remote control 23  
    not working 17  
replacing the lamp 35

## **S**

Settings menu 31  
shutdown  
    projector 14  
solid green 14  
solid red 14  
Source 32  
Source troubleshooting 15  
Sources 31  
standard accessories 37  
S-video connector 11

## **T**

Tint 13  
Troubleshooting 14, 15

## **U**

USB, using your mouse 6

## **V**

video connections  
    optional 11  
    standard 11  
Video connector 11  
video images  
    optimizing 26

## **W**

Windows 98 8  
Windows ME, XP, 2000 9

## **Z**

zoom 10, 13, 32