

American Standard

MONTERREY™

**SPREAD LAVATORY
FAUCETS**

**Installation
Instructions**

6500 SERIES 6530 SERIES
6501 SERIES 6531 SERIES
6502 SERIES 6532 SERIES
6900 SERIES 6930 SERIES
6901 SERIES 6931 SERIES
6902 SERIES 6932 SERIES

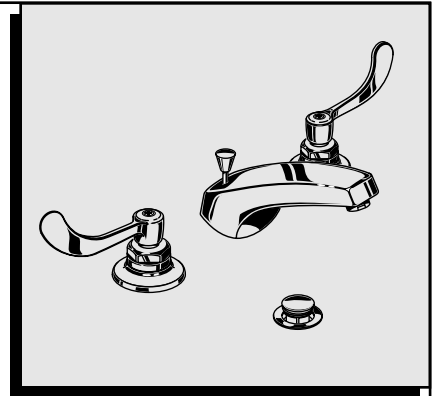

Certified to comply with ANSI A112.18.1M
US PATENT D371956

*Thank you for selecting American-Standard...the benchmark
of fine quality for over 100 years.*

*To ensure that your installation proceeds smoothly-please
read these instructions carefully before you begin.*

60186B

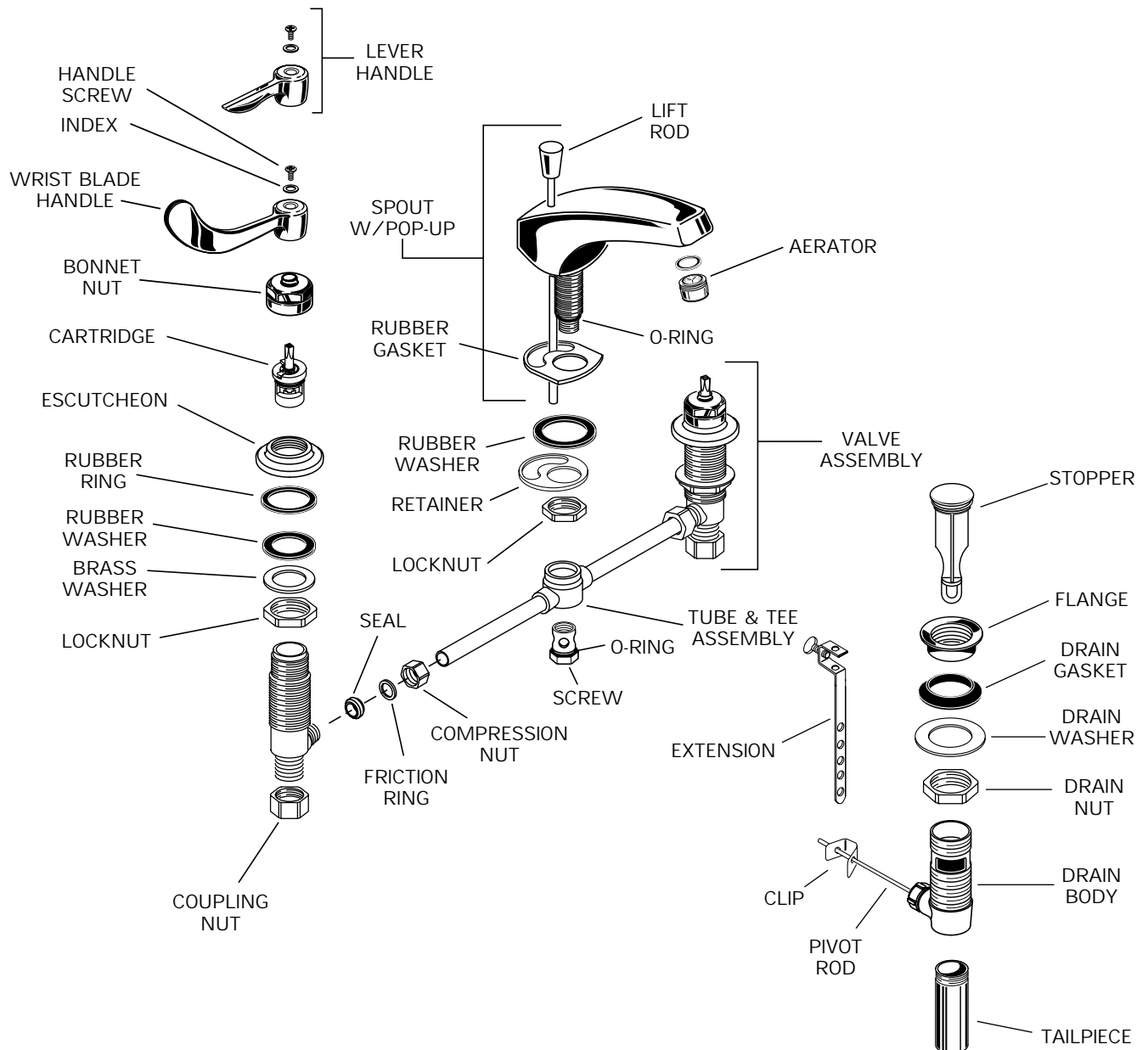

1**CAUTION**

Turn off hot and cold water supplies before beginning.

SPOUT OR BASE ASSEMBLY

- Insert BASE or SPOUT shank through center hole of SINK, making sure RUBBER GASKET is properly positioned.
- Assemble RUBBER WASHER, RETAINER, and LOCKNUT onto threads of SPOUT from underside of SINK.
- Insert LIFT ROD through SPOUT (or BASE) and slot of RETAINER.
- Align SPOUT and tighten LOCKNUT. Be sure slot in BRASS WASHER is positioned to the rear as shown.

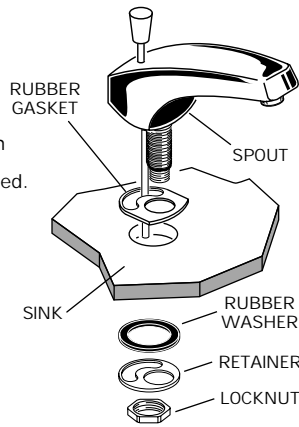
**2****VALVE INSTALLATION**

- Place RUBBER RING into ESCUTCHEON and screw ESCUTCHEON onto VALVE BODY until snug against internal stop.
- Tighten LOCKNUT to secure VALVE position. Attach COUPLING to TEE and tighten.
- Slide RUBBER FERRULE, FRICTION RING, and COUPLING NUT to outlet of VALVE and tighten COUPLING NUT firmly. Repeat on other VALVE.
- Connect HOT water supply to inlet of left VALVE and COLD water supply to inlet of right VALVE using appropriate connector.

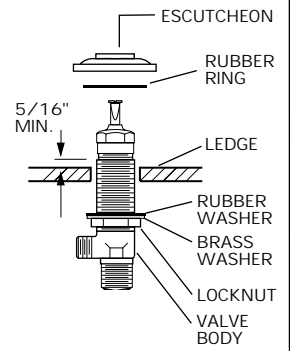
**VALVE INSTALLATION (continued)**

- Prepare TUBE and TEE ASSEMBLY to fit available VALVE location. If necessary, cut and/or bend TUBING carefully. Make sure tube bend is close to the TEE so that it will not effect the compression joint at the VALVE.
- Remove COUPLING NUT, FRICTION RING, and RUBBER FERRULE from each valve and slide onto tubing.
- Push TUBING ends into VALVE side outlets. Insert VALVES into mounting holes from underside of SINK.
- Press TEE onto SHANK of SPOUT making certain that the SHANK O-RING is properly seated on SHANK.

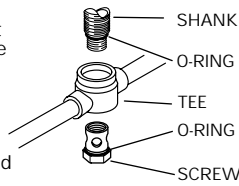
**3****DRAIN ASSEMBLY (Models 6502, 6902, 6532 and 6932)**

- Apply a bead of PUTTY around underside of DRAIN PLUG flange. Insert DRAIN PLUG into SINK drain hole.
- Hold DRAIN PLUG to prevent turning and assemble GASKET, WASHER, and LOCKNUT, from underneath sink.
- Insert threaded end of TAILPIECE into lower end of DRAIN PLUG. Connect other end to trap.

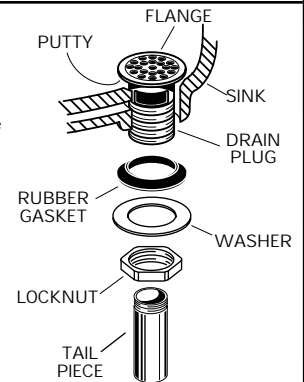
**4****DRAIN INSTALLATION (Models 6801 and 6831 only)**

- Push TAILPIECE down into TRAP (threaded end up).
- Thread LOCKNUT, WASHER and GASKET onto DRAIN BODY.
- Apply a bead of PUTTY to underside of FLANGE.
- Feed DRAIN BODY up through SINK and thread FLANGE fully onto BODY.
- Tighten LOCKNUT firmly, keeping the PIVOT ROD pointed towards the back of the SINK.
- Drop STOPPER into DRAIN BODY.
- Pull TAILPIECE up and thread tightly into DRAIN BODY.

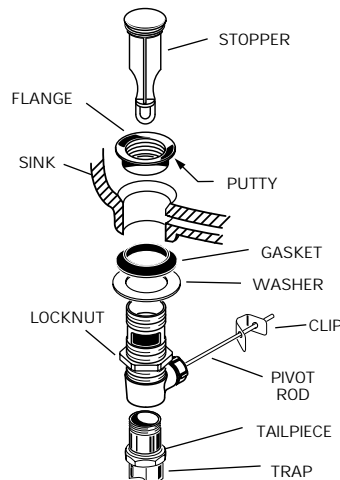

- Position EXTENSION ROD onto POP-UP ROD and tighten THUMBSCREW.
- Remove one end of CLIP from PIVOT ROD by squeezing ends together while sliding.
- Insert PIVOT ROD into second or third hole in EXTENSION and reassemble CLIP. (EXTENSION may need to be bent.)

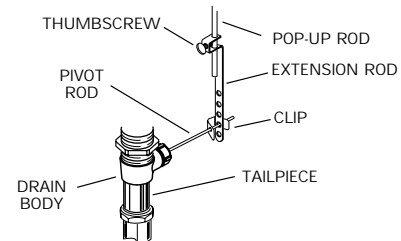

- Adjust STOPPER height by repositioning EXTENSION and tightening THUMBSCREW.

5**TEST INSTALLED FAUCET**

- Remove AERATOR.
- With handle in OFF position, turn on water supplies and check all connections for leaks.

- Operate both handles to flush water lines thoroughly. Check spout mounting and hose connections for leaks.
- Operate LIFT ROD and check DRAIN for leaks.
- Turn handles into OFF position and replace AERATOR.

6**SERVICE**

- To change direction of handle rotation, proceed as follows:
 - Turn valve to OFF position.
 - Remove HANDLE and BONNET NUT.
 - Remove SPRING CLIP.
 - Lift STOP WASHER, turn 90° and replace.
 - Replace SPRING CLIP.
 - Replace BONNET NUT, HANDLE, SCREW, and INDEX.
- AERATOR may accumulate dirt causing distorted and reduced water flow. Remove AERATOR and rinse clean.

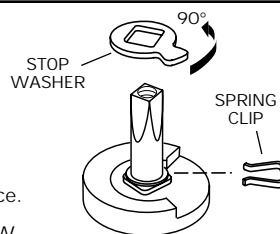

- If spout drips, operate handles several times from OFF to ON position. Do not force - handles turn only 90°.

- Plastic SCREEN in CARTRIDGE may accumulate dirt causing reduced water flow. To clean, first turn off hot and cold water supplies, then:
 - Remove HANDLE and BONNET NUT.
 - Remove CARTRIDGE by pulling up.
 - Thoroughly rinse plastic SCREEN at base of CARTRIDGE.

- Replace CARTRIDGE until flange is tight against valve body.
- Turn valves OFF.
- Replace BONNET NUT, HANDLE, SCREW and INDEX.

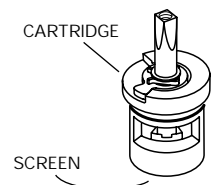
**HOTLINE FOR HELP**

For toll-free information and answers to your questions, call:

1 (800) 223-0068

Weekdays 8:00 a.m. to 4:00 p.m. Eastern Time

Product names listed herein are trademarks of American Standard Inc.
©American Standard Inc. 1997

60186B