

# Sunfire®

*Olé-2SF*  
*Film Interactive Touchpad*



*User's Manual*

# Important Safety Instructions

1. Read Instructions
2. Keep these Instructions
3. Heed all Warnings.
4. Follow all Instructions
5. Do not use this apparatus near water.
6. Clean only with dry cloth.
7. Do not install near any heat sources such as radiators, heat registers, stoves, or other apparatus (including amplifiers) that produce heat.
8. Refer all servicing to qualified service personnel. Servicing is required when the apparatus has been damaged in any way, such as a cord or plug is damaged, liquid has been spilled or objects have fallen into the apparatus, the apparatus has been exposed to rain or moisture, does not operate normally, or has been dropped.
9. The apparatus should only be connected to equipment of the type described in these operation instructions or as marked on the apparatus.
10. Object and Liquid Entry — Care should be taken so that objects do not fall into and liquids are not spilled into the inside of the apparatus.
11. Servicing — The user should not attempt to service the apparatus beyond those means described in this operating manual. All other servicing should be referred to qualified service personnel.

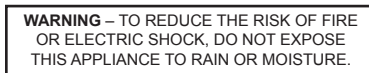
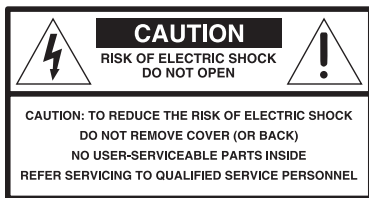

The lightning flash with arrowhead symbol within an equilateral triangle is intended to alert the user to the presence of uninsulated "dangerous voltage" within the product's enclosure, that may be of sufficient magnitude to constitute a risk of electric shock to persons.



The exclamation point within an equilateral triangle is intended to alert the user of the presence of important operating and maintenance (servicing) instructions in the literature accompanying the appliance.



# Contents

Important Safety Instructions .....	2
Introduction .....	4
Features.....	7
System Design, Installation and Connections.....	10
Connectors/Pinout .....	12
System Connections.....	16
Programming .....	18
Feature Enable/Disable .....	19
Specifications.....	20
Troubleshooting .....	21
Warranty .....	23
Service Assistance.....	23

For more information on this and other Sunfire products, please visit our website:

**[www.sunfire.com](http://www.sunfire.com)**

# Introduction

The Olé®-2SF Film Interactive Touchpad (FIT) is a revolutionary in-wall controller for your Sunfire receiver or processor. Using a photographic film overlay instead of hard buttons, it marries the beauty of a touchscreen with the simplicity of a keypad –seamlessly controlling all major functions of your home theater or secondary room.

The backlit film transparency provides system control icons and functions, while a 4-line 2" color OLED displays multiple pages of source control and feedback to the user. Multiple IR commands, or 'Sequences', can be issued from a single press of any button. Programming is accomplished with Sunfire's SunTools™ setup software, and is done through a direct link from a computer to the mini-USB download port on the front of the Olé-2SF.

Each button location (or "hot spot") is assigned a command that controls sources such as A/V equipment, HVAC systems, drapes, shades, lighting systems, or even fireplaces! Your Olé-2SF is configured out of the box to control your Olé-ready Sunfire receiver or processor's Zone 2 output. Custom-programming by your authorized Sunfire dealer will allow reconfiguring of the Olé-2SF to control the main theater system and a variety of functions required for your specific system.

## Unpacking

Your Olé-2SF touchpad should reach you in perfect condition. If you do notice any shipping damage, please contact Sunfire immediately.

Gently lift out the touchpad and all the packing material. It is important to save all the packing materials and the box in case your touchpad ever needs to be moved or shipped for repair.

Make sure that you keep your sales receipt. It is the only way to establish the duration of your Limited Warranty and it may come in useful for insurance purposes.

## Features

- Plug-and-play. Right out of the box, the Olé-2SF controls Zone 2 on Olé-ready Sunfire receivers and processors
- Simple SunTools™ PC programming for customization
- Sunfire Optimized™ graphics and programming
- Full touchpad design, with no hard buttons
- Two inch color OLED (Organic LED)
- Two-way feedback for artist/song data from SIRIUS satellite radio and VIA!migo™ iPod® cradle
- Automatic brightness-adjusting via light sensor
- Audible 'click' to indicate a button press (can be disabled in software)
- Built-in IR receiver for passing IR commands back to the main room
- Connectivity for Local IR Output and Remote IR Receiver
- Virtually unlimited IR command sequences issued from any button press
- System sense sequence capability
- Fits in a double-gang electrical box
- Stylish Euro wall plate in optional colors
- Patent pending design

## Care

If your Olé-2SF touchpad needs servicing, please read the Troubleshooting section on page 21. If a problem persists, please contact your nearest authorized Sunfire Dealer.

Please take a moment to fill out and mail the Sunfire Customer Response card. Also record the serial number and your details here:

Serial Number:	_____
Purchased from:	_____
	_____
	_____
Date:	_____

## Installation & Usage Tips

- When properly installed, nothing should be applying contact pressure to the touchpad except for the operator's finger. If something is touching the touchscreen window, a false signal can be generated causing the touchpad not to respond to a finger press (Sunfire does not recommend wrapping the removable frame with wallpaper as this can cause the aforementioned symptom). Too much force on the front of the touchpad, or concentrated pressure, can damage the polyester film or break the underlying glass plate.
- Avoid installation in direct sunlight or strong ultraviolet light (such as grow lamps, plant lights, or compact fluorescent lights). This can degrade and discolor the polyester film.
- Avoid installation over heat generating devices and/or in moist areas where condensation can form on the polyester film. Both heat and condensed moisture can affect touch screen performance.
- Avoid installation next to thermostats. The touch screen generates heat that can affect thermostat control and readings.
- Avoid applying any foreign objects, such as adhesive labels, on the touchscreens polyester film. This can release chemicals that can discolor the clear film.
- The touchpad should not be mounted near electronics that emit radio frequencies or electromagnetic interference (such as the deflection circuits of CRT monitors, light dimmers, and some power supplies)
- The edge of the touchpad has exposed sharp glass. Be careful when handling the assembly in order to avoid injury.

## Cleaning the touch screen

To clean the polyester film, first use a soft dry cloth to remove contamination. If dust or smudges are still present, disconnect the touchpad, and use a damp cloth that has been squeezed of excess water to remove the contaminant. If contaminants are still present, use a non-abrasive cleaner or detergent to clean the polyester film. Use of strong chemicals and/or some cleaning agents may discolor the polyester film. The following cleansers have been tested and approved for cleaning an Olé-2SF touchpad:

- Windex® Glass Cleaner
- Formula 409® Cleaner
- Mr. Clean®

# Features

## Top Panel

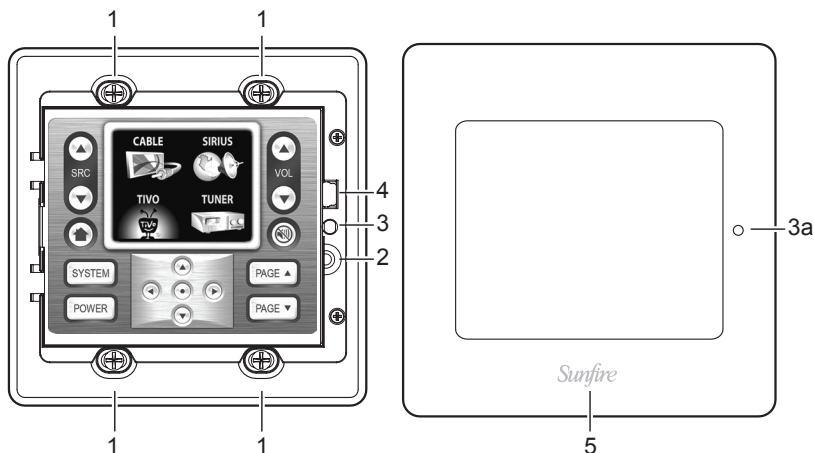

### 1. Mounting Screw (x 4)

Use these screws to mount the touchpad into a standard 32 cu in. double-gang electrical box.

### 2. Program Button

This button is for future use.

### 3. Light Sensor

When this sensor is enabled, the Olé-2SF backlight will brighten or dim depending on the room's ambient light conditions. Do not cover the small hole (3a) in the wall plate.

### 4. Download Port

This mini USB download port is used to program the touchpad, by connecting it to the USB port of a PC, using a standard USB-A to USB-mini-B cable.

### 5. Wall plate

This stylish wall plate clips over the top panel once the touchpad has been installed into a double-gang electrical box. It can be easily removed to access the download port.

## Touchpad display

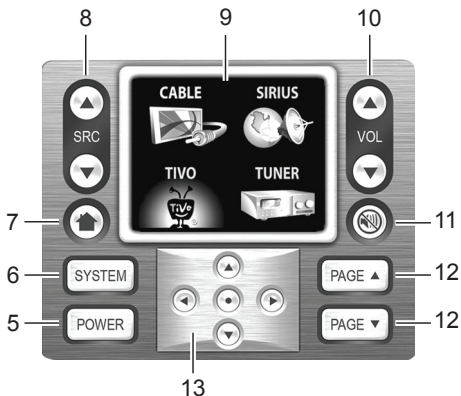

### 5. Power

Turns system audio on and off.

### 6. System

Bass/Treble control and other system options.

### 7. Home

This toggles between the main source selection screen and the current source control.

### 8. Source selection

View/change the source selection pages.

### 9. Display

This display is used for source selection and system information such as the artist/song data from SIRIUS satellite radio and the VIA!migo™ iPod® dock.

### 10. Volume up/down

Adjust the volume in your system.

### 11. Mute

Mute the sound in your system.

### 12. Page up/down

Page through different sources, or control pages within a source.

### 13. Navigation buttons

Controls various functions on source components depending on programming.



## Rear Panel

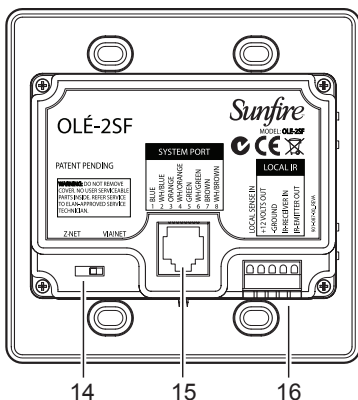

### 14. Z•NET/VIA!NET Switch

You must set this switch to VIA!NET for use with Sunfire receivers and processors.

### 15. System RJ-45 Jack

Connect this jack with Cat-5 cable to the TP1 or TP2 RJ-45 connectors on the rear panel of your Sunfire receiver or processor.

### 16. Local IR Port

This port allows the connection of local IR emitters and IR receivers, local contact switches etc. See pages 13–15 for connections.

# System Design, Installation and Connections

## Planning

Before installing the Olé-2SF, it is essential to have a detailed and accurate system design. An authorized Sunfire installer should be contracted for proper installation and programming of your touchpad. The first step to a good design is to map the system. It is advisable to mark up a copy of the house floor plan with speaker, keypad, touch panel, volume control, and equipment locations etc. Make sure that all locations are decided upon before pre-wiring commences, so that all necessary wiring and installation hardware is in place.

It is essential that ALL system components are accounted for prior to the pre-wire stage. After establishing design goals, make a detailed list of all components. Include source equipment, keypads, touch panels, volume controls, amplifiers, communications gear, etc. Gather up any IR remote controls that may be necessary for final programming, or ensure that the IR codes for all equipment to be installed are available in the SunTools IR Library.

## Installation

The Olé-2SF is designed to fit into a standard 32 cu. in. double-gang electrical box. Consult local building codes for specifics in your geographic area. Note that the Olé-2SF is not designed for outdoor use.

## Pre-Wire

The Olé-2SF requires power, control, and status to function correctly. Each touchpad has an RJ-45 jack on the back to allow for easy connection. Run Cat-5 wire from the receiver/processor location (head-end) to the location where each touchpad will be installed.

Note: Use of wire other than Cat-5 may produce undesired results (IR bandwidth may be narrowed or interference may occur).



**Warning:** Never connect the Olé-2SF Cat-5 cable to computer Ethernet or LAN systems, DSL routers etc. Make sure that Cat-5 cable used with the Olé-2SF is clearly marked to avoid any confusion.

Note: Maximum wire run is 500 feet.

## Rough-In

Roughing-in the Olé-2SF requires careful attention to the design plan made previously. Review the previous page and make a list of things to factor in to specific mounting locations, before deciding exactly where to place the unit. In order to avoid Electro-Magnetic Interference (EMI), do not mount touchpads close to light dimmers. Leave at least one stud-bay open between touchpads and dimmers (leave more space if multiple dimmers are present). Avoid installing Olé-2SF touchpads in areas that will receive direct sunlight. Sunlight can flood the IR receiver and make the system inoperative.

Do not mount touchpads outdoors! Corrosion will damage them. Sunfire does not warrant Olé touchpads for outdoor use.

## Mounting Height

The Olé-2SF has no viewing angle limitations, so mounting height should be determined by the average height of the user. Typical mounting height is 56-60 inches from the floor to the bottom of the frame. This will provide optimum viewing for the largest number of people.

## Connectors/Pinout

The Olé-2SF has a system RJ-45 connector and a five-pin Interface Port connector which each perform specific functions. All applications use the RJ-45 connector, while certain situations will require the use of the Local interface port.

## RJ-45 Connector

Use Cat-5 cable to connect the Olé-2SF to a Sunfire receiver or processor. The Sunfire standard pinout configuration is shown below.

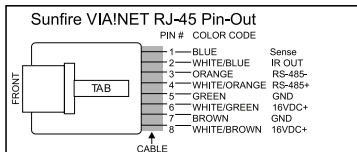
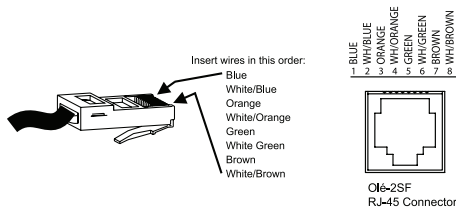

## Sunfire TGR-401 Theater Grand Receiver

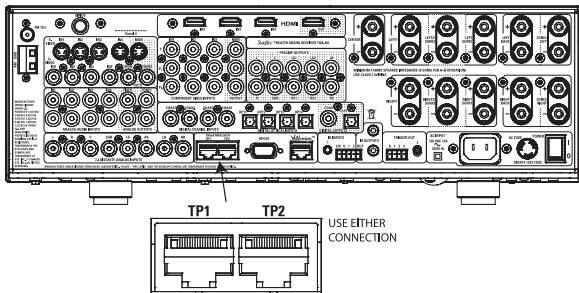

## Local IR Interface Port

Use this connector when utilizing the Olé-2SF's local control features, such as local source control, local IR sensors, or sense-enabled automated sequences.



**Warning:** The connection labeled "+12 Volts Out" is a voltage output. Do not connect a power supply to this connection!

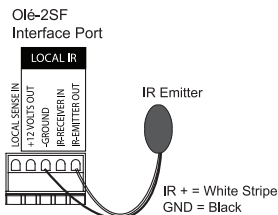

Controlling a single local device

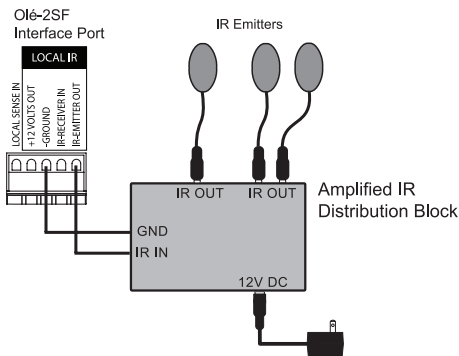

Controlling multiple local devices

## IR-Emitter Out

The Local IR-EMITTER OUT is typically used to control a device that is not part of the main IR system, such as a TV or DVD player located within the same room as the touchpad or electronic volume controls. IR is routed to an emitter or IR distribution block connected to the Local IR output in two ways:

1. Any IR signal that is received from the Local IR-RECEIVER IN is sent out both the Local IR-EMITTER OUT and the system IR output.
2. IR signals may be specified in programming as "Local" and be routed through the Local IR-EMITTER OUT.

Connect IR-EMITTER OUT and -GROUND as shown here.

## Local IR Input

The Local IR-RECEIVER IN is typically used to connect an external IR sensor to the touchpad. Typical applications include a plasma-friendly IR sensor placed near a TV, or an auxiliary IR sensor placed in an area more convenient than the location of the touchpad. IR signals that are received by the IR Input are sent out both the Local IR-EMITTER OUT and the System Port.

Connect IR-RECEIVER IN, -GROUND and +12VOLTS OUT (if required) as shown below. Consult the instruction manual that came with your external equipment before making connections.

Note: In certain cases, the built-in IR sensor on the Olé-2SF can be flooded with plasma TV interference or other ambient light interference. In this case, connect a plasma-friendly IR sensor to the Local IR Input and disable the built-in IR sensor in SunTools.

Olé-2SF Interface Port

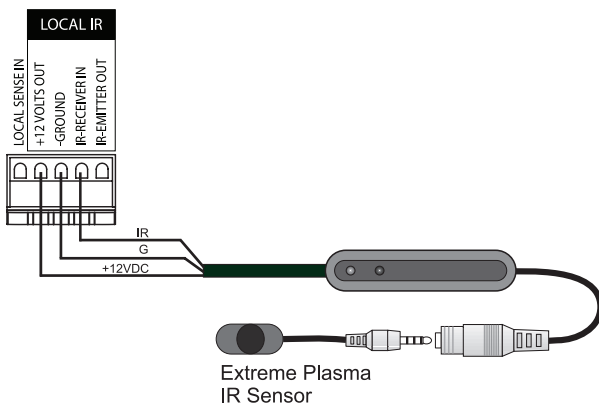

## Local Sense In

The LOCAL SENSE IN port allows a contact-closure to trigger IR sequences programmed into the Olé-2SF using SunTools. Use a motion sensor to activate a contact-closure and cause automated actions such as system power on, drapes closed, and lights dimmed, for example.

Connect LOCAL SENSE IN and -GROUND to a contact-closure device as shown below.

Olé-2SF Interface Port



# System Connections

## Zone 2 Control

The most common application (and default configuration out of the box) is to use your Olé-2SF as a Zone 2 controller. Without any programming you will be able to:

- Select Zone 2 sources
- Adjust Zone 2 volume (with feedback)
- Control the AM/FM/SIRIUS tuners (with RDS and metadata feedback)
- Basic control of VIA!migo iPod cradle (with metadata feedback)
- Adjust Zone 2 bass and treble

NOTE: The two TP (touchpad) ports on your Sunfire receiver or processor are identical.

All programming is stored in the Olé-2SF, so to reconfigure your Olé-2SF to control the main zone, or to add source IR control (play/stop/pause on a CD player, for example), you will need to connect the Olé-2SF to your PC for programming.

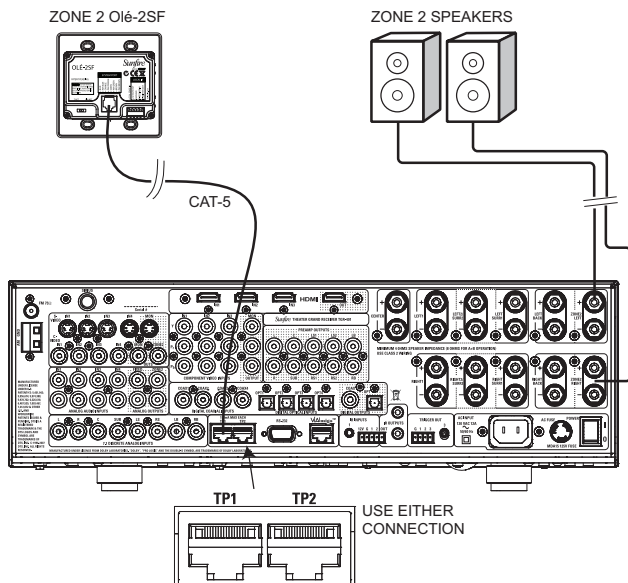



## Home Theater Control (PC required)

The Olé-2SF is perfectly suited as an in-wall Home Theater controller. You may want to include one by the entrance to startup or shutdown the system. In this case, you will need to connect your Olé-2SF to a PC running SunTools to reconfigure it to control the main zone. The main zone template allows you to control the following:

- Select Main Zone sources
- Adjust Main Zone volume (with feedback)
- Control the AM/FM/SIRIUS tuners (with RDS and metadata feedback)
- Basic control of VIA!migo iPod cradle (with metadata feedback)
- Adjust Main Zone bass and treble
- Select DSP modes
- Control OSD menu functions

NOTE: Of course you can go wild with custom programming - the above functions are simply included in the default template and represent the most commonly needed functions.

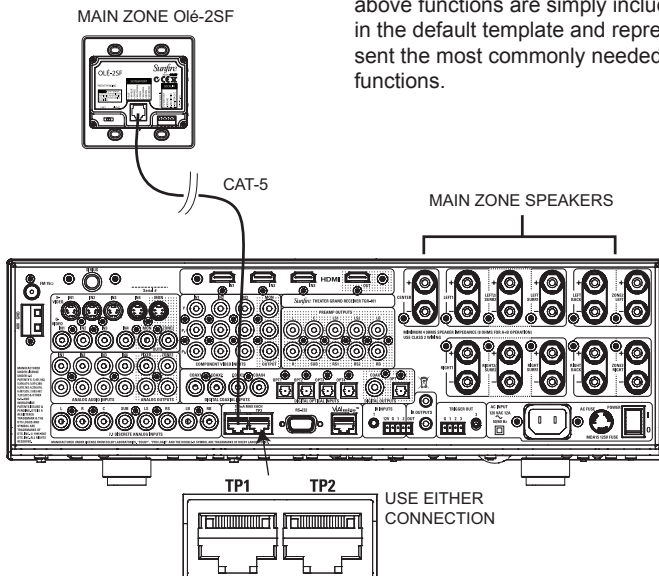

# Programming

The Olé-2SF must be programmed with Sunfire's SunTools setup software using a PC running Windows XP. Downloads are facilitated through the USB download port on the front of the unit.

Note: A standard USB-A to USB-mini-B cable must be utilized for programming and is not included with the Olé-2SF.

## To download a SunTools project:

- Ensure that your PC is running the latest version of SunTools software. Visit [sunfire.com](http://sunfire.com) for software downloads and updates.
- Remove the wall plate to access the USB download port.
- Connect a standard USB-A to USB-mini-B cable between a USB port on the PC and the USB download port on the front of the Olé-2SF touchpad.
- Navigate to the SunTools Olé transfer page to begin the transfer.
- Wait until "DONE OK" is displayed on the Olé-2SF's screen before disconnecting the USB cable from the USB Download Port.

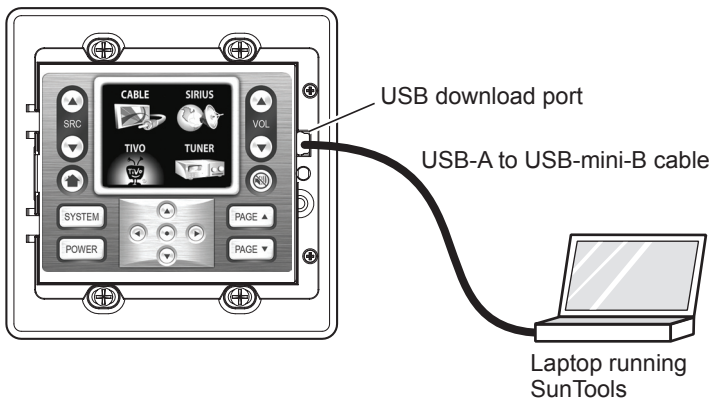

## Feature Enable/Disable:

### Speaker

The Olé-2SF contains a small speaker that allows audible feedback signals to be heard as a result of button pushes. This feature can be disabled in the SunTools setup software.

### IR Sensor

The Olé-2SF features a built-in IR Sensor. IR signals from a hand-held IR remote control pass through the IR sensor and travel to the head-end location where they control IR sources located there. These sources may be connected to a 3rd-party Multi-Zone Controller or an IR distribution network.

The IR Sensor can be disabled in SunTools setup software.

### Light Sensor Enable/Disable

The Olé-2SF touchpad has a light sensor feature.

1. Install the unit in the wall, using the wall plate that will be used in the final installation.
2. Adjust the room lighting to the brightest setting possible.
3. Select a source on the touchpad. The light sensor function only works when the unit displays the source icon screen.

4. Press and hold the "SELECT" button for five seconds. Depending on the correct state of the sensor, a message will be displayed:

"Release button to ENABLE sensor"

or

"Release button to DISABLE sensor"

Once the button is released, a confirmation message will be sent:

Either:

"LIGHT SENSOR ENABLED"

or

"LIGHT SENSOR DISABLED"

When the Light Sensor is enabled, the Olé-2SF touchpad's backlight will brighten or dim depending on the room's ambient light conditions. When the sensor is disabled, the Olé-2SF remains at full brightness no matter what the ambient light conditions are like.

# Specifications

## Viewing Angle

180° up/down, 180° left/right

## Operating Temp

32°F-104°F / 0°C-40°C

## OLED Display

Type: 2" Organic LED (OLED)

Colors: 252K

Resolution: 160 pixels (W) x 128 pixels (H)

## Connections

System Port: RJ-45

Interface Port: 5-position screw terminal

Download Port: Mini USB

## Wiring Requirements

Cat-5

## Power Requirements

12VDC/150mA or 16VDC/150mA

## Power Consumption

Each Olé-2SF touchpad draws 150mA in either 12V or 16V mode

## Dimensions

With Wall Plate

Height 4 5/8" (117 mm)

Width 4.5/8" (117 mm)

Depth 1 3/16" (30 mm)

Without Wall Plate

Height 4 7/16" (112 mm)

Width 4. 7/16" (112 mm)

Depth 1 1/8" (26 mm)

Fits into a 32 cu in. double-gang electrical box

## Weight

14 oz./0.4kg

## Shipping Weight

16 oz./0.45kg

© 2008 Sunfire, LLC.

All rights reserved. Sunfire, LLC reserves the right to improve its products at any time. Therefore, specifications are subject to change without notice.

Manual 913-144-00 Rev A

# Troubleshooting

## Power

Symptom	Cause	Solution
Olé-2SF does not power up.	1. RJ-45 plug crimped incorrectly; or wiring pinout of RJ-45 reversed.	Verify wiring pinout and RJ-45 crimp. Correct by re-crimping RJ-45 to Cat-5 cable.
	2. Break in Cat-5 between Zone and "Head-End".	Check RJ-45 to RJ-45 connections with cable tester.
	3. Receiver or processor power is disconnected.	Check AC outlet for power (reset breaker if tripped) making sure power cord is securely plugged in.

## IR

Symptom	Cause	Solution
No control of IR sources.	1. Programming: missing or incorrect IR commands.	Verify and correct programming. Test IR commands from SunTools.
	2. Wiring: Incorrect wiring between Zone and 'Head-End'.	Verify and correct wiring.
	3. Wiring: IR emitter connected to wrong source IR port of multi-room controller.	Verify port connection and correct.
	IR emitter defective.	Replace IR emitter.
Intermittent source control.	IR flooding.	Check to see if any ambient light is shining on built in IR receiver or in direct line with plasma TV noise. If the Olé-2SF cannot be relocated, disable the IR receiver in SunTools setup software and use a plasma friendly external receiver as shown on page 14 of this manual. If installed in conjunction with an 3rd-party multi-room controller, please refer to its own troubleshooting steps.

# Sunfire Warranty

Sunfire, LLC is proud of its products that have been built with care using advanced technology and premium component parts. Your unit has been crafted to perform properly for many years. Sunfire offers the following Warranty to you, the owner of a new Sunfire product:

The Sunfire Warranty for the Olé-2SF touchpad is in effect for one year from the date of original retail purchase. The Sunfire Warranty covers defects in materials and workmanship. The following, however, are excluded:

- a) Damage caused during shipment.
- b) Damage caused by accident, misuse, abuse of operation contrary to the instructions specified in the Sunfire user's manual
- c) Units where the serial number has been defaced, modified or removed,
- d) Damage resulting from modification or attempted repair by any person not authorized in writing by Sunfire, LLC.
- e) Units purchased from unauthorized dealers.

The Sunfire Warranty extends to the original owner during the one year warranty period so long as the original dated purchase receipt is presented whenever warranty service is required.

All implied warranties, including warranties of merchantability and fitness for particular purposes, are limited in duration to the one year length of this Warranty, unless otherwise provided by state law.

Sunfire's liability is limited to the repair or replacement, at our option, of any defective product and shall not in any event include property or any other incidental or consequential damages which may result from the failure of this product.

Some states do not allow limitations on how long an implied warranty lasts and/or do not allow the exclusion or limitation of incidental or consequential damages, so the above limitations or exclusions may not apply to you.

This Warranty gives you specific legal rights, and you may also have other rights which vary from state to state. We suggest that you attach your purchase receipt to this Warranty and keep these in a safe place. Thank you for your choice of a Sunfire product.

## Service Assistance

We suggest that you read the Limited Warranty completely to fully understand your Warranty/Service coverage.

If your Sunfire product ever requires service, write to us, or call:

Sunfire, LLC  
Technical Services Department  
P.O. Box 1589  
Snohomish, WA 98290  
support@sunfire.com  
Tel (425) 335-4748  
Fax (425) 335-4746

You will be directed to an authorized Sunfire Service Station or receive instructions to ship the unit to the factory. Please save the original shipping carton and packing materials in case shipping is required. Please do not ship Parcel Post.

**NOTE:** Before sending in your unit for repair, you must call Sunfire for return authorization (RA).

Include a complete description of the problem, indicating how you have it connected, the associated equipment in your system and a copy of your purchase receipt. Initial shipping costs are not paid by Sunfire; return ground shipping costs will be prepaid if repairs were covered by the scope of this Warranty.

# Sunfire®



## *Olé-2SF*

### *Film Interactive Touchpad*

---

*Sunfire, LLC*  
*P.O. Box 1589*  
*Snohomish*  
*WA 98291*

*Tel (425) 335-4748*  
*Fax (425) 335-4746*  
*[www.sunfire.com](http://www.sunfire.com)*