



USER'S MANUAL

Duct Type Series

Silhouette duct : AVMDH**

High static pressure duct : AVMHH**

ENGLISH

ESPAÑOL

FRANÇAIS

System Air Conditioner

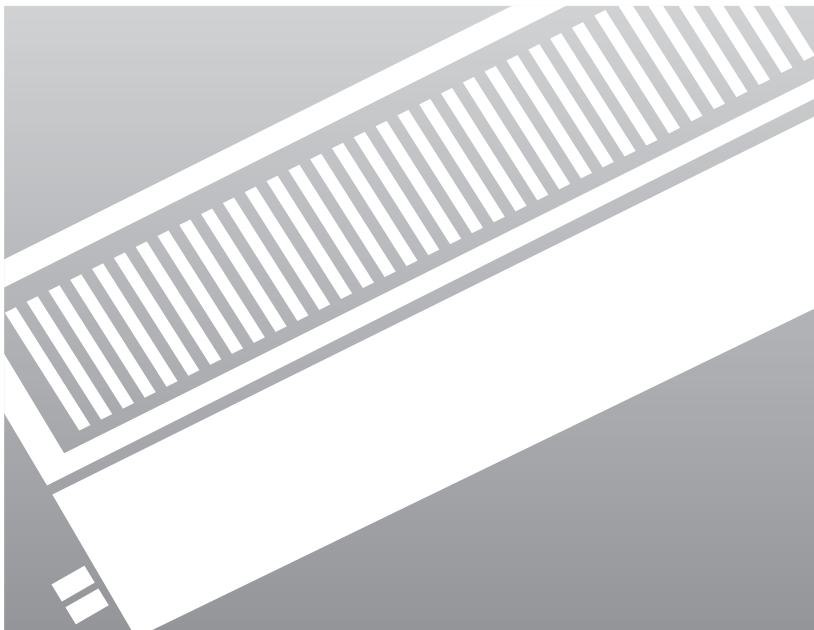

Contents

◆ PREPARING YOUR AIR CONDITIONER	
■ Safety Precautions	3
■ View of the Indoor Unit	8
◆ RECOMMENDATIONS FOR USE	
■ Operating Recommendations	10
■ Temperature and Humidity Ranges	11
■ Cleaning Your Air Conditioner	12
■ Solving Common Problems	14

Register your product at www.samsung.com/global/register

Safety Precautions

You should take the following safety precautions when using your air conditioner.



WARNING

- Risk of electric shock can cause injury or death.
- Disconnect all remote electric power supplies before servicing, installing or cleaning.
- Installation must be done by the manufacturer or service agent or a similar qualified person in order to avoid a hazard.

WHEN INSTALLING

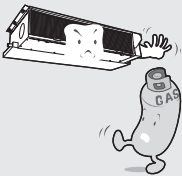

- ▶ Do not install the air conditioner where there is combustible gas.

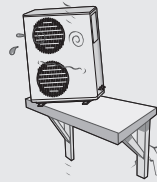

- ▶ Do not install the outdoor unit where there is the risk of dropping such as on high outer wall or outside of the terrace.

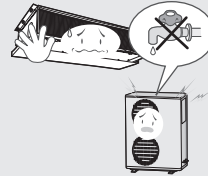

- ▶ Earth the ground conductor and do not connect it to the gas pipe, water pipe or telephone wire.

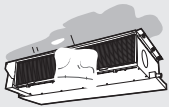

- ▶ Contact the service center if the air conditioner is under water.

REGARDING POWER SOURCE



- ▶ Do not pull the electric wire or touch the power plug with the wet hands.



- ▶ Do not bend the electric wire by force or weigh down the air conditioner not to be out of order.



- ▶ Install the switch and circuit breaker only for air conditioner.



- ▶ Use the power source with separate wiring only for air conditioner.

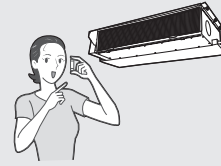

- ▶ Use the rated current fuse.



- ▶ If the power plug is damaged, replace it by the manufacturer or qualified personal to avoid the risk.



WARNING

DURING OPERATION



- ▶ Users of this product are cautioned not to attempt repair of this product at their own discretion. Instead, they are requested to directly contact a designated service center or the outlet at which the product was purchased.

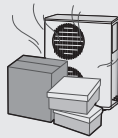

- ▶ Do not place any obstacles in front of the unit. Make sure that the unit is correctly ventilated at all times. Do not place clothing or other materials over it.



- ▶ Do not place any materials so that children cannot step on it.



- ▶ Never spill any kind of liquid into the unit. Should this happen, unplug or main switch off the unit and contact an authorized service center.

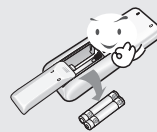

- ▶ If the wireless remote controller is not used for a long time, remove the batteries. (If applicable)

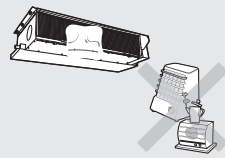

- ▶ Do not connect the electric heater to the air conditioner or repair it with your discretion.

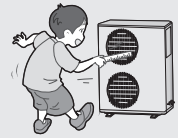

- ▶ Do not insert anything between the air outlet blades because the inner fan may be damaged and could cause injury. Keep children away from the unit.

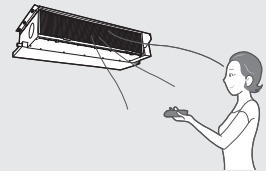

- ▶ When using a wireless remote controller, the distance should not be more than 7 meters from the air conditioner. (If applicable)



WARNING

DISPOSING THE UNIT

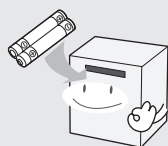

- ▶ Before throwing out the device, it is necessary to pull back the battery cells and get rid of them safely for recycling reasons.

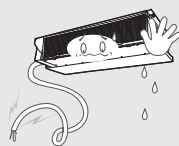

- ▶ When you need to dispose of the unit, consult your dealer. If pipes are removed incorrectly, refrigerant may blow out and come into contact with your skin, causing injury. Releasing refrigerant into the atmosphere also damages the environments.



- ▶ Please recycle or dispose of the packaging material for this product in an environmentally responsible manner.



CAUTION

WHEN INSTALLING

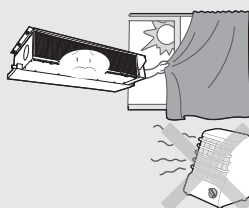

- ▶ Install the air conditioner avoiding direct sunlight or heater, especially water.



- ▶ Install the outdoor unit so as to let the discharged air out properly. Avoid a place that may disturb your neighbor by noise.

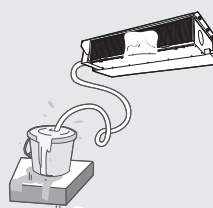

- ▶ Install the drain hose to let the water run safely and correctly.



CAUTION

REGARDING POWER SOURCE



- ▶ Disconnect the circuit breaker when you don't use the air conditioner for a long time to save energy.



- ▶ Contact the service center or manufacturer if you want to repair the air conditioner.



- ▶ Contact the service center after turning off the air conditioner if strange noise is heard, burning smell or smoke blow.

DURING OPERATION

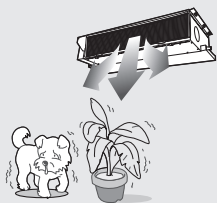

- ▶ Avoid cold and hot air reaching to person, pet or a plant directly for a long time.



- ▶ Avoid the water from getting into the air conditioner.



- ▶ Do not use the air conditioner for a long time in a closed room or in a place where there is a baby or an old person.



- ▶ Do not step on the air conditioner or put heavy objects on it.



- ▶ Do not drink the water from the air conditioner.



CAUTION

DURING OPERATION

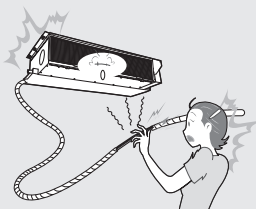

- ▶ Do not touch the pipes connected to the air conditioner.

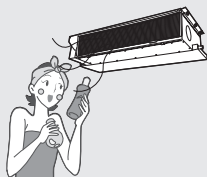

- ▶ Do not use the air conditioner to maintain the machine, food, pet, plant or cosmetics.



- ▶ Do not give excessive shock to the air conditioner.

OTHERS

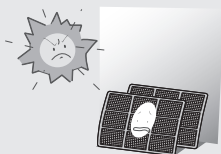

- ▶ Be sure that the air filter is not to be exposed to direct sunlight.



- ▶ The appliance is not intended for use by young children or infirm persons without supervision: Young children should be supervised to ensure that they do not play with the appliance.



- ▶ Max current is measured according to IEC standard for safety and current is measured according to ISO standard for energy efficiency.

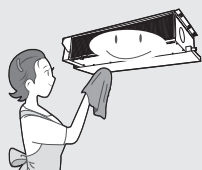

- ▶ Turn off the air conditioner and if the fan stops operating, clean the air conditioner.

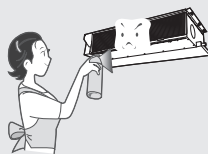

- ▶ Do not clean the air conditioner by spraying water directly or with benzene, thinner or alcohol.



- ▶ The surface of the heat exchanger is sharp, so be careful of it when cleaning.

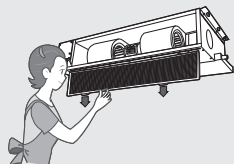

- ▶ Be sure to insert the air filter.

View of the Indoor Unit

The figures shown in this instruction may differ from yours depending on the model.

Indoor Unit AVMDH**

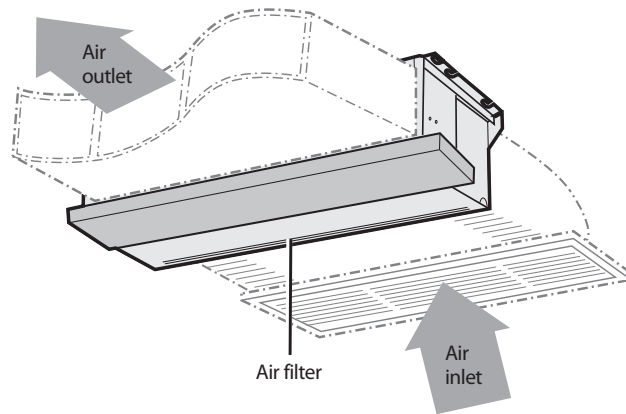

Indoor Unit

AVMHH**

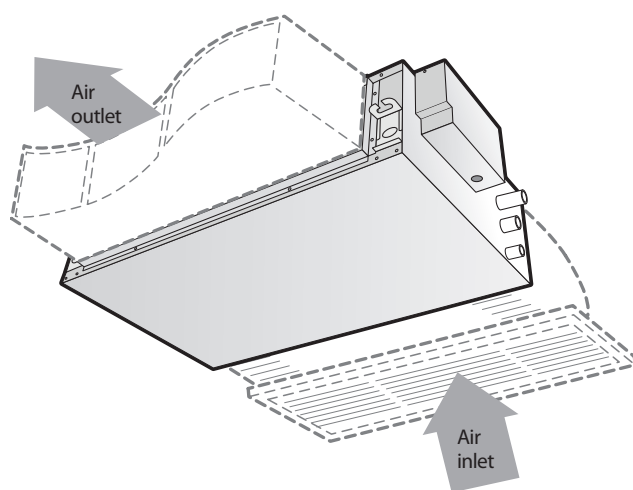

Operating Recommendations

Here are a few recommendations that you should follow when operating your air conditioner.

Topic	Recommendation
Heating performances	The heat pump function of the air conditioner absorbs heat from outside air and brings it indoors. As the temperature of the outside air drops, the heating performance of air conditioner will decrease. If you find that the room is not warm enough, using an additional heating appliance is recommended.
Frost & Defrost	When outside temperature is low but humidity is high, frost may form on the outdoor unit at HEAT mode. If this happens: <ul style="list-style-type: none">◆ The heating operation stops.◆ The defrost mode will be triggered automatically for about 10 minutes.◆ The steam produced on the outdoor unit in the defrost mode is safe. No intervention is required ; after about 10 minutes, the air conditioner operates again normally.
High indoor and outdoor temperatures	If both indoor and outdoor temperatures are high and the air conditioner is running at HEAT mode, the outdoor unit's fan and compressor may stop at times. This is normal ; simply wait until the air conditioner switches on again.
Power failure	If a power failure occurs while the air conditioner is operating, the unit will be switched off. When the power returns, the air conditioner starts up again automatically.

Temperature and Humidity Ranges

The following table indicates the temperature and humidity ranges, within which the air conditioner can be used.

If the air conditioner is used at...	Then...
High temperature	The automatic protection feature may be triggered and the air conditioner stopped.
Low temperature	Water leakage or some other malfunction may happen if the heat exchanger freezes.
High humidity levels	Water may condense on and drip from the surface of the indoor unit if it is used for a long period.

Mode	Outdoor Temperature	Indoor Temperature	Indoor Humidity
Heating	5°F to 75°F approx.	81°F or less	-
Cooling	23°F to 109°F approx.	64°F to 90°F approx.	80% or less
Drying	23°F to 109°F approx.	64°F to 90°F approx.	-

※ ***If the heating operation is used at below 32°F (outdoor temperature) then, it does not heat at its full capacity. If the cooling operation is used at over 91°F (indoor temperature) then, it does not cool at its full capacity.***

Cleaning Your Air Conditioner

To get the best possible use out of your air conditioner, you must clean it regularly to remove the dust that accumulates on the air filter.

CAUTION Before cleaning your air conditioner, ensure that you have switched off the electric circuit breaker used for the unit.

AVMDH**

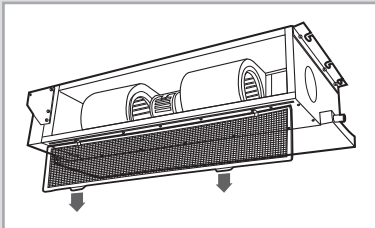
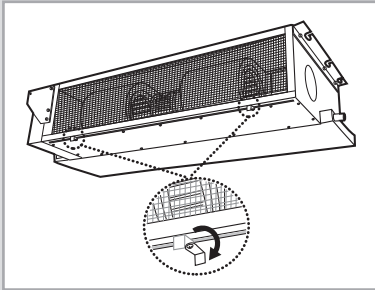

1 Turn the levers to the right or left not to prevent pulling out the air filter.

2 Pull out the air filter.

3 Remove all dust on air filter with a vacuum cleaner or a brush. In case of serious dust accumulation, put the air filter in warm detergent water and shake it vertically.

4 After washing, allow them to dry thoroughly in an area protected from sunlight.

5 When you have finished, insert the filter into the unit.

6 Return the levers.

Note

- ◆ After cleaning the air conditioner, press the Filter Reset button.
- ◆ To control indoor unit with wireless remote controller, you should install a receiver and display unit.

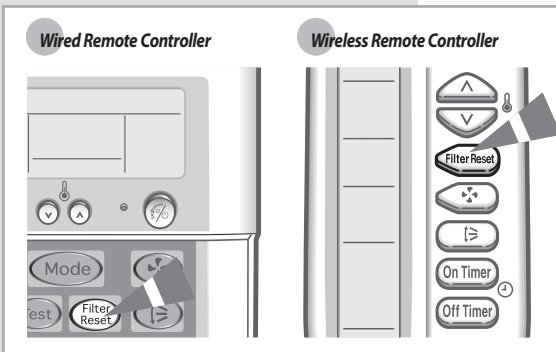

AVMHH**

- 1 Remove the fixing bracket on the base of air filter kit.
- 2 Pull out the air filter in the direction of the arrow.
- 3 Remove all dust on air filter with a vacuum cleaner or a brush. In case of serious dust accumulation, put the air filter in warm detergent water and shake it vertically.
- 4 After washing, allow them to dry thoroughly in an area protected from sunlight.
- 5 When you have finished, insert the filter into the unit.
- 6 Reinstall the fixing bracket.

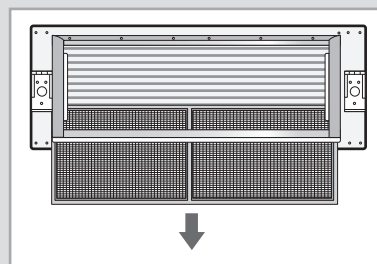
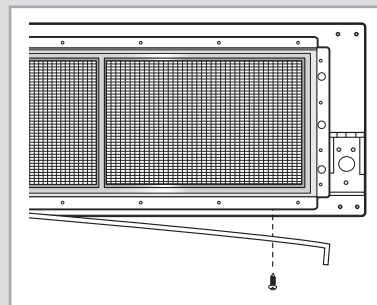



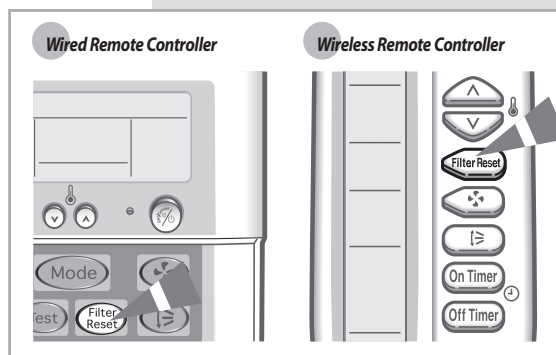

- Note**
- ◆ After cleaning the air conditioner, press the **Filter Reset** button.
 - ◆ To control indoor unit with wireless remote controller, you should install a receiver and display unit.



Solving Common Problems

Before contacting the after-sales service, perform the following simple checks. They may save you the time and expense of an unnecessary call.

Problem	Explanation/Solution
The air conditioner does not operate at all.	<ul style="list-style-type: none"> ◆ Check if power is on and operate the air conditioner again. ◆ Check if the circuit breaker is switched off. ◆ Check if Off Timer is set.
The temperature is not adjusted.	<ul style="list-style-type: none"> ◆ Check if you selected the FAN mode.
The cool(warm) air does not come out from the air conditioner.	<ul style="list-style-type: none"> ◆ Check if set temperature higher(lower) than current temperature. ◆ Check if you selected the Fan mode. Select the COOL, HEAT, AUTO or DRY mode. ◆ Check if the air filter is blocked by dirt. Clean the air filter regularly. ◆ Check if there is cover on the outdoor unit or any obstacle. Remove the cover or obstacle. ◆ Check if you installed the air conditioner under direct sunlight. ◆ The window or door may be opened. ◆ Check if you turn on the air conditioner just now. It takes about 3 minutes to cool or heat the room. ◆ Check if the refrigerant pipe is too long.
The fan speed is not adjusted.	<ul style="list-style-type: none"> ◆ In AUTO or DRY mode, the fan speed is selected automatically.
The remote controller does not operate.	<ul style="list-style-type: none"> ◆ Check if the battery is discharged. Replace the battery. ◆ Check if the remote controller sensor is blocked. ◆ Check if the air conditioner is placed near strong light.
The wired remote controller does not operate.	<ul style="list-style-type: none"> ◆ Check if  is displayed on the wired remote controller. Turn off the air conditioner and switch off the circuit breaker. Contact the service center.
The Timer is not set.	<ul style="list-style-type: none"> ◆ Check if you pressed the  button after selecting time.
The air conditioner does not turn on or off with the wired remote controller.	<ul style="list-style-type: none"> ◆ Check if you set the wired remote controller for group control.
Odor is permeated in the room during operation.	<ul style="list-style-type: none"> ◆ Check if you use the air conditioner in smoky area or there is a smell. Ventilate the room or select the FAN mode for 1~2 hours.
The indoor unit indicator flashes.	<ul style="list-style-type: none"> ◆ Press the  button to turn on the air conditioner again. Switch the circuit breaker off and switch on it again.
Strange sound is heard from the air conditioner.	<ul style="list-style-type: none"> ◆ The sound is heard when the refrigerant gas flow is changed depending on the use of the air conditioner. ◆ When you press the  button, noise may be heard from the drain pump inside of the air conditioner. ◆ When you press the  button, noise may be heard that the air conditioner sense the airflow blade.
Water drops from the outdoor unit connection part.	<ul style="list-style-type: none"> ◆ Water may form due to the difference of the temperature.



Contact SAMSUNG WORLD WIDE

If you have any comments or questions regarding a Samsung products, contact the SAMSUNG customer care center.

Country	Customer Care Center 	Web Site
CANADA	1-800-SAMSUNG (7267864)	www.samsung.com/ca
MEXICO	01-800-SAMSUNG (7267864)	www.samsung.com/mx
U.S.A	1-800-SAMSUNG (7267864)	www.samsung.com
ARGENTINE	0800-333-3733	www.samsung.com/ar
BRAZIL	0800-124-421/4004-0000	www.samsung.com/br
CHILE	800-726-7864 (SAMSUNG)	www.samsung.com/cl
COSTA RICA	0-800-507-7267	www.samsung.com/latin
ECUADOR	1-800-10-7267	www.samsung.com/latin
EL SALVADOR	800-6225	www.samsung.com/latin
GUATEMALA	1-800-299-0013	www.samsung.com/latin
JAMAICA	1-800-234-7267	www.samsung.com/latin
PANAMA	800-7267	www.samsung.com/latin
PUERTO RICO	1-800-682-3180	www.samsung.com/latin
REP. DOMINICA	1-800-751-2676	www.samsung.com/latin
TRINIDAD & TOBAGO	1-800-7267-864	www.samsung.com/latin
VENEZUELA	1-800-100-5303	www.samsung.com/latin
COLOMBIA	01-8000112112	www.samsung.com.co